

Proximity switch for T-slot



Festo Core Range
Solves the majority of your automation tasks

With the Festo Core Range, we have selected the most important products and functions from our broad product catalogue, and added the quickest delivery.

Worldwide: Quickest delivery – wherever, whenever
Simply good: Expected high Festo quality
Fast: Easy and fast to select

The Core Range offers you the best value for your automation tasks.

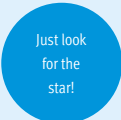

Product range overview

Design	Type of mounting	Measuring principle	Type	Operating voltage range	Switching output	Switching element function	→ Page
For T-slot	Standard						
	Screw-clamped, insertable in the slot from above	Magnetic Hall	SDBT-MSX	10 ... 30 V DC	PNP/NPN, switchable	N/O / N/C contact, switchable	–
	Insertable in the slot from above, flush with the cylinder profile	Magneto-resistive	SMT-8M-A	5 ... 30 V DC	PNP	N/O contact	7
					NPN	N/C contact	
					Non-contacting, 2-wire	N/O contact	
	Insertable in the slot from above, flush with the cylinder profile	Magnetic reed	SME-8M	5 ... 30 V AC/DC	Contacting, bipolar	N/O contact	–
						N/C contact	
	Insertable in the slot lengthwise, flush with the cylinder profile	Magnetic reed	SME-8	12 ... 30 V AC/DC	Contacting, bipolar	N/O contact	–
				3 ... 230 V AC/DC		N/C contact	
	Insertable in the slot lengthwise	Magneto-resistive	SMT-8G	10 ... 30 V DC	PNP, NPN	N/O contact	–
		Magneto-resistive	SMT-8-SL	10 ... 30 V DC	PNP	N/O contact	–
		Magnetic reed	SME-8-SL	10 ... 30 V AC/DC	Contacting, bipolar	N/O contact	–
	Insertable in the slot from above	Magnetic reed	SME-8-FM	10 ... 30 V AC/DC	Contacting, bipolar	N/O contact	–
	With accessories	Magneto-resistive	SMT-8E	10 ... 30 V DC	PNP	N/O contact	–
					NPN		
		Magnetic reed	SME-8E	12 ... 30 V DC	Contacting, bipolar	N/O contact	–
				3 ... 250 V DC			
	3 ... 230 V AC						
	Corrosion-resistant						
	Insertable in the slot from above, flush with the cylinder profile	Magneto-resistive	CRSMT-8M	5 ... 30 V DC	PNP	N/O contact	–
	Welding-field-resistant						
	Insertable in the slot from above, screw-clamped	Magneto-resistive	SDBT-BSW	10 ... 30 V DC	PNP	N/O contact	–
					NPN		
					Non-contacting, 2-wire		
	With accessories	Magneto-inductive	SMT-8E	10 ... 30 V DC	PNP	N/O contact	–
					NPN		
	Heat-resistant up to 120°C						
Insertable in the slot lengthwise, flush with the cylinder profile	Magnetic reed	SME-8-...S6	0 ... 30 V AC/DC	Contacting, bipolar	N/O contact	–	
With accessories	Magnetic reed	SME-8E-...S6	0 ... 30 V DC	Contacting	N/O contact	–	
			0 ... 30 V AC				
To EU Explosion Protection Directive (ATEX)							
Insertable in the slot from above, screw-clamped	Magneto-resistive	SDBT-MS-...EX6	8.2 V DC	NAMUR	NAMUR	–	

Product range overview

Design	Type of mounting	Measuring principle	Type	Operating voltage range	Switching output	Switching element function	→ Page
For C-slot	Standard						
	Insertable in the slot from above, flush with the cylinder profile	Magneto-resistive	SMT-10M	10 ... 30 V DC	PNP	N/O contact	C-slot
					NPN		
					Non-contacting, 2-wire		
	Insertable in the slot lengthwise	Magnetic reed	SME-10M	5 ... 30 V AC/DC	Contacting, bipolar	N/O contact	
Magneto-resistive		SMT-10G	10 ... 30 V DC	PNP	N/O contact		
	Magnetic reed	SME-10	12 ... 27 V AC/DC	Contacting	N/O contact		

T-slot switches can be used for drives with T-slot

Exceptions

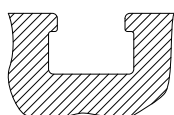

- DFM-B: SMT0-8E, SMTSO-8E, SME0-8E and SMP0-8E cannot be used
- DHDS: SME-8M can only be used on diameter \varnothing 50
- DHPS: SME-8M can only be used on \varnothing 20 ... 35
- HGDD-63-A: SMT-8M-A cannot be used
- HGPT-B: only SMT-8G can be used from size 40 and upwards
- SDBT-BSW- ... -PU/NU can only be used on a limited number of drive series. Page → 53

C-slot switches can be used for drives with C-slot

Exceptions

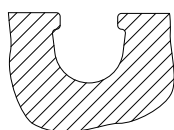

- ADVC \varnothing 100: SMT-10M and SME-10M cannot be used (ADVC has a T-slot and C-slot)
- DSM/DSM-B-6/8/10: SME-10M cannot be used
- DSM/DSM-B-10/16: SMT-10M cannot be used
- HGPT-B: only SMT-10G can be used for sizes up to and including size 35

For drives with sensor rail: these are available with 2 cylinder barrel contours

Only T-slot switches CRSMT-8M, SMT-8M-A and SDBT-MS- ... -EX6 can be used, and only with the identified profile.

CRSMT-8M and SMT-8M-A can be used for all diameters; SDBT-MS- ... -EX6 cannot be used for diameters 40 and 50.

Example: DSBF

Example: CDC

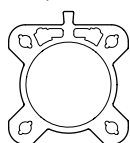

Suitable

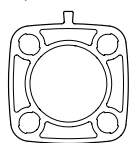

Not suitable

Peripherals overview

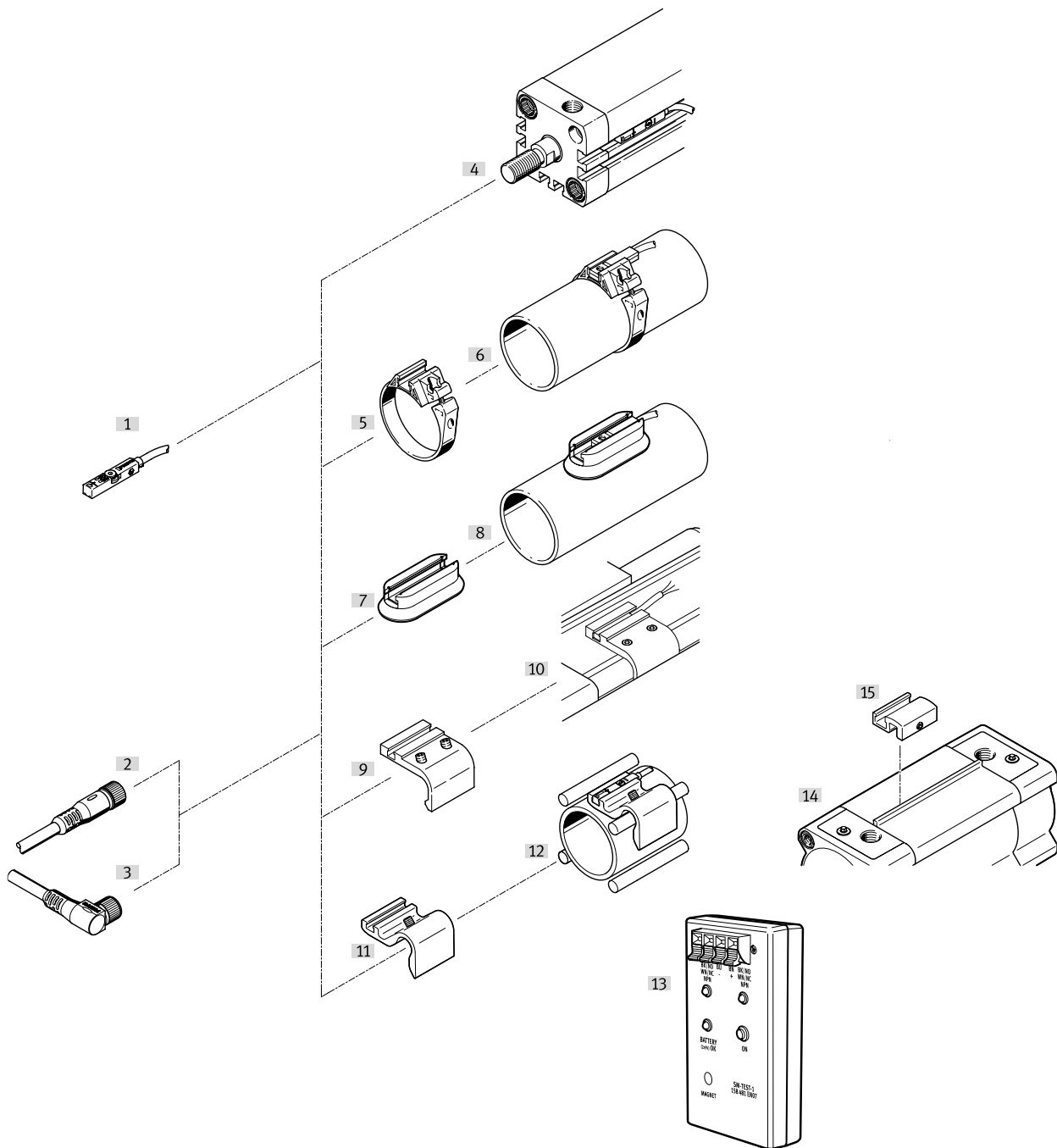

Peripherals overview

Mounting components and accessories		→ Page	Mounting components and accessories		→ Page
Proximity switches			Mounting kits and accessories		
[1]	SMT-8M-A-..., with cable	7	[5]	Mounting kit SMBR	14
			[7]	Mounting kit CRSMB, corrosion-resistant	14
			[9]	Mounting kit SMB-8-FENG	15
			[11]	Sensor bracket DASP-M4-...	15
			[15]	Mounting kit SMB-8-C	16
			[13]	Sensor tester SM-TEST-1	17
Connecting cables			Drives		
[2]	NEBU-M...G...	17	[4]	Drives with T-slot	-
[3]	NEBU-M...W...	17	[6], [8]	Round cylinders	-
			[10]	Standards-based cylinders DSBC	-
			[12]	Drives with tie or mounting rod	-
			[14]	Standards-based cylinders DSBF	-

Type codes

001	Series	
SMT	Proximity sensor	

002	Design type	
8	For T-slot	

003	Sensor version	
M	Inserted in the slot from above	

004	Design	
A	Short	

005	Switching output	
NO	3-wire N/C contact NPN	
NS	3-wire NPN N/O contact	
PNS	PNP/NPN, switchable	
PO	3-wire PNP N/C contact	
PS	3-wire PNP N/O contact	
PSO	PNP N/C or N/O contact, switchable	
ZS	2-wire PNP N/O contact	

006	Rated operating voltage	
24V	24 V	

007	Cable characteristic	
E	Suitable for energy chains/robot applications	

008	Cable length [m]	
	0.1 ... 30 m	
0,3	0.3 m	
2,5	2.5 m	
5,0	5 m	
7,5	7.5 m	

009	Cable identification	
	With label holder	
N	Without label holder	

010	Connection technology	
OE	Open end	
M8	M8, snap-on flange	
M8D	M8, rotatable thread	
M12	M12, rotatable thread	

Data sheet – Magneto-resistive

Function

PNP, N/O contact, with cable

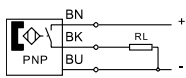

NPN, N/O contact, with cable

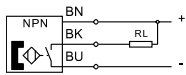

- Magneto-resistive measuring principle
- Insertable in the slot from above, does not protrude over the cylinder profile



General technical data			
Electrical connection	M8, M8D, M12	OE	NO- ... -OE
Design	For T-slot		
Mounting position	Any		
Based on standard	EN 60947-5-2		
Certification	c UL us - Listed (OL)		-
	RCM		
KC mark	KC EMC		
CE marking	To EU EMC Directive		
(see declaration of conformity)	To EU RoHS Directive		
UKCA marking	To UK EMC regulations		
(see declaration of conformity) ¹⁾	To UK RoHS regulations		
Application information	Support / Actuator-sensor overview "The right sensor for the actuator"		
Note on materials	Halogen-free		
	RoHS-compliant		
PWIS conformity	VDMA24364-B2-L		
Certificate-issuing authority	UL E232949		
Special characteristics	Oil-resistant		
Suitable for the production of lithium-ion batteries	-	Metals with more than 1% by mass of copper, zinc or nickel are excluded from use. Exceptions are nickel in steel, chemically nickel-plated surfaces, printed circuit boards, cables, electrical plug connectors and coils	-
Cleanroom class	-	Class 4 to ISO 14644-1	-

1) For information about the area of use, see the EC declaration of conformity at: www.festo.com/catalogue/... → Support/Downloads.

If the devices are subject to usage restrictions in residential, commercial or light-industrial environments, further measures for the reduction of the emitted interference may be necessary.

Input signal/measuring element	
Measured variable	Position
Measuring principle	Magneto-resistive
Ambient temperature	[°C] -40 ... +85

Data sheet – Magneto-resistive

Switching output							
Type	PS	NS	PO	NO	ZS	PNS	PSO
Switching output	PNP	NPN	PNP	NPN	Non-contacting, 2-wire	PNP, NPN, switchable	PNP
Switching element function	N/O contact	N/O contact	N/C contact	N/C contact	N/O contact	N/O contact	N/C contact, N/O contact, switchable
Repetition accuracy [mm]	0.2						
Switch-on time [ms]	≤ 1.3				≤ 1.0		
Switch-off time [ms]	≤ 1.4				≤ 1.0		
Max. output current [mA]	100	100	100	100	80	100	100
Max. output current in mounting kits [mA]	100				80	100	
Max. switching capacity DC [W]	2.8	2.8	2.8	2.8	1.9	2.7	2.7
Max. switching capacity DC in mounting kits [W]	2.8	2.8	2.8	2.8	1.5	2.7	2.7
Max. switching frequency [Hz]	180						
Voltage drop [V]	< 1.5				< 6	< 2.5	

Output, additional data	
Short circuit protection	Yes
Overload protection	Present

Electronics		
Type	PS, NS, PO, NO, ZS	PNS, PSO, ZS
Operating voltage range [V DC]	5 ... 30	
Rated operating voltage [V DC]	24	
Reverse polarity protection	For all electrical connections	

Electromechanics					
Electrical connection	M8	M8D	M12	OE	ZS-...-OE
Connection type	Cable with plug			Cable	
Connection technology	Open end	M8x1, A-coded to EN 61076-2-104	M12x1, A-coded to EN 61076-2-101	Open end	
Number of pins/wires	3			3	2
Type of mounting	-		Screw-type lock	-	
Outlet direction of connection	In-line				
Cable test conditions	Cable chain: 5 million cycles, bending radius 28 mm				
	Torsional resistance: > 300,000 cycles, ±270°/0.1 m				
	Resistance to bending: to Festo standard; test conditions on request				
Cable characteristic	Cable chain + robot				
Information on materials: cable sheath	TPE-U(PUR)				
Cable sheath colour	Grey				

Data sheet – Magneto-resistive

Mechanics		
Electrical connection	M8, M8D, M12	OE
Type of mounting	Screw-clamped, insertable in the slot from above	
Max. tightening torque [Nm]	0.6	
Housing	black	
	PA-reinforced	
	High-alloy stainless steel	
	Nickel-plated brass	-

Display/operation			
	PS, NS, PO, NO, ZS	PNS	PSO
Switching status indication	Yellow LED	Yellow LED (for PNP) / white LED (for NPN)	Yellow LED (for N/O contact) / white LED (for N/C contact)
Function reserve indication	Orange LED	-	

Immission/emission	
Ambient temperature with flexible cable installation [°C]	-20 ... +85
Degree of protection	IP65, IP68, IP69K

Pin allocation to EN 60947-5-2

M8x1, 2-pin N/O contact			
	Pin	Wire colour	Allocation
	1	Brown	+
	4	Black	-

M12x1, 2-pin N/O contact			
	Pin	Wire colour	Allocation
	1	Brown	+
	4	Black	-

Pin allocation to EN 60947-5-2

M8x1, 3-pin N/O contact / N/C contact			
	Pin	Wire colour	Allocation
	1	Brown	+
	3	Blue	-
	4	Black	Output

M12x1, 3-pin N/O contact			
	Pin	Wire colour	Allocation
	1	Brown	+
	3	Blue	-
	4	Black	Output

Pin allocation to EN 60947-5-2

M12x1, 3-pin N/C contact			
	Pin	Wire colour	Allocation
	1	Brown	+
	3	Blue	-
	2	White	Output

Data sheet – Magneto-resistive

Dimensions

Download CAD data → www.festo.com

SMT8-M-A-24V-E-... (PS, NS, PO, NO, ZS)

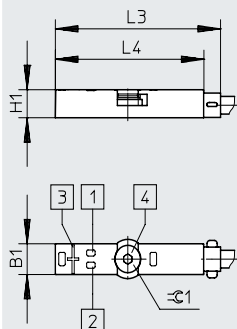

- [1] Yellow light emitting diode
- [2] Orange light emitting diode
- [3] Position of sensor element centre
- [4] Clamping element, tightening torque 0.6 Nm

Yellow light emitting diode for safe switching status.

Yellow and orange light emitting diode for unsafe switching status.



SMT8-M-A-24V-E-... (PNS, PSO)

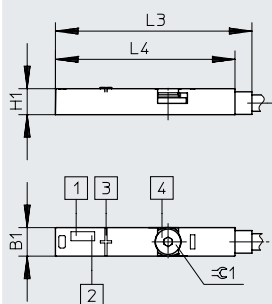

- [1] Yellow light emitting diode
- [2] White light emitting diode
- [3] Position of sensor element centre
- [4] For Allen key

Switching status indication for PNS:

Yellow light emitting diode for PS switching output.

White light emitting diode for NS switching output.

Switching status indication for PSO:

Yellow light emitting diode for PS switching output.

White light emitting diode for PO switching output.



Type	B1	H1	L3	L4	≈ 1
SMT-8M-A-...-24V-E- (PS, NS, PO, NO, ZS)	5	4.6	29.3	26.3	1.5
SMT-8M-A-...-24V-E- (PNS, PSO)			34.8	31.8	

Data sheet – Magneto-resistive

Dimensions

Download CAD data → www.festo.com

SMT-8M-A...-OE – Cable

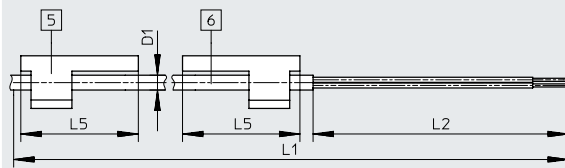

- [5] Inscription label holder drawn turned by 90°
- [6] Connecting cable

L1 Cable length

SMT-8M-A...-M8D – Cable with plug M8x1, rotatable thread

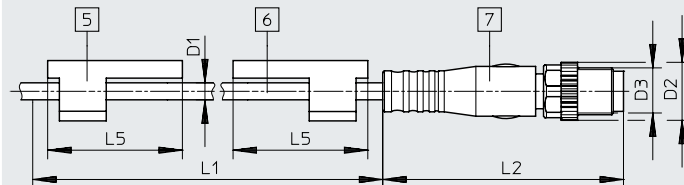

- [5] Inscription label holder drawn turned by 90°
- [6] Connecting cable
- [7] Plug suitable for connecting cable NEBU-M8

L1 Cable length

SMT-8M-A...-M8 – Cable with plug M8x1, snap-on flange

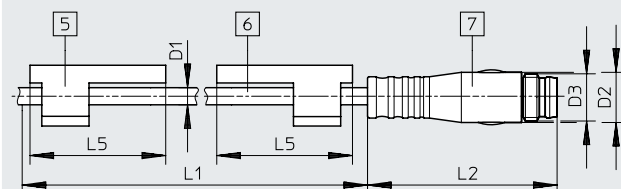

- [5] Inscription label holder drawn turned by 90°
- [6] Connecting cable
- [7] Plug suitable for connecting cable NEBU-M8

L1 Cable length

SMT-8M-A...-M12 – Cable with plug M12x1, rotatable thread

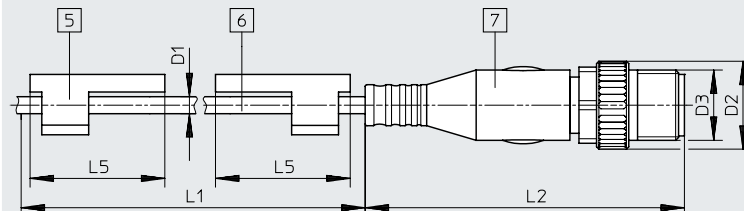

- [5] Inscription label holder drawn turned by 90°
- [6] Connecting cable
- [7] Plug suitable for connecting cable NEBU-M12

L1 Cable length

Type	D1	D2 ∅	D3	L1	L2	L5	±0.1
SMT-8M-A...-OE	2.9	-	-	2500, 7500	50	23	1.5
SMT-8M-A...-M8D		10	M8x1	300	41.1		
SMT-8M-A...-M8		8.5	M8x1	-	32.7		
SMT-8M-A...-M12		15	M12x1	-	54.5		

Data sheet – Magneto-resistive

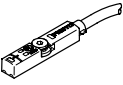
Ordering data								
	Switching output	Electrical connection Cable	Cable with plug, rotatable thread		Cable length [m]	Weight [g]	Part no.	Type
			M8x1	M12x1				
	N/O contact							
	PNP	–	3-pin	–	0.3	8.9	★ 574334	SMT-8M-A-PS-24V-E-0.3-M8D
	PNP	3-wire	–	–	2.5	29.1	★ 574335	SMT-8M-A-PS-24V-E-2.5-OE
	PNP	3-wire	–	–	5	57.1	★ 574336	SMT-8M-A-PS-24V-E-5.0-OE
	PNP	–	–	3-pin	0.3	15.9	★ 574337	SMT-8M-A-PS-24V-E-0.3-M12
	NPN	3-wire	–	–	2.5	29.1	★ 574338	SMT-8M-A-NS-24V-E-2.5-OE
		–	–	3-pin	–	0.3	8.9	★ 574339
	Non-contacting	2-wire, open end	–	–	5	57.1	8165237	SMT-8M-A-ZS-24V-E-5-OE
N/C contact								
PNP	3-wire	–	–	7.5	85.1	★ 574340	SMT-8M-A-PO-24V-E-7.5-OE	

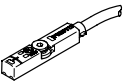
Ordering data								
	Switching output	Electrical connection Cable	Cable with plug, rotatable thread		Cable length [m]	Weight [g]	Part no.	Type
			M8x1	M12x1				
	N/C contact							
	NPN/NO	3-wire, open end	–	–	2.5	29.1	8138000	SMT-8M-A-NO-24V-E-2,5-OE
	NPN/NO	3-wire, open end	–	–	7.5	85.1	8138001	SMT-8M-A-NO-24V-E-7,5-OE
	Switchable							
	PNP/NPN	–	3-pin	–	0.3	9	574343	SMT-8M-A-PNS-24V-E-0.3-M8D
PNP PS/PO	–	3-pin	–	0.3	9	574344	SMT-8M-A-PSO-24V-E-0.3-M8D	

Ordering data – Modular product system

Ordering table		Conditions	Code	Enter code
Size	8			
Module no.	574333			
Function	Proximity switch for T-slot, electronic		SMT-8M	SMT-8M
			–	–
Series	Short design		A	A
			–	–
Switching output	3-wire PNP N/O contact		PS	
	3-wire NPN N/O contact		NS	
	3-wire PNP N/C contact		PO	
	2-wire PNP N/O contact		ZS	
	PNP / NPN, switchable		PNS	
	PNP N/C contact / N/O contact, switchable		PSO	
	3-wire NPN N/C contact		NO	
			–	–
Rated operating voltage [V DC]	24		24V	24V
			–	–
Cable characteristic	Cable chain + robot		E	E
			–	–
Cable length [m]	0.1 ... 30		...	
	(0.1 ... 5.0 in increments of 0.1, 5.0 ... 30 in increments of 0.5)			
			–	–
Cable designation	With inscription label holder			
	Without inscription label holder		N	
			–	–
Connection technology	Open end		OE	
	M8, rotatable thread		M8D	
	M8, snap-on flange		M8	
	M12, rotatable thread		M12	

Accessories

Mounting kit SMBR

Material:
Polyacetal
RoHS-compliant

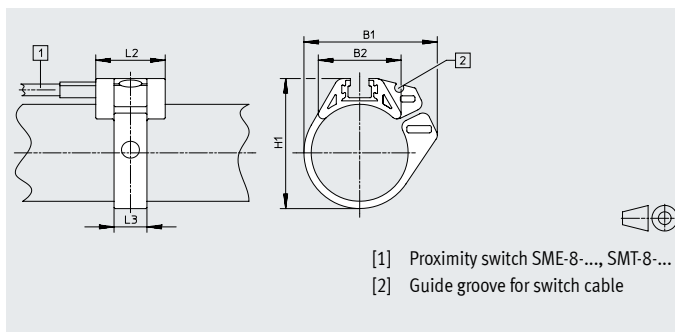

Dimensions and ordering data

For piston \varnothing	B1	B2	H1	L2	L3	Part no.	Type
8	18.9	12.3	17.5	19	7	175091	SMBR-8-8
10	20.4	13.7	19.9	19	7	175092	SMBR-8-10
12	22.7	14.3	21.9	19	7	★ 175093	SMBR-8-12
16	28.2	16.9	25.7	19	8	★ 175094	SMBR-8-16
20	34.5	20.8	30.4	19	9	★ 175095	SMBR-8-20
25	36.7	22.7	35.6	19	9	★ 175096	SMBR-8-25
32	41.7	24.6	42.7	19	9	175097	SMBR-8-32
40	47.1	26.5	50.7	19	9	175098	SMBR-8-40
50	56.4	28.6	61.5	19	9	175099	SMBR-8-50
63	69.4	32	74.5	19	9	175100	SMBR-8-63

Mounting kit CRSMB

Design: for round cylinders
Type of mounting: any
Type of mounting: glued
Degree of protection: IP65, IP68, IP69K
Ambient temperature: $-40 \dots +90^{\circ}\text{C}$
Material:
Housing: anodised aluminium,
TPE-U(PU)
Free of copper and PTFE
RoHS-compliant
PWIS conformity:
VDMA24364-B2-L

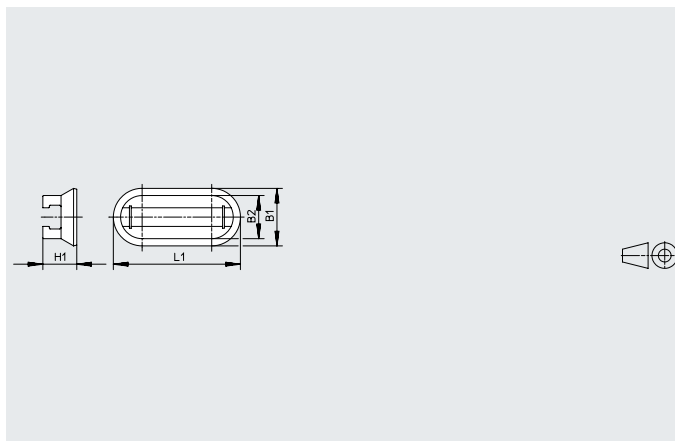

Ordering data

For piston \varnothing	B1	B2	H1	L1	CRC ¹⁾	Part no.	Type
32 ... 100	15.8	11.8	9.3	35	4	525565	CRSMB-8-32/100

1) Corrosion resistance class CRC 4 to Festo standard FN 940070
Particularly high corrosion stress. Outdoor exposure under extreme corrosive conditions. Parts exposed to aggressive media, e.g. in the chemical or food industries. Such applications may need to be safeguarded by means of special testing (→ also FN 940082), using appropriate media.

Accessories

Mounting kit SMB-8-FENG

Material:
Wrought aluminium alloy
Free of copper and PTFE

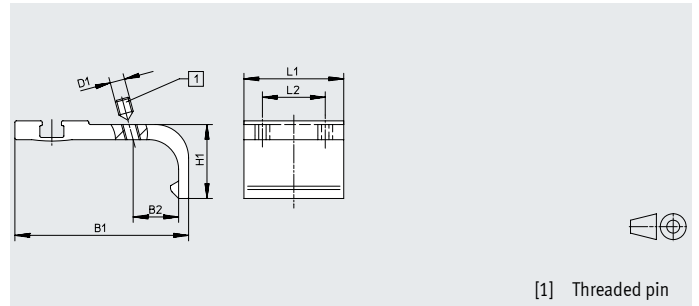
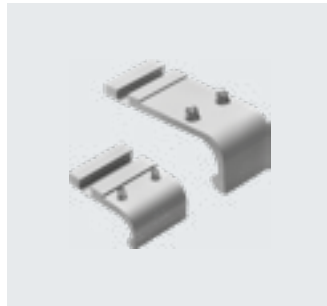

[1] Threaded pin

Dimensions and ordering data										
For piston \varnothing	B1	B2	D1	H1	L1	L2	Tightening torque [Nm]	Part no.	Type	
32/40	35.1	8.7	M3	15.5	27	17	0.2	175705	SMB-8-FENG-32/40	
50/63	47	12.3	M4	20	27	17	0.5	175706	SMB-8-FENG-50/63	
80/100	64.3	15.7	M5	24.3	27	17	0.7	175707	SMB-8-FENG-80/100	

Sensor bracket DASP-M4-...-A

Material:
Anodised wrought aluminium alloy
Screws: high-alloy stainless steel
RoHS-compliant

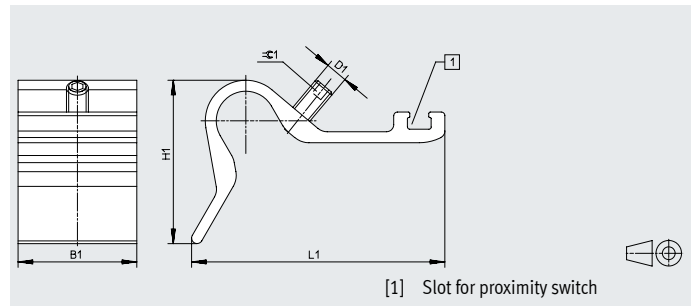

[1] Slot for proximity switch

Dimensions and ordering data										
Type	B1	D1	H1	L1	≈ 1	Tightening torque [Nm]	CRC ¹⁾	Weight [g]	Part no.	Type
DASP-M4-125-A	32.5	M5	28	45.4	2.5	1	3	26.5	1451483	DASP-M4-125-A
DASP-M4-160-A	32.5	M6	44.7	69.4	3	1	3	41.5	1553813	DASP-M4-160-A
DASP-M4-250-A	32.5	M6	56.3	88	3	1	3	60	1456781	DASP-M4-250-A
DASP-M4-320-A	32.5	M6	56.3	88	3	1	3	60	3015256	DASP-M4-320-A

1) Corrosion resistance class CRC 3 to Festo standard FN 940070

High corrosion stress. Outdoor exposure under moderate corrosive conditions. Externally visible parts with primarily functional surface requirements which are in direct contact with a normal industrial environment.

Accessories

Mounting kit SMB-8-C

Temperature: -40 ... 120°C

Material:

Retaining bracket: anodised wrought aluminium alloy

Screws: high-alloy stainless steel

Free of copper and PTFE,

RoHS-compliant

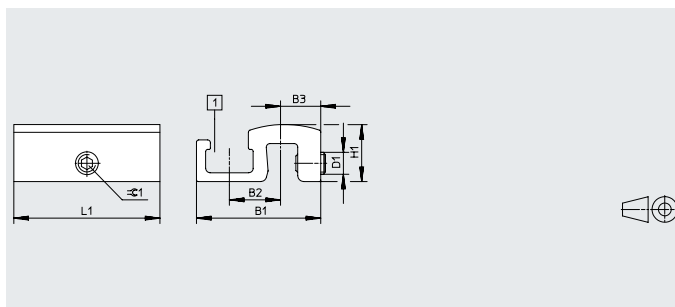

Dimensions and ordering data

Type	B1	B2	B3	D1	H1	L1	$\varnothing 1$	Tightening torque [Nm]	CRC ¹⁾	Weight [g]	Part no.	Type
SMB-8-C	17	7	5.5	M3	7.8	20	1.5	0.2 ... 0.6	3	3.5	1806790	SMB-8-C

1) Corrosion resistance class CRC 3 to Festo standard FN 940070

High corrosion stress. Outdoor exposure under moderate corrosive conditions. Externally visible parts with primarily functional surface requirements which are in direct contact with a normal industrial environment.

Positioning element SMM

Insertable in the slot lengthwise

Ambient temperature: -40 ... +120°C

Materials:

Housing: anodised wrought aluminium alloy

Screws: high-alloy stainless steel

Note on materials: RoHS-compliant

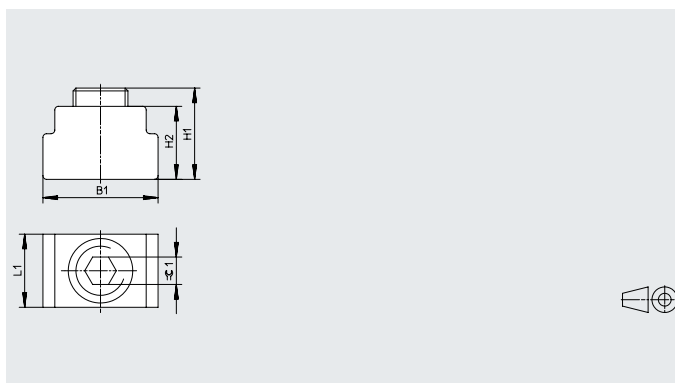

Dimensions and ordering data





B1	H1	H2	L1	$\varnothing 1$	CRC ¹⁾	Part no.	Type	PJ ²⁾
6.3	5.0	4.0	4.0	1.5	3	547941	SMM-8	10

1) Corrosion resistance class CRC 3 to Festo standard FN 940070

High corrosion stress. Outdoor exposure under moderate corrosive conditions. Externally visible parts with primarily functional surface requirements which are in direct contact with a normal industrial environment.

2) Packaging unit

Accessories

Ordering data – Connecting cables				Data sheets → Internet: nebu/sim	
		Number of wires	Cable length [m]	Part no.	Type
Socket M8x1, 3-pin					
	For SMT/SME-8... and SMT0/SMTSO/SME0-8E	3	2.5	★ 541333	NEBU-M8G3-K-2.5-LE3
			5	★ 541334	NEBU-M8G3-K-5-LE3
	For SMT/SME-8... and SMT0/SMTSO/SME0-8E	3	2.5	★ 541338	NEBU-M8W3-K-2.5-LE3
			5	★ 541341	NEBU-M8W3-K-5-LE3
Socket M12x1, 5-pin					
	For SMT/SME-8M and SMT0/SMTSO/SME0-8E	3	2.5	★ 541363	NEBU-M12G5-K-2.5-LE3
			5	★ 541364	NEBU-M12G5-K-5-LE3
	For SMT/SME-8M and SMT0/SMTSO/SME0-8E	3	2.5	541367	NEBU-M12W5-K-2.5-LE3
			5	541370	NEBU-M12W5-K-5-LE3

Ordering data – Mounting components			
	Description	Part no.	Type
	For fixing connecting cables in place	534254	SMBK-8

Ordering data – Sensor tester			
	Description	Part no.	Type
	<ul style="list-style-type: none"> Testing the functionality of proximity switches using the integrated voltage supply Adjusting proximity switches on the cylinder 	158481	SM-TEST-1

Ordering data – Inscription labels				
	Size	Part no.	Type	PU ¹⁾
	23x4 mm	541598	ASLR-L-423	34

1) Packaging unit

Ordering data – Inscription label holder							
	Length	Width	Height	For cable diameter	Part no.	Type	PS ¹⁾
	23 mm	5.4 mm	10.3 mm	2.5 ... 3.5 mm	8078306	NEAU-LH-2	100

1) Pack size