

Proximity switch for T-slot

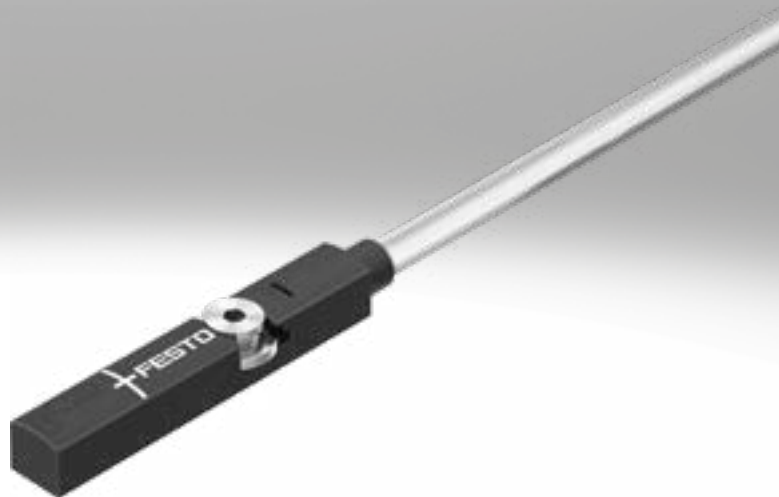

Festo Core Range
Solves the majority of your automation tasks

With the Festo Core Range, we have selected the most important products and functions from our broad product catalogue, and added the quickest delivery.

Worldwide: Quickest delivery – wherever, whenever
Simply good: Expected high Festo quality
Fast: Easy and fast to select

The Core Range offers you the best value for your automation tasks.

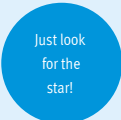

Product range overview

Design	Type of mounting	Measuring principle	Type	Operating voltage range	Switching output	Switching element function	→ Page
For T-slot	Standard						
	Screw-clamped, insertable in the slot from above	Magnetic Hall	SDBT-MSX	10 ... 30 V DC	PNP/NPN, switchable	N/O / N/C contact, switchable	–
	Insertable in the slot from above, flush with the cylinder profile	Magneto-resistive	SMT-8M-A	5 ... 30 V DC	PNP	N/O contact	–
						N/C contact	
					NPN	N/O contact	
					Non-contacting, 2-wire	N/O contact	
	Insertable in the slot from above, flush with the cylinder profile	Magnetic reed	SME-8M	5 ... 30 V AC/DC	Contacting, bipolar	N/O contact	7
						N/C contact	
	Insertable in the slot lengthwise, flush with the cylinder profile	Magnetic reed	SME-8	12 ... 30 V AC/DC	Contacting, bipolar	N/O contact	–
				3 ... 230 V AC/DC		N/C contact	
	Insertable in the slot lengthwise	Magneto-resistive	SMT-8G	10 ... 30 V DC	PNP, NPN	N/O contact	–
		Magneto-resistive	SMT-8-SL	10 ... 30 V DC	PNP	N/O contact	–
		Magnetic reed	SME-8-SL	10 ... 30 V AC/DC	Contacting, bipolar	N/O contact	–
	Insertable in the slot from above	Magnetic reed	SME-8-FM	10 ... 30 V AC/DC	Contacting, bipolar	N/O contact	–
	With accessories	Magneto-resistive	SMT-8E	10 ... 30 V DC	PNP	N/O contact	–
					NPN		
		Magnetic reed	SME-8E	12 ... 30 V DC	Contacting, bipolar	N/O contact	–
				3 ... 250 V DC			
				3 ... 230 V AC			
	Corrosion-resistant						
	Insertable in the slot from above, flush with the cylinder profile	Magneto-resistive	CRSMT-8M	5 ... 30 V DC	PNP	N/O contact	–
	Welding-field-resistant						
	Insertable in the slot from above, screw-clamped	Magneto-resistive	SDBT-BSW	10 ... 30 V DC	PNP	N/O contact	–
					NPN		
					Non-contacting, 2-wire		
	With accessories	Magneto-inductive	SMT-8E	10 ... 30 V DC	PNP	N/O contact	–
					NPN		
Heat-resistant up to 120°C							
Insertable in the slot lengthwise, flush with the cylinder profile	Magnetic reed	SME-8-...S6	0 ... 30 V AC/DC	Contacting, bipolar	N/O contact	–	
With accessories	Magnetic reed	SME-8E-...S6	0 ... 30 V DC	Contacting	N/O contact	–	
			0 ... 30 V AC				
To EU Explosion Protection Directive (ATEX)							
Insertable in the slot from above, screw-clamped	Magneto-resistive	SDBT-MS-...EX6	8.2 V DC	NAMUR	NAMUR	–	

Product range overview

Design	Type of mounting	Measuring principle	Type	Operating voltage range	Switching output	Switching element function	→ Page	
For C-slot	Standard	Magneto-resistive	SMT-10M	10 ... 30 V DC	PNP	N/O contact	C-slot	
					NPN			
					Non-contacting, 2-wire			
	Insertable in the slot from above, flush with the cylinder profile	Magnetic reed	SME-10M	5 ... 30 V AC/DC	Contacting, bipolar	N/O contact		
		Insertable in the slot lengthwise	Magneto-resistive	SMT-10G	10 ... 30 V DC	PNP		N/O contact
			Magnetic reed	SME-10	12 ... 27 V AC/DC	Contacting		N/O contact

T-slot switches can be used for drives with T-slot

Exceptions

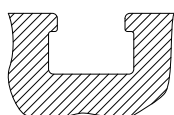

- DFM-B: SMT0-8E, SMTSO-8E, SME0-8E and SMP0-8E cannot be used
- DHDS: SME-8M can only be used on $\varnothing 50$
- DHPS: SME-8M can only be used on $\varnothing 20 \dots 35$
- HGDD-63-A: SMT-8M-A cannot be used
- HGPT-B: only SMT-8G can be used from size 40 and upwards
- SDBT-BSW- ... -PU/NU can only be used on a limited number of drive series. Page → 53

C-slot switches can be used for drives with C-slot

Exceptions

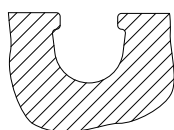

- ADVC $\varnothing 100$: SMT-10M and SME-10M cannot be used (ADVC has a T-slot and C-slot)
- DSM/DSM-B-6/8/10: SME-10M cannot be used
- DSM/DSM-B-10/16: SMT-10M cannot be used
- HGPT-B: only SMT-10G can be used for sizes up to and including size 35

For drives with sensor rail: these are available with 2 cylinder barrel contours

Only T-slot switches CRSMT-8M, SMT-8M-A and SDBT-MS- ... -EX6 can be used, and only with the identified profile.

CRSMT-8M and SMT-8M-A can be used for all diameters; SDBT-MS- ... -EX6 cannot be used for diameters 40 and 50.

Example: DSBF

Example: CDC

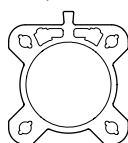

Suitable

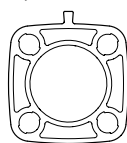

Not suitable

Peripherals overview

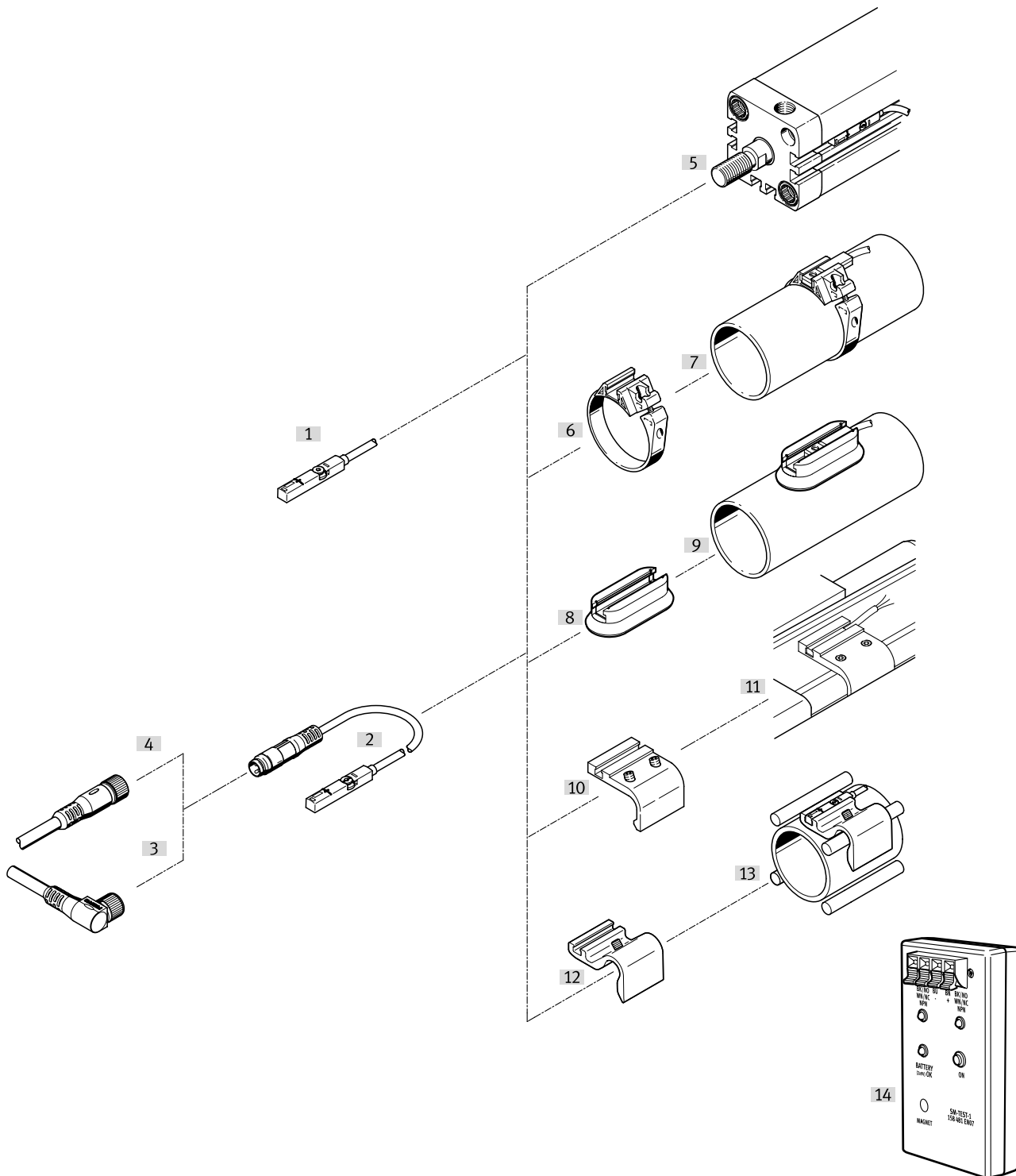

Peripherals overview

Mounting components and accessories		→ Page	Mounting components and accessories		→ Page
Proximity switches			Mounting kits and accessories		
[1]	SME-8M-...-OE, with cable	7	[6]	Mounting kit SMBR	13
[2]	SME-8M-...-M..., with cable and plug	7	[8]	Mounting kit CRSMB, corrosion-resistant	13
			[10]	Mounting kit SMB-8-FENG	14
			[12]	Sensor bracket DASP-M4-...	15
			[14]	Sensor tester SM-TEST-1	16
			-	Positioning element SMM-8	15
			-	Clip SMBK-8	16
			-	Inscription label ASLR	16
			-	Safety clip NEAU	16
Connecting cables			Drives		
[4]	NEBU-M...G...	16	[5]	Drives with T-slot	-
[3]	NEBU-M...W...	16	[7, 9]	Round cylinders	-
			[11]	Standards-based cylinders DSBC	-
			[13]	Drives with tie or mounting rod	-

Type codes

001	Series	
SME	Proximity sensor	
002	Design type	
8	For T-slot	
003	Sensor version	
M	Inserted in the slot from above	
004	Switching output	
DO	3-wire N/C contact	
DS	3-wire N/O contact	
ZS	2-wire PNP N/O contact	
005	Rated operating voltage	
	None	
24V	24 V	

006	Cable characteristic	
E	Suitable for energy chains/robot applications	
K	Standard/suitable for energy chains	
007	Cable length [m]	
	0.2 ... 10 m	
0,3	0.3 m	
2,5	2.5 m	
5,0	5.0 m	
7,5	7.5 m	
008	Connection technology	
OE	Open end	
M8	M8, snap-on flange	
M8D	M8, rotatable thread	
M12	M12, rotatable thread	

Data sheet – Magnetic reed

Function

PNP, N/O contact, open end

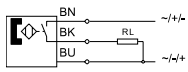

N/O contact, 3-wire, with plug

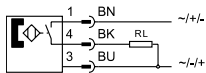

- Magnetic reed measuring principle
- Insertable in the slot from above, does not protrude over the cylinder profile



General technical data

Design	For T-slot
Based on standard	EN 60947-5-2
Certification	c UL us listed (OL) RCM compliance mark
CE marking (see declaration of conformity)	To EU EMC Directive
Special characteristics	Oil-resistant
Note on materials	Free of copper and PTFE RoHS-compliant

Input signal/measuring element

Measuring principle	Magnetic reed
Ambient temperature [°C]	-40 ... +70

Switching output

Type	SME-8M-DS	SME-8M-ZS	SME-8M-DO
Switching output	Contacting, bipolar		
Switching element function	N/O contact	N/O contact	N/C contact
Max. output current [mA]	500	80	
Max. output current in mounting kits [mA]	80	80	
Max. switching capacity DC [W]	10	2.4	
Max. switching capacity DC in mounting kits [W]	2.4	2.4	
Max. switching capacity AC [VA]	10	2.4	
Max. switching capacity AC in mounting kits [VA]	2.4	2.4	
Voltage drop ¹⁾ [V]	≤1.5	≤4.8	≤3.5

1) Applies to cable length 2.5 m. Max. 0.15 V voltage drop per metre of additional cable length

Output, additional data

Short circuit protection	No
Overload protection	Not present

Electronics

Operating voltage range DC [V]	5 ... 30
Operating voltage range AC [V]	5 ... 30
Reverse polarity protection	No

Data sheet – Magnetic reed

Electromechanics								
Switching element function	DS/DO				ZS			
Electrical connection	OE	M8D	M8	M12	OE	M8D	M8	M12
Electrical connection	Cable	Cable with plug			Cable	Cable with plug		
Connection technology	–	M8x1, A-coded to EN 61076-2-104	M8x1	M12x1	–	M8x1, A-coded to EN 61076-2-104	M8x1	M12x1
Number of pins/wires	3				2	3		
Type of mounting	–	Screw-type lock	Snap-on flange	Rotatable thread	–	Screw-type lock	Snap-on flange	Rotatable thread
Outlet direction of connection	In-line							
Cable test conditions	K	Cable chain: 5 million cycles, bending radius 75 mm						
		Resistance to bending: to Festo standard; test conditions on request						
	E	Cable chain: 5 million cycles, bending radius 28 mm						
		Torsional strength: $\pm 270^\circ/0.1$ m						
Resistance to bending: to Festo standard; test conditions on request								
Cable length	[m]	0.2 ... 10						
Cable characteristic	K	Standard + cable chain						
	E	Cable chain + robot						
Information on materials: cable sheath	K	TPE-U(PUR)						
	E	TPE-U(PUR), halogen-free						
Mechanics								
Electrical connection	OE				M...			
Type of mounting	Screw-clamped, insertable in the slot from above							
Housing	PA				PA			
	High-alloy stainless steel				High-alloy stainless steel			
	–				Nickel-plated brass			
	–				TPE-U(PUR)			
Display/operation								
Switching status indication	Yellow LED							
Immission/emission								
Ambient temperature with flexible cable installation	[°C]	–5 ... +70						
Degree of protection	IP65, IP68							

Data sheet – Magnetic reed

Pin allocation to EN 60947-5-2

M8x1, 2-polig, ZS, M8, M8D

N/O contact

	Pin	Wire colour	Allocation
	1	Brown	+
	4	Black	Output

M12x1, 2-polig, ZS, M12

N/O contact

	Pin	Wire colour	Allocation
	1	Brown	+
	4	Black	Output

Pin allocation to EN 60947-5-2

M8x1, 3-polig, DS, DO, M8

N/O contact / N/C contact

	Pin	Wire colour	Allocation
	1	Brown	+
	3	Blue	-
	4	Black	Output

M12x1, 3-polig, DS, M12

N/O contact

	Pin	Wire colour	Allocation
	1	Brown	+
	3	Blue	-
	4	Black	Output

Pin allocation to EN 60947-5-2

M12x1, 3-polig, DO, M12

N/C contact

	Pin	Wire colour	Allocation
	1	Brown	+
	3	Blue	-
	2	White	Output

Data sheet – Magnetic reed

Dimensions

Download CAD data → www.festo.com

SME-8M-...-OE – Cable

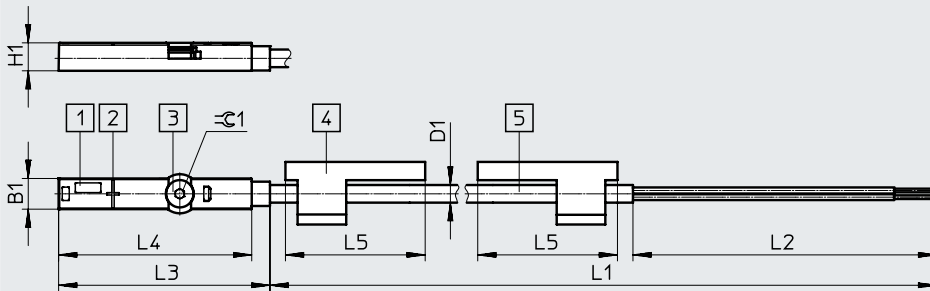

- [1] Yellow light emitting diode
 - [2] Centre of the sensor element
 - [3] Clamping element, tightening torque 0.6 Nm
 - [4] Inscription label holder
 - [5] Connecting cable
- L1 Cable length

SME-8M-DO-...-OE – Cable

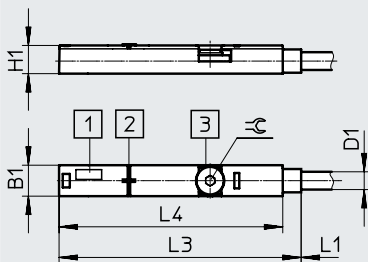

- [1] Light emitting diode
 - [2] Centre of the sensor element
 - [3] Clamping element, tightening torque 0.6 Nm
- L1 Cable length

SME-8M-...-M8D – Cable with plug M8x1, rotatable thread

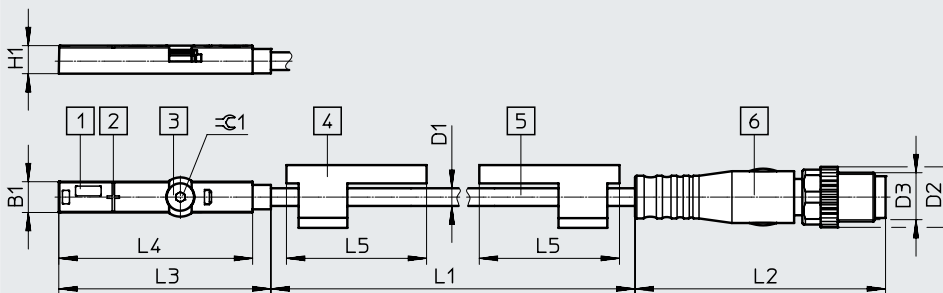

- [1] Yellow light emitting diode
 - [2] Centre of the sensor element
 - [3] Clamping element, tightening torque 0.6 Nm
 - [4] Inscription label holder
 - [5] Connecting cable
 - [6] Plug to fit connecting cable NEBU-M8
- L1 Cable length

SME-8M-...-M8 – Cable with plug M8x1, snap-on flange

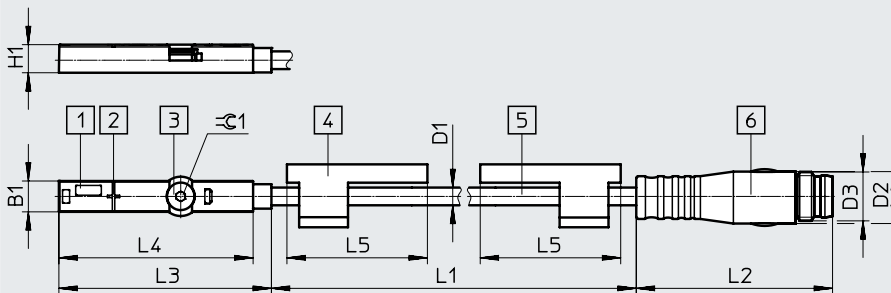

- [1] Yellow light emitting diode
 - [2] Centre of the sensor element
 - [3] Clamping element, tightening torque 0.6 Nm
 - [4] Inscription label holder
 - [5] Connecting cable
 - [6] Plug to fit connecting cable NEBU-M8
- L1 Cable length

Type	B1 ±0.05	D1 ∅	D2 ∅	D3	H1 ±0.05	L2	L3	L4 ±0.1	L5	⌀C1
SME-8M-...-OE	5	2.9	-	-	4.6	50	34.8	31.8	23	1.5
SME-8M-DO-...-OE			-	-		-	39.5	36.5	-	
SME-8M-...-M8D			9.6	M8x1		41.1	34.8	31.8	23	
SME-8M-...-M8			8.5	M8x1		32.7	34.8	31.8	23	

Data sheet – Magnetic reed

Dimensions

Download CAD data → www.festo.com

SME-8M-...-M12 – Cable with plug M12x1, rotatable thread

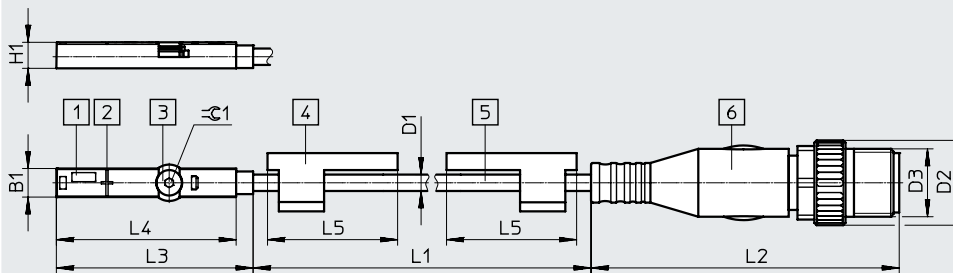

- [1] Yellow light emitting diode
- [2] Centre of the sensor element
- [3] Clamping element, tightening torque 0.6 Nm
- [4] Inscription label holder
- [5] Connecting cable
- [6] Plug to fit connecting cable NE-BU-M12

L1 Cable length

Type	B1	D1 ∅	D2	D3	H1	L2	L3	L4	L5	≈G 1
SME-8M-...-M12	5	2.9	15	M12x1	4.6	54.5	34.8	31.8	23	1.5

★ Core product range

Ordering data

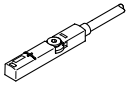
	Switching output	Electrical connection		Cable length [m]	Part no.	Type
		Cable	Cable with plug, rotatable thread, M8x1			
	N/O contact					
	Contacting Bipolar	3-wire	–	2.5	★ 543862	SME-8M-DS-24V-K-2.5-OE
		–	3-pin	0.3	★ 543863	SME-8M-DS-24V-K-5.0-OE
		2-wire	–	2.5	★ 543872	SME-8M-ZS-24V-K-2.5-OE
N/C contact						
Contacting Bipolar	3-wire	–	7.5	★ 546799	SME-8M-DO-24V-K-7.5-OE	

Ordering data

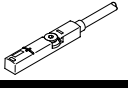
	Switching output	Electrical connection		Cable length [m]	Part no.	Type
		Cable	Cable with plug, rotatable thread, M8x1			
	N/O contact					
	Contacting Bipolar	3-wire	–	7.5	543876	SME-8M-DS-24V-K-7.5-OE

Modular product system – Magnetic reed

Ordering table		Conditions	Code	Enter code
Size	8			
Module no.	543892			
Function	Proximity switch for T-slot, contacting		SME-8M	SME-8M
			–	–
Switching output	3-wire N/O contact		DS	
	2-wire N/O contact		ZS	
	3-wire N/C contact		DO	
			–	–
Rated operating voltage [V DC]	24		24V	24V
			–	–
Cable characteristic	Standard + cable chain		K	
	Cable chain + robot		E	
			–	–
Cable length [m]	0.2 ... 10		...	
	(0.2 ... 5.0 m in 0.1 m increments, 5.0 ... 10 m in 0.5 m increments)			
			–	–
Connection technology	Open end		OE	
	M8, rotatable thread		M8D	
	M8, snap-on flange		M8	
	M12, rotatable thread		M12	

Accessories

Mounting kit SMBR

Material:
Polyacetal
RoHS-compliant

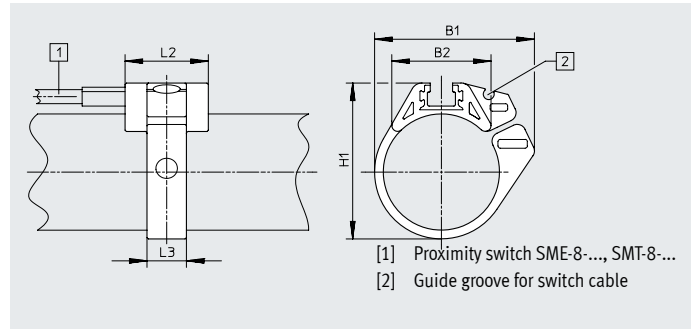

Dimensions and ordering data

For piston \varnothing	B1	B2	H1	L2	L3	Part no.	Type
8	18.9	12.3	17.5	19	7	175091	SMBR-8-8
10	20.4	13.7	19.9	19	7	175092	SMBR-8-10
12	22.7	14.3	21.9	19	7	★ 175093	SMBR-8-12
16	28.2	16.9	25.7	19	8	★ 175094	SMBR-8-16
20	34.5	20.8	30.4	19	9	★ 175095	SMBR-8-20
25	36.7	22.7	35.6	19	9	★ 175096	SMBR-8-25
32	41.7	24.6	42.7	19	9	175097	SMBR-8-32
40	47.1	26.5	50.7	19	9	175098	SMBR-8-40
50	56.4	28.6	61.5	19	9	175099	SMBR-8-50
63	69.4	32	74.5	19	9	175100	SMBR-8-63

Mounting kit CRSMB

Design: for round cylinders
Type of mounting: any
Type of mounting: glued
Degree of protection: IP65, IP68, IP69K
Ambient temperature: $-40 \dots +90^{\circ}\text{C}$
Material:
Housing: anodised aluminium,
TPE-U(PU)
Free of copper and PTFE
RoHS-compliant
PWIS conformity:
VDMA24364-B2-L

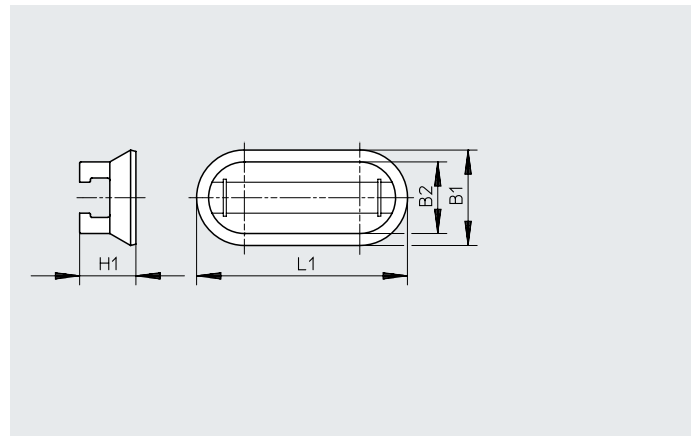

Ordering data

For piston \varnothing	B1	B2	H1	L1	CRC ¹⁾	Part no.	Type
32 ... 100	15.8	11.8	9.3	35	4	525565	CRSMB-8-32/100

1) Corrosion resistance class CRC 4 to Festo standard FN 940070
Particularly high corrosion stress. Outdoor exposure under extreme corrosive conditions. Parts exposed to aggressive media, e.g. in the chemical or food industries. Such applications may need to be safeguarded by means of special testing (→ also FN 940082), using appropriate media.

Accessories

Mounting kit SMB-8-FENG

Material:
Wrought aluminium alloy
Free of copper and PTFE

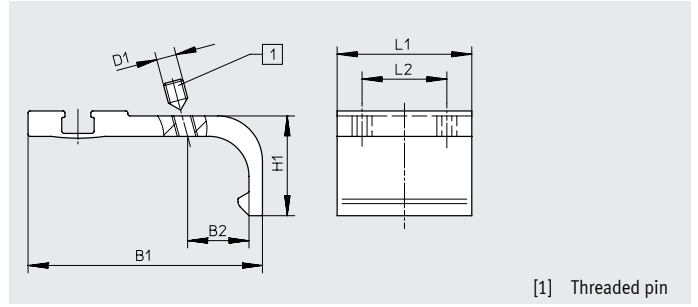
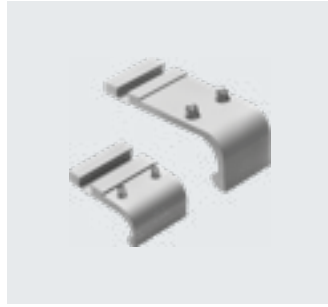

[1] Threaded pin

Dimensions and ordering data

For piston \varnothing	B1	B2	D1	H1	L1	L2	Tightening torque [Nm]	Part no.	Type
32/40	35.1	8.7	M3	15.5	27	17	0.2	175705	SMB-8-FENG-32/40
50/63	47	12.3	M4	20	27	17	0.5	175706	SMB-8-FENG-50/63
80/100	64.3	15.7	M5	24.3	27	17	0.7	175707	SMB-8-FENG-80/100

Accessories

Sensor bracket DASP-M4-...-A

Material:
Anodised wrought aluminium alloy
Screws: high-alloy stainless steel
RoHS-compliant

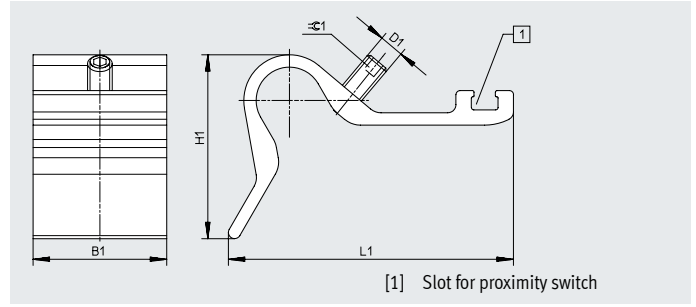

Dimensions and ordering data										
Type	B1	D1	H1	L1	$\approx \ominus 1$	Tightening torque [Nm]	CRC ¹⁾	Weight [g]	Part no.	Type
DASP-M4-125-A	32.5	M5	28	45.4	2.5	1	3	26.5	1451483	DASP-M4-125-A
DASP-M4-160-A	32.5	M6	44.7	69.4	3	1	3	41.5	1553813	DASP-M4-160-A
DASP-M4-250-A	32.5	M6	56.3	88	3	1	3	60	1456781	DASP-M4-250-A
DASP-M4-320-A	32.5	M6	56.3	88	3	1	3	60	3015256	DASP-M4-320-A

1) Corrosion resistance class CRC 3 to Festo standard FN 940070
High corrosion stress. Outdoor exposure under moderate corrosive conditions. Externally visible parts with primarily functional surface requirements which are in direct contact with a normal industrial environment.

Positioning element SMM

Insertable in the slot lengthwise

Ambient temperature: -40 ... +120°C



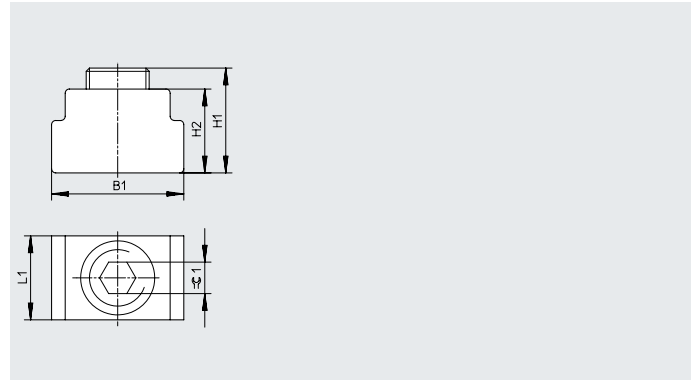

Materials:
Housing: anodised wrought aluminium alloy
Screws: high-alloy stainless steel
Note on materials: RoHS-compliant



Dimensions and ordering data									
B1	H1	H2	L1	$\approx \ominus 1$	CRC ¹⁾	Part no.	Type	PU ²⁾	
6.3	5.0	4.0	4.0	1.5	3	547941	SMM-8	10	

1) Corrosion resistance class CRC 3 to Festo standard FN 940070
High corrosion stress. Outdoor exposure under moderate corrosive conditions. Externally visible parts with primarily functional surface requirements which are in direct contact with a normal industrial environment.
2) Packaging unit

Accessories

Ordering data – Connecting cables		Number of wires	Cable length [m]	Part no.	Type	Data sheets → Internet: nebu/sim
Socket M8x1, 3-pin						
	For SMT/SME-8... and SMT0/SMTSO/SME0-8E	3	2.5	★ 541333	NEBU-M8G3-K-2.5-LE3	
			5	★ 541334	NEBU-M8G3-K-5-LE3	
	For SMT/SME-8... and SMT0/SMTSO/SME0-8E	3	2.5	★ 541338	NEBU-M8W3-K-2.5-LE3	
			5	★ 541341	NEBU-M8W3-K-5-LE3	
Socket M12x1, 5-pin						
	For SMT/SME-8M and SMT0/SMTSO/SME0-8E	3	2.5	★ 541363	NEBU-M12G5-K-2.5-LE3	
			5	★ 541364	NEBU-M12G5-K-5-LE3	
	For SMT/SME-8M and SMT0/SMTSO/SME0-8E	3	2.5	541367	NEBU-M12W5-K-2.5-LE3	
			5	541370	NEBU-M12W5-K-5-LE3	

Ordering data – Safety clip for ATEX zone		Size	Description	Part no.	Type	PU ¹⁾
	M8	<ul style="list-style-type: none"> Protects "equipment that is not intrinsically safe" in zones 2 and 22 against simple disconnection ATEX category: gas: II 3G / dust: II 3D 	548067	NEAU-M8-GD	1	
	M12		548068	NEAU-M12-GD	1	

1) Packaging unit

Ordering data – Mounting components		Description	Part no.	Type
		For fixing connecting cables in place	534254	SMBK-8

Ordering data – Sensor tester		Description	Part no.	Type
		<ul style="list-style-type: none"> Testing the functionality of proximity switches using the integrated voltage supply Adjusting proximity switches on the cylinder 	158481	SM-TEST-1

Ordering data – Inscription labels		Size	Part no.	Type	PU ¹⁾
		23x4 mm	541598	ASLR-L-423	34

1) Packaging unit