

## Vacuum security valves ISV

**FESTO**



## Key features

### Areas of application

- For parallel arrangement of multiple suction cups
  - so that the vacuum does not break down if one or more suction cups does not have a tight seal
- Gripping of randomly placed products
- Saves air and energy
  - gripping occurs only with full contact
- Maintains vacuum

### Function diagram

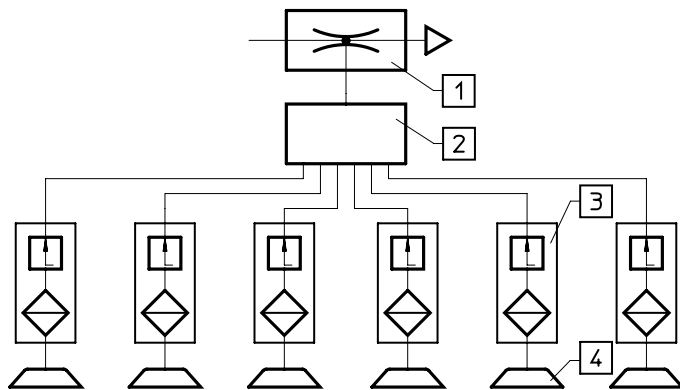

- [1] Vacuum generator
- [2] Distributor
- [3] Vacuum security valve
- [4] Suction cup

The vacuum security valves are suitable for maintaining the vacuum in applications where several suction cups are used and one or more suction cups fail.

### Function of the security valve

The vacuum security valve ISV is mounted between the suction cup and the vacuum generator.

If, during vacuum generation, the suction cup is uncovered or only partly covered, the vacuum security valve automatically stops the influx of air.

Once the suction cup is seated tightly on the surface, the vacuum is switched back on again.

If the workpiece is separated from the suction cup, the vacuum security valve immediately closes.

1. If the suction cup is open to the environment, the float is pressed back against the housing. In this position, air can only flow through a small hole at the front of the float.
2. If a workpiece comes in contact with the suction cup, the air flow is reduced and the spring forces the float forward. This causes the vacuum security valve to open, and a complete vacuum is created in the suction cup.

## Data sheet

 Temperature range  
 -10 ... +60°C

 Operating pressure  
 -95 ... 0 kPa

**General technical data**

Pneumatic connection 1, 2	For suction cup				For suction gripper		
	M5	G1/8	G1/4	G3/8	M4	M6	M10
Mounting position	Any						
Type of mounting	Screw-in						
Ejector pulse suitability [MPa]	≤ 0.8						
Required suction rate at -50 kPa [l/min]	1	2	1.6	1.5	1	2	2

**Operating and environmental conditions**

Operating pressure [kPa]	-95 ... 0
Operating medium	Atmospheric air based on ISO 8573-1:2010 [7:-:-]
Ambient temperature [°C]	-10 ... +60
Corrosion resistance class CRC <sup>1)</sup>	2

1) Corrosion resistance class CRC 2 to Festo standard FN 940070

Moderate corrosion stress. Indoor applications in which condensation can occur. External visible parts with primarily decorative surface requirements which are in direct contact with a normal industrial environment.

**Weight [g]**

Pneumatic connection 1, 2	For suction cup				For suction gripper		
	M5	G1/8	G1/4	G3/8	M4	M6	M10
Vacuum security valve	4	9	16	33	1.5	14	18

**Materials**

Pneumatic connection 1, 2	For suction cup				For suction gripper		
	M5	G1/8	G1/4	G3/8	M4	M6	M10
Housing	Wrought aluminium alloy	Wrought aluminium alloy			Wrought aluminium alloy	Wrought aluminium alloy	
Filter	Sintered bronze	Wrought aluminium alloy, stainless steel mesh			Sintered bronze	Sintered bronze	
Spring	-	High-alloy steel			-	High-alloy steel	
Hollow bolt	-	Wrought aluminium alloy			-	-	
Float	-	POM			-	POM	

Data sheet

Evacuation time  $t$  as a function of the volume  $V$  to be evacuated with various vacuum generators

ISV-M5

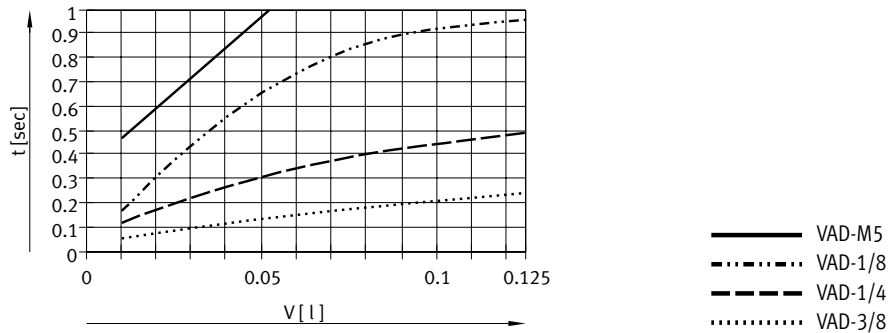

ISV-1/8/ISV-1/4

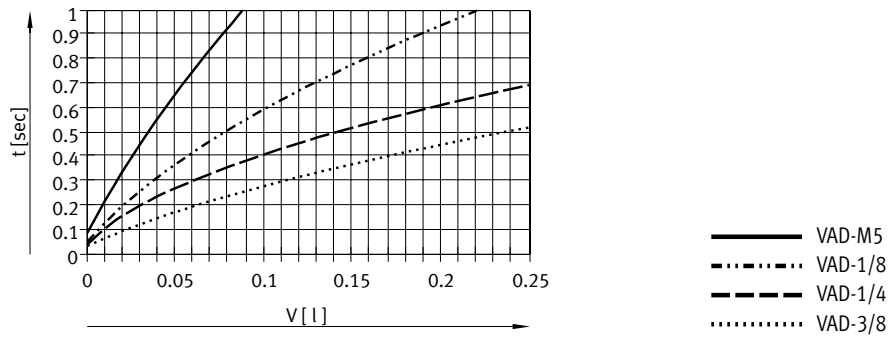

ISV-3/8

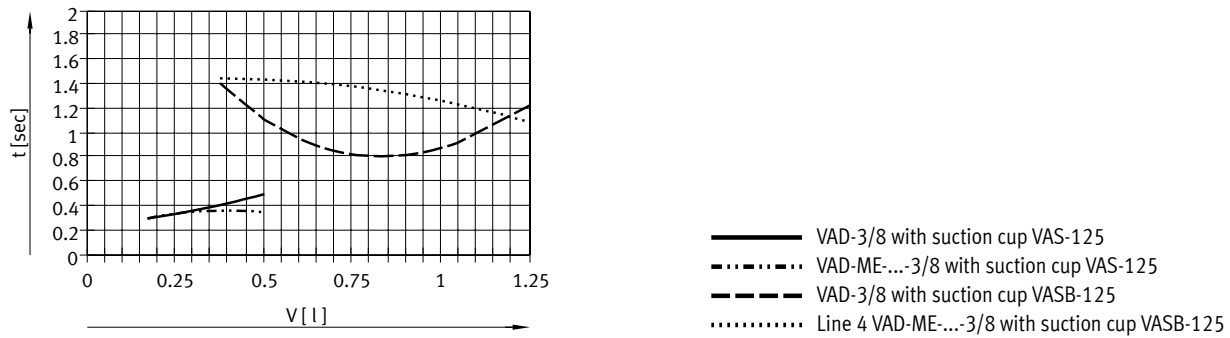

 **Note**  
Evacuation time is the time required to achieve 90% of the maximum possible vacuum.

## Data sheet

## Conditions for operating the vacuum security valve ISV

- The number of suction cups that can be secured depends on the suction capacity of the vacuum generator.
- If the vacuum generator has a parallel connection, a minimum switching flow rate is required for the function of each vacuum security valve ISV.
- The number of suction cups that can be secured can be estimated from the ratio of the suction capacity of the vacuum generator to the minimum switching flow rate of the vacuum security valve ISV.

## Max. number of secured suction cups as a function of the vacuum generator used and the vacuum that can be achieved

Vacuum generator	Max. number of suction cups at $p_U$ [kPa]											
	ISV-M5			ISV-1/8			ISV-1/4			ISV-3/8		
	-50	-60	-70	-50	-60	-70	-50	-60	-70	-50	-60	-70
VAD-M5	2	1	-	1	1	-	1	-	-	-	-	-
VAD-1/8	4	2	1	2	1	-	2	1	-	-	-	-
VAD-1/4	8	6	3	4	3	1	4	3	1	-	-	-
VAD-3/8	8	8	7	7	6	3	7	6	3	-	2	1
VADM/VADMI-45	2	1	-	1	1	-	1	-	-	-	-	-
VADM/VADMI-70	4	2	1	2	1	-	2	1	-	-	-	-
VADM/VADMI-95	8	6	3	4	3	1	4	2	1	-	-	-
VADM/VADMI-140	8	8	7	7	6	3	7	6	3	3	2	1
VADM/VADMI-200	16	16	14	14	12	6	14	12	6	6	4	2
VADM/VADMI-300	32	32	28	28	24	12	28	14	12	12	8	4
OVEL-5-H	2	-	-	1	-	-	1	-	-	1	-	-
OVEL-5-L	2	-	-	1	-	-	1	-	-	1	-	-
OVEL-7-H	6	-	-	3	-	-	3	-	-	4	-	-
OVEL-7-L	11	-	-	5	-	-	6	-	-	7	-	-
OVEL-10-H	8	-	-	4	-	-	5	-	-	5	-	-
OVEL-10-L	19	-	-	9	-	-	12	-	-	13	-	-
OVEM-...-B-14-H	15	-	-	7	-	-	9	-	-	10	-	-
OVEM-...-B-14-L	37	-	-	18	-	-	23	-	-	24	-	-
OVEM-...-B-20-H	30	-	-	15	-	-	18	-	-	20	-	-
OVEM-...-C-20-H	39	-	-	19	-	-	24	-	-	26	-	-
OVEM-...-C-20-L	84	-	-	42	-	-	52	-	-	56	-	-
OVEM-...-C-30-H	70	-	-	35	-	-	43	-	-	46	-	-
OVEM-...-C-30-L	115	-	-	57	-	-	72	-	-	76	-	-
VN-05-H	2	-	-	1	-	-	1	-	-	1	-	-
VN-05-L	3	-	-	1	-	-	1	-	-	2	-	-
VN-05-M	1	-	-	0	-	-	1	-	-	1	-	-
VN-07-H	5	-	-	2	-	-	3	-	-	3	-	-
VN-07-M	3	-	-	1	-	-	1	-	-	2	-	-
VN-10-H	10	-	-	5	-	-	6	-	-	6	-	-
VN-10-L	10	-	-	5	-	-	6	-	-	6	-	-
VN-10-M	8	-	-	4	-	-	5	-	-	5	-	-
VN-14-H	23	-	-	11	-	-	14	-	-	15	-	-
VN-14-L	3	-	-	1	-	-	2	-	-	2	-	-
VN-20-H	36	-	-	18	-	-	23	-	-	24	-	-
VN-30-H	68	-	-	34	-	-	43	-	-	45	-	-
VN-30-L	131	-	-	65	-	-	81	-	-	87	-	-
VN-05-H-...-A/B/M/P	2	-	-	1	-	-	1	-	-	1	-	-
VN-05-L-...-A/B/M/P	4	-	-	2	-	-	2	-	-	3	-	-
VN-07-H-...-A/B/M/P	6	-	-	3	-	-	3	-	-	4	-	-
VN-07-L-...-A/B/M/P	0	-	-	0	-	-	0	-	-	0	-	-
VN-10-H-...-A/B/M/P	8	-	-	4	-	-	5	-	-	5	-	-
VN-10-L-...-A/B/M/P	18	-	-	9	-	-	11	-	-	12	-	-
VN-14-H-...-A/B/M/P	15	-	-	7	-	-	9	-	-	10	-	-
VN-14-L-...-A/B/M/P	40	-	-	20	-	-	25	-	-	26	-	-
VN-20-H-...-A/B/M/P	36	-	-	18	-	-	23	-	-	24	-	-
VN-30-H-...-A/B/M/P	68	-	-	34	-	-	43	-	-	45	-	-

Data sheet

Max. number of secured suction grippers as a function of the vacuum generator used and the vacuum that can be achieved									
Vacuum generator	Max. number of suction grippers at $p_u$ [kPa]								
	ISV-M4			ISV-M6			ISV-M10		
	-50	-60	-70	-50	-60	-70	-50	-60	-70
VAD-M5	-	1	-	1	1	-	1	-	-
VAD-1/8	-	2	1	2	1	-	2	1	-
VAD-1/4	1	6	3	4	3	1	4	3	1
VAD-3/8	3	8	7	7	6	3	7	6	3
VADM/VADMI-45	-	1	-	1	1	-	1	-	-
VADM/VADMI-70	-	2	1	2	1	-	2	1	-
VADM/VADMI-95	1	6	3	4	3	1	4	2	1
VADM/VADMI-140	3	8	7	7	6	3	7	6	3
VADM/VADMI-200	6	16	14	14	12	6	14	12	6
VADM/VADMI-300	12	32	28	28	24	12	28	14	12
OVEM-5-H	2	-	-	1	-	-	1	-	-
OVEM-5-L	2	-	-	1	-	-	1	-	-
OVEM-7-H	6	-	-	3	-	-	3	-	-
OVEM-7-L	11	-	-	5	-	-	5	-	-
OVEM-10-H	8	-	-	4	-	-	4	-	-
OVEM-10-L	19	-	-	9	-	-	9	-	-
OVEM-...-B-14-H	15	-	-	7	-	-	7	-	-
OVEM-...-B-14-L	37	-	-	18	-	-	18	-	-
OVEM-...-B-20-H	30	-	-	15	-	-	15	-	-
OVEM-...-C-20-H	39	-	-	19	-	-	19	-	-
OVEM-...-C-20-L	84	-	-	42	-	-	42	-	-
OVEM-...-C-30-H	70	-	-	35	-	-	35	-	-
OVEM-...-C-30-L	115	-	-	57	-	-	57	-	-
VN-05-H	2	-	-	1	-	-	1	-	-
VN-05-L	3	-	-	1	-	-	1	-	-
VN-05-M	1	-	-	0	-	-	0	-	-
VN-07-H	5	-	-	2	-	-	2	-	-
VN-07-M	3	-	-	1	-	-	1	-	-
VN-10-H	10	-	-	5	-	-	5	-	-
VN-10-L	10	-	-	5	-	-	5	-	-
VN-10-M	8	-	-	4	-	-	4	-	-
VN-14-H	23	-	-	11	-	-	11	-	-
VN-14-L	3	-	-	1	-	-	1	-	-
VN-20-H	36	-	-	18	-	-	18	-	-
VN-30-H	68	-	-	34	-	-	34	-	-
VN-30-L	131	-	-	65	-	-	65	-	-
VN-05-H-...-A/B/M/P	2	-	-	1	-	-	1	-	-
VN-05-L-...-A/B/M/P	4	-	-	2	-	-	2	-	-
VN-07-H-...-A/B/M/P	6	-	-	3	-	-	3	-	-
VN-07-L-...-A/B/M/P	0	-	-	0	-	-	0	-	-
VN-10-H-...-A/B/M/P	8	-	-	4	-	-	4	-	-
VN-10-L-...-A/B/M/P	18	-	-	9	-	-	9	-	-
VN-14-H-...-A/B/M/P	15	-	-	7	-	-	7	-	-
VN-14-L-...-A/B/M/P	40	-	-	20	-	-	20	-	-
VN-20-H-...-A/B/M/P	36	-	-	18	-	-	18	-	-
VN-30-H-...-A/B/M/P	68	-	-	34	-	-	34	-	-

## Data sheet

## Dimensions

For suction cup

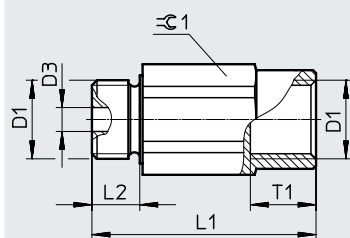

[3] Sealing ring

For suction gripper

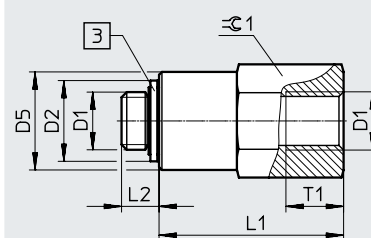

[3] Sealing ring

Type	D1	D2 ∅	D3 ∅	D5 ∅	L1	L2	T1	≈ 1
<b>For suction cup</b>								
ISV-M5	M5	-	2	-	15	4.3	5.5	8
ISV-1/8	G1/8	-	4	-	36	6.5	11	13
ISV-1/4	G1/4	-	4	-	37.5	8	11	17
ISV-3/8	G3/8	-	4	-	42	9	13	22
<b>For suction gripper</b>								
ISV-M4	M4	7.8	-	7	10.7	3.8	5	7
ISV-M6	M6	8.4	-	14	28.3	5	5	14
ISV-M10	M10	13	-	17	32	6.5	10	17

## Ordering data

Description	Pneumatic connection 1, 2	Part no.	Type
For suction cup	M5	151217	ISV-M5
	G1/8	33969	ISV-1/8
	G1/4	33970	ISV-1/4
	G3/8	33971	ISV-3/8
For suction gripper	M4	545996	ISV-M4
	M6	545997	ISV-M6
	M10	545998	ISV-M10