

Angle grippers HGW

FESTO



-  - Type discontinued
Available up until 2011

Angle grippers HGW

Key features

FESTO



At a glance

- Double-acting piston drive
- Self-centring
- Variable gripping action:
 - External/internal gripping
- Versatility thanks to externally adaptable gripper fingers
- Wide range of options for mounting on drive units
- Constant gripping torque over the entire angle range
- 40° opening angle
- Internal fixed flow control
- Sensor technology:
 - Adaptable proximity sensors on the small grippers
 - Integral proximity sensors for medium and large grippers

-  - Note
Sizing software
Gripper selection
→ www.festo.com

Mounting options for external gripper fingers (customer-specific)

- 1 Angle gripper
- 2 External gripper fingers
- 3 Mounting screws
- 4 Centring pins

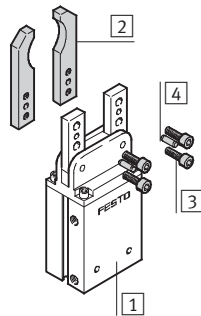

-  - Note
Grippers should always be used with exhaust air flow control. They are not suitable for the following, or for similar applications:

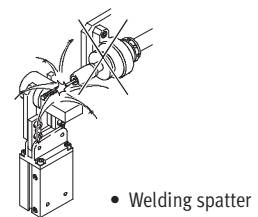
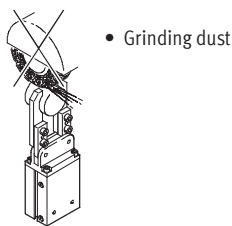
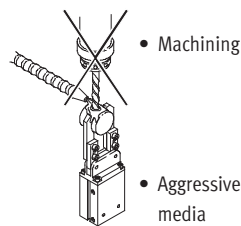

Angle grippers HGW

Peripherals overview and type codes

Peripherals overview

HGW-10

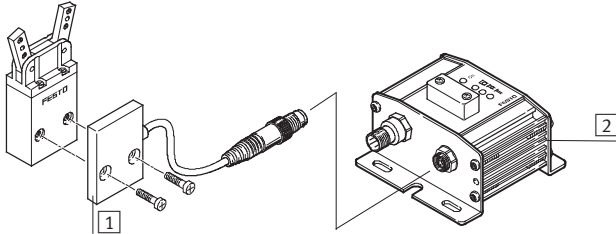

HGW-16 ... 40

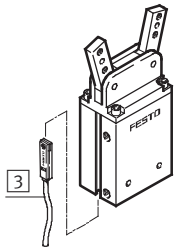

System product for handling and assembly technology

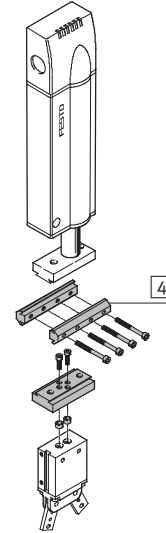

Accessories

Type	Brief description	→ Page/Internet
1 Position sensor SMH-S1	Adaptable and integratable sensor technology, for sensing the piston position	11
2 Evaluation unit SMH-AE1	For position sensor SMH-S1	11
3 Proximity sensor SME/SMT-8	For sensing the piston position	11
4 -	Drive/gripper connections	adapter kit

Type codes

HGW		16	A
Type			
HGW	Angle gripper		
Size			
Position sensing			
A	For proximity sensing		

- 1 - Type discontinued
Available up until 2011

Angle grippers HGW

Technical data

FESTO

Function
Double-acting

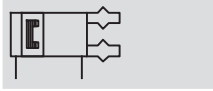

www.festo.com

Wearing parts kits
→ 10



- 2 - Size
10 ... 40 mm

General technical data					
Size	10	16	25	32	40
Design	Lever mechanism				
Mode of operation	Double-acting				
Gripper function	Angle				
Number of gripper jaws	2				
Opening angle [°]	40				
Pneumatic connection	M3		M5	G $\frac{1}{8}$	
Repetition accuracy ¹⁾ [mm]	≤ 0.04				
Max. interchangeability [mm]	0.2				
Max. operating frequency [Hz]	4				
Position sensing	For proximity sensing				
Type of mounting	With female thread and centring hole				

1) End position drift under constant conditions of use with 100 consecutive strokes in the direction of movement of the gripper jaws

Operating and environmental conditions		
Min. operating pressure [bar]	2	
Max. operating pressure [bar]	8	
Operating medium	Filtered compressed air, lubricated or unlubricated	
Ambient temperature [°C]	+5 ... +60	
Corrosion resistance class CRC ¹⁾	2	

1) Corrosion resistance class 2 according to Festo standard 940 070

Components requiring moderate corrosion resistance. Externally visible parts with primarily decorative surface requirements which are in direct contact with a normal industrial environment or media such as coolants or lubricating agents

Weights [g]					
Size	10	16	25	32	40
HGW	39	100	250	420	720

Angle grippers HGW

Technical data

Materials

Sectional view

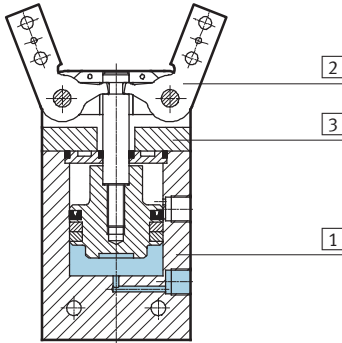

Angle gripper		
1	Body	Hard anodised aluminium
2	Gripper jaw	Nickel-plated tool steel
3	Cover cap	Polyacetate
-	Note on materials	Copper, PTFE and silicone-free Conforms to RoHS

Total gripping torque [Ncm] at 6 bar, with external gripper fingers

External gripping

Internal gripping

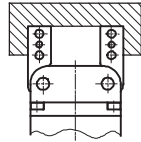
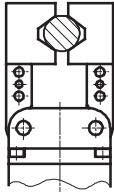

Size	10	16	25	32	40
Total gripping torque					
Opening	25	120	360	680	965
Closing	22	106	320	600	880

Characteristic load values at the gripper jaws

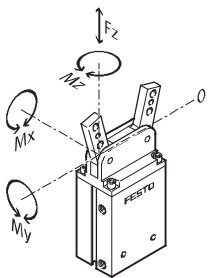

The indicated permissible forces and torques apply to a single gripper jaw. Static forces and torques relate to additional applied loads caused by

the workpiece or external gripper fingers, as well as forces which occur during handling. The zero co-ordinate

line (gripper jaws point of rotation) must be taken into consideration for the calculation of torques.

Size	10	16	25	32	40	
Max. permissible force F_z	[N]	16	31	54	74	124
Max. permissible torque M_x	[Nm]	0.3	0.9	1.7	3	5.7
Max. permissible torque M_y	[Nm]	0.1	0.3	0.6	1	2.2
Max. permissible torque M_z	[Nm]	0.2	0.5	1.1	1.8	3.6

- 1 - Type discontinued
Available up until 2011

Angle grippers HGW

Technical data

FESTO

Mass moment of inertia [$\text{kgm}^2 \times 10^{-4}$]

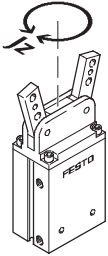

Mass moment of inertia [$\text{kgm}^2 \times 10^{-4}$] for angle grippers in relation to the central axis, without external gripper fingers, without load.

Size	10	16	25	32	40
HGW	0.03	0.13	0.60	1.48	3.54

Opening and closing times [ms] at 6 bar

Without external gripper fingers

With external gripper fingers

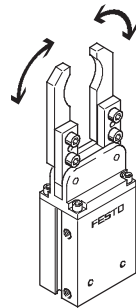
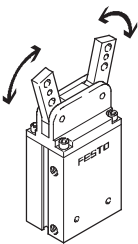

The indicated opening and closing times [ms] have been measured at room temperature and 6 bar operating pressure without external gripper fingers.

The grippers must be throttled for greater applied loads. Opening and closing times must then be adjusted accordingly.

Size		10	16	25	32	40
Without external gripper fingers						
HGW	Opening	5	25	50	50	60
	Closing	5	30	40	40	50
With external gripper fingers → 7						

Angle grippers HGW

Technical data

Opening and closing times t as a function of gripper finger mass moment of inertia J

HGW-10-A

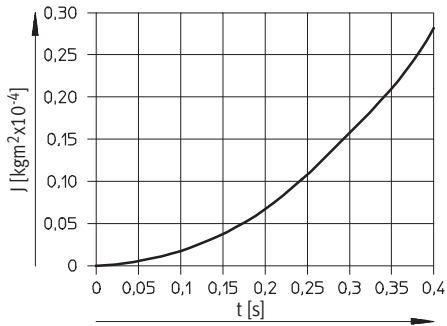

HGW-16-A

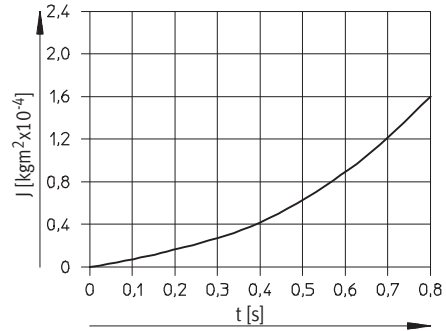

HGW-25-A

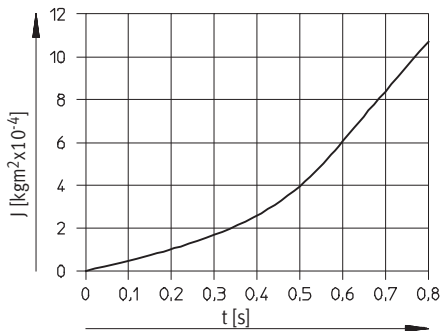

HGW-32-A

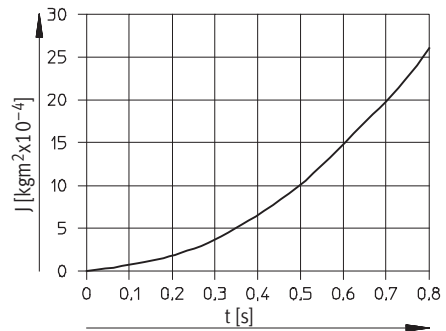

HGW-40-A

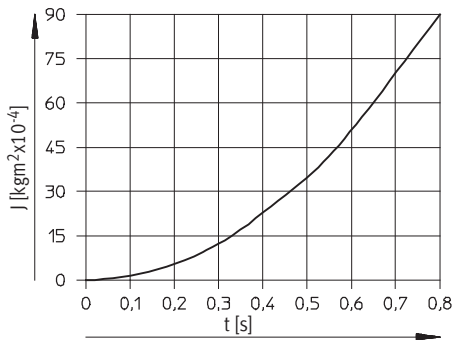

-  - Type discontinued
Available up until 2011

Angle grippers HGW

Technical data

FESTO

Gripping force F per gripper as a function of operating pressure and the lever arm r

Gripping forces

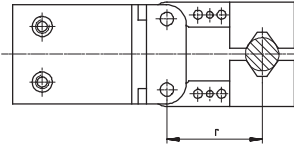

Gripping forces can be determined with the following diagrams for the various sizes in relation to operating

pressure and lever arm (distance from the zero co-ordinate line shown oppo-

site to the pressure point at which the external fingers grip the workpiece).

External gripping (closing)

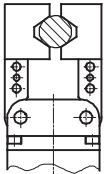

Internal gripping (opening)

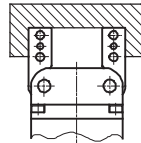

HGW-10-A

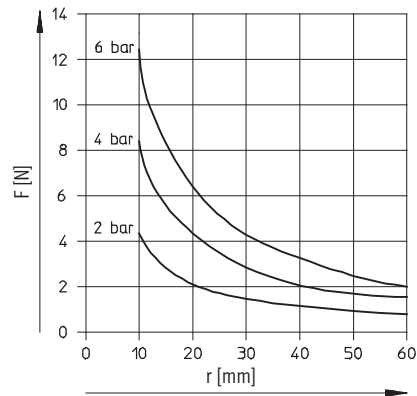
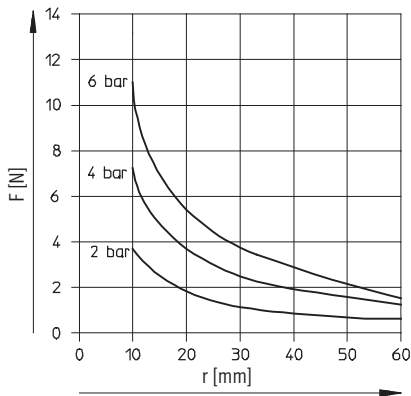

HGW-16-A

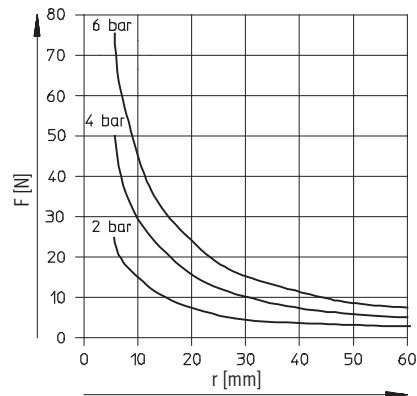
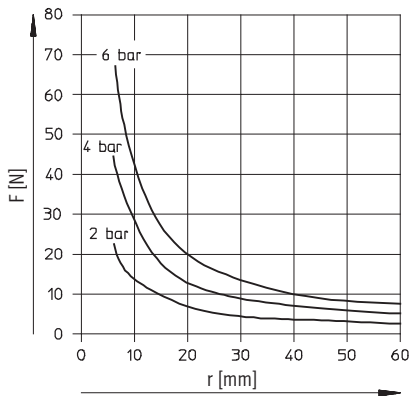

Angle grippers HGW

Technical data

Gripping force F per gripper as a function of operating pressure and the lever arm r

External gripping (closing)

Internal gripping (opening)

HGW-25-A

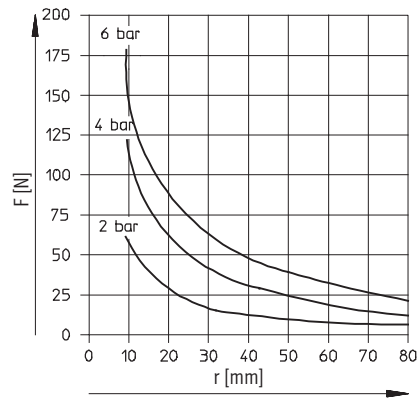
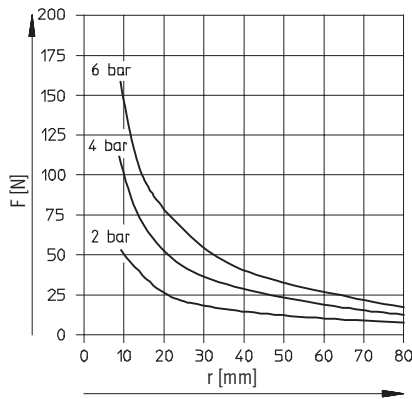

HGW-32A

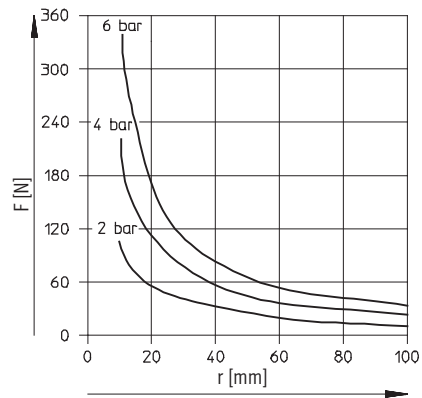
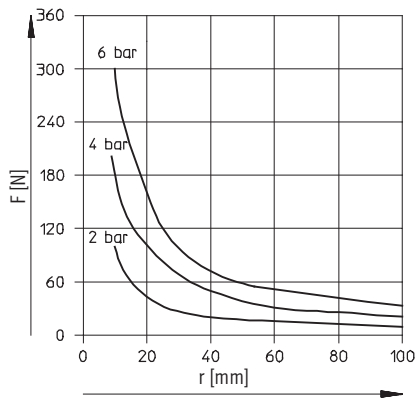

HGW-40A

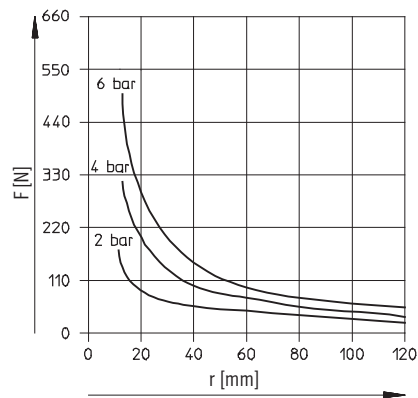
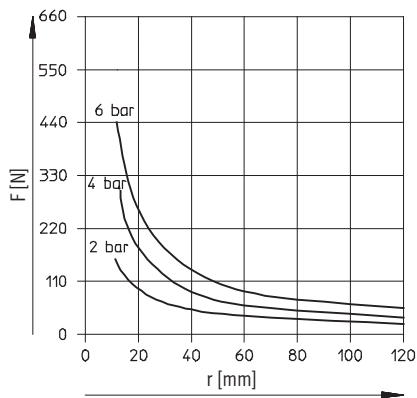

-  - Type discontinued
Available up until 2011

Angle grippers HGW

Technical data

FESTO

Dimensions

Download CAD data → www.festo.com

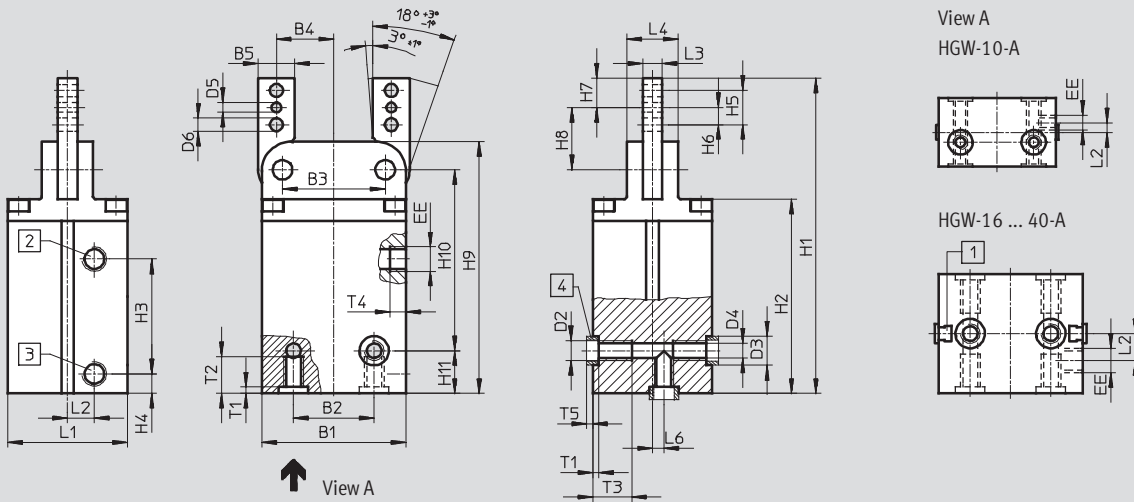

- 1 Sensor slot for proximity sensor SME/SMT-8 (not with HGW-10-A)
 2 Compressed air connection, closing
3 Compressed air connection, opening
4 Centring sleeves ZBH (2 included in scope of delivery)

Size	B1	B2	B3	B4	B5	D2	D3	D4	D5	D6	EE	H1	H2	H3	H4	H5
[mm]		±0.02	±0.02		-0.02/-0.05		∅ H8/h7	∅ +0.1	∅ H8	∅						
10	24	15	17	9.75	5.5	M3	5	2.5	2	2.2	M3	56.3	34.5	16	8.8	7
16	33.4	16	24	13	8	M3	5	2.5	2.5	3.2	M3	81	53.2	23	12.25	9
25	44	25	32	18	10	M4	7	3.3	3	3.2	M5	100	63.5	24.7	14.3	11
32	51	29	37	20.5	12	M6	9	5.1	3	4.3	G $\frac{1}{8}$	116	73	25	20	13
40	59	33	42	23.5	15	M8	12	6.4	4	5.3	G $\frac{1}{8}$	129	79.5	47	8	14

Size	H6	H7	H8	H9	H10	H11	L1	L2	L3	L4	L6	T1	T2	T3	T4	T5
[mm]			±0.05			-0.05			-0.02		±0.02	+0.1		+1	+0.5	
10	3.5	5.75	10.75	44.8	27.5	12.3	14	2	3	7	2	1.2	12.3	-	3.5	1.2
16	4.5	7.5	13.7	65.5	52.3	7.5	19	5.5	4	10	-	1.2	7	7	4.5	1.2
25	5.5	8.8	18.7	80.7	65	7.5	29.5	8.75	5	14	-	1.6	7	8	6.5	1.4
32	6.5	11	22	92.5	72	11	38	9.5	6	17	-	2.1	10	15	6.5	1.9
40	7	12	25.5	103	74	17.5	49	11	8	21	-	2.6	15	16	6.5	2.4

Ordering data

Size	Double-acting	
[mm]	Part No.	Type
10	174 818	HGW-10-A
16	161 833	HGW-16-A
25	161 834	HGW-25-A
32	161 835	HGW-32-A
40	161 836	HGW-40-A

Ordering data – Wearing parts kits



Size	Wearing parts kits	
[mm]	Part No.	Type
10	378 527	HGW-10-A
16	125 680	HGW-16-A
25	125 681	HGW-25-A
32	125 682	HGW-32-A
40	125 683	HGW-40-A

- 2 - Type discontinued
Available up until 2011

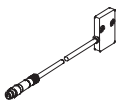

FESTO

Angle grippers HGW

Accessories

Ordering data					
Type	For size	Weight [g]	Part No.	Type	PU ¹⁾
Position sensor SMH-S1			Technical data → Internet: smh-s1		
	10	20	175 711	SMH-S1-HGW10	1
Evaluation unit SMH-AE1			Technical data → Internet: smh-ae		
	10	170	175 708	SMH-AE1-PS3-M12	1
			175 709	SMH-AE1-NS3-M12	
Centring sleeve ZBH			Technical data → Internet: zbh		
	10, 16	1	189 652	ZBH-5	10
	25		186 717	ZBH-7	
	32		150 927	ZBH-9	
	40		189 653	ZBH-12	

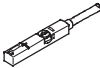
1) Packaging unit quantity

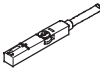

Ordering data – Proximity sensors for T-slot, magneto-resistive					
Type of mounting	Switch output	Electrical connection	Cable length [m]	Part No.	Type
N/O contact					
	Insertable in the slot from above, flush with cylinder profile	PNP	Cable, 3-wire	2.5	543 867 SMT-8M-PS-24V-K-2,5-OE
			Plug M8x1, 3-pin	0.3	543 866 SMT-8M-PS-24V-K-0,3-M8D
			Plug M12x1, 3-pin	0.3	543 869 SMT-8M-PS-24V-K-0,3-M12
	Insertable in the slot lengthwise, flush with the cylinder profile	NPN	Cable, 3-wire	2.5	543 870 SMT-8M-NS-24V-K-2,5-OE
			Plug M8x1, 3-pin	0.3	543 871 SMT-8M-NS-24V-K-0,3-M8D
			Plug M8x1, 3-pin	0.3	175 436 SMT-8-PS-K-LED-24-B
					175 484 SMT-8-PS-S-LED-24-B
N/C contact					
	Insertable in the slot from above, flush with cylinder profile	PNP	Cable, 3-wire	7.5	543 873 SMT-8M-PO-24V-K7,5-OE



- 1 - Type discontinued
Available up until 2011

Angle grippers HGW

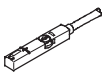
Accessories

FESTO

Ordering data – Proximity sensors for T-slot, magnetic reed					Technical data → Internet: sme	
	Type of mounting	Switch output	Electrical connection	Cable length [m]	Part No.	Type
N/O contact						
	Insertable in the slot from above, flush with cylinder profile	Contacting	Cable, 3-wire	2.5	543 862	SME-8M-DS-24V-K-2,5-OE
				5.0	543 863	SME-8M-DS-24V-K-5,0-OE
			Plug M8x1, 3-pin	2.5	543 872	SME-8M-ZS-24V-K-2,5-OE
				0.3	543 861	SME-8M-DS-24V-K-0,3-M8D
	Insertable in the slot lengthwise, flush with the cylinder profile	Contacting	Cable, 3-wire	2.5	150 855	SME-8-K-LED-24
			Plug M8x1, 3-pin	0.3	150 857	SME-8-S-LED-24
N/C contact						
	Insertable in the slot lengthwise, flush with the cylinder profile	Contacting	Cable, 3-wire	7.5	160 251	SME-8-O-K-LED-24

Ordering data – Connecting cables				Technical data → Internet: nebu	
	Electrical connection, left	Electrical connection, right	Cable length [m]	Part No.	Type
	Straight socket, M8x1, 3-pin	Cable, open end, 3-wire	2.5	541 333	NEBU-M8G3-K-2.5-LE3
			5	541 334	NEBU-M8G3-K-5-LE3
	Straight socket, M12x1, 5-pin	Cable, open end, 3-wire	2.5	541 363	NEBU-M12G5-K-2.5-LE3
			5	541 364	NEBU-M12G5-K-5-LE3
	Angled socket, M8x1, 3-pin	Cable, open end, 3-wire	2.5	541 338	NEBU-M8W3-K-2.5-LE3
			5	541 341	NEBU-M8W3-K-5-LE3
	Angled socket, M12x1, 5-pin	Cable, open end, 3-wire	2.5	541 367	NEBU-M12W5-K-2.5-LE3
			5	541 370	NEBU-M12W5-K-5-LE3