

Parallel grippers HGPT, robust



Parallel grippers HGPT, robust

Key features



At a glance

The force generated by the linear motion is translated into the gripper jaw movement via a wedge mechanism with guided motion sequence. This also guarantees synchronous movement of the gripper jaw. The virtually backlash-free slideway is realised using ground-in gripper jaws.

Flexible range of applications

- Double-acting gripper
- Compression spring for supplementary or retaining gripping forces
- For use as a single-acting gripper with only one compressed air connection
- Suitable for external and internal gripping

Gripper closed

Gripper open

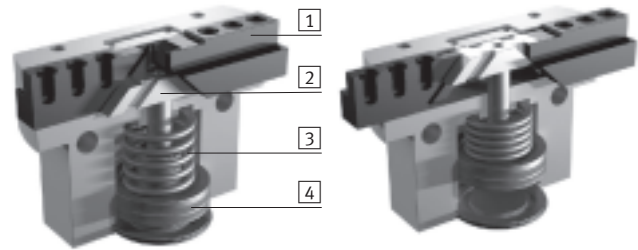

- 1 Gripper jaw
- 2 Wedge with restricted guidance
- 3 Spring
- 4 Piston with magnet

Note

Sizing software
Gripper selection
→ www.festo.com

Sealing air connection

Compressed air flows past the gripper jaw when sealing air (max. 0.5 bar) is connected.

This prevents, for example, particles and soluble cutting oil from entering the gripper jaw guides.

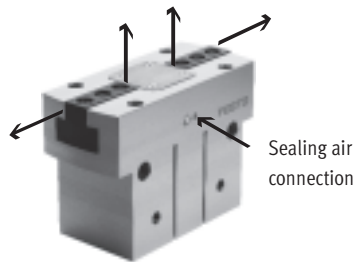

Sealing air connection

Versatile compressed air connections

Direct from the front

Via adapter plate from underneath

Mounting options

Direct mounting from above

from underneath and from the side

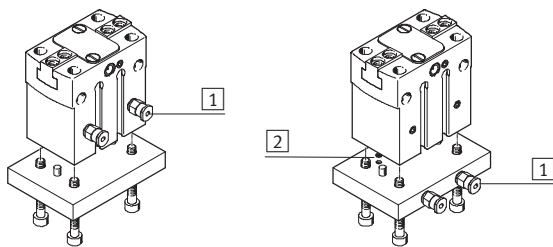

- 1 Compressed air connections
- 2 O-rings

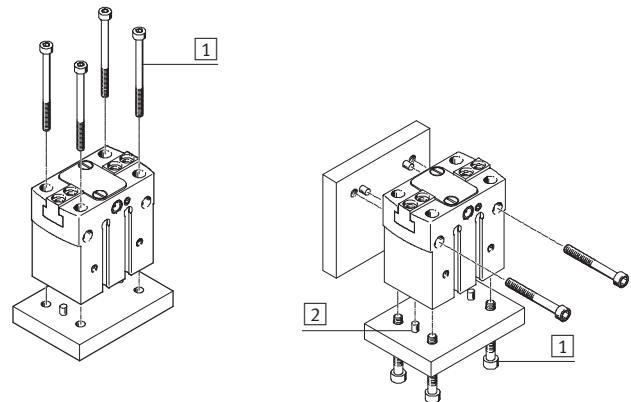

- 1 Mounting screws
- 2 Centring pins

Note

These grippers are not designed for the following application examples or only under limited conditions:

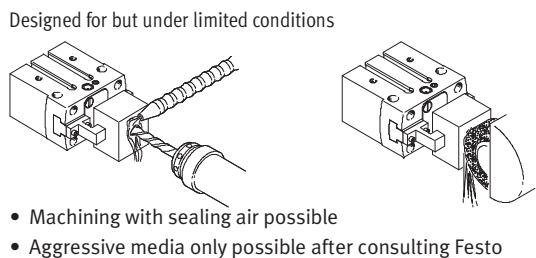
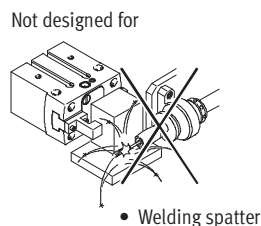

Parallel grippers HGPT, robust

Peripherals overview and type codes

Peripherals overview

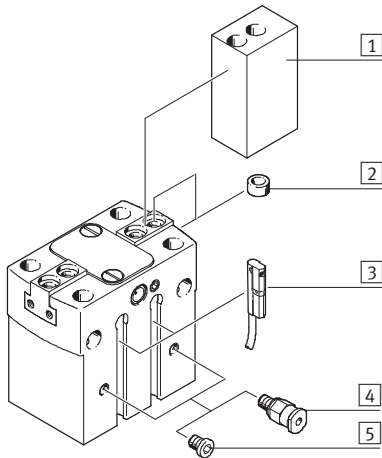

System product for handling and assembly technology

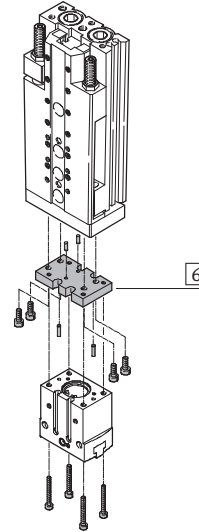

Accessories			
Type		Brief description	→ Page/Internet
1	Unmachined gripper finger BUB-HGPT	Unmachined part specially matched to the gripper jaws for custom building of gripper fingers	14
2	Centring sleeve ZBH	For centring when attaching gripper fingers	15
3	Proximity sensor SME/SMT-10	For sensing the piston position	15
4	Push-in fitting QS	For connecting compressed air tubing with standard external diameters	quick star
5	Blanking plug B	For sealing compressed air connections when using air connections at the front	15
6	-	Drive/gripper connections	adapter kit

Type codes

		HGPT	-	16	-	A	-	G1
Type								
HGPT	Parallel gripper							
Size								
Position sensing								
A	For proximity sensing							
Gripping force retention								
G1	Opening							
G2	Closing							

Parallel grippers HGPT, robust

Technical data

FESTO

Function
Double-acting
HGPT-...-A

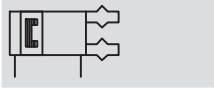

-  - Size
16 ... 63 mm

-  - Stroke
6 ... 32 mm



Single-acting or
with gripping force retention ...
... opening HGPT-...-G1



... closing HGPT-...-G2



General technical data							
Size	16	20	25	35	40	50	63
Design	Wedge mechanism Guided motion sequence						
Mode of operation	Double-acting						
Gripper function	Parallel						
Number of gripper jaws	2						
Max. weight force per external gripper finger ¹⁾ [N]	0.5	1	1.5	2	2.5	3	4
Stroke per gripper jaw [mm]	3	4	6	8	10	12	16
Pneumatic connection	M3	M3	M5	M5	M5	G $\frac{1}{8}$	G $\frac{1}{8}$
Pneumatic connection Sealing air	M3	M3	M5	M5	M5	M5	M5
Repetition accuracy ²⁾ [mm]	< 0.03	< 0.04	< 0.05				
Max. interchangeability [mm]	0.2						
Max. gripper jaw backlash ³⁾ [mm]	0.02						
Max. gripper jaw angular backlash [°]	0.1						
Max. operating frequency [Hz]	3				2		
Rotational symmetry [mm]	< \varnothing 0.2						
Position sensing	For proximity sensing						
Type of mounting	Via through-hole and dowel pin Via female thread and dowel pin						
Fitting position	Any						

1) Valid for unthrottled operation

2) End-position drift under constant conditions of use with 100 consecutive strokes in the direction of movement of the gripper jaws

3) In the direction of the gripper jaw movement

-  - Note: This product conforms to ISO 1179-1 and to ISO 228-1

Operating and environmental conditions			
Min. operating pressure	HGPT-...-A	[bar]	3
	HGPT-...-G...	[bar]	5
Max. operating pressure		[bar]	8
Operating medium	Filtered compressed air, lubricated or unlubricated		
Ambient temperature ¹⁾		[°C]	+5 ... +60
Corrosion resistance class CRC ²⁾	2		

1) Note operating range of proximity sensors

2) Corrosion resistance class 2 according to Festo standard 940 070

Components requiring moderate corrosion resistance. Externally visible parts with primarily decorative surface requirements which are in direct contact with a normal industrial environment or media such as coolants or lubricating agents

Parallel grippers HGPT, robust

Technical data

FESTO

Weight [g]							
Size	16	20	25	35	40	50	63
HGPT-...-A	102	183	361	625	1209	1984	3633
HGPT-...-G1	104	186	371	645	1252	2102	3763
HGPT-...-G2	104	186	371	645	1252	2102	3763

Materials

Sectional view

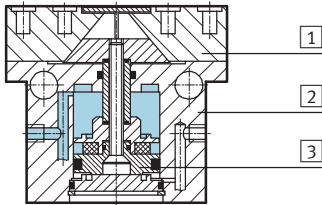

Parallel gripper		
1	Gripper jaw	Hardened steel
2	Housing	Aluminium, coated with CompCote
3	Piston	Gunmetal (red brass)
-	Seals	Nitrile rubber
-	Note on materials	Free of copper, PTFE and silicone Conforms to RoHS

Gripping force [N] at 6 bar

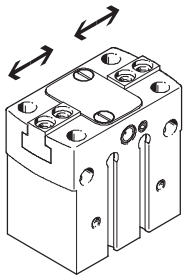

Size	16	20	25	35	40	50	63
Gripping force per gripper jaw							
Opening	42	75	110	250	300	480	825
Closing	36	70	100	230	270	440	770
Total gripping force							
Opening	84	150	220	500	600	960	1650
Closing	72	140	200	460	540	880	1540

Characteristic load values at the gripper jaws

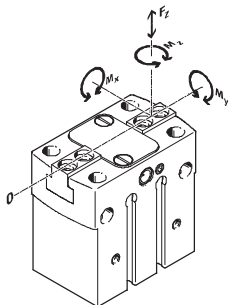

The indicated permissible forces and torques refer to a single gripper jaw. The indicated values include the lever arm, additional applied loads caused by the workpiece or external gripper

fingers, as well as forces which occur during movement. The zero coordinate line (gripper finger guide) must be taken into consideration for the calculation of torques.

Size	16	20	25	35	40	50	63	
Max. permissible force F_z	[N]	200	300	500	900	1500	2500	4000
Max. permissible torque M_x	[Nm]	10	15	30	50	80	100	140
Max. permissible torque M_y	[Nm]	7	10	25	40	60	90	120
Max. permissible torque M_z	[Nm]	5	8	15	30	40	60	80

Parallel grippers HGPT, robust

Technical data

FESTO

Mass moment of inertia [$\text{kgm}^2 \times 10^{-4}$]

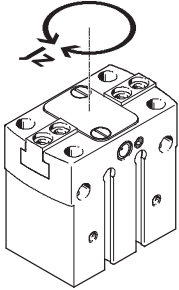

Mass moment of inertia [$\text{kgm}^2 \times 10^{-4}$] for parallel grippers in relation to the central axis with no load.

Size	16	20	25	35	40	50	63
HGPT-...-A	0.177	0.391	1.263	3.383	9.673	25.147	74.991
HGPT-...-G1	0.178	0.392	1.272	3.411	9.786	25.460	75.409
HGPT-...-G2	0.178	0.392	1.272	3.411	9.786	25.460	75.409

Opening and closing times [ms] at 6 bar

without external gripper fingers

with external gripper fingers

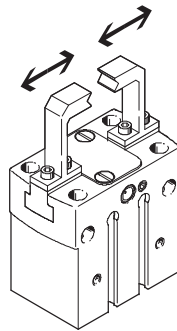
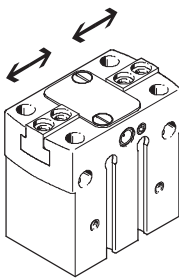

The indicated opening and closing times [ms] have been measured at room temperature and at 6 bar operating pressure with horizontally mounted gripper without external

gripper fingers. The grippers must be throttled for greater applied loads. Opening and closing times must then be adjusted correspondingly.

Size		16	20	25	35	40	50	63
without external gripper fingers								
HGPT-...-A	Opening	20	31	30	40	66	85	150
	Closing	21	31	33	40	61	76	135
HGPT-...-G1	Opening	10	26	30	39	57	65	123
	Closing	44	51	64	92	130	150	282
HGPT-...-G2	Opening	41	52	50	78	100	130	260
	Closing	21	31	30	39	61	70	130
with external gripper fingers as a function of weight force								
HGPT-...	1 N	100	-	-	-	-	-	-
	2 N	200	150	100	-	-	-	-
	3 N	300	250	200	150	100	-	-
	4 N	-	350	300	250	200	150	-
	5 N	-	-	400	350	300	250	200
	6 N	-	-	-	450	400	300	250
	8 N	-	-	-	-	-	450	400
	10 N	-	-	-	-	-	-	500

Parallel grippers HGPT, robust

Technical data

Gripping force F_{Grip} per gripper jaw as a function of operating pressure and lever arm x

Gripping forces related to operating pressure and lever arm can be determined for the various sizes using the following graphs.

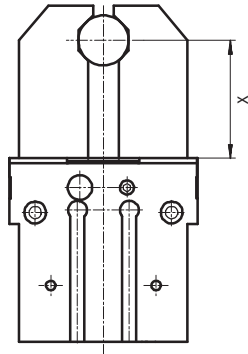

As external gripper: Closing operation

HGPT-16-A

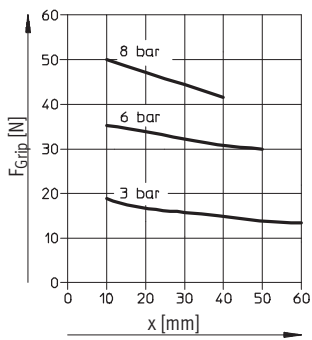

HGPT-20-A

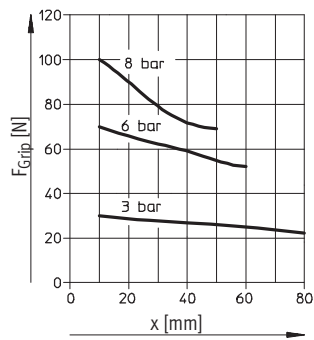

HGPT-25-A

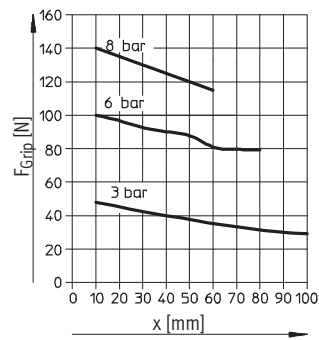

HGPT-35-A

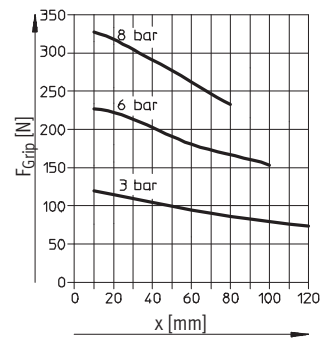

HGPT-40-A

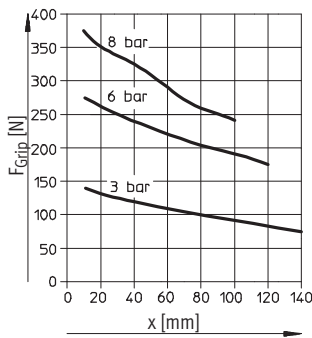

HGPT-50-A

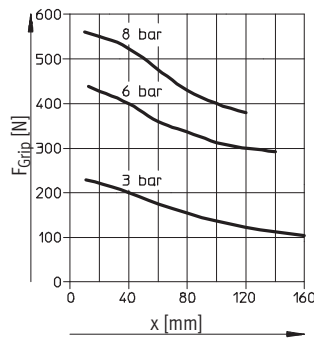

HGPT-63-A

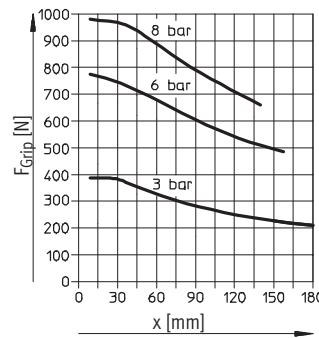

Parallel grippers HGPT, robust

Technical data

Gripping force F_{Grip} per gripper jaw as a function of operating pressure and lever arm x
As internal gripper: Opening operation

HGPT-16-A

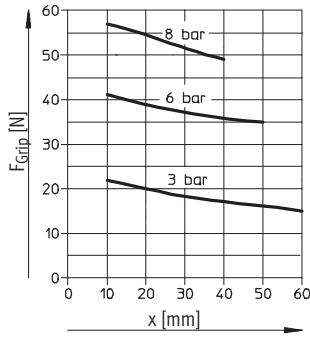

HGPT-20-A

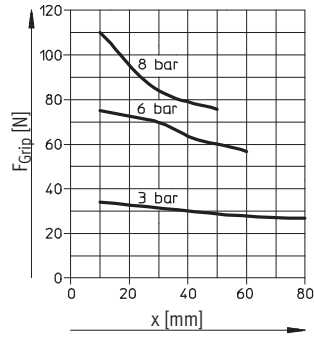

HGPT-25-A

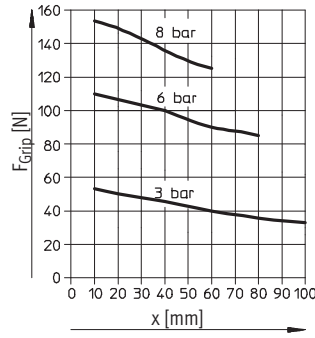

HGPT-35-A

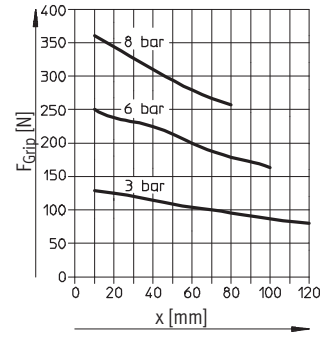

HGPT-40-A

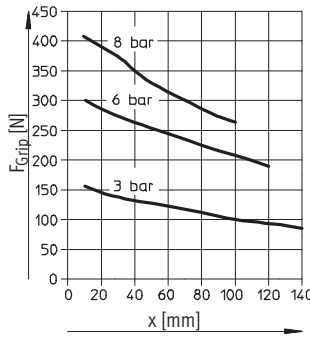

HGPT-50-A

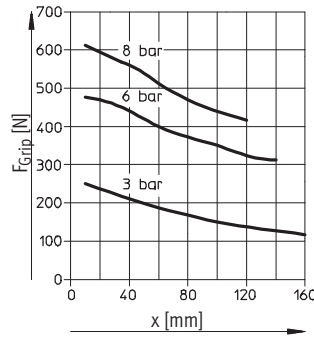

HGPT-63-A

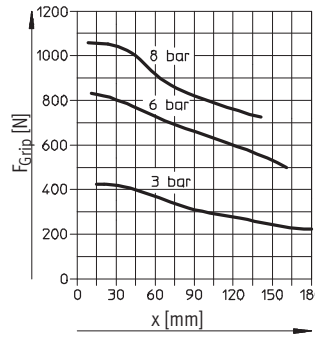

Parallel grippers HGPT, robust

Technical data

Spring force F_{Spring} as a function of gripper size and overall stroke l

Gripping force retention for HGPT-...-G...

Spring forces F_{Spring} as a function of gripper size and overall stroke l can be determined for the various gripper types (HGPT-...-G...) using the following graphs.

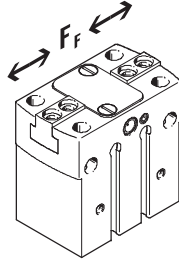

Size 16 ... 35

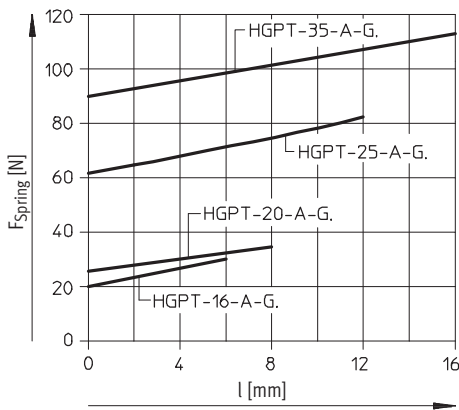

Size 40 ... 63

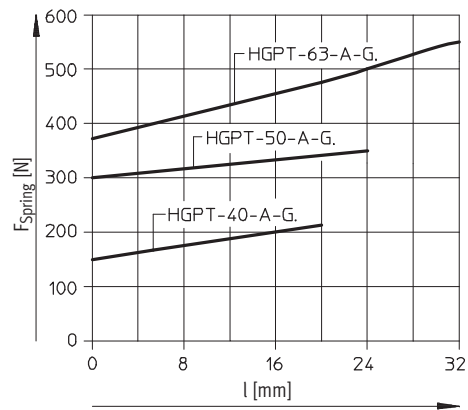

The lever arm x must be taken into consideration when determining the actual spring force F_{Stotal} . The formulae for calculating the spring force are provided in the table opposite.

Size	$F_{Stotal} =$
16	$-0.2 * x + 0.8 * F_{Spring}$
20	$-0.375 * x + 0.8 * F_{Spring}$
25	$-0.25 * x + 0.8 * F_{Spring}$
35	$-1 * x + 0.8 * F_{Spring}$
40	$-0.9 * x + 0.8 * F_{Spring}$
50	$-1.36 * x + 0.8 * F_{Spring}$
63	$-2.2 * x + 0.8 * F_{Spring}$

Determination of the actual gripping forces F_{Gr} for HGPT-...-G1 and HGPT-...-G2 depending on the application

Parallel grippers with integrated spring type HGPT-...-G1 (opening gripping force retention) and HGPT-...-G2 (closing gripping force retention) can be used as:

- single-acting grippers
- grippers with supplementary gripping force and
- grippers with gripping force retention depending on requirements.

In order to calculate available gripping forces F_{Gr} (per gripper jaw), the gripping force (F_{Grip}) and spring

force (F_{Stotal}) must be combined accordingly.

Application

Single-acting

Gripping with spring force:
 $F_{Gr} = F_{Stotal}$

Gripping with pressure force:
 $F_{Gr} = F_{Grip} - F_{Stotal}$

Supplementary gripping force

Gripping with pressure and spring force:
 $F_{Gr} = F_{Grip} + F_{Stotal}$

Gripping force retention

Gripping with spring force:
 $F_{Gr} = F_{Stotal}$

Parallel grippers HGPT, robust

Technical data

FESTO

Gripping force F_H per gripper jaw at 6 bar as a function of lever arm x and eccentricity y

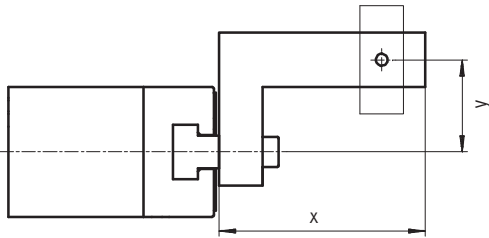

Gripping forces at 6 bar dependent upon eccentric application of force and the maximum permissible off-centre point of force application can be determined for the various sizes using the following graphs.

Calculation example

Given:

Lever arm $x = 40$ mm

Eccentricity $y = 45$ mm

To be found:

Gripping force at 6 bar

Procedure:

- Determine the intersection xy between lever arm x and eccentricity y in the graph for HGPT-25-A...
- Draw an arc (with centre at origin) through intersection xy
- Determine the intersection between the arc and the X axis
- Read the gripping force

Result:

Gripping force = approx. 83 N

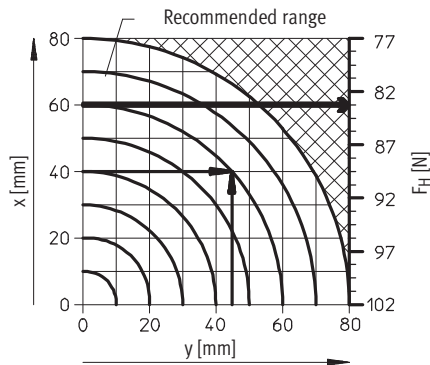

As external gripper: Closing operation

HGPT-16-A

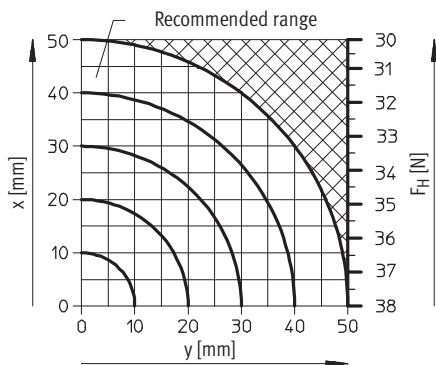

HGPT-20-A

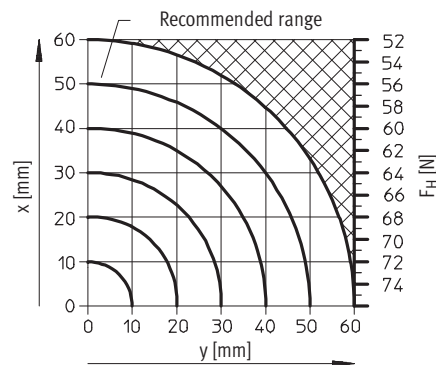

HGPT-25-A

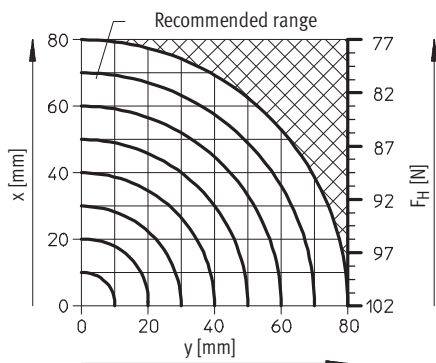

HGPT-35-A

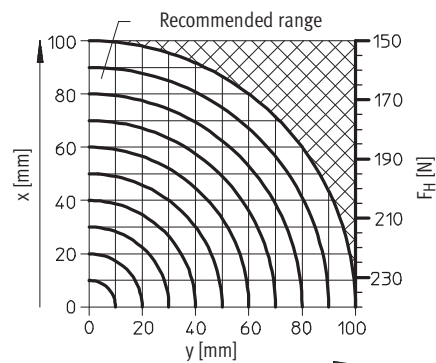

Parallel grippers HGPT, robust

Technical data

Gripping force F_H per gripper jaw at 6 bar as a function of lever arm x and eccentricity y

HGPT-40-A

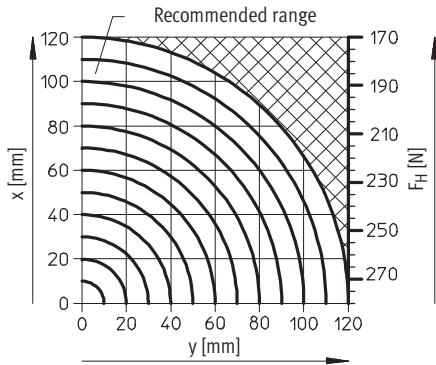

HGPT-50-A

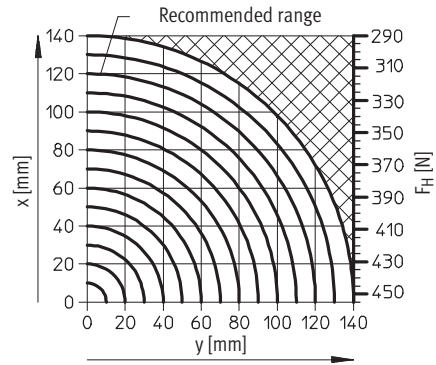

HGPT-63-A

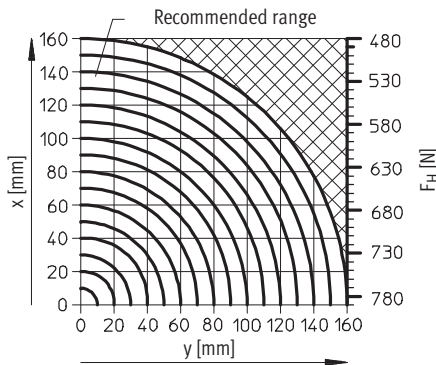

As internal gripper: Opening operation

HGPT-16-A

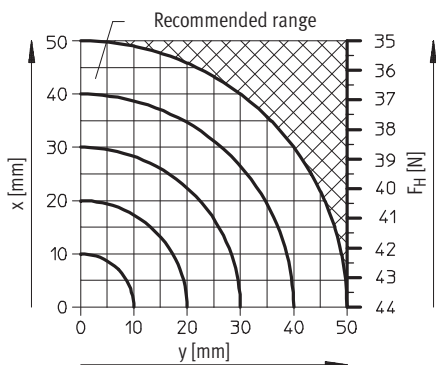

HGPT-20-A

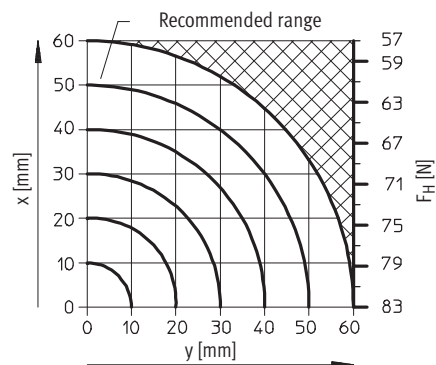

HGPT-25-A

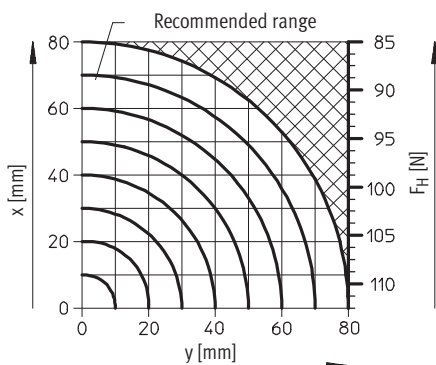

HGPT-35-A

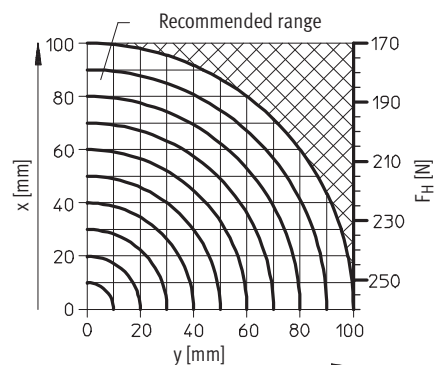

Parallel grippers HGPT, robust

Technical data

FESTO

Gripping force F_H per gripper jaw at 6 bar as a function of lever arm x and eccentricity y

HGPT-40-A

HGPT-50-A

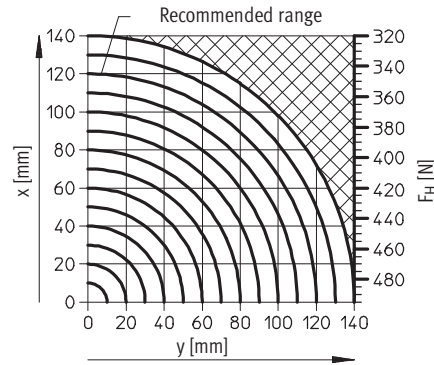
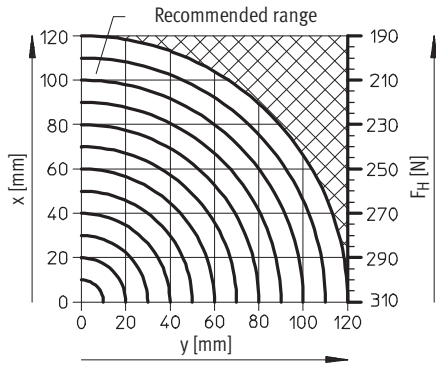

HGPT-63-A

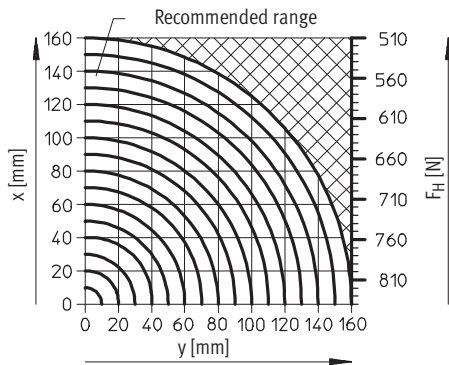

Dimensions

Download CAD data → www.festo.com

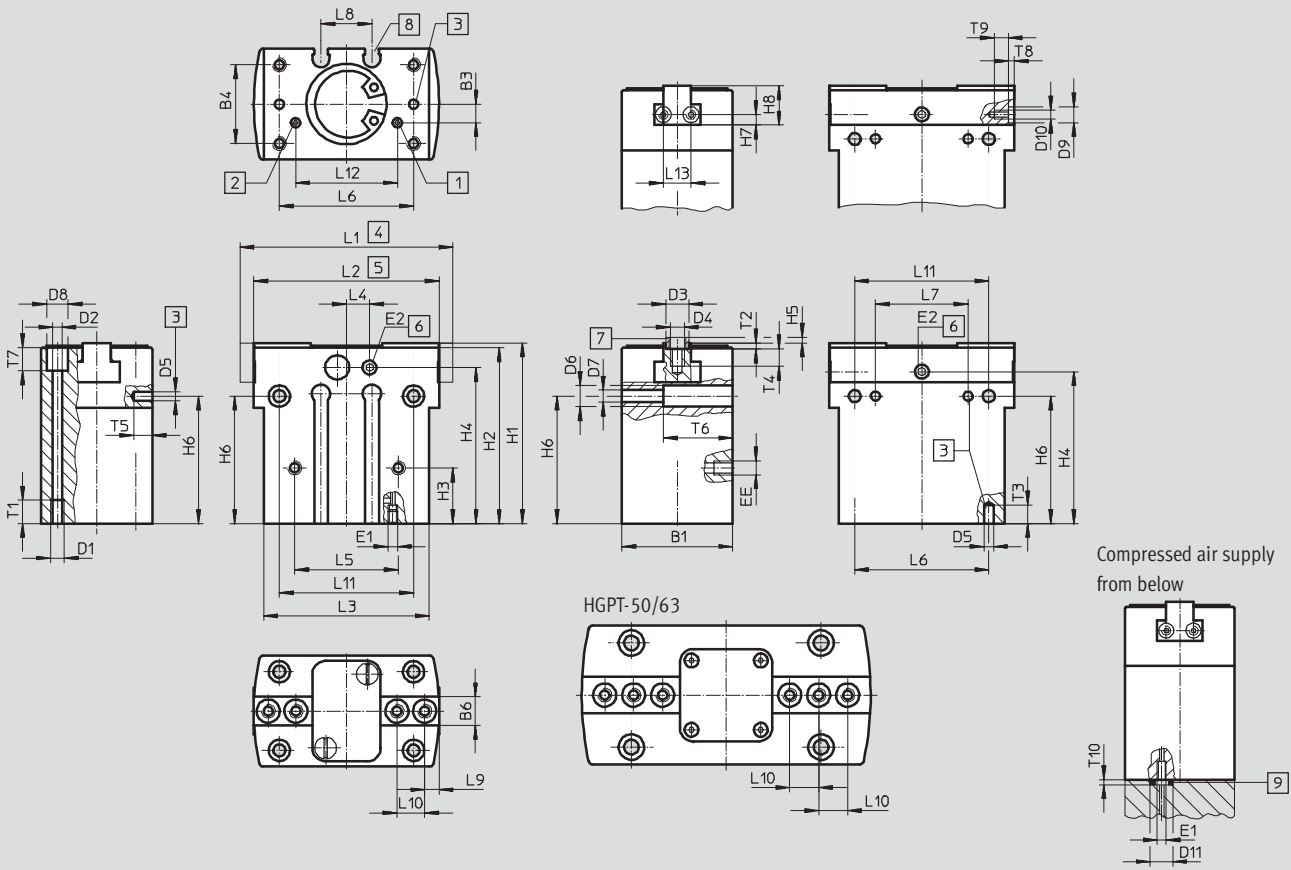

Parallel grippers HGPT, robust

Technical data

FESTO

- | | | | |
|---|--|--|--|
| <p>1 Compressed air connection opening, either on the side or bottom (bottom connection sealed on delivery)</p> <p>2 Compressed air connection closing, either on the side or bottom (bottom connection sealed on delivery)</p> | <p>3 Hole for dowel pin (not included in scope of delivery)</p> <p>4 Gripper jaw open</p> <p>5 Gripper jaw closed</p> <p>6 Sealing air connection (sealed on delivery)</p> | <p>7 Centring sleeves ZBH (4 included in scope of delivery)</p> <p>8 Slot for proximity sensor</p> | <p>9 O-ring for parallel grippers
 HGPT-16: \varnothing 2x1.5
 HGPT-20: \varnothing 3x1.5
 HGPT-25: \varnothing 3x1.5
 HGPT-35: \varnothing 4x1.5
 HGPT-40: \varnothing 5x1.5
 HGPT-50: \varnothing 5x1.5
 HGPT-63: \varnothing 5x1.5</p> |
|---|--|--|--|

Size [mm]	B1 ± 0.05	B3 ± 0.1	B4 ± 0.1	B6 -0.05 -0.1	D1	D2 \varnothing	D3 \varnothing H8/h7	D4	D5 \varnothing H7	D6 \varnothing	D7 \varnothing	D8 \varnothing
16	24	4	17	6	M3	2.6	5	M3	2	4.6 ^{+0.1}	2.6	4.6 ^{+0.1}
20	28	7	22	6.5	M4	3.2	5	M3	3	6 ^{+0.2}	3.2	6 ^{+0.2}
25	36	10	27	10	M5	4.2	7	M4	4	8 ^{+0.3}	4.2	8 ^{+0.3}
35	42	9	32	12	M5	4.2	9	M6	4	10 ^{+0.3}	5.3	8 ^{+0.3}
40	50	13	38	14	M6	5.1	9	M6	5	11 ^{+0.3}	6.4	9 ^{+0.3}
50	60	14	45	15.5	M8	6.4	9	M6	6	13.5 ^{+0.3}	8.4	11 ^{+0.3}
63	72	12	56	20	M8	6.4	12	M8	6	13.5 ^{+0.3}	8.4	11 ^{+0.3}

Size [mm]	D9 \varnothing H8	D10	D11 \varnothing	EE	E1	E2	H1 ± 0.05	H2 ± 0.05	H3 ± 0.1	H4	H5 -0.3	H6 $\pm 0.02^{1)}$ $\pm 0.1^{2)}$
16	-	M2	5	M3	M2	M3	39	38	12	33.7	1.2	27.5
20	5	M3	6	M3	M3	M3	46	45	15	37	1.2	24
25	5	M3	6	M5	M3	M5	57	56	20	46	1.4	34
35	7	M5	7	M5	M4	M5	67	66	28	53	1.9	38
40	7	M5	8	M5	M5	M5	83	82	36	68	1.9	53
50	7	M5	8	G $\frac{1}{8}$	M5	M5	97	96	30	78	1.9	61
63	7	M5	8	G $\frac{1}{8}$	M5	M5	117	116	26	92	2.4	67

Size [mm]	H7 $\pm 0.02^{1)}$ $\pm 0.1^{2)}$	H8 -0.02	L1 ± 0.5	L2 ± 0.5	L3 ± 0.1	L4	L5 ± 0.1	L6 $\pm 0.02^{1)}$ $\pm 0.1^{2)}$	L7 ± 0.02	L8 +0.1	L9 $\pm 0.02^{1)}$ $\pm 0.1^{2)}$	L10 $\pm 0.02^{1)}$ $\pm 0.1^{2)}$
16	2.25	8.5	46	40	35.8	3.8	22.4	29	20	11	3	6
20	3	12	58	50	44	-	28	35	24	18	4	8
25	4.5	16	76	64	52	-	28	42	20	17	5	12
35	5.5	19	96	80	64	-	40	52	40	24	6	15
40	5.5	22	120	100	80	-	48	66	50	32	10	18
50	7.5	25.5	149	125	100	-	56	82	60	32	10	12.5
63	9	32	192	160	125	-	74	100	76	34	10	18

Size [mm]	L11 ± 0.1	L12 ± 0.1	L13 $\pm 0.02^{1)}$ $\pm 0.1^{2)}$	T1 min.	T2 +0.1	T3 min.	T4 min.	T5 min.	T6	T7 +0.2	T8 +0.1	T9	T10
16	29	22	6	5	1.3	4	5	4	15	24	-	3	1.2
20	35	24	6	6	1.3	4	5	4	19	11	1.3	6	1.2
25	42	28	6	10	1.6	4	5	4	24	16	1.3	6	1.2
35	52	40	13	10	2.1	6	10	4	27	19	1.6	9	1.2
40	66	44	13	12	2.1	6	10	6	33	20	1.6	9	1.2
50	82	56	13	12	2.1	8	10	8	43	23	1.6	9	1.2
63	100	70	13	12	2.6	10	12	10	55	35	1.6	9	1.2

1) For centring

2) For through-and threaded hole

- | - Note: This product conforms to ISO 1179-1 and to ISO 228-1

Parallel grippers HGPT, robust

Technical data and accessories

FESTO

Ordering data						
Size [mm]	Double-acting without compression spring		Single-acting or with gripping force retention			
	Part No.	Type	opening		closing	
	Part No.	Type	Part No.	Type	Part No.	Type
16	535 858	HGPT-16-A	535 859	HGPT-16-A-G1	535 860	HGPT-16-A-G2
20	535 861	HGPT-20-A	535 862	HGPT-20-A-G1	535 863	HGPT-20-A-G2
25	535 864	HGPT-25-A	535 865	HGPT-25-A-G1	535 866	HGPT-25-A-G2
35	535 867	HGPT-35-A	535 868	HGPT-35-A-G1	535 869	HGPT-35-A-G2
40	535 870	HGPT-40-A	535 871	HGPT-40-A-G1	535 872	HGPT-40-A-G2
50	535 873	HGPT-50-A	535 874	HGPT-50-A-G1	535 875	HGPT-50-A-G2
63	535 876	HGPT-63-A	535 877	HGPT-63-A-G1	535 878	HGPT-63-A-G2

Accessories

Unmachined gripper finger

BUB-HGPT

(Scope of delivery: 2 pcs.)

Material:
Aluminium

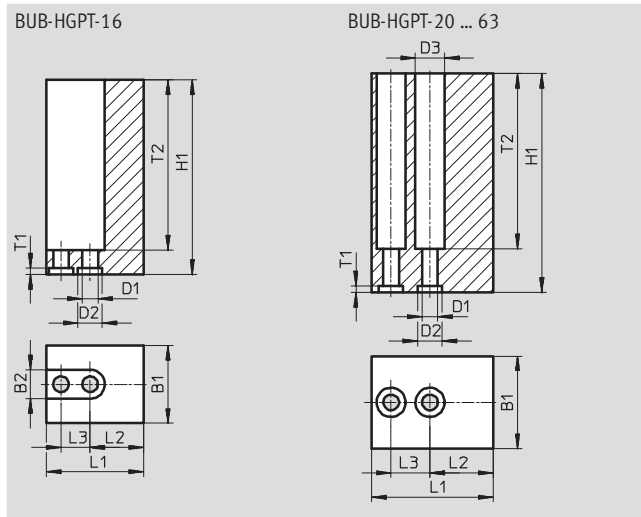

Dimensions and ordering data							
For size	B1	B2	D1	D2	D3	H1	L1
[mm]	±0.05	+0.22	∅ H13	∅ H8	∅ +0.22	±0.05	±0.05
16	16	6	3.2	5	-	40	20
20	19	-	3.2	5	6	45	25
25	24	-	4.3	7	8	60	32
35	28	-	6.4	9	11	70	40
40	34	-	6.4	9	11	75	50
50	40	-	6.4	9	11	100	62.5
63	50	-	8.4	12	13.5	120	80



For size	L2	L3	T1	T2	Weight per unmachined gripper finger [g]	Part No.	Type
[mm]	±0.02 ¹⁾ ±0.1 ²⁾	±0.01 ¹⁾ ±0.1 ¹⁾	+0.1				
16	11	6	1.3	35	28	537 198	BUB-HGPT-16
20	13	8	1.3	36	53	537 199	BUB-HGPT-20
25	15	12	1.6	51	112	537 200	BUB-HGPT-25
35	19	15	2.1	61	182	537 201	BUB-HGPT-35
40	22	18	2.1	71	312	537 202	BUB-HGPT-40
50	27.5	25	2.1	91	638	537 203	BUB-HGPT-50
63	34	36	2.6	110	1 230	537 204	BUB-HGPT-63

1) For centring
2) For through-hole



Parallel grippers HGPT, robust



Accessories



FESTO

Ordering data						
	For size [mm]	Remarks	Weight [g]	Part No.	Type	PU ¹⁾
Centring sleeve ZBH			Technical data → Internet: zbh			
	16, 20	For centring unmachined gripper jaws/gripper fingers on the gripper jaws	1	189 652	ZBH-5	10
	25		1	186 717	ZBH-7	10
	35, 40, 50		1	150 927	ZBH-9	10
	63		1	189 653	ZBH-12	10
	20, 25	For lateral centring of gripper fingers on the gripper jaws	1	189 652	ZBH-5	10
	35, 40, 50, 63		1	186 717	ZBH-7	10
Blanking plug B			Technical data → Internet: b			
	16, 20	For sealing the compressed air connections	0.6	30 979	B-M3-S9	10
	25, 35, 40		1	174 308	B-M5-B	10
	50, 63		5	3 568	B-1/8	10

1) Packaging unit quantity

Ordering data – Proximity sensors for C-slot, magneto-resistive						Technical data → Internet: smt
	Type of mounting	Switch output	Electrical connection, connection direction	Cable length [m]	Part No.	Type
N/O contact						
	Insertable in the slot from above, flush with cylinder profile	PNP	Cable, 3-wire, in-line	2.5	525 915	SMT-10F-PS-24V-K2,5L-OE
			Plug M8x1, 3-pin, in-line	0.3	525 916	SMT-10F-PS-24V-K0,3L-M8D
			Cable, 3-wire, lateral	2.5	526 674	SMT-10F-PS-24V-K2,5Q-OE
			Plug M8x1, 3-pin, lateral	0.3	526 675	SMT-10F-PS-24V-K0,3Q-M8D
	Insertable in the slot lengthwise	PNP	Plug M8x1, 3-pin, in-line	0.3	173 220	SMT-10-PS-SL-LED-24
			Cable, 3-wire, in-line	2.5	173 218	SMT-10-PS-KL-LED-24

Ordering data – Proximity sensors for C-slot, magnetic reed						Technical data → Internet: sme
	Type of mounting	Switch output	Electrical connection, connection direction	Cable length [m]	Part No.	Type
N/O contact						
	Insertable in the slot from above, flush with cylinder profile	Contacting	Plug M8x1, 3-pin, in-line	0.3	525 914	SME-10F-DS-24V-K0,3L-M8D
			Cable, 3-wire, in-line	2.5	525 913	SME-10F-DS-24V-K2,5L-OE
			Plug M8x1, 3-pin, lateral	0.3	526 671	SME-10F-DS-24V-K0,3Q-M8D
			Cable, 3-wire, lateral	2.5	526 670	SME-10F-DS-24V-K2,5Q-OE
	Insertable in the slot lengthwise	Contacting	Plug M8x1, 3-pin, in-line	0.3	173 212	SME-10-SL-LED-24
			Cable, 3-wire, in-line	2.5	173 210	SME-10-KL-LED-24

Ordering data – Connecting cables					Technical data → Internet: nebu
	Electrical connection, left	Electrical connection, right	Cable length [m]	Part No.	Type
	Straight socket, M8x1, 3-pin	Cable, open end, 3-wire	2.5	541 333	NEBU-M8G3-K-2.5-LE3
			5	541 334	NEBU-M8G3-K-5-LE3
	Angled socket, M8x1, 3-pin	Cable, open end, 3-wire	2.5	541 338	NEBU-M8W3-K-2.5-LE3
			5	541 341	NEBU-M8W3-K-5-LE3