

Parallel grippers HGPM, micro

FESTO



Key features

At a glance

- Compact, handy designs
- With open or closed gripper jaws
- Versatile thanks to externally adaptable gripper fingers
- Wide range of options for mounting on drives
- With stroke compensation after installation
- Mounting options:
 - Clamping spigot
 - Flange mounting



Note

Engineering software

Gripper selection

→ www.festo.com

Variants

With stroke compensation

With clamping spigot

With flange mounting



Mounting options for external gripper fingers (customer-specific)

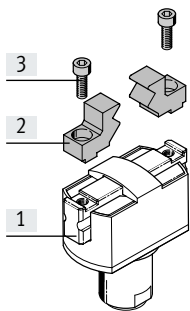

- [1] Parallel gripper
- [2] External gripper fingers
- [3] Retaining screws



Note

These grippers are not suitable for the following or similar applications:

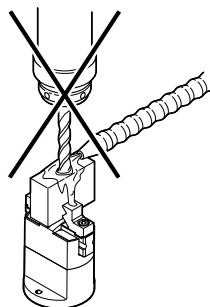

- Machining
- Aggressive media

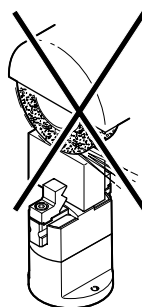

- Grinding dust

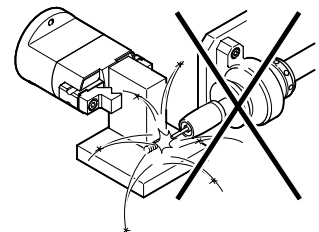

- Welding spatter

Key features

Mounting options

With through-holes

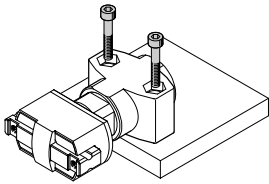

With through-holes, screws and retaining nuts

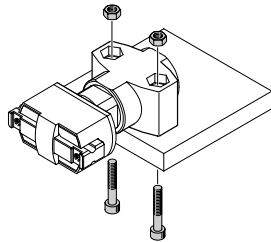

With flange mounting, screws and cylindrical pins

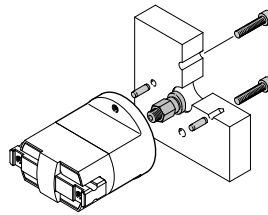

Integrated air supply

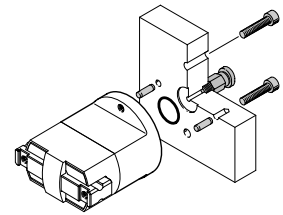

With threaded pin

Direct air supply

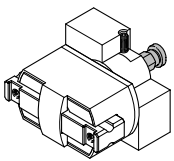

Integrated air supply

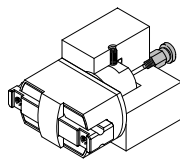

Type codes

001	Series	
HGPM	Parallel gripper, micro	
002	Size	
8	8	
12	12	

003	Gripper function	
E0	Single-acting, open	
EZ	Single-acting, closed	
004	Mounting method	
G6	Flange with stroke compensation	
G8	Clamping shaft	
G9	Flange	

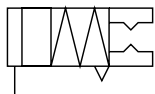

Data sheet

Single-acting
with open gripper jaws
HGPM-...-EO-G...

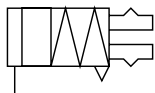

with closed gripper jaws
HGPM-...-EZ-G...



-  - Size
8 ... 12 mm
-  - Total stroke
4 ... 6 mm

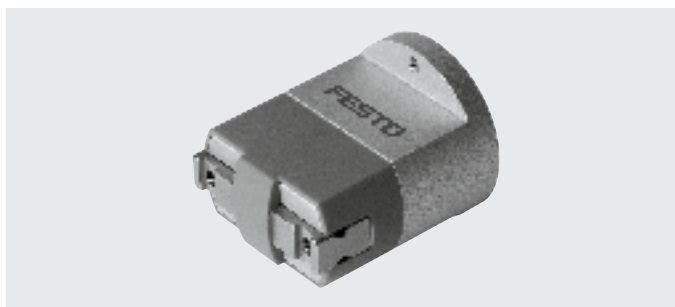

General technical data			
Size		8	12
Design		Sloping surface	
Mode of operation		Single-acting	
Gripper function		Parallel	
Number of gripper jaws		2	
Max. weight force per external gripper finger ¹⁾	[N]	0.05	0.15
Resetting force ²⁾			
Gripper jaws open	[N]	1.5	5
Gripper jaws closed	[N]	2	6.5
Stroke per gripper jaw	[mm]	2	3
Pneumatic connection		M3	
Repetition accuracy ^{3) 4)}	[mm]	< 0.05	
Max. interchangeability	[mm]	0.4	
Max. operating frequency	[Hz]	4	
Centring precision ⁴⁾	[mm]	< \varnothing 0.15 (only valid for HGPM-...-G8 and HGPM-...-G9)	
Position sensing		None	
Type of mounting			
HGPM-...-E...-G6		With through-hole	
HGPM-...-E...-G8		Clamped	
HGPM-...-E...-G9		With female thread and locating hole	

1) Applies to unthrottled operation

2) Spring resetting force between the jaws

3) Under constant exposure to operating conditions, end-position drift occurs in the direction of movement of the gripper jaws, at 100 consecutive strokes

4) The indicated values are only valid when gripping with compressed air, not with spring force

Data sheet

Operating and environmental conditions		
Min. operating pressure	[bar]	4
Max. operating pressure	[bar]	8
Operating medium		Compressed air to ISO 8573-1:2010 [7:4:4]
Note on the operating/pilot medium		Lubricated operation possible (in which case lubricated operation will always be required)
Ambient temperature	[°C]	+5 ... +60
Corrosion resistance class CRC ¹⁾		1

1) Corrosion resistance class CRC 1 to Festo standard FN 940070

Low corrosion stress. Dry indoor application or transport and storage protection. Also applies to parts behind covers, in the non-visible interior area, and parts which are covered in the application (e.g. drive trunnions).

Weight [g]		
Size	8	12
With stroke compensation	19	62
With clamping spigot	11	41
With flange mounting	18	62

Materials

Sectional view

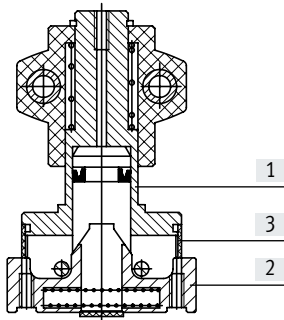

Parallel gripper		
[1]	Housing	Anodised aluminium
[2]	Gripper jaws	Stainless steel
[3]	Cover cap	Polyacetal
-	Note on materials	Free of copper and PTFE RoHS-compliant

Data sheet

Gripping force [N] at 6 bar

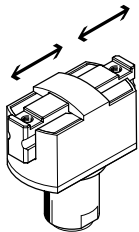

Size	8		12	
	HGPM-...EO-...	HGPM-...EZ-...	HGPM-...EO-...	HGPM-...EZ-...
Gripping force per gripper jaw				
Opening	-	8	-	17.5
Closing	8	-	13.5	-
Total gripping force				
Opening	-	16	-	35
Closing	16	-	27	-

Characteristic load values per gripper jaw

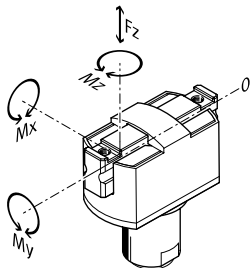

The indicated permissible forces and torques apply to a single gripper jaw. The indicated values include the lever arm, additional weight forces caused by the workpiece or external gripper fingers, as well as forces which occur during movement. The zero co-ordinate line (gripper jaw guide groove) must be taken into consideration for the calculation of torques.

Size	8		12	
	Max. permissible force F_z	[N]	10	
Max. permissible torque M_x	[Nm]	0.15		0.5
Max. permissible torque M_y	[Nm]	0.15		0.5
Max. permissible torque M_z	[Nm]	0.15		0.5

Data sheet

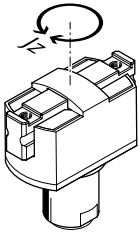
Mass moments of inertia [$\text{kgm}^2 \times 10^{-4}$]

Mass moment of inertia [$\text{kgm}^2 \times 10^{-4}$] for parallel grippers in relation to the central axis, without external gripper fingers, without load.

Size	8	12
With stroke compensation	0.00922	0.06674
With clamping spigot	0.00573	0.04252
With flange mounting	0.01712	0.07939

Opening and closing times [ms] at 6 bar

Without external gripper fingers

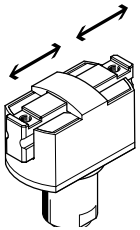

The indicated opening and closing times [ms] have been measured at room temperature and 6 bar operating pressure with a vertically mounted gripper and without additional gripper fingers. The moving mass is increased if external gripper fingers are attached. This means that kinetic energy is also increased, as this is determined by the mass of the gripper fingers and velocity. If permissible kinetic energy is exceeded, various parts of the gripper may be damaged. This occurs when the moving mass reaches the end-position and the cushioning is only able to partially convert the kinetic energy into potential energy and heat energy. It thus becomes apparent that the indicated max. permissible weight force of the external gripper fingers must be checked and maintained.

Size		8	12
HGPM-...EO-...	Opening	4.9	11
	Closing	2.3	3.7
HGPM-...EZ-...	Opening	1.9	3
	Closing	4.1	8.3

Gripper jaw backlash

Without external gripper fingers

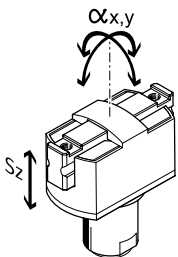

With parallel grippers, backlash occurs between the gripper jaws and the guide element due to the plain-bearing guide. The backlash values listed in the table have been calculated based on the traditional cumulative tolerance method and usually do not occur with mounted grippers.

Size		8	12
Gripper jaw backlash s_z	[mm]	< 0.03	
Gripper jaw angular backlash a_x, a_y	[°]	< 0.5	

Data sheet

Spring displacement forces [N]

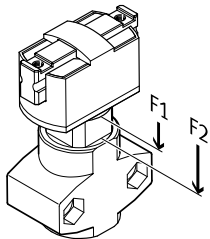

Theoretical actuating force due to stroke compensation for the design variant with stroke compensation.

Size	8	12
Spring displacement forces F_1	4	10
Spring displacement forces F_2	6	23

Gripping force F_H per gripper jaw as a function of operating pressure and lever arm x

External and internal gripping (closing and opening)

Gripping forces as a function of operating pressure and lever arm can be determined for the various sizes using the following graphs.

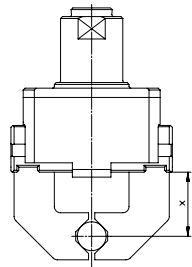

- EO = External gripping (closing)
- EZ = Internal gripping (opening)

HGPM-08-EO-...

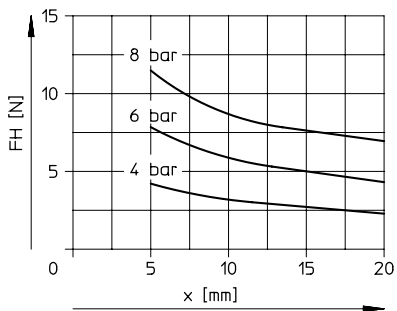

HGPM-08-EZ-...

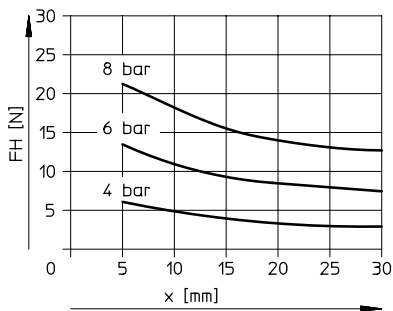

HGPM-12-EO-...

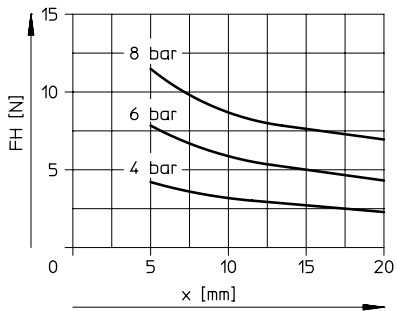

HGPM-12-EZ-...

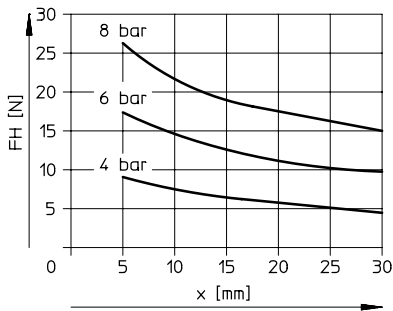

Data sheet

Gripping force F_H per gripper jaw at 6 bar as a function of lever arm x and eccentricity y

External and internal gripping (closing and opening)

Gripping forces at 6 bar dependent on eccentric application of force and the maximum permissible off-centre point of force application can be determined for the various sizes using the following graphs.

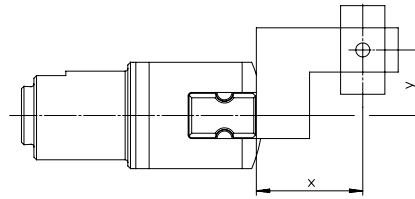

Calculation example

Assuming:

HGPM-12-EZ-...

Lever arm $x = 10$ mm

Eccentricity $y = 11$ mm

To be calculated:

Gripping force at 6 bar

Procedure:

- Determine the intersection xy between lever arm x and eccentricity y in the graph for HGPM-12-EZ
 - Draw an arc (with centre at origin) through the intersection xy
 - Determine the intersection between the arc and X-axis
 - Read the gripping force
- Result:
gripping force = approx. 15 N

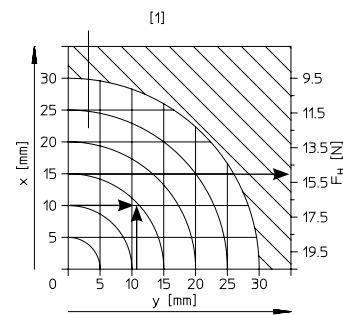

[1] Recommended range

HGPM-08-EO-...

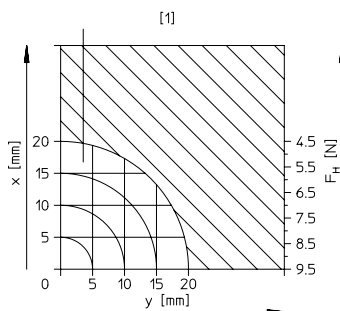

HGPM-08-EZ-...

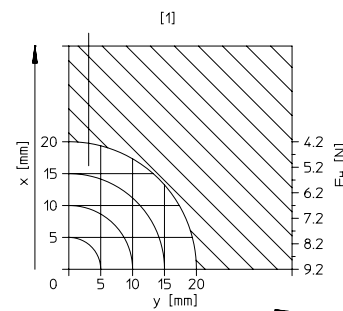

HGPM-12-EO-...

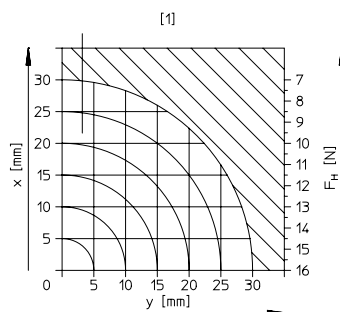

HGPM-12-EZ-...

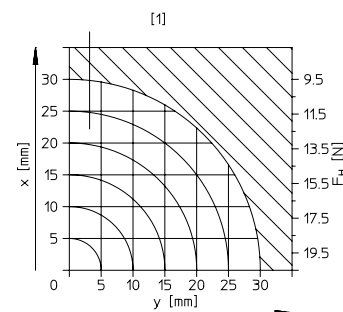

EO = External gripping (closing)

EZ = Internal gripping (opening)

[1] = Recommended range

Data sheet

Dimensions

Download CAD data → www.festo.com

With stroke compensation – HGPM-...-E...-G6

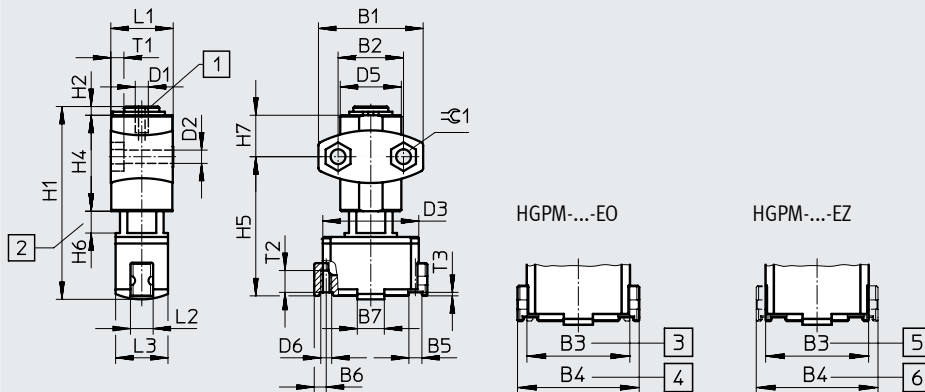

- [1] Supply port
- [2] Stroke compensation
- [3] Closed
- [4] Open (initial position)
- [5] Closed (initial position)
- [6] Open

With clamping spigot – HGPM-...-E...-G8

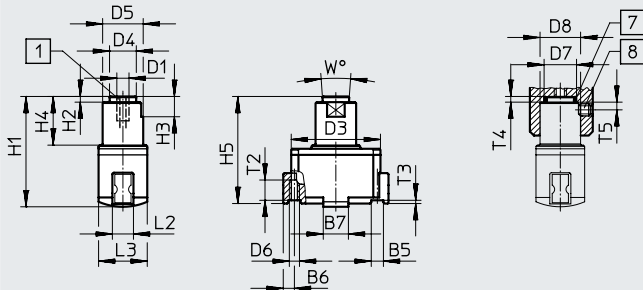

- [1] Supply port
- [7] O-ring:
HGPM-08: 6x1
HGPM-12: 10x1
(not included in the scope of delivery)
- [8] Threaded pin M3x3 DIN 913
(not included in the scope of delivery)

With flange mounting – HGPM-...-E...-G9

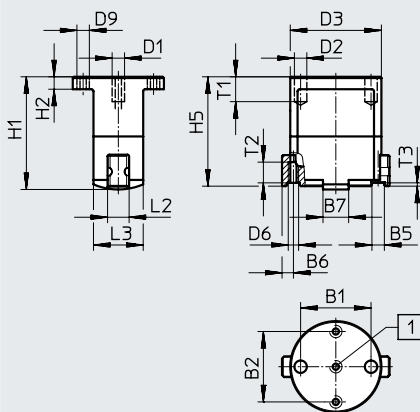

- [1] Supply port

Data sheet

Type	B1	B2	B3 ±0.3	B4 ±0.3	B5 +0.05/+0.02	B6 +0.19/-0.23	B7 ±0.1	D1	D2 ∅	D3 ∅
HGPM-08-EO-G6	24 ±0.1	15 ±0.25	22	26	3	2.75	6.2	M3	3.4 ±0.2	22
HGPM-08-EZ-G6										
HGPM-12-EO-G6	35 ±0.1	24 ±0.25	33	39	4	4	9	M3	4.5 ±0.2	33
HGPM-12-EZ-G6										
HGPM-08-EO-G8	–	–	22	26	3	2.75	6.2	M3	–	22
HGPM-08-EZ-G8										
HGPM-12-EO-G8	–	–	33	39	4	4	9	M3	–	33
HGPM-12-EZ-G8										
HGPM-08-EO-G9	17 ±0.02	17 ±0.1	22	26	3	2.75	6.2	M3	3 F8	22
HGPM-08-EZ-G9										
HGPM-12-EO-G9	27 ±0.02	27 ±0.1	33	39	4	4	9	M3	3 F8	33
HGPM-12-EZ-G9										

Type	D4 ∅ ±0.1	D5 ∅	D6	D7 ∅ +0.1	D8 ∅ +0.1	D9	H1 ±0.3	H2	H3	H4	H5
HGPM-08-EO-G6	–	15 ±0.5	M2.5	–	–	–	44.2	2 +0.1/-0.3	–	22 -0.3	32.4 +0.8/-0.65
HGPM-08-EZ-G6											
HGPM-12-EO-G6	–	22 ±0.5	M3	–	–	–	63	3 +0.2/-0.3	–	29 -0.3	46.65 +0.9/-0.7
HGPM-12-EZ-G6											
HGPM-08-EO-G8	6.6	10 h8	M2.5	8	10	–	27.2	1.4 -0.1	5	12 ±0.1	26.9 +0.2/-0.25
HGPM-08-EZ-G8											
HGPM-12-EO-G8	10.6	15 h8	M3	12	15	–	41	1.4 -0.1	7 ±0.1	18 ±0.1	40.15 +0.2/-0.25
HGPM-12-EZ-G8											
HGPM-08-EO-G9	–	–	M2.5	–	–	M3	27.2	3 ±0.2	–	–	26.9 +0.2/-0.25
HGPM-08-EZ-G9											
HGPM-12-EO-G9	–	–	M3	–	–	M3	41	5 ±0.2	–	–	40.15 +0.2/-0.25
HGPM-12-EZ-G9											

Type	H6 +0.7/-0.2	H7 ±0.3	L1 +0.1/-0.3	L2 -0.1	L3 ±0.1	T1	T2 ¹⁾	T3	W	⊕1
HGPM-08-EO-G6	0 ... 5	9.5	14.3	5	12	3 -0.2	4	0.8	–	5.7
HGPM-08-EZ-G6										
HGPM-12-EO-G6	0 ... 8	12.5	20.35	7	18	4 -0.2	6	1	–	7.5
HGPM-12-EZ-G6										
HGPM-08-EO-G8	–	–	–	5	12	–	4	0.8	8°	–
HGPM-08-EZ-G8										
HGPM-12-EO-G8	–	–	–	7	18	–	6	1	8°	–
HGPM-12-EZ-G8										
HGPM-08-EO-G9	–	–	–	5	12	min. 6	4	0.8	–	–
HGPM-08-EZ-G9										
HGPM-12-EO-G9	–	–	–	7	18	min. 6	6	1	–	–
HGPM-12-EZ-G9										

1) Do not exceed max. thread screw-in depth

Ordering data		Mounting variants					
Single-acting	Size [mm]	With stroke compensation		With clamping spigot		With flange mounting	
		Part no.	Type	Part no.	Type	Part no.	Type
Gripper jaws open	8	197559	HGPM-08-EO-G6	197560	HGPM-08-EO-G8	197561	HGPM-08-EO-G9
	12	197565	HGPM-12-EO-G6	197566	HGPM-12-EO-G8	197567	HGPM-12-EO-G9
Gripper jaws closed	8	197562	HGPM-08-EZ-G6	197563	HGPM-08-EZ-G8	197564	HGPM-08-EZ-G9
	12	197568	HGPM-12-EZ-G6	197569	HGPM-12-EZ-G8	197570	HGPM-12-EZ-G9