

Electric cylinders ESBF, with spindle drive

FESTO



Festo core product range
Covers 80% of your automation tasks

Worldwide:
Superb:
Easy:

Always in stock
Festo quality at an attractive price
Simplified procurement and warehousing

- ★ Generally ready for dispatch from the factory within 24 hours
In stock at 13 Service Centres worldwide
More than 2200 products
- ★ Generally ready for dispatch from the factory within 5 days
Assembled for you at 4 Service Centres worldwide
Up to 6×10^{12} variants per product family

Just look
for the
star!

Key features

At a glance

The electric cylinder ESBF is a mechanical linear drive unit with piston rod. The drive component consists of an electrically actuated spindle that converts the rotary motion of the motor into linear motion of the piston rod.

The electric cylinder is based on the ISO 15552 standard. The mechanical interfaces are largely compatible with the standards-based cylinder DSBF. The lead screws have lifetime lubrication and are thus maintenance-free.

Two spindle types to choose from:

Size 32 ... 50:

- Ball screw (BS)
- Lead screw (LS)

Size 63 ... 100:

- Ball screw (BS)

Options:

- High corrosion protection
- Degree of protection IP65
- Extended piston rod
- NSF-H1 lubricant for food & beverage industry applications
- Extensive accessories

Complete system consisting of electric cylinder, motor and motor mounting kit

Electric cylinder

→ Page 4



Motor

→ Page 27



Note

Specially adapted complete solutions are available for the electric cylinder ESBF and the motors.

Motor mounting kit

→ Page 27

Axial kit

Parallel kit

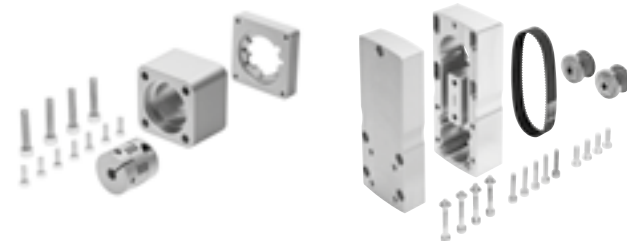

A range of complete kits is available for both parallel and axial motor mounting.

Bellows kit EADB for use in dusty environments

→ Page 43



The bellows protects the piston rod, the seal and the bearings from the effects of a wide range of media, which has a positive impact on the service life of these components.

The bellows kit is a leak-free system. To prevent unwanted media from being drawn in, the supply and exhaust air for the kit must be ducted via a pressure compensation hole in the connection part [1].

The kit protects the piston rod, seal and bearing against a wide variety of media, for example:

- Dust
- Chippings
- Oil
- Grease
- Petrol

Key features

Use in wet environments with protection to IP65

→ Page 43



The electric cylinder to IP65 fulfils the requirements of IEC 60529.

Air is exchanged between the interior of the cylinder and the environment via a pressure compensation hole [1]. This prevents negative pressure or excess pressure in the interior of the cylinder.

Connecting plastic tubing prevents unwanted media from being drawn in.

Sealing air can also be connected to the pressure compensation hole if required (e.g. during a cleaning process).

NSF-H1 lubricant for food & beverage applications (feature F1)

The electric cylinder is of limited suitability for the food industry.

Can only be selected in combination with the ball screw system (BS).

NSF-H1 lubricant for piston rod and threaded spindle as well as other parts.

Supplementary material information:

Additional information: www.festo.com/sp → Certificates

For manufacturing lithium-ion batteries

ESBF-...-F1A

Accessories

Recommended for production plants for manufacturing lithium-ion batteries.

Metals with more than 1% copper, zinc or nickel by mass are excluded from use.

Exceptions are nickel in steel, chemically nickel-plated surfaces, printed circuit boards, cables, electrical plug connectors and coils

Your Festo contact partner can provide information about which accessories are suitable for manufacturing lithium-ion batteries.

Peripherals overview

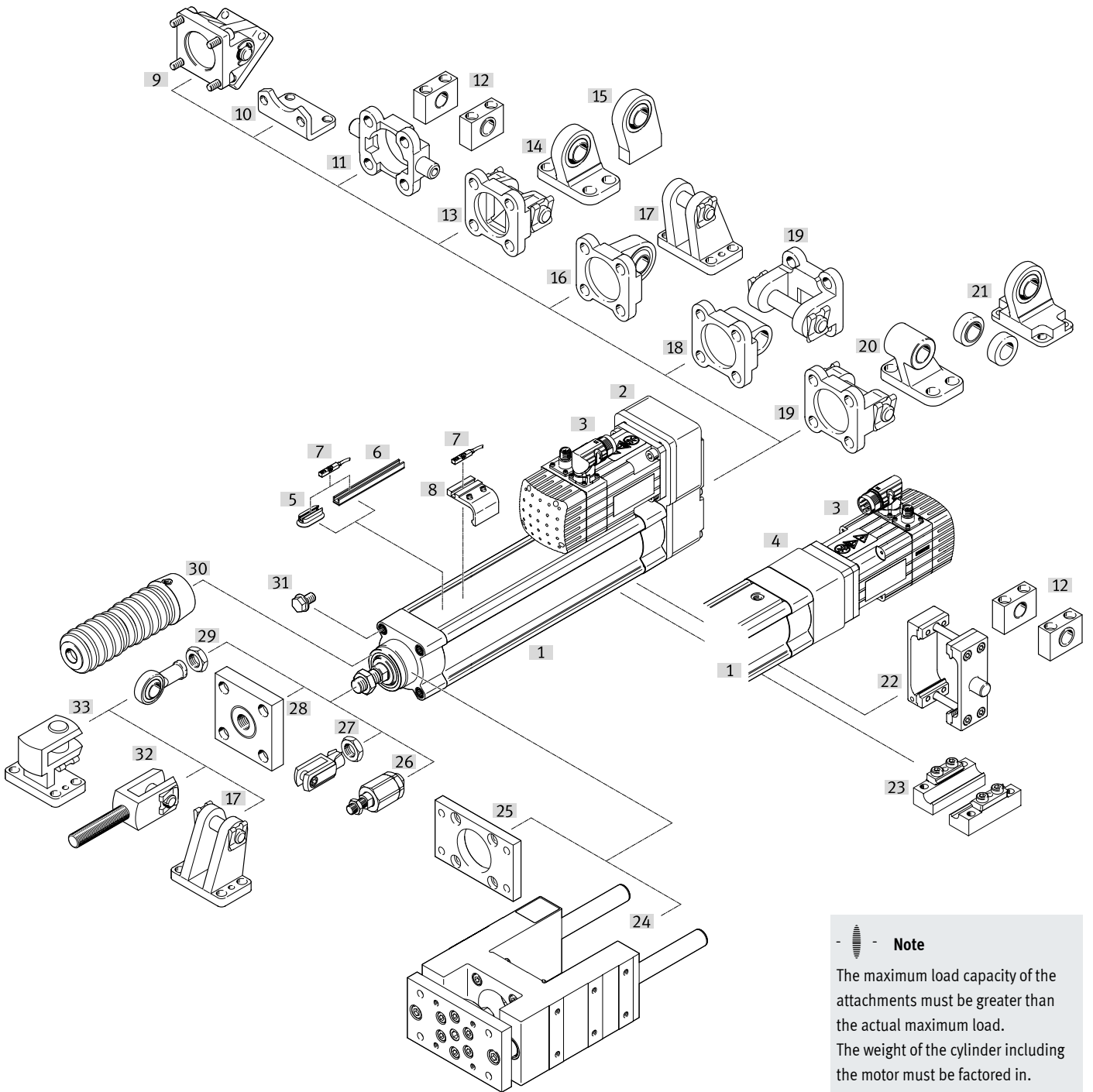

Note
 The maximum load capacity of the attachments must be greater than the actual maximum load.
 The weight of the cylinder including the motor must be factored in.

Mounting attachments and accessories		Description	Suitable for high forces ¹⁾	→ Page/Internet
[1]	Electric cylinder ESBF	Electric drive	■	6
[2]	Parallel kit EAMM-U	For parallel motor mounting	■	38
[3]	Motors EMMT, EMMS	Motors specially matched to the axis, with or without brake	■	27
[4]	Axial kit EAMM-A	For axial motor mounting	■	27

1) Indicates which accessories can be used within the entire force range. For restricted force ranges see the relevant accessory part, from page 50

Peripherals overview

Mounting attachments and accessories		Description	Suitable for high forces ¹⁾	→ Page/Internet
[5]	Mounting kit CRSMB	For proximity sensor with T-slot	■	64
[6]	Sensor rail SAMH	For proximity sensor with T-slot	■	64
[7]	Proximity sensors SMT/CRSMT-8	For position sensing	■	65
[8]	Mounting kit SMB-8-FENG	For proximity sensor with T-slot	■	64
[9]	Swivel flange DAMS	With parallel motor mounting, for spherical bearing	■	55
[10]	Foot mounting HNC/CRHNC	For mounting the cylinder. The foot mounting can only be secured at the rear on the parallel kit	–	50
[11]	Trunnion flange ZNCF/CRZNG	For spherical bearing	–	52
[12]	Trunnion support LNZG/CRLNZG	For cylinders with trunnion flange mounting	–	53
[13]	Swivel flange SNC	With parallel motor mounting	–	56
[14]	Clevis foot LSNG	With parallel motor mounting, with spherical bearing	–	61
[15]	Clevis foot LSNSG	With parallel motor mounting, weld-on, with spherical bearing	–	61
[16]	Swivel flange SNCS/CRSNCS/SNCS-...-R3	With parallel motor mounting	–	57
[17]	Clevis foot LBG/LBG-...-R3	With parallel motor mounting, for spherical bearing	–	61
[18]	Swivel flange SNCL	With parallel motor mounting	–	58
[19]	Swivel flange SNCB/SNCB-...-R3	With parallel motor mounting, for spherical bearing	–	59
[20]	Clevis foot LNG/CRLNG	With parallel motor mounting	–	61
[21]	Clevis foot LSN	With parallel motor mounting, for spherical bearing	–	61
[22]	Trunnion flange kit DAMT	For mounting anywhere along the cylinder profile barrel. Cannot be mounted in the vicinity of the motor with parallel motor mounting	–	60
[23]	Profile mounting EAHF-...-P	<ul style="list-style-type: none"> For mounting the electric cylinder via the profile Cannot be mounted in conjunction with the parallel kit EAMM-U (in the vicinity of the motor) in some combinations 	■	49
[24]	Guide unit EAGF	<ul style="list-style-type: none"> For protecting electric cylinders against rotation at high torque loads Cannot be used in combination with bellows kit EADB 	■	63
[25]	Flange mounting EAHH	<ul style="list-style-type: none"> On the bearing cap Cannot be used in combination with bellows kit EADB 	■	51
[26]	Self-aligning rod coupler FK/CRFK	For compensating radial and angular deviations	–	62
[27]	Rod clevis SG/CRSG	Permits a swivelling movement of the cylinder in one plane	■	62
[28]	Coupling piece KSZ	For compensating radial deviations	–	62
[29]	Rod eye SGS/CRSGS	With spherical bearing	■	62
[30]	Bellows kit EADB	<ul style="list-style-type: none"> Protects the cylinder (piston rod, seal and bearings) against a wide range of media and thus prevents premature wear The kit can only be used in combination with an extended piston rod (...E) 	■	43
[31]	Plug screw DAMD-PS	For covering unused mounting threads	■	65
[32]	Rod clevis SGA	For swivel mounting of the cylinder	■	62
[33]	Right angle clevis foot LQG	For rod eye SGS	–	61

1) Indicates which accessories can be used within the entire force range. For restricted force ranges see the relevant accessory part, from page 50.

Type codes



001		Series
ESBF		Electric cylinder, with spindle drive
002		Drive system
BS		Ball screw drive
LS		Lead screw
003		Size
32		32
40		40
50		50
63		63
80		80
100		100
004		Stroke [mm]
100		100
200		200
300		300
400		400
...		30 ... 1500
005		Spindle pitch
2.5P		2.5 mm
3P		3 mm
4P		4 mm
5P		5 mm
10P		10 mm
15P		15 mm
16P		16 mm
20P		20 mm
25P		25 mm
32P		32 mm
40P		40 mm

006		Piston rod thread type
		Male thread
F		Female thread
007		Degree of protection, electrical system
		Standard
S1		IP65
008		Corrosion protection
		Standard
R3		High corrosion protection
009		Special material properties
		None
F1A		Recommended for production facilities for the manufacture of lithium-ion batteries
010		Additional characteristics
		None
F1		Food-safe according to supplementary information on materials
011		Piston rod extension
...E		1 ... 500 mm

Data sheet

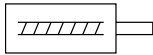
Function



-  Size
32 ... 100
-  Stroke length
30 ... 1500 mm
-  www.festo.com



General technical data		32	40	50	63	80	100
Size		32	40	50	63	80	100
Based on standard		ISO 15552					
Design		Electric cylinder with ball screw or lead screw			Electric cylinder with ball screw		
Piston rod thread		M10x1.25 M12x1.25 M16x1.5 M16x1.5 M20x1.5 M20x1.5					
Male thread		M10x1.25	M12x1.25	M16x1.5	M16x1.5	M20x1.5	M20x1.5
Female thread		M6	M8	M10	M10	M12	M12
Working stroke	[mm]	30 ... 800	30 ... 800	30 ... 1000	30 ... 1200	30 ... 1500	30 ... 1500
Protection against rotation/guide		Piston rod protected against rotation, with plain-bearing guide					
Duty cycle	[%]	100					
Position sensing		For proximity sensor					
Type of mounting		With female thread/accessories					
Mounting position		Any					

Mechanical data – Ball screw		32			40			50		
Size		32			40			50		
Spindle pitch	[mm/rev]	5	10	5	10	16	5	10	20	
Spindle diameter	[mm]	12			16			20		
Max. cylinder force ¹⁾	[kN]	1	1	3	3	2.6	5	5	4.5	
Max. driving torque	[Nm]	1.1	2	3	5.6	7.7	4.8	9.2	16.3	
Max. radial force ²⁾	[N]	115			130			300		
Max. speed	[m/s]	0.55	1.1	0.4	0.8	1.2	0.3	0.6	1.2	
Max. rotational speed	[rpm]	6600	6600	4800	4800	4500	3600	3600	3600	
Max. acceleration	[m/s ²]	5	15	5	15	25	5	15	25	
Max. angle of rotation of piston rod ³⁾	[°]	±0.25			±0.2			±0.15		
Reversing backlash ³⁾	[mm]	< 0.03	< 0.04	< 0.03	< 0.03	< 0.04	< 0.03	< 0.03	< 0.04	
Repetition accuracy	[mm]	±0.01								
No-load driving torque ⁴⁾	[Nm]	0.1			0.2			0.3		

		63			80			100		
Size		63			80			100		
Spindle pitch	[mm/rev]	5	10	25	5	15	32	5	20	40
Spindle diameter	[mm]	25			32			40		
Max. cylinder force ¹⁾	[kN]	7	7	6	12	12	10	17	17	14.5
Max. driving torque	[Nm]	7	13.1	26.5	11.9	33.7	56.6	16.9	63.7	102.6
Max. radial force ²⁾	[N]	700			1100			1100		
Max. speed	[m/s]	0.27	0.53	1.35	0.21	0.62	1.34	0.16	0.67	1.34
Max. rotational speed	[rpm]	3250	3220	3260	2530	2515	2515	2010	2010	2010
Max. acceleration	[m/s ²]	5	15	25	5	15	25	5	15	25
Max. angle of rotation of piston rod ³⁾	[°]	±0.4			±0.5			±0.5		
Reversing backlash ³⁾	[mm]	< 0.03	< 0.03	< 0.04	< 0.03	< 0.03	< 0.04	< 0.03	< 0.03	< 0.04
Repetition accuracy	[mm]	±0.015		±0.01						
No-load driving torque ⁴⁾	[Nm]	0.4	0.45	0.5	0.5	0.6	0.65	0.7	0.9	1.0

- 1) The pressure force is dependent on the stroke and has an effect on the service life → page 12
- 2) On the drive shaft
- 3) In new condition
- 4) At a rotational speed of the spindle of 200 rpm

Data sheet

Mechanical data – Lead screw				
Size		32	40	50
Spindle pitch	[mm/rev]	2.5	3	4
Spindle diameter	[mm]	12	16	20
Max. cylinder force ¹⁾	[kN]	0.6	1	1.6
Max. driving torque	[Nm]	1.1	2.4	4.8
Max. radial force ²⁾	[N]	115	130	300
Max. speed	[m/s]	0.05	0.05	0.05
Max. rotational speed	[rpm]	1200	1000	750
Max. acceleration	[m/s ²]	2.5	2.5	2.5
Max. angle of rotation of the piston rod	[°]	±0.25	±0.2	±0.15
Reversing backlash ³⁾	[mm]	< 0.1	< 0.1	< 0.1
Repetition accuracy	[mm]	±0.05		
No-load driving torque ⁴⁾	[Nm]	0.1	0.2	0.3

- 1) Electric cylinder with lead screw can be operated at max. force over the entire stroke range.
- 2) On the drive shaft
- 3) In new condition
- 4) At a rotational speed of the spindle of 200 rpm

Weight [g] – Ball screw						
Size	32	40	50	63	80	100
Basic weight m_0 with 0 mm stroke	781	1237	1982	3165	7393	11123
Additional weight m_{10} per 10 mm stroke	33	47	65	87	155	193
Moving mass m_{b0} with 0 mm stroke	281	467	793	1831	5300	8786
Moving mass m_{b10} per 10 mm stroke	9	26	35	52	103	132

Weight [g] – Lead screw			
Size	32	40	50
Basic weight m_0 with 0 mm stroke	667	1079	1716
Additional weight m_{10} per 10 mm stroke	34	48	67
Moving mass m_{b0} with 0 mm stroke	198	317	532
Moving mass m_{b10} per 10 mm stroke	9	11	13

Total weight m_{total} :

$$m = m_0 + m_{10} \cdot \frac{l}{10}$$

l = stroke

Total moving mass m_{btotal} :

$$m_b = m_{b0} + m_{b10} \cdot \frac{l}{10}$$

Data sheet

Operating and environmental conditions		
Ambient temperature ¹⁾		
ESBF-BS-...	[°C]	0 ... +60
ESBF-LS-...	[°C]	0 ... +50
Storage temperature	[°C]	-20 ... +60
Degree of protection to IEC 60529		
ESBF-...		IP40
ESBF-...-S1		IP65
Relative humidity	[%]	0 ... 95 (non-condensing)
Duty cycle	[%]	100
Maintenance interval		Lifetime lubrication
Cleanroom class		Class 7 according to ISO 14644-1
Food-safe with ESBF-...-F1 ²⁾		Supplementary material information
Corrosion resistance class CRC ³⁾		
ESBF-...		2
ESBF-...-R3		3

1) Note operating range of proximity sensors and motors

2) Additional information: www.festo.com/sp → Certificates

Only in combination with ESBF-BS-... (ball screw)

3) Corrosion resistance class CRC 2 to Festo standard FN 940070

Moderate corrosion stress. Indoor applications in which condensation can occur. External visible parts with primarily decorative surface requirements which are in direct contact with a normal industrial environment.

Corrosion resistance class CRC 3 to Festo standard FN 940070

High corrosion stress. Outdoor exposure under moderate corrosive conditions. Externally visible parts with primarily functional surface requirements which are in direct contact with a normal industrial environment.

Mass moment of inertia – Ball screw										
Size		32			40			50		
Spindle pitch	[mm/rev]	5	10		5	10	16	5	10	20
J_0 with 0 mm stroke	[kg cm ²]	0.023	0.036		0.050	0.078	0.125	0.145	0.187	0.329
J_H per metre stroke	[kg cm ² /m]	0.122	0.139		0.460	0.480	0.523	1.019	1.043	1.139
J_L per kg payload	[kg cm ² /kg]	0.006	0.025		0.006	0.025	0.065	0.006	0.025	0.101

Size		63			80			100		
Spindle pitch	[mm/rev]	5	10	25	5	15	32	5	20	40
J_0 with 0 mm stroke	[kg cm ²]	0.491	0.486	0.650	1.529	1.648	2.119	4.696	5.050	6.710
J_H per metre stroke	[kg cm ² /m]	2.832	2.859	3.053	7.699	7.815	8.277	18.978	19.310	20.372
J_L per kg payload	[kg cm ² /kg]	0.006	0.025	0.158	0.006	0.057	0.259	0.006	0.101	0.405

Mass moment of inertia – Lead screw					
Size		32		40	50
Spindle pitch	[mm/rev]	2.5		3	4
J_0 with 0 mm stroke	[kg cm ²]	0.016		0.045	0.141
J_H per metre stroke	[kg cm ² /m]	0.161		0.508	1.238
J_L per kg payload	[kg cm ² /kg]	0.002		0.002	0.004

The mass moment of inertia J_A of the electric cylinder is calculated as follows:

$$J_A = J_0 + J_H \times \text{working stroke [m]} + J_L \times m_{\text{moving payload [kg]}}$$

Data sheet

Materials

Sectional view

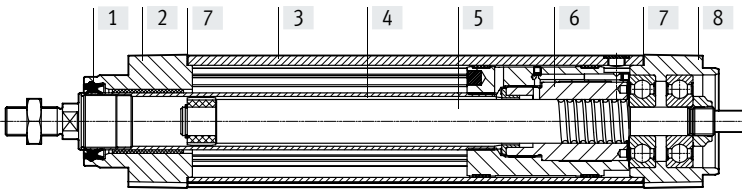

Size	32 ... 50	63 ... 100
[1] Wiper	TPE-U	
[2] Bearing cap	Coated wrought aluminium alloy	Coated gravity die-cast aluminium
[3] Cylinder barrel	Smooth-anodised wrought aluminium alloy	
[4] Piston rod	High-alloy stainless steel	
[5] Spindle		
ESBF-BS-...	Rolled steel	
ESBF-LS-...	High-strength steel	
[6] Spindle nut		
ESBF-BS-...	Rolled steel	
ESBF-LS-...	POM with PTFE	
[7] Flat seal (with ESBF-...-S1)	Fibre-reinforced thermoplastic	
[8] Drive cover	Coated wrought aluminium alloy	Coated gravity die-cast aluminium
- Note on materials	RoHS-compliant	
- PWIS conformity	VDMA24364 zone III	
- ESBF-F1A	Metals with more than 1% copper, zinc or nickel by mass are excluded from use. Exceptions are nickel in steel, chemically nickel-plated surfaces, printed circuit boards, cables, electrical plug connectors and coils	

Data sheet

Lateral force F_q as a function of stroke length l

On the piston rod

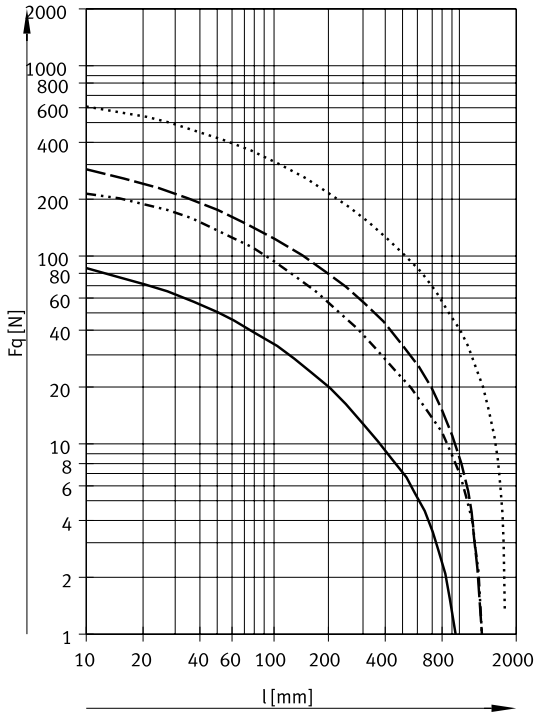
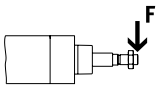

- ESBF-32
- ESBF-40
- - - ESBF-50, 63
- · - · ESBF-80, 100

On the drive shaft

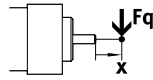

ESBF-BS-32/40/50

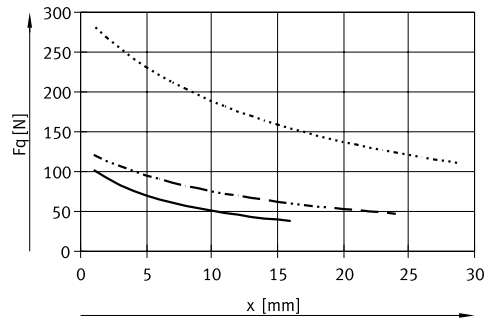

ESBF-BS-63/80/100

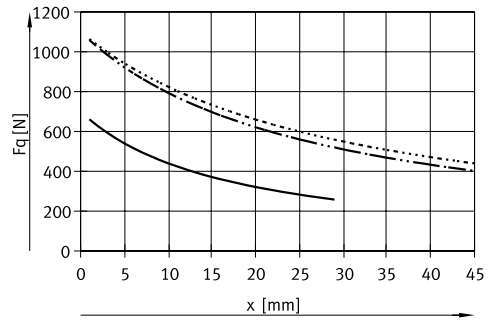

- ESBF-32
- ESBF-40
- - - ESBF-50
- ESBF-63
- ESBF-80
- · - · ESBF-100

Data sheet

Max. pressure force F as a function of piston rod length l (l = stroke + optional piston rod extension)

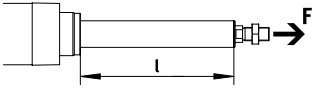

Dependent on the stroke, the pressure force must be limited due to possible buckling.
This does not affect the tensile force.

For ball screw
ESBF-BS-32-...

ESBF-BS-40-...

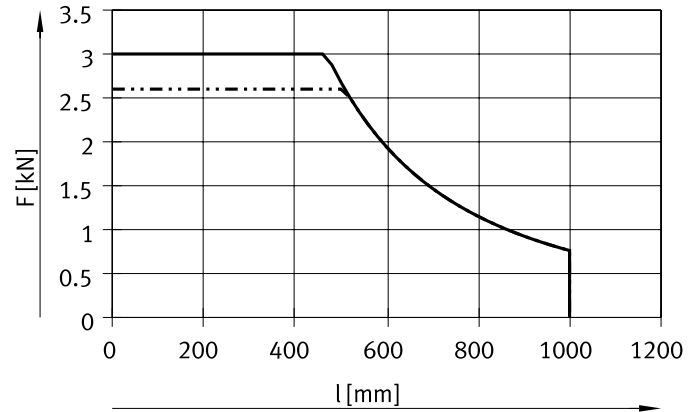
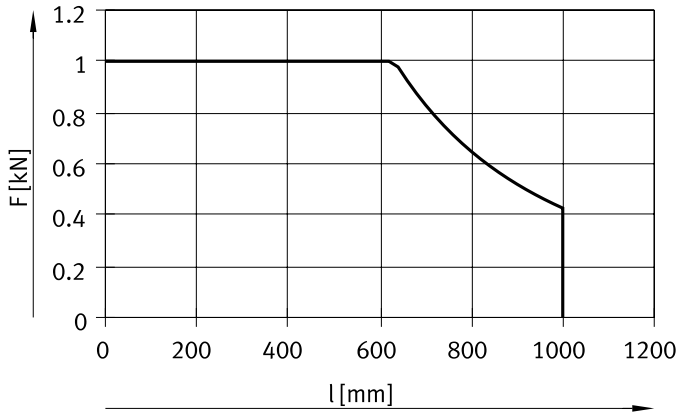

ESBF-BS-32-...-5P/10P

ESBF-BS-40-...-5P/10P
ESBF-BS-40-...-16P

ESBF-BS-50-...

ESBF-BS-63-...

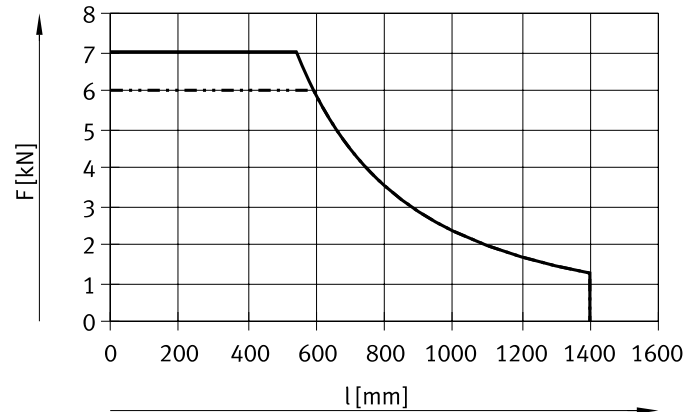
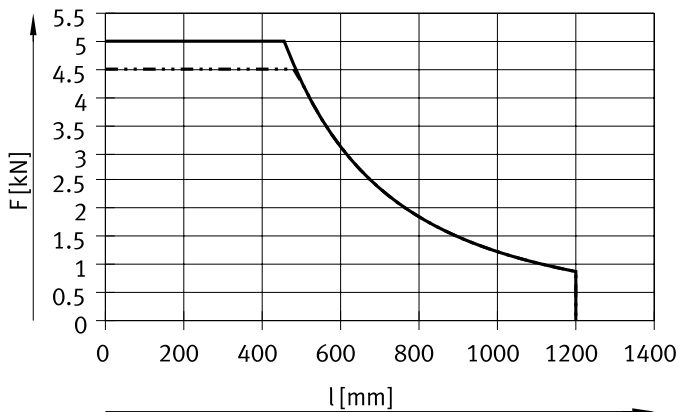

ESBF-BS-50-...-5P/10P
ESBF-BS-50-...-20P

ESBF-BS-63-...-5P/10P
ESBF-BS-63-...-25P

Data sheet

Max. pressure force F as a function of piston rod length l ($l = \text{stroke} + \text{optional piston rod extension}$)

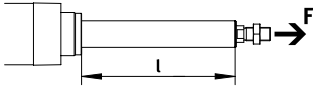

Dependent on the stroke, the pressure force must be limited due to possible buckling.
This does not affect the tensile force.

For ball screw
ESBF-BS-80-...

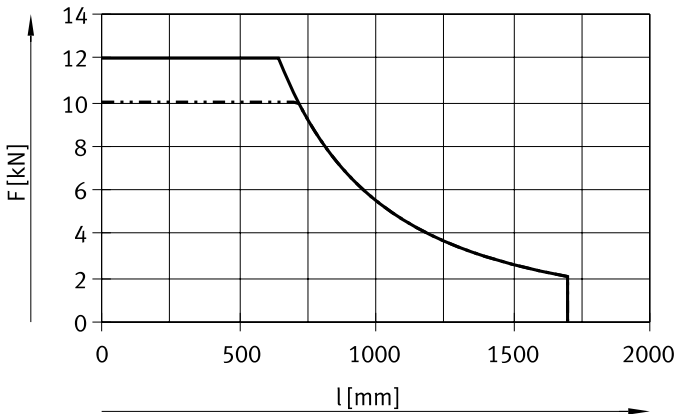

— ESBF-BS-80-...-5P/15P
- - - ESBF-BS-80-...-32P

ESBF-BS-100-...

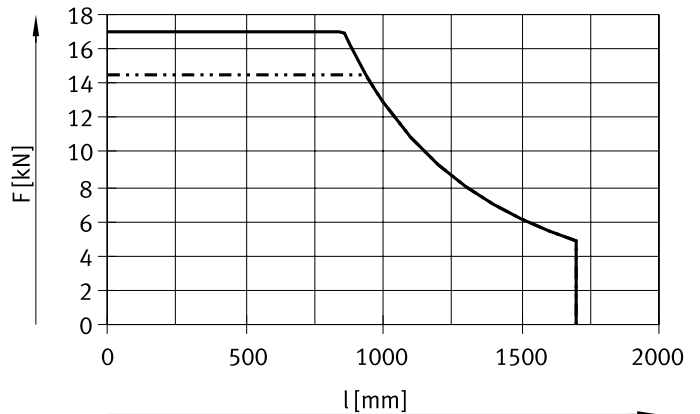

— ESBF-BS-100-...-5P/20P
- - - ESBF-BS-100-...-40P

For lead screw
ESBF-LS-...

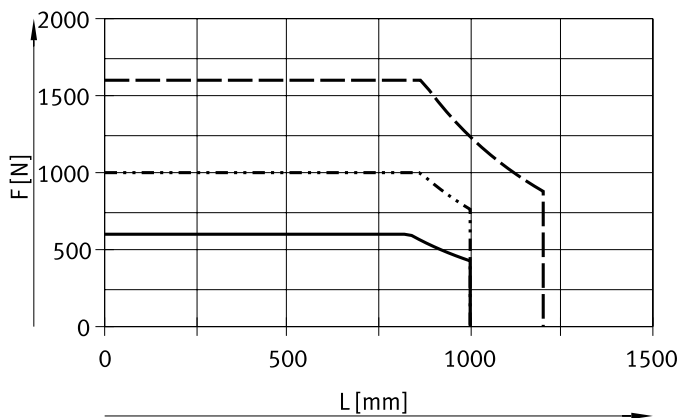

— ESBF-LS-32
- - - ESBF-LS-40
- · - ESBF-LS-50

Data sheet

Max. feed speed v as a function of stroke length l

For ball screw

ESBF-BS-32-...

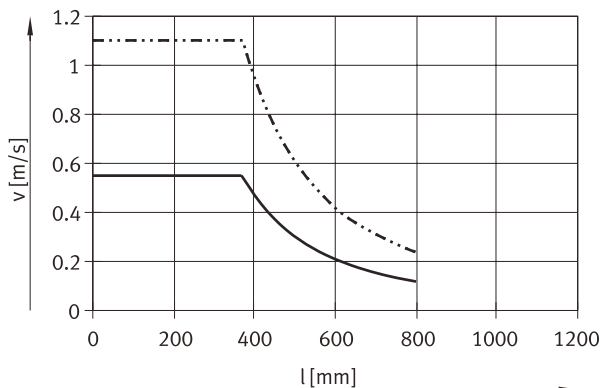

- ESBF-BS-32-...-5P
- - - ESBF-BS-32-...-10P

ESBF-BS-40-...

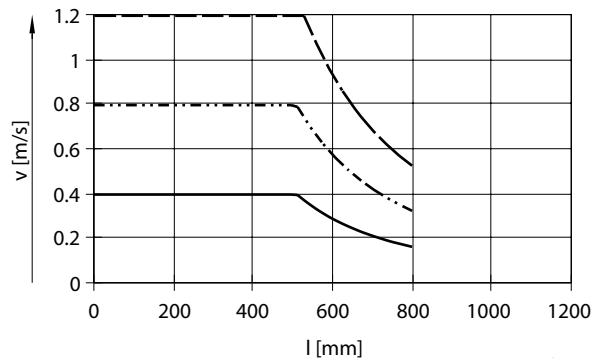

- ESBF-BS-40-...-5P
- - - ESBF-BS-40-...-10P
- · - ESBF-BS-40-...-16P

ESBF-BS-50-...

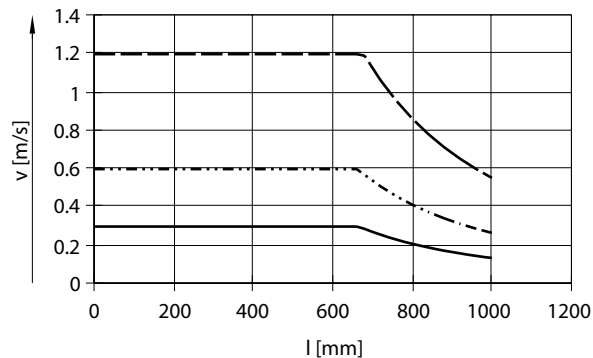

- ESBF-BS-50-...-5P
- - - ESBF-BS-50-...-10P
- · - ESBF-BS-50-...-20P

ESBF-BS-63-...

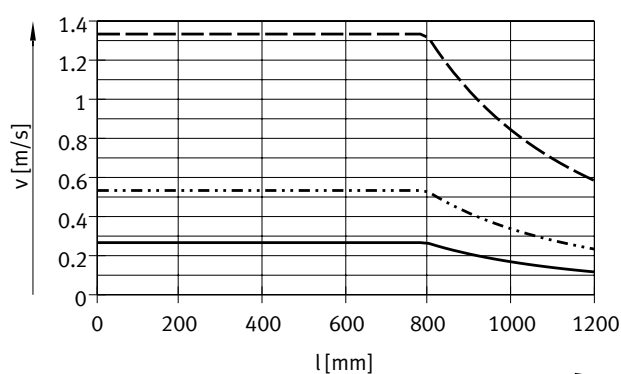

- ESBF-BS-63-...-5P
- - - ESBF-BS-63-...-10P
- · - ESBF-BS-63-...-25P

ESBF-BS-80-...

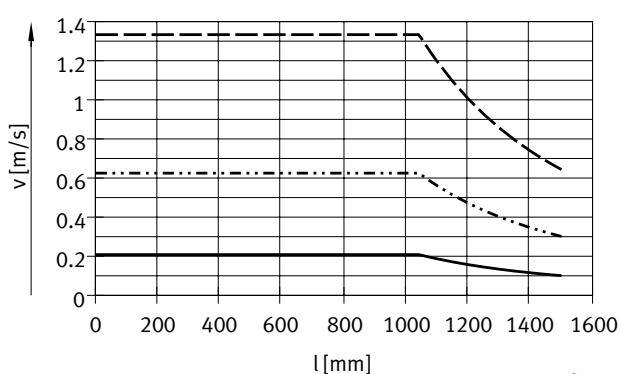

- ESBF-BS-80-...-5P
- - - ESBF-BS-80-...-15P
- · - ESBF-BS-80-...-32P

ESBF-BS-100-...

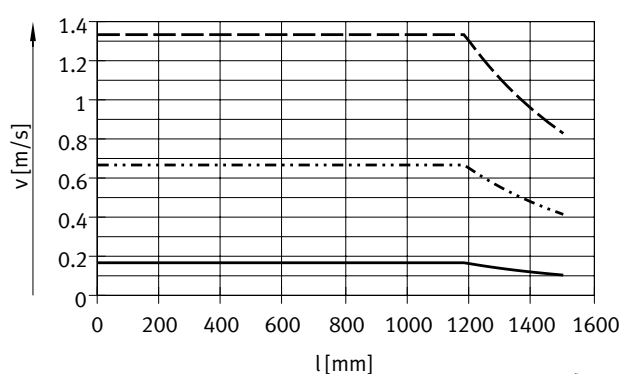

- ESBF-BS-100-...-5P
- - - ESBF-BS-100-...-20P
- · - ESBF-BS-100-...-40P

Data sheet

Maximum feed force F as a function of feed speed v

For ball screw

ESBF-BS-32-...

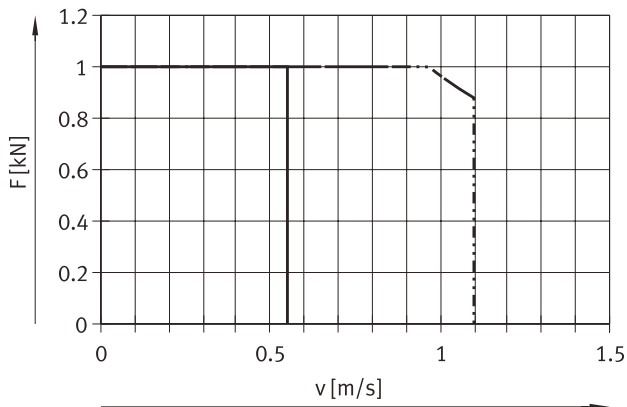

— ESBF-32-...-5P
 - - - ESBF-32-...-10P

ESBF-BS-40-...

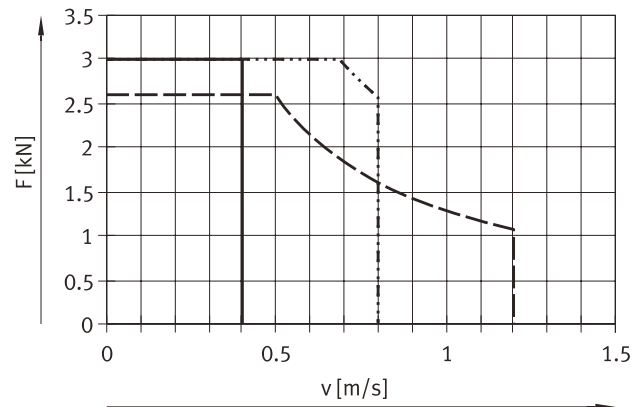

— ESBF-40-...-5P
 - - - ESBF-40-...-10P
 - · - ESBF-40-...-16P

ESBF-BS-50-...

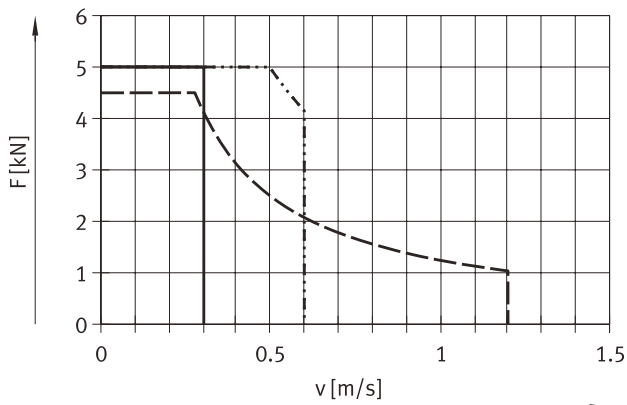

— ESBF-50-...-5P
 - - - ESBF-50-...-10P
 - · - ESBF-50-...-20P

ESBF-BS-63-...

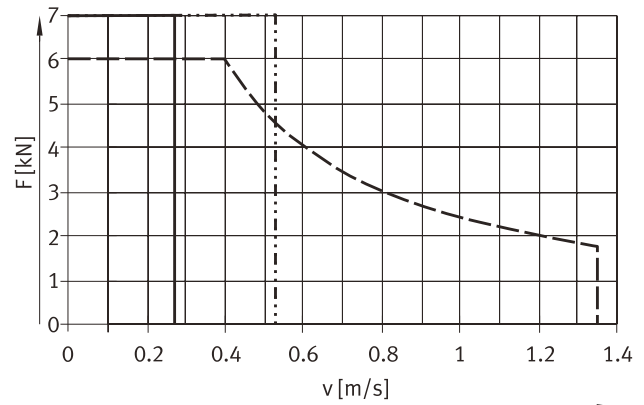

— ESBF-BS-63-...-5P
 - - - ESBF-BS-63-...-10P
 - · - ESBF-BS-63-...-25P

ESBF-BS-80-...

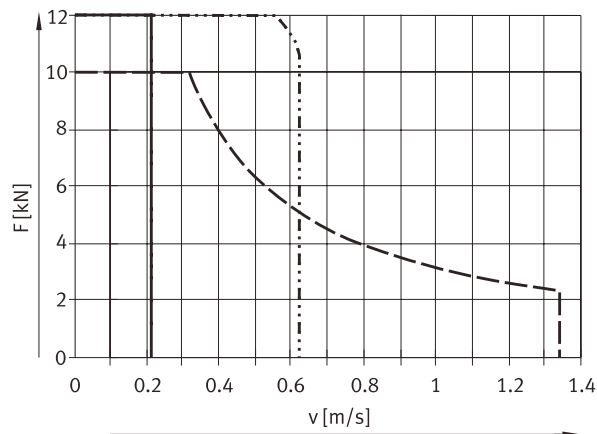

— ESBF-BS-80-...-5P
 - - - ESBF-BS-80-...-15P
 - · - ESBF-BS-80-...-32P

ESBF-BS-100-...

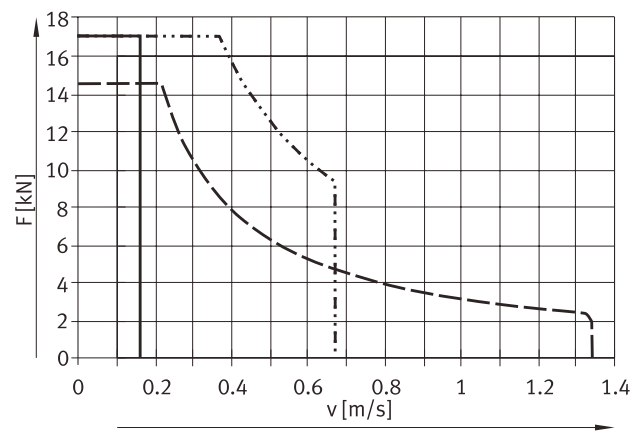

— ESBF-BS-100-...-5P
 - - - ESBF-BS-100-...-20P
 - · - ESBF-BS-100-...-40P

Data sheet

Maximum feed force F as a function of feed speed v

For lead screw
ESBF-LS-...

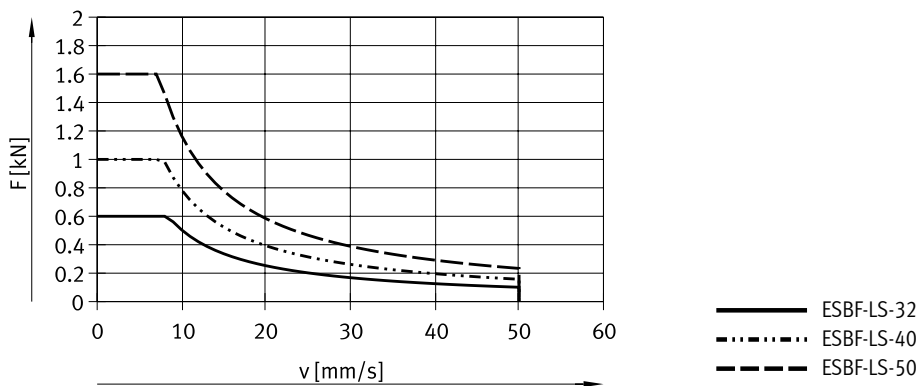

Service life

- The service life of the electric cylinder depends largely on that of the lead screw. The operating coefficient plays a considerable role in determining the possible service life, and can be determined with the help of the table (→ page 17)
- The operating coefficient for the variant ESBF-...-F1 (NSF-H1 lubricant for food & beverage applications) matches that of the standard type
- The service life ends when the maximum number of switching cycles or maximum running performance has been reached:
 - ESBF-BS: 10 million
 - ESBF-LS: → page 17 (below)
- The distance between the furthest and rearmost positions must be at least 2.5 times the spindle pitch per travel cycle
- The specifications for running performance are based on experimentally determined and theoretically calculated data (at room temperature). The running performance that can be achieved in practice can deviate considerably from the specified curves under different parameters

Calculation of the mean feed force F_{xm} with ball screw (ESBF-BS)

$$F_{xm} = \sqrt[3]{\frac{F_{x1}^3 \cdot s_1 + \dots + F_{xn}^3 \cdot s_n}{s_1 + \dots + s_n}}$$

F_{xm} = Mean feed force
 $F_{x1/n}$ = Feed force of section
 $s_{1/n}$ = Part of movement cycle that is travel

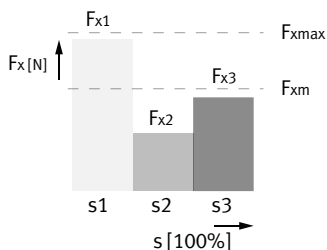

Mean feed force F_{xm} as a function of running performance L, with an operating coefficient f_b of 1.0, at room temperature

For ball screw
ESBF-BS-32-...

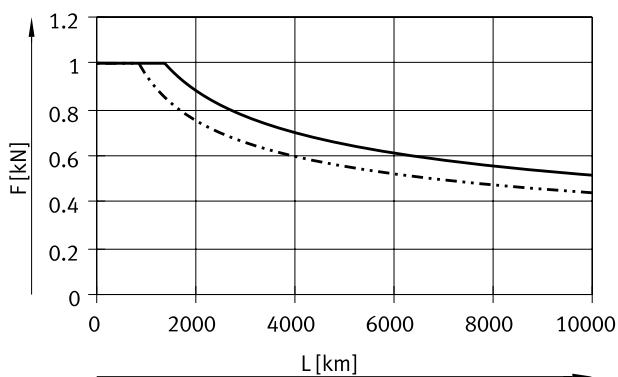

ESBF-BS-40-...

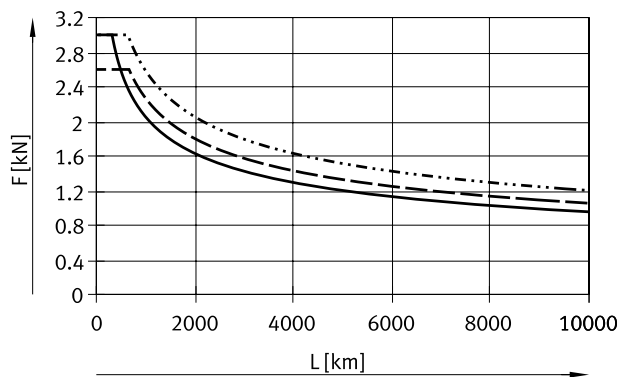

Data sheet

Service life

Mean feed force F_{xm} as a function of running performance L, with an operating coefficient f_B of 1.0, at room temperature

For ball screw

ESBF-BS-50-...

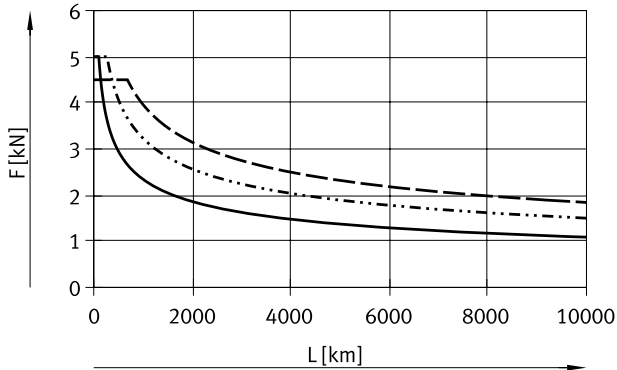

— ESBF-50-...-5P
 - - - ESBF-50-...-10P
 - - - ESBF-50-...-20P

ESBF-BS-63-...

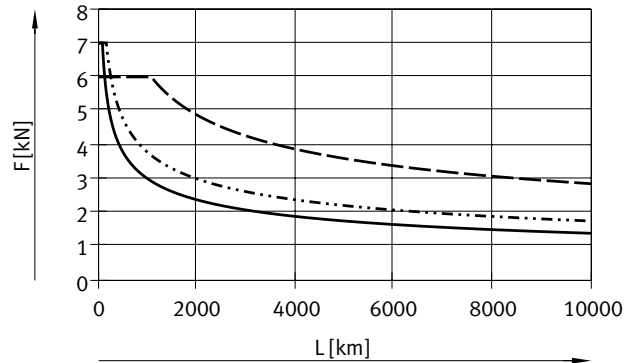

— ESBF-63-...-5P
 - - - ESBF-63-...-10P
 - - - ESBF-63-...-25P

ESBF-BS-80-...

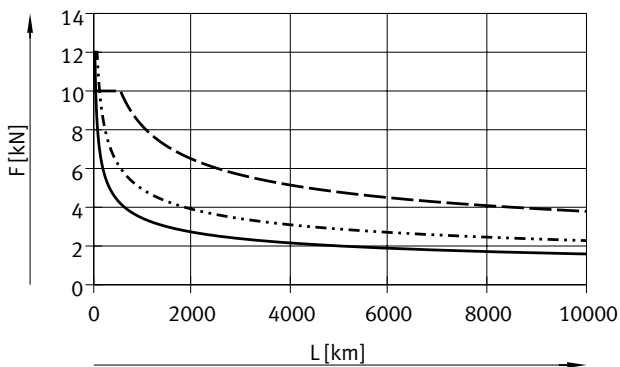

— ESBF-80-...-5P
 - - - ESBF-80-...-15P
 - - - ESBF-80-...-32P

ESBF-BS-100-...

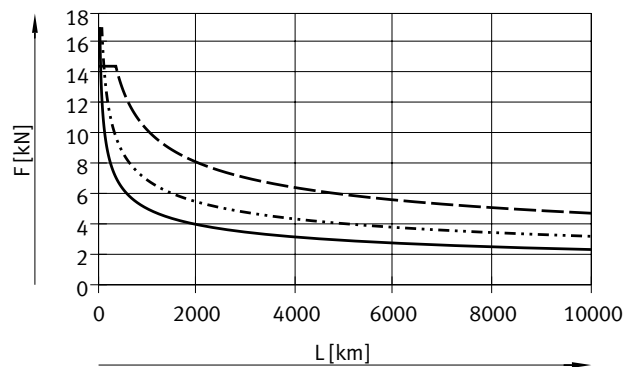

— ESBF-100-...-5P
 - - - ESBF-100-...-20P
 - - - ESBF-100-...-40P

Service life taking into account the operating coefficient

$$L_1 = \frac{L}{f_B^3}$$

L_{ist} = Actual service life

L = Target service life

(→ graphs)

f_B = Operating coefficient

Load ¹⁾	Operating coefficient f_B	Application example
None	1.0 ... 1.2	Measuring machine
Light	1.2 ... 1.4	Handling, robotics
Medium	1.4 ... 1.6	Press-in operations
High	1.6 ... 2.0	Construction, agriculture

1) This refers to loads caused by impact, temperature, contamination, shock and vibrations that affect the cylinder or piston rod.

Reference values for lead screw (ESBF-LS)

Size	32	40	50
Running performance L [km]	200	250	300
Load cycle L ¹⁾ [million]	1.0	1.2	1.4
Switching cycles L ²⁾ [million]	0.5	0.6	0.7

1) Movement from position A to B with acceleration and deceleration to a standstill.

2) Two load cycles to return to starting point

Data sheet

Friction losses and driving torque

Friction losses

The friction losses comprise the no-load driving torque and the speed-dependent friction losses.

$$M_{\text{friction}} = M_{\text{no-load}} + M_{\text{V}}$$

M_{friction} = Friction torque

$M_{\text{no-load}}$ = No-load driving torque

M_{V} = Friction torque as a function of feed speed

Driving torque

The driving torque required for the cylinder comprises the friction torque and the effective torque.

$$M_{\text{drive}} = M_{\text{friction}} + M_{\text{eff}}$$

M_{drive} = Required driving torque

M_{friction} = Friction torque

M_{eff} = Effective torque

No-load driving torque – Ball screw¹⁾

Size	32			40			50		
Spindle pitch [mm/rev]	5	10		5	10	16	5	10	20
No-load driving torque $M_{\text{no-load}}$ [Nm]	0.1	0.1		0.2	0.2	0.2	0.3	0.3	0.3

Size	63			80			100		
Spindle pitch [mm/rev]	5	10	25	5	15	32	5	20	40
No-load driving torque $M_{\text{no-load}}$ [Nm]	0.4	0.45	0.5	0.5	0.6	0.65	0.7	0.9	1.0

No-load driving torque – Lead screw¹⁾

Size	32		40		50	
Spindle pitch [mm/rev]	2.5		3		4	
No-load driving torque $M_{\text{no-load}}$ [Nm]	0.1		0.2		0.3	

1) Corresponds to the driving torque required without load at a rotational speed of the spindle of 200 rpm

Data sheet

Friction torque M_f as a function of feed speed v

For ball screw

ESBF-BS-32-...

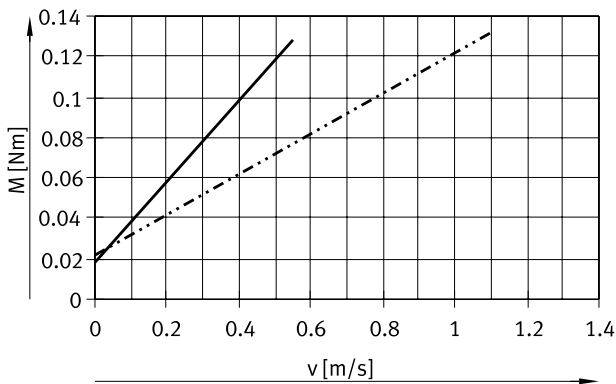

- ESBF-BS-32-...-5P
- - - ESBF-BS-32-...-10P

ESBF-BS-40-...

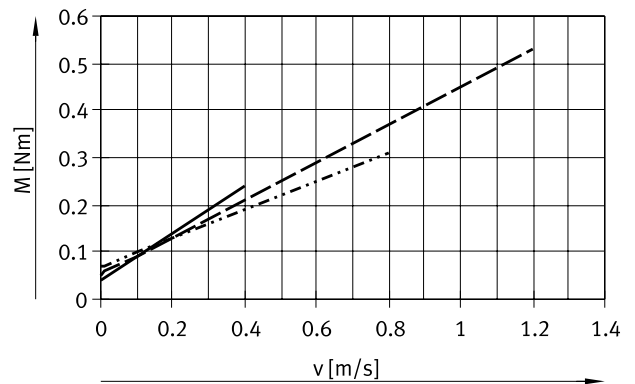

- ESBF-BS-40-...-5P
- - - ESBF-BS-40-...-10P
- · - ESBF-BS-40-...-16P

ESBF-BS-50-...

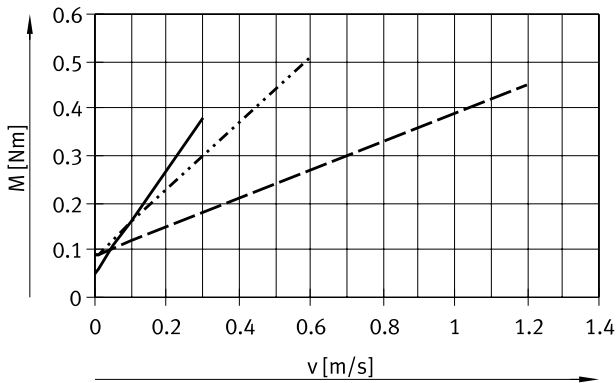

- ESBF-BS-50-...-5P
- - - ESBF-BS-50-...-10P
- · - ESBF-BS-50-...-20P

ESBF-BS-63-...

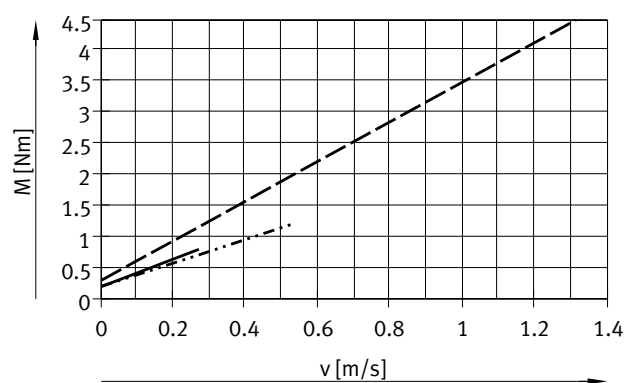

- ESBF-BS-63-...-5P
- - - ESBF-BS-63-...-10P
- · - ESBF-BS-63-...-25P

ESBF-BS-80-...

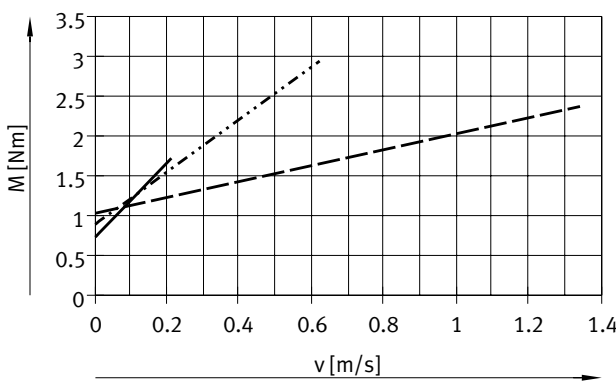

- ESBF-BS-80-...-5P
- - - ESBF-BS-80-...-15P
- · - ESBF-BS-80-...-20P

ESBF-BS-100-...

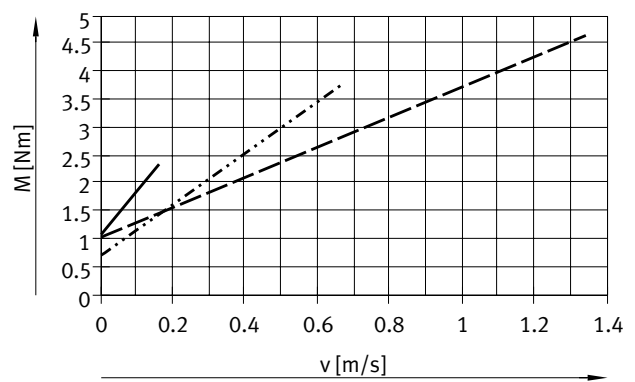

- ESBF-BS-100-...-5P
- - - ESBF-BS-100-...-20P
- · - ESBF-BS-100-...-40P

Data sheet

Friction torque M_v as a function of feed speed v

For lead screw

ESBF-LS-...

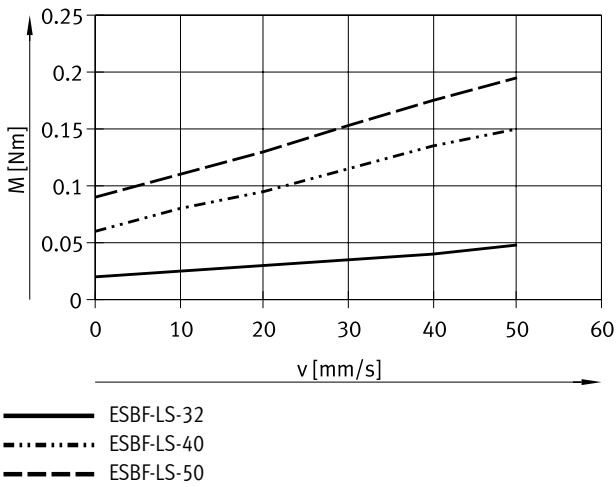

Effective torque M_{eff} as a function of feed force F

For ball screw

ESBF-BS-32-...

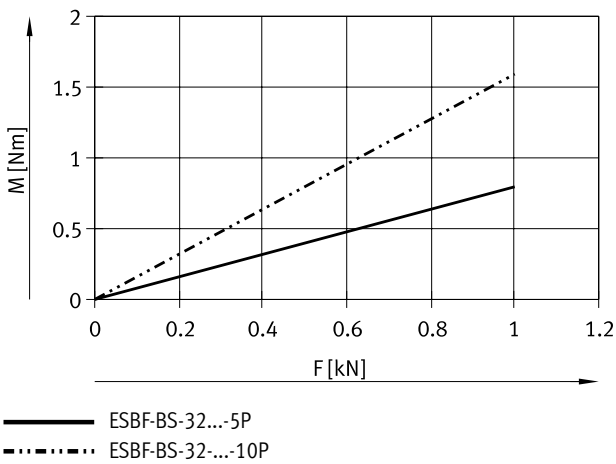

ESBF-BS-40-...

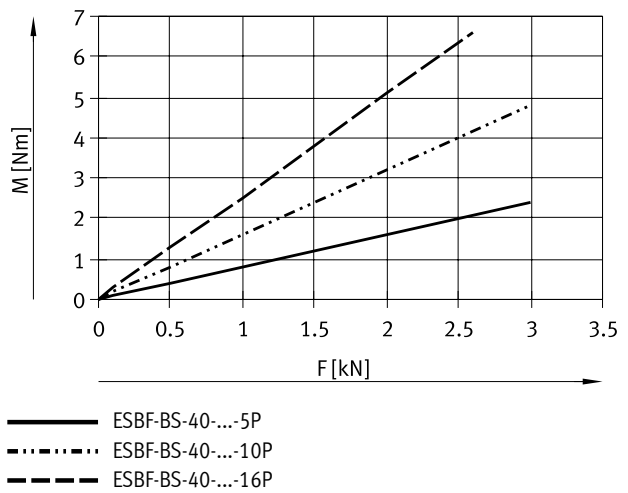

ESBF-BS-50-...

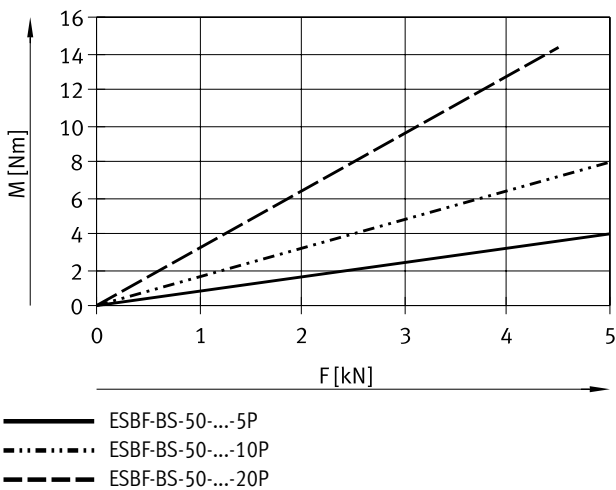

ESBF-BS-63-...

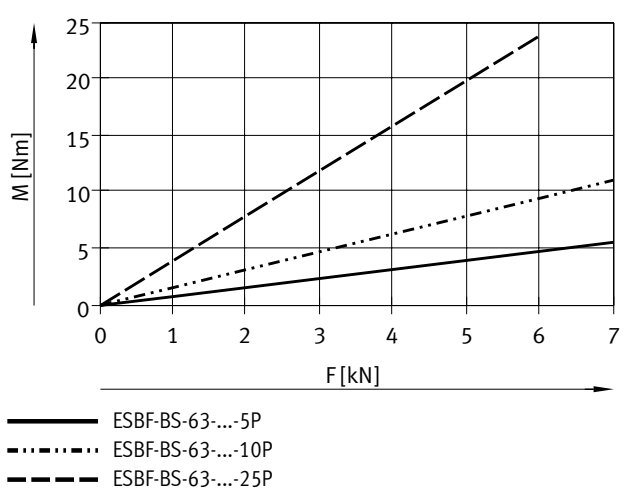

Data sheet

Effective torque M_{eff} as a function of feed force F

For ball screw

ESBF-BS-80-...

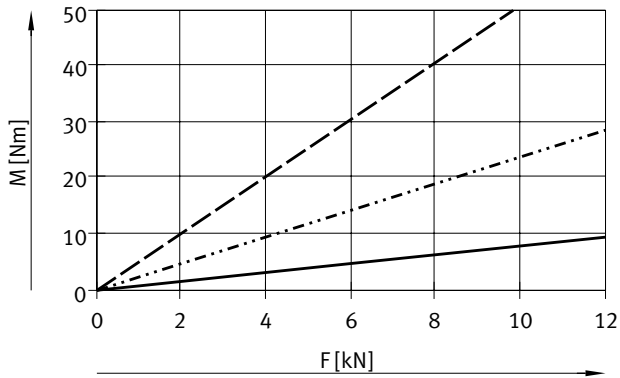

- ESBF-BS-80-...-5P
- - - ESBF-BS-80-...-15P
- - - ESBF-BS-80-...-32P

ESBF-BS-100-...

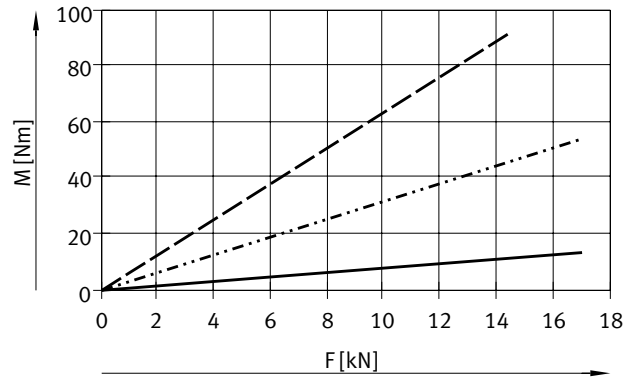

- ESBF-BS-100-...-5P
- - - ESBF-BS-100-...-20P
- - - ESBF-BS-100-...-40P

For lead screw

ESBF-LS-...

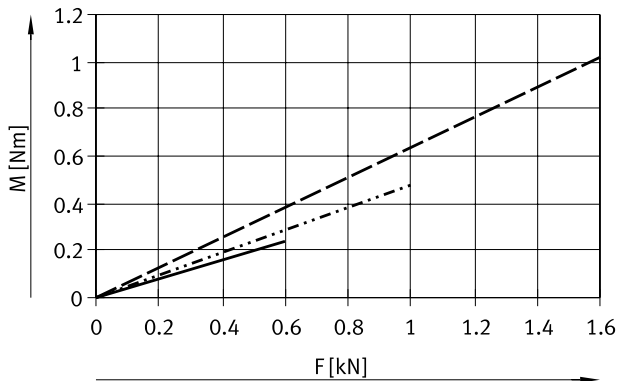

- ESBF-LS-32
- - - ESBF-LS-40
- - - ESBF-LS-50

Data sheet

Dimensions

Download CAD data → www.festo.com

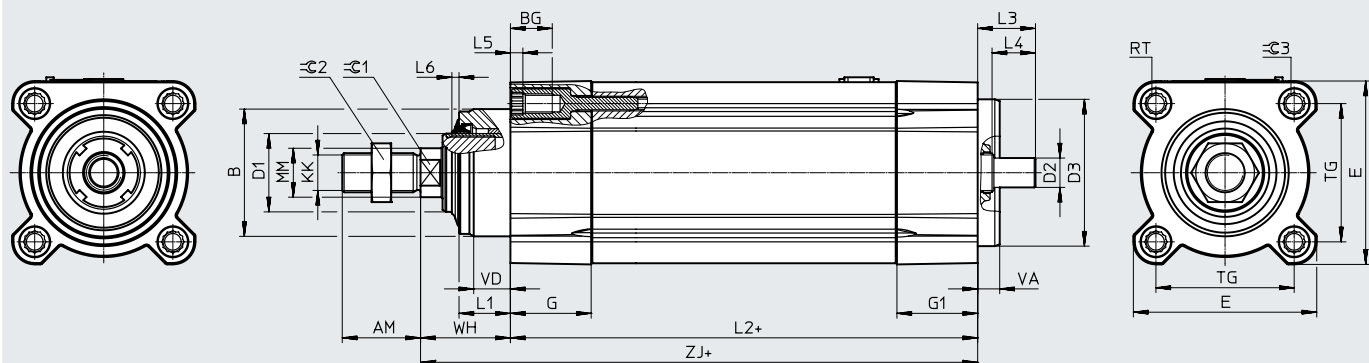

+ = plus stroke length

Size	AM	B	BG	D1	D2	D3	E	G
	-0.5	\varnothing d11	min.	\varnothing h9	\varnothing h6	\varnothing f7		
32	22	34	16	20	6	32	$45^{+0.5}$	$25.5_{-0.1}$
40	24	39	16	24	8	40	$54^{+0.5}$	$30_{-0.1}$
50	32	45	17	28	12	50	$64^{+0.5}$	$30_{-0.1}$
63	32	52	17	32	12	60	$75^{+0.5/-0.1}$	33 ± 0.1
80	40	60	17	40	19	80	$93^{+0.5/-0.1}$	39 ± 0.1
100	40	70	17	50	24	100	$110^{+0.5/-0.1}$	39 ± 0.1

Size	G1	L1	L2	L3	L4	L5	L6	KK	MM
					± 0.2	min.			\varnothing -0.1
32	$25.5_{-0.1}$	$12^{+0.2}$	$122.5^{+0.2/-1.4}$	$15.9^{+0.8/-0.3}$	8	4	4	M10x1.25	14
40	$30_{-0.1}$	$14^{+0.2}$	$144^{+0.2/-1.4}$	$18.4^{+0.8/-0.3}$	14	4	4	M12x1.25	16
50	$34_{-0.1}$	$20^{+0.2}$	$163^{+0.2/-1.4}$	$27^{+0.8/-0.3}$	17	5	4	M16x1.5	20
63	33 ± 0.1	$21_{-0.5}$	$171^{+0.7/-1.2}$	23.5 ± 0.5	17	5	5	M16x1.5	20
80	39 ± 0.1	$28_{-0.5}$	$204^{+0.7/-1.2}$	33.5 ± 0.5	26	25.9	5	M20x1.5	25
100	39 ± 0.1	$33_{-0.5}$	$224^{+0.7/-1.2}$	39.5 ± 0.5	30	25.9	5	M20x1.5	25

Size	RT	TG	VA	VD	WH	ZJ	$\varnothing C1$	$\varnothing C2$	$\varnothing C3$
32	M6	32.5	$7_{-0.2}$	8 ± 0.1	$25.5^{+1.9/-0.8}$	$148^{+2.1/-1.1}$	10	17	6
40	M6	38	$7_{-0.2}$	9 ± 0.1	$29.5^{+1.9/-0.8}$	$173.5^{+2.1/-1.1}$	13	19	6
50	M8	46.5	$9_{-0.2}$	11.5 ± 0.1	$36.5^{+1.9/-0.8}$	$199.5^{+2.1/-1.1}$	17	24	8
63	M8	56.5 ± 0.5	9 ± 0.2	15 ± 0.2	$37^{+1.8/-1.7}$	208	17	24	8
80	M10	72 ± 0.5	10 ± 0.2	18 ± 0.2	$46^{+1.8/-1.7}$	250	22	30	6
100	M10	89 ± 0.5	12 ± 0.2	20 ± 0.2	$51^{+1.8/-1.7}$	275	22	30	6

 - **Note**
Spanner flat $\varnothing C1$ can be aligned either way.

Data sheet

Dimensions

Download CAD data → www.festo.com

Variants

...E – Extended piston rod

F – Female thread

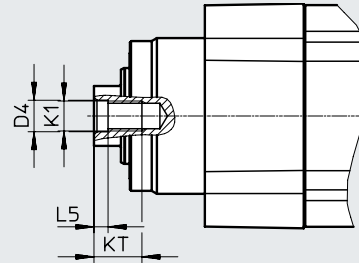
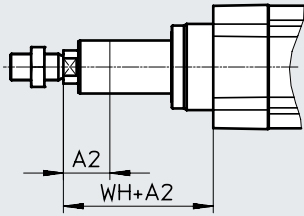

S1 – Degree of protection IP65 / F1 – For the food zone

ESBF-32 ... 50

ESBF-63 ... 100

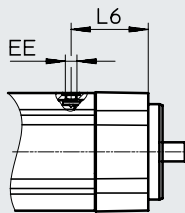
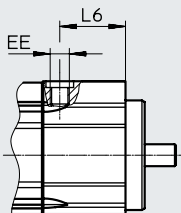

Size	A2 max.	D4 ∅	EE	L5 ±0.2	L6	K1	KT min.	WH
32	200	6.4 ^{+0.2}	M7	2.6	19.5	M6	12	25.5+1.9/-0.8
40	200	8.4 ^{+0.2}	M7	3.3	24	M8	12	29.5+1.9/-0.8
50	200	10.5 ^{+0.2}	M7	4.7	28	M10	16	36.5+1.9/-0.8
63	200	10.5 ^{+0.1}	G1/8	4.7	48.5	M10	16	37+1.8/-1.7
80	200	13 ^{+0.1}	G1/8	6.1	57.5	M12	20	46+1.8/-1.7
100	200	13 ^{+0.1}	G1/8	6.1	68.5	M12	20	51+1.8/-1.7

Data sheet

Ordering data – Ball screw

Spindle pitch [mm/rev]	Stroke [mm]	Part no.	Type
ESBF-32			
5	100	★ 8022562	ESBF-BS-32-100-5P
	200	★ 2215384	ESBF-BS-32-200-5P
	300	★ 8022563	ESBF-BS-32-300-5P
	400	★ 8022564	ESBF-BS-32-400-5P
10	100	★ 8022565	ESBF-BS-32-100-10P
	200	★ 8022566	ESBF-BS-32-200-10P
	300	★ 8022567	ESBF-BS-32-300-10P
	400	★ 8022568	ESBF-BS-32-400-10P
ESBF-40			
5	100	★ 8022574	ESBF-BS-40-100-5P
	200	★ 2215385	ESBF-BS-40-200-5P
	300	★ 8022575	ESBF-BS-40-300-5P
	400	★ 8022576	ESBF-BS-40-400-5P
10	100	★ 8022577	ESBF-BS-40-100-10P
	200	★ 8022578	ESBF-BS-40-200-10P
	300	★ 8022579	ESBF-BS-40-300-10P
	400	★ 8022580	ESBF-BS-40-400-10P
16	100	★ 8022581	ESBF-BS-40-100-16P
	200	★ 8022582	ESBF-BS-40-200-16P
	300	★ 8022583	ESBF-BS-40-300-16P
	400	★ 8022584	ESBF-BS-40-400-16P

Spindle pitch [mm/rev]	Stroke [mm]	Part no.	Type
ESBF-50			
5	100	★ 8022590	ESBF-BS-50-100-5P
	200	★ 2215386	ESBF-BS-50-200-5P
	300	★ 8022591	ESBF-BS-50-300-5P
	400	★ 8022592	ESBF-BS-50-400-5P
10	100	★ 8022593	ESBF-BS-50-100-10P
	200	★ 8022594	ESBF-BS-50-200-10P
	300	★ 8022595	ESBF-BS-50-300-10P
	400	★ 8022596	ESBF-BS-50-400-10P
20	100	★ 8022597	ESBF-BS-50-100-20P
	200	★ 8022598	ESBF-BS-50-200-20P
	300	★ 8022599	ESBF-BS-50-300-20P
	400	★ 8022600	ESBF-BS-50-400-20P
ESBF-63			
5	100	★ 574093	ESBF-BS-63-100-5P
	200	★ 1347390	ESBF-BS-63-200-5P
	300	★ 574094	ESBF-BS-63-300-5P
	400	★ 574095	ESBF-BS-63-400-5P
10	100	★ 574096	ESBF-BS-63-100-10P
	200	★ 574097	ESBF-BS-63-200-10P
	300	★ 574098	ESBF-BS-63-300-10P
	400	★ 574099	ESBF-BS-63-400-10P
25	100	★ 574100	ESBF-BS-63-100-25P
	200	★ 574101	ESBF-BS-63-200-25P
	300	★ 574102	ESBF-BS-63-300-25P
	400	★ 574103	ESBF-BS-63-400-25P

 Note

Order variable strokes and variants via the modular product system

→ page 26

Festo core product range

- ★ Generally ready for dispatch from the factory within 24 hours
- ★ Generally ready for dispatch from the factory within 5 days

Data sheet

Ordering data – Ball screw				Ordering data – Ball screw			
Spindle pitch [mm/rev]	Stroke [mm]	Part no.	Type	Spindle pitch [mm/rev]	Stroke [mm]	Part no.	Type
ESBF-80				ESBF-100			
5	100	574104	ESBF-BS-80-100-5P	5	100	574115	ESBF-BS-100-100-5P
	200	1347391	ESBF-BS-80-200-5P		200	1347393	ESBF-BS-100-200-5P
	300	574105	ESBF-BS-80-300-5P		300	574116	ESBF-BS-100-300-5P
	400	574106	ESBF-BS-80-400-5P		400	574117	ESBF-BS-100-400-5P
15	100	574107	ESBF-BS-80-100-15P	20	100	574118	ESBF-BS-100-100-20P
	200	574108	ESBF-BS-80-200-15P		200	574119	ESBF-BS-100-200-20P
	300	574109	ESBF-BS-80-300-15P		300	574120	ESBF-BS-100-300-20P
	400	574110	ESBF-BS-80-400-15P		400	574121	ESBF-BS-100-400-20P
32	100	574111	ESBF-BS-80-100-32P	40	100	574122	ESBF-BS-100-100-40P
	200	574112	ESBF-BS-80-200-32P		200	574123	ESBF-BS-100-200-40P
	300	574113	ESBF-BS-80-300-32P		300	574124	ESBF-BS-100-300-40P
	400	574114	ESBF-BS-80-400-32P		400	574125	ESBF-BS-100-400-40P

Ordering data – Lead screw			
Spindle pitch [mm/rev]	Stroke [mm]	Part no.	Type
ESBF-32			
2.5	100	8022570	ESBF-LS-32-100-2.5P
	200	2295381	ESBF-LS-32-200-2.5P
	300	8022571	ESBF-LS-32-300-2.5P
	400	8022572	ESBF-LS-32-400-2.5P
ESBF-40			
3	100	8022586	ESBF-LS-40-100-3P
	200	2295382	ESBF-LS-40-200-3P
	300	8022587	ESBF-LS-40-300-3P
	400	8022588	ESBF-LS-40-400-3P
ESBF-50			
4	100	8022602	ESBF-LS-50-100-4P
	200	2295383	ESBF-LS-50-200-4P
	300	8022603	ESBF-LS-50-300-4P
	400	8022604	ESBF-LS-50-400-4P

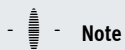
**Note**

Order variable strokes and variants
via the modular product system
→ page 26

Ordering data – Modular product system

Ordering table								Conditions	Code	Enter code
Size	32	40	50	63	80	100				
Module no.	8022569	8022585	8022601	574090	574091	574092				
Function	Electric cylinder								ESBF	ESBF
Drive type	Ball screw							[1]	-BS	
	Lead screw							[2]	-LS	
Size	32	40	50	63	80	100		-...		
Stroke [mm]	100								-...	
	200									
	300									
	400									
	30 ... 800	30 ... 800	30 ... 1000	30 ... 1200	30 ... 1500	30 ... 1500				
Spindle pitch [mm]	2.5	-	-	-	-	-		-...P		
	-	3	-	-	-	-				
	-	-	4	-	-	-				
	5	5	5	5	5	5				
	10	10	10	10	-	-				
	-	-	-	-	15	-				
	-	16	-	-	-	-				
	-	-	20	-	-	20				
	-	-	-	25	-	-				
	-	-	-	-	32	-				
	-	-	-	-	-	40				
Piston rod thread type	Male thread									
	Female thread								-F	
Degree of protection, electrical system	Standard									
	IP65								-S1	
Corrosion protection	Standard									
	High corrosion protection							[3]	-R3	
Special material properties	None									
	Recommended for production facilities for manufacturing lithium-ion batteries							[4]	-F1A	
Additional features	None									
	Food-safe as per supplementary material information							[5]	-F1	
Extended piston rod	None									
	1 ... 200								-...E	

[1] **BS** Only with spindle pitch 5P, 10P, 15P, 16P, 20P, 25P, 32P, 40P

[2] **LS** Only with spindle pitch 2.5P, 3P, 4P

[3] **R3** Only with S1

[4] **F1A** Not with S1
Not with LS
Not with R3
Not with F1

[5] **F1** Only with R3
Not with LS

Accessories

 **Note**

Depending on the combination of motor and drive, it may not be possible to reach the maximum feed force of the drive.

When using parallel kits, the no-load driving torque of the particular kit must be taken into consideration.

Permissible axis/motor combinations with axial kit

Data sheets → Internet: eamm-a

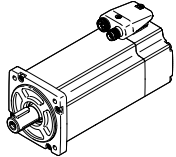
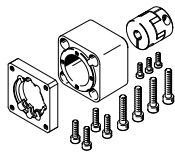
Motor/gear unit ¹⁾	Axial kit	
		<ul style="list-style-type: none"> Kits for third-party motors → Internet: eamm-a
Type	Part no.	Type
ESBF-32		
With servo motor		
EMME-AS-40-...	★ 1976465	EAMM-A-D32-40P
	2207372	EAMM-A-D32-40P-S1 ²⁾
EMMT-AS-60-..., EMME-AS-60-...	★ 1956054	EAMM-A-D32-60P
	2234020	EAMM-A-D32-60P-S1 ²⁾
With servo motor and gear unit		
EMME-AS-40-...	1454238	EAMM-A-D32-40G
EMGA-40-P-G...-EAS-40	2256396	EAMM-A-D32-40G-S1 ²⁾
EMMT-AS-60-..., EMME-AS-60-...	2946760	EAMM-A-D32-60H
	EMGA-60-P-G...-EAS-60	2946761
With stepper motor		
EMMS-ST-42-...	★ 543148	EAMM-A-D32-42A
	1322179	EAMM-A-D32-42A-S1 ²⁾
EMMS-ST-57-...	★ 550980	EAMM-A-D32-57A
	1322181	EAMM-A-D32-57A-S1 ²⁾

1) The input torque must not exceed the max. permissible transferable torque of the axial kit.

2) With degree of protection IP65

Festo core product range



Generally ready for dispatch from the factory within 24 hours

Generally ready for dispatch from the factory within 5 days

Accessories

Data sheets → Internet: eamm-a

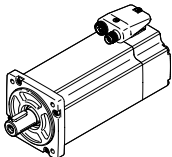
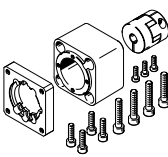
Permissible axis/motor combinations with axial kit		
Motor/gear unit ¹⁾	Axial kit	
		<ul style="list-style-type: none"> Kits for third-party motors → Internet: eamm-a
Type	Part no.	Type
ESBF-32		
With stepper motor and gear unit		
EMMS-ST-42-...	1454238	EAMM-A-D32-40G
EMGA-40-P-G...-SST-42	2256396	EAMM-A-D32-40G-S1 ²⁾
EMMS-ST-57-...	2946758	EAMM-A-D32-60G
EMGA-60-P-G...-SST-57	2946759	EAMM-A-D32-60G-S1 ²⁾
With integrated drive		
EMCA-EC-67-...	1454239	EAMM-A-D32-67A
	2256397	EAMM-A-D32-67A-S1 ²⁾
With integrated drive and gear unit		
EMCA-EC-67-...	1454238	EAMM-A-D32-40G
EMGC-40-...	2256396	EAMM-A-D32-40G-S1 ²⁾
EMCA-EC-67-...	2946760	EAMM-A-D32-60H
EMGC-60-...	2946761	EAMM-A-D32-60H-S1 ²⁾
ESBF-40		
With servo motor		
EMMT-AS-60-..., EMME-AS-60-...	★ 1977000	EAMM-A-D40-60P
	2151519	EAMM-A-D40-60P-S1 ²⁾
With servo motor and gear unit		
EMME-AS-40-...	★ 560282	EAMM-A-D40-40G
EMGA-40-P-G...-EAS-40	2256398	EAMM-A-D40-40G-G2 ³⁾
	2256399	EAMM-A-D40-40G-S1 ²⁾
EMMT-AS-60-..., EMME-AS-60-...	1454242	EAMM-A-D40-60H
EMGA-60-P-G...-EAS-60	2256401	EAMM-A-D40-60H-S1 ²⁾

1) The input torque must not exceed the max. permissible transferable torque of the axial kit.

2) With degree of protection IP65

3) The axial kit can be retrofitted from IP40 to IP65 with the help of a seal set EADS-F → page 66.

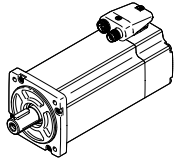
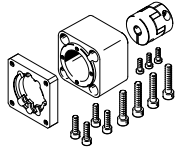

Accessories

Permissible axis/motor combinations with axial kit		Data sheets → Internet: eamm-a
Motor/gear unit ¹⁾	Axial kit	
		• Kits for third-party motors → Internet: eamm-a
Type	Part no.	Type
ESBF-40		
With stepper motor		
EMMS-ST-57-...	★ 543154	EAMM-A-D40-57A
	1322183	EAMM-A-D40-57A-S1 ²⁾
EMMS-ST-87-...	★ 550982	EAMM-A-D40-87A
	1322186	EAMM-A-D40-87A-S1 ²⁾
With stepper motor and gear unit		
EMMS-ST-42-... EMGA-40-P-G...-SST-42	★ 560282	EAMM-A-D40-40G
	2256398	EAMM-A-D40-40G-G2 ³⁾
	2256399	EAMM-A-D40-40G-S1 ²⁾
EMMS-ST-57-... EMGA-60-P-G...-SST-57	2256400	EAMM-A-D40-60G
	2256409	EAMM-A-D40-60G-S1 ²⁾
With integrated drive		
EMCA-EC-67-...	1454243	EAMM-A-D40-67A
	2256695	EAMM-A-D40-67A-S1 ²⁾
With integrated drive and gear unit		
EMCA-EC-67-... EMGC-40-...	★ 560282	EAMM-A-D40-40G
	2256398	EAMM-A-D40-40G-G2 ³⁾
	2256399	EAMM-A-D40-40G-S1 ²⁾
EMCA-EC-67-... EMGC-60-...	1454242	EAMM-A-D40-60H
	2256401	EAMM-A-D40-60H-S1 ²⁾

1) The input torque must not exceed the max. permissible transferable torque of the axial kit.

2) With degree of protection IP65

3) The axial kit can be retrofitted from IP40 to IP65 with the help of a seal set EADS-F → page 66.

Festo core product range



Generally ready for dispatch from the factory within 24 hours



Generally ready for dispatch from the factory within 5 days

Accessories

Data sheets → Internet: eamm-a

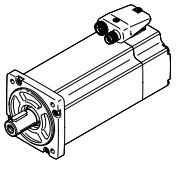
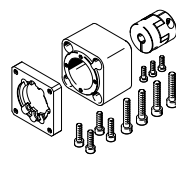
Permissible axis/motor combinations with axial kit			
Motor/gear unit ¹⁾	Axial kit		
		• Kits for third-party motors → Internet: eamm-a	
Type	Part no.	Type	
ESBF-50			
With servo motor			
EMMT-AS-80-..., EMME-AS-80-...	★ 2733785	EAMM-A-D50-80P	
	2734289	EAMM-A-D50-80P-S1 ²⁾	
EMMT-AS-100-..., EMME-AS-100-...	★ 2733784	EAMM-A-D50-100A	
	2734288	EAMM-A-D50-100A-S1 ²⁾	
With servo motor and gear unit			
EMMT-AS-60-..., EMME-AS-60-...	2733796	EAMM-A-D50-60H	
	2907418	EAMM-A-D50-60H-S1 ²⁾	
EMMT-AS-80-..., EMME-AS-80-...	2733787	EAMM-A-D50-80G	
	2734291	EAMM-A-D50-80G-S1 ²⁾	
EMMT-AS-100-..., EMME-AS-100-...	2733787	EAMM-A-D50-80G	
	2734291	EAMM-A-D50-80G-S1 ²⁾	

1) The input torque must not exceed the max. permissible transferable torque of the axial kit.

2) With degree of protection IP65

3) The axial kit can be retrofitted from IP40 to IP65 with the help of a seal set EADS-F → page 66.

Festo core product range



Generally ready for dispatch from the factory within 24 hours

Generally ready for dispatch from the factory within 5 days

Accessories

Data sheets → Internet: eamm-a

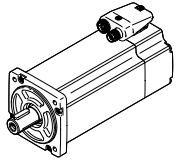
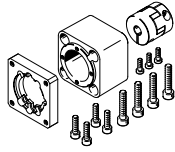
Permissible axis/motor combinations with axial kit		
Motor/gear unit ¹⁾	Axial kit	
		• Kits for third-party motors → Internet: eamm-a
Type	Part no.	Type
ESBF-50		
With stepper motor		
EMMS-ST-87-...	★ 2733781	EAMM-A-D50-87A
	2734286	EAMM-A-D50-87A-S1 ²⁾
With stepper motor and gear unit		
EMMS-ST-57-...	2733786	EAMM-A-D50-60G
EMGA-60-P-G...-SST-57	2734290	EAMM-A-D50-60G-S1 ²⁾
EMMS-ST-87-...	2733787	EAMM-A-D50-80G
EMGA-80-P-G...-SST-87	2734291	EAMM-A-D50-80G-S1 ²⁾
With integrated drive and gear unit		
EMCA-EC-67-...	2733796	EAMM-A-D50-60H
EMGC-60-...	2907418	EAMM-A-D50-60H-S1 ²⁾
ESBF-63		
With servo motor		
EMMT-AS-80-..., EMME-AS-80-...	★ 1977073	EAMM-A-D60-80P
	2218564	EAMM-A-D60-80P-S1 ²⁾
EMMT-AS-100-..., EMME-AS-100-...	★ 550983	EAMM-A-D60-100A
	2256700	EAMM-A-D60-100A-S1 ²⁾
With servo motor and gear unit		
EMMT-AS-60-..., EMME-AS-60-...	1454245	EAMM-A-D60-60H
EMGA-60-P-G...-EAS-60	2256697	EAMM-A-D60-60H-S1 ²⁾
EMMT-AS-80-..., EMME-AS-80-...	1499402	EAMM-A-D60-80G
EMGA-80-P-G...-EAS-80	2946762	EAMM-A-D60-80G-S1 ²⁾
EMMT-AS-100-..., EMME-AS-100-...	1499402	EAMM-A-D60-80G
EMGA-80-P-G...-SAS-100	2946762	EAMM-A-D60-80G-S1 ²⁾

1) The input torque must not exceed the max. permissible transferable torque of the axial kit.

2) With degree of protection IP65

3) The axial kit can be retrofitted from IP40 to IP65 with the help of a seal set EADS-F → page 66.



Accessories

Data sheets → Internet: eamm-a

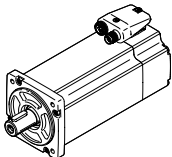
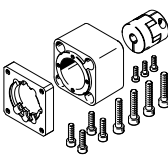
Permissible axis/motor combinations with axial kit			
Motor/gear unit ¹⁾	Axial kit		
		• Kits for third-party motors → Internet: eamm-a	
Type	Part no.	Type	
ESBF-63			
With stepper motor			
EMMS-ST-87-...	★ 543162	EAMM-A-D60-87A	
	1322188	EAMM-A-D60-87A-S1 ²⁾	
With stepper motor and gear unit			
EMMS-ST-57-...	★ 560283	EAMM-A-D60-60G	
EMGA-60-P-G...-SST-57	2256696	EAMM-A-D60-60G-G2 ³⁾	
	2256698	EAMM-A-D60-60G-S1 ²⁾	
EMMS-ST-87-...	1499402	EAMM-A-D60-80G	
EMGA-80-P-G...-SST-87	2946762	EAMM-A-D60-80G-S1 ²⁾	
With integrated drive and gear unit			
EMCA-EC-67-...	1454245	EAMM-A-D60-60H	
EMGC-60-...	2256697	EAMM-A-D60-60H-S1 ²⁾	
ESBF-80			
With servo motor			
EMMT-AS-100-..., EMME-AS-100-...	1589665	EAMM-A-D80-100A	
	1600673	EAMM-A-D80-100A-S1 ²⁾	
EMMS-AS-140-...	1588299	EAMM-A-D80-140A	
	1600674	EAMM-A-D80-140A-S1 ²⁾	
With servo motor and gear unit			
EMMT-AS-80-..., EMME-AS-80-...	2946763	EAMM-A-D80-80G	
EMGA-80-P-G...-EAS-80	2946764	EAMM-A-D80-80G-S1 ²⁾	
EMMT-AS-100-..., EMME-AS-100-...	2946763	EAMM-A-D80-80G	
EMGA-80-P-G...-SAS-100	2946764	EAMM-A-D80-80G-S1 ²⁾	

1) The input torque must not exceed the max. permissible transferable torque of the axial kit.

2) With degree of protection IP65

3) The axial kit can be retrofitted from IP40 to IP65 with the help of a seal set EADS-F → page 66.

Festo core product range



Generally ready for dispatch from the factory within 24 hours



Generally ready for dispatch from the factory within 5 days

Accessories

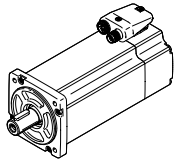
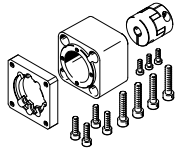
Permissible axis/motor combinations with axial kit		Data sheets → Internet: eamm-a
Motor/gear unit ¹⁾	Axial kit	
		<ul style="list-style-type: none"> Kits for third-party motors → Internet: eamm-a
Type	Part no.	Type
ESBF-80		
With stepper motor and gear unit		
EMMS-ST-87-...	2946763	EAMM-A-D80-80G
EMGA-80-P-G...-SST-87	2946764	EAMM-A-D80-80G-S1 ²⁾
ESBF-100		
With servo motor		
EMMT-AS-100-..., EMME-AS-100-...	3356796	EAMM-A-D100-100A
	3356931	EAMM-A-D100-100A-S1 ²⁾
EMMS-AS-140-...	1588349	EAMM-A-D100-140A
	1600675	EAMM-A-D100-140A-S1 ²⁾
With servo motor and gear unit		
EMMT-AS-100-..., EMME-AS-100-...	2449341	EAMM-A-D100-120G
EMGA-120-P-G...-SAS-100	2946765	EAMM-A-D100-120G-S1 ²⁾
EMMS-AS-140-...	2449341	EAMM-A-D100-120G
EMGA-120-P-G...-SAS-140	2946765	EAMM-A-D100-120G-S1 ²⁾

1) The input torque must not exceed the max. permissible transferable torque of the axial kit.

2) With degree of protection IP65

Accessories

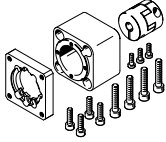
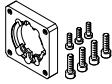
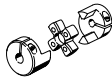
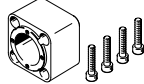
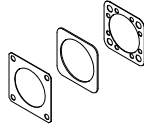
Individual components of the axial kit				
Axial kit	Comprising:			
	Motor flange	Coupling	Coupling housing	Seal set
				
Part no. Type	Part no. Type	Part no. Type	Part no. Type	Part no. Type
ESBF-32				
543147 EAMM-A-D32-40A	552163 EAMF-A-28B-40A	543420 EAMC-16-20-6-6	552155 EAMK-A-D32-28B	-
1322178 EAMM-A-D32-40A-S1				1561526 EADS-F-D32-40A
1454238 EAMM-A-D32-40G	1460095 EAMF-A-44C-40G-S1	562681 EAMC-30-32-6-10	551006 EAMK-A-D32-44A/C	-
2256396 EAMM-A-D32-40G-S1				2253500 EADS-F-D32-40G
★ 1976465 EAMM-A-D32-40P	1976704 EAMF-A-28B-40P	1232854 EAMC-16-20-6-8	552155 EAMK-A-D32-28B	-
2207372 EAMM-A-D32-40P-S1				2207219 EADS-F-D32-40P
★ 543148 EAMM-A-D32-42A	552164 EAMF-A-28B-42A	543419 EAMC-16-20-5-6	552155 EAMK-A-D32-28B	-
1322179 EAMM-A-D32-42A-S1				1561527 EADS-F-D32-42A
550979 EAMM-A-D32-55A	529942 EAMF-A-44A/B-55A	551003 EAMC-30-32-6-9	551006 EAMK-A-D32-44A/C	-
1322180 EAMM-A-D32-55A-S1				1561528 EADS-F-D32-55A
★ 550980 EAMM-A-D32-57A	530081 EAMF-A-44A/B-57A	551002 EAMC-30-32-6-6.35	551006 EAMK-A-D32-44A/C	-
1322181 EAMM-A-D32-57A-S1				1561529 EADS-F-D32-57A
2946758 EAMM-A-D32-60G	1460105 EAMF-A-44C-60G/H-S1	3187577 EAMC-30-32-6-11	551006 EAMK-A-D32-44A/C	-
2946759 EAMM-A-D32-60G-S1				8022150 EADS-F-D32-60G/H
2946760 EAMM-A-D32-60H	1460105 EAMF-A-44C-60G/H-S1	1233256 EAMC-30-32-6-14	551006 EAMK-A-D32-44A/C	-
2946761 EAMM-A-D32-60H-S1				8022150 EADS-F-D32-60G/H
★ 1956054 EAMM-A-D32-60P	1956846 EAMF-A-44C-60P	1233256 EAMC-30-32-6-14	551006 EAMK-A-D32-44A/C	-
2234020 EAMM-A-D32-60P-S1				2234012 EADS-F-D32-60P
1454239 EAMM-A-D32-67A	1476305 EAMF-A-44A/B/C-67A-S1	551003 EAMC-30-32-6-9	551006 EAMK-A-D32-44A/C	-
2256397 EAMM-A-D32-67A-S1				2253501 EADS-F-D32-67A

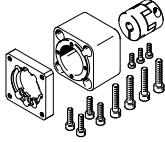
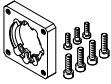
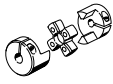
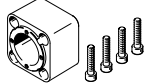
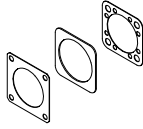

Accessories

Individual components of the axial kit				
Axial kit	Comprising:			
	Motor flange	Coupling	Coupling housing	Seal set
				
Part no. Type	Part no. Type	Part no. Type	Part no. Type	Part no. Type
ESBF-40				
★ 560282 EAMM-A-D40-40G	550986 EAMF-A-44A/B-40G	558029 EAMC-30-32-8-10	552157 EAMK-A-D40-44A/C	–
2256398 EAMM-A-D40-40G-G2	1460095 EAMF-A-44C-40G-S1			2253502 EADS-F-D40-40G
2256399 EAMM-A-D40-40G-S1				
543153 EAMM-A-D40-55A	529942 EAMF-A-44A/B-55A	543423 EAMC-30-32-8-9	552157 EAMK-A-D40-44A/C	–
1322182 EAMM-A-D40-55A-S1				1561530 EADS-F-D40-55A
★ 543154 EAMM-A-D40-57A	530081 EAMF-A-44A/B-57A	543421 EAMC-30-32-6.35-8	552157 EAMK-A-D40-44A/C	–
1322183 EAMM-A-D40-57A-S1				1561531 EADS-F-D40-57A
2256400 EAMM-A-D40-60G	1460105 EAMF-A-44C-60G/H-S1	551004 EAMC-30-32-8-11	552157 EAMK-A-D40-44A/C	–
2256409 EAMM-A-D40-60G-S1				2253503 EADS-F-D40-60G/H
1454242 EAMM-A-D40-60H	1460105 EAMF-A-44C-60G/H-S1	562682 EAMC-30-32-8-14	552157 EAMK-A-D40-44A/C	–
2256401 EAMM-A-D40-60H-S1				2253503 EADS-F-D40-60G/H
★ 1977000 EAMM-A-D40-60P	1956846 EAMF-A-44C-60P	562682 EAMC-30-32-8-14	552157 EAMK-A-D40-44A/C	–
2151519 EAMM-A-D40-60P-S1				2151545 EADS-F-D40-60P
1454243 EAMM-A-D40-67A	1476305 EAMF-A-44A/B/C-67A-S1	543423 EAMC-30-32-8-9	552157 EAMK-A-D40-44A/C	–
2256695 EAMM-A-D40-67A-S1				2253501 EADS-F-D32-67A
550981 EAMM-A-D40-70A	529943 EAMF-A-44A/B-70A	551004 EAMC-30-32-8-11	552157 EAMK-A-D40-44A/C	–
1322185 EAMM-A-D40-70A-S1				1561532 EADS-F-D40-70A
★ 550982 EAMM-A-D40-87A	530082 EAMF-A-44A/B-87A	551004 EAMC-30-32-8-11	552157 EAMK-A-D40-44A/C	–
1322186 EAMM-A-D40-87A-S1				1561533 EADS-F-D40-87A

Festo core product range

- ★ Generally ready for dispatch from the factory within 24 hours
- ★ Generally ready for dispatch from the factory within 5 days

Accessories

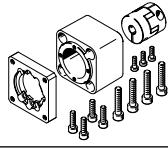
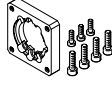
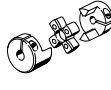
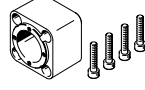
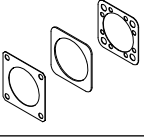
Individual components of the axial kit				
Axial kit	Comprising:			
	Motor flange	Coupling	Coupling housing	Seal set
				
Part no. Type	Part no. Type	Part no. Type	Part no. Type	Part no. Type
ESBF-50				
2733786 EAMM-A-D50-60G	2256289 EAMF-A-64B-60G/H-S1	543424 EAMC-42-50-11-12	2733780 EAMK-A-D50-64B	-
2734290 EAMM-A-D50-60G-S1				2733792 EADS-F-D50-60G/H
2733796 EAMM-A-D50-60H	2256289 EAMF-A-64B-60G/H-S1	1455671 EAMC-42-50-12-14	2733780 EAMK-A-D50-64B	-
2907418 EAMM-A-D50-60H-S1				2733792 EADS-F-D50-60G/H
2733783 EAMM-A-D50-70A	529945 EAMF-A-64A/B-70A	543424 EAMC-42-50-11-12	2733780 EAMK-A-D50-64B	-
2734287 EAMM-A-D50-70A-S1				2733789 EADS-F-D50-70A
2733787 EAMM-A-D50-80G	2843290 EAMF-A-64C-80G-S1	2138701 EAMC-42-50-12-20	2836865 EAMK-A-D50-64C	-
2734291 EAMM-A-D50-80G-S1				2733793 EADS-F-D50-80G
★ 2733785 EAMM-A-D50-80P	1977113 EAMF-A-64A/C-80P	551005 EAMC-42-50-12-19	2836865 EAMK-A-D50-64C	-
2734289 EAMM-A-D50-80P-S1				2733791 EADS-F-D50-80P
★ 2733781 EAMM-A-D50-87A	533140 EAMF-A-64A/B-87A	543424 EAMC-42-50-11-12	2733780 EAMK-A-D50-64B	-
2734286 EAMM-A-D50-87A-S1				2733788 EADS-F-D50-87A
★ 2733784 EAMM-A-D50-100A	529947 EAMF-A-64A/C/D-100A	551005 EAMC-42-50-12-19	2836865 EAMK-A-D50-64C	-
2734288 EAMM-A-D50-100A-S1				2733790 EADS-F-D50-100A
ESBF-63				
★ 560283 EAMM-A-D60-60G	550987 EAMF-A-64A/B-60G/H	543424 EAMC-42-50-11-12	552160 EAMK-A-D60-64B	-
2256696 EAMM-A-D60-60G-G2	2256289 EAMF-A-64B-60G/H-S1			2253505 EADS-F-D60-60G/H
2256698 EAMM-A-D60-60G-S1				
1454245 EAMM-A-D60-60H	2256289 EAMF-A-64B-60G/H-S1	1455671 EAMC-42-50-12-14	552160 EAMK-A-D60-64B	-
2256697 EAMM-A-D60-60H-S1				2253505 EADS-F-D60-60G/H
543161 EAMM-A-D60-70A	529945 EAMF-A-64A/B-70A	543424 EAMC-42-50-11-12	552160 EAMK-A-D60-64B	-
2256699 EAMM-A-D60-70A-S1				8022145 EADS-F-D60-70A

Festo core product range



Generally ready for dispatch from the factory within 24 hours

Generally ready for dispatch from the factory within 5 days

Accessories

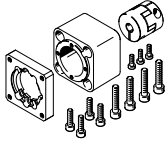
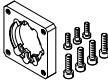
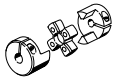
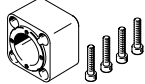
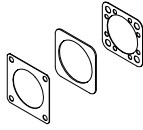
Individual components of the axial kit				
Axial kit	Comprising:			
	Motor flange	Coupling	Coupling housing	Seal set
				
Part no. Type	Part no. Type	Part no. Type	Part no. Type	Part no. Type
ESBF-63				
1499402 EAMM-A-D60-80G	2843290 EAMF-A-64C-80G-S1	2138701 EAMC-42-50-12-20	551007 EAMK-A-D60-64C	–
2946762 EAMM-A-D60-80G-S1				8022146 EADS-F-D60-80G
★ 1977073 EAMM-A-D60-80P	1977113 EAMF-A-64A/C-80P	551005 EAMC-42-50-12-19	551007 EAMK-A-D60-64C	–
2218564 EAMM-A-D60-80P-S1				2218523 EADS-F-D60-80P
★ 543162 EAMM-A-D60-87A	533140 EAMF-A-64A/B-87A	543424 EAMC-42-50-11-12	552160 EAMK-A-D60-64B	–
1322188 EAMM-A-D60-87A-S1				1561536 EADS-F-D60-87A
★ 550983 EAMM-A-D60-100A	529947 EAMF-A-64A/C/D-100A	551005 EAMC-42-50-12-19	551007 EAMK-A-D60-64C	–
2256700 EAMM-A-D60-100A-S1				2253507 EADS-F-D60-100A
ESBF-80				
2946763 EAMM-A-D80-80G	2933286 EAMF-A-77A-80G-S1	3181801 EAMC-56-58-19-20	1593627 EAMK-A-D80-77A	–
2946764 EAMM-A-D80-80G-S1				8022147 EADS-F-D80-80G
1589665 EAMM-A-D80-100A	1593628 EAMF-A-77A-100A	1485673 EAMC-56-58-19-19	1593627 EAMK-A-D80-77A	–
1600673 EAMM-A-D80-100A-S1				1593617 EADS-F-D80-100A
1588299 EAMM-A-D80-140A	1593636 EAMF-A-77A-140A	1485674 EAMC-56-58-19-24	1593627 EAMK-A-D80-77A	–
1600674 EAMM-A-D80-140A-S1				1593671 EADS-F-D80-140A
ESBF-100				
1588349 EAMM-A-D100-140A	1593636 EAMF-A-77A-140A	1451407 EAMC-67-62-24-24	1593914 EAMK-A-D100-77A/B	–
1600675 EAMM-A-D100-140A-S1				1593991 EADS-F-D100-140A
3356796 EAMM-A-D100-100A	1593628 EAMF-A-77A-100A	1485674 EAMC-56-58-19-24	1593914 EAMK-A-D100-77A/B	–
3356931 EAMM-A-D100-100A-S1				3356966 EADS-F-D100-100A
2449341 EAMM-A-D100-120G	2449380 EAMF-A-77B-120G-S1	3187895 EAMC-67-62-24-25	1593914 EAMK-A-D100-77A/B	–
2946765 EAMM-A-D100-120G-S1				8022148 EADS-F-D100-120G

Festo core product range

- ★ Generally ready for dispatch from the factory within 24 hours
- ★ Generally ready for dispatch from the factory within 5 days

Accessories

Data sheets → Internet: eamm-u

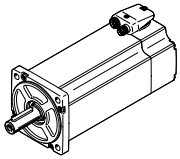
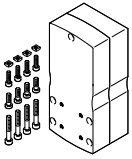
Permissible axis/motor combinations with parallel kit		
Motor/gear unit ¹⁾	Parallel kit	
		<ul style="list-style-type: none"> The kit can be mounted in all directions Optionally with degree of protection IP65 Kits for third-party motors → Internet: eamm-u
Type	Part no.	Type
ESBF-32		
With servo motor		
EMME-AS-40-...	★ 2153283	EAMM-U-50-D32-40P-78
	2154009	EAMM-U-50-D32-40P-78-S1 ²⁾
EMMT-AS-60-..., EMME-AS-60-...	★ 2619586	EAMM-U-70-D32-60P-96
	2619688	EAMM-U-70-D32-60P-96-S1 ²⁾
With stepper motor		
EMMS-ST-42-...	★ 1201607	EAMM-U-50-D32-42A-78
	1202312	EAMM-U-50-D32-42A-78-S1 ²⁾
EMMS-ST-57-...	★ 1210419	EAMM-U-60-D32-57A-91
	1210453	EAMM-U-60-D32-57A-91-S1 ²⁾
With integrated drive		
EMCA-EC-67-...	1577063	EAMM-U-60-D32-67A-91
	1529422	EAMM-U-60-D32-67A-91-S1
With servo motor and gear unit		
EMME-AS-40-...	1577358	EAMM-U-60-D32-40G-91
EMGA-40-P-...	1577346	EAMM-U-60-D32-40G-91-S1 ²⁾
EMMT-AS-60-..., EMME-AS-60-...	2778393	EAMM-U-70-D32-60H-96
EMGA-60-P-...-EAS ³⁾	2781450	EAMM-U-70-D32-60H-96-S1 ²⁾
With stepper motor and gear unit		
EMMS-ST-42-...	1577358	EAMM-U-60-D32-40G-91
EMGA-40-P-...-SST	1577346	EAMM-U-60-D32-40G-91-S1 ²⁾
EMMS-ST-57-...	2748181	EAMM-U-70-D32-60G-96
EMGA-60-P-...-SST ³⁾	2778302	EAMM-U-70-D32-60G-96-S1 ²⁾
With integrated drive and gear unit		
EMCA-EC-67-...	1577358	EAMM-U-60-D32-40G-91
EMGC-40-P-...	1577346	EAMM-U-60-D32-40G-91-S1 ²⁾
EMCA-EC-67-...	2778393	EAMM-U-70-D32-60H-96
EMGC-60-P-... ³⁾	2781450	EAMM-U-70-D32-60H-96-S1 ²⁾



1) The input torque must not exceed the max. permissible transferable torque of the parallel kit.
 2) With degree of protection IP65
 3) Gear unit drive shaft diameter: EMGA-60-P-...-SAS/-SST: 11 mm; EMGA-60-P-...-EAS, EMGC-60-P: 14 mm.

Festo core product range

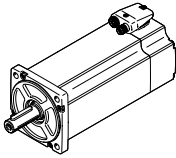

Generally ready for dispatch from the factory within 24 hours
 Generally ready for dispatch from the factory within 5 days

Accessories

Permissible axis/motor combinations with parallel kit			Data sheets → Internet: eamm-u
Motor/gear unit ¹⁾	Parallel kit		
			<ul style="list-style-type: none"> The kit can be mounted in all directions Optionally with degree of protection IP65 Kits for third-party motors → Internet: eamm-u
Type	Part no.	Type	
ESBF-40			
With servo motor			
EMMT-AS-60-..., EMME-AS-60-...	★ 2617488	EAMM-U-70-D40-60P-96	
	2546123	EAMM-U-70-D40-60P-96-S1 ²⁾	
EMMT-AS-80-..., EMME-AS-80-...	★ 2802441	EAMM-U-86-D40-80P-102	
	2802656	EAMM-U-86-D40-80P-102-S1 ²⁾	
With stepper motor			
EMMS-ST-57-...	★ 1210442	EAMM-U-60-D40-57A-91	
	1210462	EAMM-U-60-D40-57A-91-S1 ²⁾	
EMMS-ST-87-...	★ 1215802	EAMM-U-86-D40-87A-102	
	1215814	EAMM-U-86-D40-87A-102-S1 ²⁾	
With integrated drive			
EMCA-EC-67-...	1577083	EAMM-U-60-D40-67A-91	
	1435249	EAMM-U-60-D40-67A-91-S1	
With servo motor and gear unit			
EMME-AS-40-...	1577165	EAMM-U-60-D40-40G-91	
EMGA-40-P-...	1435968	EAMM-U-60-D40-40G-91-S1 ²⁾	
EMMT-AS-60-..., EMME-AS-60-...	2786101	EAMM-U-70-D40-60H-96	
EMGA-60-P-...-EAS ³⁾	2786137	EAMM-U-70-D40-60H-96-S1 ²⁾	
	1586496	EAMM-U-86-D40-60H-102	
	1586372	EAMM-U-86-D40-60H-102-S1 ²⁾	
With stepper motor and gear unit			
EMMS-ST-42-...	1577165	EAMM-U-60-D40-40G-91	
EMGA-40-P-...-SST	1435968	EAMM-U-60-D40-40G-91-S1 ²⁾	
EMMS-ST-57-...	2785471	EAMM-U-70-D40-60G-96	
EMGA-60-P-...-SST ³⁾	2785542	EAMM-U-70-D40-60G-96-S1 ²⁾	
	1586445	EAMM-U-86-D40-60G-102	
	1586429	EAMM-U-86-D40-60G-102-S1 ²⁾	
With integrated drive and gear unit			
EMCA-EC-67-...	1577165	EAMM-U-60-D40-40G-91	
EMGC-40-P-...	1435968	EAMM-U-60-D40-40G-91-S1 ²⁾	
EMCA-EC-67-...	2786101	EAMM-U-70-D40-60H-96	
EMGC-60-P-... ³⁾	2786137	EAMM-U-70-D40-60H-96-S1 ²⁾	
	1586496	EAMM-U-86-D40-60H-102	
	1586372	EAMM-U-86-D40-60H-102-S1 ²⁾	

1) The input torque must not exceed the max. permissible transferable torque of the parallel kit.

2) With degree of protection IP65

3) Gear unit drive shaft diameter: EMGA-60-P-...-SAS/-SST: 11 mm; EMGA-60-P-...-EAS, EMGC-60-P: 14 mm.

Festo core product range



Generally ready for dispatch from the factory within 24 hours

Generally ready for dispatch from the factory within 5 days

Accessories

Data sheets → Internet: eamm-u

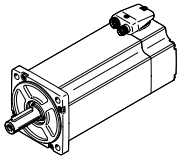
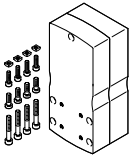
Permissible axis/motor combinations with parallel kit		
Motor/gear unit ¹⁾	Parallel kit	
		<ul style="list-style-type: none"> The kit can be mounted in all directions Optionally with degree of protection IP65 Kits for third-party motors → Internet: eamm-u
Type	Part no.	Type
ESBF-50		
With servo motor		
EMMT-AS-80-..., EMME-AS-80-...	★ 2803053	EAMM-U-86-D50-80P-102
	2803073	EAMM-U-86-D50-80P-102-S1 ²⁾
EMMT-AS-100-..., EMME-AS-100-...	★ 2799424	EAMM-U-110-D50-100A-120
	2799488	EAMM-U-110-D50-100A-120-S1 ²⁾
With stepper motor		
EMMS-ST-87-...	★ 2802708	EAMM-U-86-D50-87A-102
	2802742	EAMM-U-86-D50-87A-102-S1 ²⁾
With servo motor and gear unit		
EMMT-AS-60-..., EMME-AS-60-... EMGA-60-P-...-EAS ³⁾	2803326	EAMM-U-86-D50-60H-102
	2803325	EAMM-U-86-D50-60H-102-S1 ²⁾
	2798760	EAMM-U-110-D50-60H-120
	2799150	EAMM-U-110-D50-60H-120-S1 ²⁾
EMMT-AS-80-..., EMMT-AS-100-... EMME-AS-80-..., EMME-AS-100-... EMGA-80-P-...	2799196	EAMM-U-110-D50-80G-120
	2799281	EAMM-U-110-D50-80G-120-S1 ²⁾
With stepper motor and gear unit		
EMMS-ST-57-... EMGA-60-P-...-SST ³⁾	2803125	EAMM-U-86-D50-60G-102
	2803197	EAMM-U-86-D50-60G-102-S1 ²⁾
	2797368	EAMM-U-110-D50-60G-120
	2798665	EAMM-U-110-D50-60G-120-S1 ²⁾
EMMS-ST-87-... EMGA-80-P-...-SST	2799196	EAMM-U-110-D50-80G-120
	2799281	EAMM-U-110-D50-80G-120-S1 ²⁾
With integrated drive and gear unit		
EMCA-EC-67-... EMGC-60-P-... ³⁾	2803326	EAMM-U-86-D50-60H-102
	2803325	EAMM-U-86-D50-60H-102-S1 ²⁾
	2798760	EAMM-U-110-D50-60H-120
	2799150	EAMM-U-110-D50-60H-120-S1 ²⁾

1) The input torque must not exceed the max. permissible transferable torque of the parallel kit.

2) With degree of protection IP65

3) Gear unit drive shaft diameter: EMGA-60-P-...-SAS/-SST: 11 mm; EMGA-60-P-...-EAS, EMGC-60-P: 14 mm.

Note

The clamping element EADT is required to adjust the toothed belt pretensioning for EAMM-U-110.

The motor and/or axis shaft can optionally be supported with a counter bearing EAMG.

Additional information → eamm-u

Festo core product range





Generally ready for dispatch from the factory within 24 hours



Generally ready for dispatch from the factory within 5 days

Accessories

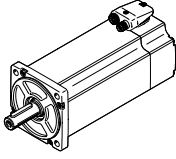
Data sheets → Internet: eamm-u

Permissible axis/motor combinations with parallel kit		
Motor/gear unit ¹⁾	Parallel kit	
		<ul style="list-style-type: none"> The kit can be mounted in all directions Optionally with degree of protection IP65 Kits for third-party motors → Internet: eamm-u
Type	Part no.	Type
ESBF-63		
With servo motor		
EMMT-AS-80-..., EMME-AS-80-...	★ 2155875	EAMM-U-86-D60-80P-102
	2156527	EAMM-U-86-D60-80P-102-S1 ²⁾
EMMT-AS-100-..., EMME-AS-100-...	★ 1202436	EAMM-U-110-D60-100A-120
	1203112	EAMM-U-110-D60-100A-120-S1 ²⁾
With stepper motor		
EMMS-ST-87-...	★ 1215784	EAMM-U-86-D60-87A-102
	1215810	EAMM-U-86-D60-87A-102-S1 ²⁾
With servo motor and gear unit		
EMMT-AS-60-..., EMME-AS-60-... EMGA-60-P-...-EAS ³⁾	1586276	EAMM-U-86-D60-60H-102
	1530837	EAMM-U-86-D60-60H-102-S1 ²⁾
	1542264	EAMM-U-110-D60-60H-120
	1530621	EAMM-U-110-D60-60H-120-S1 ²⁾
EMMT-AS-80-..., EMMT-AS-100-... EMME-AS-80-..., EMME-AS-100-... EMGA-80-P-...	1532949	EAMM-U-110-D60-80G-120
	1530875	EAMM-U-110-D60-80G-120-S1 ²⁾
With stepper motor and gear unit		
EMMS-ST-57-... EMGA-60-P-...-SST ³⁾	1586347	EAMM-U-86-D60-60G-102
	1437163	EAMM-U-86-D60-60G-102-S1 ²⁾
	1543240	EAMM-U-110-D60-60G-120
	1436183	EAMM-U-110-D60-60G-120-S1 ²⁾
EMMS-ST-87-... EMGA-80-P-...-SST	1532949	EAMM-U-110-D60-80G-120
	1530875	EAMM-U-110-D60-80G-120-S1 ²⁾
With integrated drive and gear unit		
EMCA-EC-67-... EMGC-60-P-... ³⁾	1586276	EAMM-U-86-D60-60H-102
	1530837	EAMM-U-86-D60-60H-102-S1 ²⁾
	1542264	EAMM-U-110-D60-60H-120
	1530621	EAMM-U-110-D60-60H-120-S1 ²⁾

1) The input torque must not exceed the max. permissible transferable torque of the parallel kit.

2) With degree of protection IP65

3) Gear unit drive shaft diameter: EMGA-60-P-...SAS/SST: 11 mm; EMGA-60-P-...EAS, EMGC-60-P: 14 mm.

 **Note**

The clamping element EADT is required to adjust the toothed belt pretensioning for EAMM-U-110.

The motor and/or axis shaft can optionally be supported with a counter bearing EAMG.

Additional information → eamm-u

Festo core product range

- ★ Generally ready for dispatch from the factory within 24 hours
- ★ Generally ready for dispatch from the factory within 5 days

Accessories

Data sheets → Internet: eamm-u

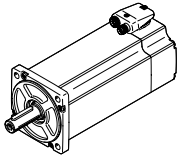
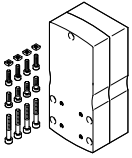
Permissible axis/motor combinations with parallel kit		
Motor/gear unit ¹⁾	Parallel kit	
		<ul style="list-style-type: none"> • The kit can be mounted in all directions • Optionally with degree of protection IP65 • Kits for third-party motors → Internet: eamm-u
Type	Part no.	Type
ESBF-80		
With servo motor		
EMMT-AS-100-..., EMME-AS-100-...	1465438	EAMM-U-110-D80-100A-120
	1433650	EAMM-U-110-D80-100A-120-S1 ²⁾
EMMS-AS-140-...	1465530	EAMM-U-145-D80-140A-188
	1433709	EAMM-U-145-D80-140A-188-S1 ²⁾
With servo motor and gear unit		
EMMT-AS-80-..., EMMT-AS-100-...	1589614	EAMM-U-110-D80-80G-120
EMME-AS-80-..., EMME-AS-100-...	1589706	EAMM-U-110-D80-80G-120-S1 ²⁾
EMGA-80-P-...		
With stepper motor and gear unit		
EMMS-ST-87-...	1589614	EAMM-U-110-D80-80G-120
EMGA-80-P-...-SST	1589706	EAMM-U-110-D80-80G-120-S1 ²⁾
ESBF-100		
With servo motor		
EMMS-AS-140-...	1465541	EAMM-U-145-D100-140A-188
	1433852	EAMM-U-145-D100-140A-188-S1 ²⁾
With servo motor and gear unit		
EMMT-AS-100-..., EMME-AS-100-...	2803620	EAMM-U-145-D100-120G-188
EMMS-AS-140-...	2803622	EAMM-U-145-D100-120G-188-S1 ²⁾
EMGA-120-P-...		

- 1) The input torque must not exceed the max. permissible transferable torque of the parallel kit.
- 2) With degree of protection IP65
- 3) Gear unit drive shaft diameter: EMGA-60-P-...-SAS/-SST: 11 mm; EMGA-60-P-...-EAS, EMGC-60-P: 14 mm.

 **Note**

The clamping element EADT is required to adjust the toothed belt pretensioning for EAMM-U-110.

The motor and/or axis shaft can optionally be supported with a counter bearing EAMG.

Additional information → eamm-u

Accessories

Bellows kit EADB



General technical data		32	40	50	63	80
Type EADB-V2-						
Max. stroke range of the cylinder ¹⁾	[mm]	30 ... 500	30 ... 500	30 ... 500	30 ... 500	30 ... 500
Type of mounting		Push-on Via threaded pin				
Mounting position		Any				
Media resistance		Dust, chippings, oil, grease, fuel (→ Internet: media resistance)				
Ambient temperature ²⁾	[°C]	-10 ... +80				
Degree of protection to IEC 60529		IP65				
Corrosion resistance class CRC ³⁾		3				

1) In combination with the bellows kit EADB

2) Note operating range of proximity sensors and cylinder

3) Corrosion resistance class CRC 3 to Festo standard FN 940070

High corrosion stress. Outdoor exposure under moderate corrosive conditions. Externally visible parts with primarily functional surface requirements which are in direct contact with a normal industrial environment.

Accessories

Materials

Sectional view

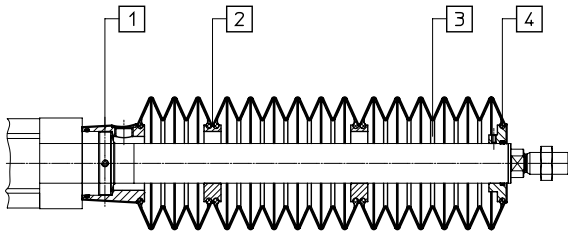

Bellows		
[1]	Connection	Anodised wrought aluminium alloy
[2]	Adapter	Polyamide
[3]	Bellows	NBR
[4]	End piece	Anodised wrought aluminium alloy
-	O-ring	NBR
Note on materials		RoHS-compliant

Weight [g]

Type EADB-V2-	32	40	50	63	80
Stroke [mm]					

Product weight

10 ... 100	116	109	190	203	269
101 ... 200	155	146	261	265	327
201 ... 300	173	164	306	307	365
301 ... 400	212	201	377	370	423
401 ... 500	233	222	402	391	444

Moving mass

10 ... 100	46	44	93	79	72
101 ... 200	85	82	164	142	130
201 ... 300	104	99	209	183	168
301 ... 400	143	137	280	246	226
401 ... 500	163	157	305	267	247

Accessories

Travel speed v as a function of tubing length l



The bellows kit is a leak-free system.

To prevent unwanted media from being drawn in, the supply and exhaust air must be ducted via a pressure compensation hole in the connection part [1].

The pressure generated in the bellows kit by the positioning motion is largely defined by the travel speed and tubing length. The recommended tubing length based on the travel speed of the drive can be read from the graph.

For size 32

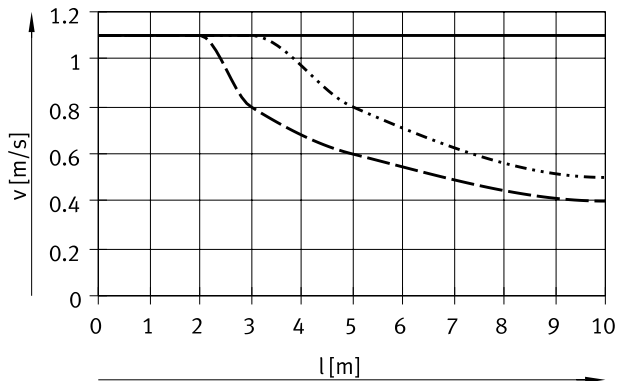

- With QS-G1/4-12, QSH-16-12, PUN-16x2.5P
- · - · - With QS-G1/4-12, PUN-12x2
- - - With QS-G1/4-10, PUN-10x1.5

For size 40

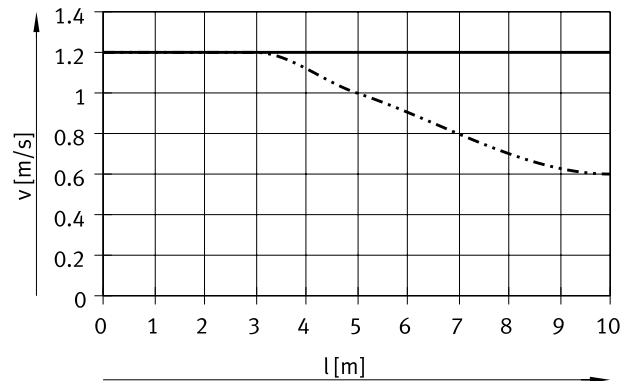

- With QS-G1/4-12, QSH-16-12, PUN-16x2.5
- · - · - With QS-G1/4-10, PUN-10x1.5P

For size 50

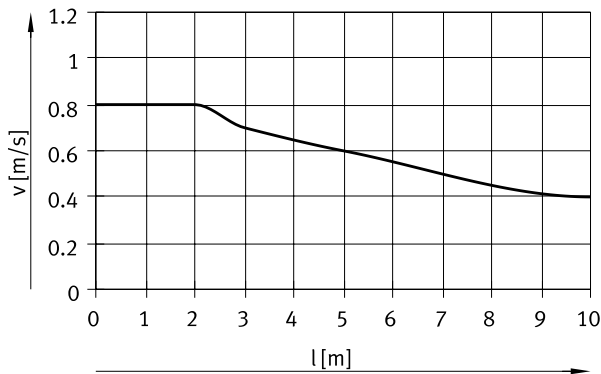

- With QS-G1/4-12, QSH-16-12, PUN-16x2.5

For size 63

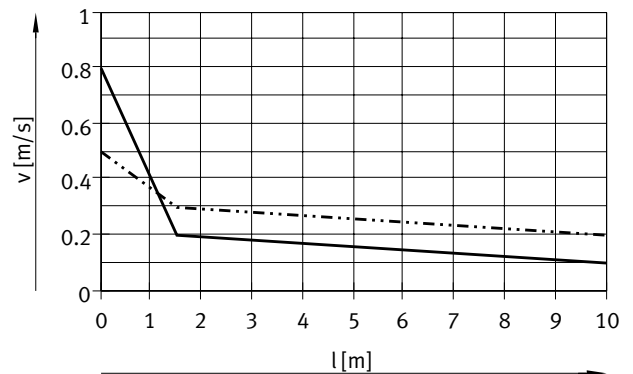

- With QS-G1/4-12, PUN-12x2
- · - · - With QS-G1/4-12, QSH-16-12, PUN-16x2.5

For size 80

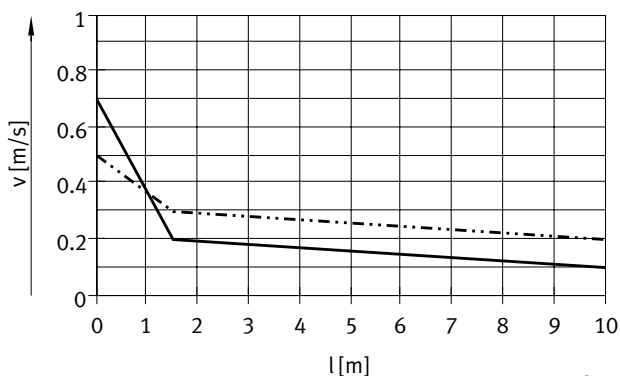

- With QS-G1/4-12, PUN-12x2
- · - · - With QS-G1/4-12, QSH-16-12, PUN-16x2.5

Accessories

Tubing size and push-in fitting for pressure compensation hole

The push-in fittings in the following table must be used for the pressure compensation hole.

Silencers can be used as an alternative. This reduces the travel speed slightly.

For size	Tubing O.D. [mm]	Push-in fitting		Push-in sleeve		Plastic tubing Type
		Part no.	Type	Part no.	Type	
32, 40, 50, 63, 80	16	★ 186350	QS-G1/4-12	153261	QSH-16-12	PUN-16x2.5
32, 63, 80	12	★ 186350	QS-G1/4-12	-		PUN-12x2
32, 40	10	★ 186101	QS-G1/4-10	-		PUN-10x1.5

Dimensions

Download CAD data → www.festo.com

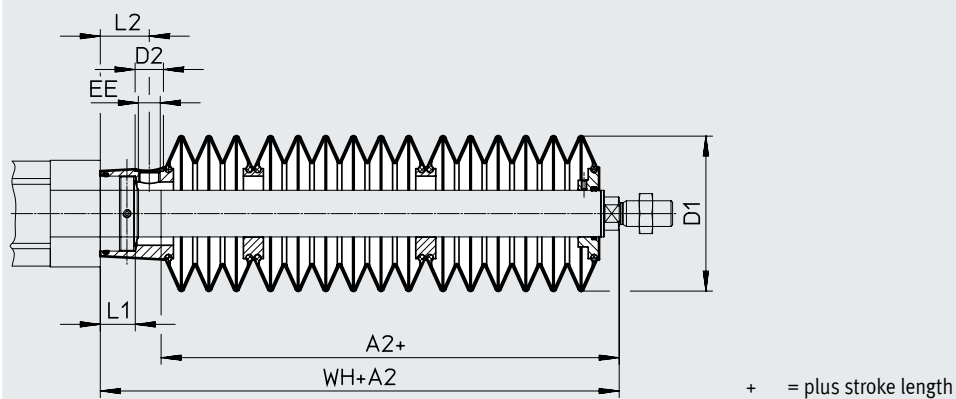

Size Stroke [mm]	32						
	A2 ¹⁾	D1 max.	D2	EE	L1	L2	WH+A2
10 ... 100	52	57	17	G1/4	15	23.3	77.5
101 ... 200	81						106.5
201 ... 300	92						117.5
301 ... 400	121						146.5
401 ... 500	139						164.5

Size Stroke [mm]	40						
	A2 ¹⁾	D1 max.	D2	EE	L1	L2	WH+A2
10 ... 100	50	57	17	G1/4	15	23.3	79.5
101 ... 200	79						108.5
201 ... 300	90						119.5
301 ... 400	119						148.5
401 ... 500	137						166.5

1) The dimension corresponds to the E value (piston rod extension) of the cylinder

Accessories

Size Stroke [mm]	50						
	A2 ¹⁾	D1 max.	D2	EE	L1	L2	WH+A2
10 ... 100	46	93	17	G1/4	21	29.4	82.5
101 ... 200	70						106.5
201 ... 300	82						118.5
301 ... 400	107						143.5
401 ... 500	119						155.5

Size Stroke [mm]	63						
	A2 ¹⁾	D1 max.	D2	EE	L1	L2	WH+A2
10 ... 100	45	93	17	G1/4	25	33.9	82
101 ... 200	70						107
201 ... 300	82						119
301 ... 400	106						143
401 ... 500	119						156

Size Stroke [mm]	80						
	A2 ¹⁾	D1 max.	D2	EE	L1	L2	WH+A2
10 ... 100	48	93	17	G1/4	31	42.9	94
101 ... 200	73						119
201 ... 300	85						131
301 ... 400	109						155
401 ... 500	122						168

1) The dimension corresponds to the E value (piston rod extension) of the cylinder

Accessories

Ordering data – Bellows kit

An extended piston rod (order code ...E) → page 26 is absolutely essential if a bellows kit is to be used.

The necessary dimensions for ...E as a function of cylinder size and stroke as well as the relevant bellows kit are indicated in the following table:

Order example:

Selected electric cylinder:

ESBF-BS-63-250-5P-...E

The dimension for the corresponding E value (see table):

82 mm

Complete type code for electric cylinder:

ESBF-BS-63-250-5P-82E

The corresponding bellows kit:

EADB-V2-63-S201-300

Cylinder data			Bellows kit	
Size	Stroke [mm]	Dimension for ...E [mm]	Part no.	Type
32	10 ... 100	52	2828829	EADB-V2-32-S10-100
	101 ... 200	81	2828830	EADB-V2-32-S101-200
	201 ... 300	92	2828831	EADB-V2-32-S201-300
	301 ... 400	121	2828832	EADB-V2-32-S301-400
	401 ... 500	139	2828833	EADB-V2-32-S401-500
40	10 ... 100	50	2828834	EADB-V2-40-S10-100
	101 ... 200	79	2828835	EADB-V2-40-S101-200
	201 ... 300	90	2828836	EADB-V2-40-S201-300
	301 ... 400	119	2828837	EADB-V2-40-S301-400
	401 ... 500	137	2828838	EADB-V2-40-S401-500
50	10 ... 100	46	2828839	EADB-V2-50-S10-100
	101 ... 200	70	2828840	EADB-V2-50-S101-200
	201 ... 300	82	2828841	EADB-V2-50-S201-300
	301 ... 400	107	2828842	EADB-V2-50-S301-400
	401 ... 500	119	2828843	EADB-V2-50-S401-500
63	10 ... 100	45	1488361	EADB-V2-63-S10-100
	101 ... 200	70	1488362	EADB-V2-63-S101-200
	201 ... 300	82	1488363	EADB-V2-63-S201-300
	301 ... 400	106	1488364	EADB-V2-63-S301-400
	401 ... 500	119	1488365	EADB-V2-63-S401-500
80	10 ... 100	48	1489406	EADB-V2-80-S10-100
	101 ... 200	73	1489407	EADB-V2-80-S101-200
	201 ... 300	85	1489408	EADB-V2-80-S201-300
	301 ... 400	109	1489409	EADB-V2-80-S301-400
	401 ... 500	122	1489410	EADB-V2-80-S401-500

Accessories

Profile mounting EAHF

Material:

RoHS-compliant

Plate: Anodised aluminium

Clamping piece: Coated steel

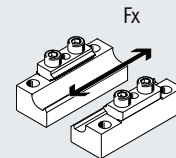
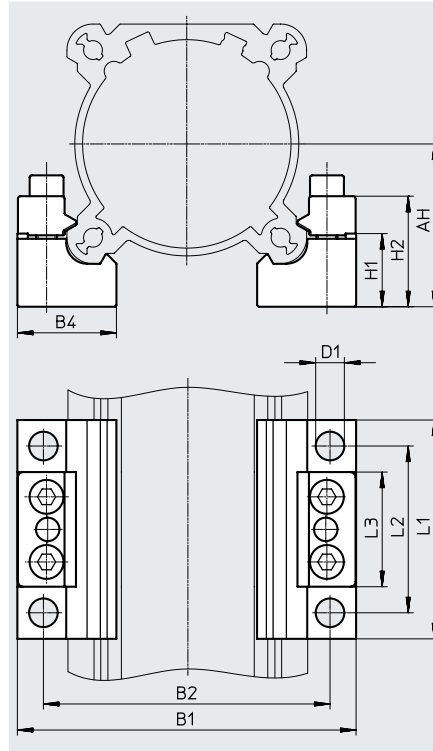
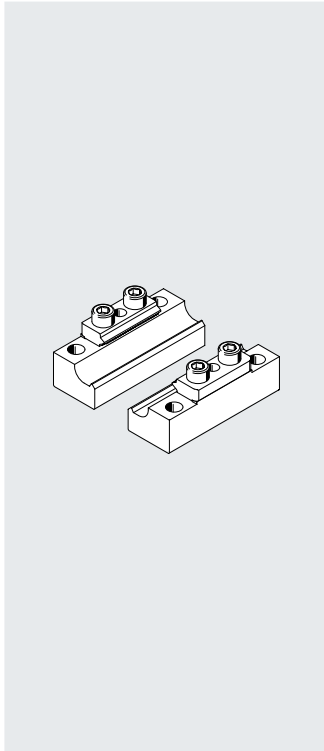

Dimensions and ordering data

For size	AH	B1	B2	B4	D1 ∅	H1	H2	L1	L2	L3
32	32	76	60	26	9	16	23.6	80	60	34
40	36	84.5	68	26	9	16	23.6	80	60	34
50	44.5	94	81	30	9	22.8	30.4	80	60	41
63	50	105	92	30	9	22.8	30.4	80	60	41
80	62.5	130	110	38	11	28.1	42.5	84	64	44
100	71	147	127	38	11	28.1	42.5	84	64	44

For size	Transferable axial force F_x [kN]	CRC ¹⁾	Weight [g]	Part no.	Type
32, 40	1.6	3	218	★ 2838839	EAHF-V2-32/40-P
50, 63	3.6	3	340	★ 1547781	EAHF-V2-50/63-P
80, 100	4.0	3	570	1547780	EAHF-V2-80/100-P

1) Corrosion resistance class CRC 3 to Festo standard FN 940070

High corrosion stress. Outdoor exposure under moderate corrosive conditions. Externally visible parts with primarily functional surface requirements which are in direct contact with a normal industrial environment.

Festo core product range



Generally ready for dispatch from the factory within 24 hours

Generally ready for dispatch from the factory within 5 days

Accessories

Foot mounting HNC/CRHNC, for parallel motor mounting

Material:
HNC: Galvanised steel

CRHNC: High-alloy steel

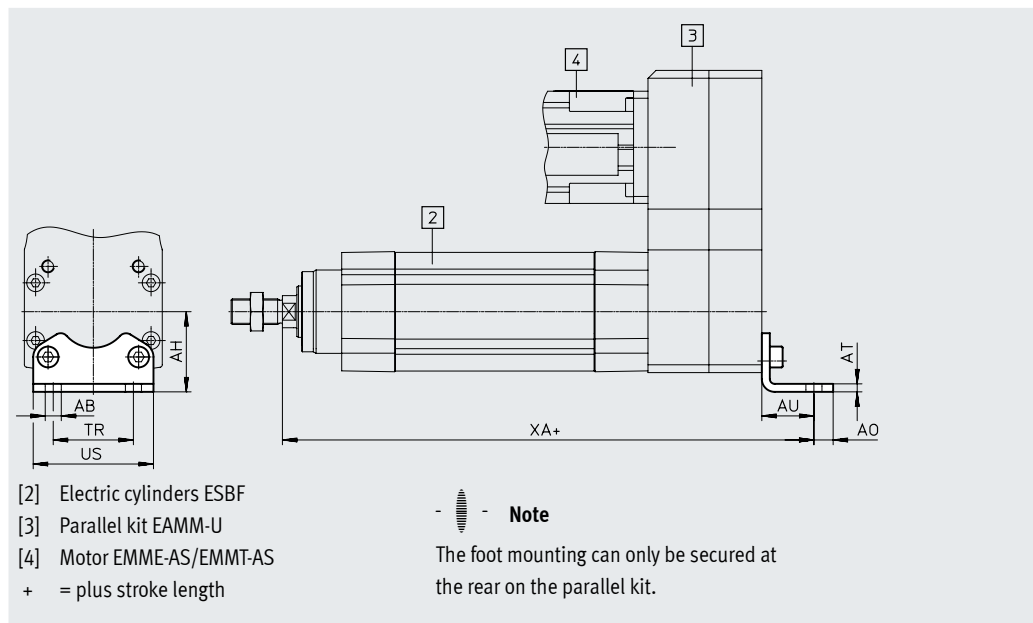

Dimensions and ordering data

For size	AB ∅	AH	AO	AT	AU ±0.2	TR JS14	US
32	7	32	6.5	4	24	32	45 _{-0.5}
40	10	36	9	4	28	36	54 _{-0.6}
50	10	45	9.5	5	32	45	64 _{-0.6}
63	10	50	12.5	5	32	50	75 _{-0.6}
80	12	63	15	6	41	63	93 _{-0.8}
100	14.5	71	17.5	6	41	75	110 _{-0.8}

For size	XA With parallel kit					
	EAMM-U-50	EAMM-U-60	EAMM-U-70	EAMM-U-86	EAMM-U-110	EAMM-U-145
32	217	228	236.5	–	–	–
40	–	257.5	266	270.5	–	–
50	–	–	298	302.5	313.5	–
63	–	–	–	311	322	–
80	–	–	–	–	373	390.5
100	–	–	–	–	–	415.5

For size	Max. load capacity [kN]	ESBF... CRC ¹⁾				ESBF...-R3			
		Weight [g]	Part no.	Type	Weight [g]	Part no.	Type		
32	0.9	2	144	★ 174369	HNC-32	4	139	176937	CRHNC-32
40	1.5	2	193	★ 174370	HNC-40	4	188	176938	CRHNC-40
50	2.5	2	353	★ 174371	HNC-50	4	341	176939	CRHNC-50
63	4	2	436	★ 174372	HNC-63	4	424	176940	CRHNC-63
80	6	2	829	★ 174373	HNC-80	4	809	176941	CRHNC-80
100	9	2	1009	★ 174374	HNC-100	4	990	176942	CRHNC-100

1) Corrosion resistance class CRC 2 to Festo standard FN 940070

Moderate corrosion stress. Indoor applications in which condensation can occur. External visible parts with primarily decorative surface requirements which are in direct contact with a normal industrial environment.

Corrosion resistance class CRC 4 to Festo standard FN 940070

Particularly high corrosion stress. Outdoor exposure under extreme corrosive conditions. Parts exposed to aggressive media, e.g. in the chemical or food industries. Such applications may need to be safeguarded by means of special testing (→ also FN 940082), using appropriate media.

Festo core product range



Generally ready for dispatch from the factory within 24 hours



Generally ready for dispatch from the factory within 5 days

Accessories

Flange mounting EAHH

Material:
High-alloy stainless steel

RoHS-compliant

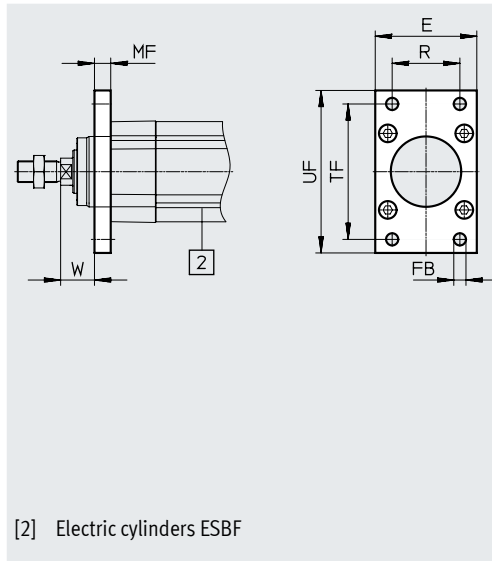

[2] Electric cylinders ESBF

Dimensions and ordering data

For size	E	FB ∅ H13	MF js14	R	TF	UF ±1	W
32	45	7	10	32	64	80	15.5
40	54	9	10	36	72	90	19.5
50	64	9	12	45	90	110	24.5
63	75	9	12	50	100	120	25
80	93	12	16	63	126	150	30
100	110	14	16	75	150	175	35

For size	Max. load capacity [kN]	ESBF-...-R3			
		CRC ¹⁾	Weight [g]	Part no.	Type
32	1	3	206	★ 2827587	EAHH-V2-32-R1
40	3	3	275	★ 2827588	EAHH-V2-40-R1
50	5	3	496	★ 2827589	EAHH-V2-50-R1
63	7	3	633	★ 1502305	EAHH-V2-63-R1
80	12	3	1360	1502306	EAHH-V2-80-R1
100	17	3	1880	1502307	EAHH-V2-100-R1

1) Corrosion resistance class CRC 3 to Festo standard FN 940070

High corrosion stress. Outdoor exposure under moderate corrosive conditions. External visible parts with primarily functional surface requirements which are in direct contact with a normal industrial environment.

Festo core product range

- ★ Generally ready for dispatch from the factory within 24 hours
- ★ Generally ready for dispatch from the factory within 5 days

Accessories

Trunnion flange ZNCF/CRZNG

Material:
 ZNCF: Stainless steel casting
 CRZNG: Electropolished stainless steel casting

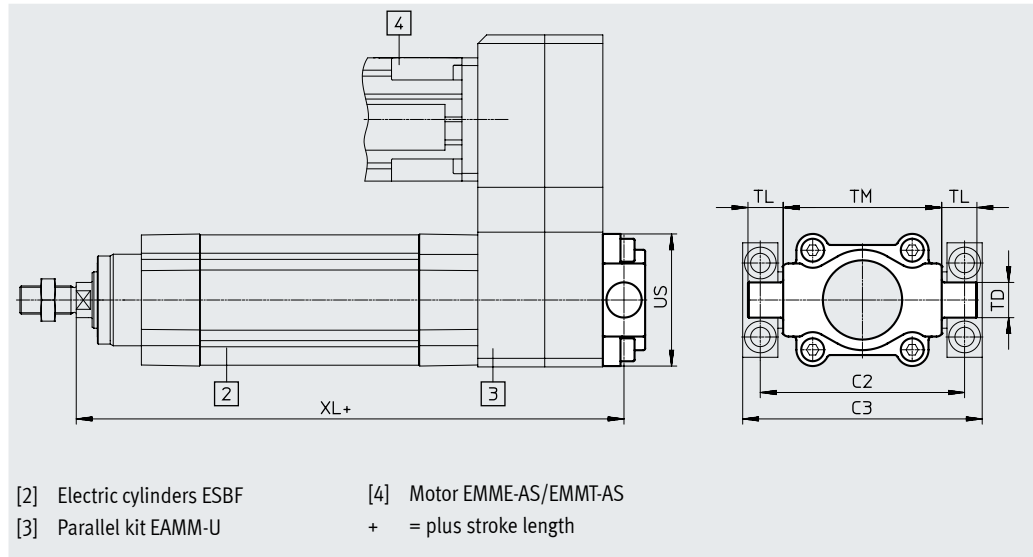

[2] Electric cylinders ESBF [4] Motor EMME-AS/EMMT-AS
 [3] Parallel kit EAMM-U + = plus stroke length

Dimensions and ordering data

For size	C2	C3	TD ∅ E9	TL	TM h14	US
32	71	86	12	12 _{h14}	50	45
40	87	105	16	16 _{h14}	63	54
50	99	117	16	16 _{h14}	75	64
63	116	136	20	20+0.5/-0.7	90	75
80	136	156	20	19.5+0.5/-0.7	110	93
100	164	189	25	24.5+0.5/-0.7	132	110

For size	XL With parallel kit					
	EAMM-U-50	EAMM-U-60	EAMM-U-70	EAMM-U-86	EAMM-U-110	EAMM-U-145
32	201	212	220.5	-	-	-
40	-	239.5	248	252.5	-	-
50	-	-	278	282.5	293.5	-
63	-	-	-	291	302	-
80	-	-	-	-	346	363.5
100	-	-	-	-	-	393.5

For size	Max. load capacity [kN]	ESBF-...				ESBF-...-R3			
		CRC ¹⁾	Weight [g]	Part no.	Type	CRC ¹⁾	Weight [g]	Part no.	Type
32	0.9	2	150	174411	ZNCF-32	4	150	161852	CRZNG-32
40	1.5	2	285	174412	ZNCF-40	4	285	161853	CRZNG-40
50	2.5	2	473	174413	ZNCF-50	4	473	161854	CRZNG-50
63	4	2	687	174414	ZNCF-63	4	687	161855	CRZNG-63
80	6	2	1296	174415	ZNCF-80	4	1296	161856	CRZNG-80
100	9	2	2254	174416	ZNCF-100	4	2254	161857	CRZNG-100

1) Corrosion resistance class CRC 2 to Festo standard FN 940070
 Moderate corrosion stress. Indoor applications in which condensation can occur. External visible parts with primarily decorative surface requirements which are in direct contact with a normal industrial environment.
 Corrosion resistance class CRC 4 to Festo standard FN 940070
 Particularly high corrosion stress. Outdoor exposure under extreme corrosive conditions. Parts exposed to aggressive media, e.g. in the chemical or food industries. Such applications may need to be safeguarded by means of special testing (→ also FN 940082), using appropriate media.

Accessories

Trunnion support LNZG

Material:

Trunnion support: Anodised aluminium

Plain bearing: Plastic

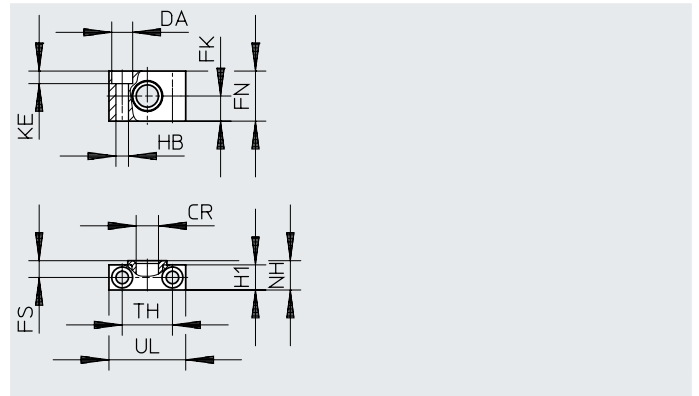

Dimensions and ordering data								
For size	Max. load capacity [kN]	CR ∅ D11	DA ∅ H13	FK ±0.1	FN	FS	H1	HB ∅ H13
32	0.9	12	11	15	30	10.5	15	6.6
40, 50	2.5	16	15	18	36	12	18	9
63, 80	6	20	18	20	40	13	20	11
100	9	25	20	25	50	16	24.5	14

For size	KE	NH	TH ±0.2	UL	CRC ¹⁾	Weight [g]	Part no.	Type
32	6.8	18	32	46	2	83	32959	LNZG-32
40, 50	9	21	36	55	2	129	32960	LNZG-40/50
63, 80	11	23	42	65	2	178	32961	LNZG-63/80
100	13	28.5	50	75	2	306	32962	LNZG-100/125

1) Corrosion resistance class CRC 2 to Festo standard FN 940070

Moderate corrosion stress. Indoor applications in which condensation can occur. External visible parts with primarily decorative surface requirements which are in direct contact with a normal industrial environment.

Accessories

Trunnion support CRLNZG

Material:
High-alloy steel

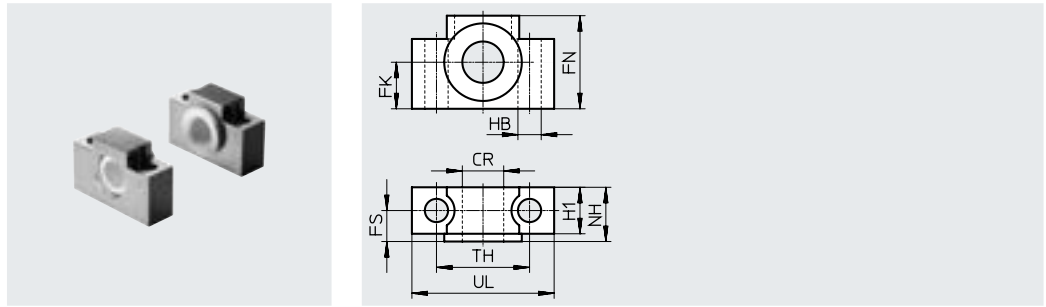

Dimensions and ordering data

For size	Max. load capacity [kN]	CR ∅ D11	FK ±0.1	FN	FS	H1	HB ∅ H13
32	0.9	12	15	30	10.5	15	6.6
4 0/50	2.5	16	18	36	12	18	9
63, 80	6	20	20	40	13	20	11
100	9	25	25	50	16	24.5	14

For size	NH	TH ±0.2	UL	CRC ¹⁾	Weight [g]	Part no.	Type
32	18	32	46	4	205	161874	CRLNZG-32
4 0/50	21	36	55	4	323	161875	CRLNZG-40/50
63, 80	23	42	65	4	435	161876	CRLNZG-63/80
100	28.5	50	75	4	739	161877	CRLNZG-100/125

1) Corrosion resistance class CRC 4 to Festo standard FN 940070

Particularly high corrosion stress. Outdoor exposure under extreme corrosive conditions. Parts exposed to aggressive media, e.g. in the chemical or food industries. Such applications may need to be safeguarded by means of special testing (→ also FN 940082), using appropriate media.

Accessories

Swivel flange DAMS

Material:
Aluminium

RoHS-compliant

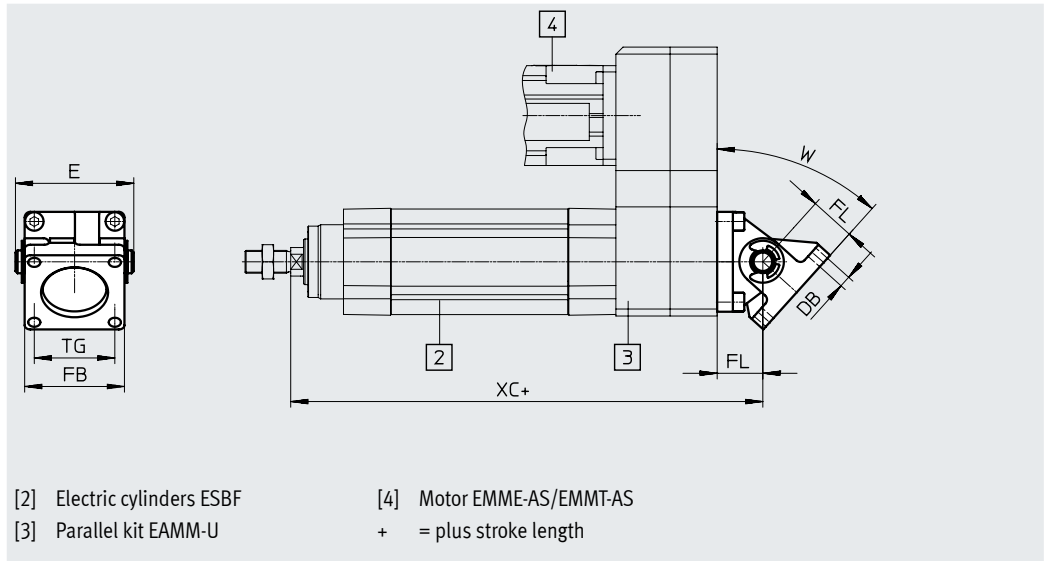

[2] Electric cylinders ESBF
[3] Parallel kit EAMM-U

[4] Motor EMME-AS/EMMT-AS
+ = plus stroke length

Dimensions and ordering data

For size	DB ∅	E	FB	FL	TG	W max. [°]
40	6.5	63	52	25	38	32
50	8.5	73	60	27	46.5	45
63	8.5	83	70	32	56.5	42
80	10.5	103	90	36	72	31
100	10.5	127	110	41	89	36

For size	XC With parallel kit				
	EAMM-U-60	EAMM-U-70	EAMM-U-86	EAMM-U-110	EAMM-U-145
40	254.5	263	267.5	–	–
50	–	293	297.5	308.5	–
63	–	–	311	322	–
80	–	–	–	368	385.5
100	–	–	–	–	415.5

For size	Max. load capacity [kN]	CRC ¹⁾	Weight [g]	Part no.	Type
40	3	3	258	2787470	DAMS-K-V1-40-V-R3
50	5	3	451	2787651	DAMS-K-V1-50-V-R3
63	7	3	657	1555443	DAMS-K-V1-63-V-R3
80	12	3	1240	1556588	DAMS-K-V1-80-V-R3
100	17	3	1940	1560237	DAMS-K-V1-100-V-R3

1) Corrosion resistance class CRC 3 to Festo standard FN 940070
High corrosion stress. Outdoor exposure under moderate corrosive conditions. Externally visible parts with primarily functional surface requirements which are in direct contact with a normal industrial environment.

Note

The swivel flange SNCS or SNCB (max. load capacity of 1 kN) can be used for size 32.

Accessories

Swivel flange SNC

Material:
Die-cast aluminium

RoHS-compliant

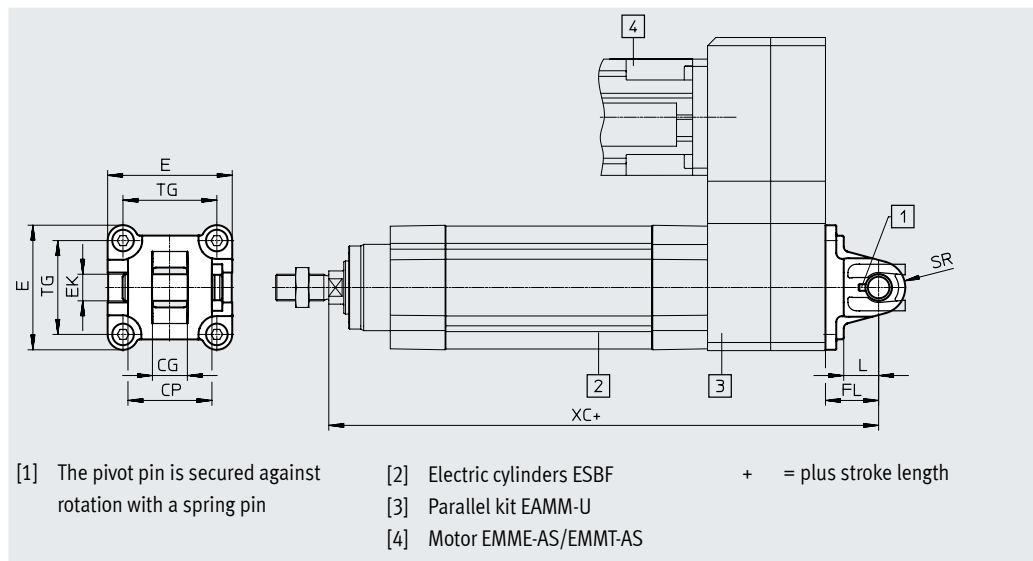

Dimensions and ordering data

For size	CG	CP	E	EK ∅ H9	FL ±0.2	L	SR	TG
	H14	h14						
32	14	34	45 ^{+0.2/-0.5}	10	22	13	10	32.5
40	16	40	54 ^{-0.5}	12	25	16	12	38
50	21	45	64 ^{-0.6}	16	27	16	12	46.5
63	21	51	75 ^{-0.6}	16	32	21	16	56.5
80	25	65	93 ^{-0.8}	20	36	22	16	72
100	25	75	110 ^{+0.3/-0.8}	20	41	27	20	89

For size	XC With parallel kit					
	EAMM-U-50	EAMM-U-60	EAMM-U-70	EAMM-U-86	EAMM-U-110	EAMM-U-145
32	215	226	234.5	-	-	-
40	-	254.5	263	267.5	-	-
50	-	-	293	297.5	308.5	-
63	-	-	-	311	322	-
80	-	-	-	-	368	385.5
100	-	-	-	-	-	415.5

For size	Max. load capacity [kN]	CRC ¹⁾	Weight [g]	Part no.	Type
32	0.9	1	93	★ 174383	SNC-32
40	1.5	1	140	★ 174384	SNC-40
50	2.5	1	234	★ 174385	SNC-50
63	4	1	331	★ 174386	SNC-63
80	6	1	618	★ 174387	SNC-80
100	9	1	865	174388	SNC-100

1) Corrosion resistance class CRC 1 to Festo standard FN 940070
Low corrosion stress. Dry indoor application or transport and storage protection. Also applies to parts behind coverings, in the non-visible interior area, and parts which are covered in the application (e.g. drive shaft).

Accessories

Swivel flange
SNCS/CRSNCS/SNCS-...-R3

Material:
SNCS 32 ... 50:
Die-cast aluminium
SNCS 63 ... 100:
Wrought aluminium alloy

CRSNCS 32 ... 80:
High-alloy stainless steel
SNCS-100-R3:
Wrought aluminium alloy with
protective coating

RoHS-compliant

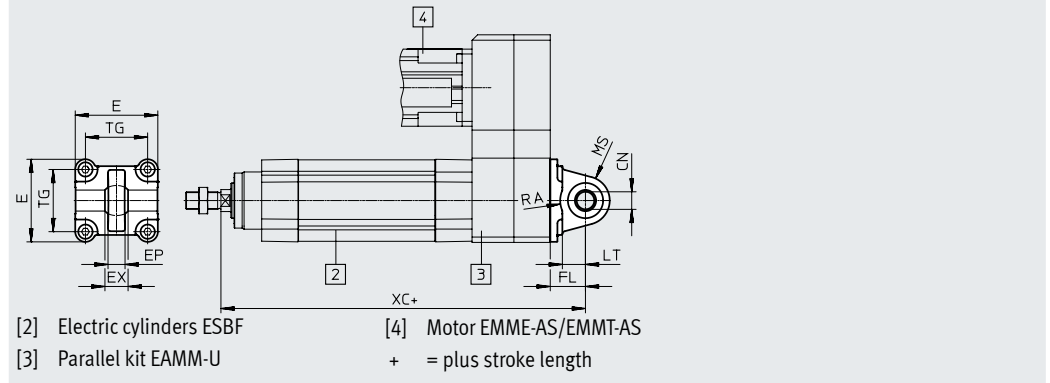

Dimensions and ordering data

For size	CN		E		EP ±0.2	EX	FL ±0.2	LT	MS	
	ESBF-...	ESBF-...-R3	ESBF-...	ESBF-...-R3					ESBF-...	ESBF-...-R3
32	10 ^{+0.013}	10+0.015/-0.04	45+0.2/-0.5	45+0.2/-0.5	10.5	14	22	13	15 ^{+0.5}	15 ^{+0.5}
40	12 ^{+0.015}	12+0.018/-0.04	54 _{-0.5}	54-0.5	12	16	25	16	17 ^{+0.5}	17 ^{+0.5}
50	16 ^{+0.015}	16+0.018/-0.04	64 _{-0.6}	64-0.6	15	21	27	16	20 ^{+0.5}	20 ^{+0.5}
63	16 ^{+0.015}	16+0.018/-0.04	74.5±0.5	75 _{-0.6}	15	21	32	21	23 _{-0.5}	22 ^{+0.5}
80	20 ^{+0.018}	20+0.021/-0.04	92.2±0.8	93 _{-0.6}	18	25	36	22	28 _{-0.5}	27 ^{+0.5}
100	20 ^{+0.018}	20+0.021/-0.04	109+1/-0.7	109 _{-0.8}	18	25	41	27	30±0.5	30±0.5

For size	RA +1		TG	XC With parallel kit					
	ESBF-...	ESBF-...-R3		EAMM-U-50	EAMM-U-60	EAMM-U-70	EAMM-U-86	EAMM-U-110	EAMM-U-145
32	14.5	14.5	32.5	215	226	234.5	-	-	-
40	17.5	17.5	38	-	254.5	263	267.5	-	-
50	18.5	19	46.5	-	-	293	297.5	308.5	-
63	23	23	56.5	-	-	-	311	322	-
80	25	25	72	-	-	-	-	368	385.5
100	95	100	89	-	-	-	-	-	415.5

For size	Max. load capacity [kN]	Basic type				High corrosion protection			
		CRC ¹⁾	Weight [g]	Part no.	Type	CRC ¹⁾	Weight [g]	Part no.	Type
32	1	1	86	★ 174397	SNCS-32	4	161	2895920	CRSNCS-32
40	1.5	1	122	★ 174398	SNCS-40	4	239	2895921	CRSNCS-40
50	2.5	1	216	★ 174399	SNCS-50	4	403	2895922	CRSNCS-50
63	4	2	281	★ 174400	SNCS-63	4	576	2895923	CRSNCS-63
80	6	2	557	★ 174401	SNCS-80	4	1173	2895924	CRSNCS-80
100	9	2	683	174402	SNCS-100	3	684	2895925	SNCS-100-R3

- 1) Corrosion resistance class CRC 1 to Festo standard FN 940070
 Low corrosion stress. Dry indoor application or transport and storage protection. Also applies to parts behind coverings, in the non-visible interior area, and parts which are covered in the application (e.g. drive shaft).
 Corrosion resistance class CRC 2 to Festo standard FN 940070
 Moderate corrosion stress. Indoor applications in which condensation can occur. External visible parts with primarily decorative surface requirements which are in direct contact with a normal industrial environment.
 Corrosion resistance class CRC 3 to Festo standard FN 940070
 High corrosion stress. Outdoor exposure under moderate corrosive conditions. Externally visible parts with primarily functional surface requirements which are in direct contact with a normal industrial environment.
 Corrosion resistance class CRC 4 to Festo standard FN 940070
 Particularly high corrosion stress. Outdoor exposure under extreme corrosive conditions. Parts exposed to aggressive media, e.g. in the chemical or food industries. Such applications may need to be safeguarded by means of special testing (→ also FN 940082), using appropriate media.

Festo core product range

- ★ Generally ready for dispatch from the factory within 24 hours
- ★ Generally ready for dispatch from the factory within 5 days

Accessories

Swivel flange SNCL

Material:
Die-cast aluminium

RoHS-compliant

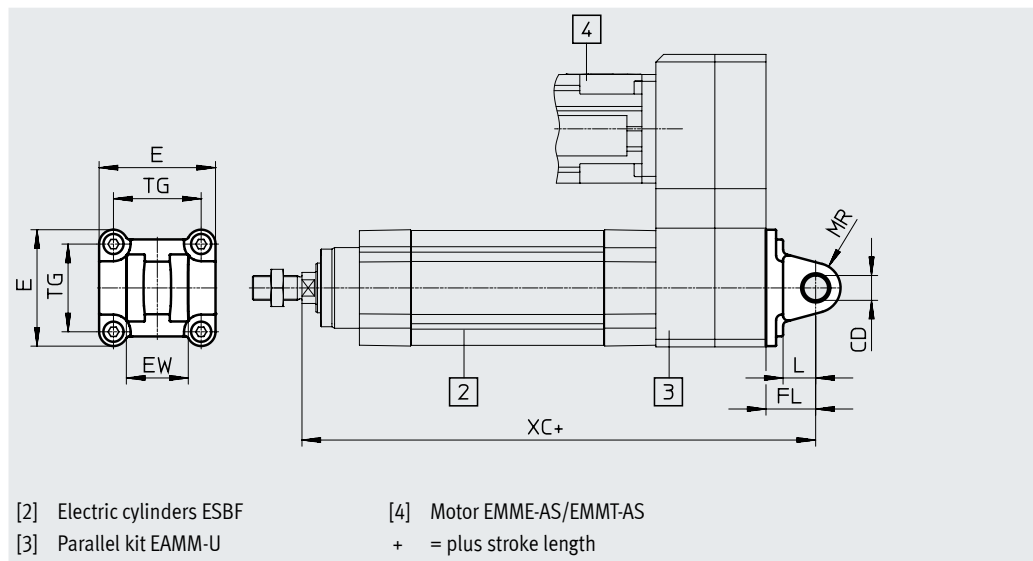

Dimensions and ordering data

For size	CD ∅ H9	E	EW -0.2/-0.6	FL ±0.2	L	MR	TG
32	10	45+0.2/-0.5	26	22	13	10	32.5
40	12	54-0.5	28	25	16	12	38
50	12	64-0.6	32	27	16	12	46.5
63	16	75-0.6	40	32	21	16	56.5
80	16	93-0.8	50	36	22	16	72
100	20	110+0.3/-0.8	60	41	27	20	89

For size	XC With parallel kit					
	EAMM-U-50	EAMM-U-60	EAMM-U-70	EAMM-U-86	EAMM-U-110	EAMM-U-145
32	215	226	234.5	-	-	-
40	-	254.5	263	267.5	-	-
50	-	-	293	297.5	308.5	-
63	-	-	-	311	322	-
80	-	-	-	-	368	385.5
100	-	-	-	-	-	415.5

For size	Max. load capacity [kN]	CRC ¹⁾	Weight [g]	Part no.	Type
32	0.9	1	71	★ 174404	SNCL-32
40	1.5	1	95	★ 174405	SNCL-40
50	2.5	1	158	★ 174406	SNCL-50
63	4	1	225	★ 174407	SNCL-63
80	6	1	436	★ 174408	SNCL-80
100	9	1	606	174409	SNCL-100

1) Corrosion resistance class CRC 1 to Festo standard FN 940070
Low corrosion stress. Dry indoor application or transport and storage protection. Also applies to parts behind coverings, in the non-visible interior area, and parts which are covered in the application (e.g. drive shaft).

Festo core product range

- ★ Generally ready for dispatch from the factory within 24 hours
- ☆ Generally ready for dispatch from the factory within 5 days

Accessories

Swivel flange SNCB/SNCB-...-R3

Material:
SNCB: Die-cast aluminium
SNCB-...-R3: Die-cast aluminium with
protective coating, high corrosion
protection

RoHS-compliant

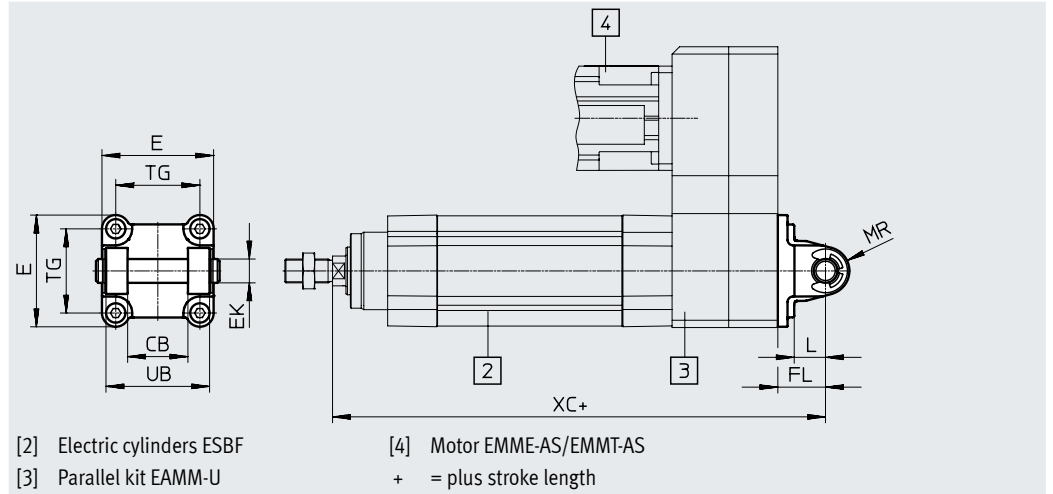

Dimensions and ordering data

For size	CB	E	EK ∅ E8	FL	L	MR	TG	UB
	H14			±0.2		-0.5		h14
32	26	45+0.2/-0.5	10	22	13	8.5	32.5	45
40	28	54-0.5	12	25	16	12	38	52
50	32	64-0.6	12	27	16	12	46.5	60
63	40	75-0.6	16	32	21	16	56.5	70
80	50	93-0.8	16	36	22	16	72	90
100	60	110+0.3/-0.8	20	41	27	20	89	110

For size	XC With parallel kit					
	EAMM-U-50	EAMM-U-60	EAMM-U-70	EAMM-U-86	EAMM-U-110	EAMM-U-145
32	215	226	234.5	-	-	-
40	-	254.5	263	267.5	-	-
50	-	-	293	297.5	308.5	-
63	-	-	-	311	322	-
80	-	-	-	-	368	385.5
100	-	-	-	-	-	415.5

For size	Max. load capacity [kN]	ESBF-...				ESBF-...-R3			
		CRC ¹⁾	Weight [g]	Part no.	Type	CRC ¹⁾	Weight [g]	Part no.	Type
32	1	1	103	★ 174390	SNCB-32	3	100	176944	SNCB-32-R3
40	1.5	1	155	★ 174391	SNCB-40	3	151	176945	SNCB-40-R3
50	2.5	1	232	★ 174392	SNCB-50	3	228	176946	SNCB-50-R3
63	4	1	375	★ 174393	SNCB-63	3	371	176947	SNCB-63-R3
80	6	1	636	★ 174394	SNCB-80	3	632	176948	SNCB-80-R3
100	9	1	1035	★ 174395	SNCB-100	3	986	176949	SNCB-100-R3

1) Corrosion resistance class CRC 1 to Festo standard FN 940070

Low corrosion stress. Dry indoor application or transport and storage protection. Also applies to parts behind coverings, in the non-visible interior area, and parts which are covered in the application (e.g. drive shaft).

Corrosion resistance class CRC 3 to Festo standard FN 940070

High corrosion stress. Outdoor exposure under moderate corrosive conditions. Externally visible parts with primarily functional surface requirements which are in direct contact with a normal industrial environment.

Festo core product range

- ★ Generally ready for dispatch from the factory within 24 hours
- ★ Generally ready for dispatch from the factory within 5 days

Accessories

Trunnion flange kit DAMT

Material:
Galvanised steel

RoHS-compliant

The kit can be attached at any position along the profile barrel of the cylinder.
The trunnion flange kit cannot be mounted in the vicinity of the motor in conjunction with the parallel kit EAMM-U.

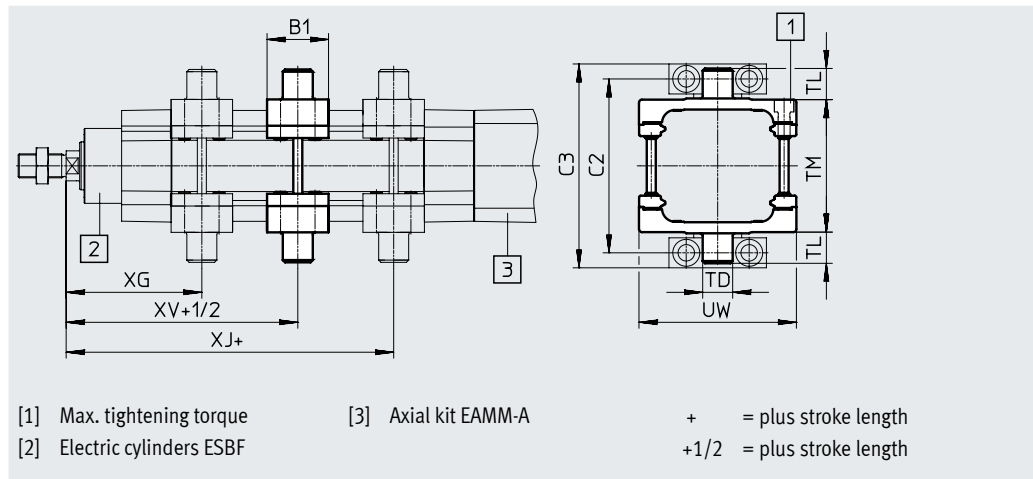
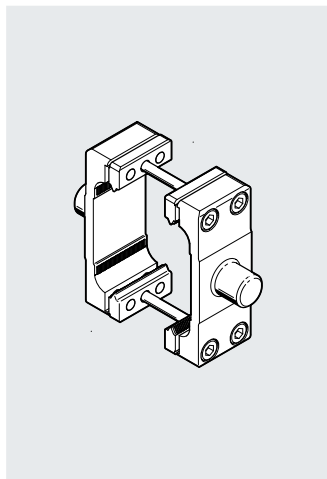

Dimensions and ordering data

For size	B1	C2	C3	TD ∅ E9	TL	TM	UW	XG
32	30	71	86	12	12	50	65	66
40	32	87	105	16	16	63	75	75.5
50	34	99	117	16	16	75	95	83.5
63	41	116	136	20	20	90	105	90.5
80	44	136	156	20	20	110	130	107
100	48	164	189	25	25	132	145	114



For size	XJ	XV	Max. tightening torque [Nm]	Max. load capacity [kN]	CRC ¹⁾	Weight [g]	Part no.	Type
32	107.5	86.8	4+1	0.9	1	212.7	★ 2213233	DAMT-V1-32-A
40	127.5	101.5	8+1	1.5	1	387.5	★ 2214899	DAMT-V1-40-A
50	152.5	118	8+2	2.5	1	607.6	★ 2214909	DAMT-V1-50-A
63	154.5	122.5	18+2	4	1	910.5	★ 2214971	DAMT-V1-63-A
80	189	148	28+2	6	1	1493.7	★ 163529	DAMT-V1-80-A
100	212	163	28+2	9	1	2094.8	★ 163530	DAMT-V1-100-A

1) Corrosion resistance class CRC 1 to Festo standard FN 940070



Low corrosion stress. Dry indoor application or transport and storage protection. Also applies to parts behind coverings, in the non-visible interior area, and parts which are covered in the application (e.g. drive shaft).

Accessories

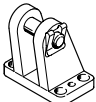
Ordering data – Mounting components

Designation	For size	Max. load capacity [kN]	Part no.	Type
Clevis foot LNG				
	32	0.9	★ 33890	LNG-32
	40	1.5	★ 33891	LNG-40
	50	2.5	★ 33892	LNG-50
	63	4	★ 33893	LNG-63
	80	6	★ 33894	LNG-80
	100	9	33895	LNG-100
Clevis foot LSNG				
	32	0.9	31740	LSNG-32
	40	1.5	31741	LSNG-40
	50	2.5	31742	LSNG-50
	63	4	31743	LSNG-63
	80	6	31744	LSNG-80
	100	9	31745	LSNG-100
Clevis foot LBG				
	32	0.9	31761	LBG-32
	40	1.5	31762	LBG-40
	50	2.5	31763	LBG-50
	63	4	31764	LBG-63
	80	6	31765	LBG-80
	100	9	31766	LBG-100

Data sheets → Internet: clevis foot

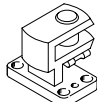
Designation	For size	Max. load capacity [kN]	Part no.	Type
Clevis foot LSN				
	32	0.9	5561	LSN-32
	40	1.5	5562	LSN-40
	50	2.5	5563	LSN-50
	63	4	5564	LSN-63
	80	6	5565	LSN-80
	100	9	5566	LSN-100
Clevis foot LSNSG				
	32	0.9	31747	LSNSG-32
	40	1.5	31748	LSNSG-40
	50	2.5	31749	LSNSG-50
	63	4	31750	LSNSG-63
	80	6	31751	LSNSG-80
	100	9	31752	LSNSG-100
Right angle clevis foot LQG				
	32	0.9	31768	LQG-32
	40	1.5	31769	LQG-40
	50	2.5	31770	LQG-50
	63	4	31771	LQG-63
	80	6	31772	LQG-80
	100	9	31773	LQG-100

Ordering data – Mounting components, corrosion-resistant

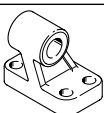
Designation	For size	Max. load capacity [kN]	Part no.	Type
Clevis foot CRLNG				
	32	0.9	161840	CRLNG-32
	40	1.5	161841	CRLNG-40
	50	2.5	161842	CRLNG-50
	63	4	161843	CRLNG-63
	80	6	161844	CRLNG-80
	100	9	161845	CRLNG-100

Data sheets → Internet: clevis foot

Ordering data – Mounting components, high corrosion protection

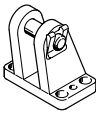
Designation	For size	Max. load capacity [kN]	Part no.	Type
Clevis foot LBG-R3				
	32	0.9	2078790	LBG-32-R3
	40	1.5	2078792	LBG-40-R3
	50	2.5	2078794	LBG-50-R3
	63	4	2078795	LBG-63-R3
	80	6	2078797	LBG-80-R3
	100	9	2078799	LBG-100-R3

Data sheets → Internet: clevis foot

Festo core product range

- ★ Generally ready for dispatch from the factory within 24 hours
- ☆ Generally ready for dispatch from the factory within 5 days

Accessories

Ordering data – Piston rod attachments

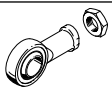
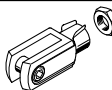
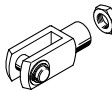
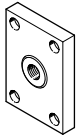
Designation	For size	Max. load capacity [kN]	Part no.	Type
Rod eye SGS				
	32	0.9	★ 9261	SGS-M10x1.25
	40	1.5	★ 9262	SGS-M12x1.25
	50, 63	4	★ 9263	SGS-M16x1.5
	80, 100	9	★ 9264	SGS-M20x1.5
Rod clevis SG				
	32	0.9	★ 6144	SG-M10x1.25
	40	1.5	★ 6145	SG-M12x1.25
	50, 63	4	★ 6146	SG-M16x1.5
	80, 100	9	★ 6147	SG-M20x1.5
Coupling piece KSZ				
	32	0.9	36125	KSZ-M10x1.25
	40	1.5	36126	KSZ-M12x1.25
	50, 63	4	36127	KSZ-M16x1.5
	80, 100	9	36128	KSZ-M20x1.5

Data sheets → Internet: piston rod attachment

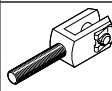
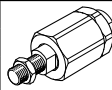
Designation	For size	Max. load capacity [kN]	Part no.	Type
Rod clevis SGA				
	32	0.9	32954	SGA-M10x1.25
	40	1.5	10767	SGA-M12x1.25
	50, 63	4	10768	SGA-M16x1.5
	80, 100	9	10769	SGA-M20x1.5
Self-aligning rod coupler FK				
	32	0.9	★ 6140	FK-M10x1.25
	40	1.5	★ 6141	FK-M12x1.25
	50, 63	4	★ 6142	FK-M16x1.5
	80, 100	9	★ 6143	FK-M20x1.5

Ordering data – Piston rod attachments, corrosion-resistant

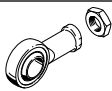
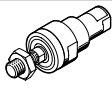
Designation	For size	Max. load capacity [kN]	Part no.	Type
Rod eye CRSGS				
	32	0.9	195582	CRSGS-M10x1.25
	40	1.5	195583	CRSGS-M12x1.25
	50, 63	4	195584	CRSGS-M16x1.5
	80, 100	9	195585	CRSGS-M20x1.5
Self-aligning rod coupler CRFK				
	32	0.9	2305778	CRFK-M10x1.25
	40	1.5	2305779	CRFK-M12x1.25
	50, 63	4	2490673	CRFK-M16x1.5
	80, 100	9	2545677	CRFK-M20x1.5

Data sheets → Internet: piston rod attachment

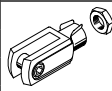
Designation	For size	Max. load capacity [kN]	Part no.	Type
Rod clevis CRSG				
	32	0.9	13569	CRSG-M10x1.25
	40	1.5	13570	CRSG-M12x1.25
	50, 63	4	13571	CRSG-M16x1.5
	80, 100	9	13572	CRSG-M20x1.5



Accessories

Ordering data – Guide units

Data sheets → Internet: eagf

Stroke [mm]	Part no.	Type	Stroke [mm]	Part no.	Type
For size 32			For size 40		
100	☆ 2782679	EAGF-V2-KF-32-100	100	☆ 2782939	EAGF-V2-KF-40-100
200	☆ 2782818	EAGF-V2-KF-32-200	200	☆ 2782976	EAGF-V2-KF-40-200
320	☆ 2782885	EAGF-V2-KF-32-320	320	☆ 2783047	EAGF-V2-KF-40-320
400	☆ 2782923	EAGF-V2-KF-32-400	400	☆ 2783080	EAGF-V2-KF-40-400
1 ... 500	3038083	EAGF-V2-KF-32-	1 ... 500	3038089	EAGF-V2-KF-40-
For size 50			For size 63		
100	☆ 2783639	EAGF-V2-KF-50-100	100	☆ 1725842	EAGF-V2-KF-63-100
200	☆ 2784152	EAGF-V2-KF-50-200	200	☆ 1725843	EAGF-V2-KF-63-200
320	☆ 2784164	EAGF-V2-KF-50-320	320	☆ 1725844	EAGF-V2-KF-63-320
400	☆ 2784184	EAGF-V2-KF-50-400	400	☆ 1725845	EAGF-V2-KF-63-400
1 ... 500	3038094	EAGF-V2-KF-50-	1 ... 500	2608521	EAGF-V2-KF-63-
For size 80			For size 100		
100	1725846	EAGF-V2-KF-80-100	100	1725850	EAGF-V2-KF-100-100
200	1725847	EAGF-V2-KF-80-200	200	1725851	EAGF-V2-KF-100-200
320	1725848	EAGF-V2-KF-80-320	320	1725852	EAGF-V2-KF-100-320
400	1725849	EAGF-V2-KF-80-400	400	1725853	EAGF-V2-KF-100-400
1 ... 500	2608528	EAGF-V2-KF-80-	1 ... 500	2608532	EAGF-V2-KF-100-

 - Note

A guide unit with a suitable length must be selected for cylinders with piston rod extensions.

Festo core product range



Generally ready for dispatch from the factory within 24 hours

Generally ready for dispatch from the factory within 5 days

Accessories

Sensor mounting

The sensor mountings can only be attached within the marked area due to the asymmetry of the internal magnet.

Reliable switching of the proximity sensors is not guaranteed outside of this area.

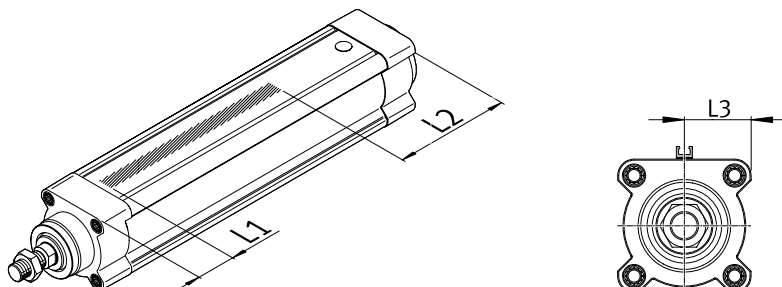

Size	L1	L2	L3
32	26	48	22.3
40	30	65	26.5
50	30	84	31.5
63	33	99	37
80	39	132	46
100	39	151	54.5

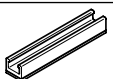
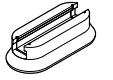
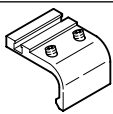

Ordering data – Sensor mounting for T-slot

	For diam.	Description	Length [mm]	Part no.	Type
Sensor rail					
	32 ... 100	<ul style="list-style-type: none"> For proximity sensor SMT/CRSMT-8 The sensor rail is glued onto the cylinder 	50	1600093	SAMH-N8-SR-50
			100	1600118	SAMH-N8-SR-100
Mounting kit					
	32 ... 100	<ul style="list-style-type: none"> For proximity sensor SMT/CRSMT-8 The overall length corresponds to the length of the sensing range plus an adjusting range of approx. 10 mm for the proximity sensors The kit is glued onto the cylinder 	35	525565	CRSMB-8-32/100
Mounting kit					
	32, 40	<ul style="list-style-type: none"> For proximity sensor SMT/CRSMT-8 The kit is mounted on the profile using two screws 	27	175705	SMB-8-FENG-32/40
	50, 63			175706	SMB-8-FENG-50/63
	80, 100			175707	SMB-8-FENG-80/100

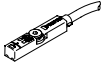
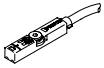
Accessories

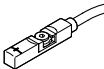
Ordering data – Proximity sensors for T-slot, magneto-resistive							Data sheets → Internet: smt
	Type of mounting	Switching output	Electrical connection	Cable length [m]	Part no.	Type	
N/O contact							
	Insertable in the slot from above, flush with the cylinder profile, short design	PNP	Cable, 3-wire	2.5	★ 574335	SMT-8M-A-PS-24V-E-2.5-OE	
			Plug M8x1, 3-pin	0.3	★ 574334	SMT-8M-A-PS-24V-E-0.3-M8D	
		NPN	Cable, 3-wire	2.5	★ 574338	SMT-8M-A-NS-24V-E-2.5-OE	
			Plug M8x1, 3-pin	0.3	★ 574339	SMT-8M-A-NS-24V-E-0.3-M8D	
N/C contact							
	Insertable in the slot from above, flush with the cylinder profile, short design	PNP	Cable, 3-wire	7.5	★ 574340	SMT-8M-A-PO-24V-E-7.5-OE	
		NPN		2.5	8138000	SMT-8M-A-NO-24V-E-2.5-OE	
				7.5	8138001	SMT-8M-A-NO-24V-E-7.5-OE	

Ordering data – Proximity sensors for T-slot, magneto-resistive, corrosion resistant							Data sheets → Internet: crsmt
	Type of mounting	Switching output	Electrical connection	Cable length [m]	Part no.	Type	
N/O contact							
	Inserted in the slot from above, flush with the mounting kit	PNP	Cable, 3-wire	5	574380	CRSMT-8M-PS-24V-K-5.0-OE	
			Plug M12x1, 3-pin	0.3	574382	CRSMT-8M-PS-24V-K-0.3-M12	
			Plug M8x1, 3-pin	0.3	574383	CRSMT-8M-PS-24V-K-0.3-M8D	

Ordering data – Connecting cables						Data sheets → Internet: nebu
	Electrical connection, left	Electrical connection, right	Cable length [m]	Part no.	Type	
	Straight socket, M8x1, 3-pin	Cable, open end, 3-wire	2.5	★ 541333	NEBU-M8G3-K-2.5-LE3	
	Straight socket, M12x1, 5-pin		5	★ 541334	NEBU-M8G3-K-5-LE3	
	Angled socket, M8x1, 3-pin	Cable, open end, 3-wire	2.5	★ 541363	NEBU-M12G5-K-2.5-LE3	
			5	★ 541364	NEBU-M12G5-K-5-LE3	
	Angled socket, M12x1, 5-pin		2.5	★ 541338	NEBU-M8W3-K-2.5-LE3	
			5	★ 541341	NEBU-M8W3-K-5-LE3	
			2.5	541367	NEBU-M12W5-K-2.5-LE3	
		5	541370	NEBU-M12W5-K-5-LE3		

Ordering data – Plug screws, corrosion-resistant							
	For diam.	Material	CRC ¹⁾	Weight [g]	Part no.	Type	PU ²⁾
	32, 40	High-alloy steel	3	6.5	1355016	DAMD-PS-M6-12-R1	4
	50, 63		3	17.5	650121	DAMD-PS-M8-16-R1	
	80, 100		3	23	1355026	DAMD-PS-M10-16-R1	

1) Corrosion resistance class CRC 3 to Festo standard FN 940070

High corrosion stress. Outdoor exposure under moderate corrosive conditions. Externally visible parts with primarily functional surface requirements which are in direct contact with a normal industrial environment.

2) Packaging unit

Festo core product range



Generally ready for dispatch from the factory within 24 hours

Generally ready for dispatch from the factory within 5 days

Accessories

Seal set

Contains paint-wetting impairment substances
RoHS-compliant

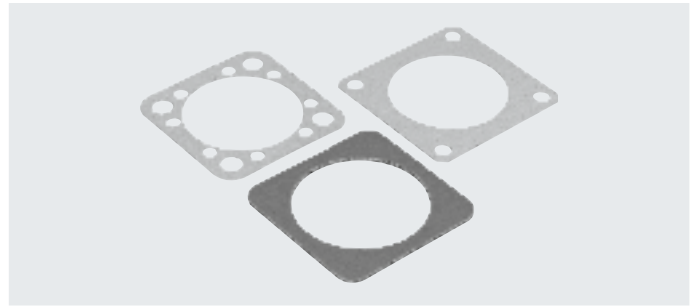

Ordering data						
Type	For axial kit	For electric cylinder	Ambient temperature [°C]	CRC ¹⁾	Part no.	Type
EADS-F-D32-40A	EAMM-A-D32-40A	ESBF, EGSL, ERMB, ERMH	-25 ... +60	4	1561526	EADS-F-D32-40A
EADS-F-D32-40G	EAMM-A-D32-40G				2253500	EADS-F-D32-40G
EADS-F-D32-40P	EAMM-A-D32-40P				2207219	EADS-F-D32-40P
EADS-F-D32-60G/H	EAMM-A-D32-60G EAMM-A-D32-60H				8022150	EADS-F-D32-60G/H
EADS-F-D32-60P	EAMM-A-D32-60P				2234012	EADS-F-D32-60P
EADS-F-D32-67A	EAMM-A-D32-67A				2253501	EADS-F-D32-67A
EADS-F-D32-42A	EAMM-A-D32-42A				1561527	EADS-F-D32-42A
EADS-F-D32-55A	EAMM-A-D32-55A				1561528	EADS-F-D32-55A
EADS-F-D32-57A	EAMM-A-D32-57A				1561529	EADS-F-D32-57A
EADS-F-D40-40G	EAMM-A-D40-40G				2253502	EADS-F-D40-40G
EADS-F-D40-55A	EAMM-A-D40-55A				1561530	EADS-F-D40-55A
EADS-F-D40-57A	EAMM-A-D40-57A				1561531	EADS-F-D40-57A
EADS-F-D40-60G/H	EAMM-A-D40-60G EAMM-A-D40-60H				2253503	EADS-F-D40-60G/H
EADS-F-D40-60P	EAMM-A-D40-60P				2151545	EADS-F-D40-60P
EADS-F-D40-67A	EAMM-A-D40-67A				2253504	EADS-F-D40-67A
EADS-F-D40-70A	EAMM-A-D40-70A				1561532	EADS-F-D40-70A
EADS-F-D40-87A	EAMM-A-D40-87A				1561533	EADS-F-D40-87A
EADS-F-D50-60G/H	EAMM-A-D50-60G EAMM-A-D50-60H				2733792	EADS-F-D50-60G/H
EADS-F-D50-70A	EAMM-A-D50-70A				2733789	EADS-F-D50-70A
EADS-F-D50-80G	EAMM-A-D50-80G				2733793	EADS-F-D50-80G
EADS-F-D50-80P	EAMM-A-D50-80P				2733791	EADS-F-D50-80P
EADS-F-D50-87A	EAMM-A-D50-87A				2733788	EADS-F-D50-87A
EADS-F-D50-100A	EAMM-A-D50-100A				2733790	EADS-F-D50-100A
EADS-F-D60-70A	EAMM-A-D60-70A				8022145	EADS-F-D60-70A
EADS-F-D60-80G	EAMM-A-D60-80G				8022146	EADS-F-D60-80G
EADS-F-D60-60G/H	EAMM-A-D60-60G EAMM-A-D60-60H				2253505	EADS-F-D60-60G/H
EADS-F-D60-80P	EAMM-A-D60-80P				2218523	EADS-F-D60-80P
EADS-F-D60-87A	EAMM-A-D60-87A				1561536	EADS-F-D60-87A
EADS-F-D60-100A	EAMM-A-D60-100A				2253507	EADS-F-D60-100A
EADS-F-D80-80G	EAMM-A-D80-80G				8022147	EADS-F-D80-80G
EADS-F-D80-100A	EAMM-A-D80-100A	1593617	EADS-F-D80-100A			
EADS-F-D80-140A	EAMM-A-D80-140A	1593671	EADS-F-D80-140A			
EADS-F-D100-100A	EAMM-A-D100-100A	3356966	EADS-F-D100-100A			
EADS-F-D100-120G	EAMM-A-D100-120G	8022148	EADS-F-D100-120G			
EADS-F-D100-140A	EAMM-A-D100-140A	1593991	EADS-F-D100-140A			

1) Corrosion resistance class CRC 4 to Festo standard FN 940070

Particularly high corrosion stress. Outdoor exposure under extreme corrosive conditions. Parts exposed to aggressive media, e.g. in the chemical or food industries. Such applications may need to be safeguarded by means of special testing (→ also FN 940082), using appropriate media.