

Rotary drive units ERMS

FESTO



This product is also available as a modular mechanical system
Rotary drive ERMO



Key features

At a glance

Plug and work with the Simplified Motion Series



The simplicity of pneumatics is now combined for the first time with the advantages of electric automation thanks to the Simplified Motion Series. These integrated drives are the perfect solution for all users who are looking for an electric alternative for very simple movement and positioning tasks between two mechanical end positions, but don't want the commissioning process for traditional electric drive systems that can often be quite complex.

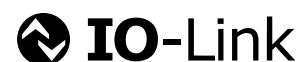

There is no need for any software since operation is simply based on the "plug and work" principle. Digital I/O (DIO) and IO-Link are always automatically included – a product with two types of control as standard.

Integrated

The integrated electronics in the drive are at the heart of the Simplified Motion Series.

Easy

For commissioning, simply set all relevant parameters directly on the drive:

- Speed and force
- Reference end position and cushioning
- Manual operation

Standardised

Electrical connection via M12 plug design

- Power (4-pin): power supply for the motor
- Logic (8-pin): control signal, sensor signal and power for the integrated electronics

Connected

Use of extended functions possible via IO-Link:

- Remote configuration of motion parameters
- Copy and backup function for transferring parameters
- Read function for extended process parameters
- Freely definable intermediate position
- Firmware update

The functions of the Simplified Motion Series

Basic profile for movement between two end positions: with speed control

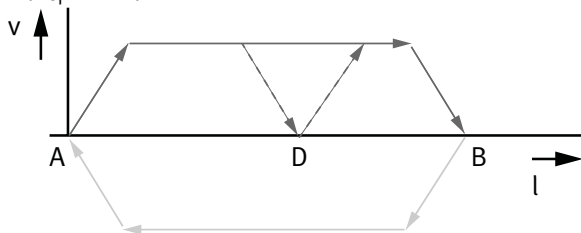

- These drives are designed for simple movements between two end positions.
- Proximity switches are required in order to implement any intermediate positions.
- With the intermediate position that can be freely configured via IO-Link, movements can be stopped at a freely defined point between the end positions, without the need for proximity switches or external stops

Extended motion profile for simplified press-fitting and clamping functions: with speed and force control

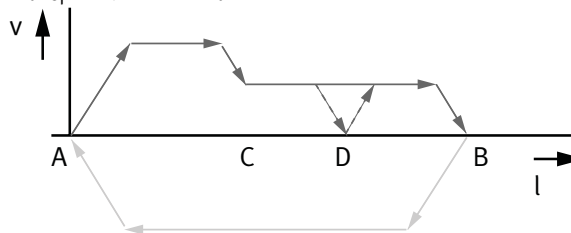

Key features

At a glance



- Without external servo drive: all the necessary electronic components are combined in the integrated drive
- Two control options integrated as standard: digital I/O and IO-Link
- Complete solution for simple movements between mechanical end positions
- Simplified commissioning: all parameters can be manually set directly on the drive
- No special expertise required for commissioning
- End-position feedback similar to that of a conventional proximity switch is integrated as standard
- Sealed hollow shaft for the integrated through-feed of cables and tubing
- Standardised mounting interface for direct connection to the electric mini slides EGSL, EGSC and EGSS

The products in the Simplified Motion Series

Electric cylinder unit
EPCE



Mini slide unit
EGSS-BS-KF

Electric cylinder unit
EPCS



Mini slide unit with parallel motor mounting
EGSS-BS-KF

Electric cylinder unit with parallel motor mounting
EPCS



Spindle axis unit
ELGS-BS-KF

Spindle axis unit with parallel motor mounting
ELGS-BS-KF



Toothed belt axis unit
ELGS-TB-KF

Toothed belt axis unit
ELGE

Rotary drive unit
ERMS



Modular and flexible with motor, motor mounting kit and servo drive

This product is also available within the Optimised Motion Series as rotary drive ERMO:



Rotary drive and motor in one unit. Compact and powerful rotating and swivelling with no limits. Sturdy and precise thanks to backlash-free ball bearing.

- Rotary drive in 4 sizes for torque of up to 5 Nm
- Hollow shaft for energy through-feed for attachments
- Optional pneumatic or electric energy chain
- Optional proximity switch for homing or position sensing
- Holding brake optional
- Modular: individual combinations with servo drive

Key features

Possible combinations with Festo drives

Rotary drive unit ERMS on electric cylinder EPCO

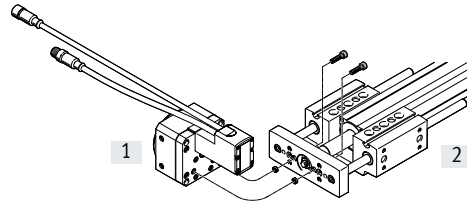
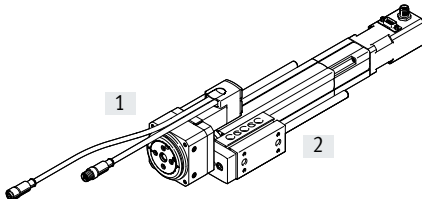

Size		Accessories	
[1] ERMS	[2] EPCO	Centring sleeve	Screw
25	40	ZBH-7 (x2)	M5x20 (x2)

Rotary drive unit ERMS on mini slide unit EGSS

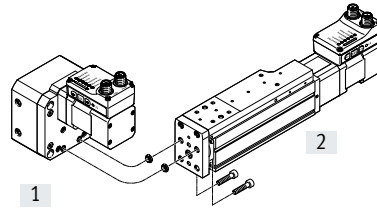
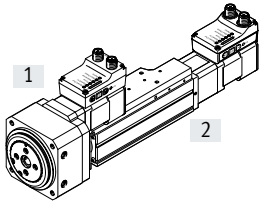

Size		Accessories	
[1] ERMS	[2] EGSS	Centring sleeve	Screw
25	45, 60	ZBH-7 (x2)	M5x12 (x2)
32	60	ZBH-7 (x2)	M5x15 (x2)

Rotary drive unit ERMS on mini slide EGSL

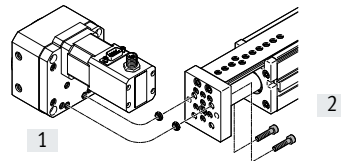
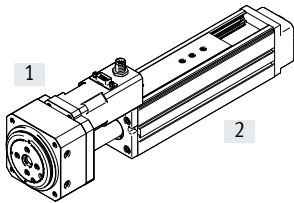

Size		Accessories	
[1] ERMS	[2] EGSL	Centring sleeve	Screw
25	55	ZBH-7 (x2)	M5x14 (x2)
32	55	ZBH-7 (x2)	M5x14 (x2)

Rotary drive unit ERMS on mini slide DGSL

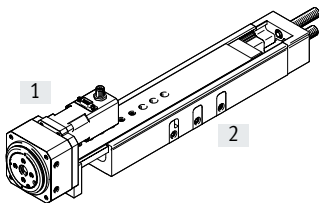

The proximity switch SIEN cannot be used as a reference sensor on the ERMO when ERMO-12 is combined with DGSL-12.

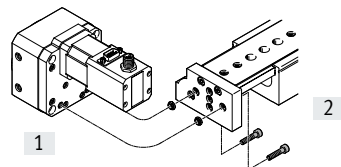

Size		Accessories	
[1] ERMS	[2] DGSL	Centring sleeve	Screw
25	20	ZBH-9-7 (x2)	M5x22 (x2)
25	25	ZBH-9-7 (x2)	M5x22 (x2)

Type codes

001	Series
ERMS	Rotary drive

002	Size
25	25
32	32

003	Nominal swivel angle
90	90°
180	180°

004	Motor type
ST	Stepper motor ST

005	Controller
M	Integrated

006	Control panel
H1	Integrated

007	Bus protocol/activation
PLK	PNP and IO-Link®
NLK	NPN and IO-Link®

008	End-position sensing
AA	With integrated end-position sensing

009	Cable outlet direction
	Standard
L	Left
R	Right

010	Electrical accessories
	None
L1	Adapter for operation as IO-Link® device

011	Operating instructions
	With operating instructions
DN	No operating instructions

Peripherals overview

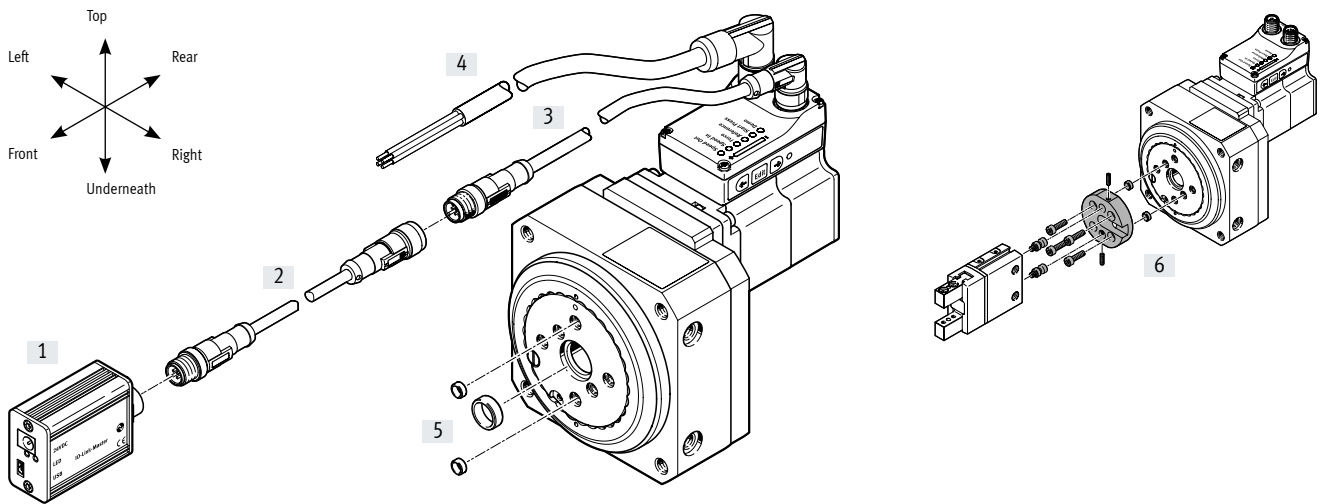

Cable outlet direction

Standard

[L] Left

[R] Right

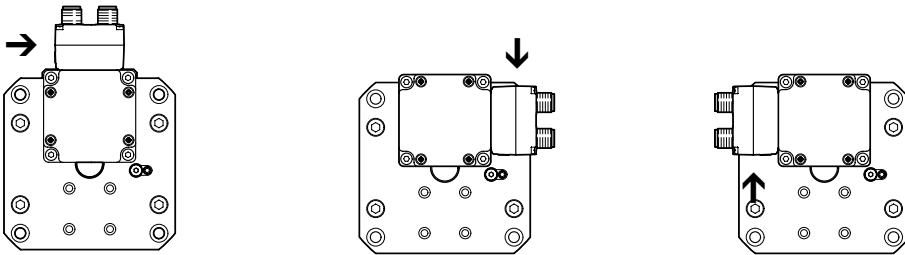

Control elements

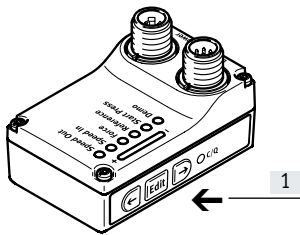



[1] Pushbutton actuators for parameterisation and control

Peripherals overview

Accessories		
Type/order code	Description	→ Page/Internet
[1] IO-Link master USB CDSU-1	For straightforward use of the mini slide unit via IO-Link	21
[2] Adapters NEFC-M12G8	<ul style="list-style-type: none"> • Connection between the motor and the IO-Link master • Only recommended for use with IO-Link port class A master 	21
[3] Connecting cable NEBC-M12	For connection to a controller	20
[4] Supply cable NEBL-T12	For connecting load and logic supply	20
[5] Centring sleeve ZBH	<ul style="list-style-type: none"> • For centring attachments • For centring the rotary drive 	20
[6] Adapter kit DHAA	For drive/gripper connections	adapter kit

Datasheet

-  Size
25, 32
-  Rotation angle
90°, 180°



General technical data			
Size		25	32
Design		Electromechanical rotary drive with integrated drive	
Rotation angle		90, 180	
Gear ratio		9:1	7:1
Mounting position		Any	
Additional functions		Built-in end-position sensing User interface	
Display		LED	
Homing		Positive fixed stop block Negative fixed stop block	
Type of mounting		With female thread	
Max. cable length			
Inputs/outputs	[m]	15	
IO-Link operation	[m]	20	
Product weight		1472	2304

Mechanical data			
Size		25	32
Permissible mass moment of inertia	[kgcm ²]	65	164
Peak torque	[Nm]	2.7	5.6
Max. speed ¹⁾	[rpm]	150	100
Max. speed at 90°	[rpm]	105	100
Speed "Speed Press" ²⁾	[rpm]	3	2
Angular acceleration ²⁾	[rad/s ²]	≤140	
Repetition accuracy	[°]	±0.05	±0.1
Torsional backlash ³⁾	[°]	0.2	0.2

1) Adjustable increments of 10%

2) Unchangeable parameter

3) Without load in new condition

Datasheet

Electrical data			
Size		25	32
Motor			
Nominal voltage DC	[V]	24 (±15%)	
Nominal current	[A]	3	5.3
Max. current consumption (load)	[A]	3	5.3
Max. current consumption (logic)	[mA]	300	
Encoder			
Rotor position sensor		Absolute encoder, single turn	
Rotor position sensor measuring principle		Magnetic	
Rotor position encoder resolution	[bit]	16	
Interfaces			
Size		25	32
Parameterisation interface			
IO-Link		Yes	
User interface		Yes	
Digital inputs			
Number		2	
Switching logic		PNP	
		NPN	
Characteristics		Not galvanically isolated	
		Configurable	
Specification		Based on IEC 61131-2, type 1	
Operating range	[V]	24	
Digital outputs			
Number		2	
Switching logic		PNP	
		NPN	
Rotor position sensor		Absolute encoder, single turn	
Characteristics		Not galvanically isolated	
		Configurable	
Max. current	[mA]	100	

Datasheet

Technical data – IO-Link		
Size	25	32
SIO mode support	Yes	
Communication mode	COM3 (230.4 kBd)	
Connection technology	Plug	
Port class	A	
No. of ports	1	
Process data width OUT	[byte]	2
Process data content OUT	[bit]	1 (Move in)
	[bit]	1 (Move out)
	[bit]	1 (Move Intermediate)
	[bit]	1 (Quit Error)
Process data width IN	[byte]	2
Process data content IN	[bit]	1 (State Device)
	[bit]	1 (State Move)
	[bit]	1 (State in)
	[bit]	1 (State out)
	[bit]	1 (State Intermediate)
Service data content IN	[bit]	32 (Force)
	[bit]	32 (Position)
	[bit]	32 (Speed)
Minimum cycle time	[ms]	1
Data memory required	[kilobyte]	0.5
Protocol version	Device V 1.1	

Operating and environmental conditions		
Size	25	32
Insulation class	B	
Ambient temperature	[°C]	0 ... +50
Storage temperature	[°C]	-20 ... +60
Note on ambient temperature	Above an ambient temperature of 30°C, the power must be reduced by 2% per K	
Temperature monitoring	Switch-off for excessive temperature	
	Integrated precise CMOS temperature sensor with analogue output	
Relative humidity	[%]	0 ... 85
Protection class	III	
Degree of protection	IP40	
Duty cycle	[%]	100
CE marking (see declaration of conformity)	To EU EMC Directive for EMCS-ST → festo.com/sp	
	To EU RoHS Directive	
UKCA marking (see declaration of conformity)	To UK instructions for EMC	
	To UK RoHS instructions	
KC mark	KC EMC	
Certification	RCM	
Vibration resistance	Transport application test with severity level 1 to FN 942017-4 and EN 61800-2 and EN 61800-5-1	
Shock resistance	Shock test with severity level 1 to FN 942017-5 and EN 61800-2	
Maintenance interval	Lifetime lubrication	

Datasheet

Materials

Sectional view

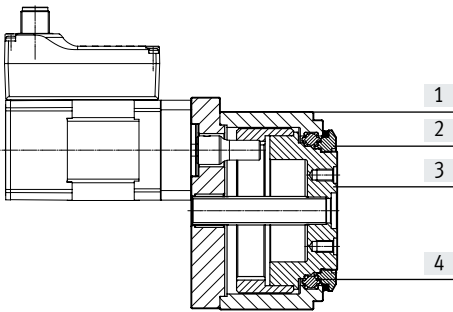

Rotary drive		
[1]	Housing	Anodised wrought aluminium alloy
[2]	Clamping ring	Anodised wrought aluminium alloy
[3]	Rotating plate	Anodised wrought aluminium alloy
[4]	Ball bearings	Rolling bearing steel
	Sealing ring	NBR
	PWIS conformity	VDMA24364 zone III
	Note on materials	RoHS-compliant

Pin allocation

Power supply

Plug

M12x1, 4-pin, T-coded to EN 61076-2-111

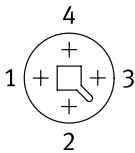

Pin	Function
1	Power voltage supply (24 V DC)
2	Reference potential, power voltage supply (GND)
3	Reserved, do not connect
4	Functional earth (FE)

Logic interface

Plug

M12x1, 8-pin, A-coded to EN 61076-2-101

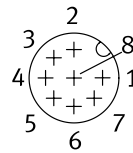

When used with digital I/O	
Pin	Function
1	Logic voltage supply (24 V DC)
2	Digital output 1 (State "In")
3	Digital output 2 (State "Out")
4	Reference potential, logic voltage supply (GND)
5	Digital input 1 (Move "In")
6	Digital input 2 (Move "Out")
7	Reserved, do not connect
8	Reference potential, logic voltage supply (GND)

When used with IO-Link	
Pin	Function
1	L+ IO-Link power supply (24 V DC)
2	Reserved, do not connect
3	C/Q communication with the IO-Link master
4	L – Reference potential, IO-Link power supply (0 V)
5	Reserved, do not connect
6	Reserved, do not connect
7	Reserved, do not connect
8	L – Reference potential, IO-Link power supply (0 V)

Datasheet

Sizing example

Application data:

- Mass moment of inertia: 100 kgcm²
- Mounting position: horizontal
- Rotation angle: 180°
- Max. permitted positioning time: 1 s (one direction)

Step 1: Selecting the possible size from the table → page 8

Mechanical data

Size	25	32
Permissible mass moment of inertia [kgcm ²]	65	164

→ Smallest possible size: ERMS-32-180

Step 2: Selecting the max. speed level v for mass moment of inertia

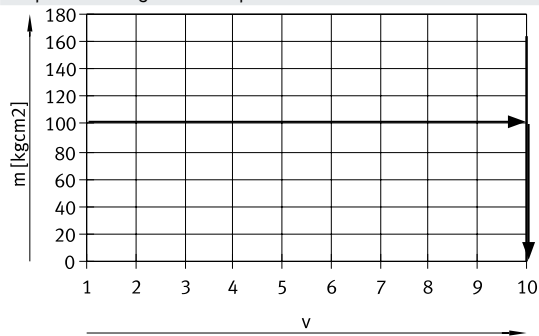

→ Max. speed level for payload: level 10

Step 3: Reading off the min. positioning time t for rotation angle

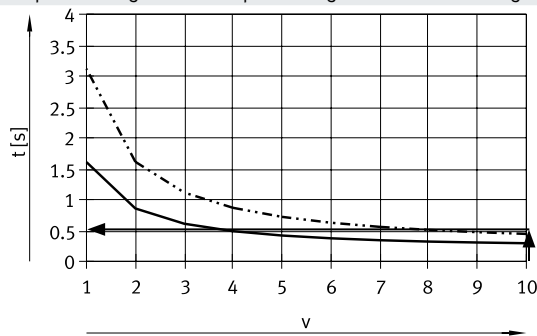

— 90°
- - - 180°

→ Min. positioning time for 180° at level 10: 0.5 s

Result

The application can be implemented using ERMS-32-180. A minimum positioning time (one direction) of 0.5 s is achieved. Longer positioning times can be selected at any time using a lower speed level.

Datasheet

Mass moment of inertia m as a function of speed level v

Size 25

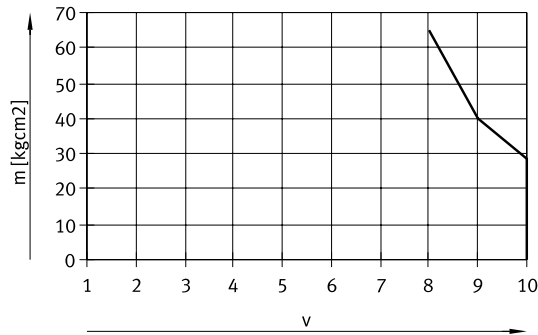

Size 32

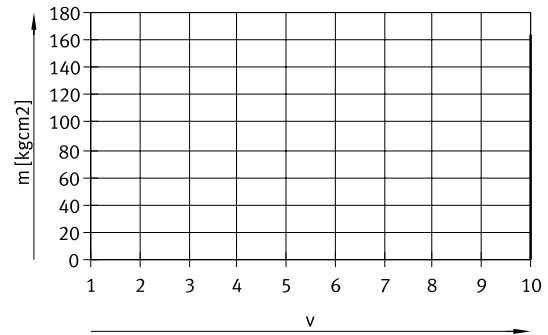

Positioning time t as a function of speed level v and rotation angle

Size 25

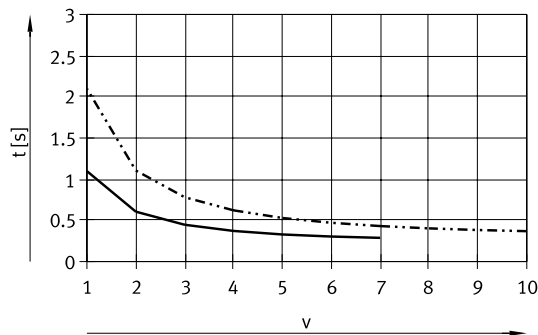

Size 32

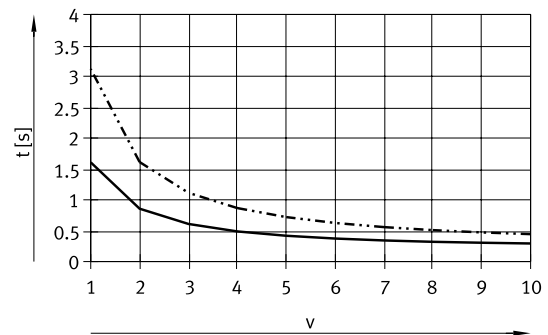

— 90°
- - - 180°

— 90°
- - - 180°

Torque M as a function of force level $F1$

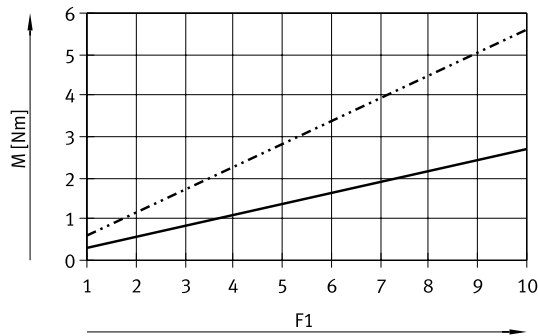

— ERMS-25
- - - ERMS-32

Datasheet

Max. permissible axial and radial force F_x/F_z

Size		25		32
Static				
Axial force F_x	[N]	700		800
Radial force F_z	[N]	1200		2000
Dynamic				
Axial force F_x	[N]	350		450
Radial force F_z	[N]	450		550

Max. dynamic axial force F_x as a function of lever arm l

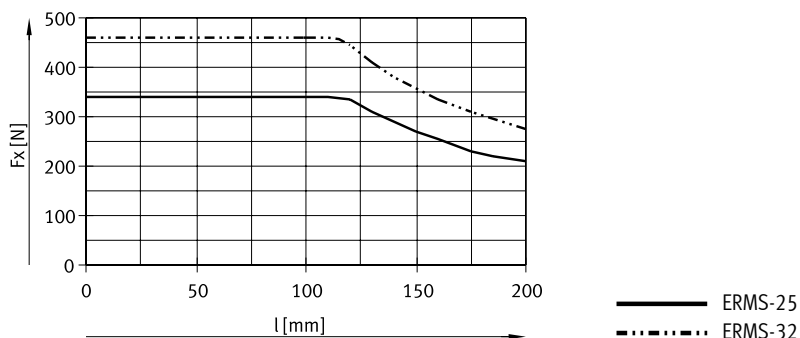
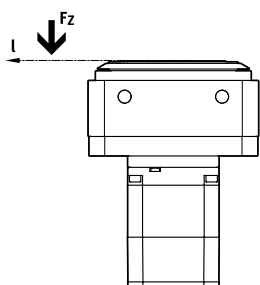

Max. dynamic radial force F_z as a function of lever arm l

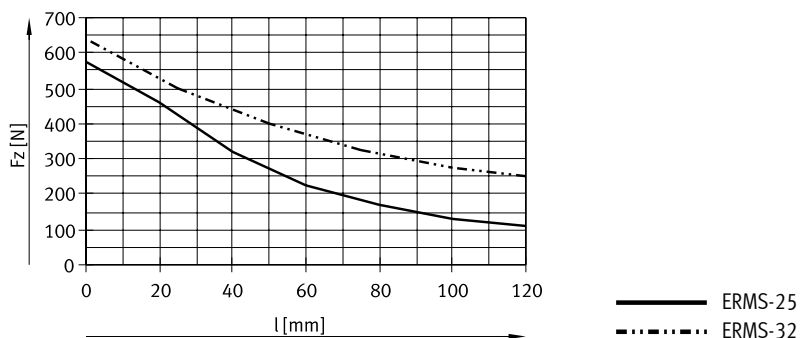
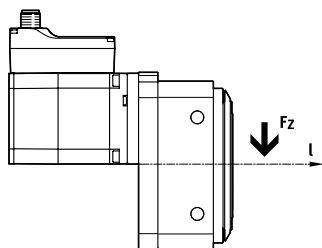

Datasheet

Axial eccentricity and concentricity

Axial eccentricity

Measured on the surface of the rotating plate at the plate edge, in new condition.

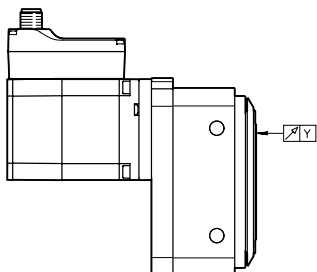

Concentricity

Measured at the centring hole of the rotating plate, when new.

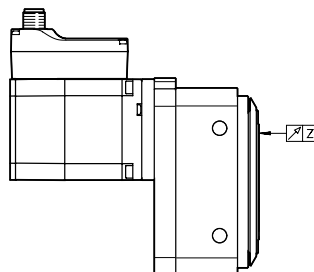

Size		25	32
Axial eccentricity Y	[mm]	<0.02	<0.04
Concentricity Z	[mm]	<0.02	<0.04

Datasheet

Dimensions

Download CAD data → www.festo.com

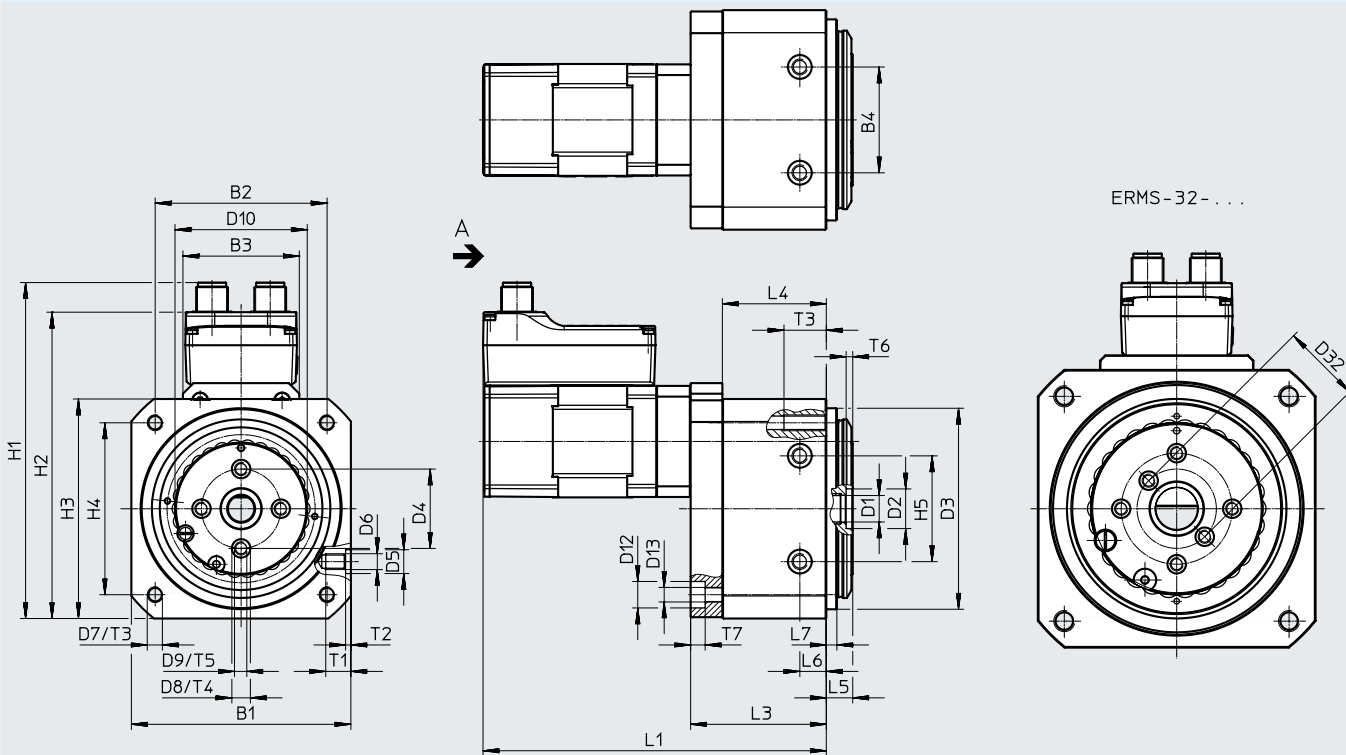

View A

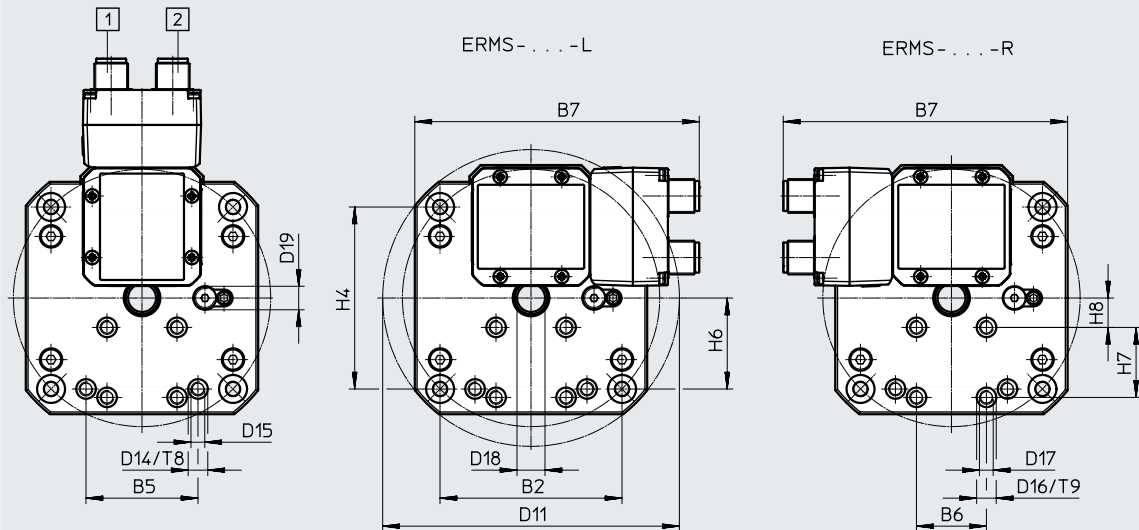

- [1] Connection to logic interface
- [2] Connection for power supply

Datasheet

Size	B1 ±0.3	B2	B3	B4 ±0.03	B5 ±0.02	B6 ±0.02	B7	D1 ∅	D2 ∅ H8	D3 ∅ f8	D4 ∅ ±0.02
25	83	65	44	40	40	25	101.6	10	15	76	30
32	105	85	58	60	–	25	120	16	20	96	42

Size	D5 ∅ H7	D6	D7	D8 ∅ H7	D9	D10 ∅	D11 ∅ ±0.5	D12 ∅	D13 ∅	D14 ∅ H7	D15
25	9	M6	M6	7	M5	50	106	10	5.5	7	M5
32	12	M8	M8	7	M5	65	135	11	6.6	–	–

Size	D16 ∅ H7	D17	D18 max.	D19	D32 ±0.02	H1	H2	H3 ±0.3	H4	H5 ±0.03
25	7	M5	10	M8x1	–	127.1	115.9	83	65	40
32	7	M5	9	M8x1	30	149	137.8	105	85	60

Size	H6	H7 ±0.02	H8	L1 ±1.5	L3 ±0.6	L4	L5 ±0.2	L6 ±0.1	L7 ±0.1	T1
25	32.5	25	10.5	129.8	51.3	39.3	10	10	4	9.5
32	–	25	15	127	46.5	34.5	12	10	6	15

Size	T2 +0.1	T3	T4 +0.1	T5	T6 +0.1	T7	T8	T9
25	2	16	1.5	8.5	2.5	5.5	1.5	1.5
32	2.5	20	1.5	10	2.8	6.8	–	1.5

Ordering data

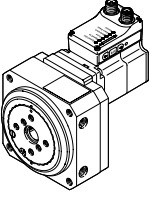
Ordering data	Size	Rotation angle	Part no.	Type
	25	90°	8087819	ERMS-25-90-ST-M-H1-PLK-AA
		180	8087820	ERMS-25-180-ST-M-H1-PLK-AA
	32	90°	8087821	ERMS-32-90-ST-M-H1-PLK-AA
		180°	8087822	ERMS-32-180-ST-M-H1-PLK-AA

Ordering data – Modular product system



Ordering table					
Size	25	32	Conditions	Code	Enter code
Module no.	8087808	8087809			
Series	ERMS			ERMS	ERMS
Size	25	32		-...	
Nominal swivel angle [°]	90, 180	90, 180		-...	
Motor type	Stepper motor ST			-ST	-ST
Controller	Integrated			-M	-M
Operator panel	Integrated			-H1	-H1
Bus protocol/control	NPN and IO-Link			-NLK	
	PNP and IO-Link			-PLK	
End-position sensing	With integrated end-position sensing			-AA	-AA
Cable outlet direction	Standard				
	Left			-L	
	Right			-R	
Electrical accessories	None				
	Adapter for operation as IO device			+L1	
Operating instructions	With operating instructions				
	Without operating instructions			DN	

Accessories

Ordering data – Centring sleeves				Datasheets → Internet: zbh	
	For size	Description	Part no.	Type	PU ¹⁾
	25	For centring the drive for lateral mounting	8137184	ZBH-9-B	10
	32		8137185	ZBH-12-B	
	25, 32	For centring attachments on the rotating plate	8146544	ZBH-7-B	
	25	For centring attachments in the middle of the rotating plate	191409	ZBH-15	

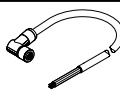
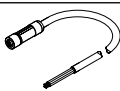
1) Packaging unit

Ordering data – Supply cables				Datasheets → Internet: nebl	
	Electrical connection, left	Electrical connection, right	Cable length [m]	Part no.	Type
	Angled socket, M12x1, 4-pin	Cable, open end, 4-wire	2	8080778	NEBL-T12W4-E-2-N-LE4
			5	8080779	NEBL-T12W4-E-5-N-LE4
			10	8080780	NEBL-T12W4-E-10-N-LE4
			15	8080781	NEBL-T12W4-E-15-N-LE4
	Straight socket, M12x1, 4-pin	Cable, open end, 4-wire	2	8080790	NEBL-T12G4-E-2-N-LE4
			5	8080791	NEBL-T12G4-E-5-N-LE4
			10	8080792	NEBL-T12G4-E-10-N-LE4
			15	8080793	NEBL-T12G4-E-15-N-LE4

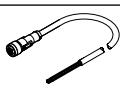
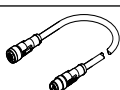
Ordering data – Connecting cables				Datasheets → Internet: nebc	
	Electrical connection, left	Electrical connection, right	Cable length [m]	Part no.	Type
	Angled socket, M12x1, 8-pin	Cable, open end, 8-wire	2	8094476	NEBC-M12W8-E-2-N-B-LE8
			5	8094478	NEBC-M12W8-E-5-N-B-LE8
			10	8094481	NEBC-M12W8-E-10-N-B-LE8
			15	8094479	NEBC-M12W8-E-15-N-B-LE8
	Straight plug, M12x1, 8-pin	Cable, open end, 8-wire	2	8080786	NEBC-M12W8-E-2-N-M12G8
			5	8080787	NEBC-M12W8-E-5-N-M12G8
			10	8080788	NEBC-M12W8-E-10-N-M12G8
			15	8080789	NEBC-M12W8-E-15-N-M12G8
	Straight socket, M12x1, 8-pin	Cable, open end, 8-wire	2	8094480	NEBC-M12G8-E-2-N-B-LE8
			5	8094477	NEBC-M12G8-E-5-N-B-LE8
			10	8094482	NEBC-M12G8-E-10-N-B-LE8
			15	8094475	NEBC-M12G8-E-15-N-B-LE8
	Straight plug, M12x1, 8-pin	Cable, open end, 8-wire	2	8080782	NEBC-M12G8-E-2-N-M12G8
			5	8080783	NEBC-M12G8-E-5-N-M12G8
			10	8080784	NEBC-M12G8-E-10-N-M12G8
			15	8080785	NEBC-M12G8-E-15-N-M12G8

 **Note**
The cables are positioned at a 45° angle to the axis.

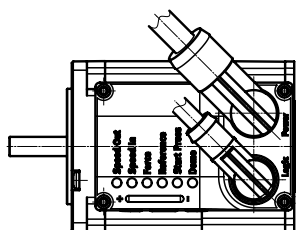

Accessories

Ordering data – IO-Link master USB					Datasheets → Internet: cdsu
	Description	Cable length [m]	Part no.	Type	
	<ul style="list-style-type: none"> For using the unit with IO-Link An external power supply plug is also required (not included in the scope of delivery) 	0.3	8091509	CDSU-1	

Ordering data – Adapter					Datasheets → Internet: nefc
	Electrical connection, left	Electrical connection, right	Cable length [m]	Part no.	Type
	Straight socket, M12x1, 8-pin	<ul style="list-style-type: none"> Straight plug, M12x1, 5-pin Only recommended for use with IO-Link port class A master 	0.3	8080777	NEFC-M12G8-0.3-M12G5-LK