

Accessories for electric positioning systems

FESTO



Key features

At a glance

Elastomer spider couplings EAMC

→ Page 3



- Three-piece coupling with clamping hub, suitable for force-locked and backlash-free transmission of medium and high torques between electric motors and axes.
- System product for positioning technology
- Outside diameter 16, 20, 30, 40, 42, 56, 65, 67 mm

Elastomer spider couplings EAMD, with expanding mandrel

→ Page 8



- Three-piece coupling with expanding mandrel and clamping hub, suitable for force-locked and backlash-free transmission of medium and high torques between electric motors and axes with hollow shaft.
- System product for positioning technology
- Outside diameter 16, 19, 21, 25, 28, 30, 32, 33, 42, 56, 67, 75 mm

Connecting shafts KSK

→ Page 13



Electric axes are often combined to form multi-axis systems. When designing gantry systems with a medium centre distance between the axes and heavy loads, it is particularly important that the two basic axes are actuated synchronously. For these systems, two axes with toothed belt drive are generally coupled with a shared motor and synchronised using a connecting shaft.

Range of applications:

- For synchronising toothed belt axes EGC and ELGA or cantilever axes ELCC
- For torsion-resistant transmission of the necessary torque
- For slip-free transmission of an identical feed speed
- For compensating tolerances and alignment errors between two axes

Type codes

001	Series
EAMC	Coupling

002	Coupling type
	Ring gear coupling

003	Collar diameter [mm]
16	16
19	19
20	20
30	30
40	40
42	42
56	56
65	65
67	67

004	Length
20	20 mm
30	30 mm
32	32 mm
35	35 mm
50	50 mm
58	58 mm
62	62 mm
66	66 mm
90	90 mm
71	71 mm
80	80 mm

005	Inside diameter 1
3	3 mm
4	4 mm
5	5 mm
6	6 mm
6.35	6.35 mm
8	8 mm
9	9 mm
10	10 mm
11	11 mm
12	12 mm
15	15 mm
19	19 mm
20	20 mm
22	22 mm
24	24 mm
25	25 mm
32	32 mm
40	40 mm
XX	Closed

006	Inside diameter 2
5	5 mm
6	6 mm
6.35	6.35 mm
8	8 mm
9	9 mm
10	10 mm
11	11 mm
12	12 mm
14	14 mm
15	15 mm
16	16 mm
19	19 mm
20	20 mm
22	22 mm
24	24 mm
25	25 mm
32	32 mm
40	40 mm

007	Ring gear hardness
	Standard
U	64 Sh D

Datasheet

Elastomer spider coupling EAMC

⊘ Diameter
16 ... 67 mm

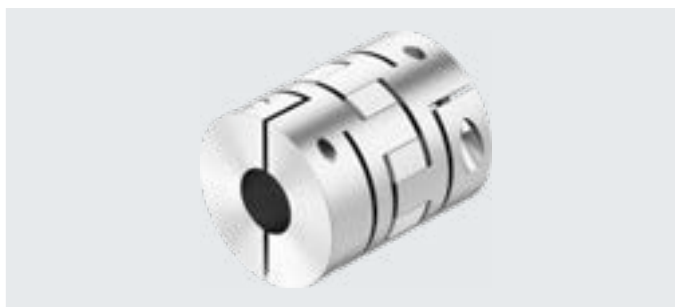

General technical data

Type		EAMC-16-20	EAMC-19-20	EAMC-20-30	EAMC-30-32
Mass moment of inertia	[kg mm ²]	0.28	0.38	1.06	5.87
Tightening torque for clamping screw	[Nm]	0.5	0.5	0.76	4
Max. rotational speed	[rpm]	10000	10000	9000	8000
Corrosion resistance class CRC ¹⁾		1			
Materials	Hubs	Aluminium			
	Ring gear	Polyurethane			
Note on materials		RoHS-compliant			
LABS (PWIS) conformity		VDMA24364-B2-L			

Type		EAMC-30-35	EAMC-40-66	EAMC-42-50	EAMC-42-66	EAMC-56-58
Mass moment of inertia	[kg mm ²]	6.1	42.3	34.8	45.5	128
Tightening torque for clamping screw	[Nm]	2.9	10.5	8	8	15
Max. rotational speed	[rpm]	8000	6500	6000	6000	5500
Corrosion resistance class CRC ¹⁾		1				
Materials	Hubs	Aluminium				
	Ring gear	Polyurethane				
Note on materials		RoHS-compliant				
LABS (PWIS) conformity		VDMA24364-B2-L				

Type		EAMC-65-90	EAMC-67-62	EAMC-67-71	EAMC-67-80
Mass moment of inertia	[kg mm ²]	417	280	302	326
Tightening torque for clamping screw	[Nm]	25	35	35	15
Max. rotational speed	[rpm]	4500	4500	4500	4500
Corrosion resistance class CRC ¹⁾		1			
Materials	Hubs	Aluminium			
	Ring gear	Polyurethane			
Note on materials		RoHS-compliant			
LABS (PWIS) conformity		VDMA24364-B2-L			

1) Corrosion resistance class CRC 1 to Festo standard FN 940070

Low corrosion stress. Dry internal application or transport and storage protection. Also applies to parts behind covers, in the non-visible interior area, or parts which are covered in the application (e.g. drive trunnions).

Datasheet

Dimensions and ordering data

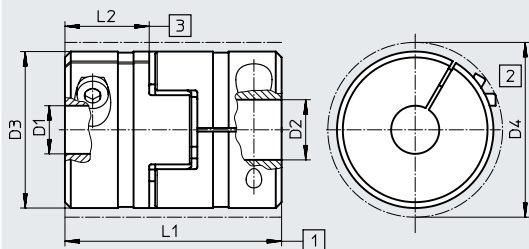
Download CAD data → www.festo.com

- [1] Nominal length with axial offset compensation
 [2] Min. installation diameter (interference profile of the clamping screw)
 [3] Insertion depth

∅	D1 ∅ H7	D2 ∅ H7	D3 ∅	D4 ∅	L1	L2	Transferable torque [Nm]	Weight [g]	Part no.	Type
16	3	5	16	17	20±1	6	0.2	8	562672	EAMC-16-20-3-5
	3	6	16	17	20±1	6	0.2	8	562671	EAMC-16-20-3-6
	3	8	16	17	20±1	6	0.2	8	2310368	EAMC-16-20-3-8
	4	5	16	17	20±1	6	0.7	8	562674	EAMC-16-20-4-5
	4	6	16	17	20±1	6	0.7	8	562673	EAMC-16-20-4-6
	4	8	16	17	20±1	6	0.7	8	562675	EAMC-16-20-4-8
	5	5	16	17	20±1	6	1.1	8	562676	EAMC-16-20-5-5
	5	6	16	17	20±1	6	1.1	8	543419	EAMC-16-20-5-6
	5	8	16	17	20±1	6	1.1	8	562677	EAMC-16-20-5-8
16	6	6	16	17	20±1	6	1.6	8	543420	EAMC-16-20-6-6
	6	8	16	17	20±1	6	1.6	8	1232854	EAMC-16-20-6-8
19	5	9	20	16	20±1	6	1.1	9	8126386	EAMC-19-20-5-9
20	5	6	20	24	30	10	2.2	20	558902	EAMC-20-30-5-6
	6	6	20	24	30	10	2.3	20	558901	EAMC-20-30-6-6
	6	10	20	24	30	10	2.3	20	1451964	EAMC-20-30-6-10
30	5	6	30	-	32±1	10.3	3.5	48	561333	EAMC-30-32-5-6
	5	8	30	-	32±1	10.3	3.5	48	562678	EAMC-30-32-5-8
	6	6	30	-	32±1	10.3	6.5	48	558312	EAMC-30-32-6-6
	6	6.35	30	-	32±1	10.3	6.5	48	551002	EAMC-30-32-6-6.35
	6	8	30	-	32±1	10.3	6.5	48	533708	EAMC-30-32-6-8
	6	9	30	-	32±1	10.3	6.5	48	551003	EAMC-30-32-6-9
	6	10	30	-	32±1	10.3	6.5	48	562681	EAMC-30-32-6-10
	6	11	30	-	32±1	10.3	6.5	48	3187577	EAMC-30-32-6-11
	6	12	30	-	32±1	10.3	6.5	48	8099435	EAMC-30-32-6-12
	6	14	30	-	32±1	10.3	6.5	48	1233256	EAMC-30-32-6-14
	6.35	8	30	-	32±1	10.3	6.5	48	543421	EAMC-30-32-6.35-8
	6.35	10	30	-	32±1	10.3	6.5	48	562679	EAMC-30-32-6.35-10
	8	8	30	-	32±1	10.3	12.5	48	543422	EAMC-30-32-8-8
	8	9	30	-	32±1	10.3	12.5	48	543423	EAMC-30-32-8-9
	8	10	30	-	32±1	10.3	12.5	48	558029	EAMC-30-32-8-10
	8	11	30	-	32±1	10.3	12.5	48	551004	EAMC-30-32-8-11
	8	12	30	-	32±1	10.3	12.5	48	8115760	EAMC-30-32-8-12
	8	14	30	-	32±1	10.3	12.5	48	562682	EAMC-30-32-8-14
	9	10	30	-	32±1	10.3	12.5	48	562680	EAMC-30-32-9-10
	10	10	30	-	32±1	10.3	12.5	48	2310372	EAMC-30-32-10-10
10	11	30	-	32±1	10.3	12.5	48	565008	EAMC-30-32-10-11	
10	14	30	-	32±1	10.3	12.5	48	562683	EAMC-30-32-10-14	

Datasheet

Dimensions and ordering data

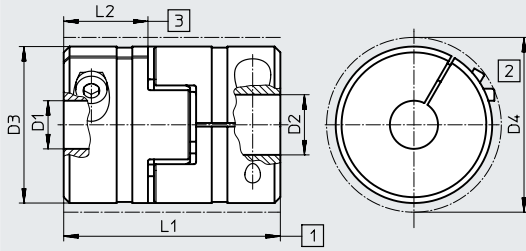
Download CAD data → www.festo.com

- [1] Nominal length with axial offset compensation
 [2] Min. installation diameter (interference profile of the clamping screw)
 [3] Insertion depth

∅	D1 ∅ H7	D2 ∅ H7	D3 ∅	D4 ∅	L1	L2	Transferable torque [Nm]	Weight [g]	Part no.	Type
30	6	6.35	30	31.4	35±0.7	11	7.5	45	530087	EAMC-30-35-6-6.35
	6	8	30	31.4	35±0.7	11	7.5	45	123041	EAMC-30-35-6-8
	6	10	30	31.4	35±0.7	11	7.5	45	1453062	EAMC-30-35-6-10
	6	11	30	31.4	35±0.7	11	7.5	45	123843	EAMC-30-35-6-11
	6.35	8	30	31.4	35±0.7	11	7.5	45	530088	EAMC-30-35-6.35-8
	6.35	12	30	31.4	35±0.7	11	7.5	45	550995	EAMC-30-35-6.35-12
	8	8	30	31.4	35±0.7	11	8	45	123044	EAMC-30-35-8-8
	8	9	30	31.4	35±0.7	11	8	45	557390	EAMC-30-35-8-9
	8	10	30	31.4	35±0.7	11	8	45	123050	EAMC-30-35-8-10
	8	11	30	31.4	35±0.7	11	8	45	123042	EAMC-30-35-8-11
	8	12	30	31.4	35±0.7	11	8	45	123043	EAMC-30-35-8-12
8	14	30	31.4	35±0.7	11	8	45	1453063	EAMC-30-35-8-14	
12	12	30	31.4	35±0.7	11	9.4	45	123052	EAMC-30-35-12-12	
40	10	12	40	45.8	66±0.85	25	21	139	1452794	EAMC-40-66-10-12
	11	11	40	45.8	66±0.85	25	21	139	530090	EAMC-40-66-11-11
	11	12	40	45.8	66±0.85	25	21	139	525864	EAMC-40-66-11-12
	11	14	40	45.8	66±0.85	25	21	139	1452798	EAMC-40-66-11-14
	11	15	40	45.8	66±0.85	25	21	139	550998	EAMC-40-66-11-15
	12	14	40	45.8	66±0.85	25	21	139	1452803	EAMC-40-66-12-14
	12	15	40	45.8	66±0.85	25	21	139	123850	EAMC-40-66-12-15
	12	20	40	45.8	66±0.85	25	21	139	123851	EAMC-40-66-12-20
	15	16	40	45.8	66±0.85	25	21	139	123846	EAMC-40-66-15-16
	15	19	40	45.8	66±0.85	25	21	139	123844	EAMC-40-66-15-19
	15	20	40	45.8	66±0.85	25	21	139	123845	EAMC-40-66-15-20
	15	22	40	45.8	66±0.85	25	21	139	3307627	EAMC-40-66-15-22
	20	24	40	45.8	66±0.85	25	21	139	176034	EAMC-40-66-20-24
	XX ¹⁾	15	40	45.8	66±0.85	25	-	139	176036	EAMC-40-66-XX-15
	XX ¹⁾	20	40	45.8	66±0.85	25	-	139	176037	EAMC-40-66-XX-20

1) Hub predrilled to a diameter of 5 mm. Drilled hole max. 20 mm

Datasheet

Dimensions and ordering data

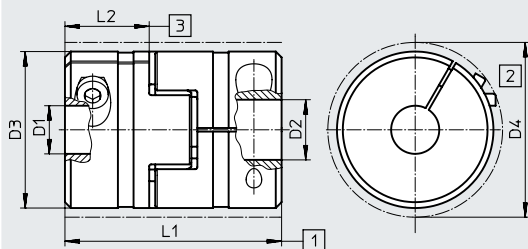
Download CAD data → www.festo.com

- [1] Nominal length with axial offset compensation
 [2] Min. installation diameter (interference profile of the clamping screw)
 [3] Insertion depth

∅	D1 ∅ H7	D2 ∅ H7	D3 ∅	D4 ∅	L1	L2	Transferable torque [Nm]	Weight [g]	Part no.	Type
42	8	19	42	44.5	50±2	17	17	140	2310376	EAMC-42-50-8-19
	9	12	42	44.5	50±2	17	17	146	1732001	EAMC-42-50-9-12
	10	12	42	44.5	50±2	17	17	145	1455666	EAMC-42-50-10-12
	11	12	42	44.5	50±2	17	17	138	543424	EAMC-42-50-11-12
	12	12	42	44.5	50±2	17	17	138	533709	EAMC-42-50-12-12
	12	14	42	44.5	50±2	17	17	142	1455671	EAMC-42-50-12-14
	12	14	42	44.5	50±2	17	17	143	8099432	EAMC-42-50-12-14-U
	12	16	42	44.5	50±2	17	17	140	1232880	EAMC-42-50-12-16
	12	16	42	44.5	50±2	17	17	141	8099433	EAMC-42-50-12-16-U
	12	19	42	44.5	50±2	17	17	138	551005	EAMC-42-50-12-19
	12	20	42	44.5	50±2	17	17	135	2138701	EAMC-42-50-12-20
12	24	42	44.5	50±2	17	17	130	558314	EAMC-42-50-12-24	
	11	12	42	44.5	66±2	25	17	166	558313	EAMC-42-66-11-12
56	19	19	56	57	58±2	19.9	60	285	1485673	EAMC-56-58-19-19
	19	20	56	57	58±2	19.9	60	284	3181801	EAMC-56-58-19-20
	19	22	56	57	58±2	19.9	60	283	8099430	EAMC-56-58-19-22
	19	24	56	57	58±2	19.9	60	277	1485674	EAMC-56-58-19-24
	19	25	56	57	58±2	19.9	60	275	558315	EAMC-56-58-19-25
	20	22	56	57	58±2	19.9	60	281	8134825	EAMC-56-58-20-22
	22	24	56	57	58±2	19.9	60	274	8134826	EAMC-56-58-22-24
	22	25	56	57	58±2	19.9	60	272	8099431	EAMC-56-58-22-25
	24	25	56	57	58±2	19.9	60	265	558316	EAMC-56-58-24-25
65	15	24	65	72.6	90±1.1	35	80	535	530940	EAMC-65-90-15-24
	25	32	65	72.6	90±1.1	35	92	535	1745817	EAMC-65-90-25-32
	XX ²⁾	25	65	72.6	90±1.1	35	-	535	176038	EAMC-65-90-XX-25
67	24	24	66.5	68	62±2	21	143	436	1451407	EAMC-67-62-24-24
	24	25	66.5	68	62±2	21	143	435	3187895	EAMC-67-62-24-25
	24	32	66.5	68	62±2	21	143	428	1485796	EAMC-67-62-24-32
	24	32	66.5	68	62±2	21	143	462	8165044	EAMC-67-71-24-32-U
	24	40	66.5	68	62±2	21	143	429	8134949	EAMC-67-71-24-40-U
	25	32	66.5	68	62±2	21	143	513	8134828	EAMC-67-80-25-32-U
	25	40	66.5	68	62±2	21	143	480	8134948	EAMC-67-80-25-40-U
	32	32	66.5	68	62±2	21	143	490	8134829	EAMC-67-80-32-32-U
	32	40	66.5	68	62±2	21	143	458	8134950	EAMC-67-80-32-40-U
	40	40	66.5	68	62±2	21	143	424	8134953	EAMC-67-80-40-40-U

2) Hub predrilled to a diameter of 9.5 mm. Drilled hole max. 38 mm

Type codes

001	Series
EAMD	Ring gear coupling with expanding mandrel

002	Collar diameter [mm]
16	16
19	19
21	21
25	25
28	28
30	30
32	32
33	33
42	42
56	56
67	67
75	75

003	Collar length [mm]
15	15
22	22
32	32
40	40
46	46
51	51
54	54
62	62
82	82

004	Inside diameter 1
5	5 mm
6	6 mm
6.35	6.35 mm
8	8 mm
9	9 mm
10	10 mm
11	11 mm
12	12 mm
14	14 mm
16	16 mm
18	18 mm
19	19 mm
20	20 mm
22	22 mm
24	24 mm
25	25 mm
32	32 mm
40	40 mm

005	Expanding mandrel diameter [mm]
8	8
10	10
16	16
23	23
32	32

006	Expanding mandrel length [mm]
X10	10
X12	12
X20	20
X32	32
X25	25
X27	27

007	Ring gear hardness
	Standard
U	64 Sh D

Datasheet

Elastomer spider coupling EAMD, with expanding mandrel

⊖ Diameter
16 ... 75 mm



General technical data		EAMD-16-15	EAMD-19-15	EAMD-21-15	EAMD-25-22	EAMD-28-22	EAMD-30-22
Type							
Mass moment of inertia	[kg mm ²]	0.355	0.445	0.45	3.2	3.5	4.0
Tightening torque for clamping screw D1	[Nm]	0.5	0.5	0.5	2	2	2
Tightening torque for clamping screw D2	[Nm]	2	2	2	4	4	4
Max. rotational speed	[rpm]	10000	10000	10000	8000	8000	8000
Corrosion resistance class CRC ¹⁾		1					
Materials	Hubs	Aluminium					
	Ring gear	Polyurethane					
Note on materials		RoHS-compliant					
LABS (PWIS) conformity		VDMA24364-B2-L					

Type	EAMD-32-32	EAMD-33-22	EAMD-42-40	EAMD-42-48	EAMD-56-46	EAMD-56-54	EAMD-56-56	
Mass moment of inertia	[kg mm ²]	14.5	4.6	39	45	151	172	168
Tightening torque for clamping screw D1	[Nm]	4	2	8	8	15	15	15
Tightening torque for clamping screw D2	[Nm]	9	4	9.5	9.5	32	32	32
Max. rotational speed	[rpm]	8000	8000	6000	6000	5500	5500	5500
Corrosion resistance class CRC ¹⁾		1						
Materials	Hubs	Aluminium						
	Ring gear	Polyurethane						
Note on materials		RoHS-compliant						
LABS (PWIS) conformity		VDMA24364-B2-L						

Type	EAMD-56-62	EAMD-67-51	EAMD-67-60	EAMD-67-82	EAMD-75-51	EAMD-67-91	EAMD-75-51	
Mass moment of inertia	[kg mm ²]	192	374	402	831	425	858	425
Tightening torque for clamping screw D1	[Nm]	15	35	15	35	35	15	35
Tightening torque for clamping screw D2	[Nm]	32	60	60	60	60	60	60
Max. rotational speed	[rpm]	5500	4500	4500	4500	4500	4500	4500
Corrosion resistance class CRC ¹⁾		1						
Materials	Hubs	Aluminium						
	Ring gear	Polyurethane						
Note on materials		RoHS-compliant						
LABS (PWIS) conformity		VDMA24364-B2-L						

1) Corrosion resistance class CRC 1 to Festo standard FN 940070

Low corrosion stress. Dry internal application or transport and storage protection. Also applies to parts behind covers, in the non-visible interior area, or parts which are covered in the application (e.g. drive trunnions).

Datasheet

Dimensions and ordering data

Download CAD data → www.festo.com

EAMD-16/EAMD-19

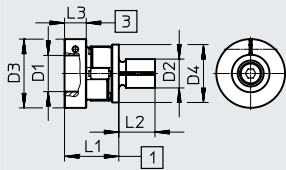

EAMD-...

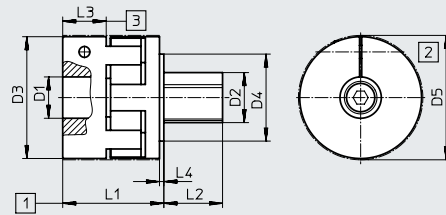

- [1] Nominal length with axial offset compensation
 [2] Min. installation diameter (interference profile of the clamping screw)
 [3] Insertion depth

∅	D1 ∅ H7	D2 ∅ H7	D3 ∅	D4 ∅	D5 ∅	L1	L2	L3	L4	Transferable torque [Nm]	Weight [g]	Part no.	Type
16	5	8	16	-	-	15±1	10	6	-	1.2	13	4819892	EAMD-16-15-5-8X10
	6	8	16	-	-	15±1	10	6	-	1.5	12.8	4819883	EAMD-16-15-6-8X10
	6.35	8	16	-	-	15±1	10	6	-	1.6	12.8	561292	EAMD-16-15-6.35-8X10
	8	8	16	-	-	15±1	10	6	-	2	12	1184697	EAMD-16-15-8-8X10
19	9	8	19	-	-	15±1	10	6	-	2	13.5	557999	EAMD-19-15-9-8X10
	10	8	19	-	-	15±1	10	6	-	2	13	557998	EAMD-19-15-10-8X10
21	11	8	21	-	-	15±1	10	6	-	2	13.7	4820350	EAMD-21-15-11-8X10
	12	8	21	-	-	15±1	10	6	-	2	13.5	4820335	EAMD-21-15-12-8X10
25	6.35	10	25	22	-	22+1	12	8.1	1	3.6	43.7	561293	EAMD-25-22-6.35-10X12
	8	10	25	22	-	22+1	12	8.1	1	8	43.4	5010861	EAMD-25-22-8-10X12
	9	10	25	22	-	22+1	12	8.1	1	9	43.2	3717923	EAMD-25-22-9-10X12
	10	10	25	22	-	22+1	12	8.1	1	9	43.7	1453860	EAMD-25-22-10-10X12
	11	10	25	22	-	22+1	12	8.1	1	9	43.5	558000	EAMD-25-22-11-10X12
	12	10	25	22	-	22+1	12	8.1	1	9	42.1	5029897	EAMD-25-22-12-10X12
28	14	10	28	22	-	22±1	12	8.1	1	9	43	1453861	EAMD-28-22-14-10X12
30	16	10	30	22	-	22±1	12	8.1	1	9	44.8	5030235	EAMD-30-22-16-10X12
32	9	16	32	25	-	32±1	20	10.1	1.5	12.5	127	5038002	EAMD-32-32-9-16X20
	10	16	32	25	-	32±1	20	10.1	1.5	16	126	5273329	EAMD-32-32-10-16X20-U
	11	16	32	25	-	32±1	20	10.1	1.5	12.5	126	558001	EAMD-32-32-11-16X20
	11	16	32	25	-	32±1	20	10.1	1.5	12.5	126	8086050	EAMD-32-32-11-16X20-U
	12	16	32	25	-	32±1	20	10.1	1.5	12.5	125	8070762	EAMD-32-32-12-16X20
	14	16	32	25	-	32±1	20	10.1	1.5	12.5	124	1377840	EAMD-32-32-14-16X20
	14	16	32	25	-	32±1	20	10.1	1.5	12.5	124	8086051	EAMD-32-32-14-16X20-U
	16	16	32	25	-	32±1	20	10.1	1.5	12.5	123	1184858	EAMD-32-32-16-16X20
33	19	10	33	22	-	22±1	12	8.1	1	9	46.1	5030024	EAMD-33-22-19-10X12

Datasheet

Dimensions and ordering data

Download CAD data → www.festo.com

EAMD...

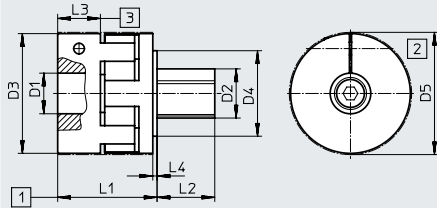

- [1] Nominal length with axial offset compensation
 [2] Min. installation diameter (interference profile of the clamping screw)
 [3] Insertion depth

∅	D1 ∅ H7	D2 ∅ H7	D3 ∅	D4 ∅	D5 ∅	L1	L2	L3	L4	Transferable torque [Nm]	Weight [g]	Part no.	Type
42	10	16	42	25	44.5	40±2	25	17	1.5	17	199	5200227	EAMD-42-40-10-16X25
	11	16	42	25	44.5	40±2	25	17	1.5	17	198	5200234	EAMD-42-40-11-16X25
	12	16	42	25	44.5	40±2	25	17	1.5	17	198	5200241	EAMD-42-40-12-16X25
	14	16	42	25	44.5	40±2	25	17	1.5	21	196	3420022	EAMD-42-40-14-16X25-U
	16	16	42	25	44.5	40±2	25	17	1.5	17	194	5153079	EAMD-42-40-16-16X25
	18	16	42	25	44.5	40±2	25	17	1.5	17	192	5056644	EAMD-42-40-18-16X25
	19	16	42	25	44.5	40±2	25	17	1.5	17	190	558002	EAMD-42-40-19-16X25
	20	16	42	25	44.5	40±2	25	17	1.5	17	189	1188350	EAMD-42-40-20-16X25
	20	16	42	25	44.5	40±2	25	17	1.5	21	189	1781043	EAMD-42-40-20-16X25-U
	22	16	42	25	44.5	40±2	25	17	1.5	17	186	5046328	EAMD-42-40-22-16X25
	16	16	42	25	44.5	48±2	25	25	1.5	17	217	8121126	EAMD-42-48-16-16X25
19	16	42	25	44.5	48±2	25	25	1.5	17	212	8121127	EAMD-42-48-19-16X25	
56	14	23	56	40	57	46.5±2	27	20	2	38	424	5062229	EAMD-56-46-14-23X27
	16	23	56	40	57	46.5±2	27	20	2	48	422	8166642	EAMD-56-46-16-23X27
	18	23	56	40	57	46.5±2	27	20	2	57	419	5063729	EAMD-56-46-18-23X27
	19	23	56	40	57	46.5±2	27	20	2	60	418	558003	EAMD-56-46-19-23X27
	19	23	56	40	57	46.5±2	27	20	2	60	418	8164975	EAMD-56-46-19-23X27-U
	20	23	56	40	57	46.5±2	27	20	2	60	416	558004	EAMD-56-46-20-23X27
	20	23	56	40	57	46.5±2	27	20	2	65	416	8165049	EAMD-56-46-20-23X27-U
	22	23	56	40	57	46.5±2	27	20	2	60	413	4435489	EAMD-56-46-22-23X27
	22	23	56	40	57	46.5±2	27	20	2	72	413	8164974	EAMD-56-46-22-23X27-U
	24	23	56	40	57	46.5±2	27	20	2	60	409	558005	EAMD-56-46-24-23X27
	24	23	56	40	57	46.5±2	27	20	2	75	409	8134726	EAMD-56-46-24-23X27-U
	25	23	56	40	57	46.5±2	27	20	2	60	407	1188801	EAMD-56-46-25-23X27
	25	23	56	40	57	46.5±2	27	20	2	75	407	1781045	EAMD-56-46-25-23X27-U
	32	23	56	40	57	46.5±2	27	20	2	60	390	5063745	EAMD-56-46-32-23X27
	18	23	56	40	57	54.5±2	27	20	2	60	466	5225774	EAMD-56-54-18-23X27
	19	23	56	40	57	54.5±2	27	20	2	60	464	5215476	EAMD-56-54-19-23X27
	22	23	56	40	57	54.5±2	27	20	2	60	457	5226828	EAMD-56-54-22-23X27
	25	23	56	40	57	56.5±2	27	20	2	75	452	8165047	EAMD-56-56-25-23X27-U
	32	23	56	40	57	56.5±2	27	20	2	75	429	8165048	EAMD-56-56-32-23X27-U
20	23	56	40	57	62.5±2	27	20	2	60	507	5228153	EAMD-56-62-20-23X27	

Datasheet

Dimensions and ordering data

Download CAD data → www.festo.com

EAMD-...

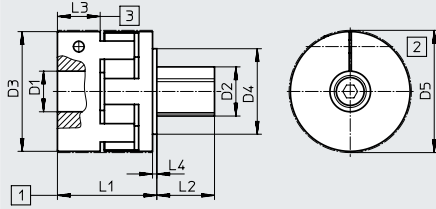

- [1] Nominal length with axial offset compensation
 [2] Min. installation diameter (interference profile of the clamping screw)
 [3] Insertion depth

∅ [mm]	D1 ∅ H7	D2 ∅ H7	D3 ∅	D4 ∅	D5 ∅	L1	L2	L3	L4	Transferable torque [Nm]	Weight [g]	Part no.	Type
67	16	32	66.5	-	68	51±2	32	21	-	93	750	5071095	EAMD-67-51-16-32x32-U
	19	32	66.5	-	68	51±2	32	21	-	113	745	3398671	EAMD-67-51-19-32X32-U
	20	32	66.5	-	68	51±2	32	21	-	120	744	3717812	EAMD-67-51-20-32X32-U
	22	32	66.5	-	68	51±2	32	21	-	133	740	5070937	EAMD-67-51-22-32X32-U
	24	32	66.5	-	68	51±2	32	21	-	143	736	558008	EAMD-67-51-24-32X32-U
	25	32	66.5	-	68	51±2	32	21	-	150	734	558006	EAMD-67-51-25-32X32-U
	32	32	66.5	-	68	51±2	32	21	-	192	717	1379269	EAMD-67-51-32-32X32-U
	25	32	66.5	-	68	60±2	32	21	-	150	789	8164976	EAMD-67-60-25-32X32-U
	32	32	66.5	-	68	60±2	32	21	-	180	766	8164977	EAMD-67-60-32-32X32-U
	40	32	66.5	-	68	60±2	32	21	-	200	733	8164978	EAMD-67-60-40-32X32-U
	24	32	66.5	-	68	82±2	32	21	-	143	1559	558009	EAMD-67-82-24-32X32-U
	25	32	66.5	-	68	82±2	32	21	-	150	1557	558007	EAMD-67-82-25-32X32-U
	32	32	66.5	-	68	82±2	32	21	-	192	1540	1379270	EAMD-67-82-32-32X32-U
32	32	66.5	-	68	91±2	32	21	-	180	858	8165458	EAMD-67-91-32-32X32-U	
75	40	32	75	-	75	51±2	32	21	-	200	741	5078084	EAMD-75-51-40-32x32-U

Type codes

001	Series
KSK	Connecting shaft

002	Product version
	Standard
A	Deviating design

003	Size [mm]
50	50
70	70
80	80
120	120
185	185

004	Nominal length [mm]
...	200 ... 2000 mm

Datasheet

Connecting shafts KSK
For toothed belt axis EGC-TB-KF

Size
50, 70, 80, 120 and 185

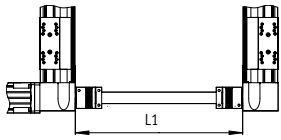

Nominal length L1 = Clear width between the drive covers

The total mass is calculated as follows:
 $m_{total} = m_0 + m_L \times L1$

The moment of inertia is calculated as follows:
 $J_{total} = J_0 + J_L \times L1$

General technical data		50	70	80	120	185
Size		50	70	80	120	185
Design		Connecting tube with a coupling at each end as well as two drive shafts for adapting the hollow shaft				
Mounting position		Horizontal (vertical on request)				
Nominal length L1	[mm]	200 ... 2000			250 ... 2000	350 ... 2000
Basic moment of inertia J ₀ with L1 = 0 mm	[kg mm ²]	34	35	159	1390	7261
Additional moment of inertia J _L per 1 m nominal length	[kg mm ² /m]	34	34	80	333	1946
Max. permissible axial offset	[mm]	±2				±5
Basic weight m ₀ with L1 = 0 mm	[kg]	0.28	0.29	0.53	2.28	5.29
Additional weight m _L per 1 m nominal length	[kg/m]	0.32	0.32	0.48	0.8	1.89

Operating and environmental conditions

Ambient temperature	[°C]	-10 ... +60
Corrosion resistance class CRC ¹⁾		2
Materials		
Coupling, hub		Wrought aluminium alloy
Coupling, bellows		Steel, high-alloy
Connecting tube, drive shafts		Steel, high-alloy
Note on materials		
		RoHS-compliant
		Contains paint-wetting impairment substances

1) Corrosion resistance class CRC 2 to Festo standard FN 940070

Moderate corrosion stress. Indoor applications in which condensation can occur. External visible parts with primarily decorative surface requirements which are in direct contact with a normal industrial environment.

Max. rotational speed n as a function of nominal length L1

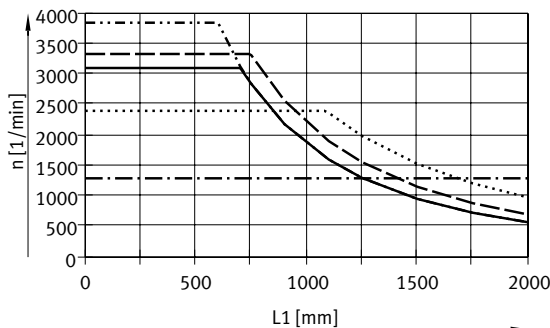

- KSK-50
- - - KSK-70
- - - KSK-80
- KSK-120
- · - · KSK-185

Max. velocity v as a function of nominal length L1

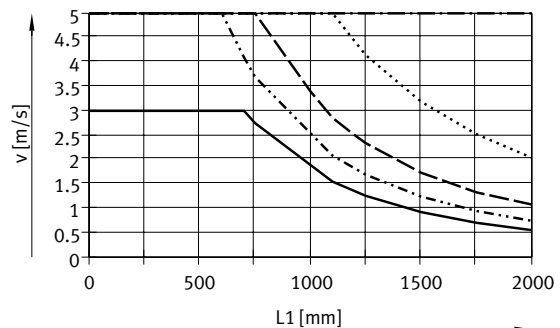

Datasheet

Dimensions and ordering data

Download CAD data → www.festo.com

Internal/external guide

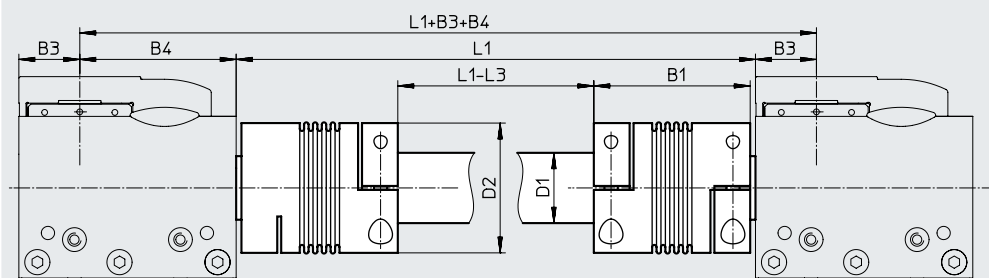

Internal guide

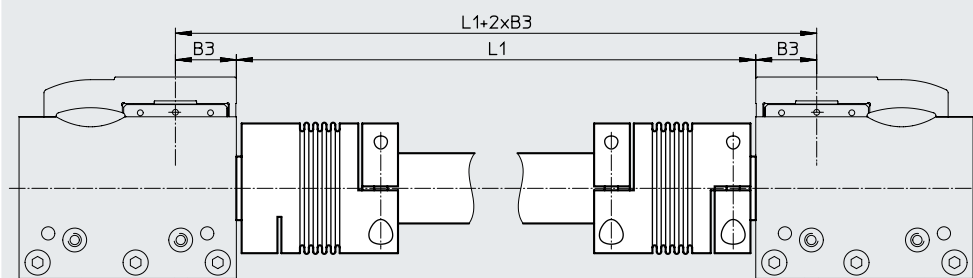

External guide

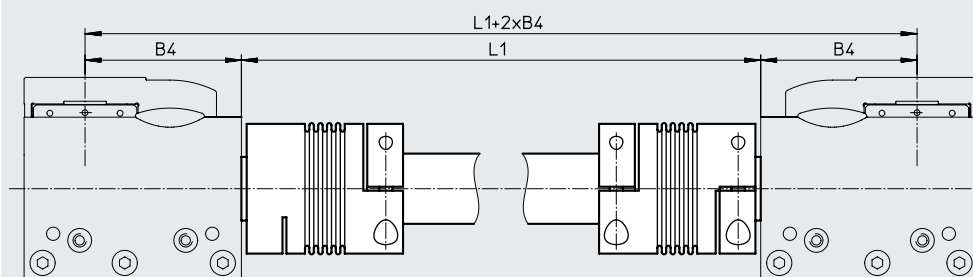

Projection of coupling

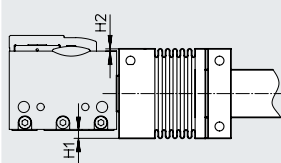

Size of axis [mm]	B1	B3	B4	D1 ∅	D2 ∅	H1	H2	L1	L3	Part no.	Type
50	50	12.5	35.5	21.27	40	4	1	1)	102.2	563710	KSK-50-...
70	50	17.5	51.5	21.27	40	-	-		103.7	562520	KSK-70-...
80	59	23	59	26.52	49	-	-		122	562521	KSK-80-...
120	94	35	85	41.6	81	-	1		192	562522	KSK-120-...
185	111	55	131	65.4	110	-	-		228	562523	KSK-185-...

1) Clear width between the drive covers

Note

The nominal length L1 must be specified in the type code when ordering. The nominal length L1 indicates the clear width between the drive covers in this case.

Order example:
Two toothed belt axes EGC-70-...-TB-KF are to be linked using a connecting shaft with a nominal length L1 = 1000 mm.

The following connecting shaft is required:
Type: KSK-70-1000
Part no. 562520

Datasheet

Connecting shafts KSK
For toothed belt axis ELGA-TB-RF

Size
A-70, 80, 120

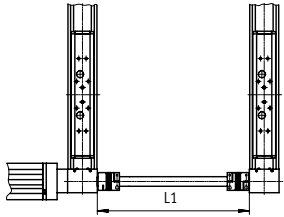
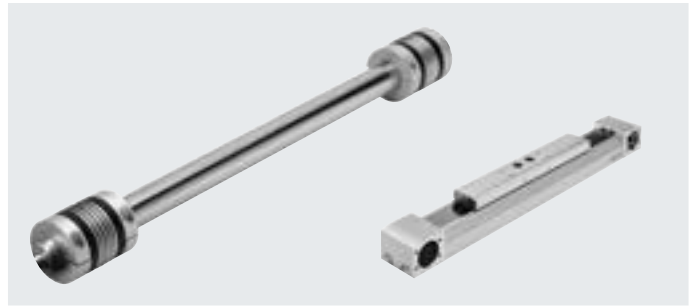

Nominal length L1 = Clear width between the drive covers

The total mass is calculated as follows:
 $m_{total} = m_0 + m_L \times L1$

The moment of inertia is calculated as follows:
 $J_{total} = J_0 + J_L \times L1$

General technical data

Size	A-70	80	120
Design	Connecting tube with a coupling at each end as well as 2 drive shafts for adapting the hollow shaft. With the KSK-185, 2 plugs are additionally supplied for inserting into the tube ends		
Mounting position	Horizontal (vertical on request)		
Nominal length L1 [mm]	200 ... 2000		250 ... 2000
Basic moment of inertia J_0 with L1 = 0 mm [kg mm ²]	161	159	1390
Additional moment of inertia J_L per 1 m nominal length [kg mm ² /m]	80	80	333
Max. permissible axial offset [mm]	±2		
Basic weight m_0 with L1 = 0 mm [kg]	0.54	0.53	2.28
Additional weight m_L per 1 m nominal length [kg/m]	0.48	0.48	0.8

Operating and environmental conditions

Ambient temperature [°C]	-10 ... +60
Corrosion resistance class CRC ¹⁾	2
Materials	
Coupling, hub	Wrought aluminium alloy
Coupling, bellows	Steel, high-alloy
Connecting tube, drive shafts	Steel, high-alloy
Note on materials	RoHS-compliant Contains paint-wetting impairment substances

1) Corrosion resistance class CRC 2 to Festo standard FN 940070
Moderate corrosion stress. Indoor applications in which condensation can occur. External visible parts with primarily decorative surface requirements which are in direct contact with a normal industrial environment.

Max. rotational speed n as a function of nominal length L1

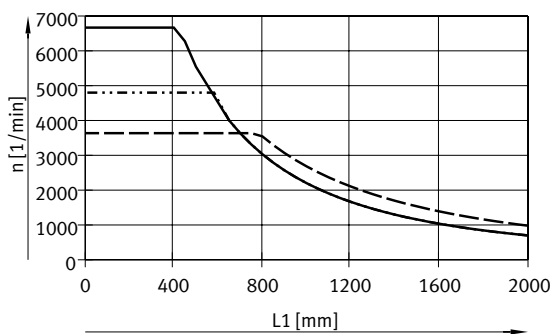

Max. velocity v as a function of nominal length L1

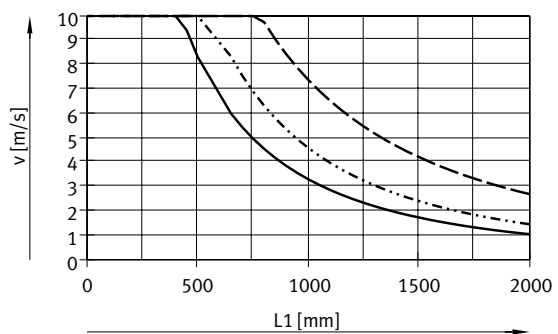

— KSK-A-70
- · - · - KSK-80
- - - KSK-120

Datasheet

Dimensions and ordering data

Download CAD data → www.festo.com

Internal/external guide

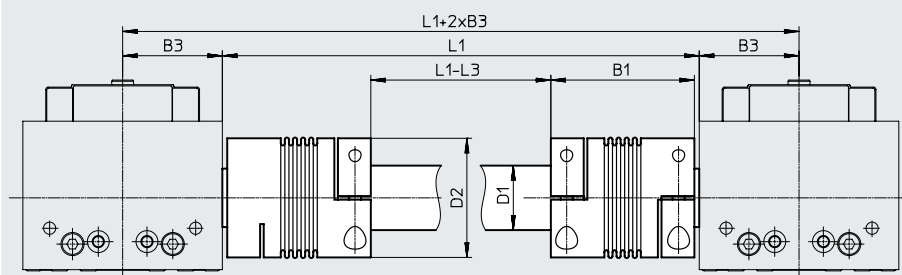

Projection of coupling

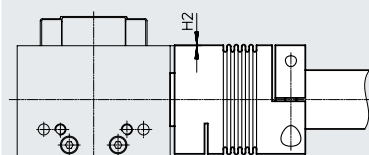

Size of axis [mm]	B1	B3	D1 ∅ H7	D2 ∅	H2	L1	L3	Part no.	Type
70	59	34.5	26.52	49	0.2	1)	122	2261462	KSK-A-70-...
80	59	41	26.52	49	-		122	562521	KSK-80-...
120	94	60	41.6	81	-		192	562522	KSK-120-...

1) Clear width between the drive covers

Note

The nominal length $L1$ must be specified in the type code when ordering. The nominal length $L1$ indicates the clear width between the drive covers in this case.

Order example:
Two toothed belt axes ELGA-TB-RF-80-... are to be linked using a connecting shaft with a nominal length $L1 = 1000$ mm.

The following connecting shaft is required:
Type: KSK-80-1000
Part no. 562521

Datasheet

Connecting shafts KSK
For toothed belt axis ELGA-TB-KF

Size
A-70, 80, 120, 185

The connecting shaft KSK-185 is used in combination with the toothed belt axis ELGA-TB-KF-150.

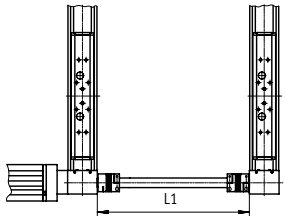

Nominal length L1 = Clear width between the drive covers

The total mass is calculated as follows:
 $m_{total} = m_0 + m_L \times L1$

The moment of inertia is calculated as follows:
 $J_{total} = J_0 + J_L \times L1$

General technical data		A-70	80	120	185
Size		A-70	80	120	185
Design		Connecting tube with a coupling at each end as well as two drive shafts for adapting the hollow shaft. With the KSK-185, 2 plugs are additionally supplied for inserting into the tube ends			
Mounting position		Horizontal (vertical on request)			
Nominal length L1	[mm]	200 ... 2000		250 ... 2000	350 ... 2000
Basic moment of inertia J ₀ with L1 = 0 mm	[kg mm ²]	161	159	1390	7261
Additional moment of inertia J _L per 1 m nominal length	[kg mm ² /m]	80	80	333	1946
Max. permissible axial offset	[mm]	±2			±5
Basic weight m ₀ with L1 = 0 mm	[kg]	0.54	0.53	2.28	5.29
Additional weight m _L per 1 m nominal length	[kg/m]	0.48	0.48	0.8	1.89

Operating and environmental conditions

Ambient temperature	[°C]	-10 ... +60
Corrosion resistance class CRC ¹⁾		2
Materials		
Coupling, hub		Wrought aluminium alloy
Coupling, bellows		Steel, high-alloy
Connecting tube, drive shafts		Steel, high-alloy
Note on materials		RoHS-compliant Contains paint-wetting impairment substances

1) Corrosion resistance class CRC 2 to Festo standard FN 940070
Moderate corrosion stress. Indoor applications in which condensation can occur. External visible parts with primarily decorative surface requirements which are in direct contact with a normal industrial environment.

Max. rotational speed n as a function of nominal length L1

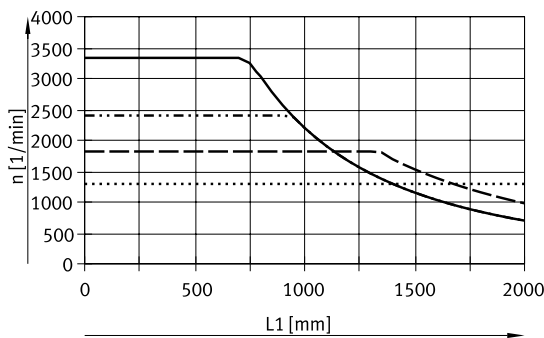

— KSK-A-70 - - - - - KSK-120
- · - · - · - KSK-80 ········· KSK-185

Max. velocity v as a function of nominal length L1

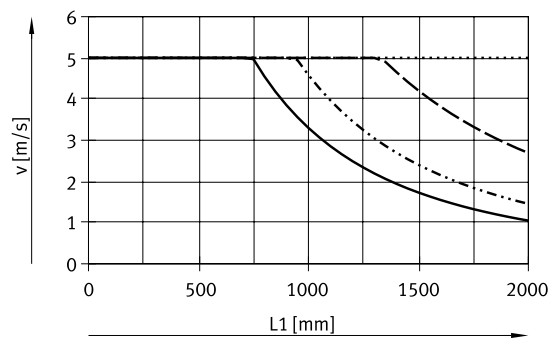

Datasheet

Dimensions and ordering data

Download CAD data → www.festo.com

Internal/external guide

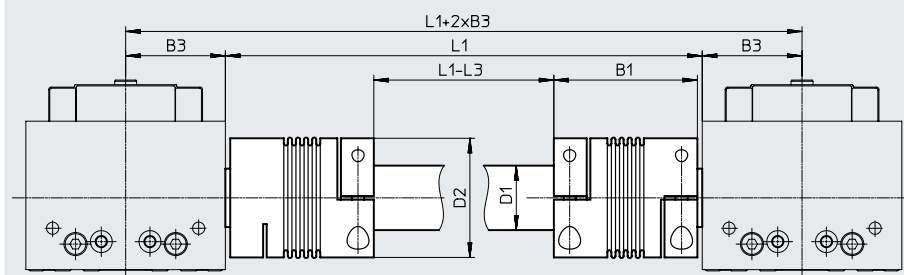

Projection of coupling

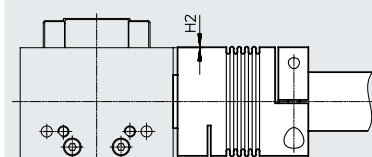

Size of axis [mm]	B1	B3	D1 ∅ H7	D2 ∅	H2	L1	L3	Part no.	Type
70	59	34.5	26.52	49	0.2	1)	122	2261462	KSK-A-70-...
80	59	41	26.52	49	-		122	562521	KSK-80-...
120	94	60	41.6	81	-		192	562522	KSK-120-...
185 ²⁾	111	77	65.4	110	-		228	562523	KSK-185-...

1) Clear width between the drive covers

2) For ELGA-TB-KF-150

 **Note**

The nominal length L1 must be specified in the type code when ordering. The nominal length L1 indicates the clear width between the drive covers in this case.

Order example:
Two toothed belt axes ELGA-TB-KF-80-... are to be linked using a connecting shaft with a nominal length L1 = 1000 mm.

The following connecting shaft is required:
Type: KSK-80-1000
Part no. 562521

Datasheet

Connecting shafts KSK
For cantilever axis ELCC-TB-KF

Size
80, 120, 185

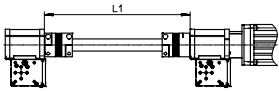

Nominal length L1 = Clear width between the drive covers

The total mass is calculated as follows:
 $m_{total} = m_0 + m_L \times L1$

The moment of inertia is calculated as follows:
 $J_{total} = J_0 + J_L \times L1$

General technical data

Size	80	120	185
Design	Connecting tube with a coupling at each end as well as two drive shafts for adapting the hollow shaft. With the KSK-185, 2 plugs are additionally supplied for inserting into the tube ends		
Mounting position	Horizontal (vertical on request)		
Nominal length L1	[mm] 200 ... 2000	250 ... 2000	350 ... 2000
Basic moment of inertia J ₀ with L1 = 0 mm	[kg mm ²] 159	1390	7261
Additional moment of inertia J _L per 1 m nominal length	[kg mm ² /m] 80	333	1946
Max. permissible axial offset	[mm] ±2		±5
Basic weight m ₀ with L1 = 0 mm	[kg] 0.53	2.28	5.29
Additional weight m _L per 1 m nominal length	[kg/m] 0.48	0.8	1.89

Operating and environmental conditions

Ambient temperature	[°C]	-10 ... +60
Corrosion resistance class CRC ¹⁾		2
Materials		
Coupling, hub		Wrought aluminium alloy
Coupling, bellows		Steel, high-alloy
Connecting tube, drive shafts		Steel, high-alloy
Note on materials		RoHS-compliant Contains paint-wetting impairment substances

1) Corrosion resistance class CRC 2 to Festo standard FN 940070
Moderate corrosion stress. Indoor applications in which condensation can occur. External visible parts with primarily decorative surface requirements which are in direct contact with a normal industrial environment.

Max. rotational speed n as a function of nominal length L1

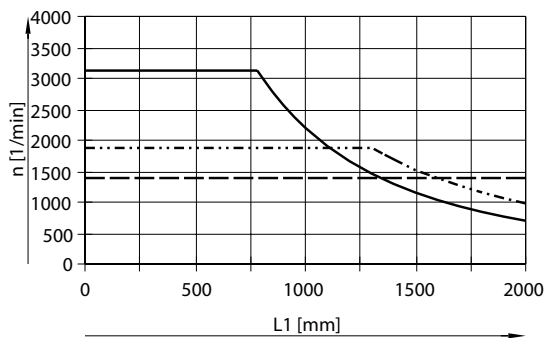

— KSK-80
- · - · - KSK-120
- - - KSK-185

Max. velocity v as a function of nominal length L1

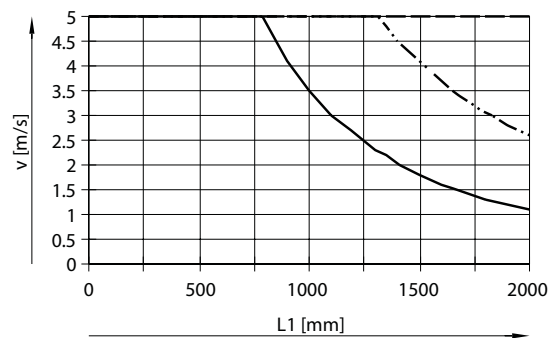

Datasheet

Dimensions and ordering data

Download CAD data → www.festo.com

Axis mounting surfaces facing in the same direction

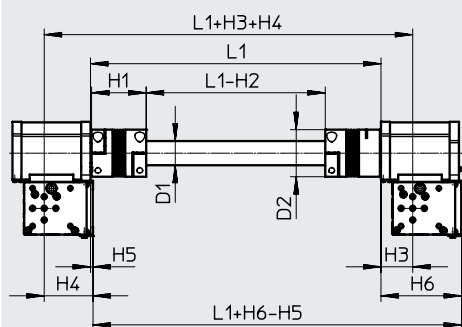

Axis mounting surfaces facing outwards

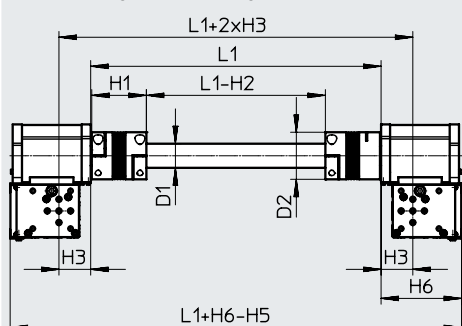

Axis mounting surfaces facing one another

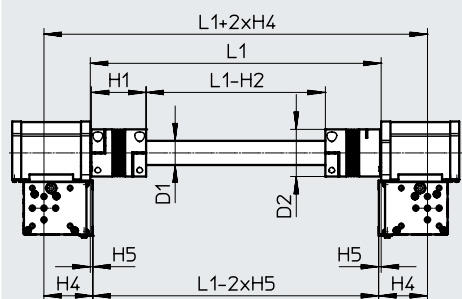

Size of axis [mm]	D1 ∅ H7	D2 ∅	H1	H2	H3	H4	H5	H6	L1	Part no.	Type
60	26.6	49	59	122	43.1	27.1	8.5	78.6	1)	562521	KSK-80-...
70	26.6	49	59	122	48	53.5	10.5	112		562521	KSK-80-...
90	41.7	81	94	192	54.6	79.6	4.4	138.6		562522	KSK-120-...
110	65.5	110	111	228	73.6	85.6	11.4	170.6		562523	KSK-185-...

1) Clear width between the contact surfaces

Note

The nominal length L1 must be specified in the type code when ordering. The nominal length L1 indicates the clear width between the drive covers in this case.

Order example:
Two cantilever axes ELCC-TB-KF-70-... are to be linked using a connecting shaft with a nominal length L1 = 1000 mm.

The following connecting shaft is required:
Type: KSK-80-1000
Part no. 562521