

## Standards-based cylinders DSBG, ISO 15552

**FESTO**



## Characteristics

### At a glance



- Standards-based cylinders to ISO 15552 (corresponds to the withdrawn standards ISO 6431, DIN ISO 6431, VDMA24562, NFE49003.1 and UNI 10290)

- Sturdy tie rod design
- Double-acting
- For contactless position sensing
- Optionally with protection against rotation
- EX4: for use in potentially explosive areas
- Extensive range of accessories makes it possible to install the cylinder virtually anywhere

- Three types of cushioning available:
  - Elastic cushioning: elastic cushioning rings/plates at both ends
  - PPS cushioning: pneumatic cushioning, self-adjusting at both ends
  - PPV cushioning: pneumatic cushioning, adjustable at both ends

- The variants can be configured according to individual needs using a modular product system
- Wide range of variants provides high level of flexibility

### DSBG-...-P2 – With bellows kit DADB, to ISO 15552

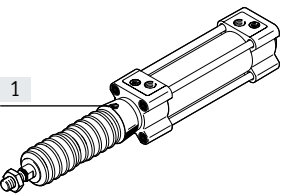

The bellows protects the piston rod, the seal and the bearing from the effects of a wide range of media, which has a positive impact on the service life of these components.

The bellows kit is a leak-free system. To prevent unwanted media from being drawn in, the supply and exhaust air for the kit must be ducted via a pressure compensation hole in the connection part [1].

The kit protects the piston rod, seal and bearing against a wide variety of media, for example:

- Dust
- Chippings
- Oil
- Grease
- Fuel

### Ordering the bellows kit

An extended piston rod is absolutely essential if a bellows kit is to be used. The bellows kit can be ordered via the modular product system or as an accessory. The following must be noted in this case:

#### Ordering via the modular product system:

The bellows kit is supplied mounted on the bearing cap using characteristic P2. The required piston rod extension is automatically taken into consideration. This means that there is no need to specify a value for characteristic ...E.

#### Ordering as an accessory:

If the bellows kit is ordered as an accessory, the required value → page 39 must be entered for characteristic ...E in the modular product system.

### Position sensing/force control

With position transmitter SMAT, SDAT → page 43



Analogue position feedback possible

- Analogue output
  - 0 ... 10 V

With proportional-pressure regulator VPPM













Infinite adjustment of the gripping force possible

- Setpoint value input
  - 0 ... 10 V
  - 4 ... 20 mA

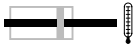
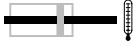
### Variants from the modular product system

| Symbol | Characteristics     | Description  |
|--------|---------------------|--|
|        | Q Square piston rod | Protection against rotation. For correctly oriented feeding  |
|        | L Low friction      | <ul style="list-style-type: none"> <li>Break-away pressure: low</li> <li>Dynamic response: Suitable for very fast movements, especially at low operating pressures</li> </ul> Application example: Very dynamic movements with no standstill |

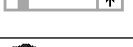
## Characteristics

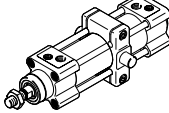
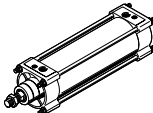
| Variants from the modular product system  |  |  |
|---|--|--|
| Symbol  | Characteristics  | Description  |
|    | U Constant, slow movement  | <ul style="list-style-type: none"> <li>Break-away pressure: very low</li> <li>Dynamic response: Suitable for very slow, constant and stick-slip-free movements</li> </ul> Application example: Slow, constant feed motion  |
|    | L1 Low friction for balancer applications  | <ul style="list-style-type: none"> <li>Break-away pressure: low</li> <li>Dynamic response: Suitable for slow movements with constant application of pressure at one end. System friction is independent of operating pressure</li> </ul> Application example: Applications for load balancing (balancer, belt tensioner with constant feed motion) |
|    | T Through piston rod   | For working at both ends with the same force in the forward and return stroke, for attaching external stops  |
|    | F Female piston rod thread   | –  |
|    | R3 High corrosion protection   | All external cylinder surfaces comply with corrosion resistance class 3 to Festo standard 940 070. The piston rod is made from corrosion- and acid-resistant steel   |
|    | T1 Heat-resistant seals  | Temperature range 0 ... +120°C   |
|    | T3 Low temperature   | Temperature range –40 ... +80°C  |
|    | T4 Heat-resistant seals  | Temperature range 0 ... +150°C   |
|    | A2 Wiper variant   | Hard scraper:<br>The cylinder has a hard-chromium plated piston rod and a hard scraper, which protects against dry, dusty and viscous media  |
|   | A3 Wiper variant   | Unlubricated operation:<br>Cleaning processes degrease the piston rod. A special piston rod seal designed for unlubricated operation permits a longer service life compared to the standard seal.  |
|  | A6 Wiper variant   | Metal scraper:<br>The cylinder has a hard-chromium plated piston rod and metal scraper, which scrapes off hard particles (e.g. welding spatter) sticking to the piston rod.<br>For use in welding systems, for example   |
|  | ...E Extended piston rod   | 1 ... 500 mm   |
|  | ...L Extended piston rod thread  | 1 ... 70 mm  |
|   | ...S Shortened piston rod thread   | 1 ... 44 mm  |
|   | M... Piston rod thread   | Piston rod thread version:<br>M16/M16x1.5/M20/M20x1.5/M24/M27  |
|  | ...V Swivel mounting position  | <ul style="list-style-type: none"> <li>Swivel mounting, position freely selectable</li> <li>Position can be moved at any time</li> </ul>   |
|  | Thread length of spacer bolts:<br>...LB2 on the bearing cap<br>...LB3 on the end cap | <ul style="list-style-type: none"> <li>Variable thread length: 20 ... 140 mm</li> <li>Optionally on the bearing or end cap</li> </ul>  |

Product range overview

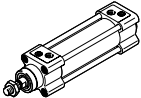
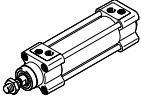
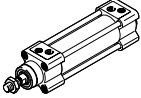
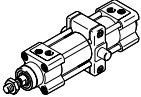
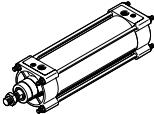
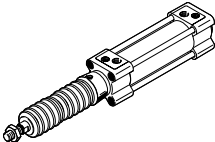
| Function  | Design  | Type                    | Piston diameter              | Stroke      | Through piston rod | Female piston rod thread | Cushioning |   |   |     |
|---|---|-------------------------|------------------------------|-------------|--------------------|--------------------------|------------|---|---|-----|
|   |   |                         | [mm]                         | [mm]        |                    |                          | T          | F | P | PPS |
| Double-acting   | <b>DSBG-...</b>   |                         |                              |             |                    |                          |            |   |   |     |
|   |    | DSBG-...                | 32, 40, 50, 63, 80, 100, 125 | 1 ... 2800  |                    | ■                        | ■          | ■ | ■ | ■   |
|   | <b>DSBG-...-Q – With protection against rotation</b>                                |                         |                              |             |                    |                          |            |   |   |     |
|   |    | DSBG-...-Q              | 32, 40, 50, 63, 80, 100      | 1 ... 1500  |                    | ■                        | ■          | ■ | ■ | ■   |
|   | <b>DSBG-...-L/-U/-L1 – With special running characteristics</b>                     |                         |                              |             |                    |                          |            |   |   |     |
|   |    | DSBG-...-L              | 32, 40, 50, 63, 80, 100      | 1 ... 2800  |                    | –                        | ■          | ■ | ■ | ■   |
|   |   | DSBG-...-U              | 32, 40, 50, 63, 80, 100, 125 | 1 ... 2800  |                    | –                        | ■          | ■ | ■ | ■   |
|   |   | DSBG-...-L1             | 32, 40, 50, 63, 80, 100, 125 | 10 ... 1000 |                    | –                        | ■          | ■ | ■ | –   |
|   | <b>DSBG-...-V – With swivel mounting position</b>                                   |                         |                              |             |                    |                          |            |   |   |     |
|   |  | DSBG-...-V              | 32, 40, 50, 63, 80, 100, 125 | 10 ... 2800 |                    | ■                        | ■          | ■ | ■ | ■   |
| <b>DSBG-...-LB2/3 – With spacer bolts on the bearing/end cap</b>                    |   |                         |                              |             |                    |                          |            |   |   |     |
|  | DSBG-...-LB2/3  | 80, 100, 125            | 10 ... 2800                  |             | ■                  | ■                        | ■          | ■ | ■ |     |
| <b>DSBG-...-P2 – With bellows</b>   |   |                         |                              |             |                    |                          |            |   |   |     |
|  | DSBG-...-P2   | 32, 40, 50, 63, 80, 100 | 10 ... 500                   |             | ■                  | ■                        | ■          | ■ | ■ |     |

## Product range overview

| Type  | Position sensing | High corrosion protection | Temperature range<br>0 ... +120°C | Temperature range<br>-40 ... +80°C | Temperature range<br>0 ... +150°C | Wiper variant<br>Hard scraper | Wiper variant<br>for unlubricated operation | Wiper variant<br>Metal scraper | EU certification | Extended piston<br>rod | Extended piston rod thread | Shortened piston rod thread |
|---|------------------|---------------------------|-----------------------------------|------------------------------------|-----------------------------------|-------------------------------|---|--------------------------------|------------------|------------------------|----------------------------|-----------------------------|
|   | A                | R3                        | T1                                | T3                                 | T4                                | A2                            | A3  | A6                             | EX4              | ..E                    | ..L                        | ..S                         |
| <b>DSBG-...</b>   |                  |                           |                                   |                                    |                                   |                               |   |                                |                  |                        |                            |                             |
| DSBG-...  | ■                | ■                         | ■                                 | ■                                  | ■                                 | ■                             | ■   | ■                              | ■                | ■                      | ■                          | ■                           |
| <b>DSBG-...-Q – With protection against rotation</b>                |                  |                           |                                   |                                    |                                   |                               |   |                                |                  |                        |                            |                             |
| DSBG-...-Q  | ■                | ■                         | ■                                 | -                                  | -                                 | -                             | -   | -                              | ■                | ■                      | ■                          | ■                           |
| <b>DSBG-...-L/-U/-L1 – With special running characteristics</b>     |                  |                           |                                   |                                    |                                   |                               |   |                                |                  |                        |                            |                             |
| DSBG-...-L  | ■                | -                         | -                                 | -                                  | -                                 | -                             | -   | -                              | -                | ■                      | ■                          | ■                           |
| DSBG-...-U  | ■                | -                         | -                                 | -                                  | -                                 | -                             | -   | -                              | -                | ■                      | ■                          | ■                           |
| DSBG-...-L1   | ■                | -                         | -                                 | -                                  | -                                 | -                             | -   | -                              | -                | ■                      | ■                          | ■                           |
| <b>DSBG-...-...V – With swivel mounting position</b>                |                  |                           |                                   |                                    |                                   |                               |   |                                |                  |                        |                            |                             |
| DSBG-...-...V   | ■                | -                         | ■                                 | ■                                  | ■                                 | ■                             | ■   | ■                              | ■                | ■                      | ■                          | ■                           |
| <b>DSBG-...-...LB2/3 – With spacer bolts on the bearing/end cap</b> |                  |                           |                                   |                                    |                                   |                               |   |                                |                  |                        |                            |                             |
| DSBG-...-...LB2/3   | ■                | ■                         | ■                                 | ■                                  | ■                                 | ■                             | ■   | ■                              | ■                | ■                      | ■                          | ■                           |
| <b>DSBG-...-P2 – With bellows</b>                                   |                  |                           |                                   |                                    |                                   |                               |   |                                |                  |                        |                            |                             |
| DSBG-...-P2   | ■                | ■                         | -                                 | -                                  | -                                 | -                             | -   | -                              | -                | ■                      | ■                          | ■                           |

## Peripherals overview

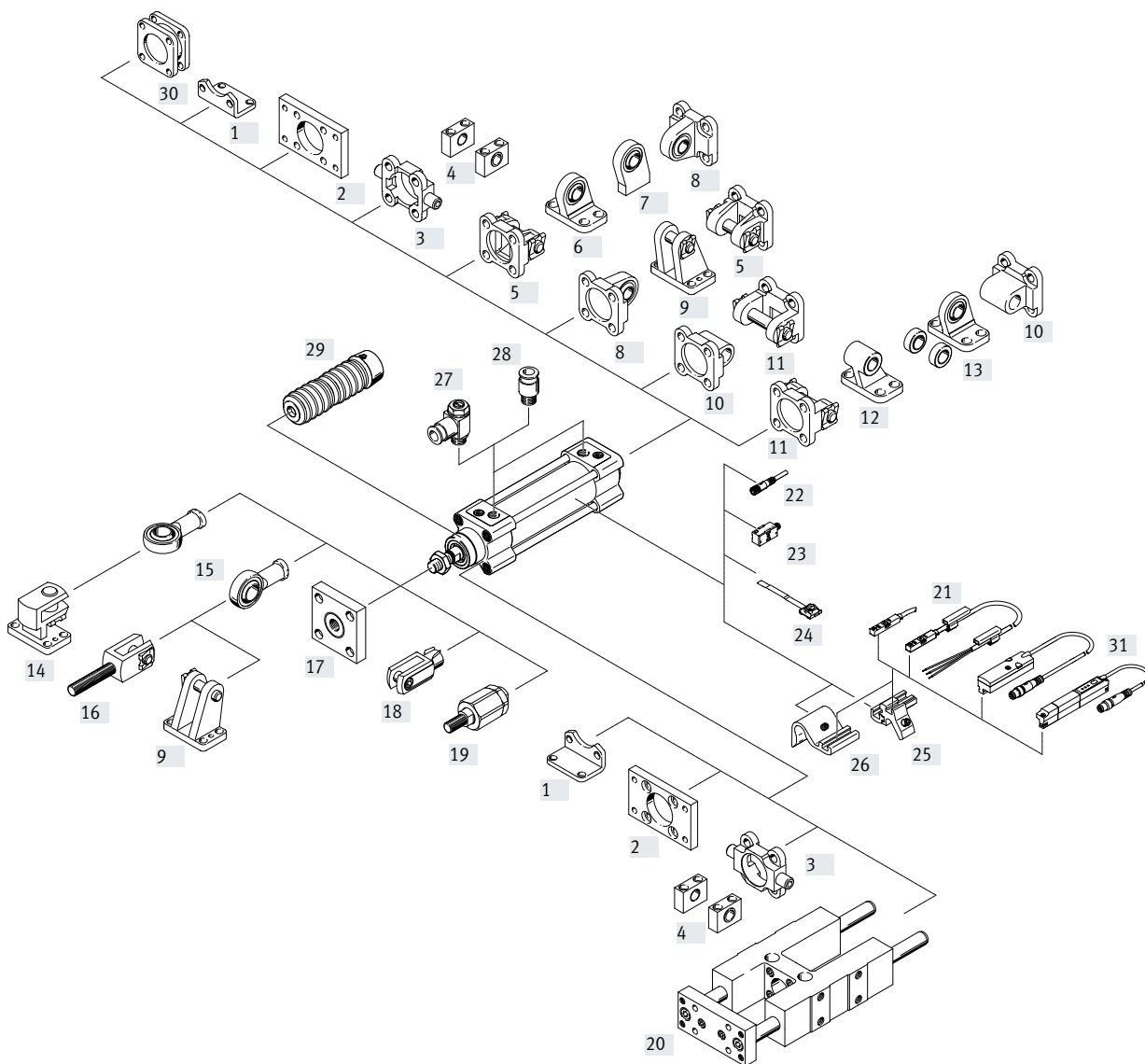

| Mounting components and accessories |                                 | Description   | DSBG-... |               |    | → Page/<br>Internet |
|-------------------------------------|---------------------------------|---|----------|---------------|----|---------------------|
|                                     |                                 |   |          | -L/-U/<br>-L1 | -T |                     |
| [1]                                 | Foot mounting<br>HNC/CRHNC      | For bearing or end caps   | ■        | ■             | ■  | 26                  |
| [2]                                 | Flange mounting<br>FNC/CRFNG    | <ul style="list-style-type: none"> <li>For bearing or end caps</li> <li>Cannot be used on the bearing cap in combination with the bellows kit DADB</li> </ul> | ■        | ■             | ■  | 27                  |
| [3]                                 | Trunnion flange<br>ZNCf/CRZNG   | <ul style="list-style-type: none"> <li>For bearing or end caps</li> <li>Cannot be used on the bearing cap in combination with the bellows kit DADB</li> </ul> | ■        | ■             | ■  | 28                  |
| [4]                                 | Trunnion support<br>LNZG/CRLNZG | –   | ■        | ■             | ■  | 29                  |
| [5]                                 | Swivel flange<br>SNC            | For end caps  | ■        | ■             | –  | 30                  |
| [6]                                 | Clevis foot<br>LSNG             | With spherical bearing  | ■        | ■             | –  | 34                  |

## Peripherals overview

| Mounting components and accessories |  | Description  | DSBG... |               |    | → Page/<br>Internet |
|-------------------------------------|--|--|---------|---------------|----|---------------------|
|                                     |  |  |         | -L/-U/<br>-L1 | -T |                     |
| [7]                                 | Clevis foot<br>LSNSG                     | Weld-on, with spherical bearing  | ■       | ■             | –  | 34                  |
| [8]                                 | Swivel flange<br>SNCS/CRSNCS/SNCS-...-R3 | With spherical bearing for end caps  | ■       | ■             | –  | 32                  |
| [9]                                 | Clevis foot<br>LBG/LBG-...-R3            | –  | ■       | ■             | –  | 34                  |
| [10]                                | Swivel flange<br>SNCL                    | For end caps   | ■       | ■             | –  | 33                  |
| [11]                                | Swivel flange<br>SNCB/SNCB-...-R3        | For end caps   | ■       | ■             | –  | 31                  |
| [12]                                | Clevis foot<br>LNG/CRLNG                 | –  | ■       | ■             | –  | 34                  |
| [13]                                | Clevis foot<br>LSN                       | With spherical bearing   | ■       | ■             | –  | 34                  |
| [14]                                | Right-angle clevis foot<br>LQG           | –  | ■       | ■             | ■  | 34                  |
| [15]                                | Rod eye<br>SGS/CRSGS                     | With spherical bearing   | ■       | ■             | ■  | 35                  |
| [16]                                | Rod clevis<br>SGA                        | With male thread   | ■       | ■             | ■  | 35                  |
| [17]                                | Coupling piece<br>KSG                    | For compensating radial deviations   | ■       | ■             | ■  | 35                  |
|                                     | Coupling piece<br>KSZ                    | For cylinders with a non-rotating piston rod to compensate radial deviations   | ■       | ■             | ■  | 35                  |
| [18]                                | Rod clevis<br>SG/CRSG                    | Permits a swivelling movement of the cylinder in one plane   | ■       | ■             | ■  | 35                  |
| [19]                                | Self-aligning rod coupler<br>FK, CRFK    | For compensating radial and angular deviations   | ■       | ■             | ■  | 35                  |
| [20]                                | Guide unit<br>FENG                       | For protecting standards-based cylinders against rotation at high torques  | ■       | ■             | ■  | 41                  |
| [21]                                | Proximity switch<br>SME/SMT-8M/SDBT-MS   | Can be integrated in the cylinder profile barrel   | ■       | ■             | ■  | 42                  |
| [22]                                | Connecting cable<br>NEBU                 | –  | ■       | ■             | ■  | 43                  |
| [23]                                | Proximity switch<br>SMPO-1-H-B           | –  | ■       | ■             | ■  | 44                  |
| [24]                                | Mounting kit<br>SMBS                     | For proximity switch SMPO-1-H-B  | ■       | ■             | ■  | 43                  |
| [25]                                | Mounting kit<br>SMBZ-8- ...              | For proximity switch SME/SMT-8M, for piston diameter 32 ... 100  | ■       | ■             | ■  | 43                  |
| [26]                                | Sensor bracket<br>DASP-M4- ...           | For proximity switch SME/SMT-8M, for piston diameter 125   | ■       | ■             | ■  | 43                  |
| [27]                                | One-way flow control valve<br>GRLA       | For speed regulation   | ■       | ■             | ■  | 44                  |
| [28]                                | Push-in fitting<br>QS                    | For connecting compressed air tubing with standard O.D.  | ■       | ■             | ■  | qs                  |
| [29]                                | Bellows kit<br>DADB                      | <ul style="list-style-type: none"> <li>Protects the cylinder (piston rod, seal and bearing) against a wide range of media and thus prevents premature wear</li> <li>Can only be used in combination with an extended piston rod (E)</li> </ul> | ■       | –             | ■  | 36                  |
| [30]                                | Multi-position kit<br>DPNC               | For connecting two cylinders with identical piston diameters to form a multi-position cylinder   | ■       | –             | ■  | 40                  |
| [31]                                | Position transmitter<br>SMAT, SDAT       | <ul style="list-style-type: none"> <li>Continuously senses the position of the piston</li> <li>Has an analogue output</li> </ul>   | ■       | ■             | ■  | 43                  |

## Type codes

|      |   |  |
|------|---|--|
| 001  | Series  |  |
| DSBG | Standards-based cylinder, double-acting, based on ISO 15552 |  |

|     |                                  |  |
|-----|----------------------------------|--|
| 002 | Protection against rotation      |  |
|     | None                             |  |
| Q   | With protection against rotation |  |

|     |  |  |
|-----|--|--|
| 003 | Running characteristics                |  |
|     | Standard                               |  |
| L   | Low friction                           |  |
| U   | Uniform, slow movement                 |  |
| L1  | Low friction for balancer applications |  |

|     |                         |  |
|-----|-------------------------|--|
| 004 | Central swivel mounting |  |
|     | None                    |  |
| Y   | Central                 |  |
| V   | Central, clamped        |  |

|     |                 |  |
|-----|-----------------|--|
| 005 | Piston diameter |  |
| 32  | 32              |  |
| 40  | 40              |  |
| 50  | 50              |  |
| 63  | 63              |  |
| 80  | 80              |  |
| 100 | 100             |  |
| 125 | 125             |  |
| 160 | 160             |  |
| 200 | 200             |  |
| 250 | 250             |  |
| 320 | 320             |  |

|     |            |  |
|-----|------------|--|
| 006 | Stroke     |  |
| ... | 1 ... 2800 |  |

|     |                    |  |
|-----|--------------------|--|
| 007 | Piston rod type    |  |
|     | At one end         |  |
| T   | Through piston rod |  |

|     |                        |  |
|-----|------------------------|--|
| 008 | Piston rod thread type |  |
|     | Male thread            |  |
| F   | Female thread          |  |

|     |                            |  |
|-----|----------------------------|--|
| 009 | Piston rod bearing version |  |
| SL  | Sintered bearing           |  |
|     | Polymer bearing            |  |

|     |   |  |
|-----|---|--|
| 010 | Cushioning  |  |
| P   | Elastic cushioning rings/plates on both sides     |  |
| PPS | Pneumatic cushioning, self-adjusting at both ends |  |
| PPV | Pneumatic cushioning, adjustable at both ends     |  |

|     |                      |  |
|-----|----------------------|--|
| 011 | Position sensing     |  |
|     | None                 |  |
| A   | For proximity sensor |  |

|     |                           |  |
|-----|---------------------------|--|
| 012 | Standard                  |  |
|     | Not according to standard |  |
| N3  | Conforms to ISO 15552     |  |

|     |                           |  |
|-----|---------------------------|--|
| 013 | Corrosion protection      |  |
|     | Standard                  |  |
| R3  | High corrosion protection |  |

|     |                                 |  |
|-----|---------------------------------|--|
| 014 | Temperature range               |  |
|     | Standard                        |  |
| T1  | Heat-resistant seals max. 120°C |  |
| T3  | -40 ... +80°C                   |  |
| T4  | 0 ... +150°C                    |  |

|     |                              |  |
|-----|------------------------------|--|
| 015 | Protection against particles |  |
|     | Standard                     |  |
| P2  | Bellows on bearing cap       |  |

|     |                            |  |
|-----|----------------------------|--|
| 016 | Scraper variant            |  |
|     | None                       |  |
| A2  | Hard scraper               |  |
| A3  | For unlubricated operation |  |
| A6  | Metal scraper              |  |

|     |                  |  |
|-----|------------------|--|
| 017 | EU certification |  |
|     | None             |  |
| EX4 | II 2GD           |  |

|      |                          |  |
|------|--------------------------|--|
| 018  | Swivel mounting position |  |
|      | None                     |  |
| ...V | 163 ... 2483 mm          |  |

|      |   |  |
|------|---|--|
| 019  | Trunnion flange mounting position, positive locking |  |
|      | None  |  |
| ...Y | With  |  |

|      |                      |  |
|------|----------------------|--|
| 020  | Piston rod extension |  |
|      | None                 |  |
| ...E | 1 ... 500 mm         |  |

|      |                             |  |
|------|-----------------------------|--|
| 021  | Piston rod thread extension |  |
|      | None                        |  |
| ...L | 0 ... 70 mm                 |  |

|      |                              |  |
|------|------------------------------|--|
| 022  | Piston rod thread shortening |  |
|      | None                         |  |
| ...S | 0 ... 86 mm                  |  |



## Data sheet

Function  
Elastic cushioning

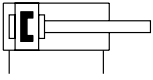

PPV cushioning

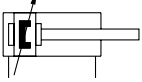

PPS cushioning

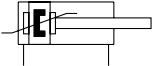

∅ - Diameter  
32 ... 125 mm

- | - Stroke length  
1 ... 2800 mm



www.festo.com

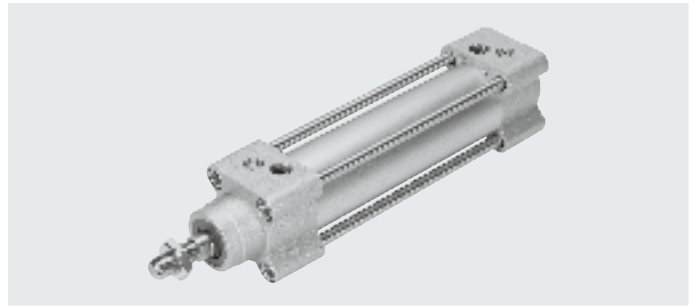

| General technical data |   |             |      |      |      |      |      |      |
|------------------------|---|-------------|------|------|------|------|------|------|
| Piston diameter        |   | 32          | 40   | 50   | 63   | 80   | 100  | 125  |
| Design                 | Piston/piston rod/cylinder barrel                 |             |      |      |      |      |      |      |
| Mode of operation      | Double-acting                                     |             |      |      |      |      |      |      |
| Pneumatic connection   |   | G1/8        | G1/4 | G1/4 | G3/8 | G3/8 | G1/2 | G1/2 |
| Stroke                 |   |             |      |      |      |      |      |      |
| DSBG-...               | [mm]  | 1 ... 2800  |      |      |      |      |      |      |
| DSBG-...-Q             | [mm]  | 1 ... 1500  |      |      |      |      |      | -    |
| DSBG-...-L1            | [mm]  | 10 ... 1000 |      |      |      |      |      |      |
| DSBG-...-P2            | [mm]  | 10 ... 500  |      |      |      |      |      | -    |
| DSBG-...-E             | [mm]  | 1 ... 2000  |      |      |      |      |      |      |
| DSBG-...-L             | [mm]  | 1 ... 2000  |      |      |      |      |      |      |
| Cushioning             |   |             |      |      |      |      |      |      |
| DSBG-...-P             | Elastic cushioning rings/plates at both ends      |             |      |      |      |      |      |      |
| DSBG-...-PPV           | Pneumatic cushioning, adjustable at both ends     |             |      |      |      |      |      |      |
| DSBG-...-PPS           | Pneumatic cushioning, self-adjusting at both ends |             |      |      |      |      |      |      |
| Cushioning length      |   |             |      |      |      |      |      |      |
| DSBG-...-PPV           | [mm]  | 17          | 19   | 22   | 22   | 31   | 31   | 45   |
| Position sensing       | Via proximity switch                              |             |      |      |      |      |      |      |
| Type of mounting       | With female thread/accessories                    |             |      |      |      |      |      |      |
| Mounting position      | Any   |             |      |      |      |      |      |      |

## Data sheet

| Operating and environmental conditions |  |                 |               |              |               |               |               |             |
|--|--|-----------------|---------------|--------------|---------------|---------------|---------------|-------------|
| Piston diameter                        |  | 32              | 40            | 50           | 63            | 80            | 100           | 125         |
| Operating medium                       | Compressed air to ISO 8573-1:2010 [7:4:4]  |                 |               |              |               |               |               |             |
| Note on the operating/pilot medium     | Lubricated operation possible (in which case lubricated operation will always be required) |                 |               |              |               |               |               |             |
| Operating pressure                     |  |                 |               |              |               |               |               |             |
| DSBG-...                               | [MPa]  | 0.06 ... 1.2    |               | 0.04 ... 1.2 |               | 0.02 ... 1.0  |               |             |
|  | [bar]  | 0.6 ... 12      |               | 0.4 ... 12   |               | 0.2 ... 10    |               |             |
| DSBG-...-Q                             | [MPa]  | 0.1 ... 1.2     |               |              |               |               |               | –           |
|  | [bar]  | 1 ... 12        |               |              |               |               |               | –           |
| DSBG-...-L <sup>1)</sup>               | [MPa]  | 0.03 ... 1.2    | 0.025 ... 1.2 |              | 0.02 ... 1.2  | 0.015 ... 1.2 | –             |             |
|  | [bar]  | 0.3 ... 12      | 0.25 ... 12   |              | 0.2 ... 12    | 0.15 ... 12   | –             |             |
| DSBG-...-U <sup>1)</sup>               | [MPa]  | 0.01 ... 1.2    |               |              | 0.005 ... 1.2 |               | 0.005 ... 1.0 |             |
|  | [bar]  | 0.1 ... 12      |               |              | 0.05 ... 12   |               | 0.05 ... 10   |             |
| DSBG-...-L1 <sup>1)</sup>              | [MPa]  | 0.03 ... 1.2    | 0.025 ... 1.2 |              | 0.02 ... 1.2  | 0.015 ... 1.2 | 0.01 ... 1.0  |             |
|  | [bar]  | 0.3 ... 12      | 0.25 ... 12   |              | 0.2 ... 12    | 0.15 ... 12   | 0.1 ... 10    |             |
| DSBG-...-T3/-A2                        | [MPa]  | 0.1 ... 1.2     |               |              |               |               |               | 0.1 ... 1.0 |
|  | [bar]  | 1 ... 12        |               |              |               |               |               | 1 ... 10    |
| DSBG-...-A3                            | [MPa]  | 0.15 ... 1.2    |               | 0.1 ... 1.2  | 0.06 ... 1.2  |               | 0.06 ... 1.0  |             |
|  | [bar]  | 1.5 ... 12      |               | 1 ... 12     | 0.6 ... 12    |               | 0.6 ... 10    |             |
| DSBG-...-A6                            | [MPa]  | 0.2 ... 1.2     | 0.15 ... 1.2  |              |               |               | 0.15 ... 1.0  |             |
|  | [bar]  | 2 ... 12        | 1.5 ... 12    |              |               |               | 1.5 ... 10    |             |
| Ambient temperature <sup>2)</sup>      |  |                 |               |              |               |               |               |             |
| DSBG-...                               | [°C]   | –20 ... +80     |               |              |               |               |               |             |
| DSBG-...-L/-U                          | [°C]   | +5 ... +80      |               |              |               |               |               |             |
| DSBG-...-L1                            | [°C]   | 0 ... +60       |               |              |               |               |               |             |
| DSBG-...-A1                            | [°C]   | 0 ... +80       |               |              |               |               |               |             |
| DSBG-...-A6                            | [°C]   | –20 ... +80     |               |              |               |               |               |             |
| DSBG-...-T1-A6                         | [°C]   | 0 ... +120      |               |              |               |               |               |             |
| DSBG-...-T3-A6                         | [°C]   | –40 ... +80     |               |              |               |               |               |             |
| DSBG-...-T4-A6                         | [°C]   | 0 ... +150      |               |              |               |               |               |             |
| DSBG-...-T1                            | [°C]   | 0 ... +120      |               |              |               |               |               |             |
| DSBG-...-T3                            | [°C]   | –40 ... +80     |               |              |               |               |               |             |
| DSBG-...-T4                            | [°C]   | 0 ... +150      |               |              |               |               |               |             |
| DSBG-...-P2                            | [°C]   | –10 ... +80     |               |              |               |               | –             |             |
| DSBG-...-EX4                           | [°C]   | –20 ... +60     |               |              |               |               |               |             |
| Corrosion resistance CRC               |  |                 |               |              |               |               |               |             |
| DSBG-...                               |  | 2 <sup>3)</sup> |               |              |               |               |               |             |
| DSBG-...-R3                            |  | 3 <sup>4)</sup> |               |              |               |               |               |             |

1) Values apply only for strokes ≤ 500 mm and after 10 double strokes.

In combination with cushioning PPV/PPS, the specifications only apply outside the cushioning range

2) Note operating range of proximity switches.

3) Corrosion resistance class CRC 2 to Festo standard FN 940070

Moderate corrosion stress. Indoor applications in which condensation can occur. External visible parts with primarily decorative surface requirements which are in direct contact with a normal industrial environment.

4) Corrosion resistance class CRC 3 to Festo standard FN 940070

High corrosion stress. Outdoor exposure under moderate corrosive conditions. Externally visible parts with primarily functional surface requirements which are in direct contact with a normal industrial environment.

| Weight [g]                         |  |     |     |      |      |      |      |      |
|------------------------------------|--|-----|-----|------|------|------|------|------|
| Piston diameter                    |  | 32  | 40  | 50   | 63   | 80   | 100  | 125  |
| DSBG-...                           |  |     |     |      |      |      |      |      |
| Product weight with 0 mm stroke    |  | 465 | 740 | 1190 | 1740 | 2660 | 3665 | 6611 |
| Additional weight per 10 mm stroke |  | 25  | 35  | 52   | 55   | 85   | 94   | 143  |
| Moving mass with 0 mm stroke       |  | 110 | 205 | 365  | 430  | 810  | 1000 | 2245 |
| Moving mass per 10 mm stroke       |  | 9   | 16  | 25   | 25   | 39   | 39   | 63   |
| DSBG-...-Q                         |  |     |     |      |      |      |      |      |
| Product weight with 0 mm stroke    |  | 503 | 755 | 1241 | 1821 | 2717 | 3827 | –    |
| Additional weight per 10 mm stroke |  | 24  | 30  | 47   | 50   | 78   | 87   | –    |
| Moving mass with 0 mm stroke       |  | 103 | 170 | 332  | 391  | 757  | 890  | –    |
| Moving mass per 10 mm stroke       |  | 8   | 11  | 20   | 20   | 32   | 32   | –    |

## Data sheet

| <b>Weight [g]</b>                                   |     |     |      |      |      |      |      |
|---|-----|-----|------|------|------|------|------|
| Piston diameter                                     | 32  | 40  | 50   | 63   | 80   | 100  | 125  |
| <b>DSBG-...-L1</b>                                  |     |     |      |      |      |      |      |
| Product weight with 0 mm stroke                     | 465 | 741 | 1200 | 1759 | 2651 | 3693 | 6651 |
| Additional weight per 10 mm stroke                  | 25  | 35  | 52   | 55   | 85   | 94   | 143  |
| Moving mass with 0 mm stroke                        | 110 | 206 | 375  | 449  | 801  | 1028 | 2285 |
| Moving mass per 10 mm stroke                        | 9   | 16  | 25   | 25   | 39   | 39   | 63   |
| <b>DSBG-...-T</b>                                   |     |     |      |      |      |      |      |
| Product weight with 0 mm stroke                     | 581 | 924 | 1523 | 2103 | 3243 | 4353 | 7450 |
| Additional weight per 10 mm stroke                  | 34  | 51  | 77   | 80   | 124  | 133  | 206  |
| Moving mass with 0 mm stroke                        | 181 | 339 | 613  | 684  | 1292 | 1516 | 3084 |
| Moving mass per 10 mm stroke                        | 18  | 32  | 50   | 50   | 78   | 78   | 126  |
| <b>DSBG-...-F</b>                                   |     |     |      |      |      |      |      |
| Product weight with 0 mm stroke                     | 453 | 721 | 1145 | 1695 | 2570 | 3575 | 6389 |
| Additional weight per 10 mm stroke                  | 25  | 35  | 52   | 55   | 85   | 94   | 143  |
| Moving mass with 0 mm stroke                        | 98  | 186 | 320  | 385  | 720  | 910  | 2023 |
| Moving mass per 10 mm stroke                        | 9   | 16  | 25   | 25   | 39   | 39   | 63   |
| <b>DSBG-...E</b>                                    |     |     |      |      |      |      |      |
| Additional weight per piston rod extension of 10 mm | 9   | 16  | 25   | 25   | 39   | 39   | 63   |
| <b>DSBG-...L</b>                                    |     |     |      |      |      |      |      |
| Additional weight per piston rod extension of 10 mm | 6   | 8   | 14   | 14   | 22   | 22   | 41   |

| <b>ATEX<sup>1)</sup></b>                          |   |
|---|---|
| ATEX category for gas                             | II 2G                                       |
| Type of ignition protection for gas               | Ex h IIC T4 Gb                              |
| ATEX category for dust                            | II 2D                                       |
| Type of ignition protection for dust              | Ex h IIIC T120°C Db                         |
| Explosion-proof ambient temperature               | -20°C ≤ Ta ≤ +60°C                          |
| CE marking (see declaration of conformity)        | To EU Explosion Protection Directive (ATEX) |
| UKCA marking (see declaration of conformity)      | To UK EX instructions                       |
| Explosion protection certification outside the EU | EPL Gb (GB)                                 |
|   | EPL Db (GB)                                 |

1) Note the ATEX certification of the accessories.

| <b>Forces [N] and impact energy [J]</b> |     |      |      |      |      |      |      |
|---|-----|------|------|------|------|------|------|
| Piston diameter                         | 32  | 40   | 50   | 63   | 80   | 100  | 125  |
| Theoretical force at 6 bar, advancing   | 483 | 754  | 1178 | 1870 | 3016 | 4712 | 7363 |
| Theoretical force at 6 bar, retracting  | 415 | 633  | 990  | 1682 | 2721 | 4418 | 6881 |
| Max. impact energy in the end positions |     |      |      |      |      |      |      |
| DSBG-...                                | 0.4 | 0.7  | 1.0  | 1.3  | 1.8  | 2.5  | 3.3  |
| DSBG-...-L/-U/-T1/-T3/-T4               | 0.2 | 0.35 | 0.5  | 0.65 | 0.9  | 1.25 | 1.65 |
| DSBG-...-L1                             | 0.1 | 0.2  | 0.3  | 0.4  | 0.9  | 1.25 | 1.65 |

Permissible impact velocity: 
$$V = \sqrt{\frac{2 \times E}{m_1 + m_2}}$$

Maximum permissible mass: 
$$m_2 = \frac{2 \times E}{V^2} - m_1$$

V Perm. impact velocity  
E Max. impact energy  
m1 Moving mass (drive)  
m2 Moving payload

## Data sheet

## Materials

Sectional view

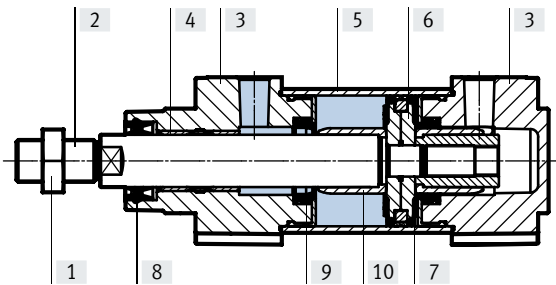

Standards-based cylinder

|      |                           |  |
|------|---------------------------|--|
| [1]  | Nut                       | Galvanised steel                             |
| [2]  | Piston rod                |  |
|      | DSBG-...                  | High-alloy steel                             |
|      | DSBG-...-R3               | High-alloy stainless steel                   |
|      | DSBG-...-A2/-A6           | Hard-chrome-plated tempered steel            |
| [3]  | Cover                     | Coated die-cast aluminium                    |
| [4]  | Bearing                   |  |
|      | DSBG-...                  | POM  |
|      | DSBG-...-A2               | Bronze                                       |
|      | DSBG-...-L/-U/-T1/-T4     | Metal polymer compound                       |
| [5]  | Cylinder barrel           | Anodised wrought aluminium alloy             |
| [6]  | Piston                    | Anodised wrought aluminium alloy             |
| [7]  | Piston seal               |  |
|      | DSBG-...                  | TPE-U(PU)                                    |
|      | DSBG-...-L/-U/-T1/-T4     | FPM  |
|      | DSBG-...-T3               | TPE-U(PU) (suitable for low temperatures)    |
|      | DSBG-...-L1               | HNBR   |
| [8]  | Piston rod wiper seal     |  |
|      | DSBG-...                  | TPE-U(PU)                                    |
|      | DSBG-...-L/-U             | FPM  |
|      | DSBG-...-L1               | HNBR   |
|      | DSBG-...-T1/-T4/-A1       | FPM  |
|      | DSBG-...-T3               | TPE-U(PU) (suitable for low temperatures)    |
|      | DSBG-...-A3               | UHMW-PE                                      |
| [9]  | Buffer seal               |  |
|      | DSBG-...                  | PUR  |
|      | DSBG-...-U                | FPM  |
|      | DSBG-...-T1/-T4           | FPM  |
|      | DSBG-...-T3               | PUR (suitable for low temperatures)          |
| [10] | Cushion piston            |  |
| -    | Tie rods                  |  |
|      | DSBG-...                  | Steel, high-alloy                            |
|      | DSBG-...-R3               | High-alloy stainless steel                   |
| -    | Rod wiper seal            |  |
|      | DSBG-...-A6               | CuZn   |
|      | DSBG-...                  | POM  |
|      | DSBG-...-L/-U             | Aluminium                                    |
|      | DSBG-...-T1/-T3/-T4       | Aluminium                                    |
| -    | Spacer bolt               |  |
|      | DSBC-...-...LB2/-...LB3   | High-alloy stainless steel                   |
| -    | Swivel mounting           |  |
|      | DSBC-...-...V             | Painted spheroidal graphite cast iron        |
| -    | Collar nut                | Galvanised steel                             |
| -    | Note on materials         |  |
|      | DSBG-...                  | RoHS-compliant                               |
|      | DSBG-...-L/-U/-T3/-T4/-A3 | Contains paint-wetting impairment substances |

## Data sheet

### Max. transverse load $F_q$ as a function of stroke length $l$

Horizontal installation

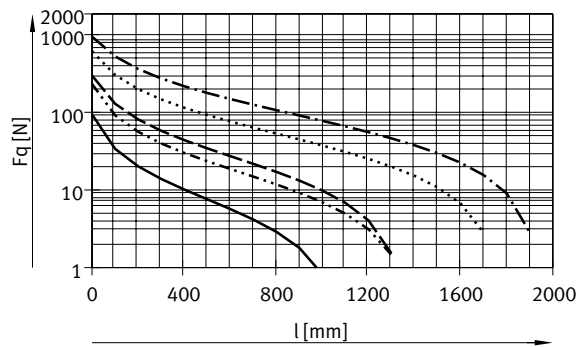

Vertical installation

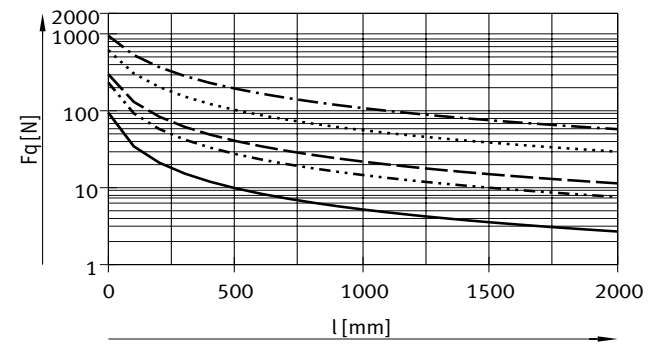

- Diameter 32
- · · · · · Diameter 40
- - - - - Diameter 50/63
- · · · · Diameter 80/100
- · - · - Diameter 125

 **Note**  
No transverse loads are permitted in combination with characteristic DSBG-...-L1.

| Permissible torsional backlash with variant Q – With protection against rotation |     |       |      |       |       |       |       |
|--|-----|-------|------|-------|-------|-------|-------|
| Piston diameter  |     | 32    | 40   | 50    | 63    | 80    | 100   |
| Torsional backlash   | [°] | ±0.65 | ±0.6 | ±0.45 | ±0.45 | ±0.45 | ±0.45 |

Data sheet

Max. transverse load  $F_q$  as a function of stroke length  $l$  and lever arm  $s$

Q – With protection against rotation

Diameter 32

Max. torque = 800 Nmm/max. stroke = 300 mm

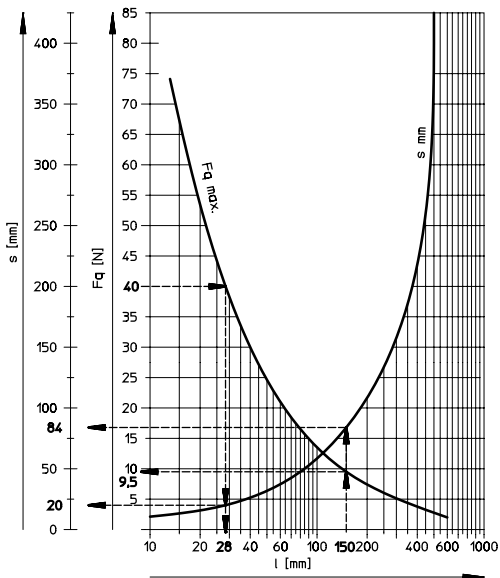

Diameter 40

Max. torque = 1100 Nmm/max. stroke = 400 mm

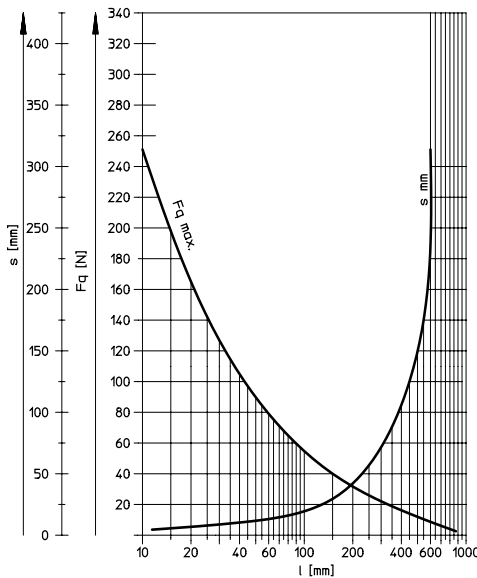

Diameter 50/63

Max. torque = 1500 Nmm/max. stroke = 500 mm

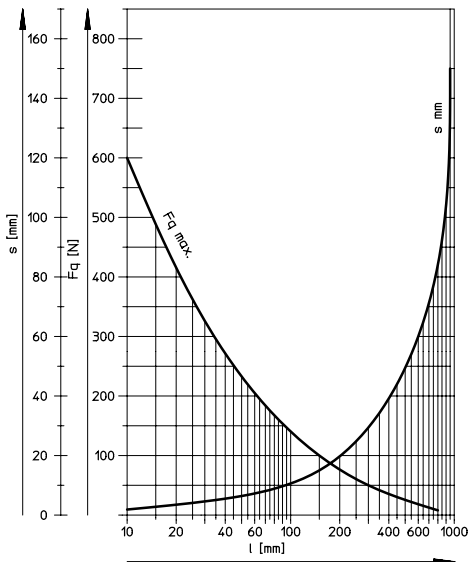

Diameter 80/100

Max. torque = 3000 Nmm/max. stroke = 600 mm

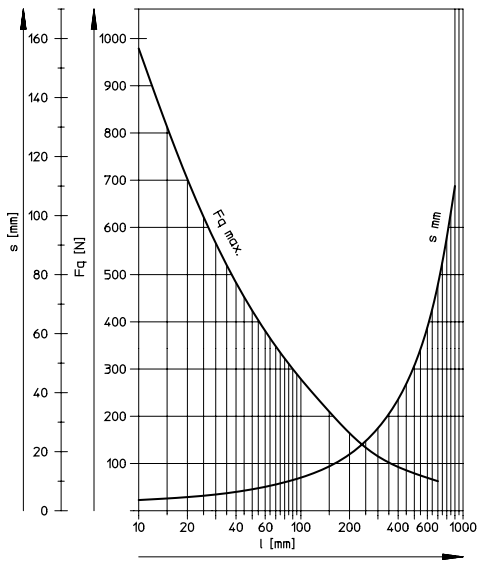

## Data sheet

## Examples for piston diameter 32 mm

## Example 1:

Stroke length l = 150 mm

Result: permissible

Transverse load  $F_q$  = 9.5 N

Lever arm s = 84 mm

## Example 2:

Transverse load  $F_q$  = 40 N

Result: permissible

Stroke length l = 28 mm

Lever arm s = 20 mm

## Example 3:

Stroke length l = 150 mm

Lever arm s = 100 mm

$$F_q = \frac{M}{s} = \frac{800 \text{ Nmm}}{100 \text{ mm}}$$

M = max. torque

s = lever arm

Result: permissible

$$F_q = 8 \text{ N} < F_{q_{\max.}} = 9.5 \text{ N}$$

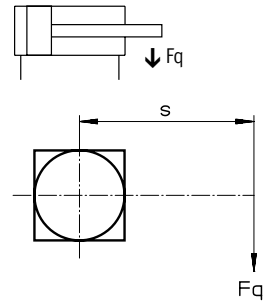

Data sheet

Dimensions

Download CAD data → [www.festo.com](http://www.festo.com)

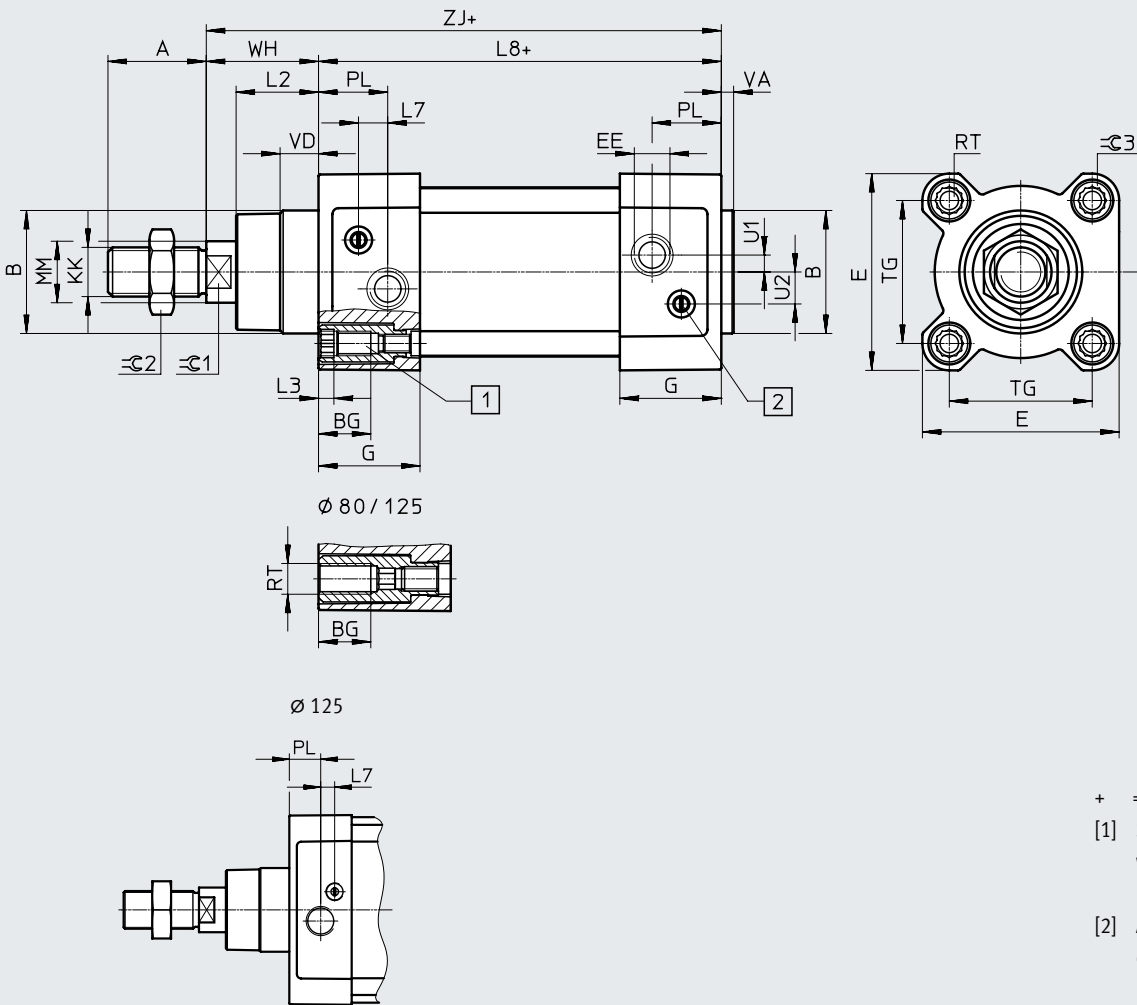

- + = plus stroke length
- [1] Socket head screw with female thread for mounting components
- [2] Adjusting screw for adjustable end-position cushioning (PPV)

Variant  
T – Through piston rod

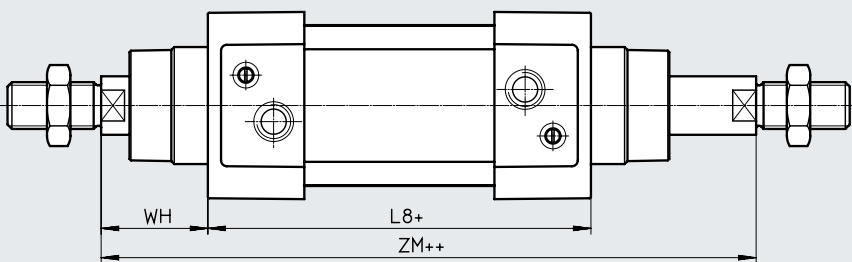

- + = plus stroke length
- ++ = plus 2x stroke length



## Data sheet

| ∅<br>[mm] | A<br>-0.5 | B<br>∅<br>d11 | BG<br>min. | E<br>+0.5 | EE   | G<br>-0.2 | L2                   | L3<br>max. |
|-----------|-----------|---------------|------------|-----------|------|-----------|----------------------|------------|
| 32        | 22        | 30            | 16         | 45        | G1/8 | 28        | 18 <sub>-0.2</sub>   | 5          |
| 40        | 24        | 35            | 16         | 54        | G1/4 | 33        | 21.3 <sub>-0.2</sub> | 5          |
| 50        | 32        | 40            | 16         | 64        | G1/4 | 33        | 26.8 <sub>-0.2</sub> | 5          |
| 63        | 32        | 45            | 16         | 75        | G3/8 | 40.5      | 27 <sub>-0.2</sub>   | 5          |
| 80        | 40        | 45            | 17         | 93        | G3/8 | 43        | 34.2 <sub>-0.2</sub> | –          |
| 100       | 40        | 55            | 17         | 110       | G1/2 | 48        | 38 <sub>-0.2</sub>   | –          |
| 125       | 54        | 60            | 20         | 136       | G1/2 | 44.7      | 45 <sub>-0.3</sub>   | –          |

| ∅<br>[mm] | L7  | L8<br>±0.4 | MM<br>∅ | PL<br>±0.1 | RT  | TG<br>±0.3 | U1<br>±0.1 | U2<br>±0.1 |
|-----------|-----|------------|---------|------------|-----|------------|------------|------------|
| 32        | 6.5 | 94         | 12      | 19.5       | M6  | 32.5       | 5.25       | 5.7        |
| 40        | 7.5 | 105        | 16      | 22.5       | M6  | 38         | 4          | 8          |
| 50        | 9.5 | 106        | 20      | 22.5       | M8  | 46.5       | 5.5        | 10.4       |
| 63        | 9   | 121        | 20      | 27.5       | M8  | 56.5       | 6.25       | 12.75      |
| 80        | 11  | 128        | 25      | 30         | M10 | 72         | 8          | 12.5       |
| 100       | 7.5 | 138        | 25      | 31.5       | M10 | 89         | 10         | 13.5       |
| 125       | 10  | 160        | 32      | 22.5       | M12 | 110        | 8          | 13         |

| ∅<br>[mm] | VA                | VD<br>+0.5 | WH<br>+2.2 | ZJ<br>+1.8 | ZM<br>+1 | ≈G1 | ≈G2 | ≈G3 |
|-----------|-------------------|------------|------------|------------|----------|-----|-----|-----|
| 32        | 4 <sub>-0.2</sub> | 10         | 25         | 119.1      | 146.1    | 10  | 17  | 6   |
| 40        | 4 <sub>-0.2</sub> | 10.5       | 28.7       | 133.9      | 164.8    | 13  | 19  | 6   |
| 50        | 4 <sub>-0.2</sub> | 11.5       | 35.6       | 141.8      | 179.8    | 17  | 24  | 8   |
| 63        | 4 <sub>-0.2</sub> | 15         | 35.9       | 157.1      | 195.4    | 17  | 24  | 8   |
| 80        | 4 <sub>-0.2</sub> | 15.7       | 45.4       | 173.6      | 221      | 22  | 30  | 6   |
| 100       | 4 <sub>-0.2</sub> | 19.2       | 49.3       | 187.5      | 238.8    | 22  | 30  | 6   |
| 125       | 6 <sub>-0.3</sub> | 20.5       | 64.1       | 225        | 290      | 27  | 41  | 8   |

| ∅<br>[mm] | KK       |                                 |
|-----------|----------|---------------------------------|
|           | DSBG-... | -M... <sup>1)</sup>             |
| 32        | M10x1.25 | –                               |
| 40        | M12x1.25 | –                               |
| 50        | M16x1.5  | –                               |
| 63        | M16x1.5  | –                               |
| 80        | M20x1.5  | M16/M16x1.5/M20                 |
| 100       | M20x1.5  | M16/M16x1.5/M20                 |
| 125       | M27x2    | M16/M16x1.5/M20/M20x1.5/M24/M27 |

1) Threads with smaller nominal diameter than in the basic version can generally not withstand such high loads. If necessary, the screw connection must be engineered.

## Data sheet

### Dimensions – Variants

Download CAD data → [www.festo.com](http://www.festo.com)

Q – With protection against rotation

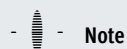
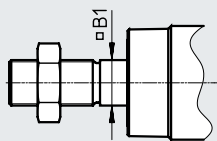

**Note**  
In combination with variant T, the piston rod is protected against rotation at one end.

F – Female thread

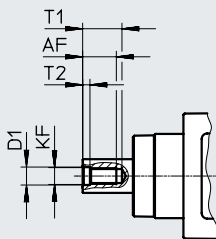

**Note**  
In combination with variant T, the piston rod has female threads at both ends.

...E – Extended piston rod

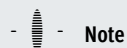
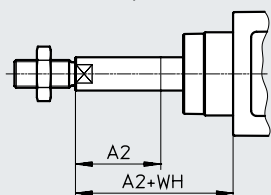

**Note**  
In combination with variant T, the piston rod is extended at one end.  
In combination with variants T and Q, the piston rod is extended only at the square piston rod.

...L – Extended piston rod thread

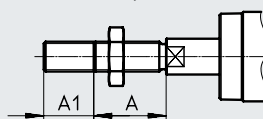

**Note**  
In combination with variant T, the piston rod thread is extended at both ends.

.....S – Shortened piston rod thread

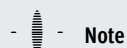
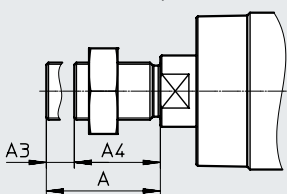

**Note**  
In combination with variant T, the piston rod thread is shortened at both ends.

Effective thread length:  $A4 = A - A3$

| ∅<br>[mm] | A  | A1   |      | A2   |      | A3   |      |
|-----------|----|------|------|------|------|------|------|
|           |    | min. | max. | min. | max. | min. | max. |
| 32        | 22 | 1    | 35   | 1    | 500  | –    | –    |
| 40        | 24 | 1    | 35   | 1    | 500  | –    | –    |
| 50        | 32 | 1    | 70   | 1    | 500  | –    | –    |
| 63        | 32 | 1    | 70   | 1    | 500  | –    | –    |
| 80        | 40 | 1    | 70   | 1    | 500  | 1    | 30   |
| 100       | 40 | 1    | 70   | 1    | 500  | 1    | 30   |
| 125       | 54 | 1    | 70   | 1    | 500  | 1    | 44   |

| ∅<br>[mm] | AF   | B1 | D1   | KF  | T1<br>max. | T2  | WH<br>+2.2 |
|-----------|------|----|------|-----|------------|-----|------------|
|           | min. |    |      |     |            |     |            |
| 32        | 12   | 10 | 6.4  | M6  | 16         | 2.6 | 25         |
| 40        | 12   | 12 | 8.4  | M8  | 16         | 3.3 | 28.7       |
| 50        | 16   | 16 | 10.5 | M10 | 21         | 4.7 | 35.6       |
| 63        | 16   | 16 | 10.5 | M10 | 21         | 4.7 | 35.9       |
| 80        | 20   | 20 | 13   | M12 | 26.5       | 6.1 | 45.4       |
| 100       | 20   | 20 | 13   | M12 | 26.5       | 6.1 | 49.3       |
| 125       | 32   | –  | 17   | M16 | 40         | 8   | 64.1       |

Data sheet

Dimensions – Variants

Download CAD data → [www.festo.com](http://www.festo.com)

...V – Swivel mounting position

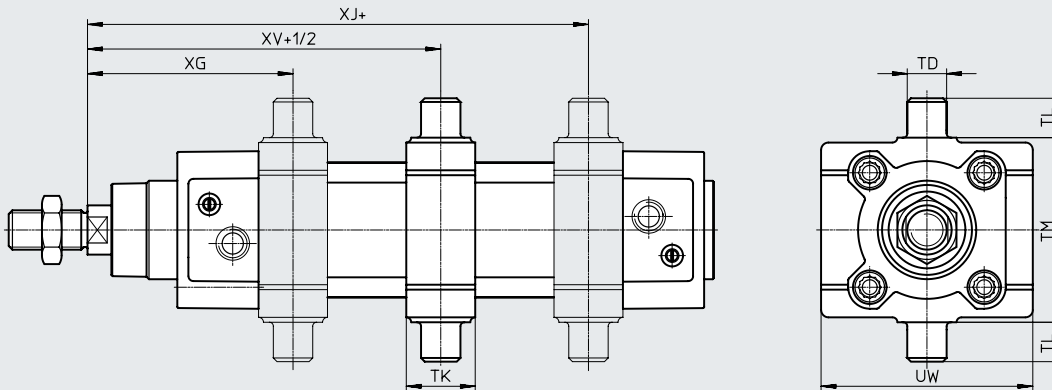

Note

The dimensions for the swivel mounting position (...V) refer to the basic design without piston rod extension.

The swivel mounting can be moved at any time.

+ = plus stroke length  
+1/2 = plus half stroke length

| ∅<br>[mm] | TD<br>∅<br>e9 | TK | TL<br>h14 | TM<br>h14 | UW  | XG<br>min. | XJ<br>max. | XV        |
|-----------|---------------|----|-----------|-----------|-----|------------|------------|-----------|
| 32        | 12            | 20 | 12        | 50        | 65  | 64±1.4     | 81±1.4     | 73±1.4    |
| 40        | 16            | 25 | 16        | 63        | 72  | 74.2±1.4   | 88.4±1.4   | 81.2±1.4  |
| 50        | 16            | 28 | 16        | 75        | 86  | 82.6±1.4   | 94.8±1.4   | 88.6±1.4  |
| 63        | 20            | 30 | 20        | 90        | 98  | 91.4±1.8   | 101.6±1.8  | 96.4±1.8  |
| 80        | 20            | 32 | 20        | 110       | 110 | 104.4±1.8  | 114.6±1.8  | 109.4±1.8 |
| 100       | 25            | 38 | 25        | 132       | 136 | 116.3±1.8  | 120.5±1.8  | 118.3±1.8 |
| 125       | 25            | 44 | 25        | 160       | 160 | 131.7±1.8  | 158.3±1.8  | 145±1.8   |

...LB2/-LB3 – Thread length of spacer bolts

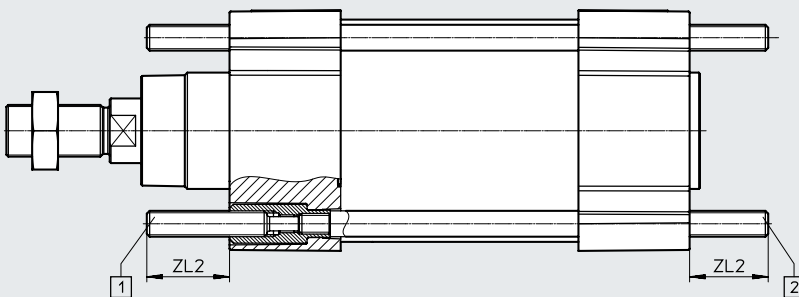

[1] = DSBG-...-LB2  
(on the bearing cap)  
[2] = DSBG-...-LB3  
(on the end cap)

| ∅<br>[mm] | ZL2<br>±1 |      |
|-----------|-----------|------|
|           | min.      | max. |
| 80        | 20        | 140  |
| 100       | 20        | 140  |
| 125       | 24        | 140  |

Data sheet

Dimensions – Variants

Download CAD data → [www.festo.com](http://www.festo.com)

P2 – Bellows on the bearing cap

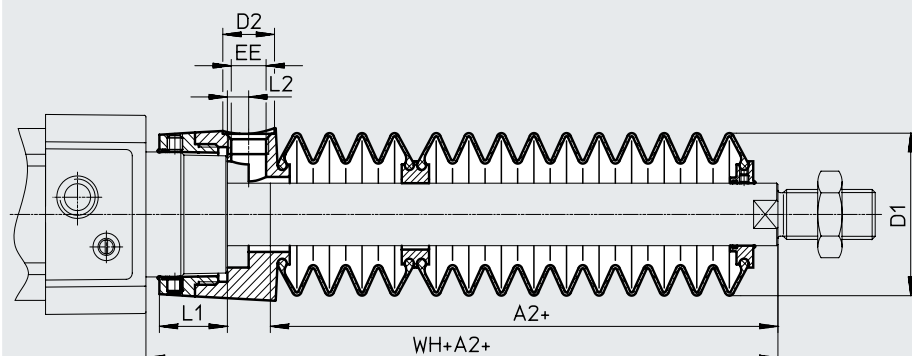

+ = plus stroke length

| ∅<br>Stroke<br>[mm] | 32               |            |     |       |      |     |       | 40               |            |    |      |      |     |       |
|---------------------|------------------|------------|-----|-------|------|-----|-------|------------------|------------|----|------|------|-----|-------|
|                     | A2 <sup>1)</sup> | D1<br>max. | D2  | EE    | L1   | L2  | WH+A2 | A2 <sup>1)</sup> | D1<br>max. | D2 | EE   | L1   | L2  | WH+A2 |
| 10 ... 50           | 29               | 38         | 14  | G1/8  | 12.9 | 5.4 | 55    | 28               | 46         | 14 | G1/8 | 16.3 | 5.4 | 56.7  |
| 51 ... 125          | 47               |            |     |       |      |     | 73    | 43               |            |    |      |      |     | 71.7  |
| 126 ... 175         | 61               |            |     |       |      |     | 87    | 56               |            |    |      |      |     | 84.7  |
| 176 ... 250         | 80               |            |     |       |      |     | 106   | 72               |            |    |      |      |     | 100.7 |
| 251 ... 300         | 96               |            |     |       |      |     | 122   | 86               |            |    |      |      |     | 114.7 |
| 301 ... 350         | 112              |            |     |       |      |     | 138   | 100              |            |    |      |      |     | 128.7 |
| 351 ... 375         | 114              |            |     |       |      |     | 140   | 101              |            |    |      |      |     | 129.7 |
| 376 ... 425         | 130              |            |     |       |      |     | 156   | 115              |            |    |      |      |     | 143.7 |
| 426 ... 475         | 145              |            |     |       |      |     | 171   | 130              |            |    |      |      |     | 158.7 |
| 476 ... 500         | 147              | 173        | 131 | 159.7 |      |     |       |                  |            |    |      |      |     |       |

| ∅<br>Stroke<br>[mm] | 50               |            |     |       |       |    |       | 63               |            |    |      |      |    |       |
|---------------------|------------------|------------|-----|-------|-------|----|-------|------------------|------------|----|------|------|----|-------|
|                     | A2 <sup>1)</sup> | D1<br>max. | D2  | EE    | L1    | L2 | WH+A2 | A2 <sup>1)</sup> | D1<br>max. | D2 | EE   | L1   | L2 | WH+A2 |
| 10 ... 50           | 28               | 57         | 17  | G1/4  | 22.35 | 7  | 63.6  | 28               | 57         | 17 | G1/4 | 22.4 | 7  | 63.9  |
| 51 ... 125          | 46               |            |     |       |       |    | 81.6  | 46               |            |    |      |      |    | 81.9  |
| 126 ... 175         | 56               |            |     |       |       |    | 91.6  | 56               |            |    |      |      |    | 91.9  |
| 176 ... 250         | 73               |            |     |       |       |    | 108.6 | 73               |            |    |      |      |    | 108.9 |
| 251 ... 300         | 86               |            |     |       |       |    | 121.6 | 86               |            |    |      |      |    | 121.9 |
| 301 ... 350         | 97               |            |     |       |       |    | 132.6 | 97               |            |    |      |      |    | 132.9 |
| 351 ... 375         | 105              |            |     |       |       |    | 140.6 | 105              |            |    |      |      |    | 140.9 |
| 376 ... 425         | 116              |            |     |       |       |    | 151.6 | 116              |            |    |      |      |    | 151.9 |
| 426 ... 475         | 126              |            |     |       |       |    | 161.6 | 126              |            |    |      |      |    | 161.9 |
| 476 ... 500         | 134              | 169.6      | 134 | 169.9 |       |    |       |                  |            |    |      |      |    |       |

| ∅<br>Stroke<br>[mm] | 80               |            |     |       |    |    |       | 100              |            |    |      |    |    |       |
|---------------------|------------------|------------|-----|-------|----|----|-------|------------------|------------|----|------|----|----|-------|
|                     | A2 <sup>1)</sup> | D1<br>max. | D2  | EE    | L1 | L2 | WH+A2 | A2 <sup>1)</sup> | D1<br>max. | D2 | EE   | L1 | L2 | WH+A2 |
| 10 ... 50           | 25               | 93         | 17  | G1/4  | 28 | 4  | 70.4  | 25               | 93         | 17 | G1/4 | 28 | 4  | 74.3  |
| 51 ... 125          | 37               |            |     |       |    |    | 82.4  | 37               |            |    |      |    |    | 86.3  |
| 126 ... 175         | 49               |            |     |       |    |    | 94.4  | 49               |            |    |      |    |    | 98.3  |
| 176 ... 250         | 62               |            |     |       |    |    | 107.4 | 62               |            |    |      |    |    | 111.3 |
| 251 ... 300         | 74               |            |     |       |    |    | 119.4 | 74               |            |    |      |    |    | 123.3 |
| 301 ... 350         | 86               |            |     |       |    |    | 131.4 | 86               |            |    |      |    |    | 135.3 |
| 351 ... 375         | 87               |            |     |       |    |    | 132.4 | 87               |            |    |      |    |    | 136.3 |
| 376 ... 425         | 98               |            |     |       |    |    | 143.4 | 98               |            |    |      |    |    | 147.3 |
| 426 ... 475         | 110              |            |     |       |    |    | 155.4 | 110              |            |    |      |    |    | 159.3 |
| 476 ... 500         | 111              | 156.4      | 111 | 160.3 |    |    |       |                  |            |    |      |    |    |       |

1) The dimension corresponds to the E value (piston rod extension) of the drive

## Data sheet

| Ordering data        |                |          |                     | With PPS cushioning |                     |
|----------------------|----------------|----------|---------------------|---------------------|---------------------|
| Piston diam.<br>[mm] | Stroke<br>[mm] | Part no. | Type                | Part no.            | Type                |
| 32                   | 25             | 1638842  | DSBG-32-25-PPVA-N3  | 1645460             | DSBG-32-25-PPSA-N3  |
|                      | 40             | 1638843  | DSBG-32-40-PPVA-N3  | 1645461             | DSBG-32-40-PPSA-N3  |
|                      | 50             | 1638844  | DSBG-32-50-PPVA-N3  | 1645462             | DSBG-32-50-PPSA-N3  |
|                      | 80             | 1638845  | DSBG-32-80-PPVA-N3  | 1645463             | DSBG-32-80-PPSA-N3  |
|                      | 100            | 1638846  | DSBG-32-100-PPVA-N3 | 1645464             | DSBG-32-100-PPSA-N3 |
|                      | 125            | 1638848  | DSBG-32-125-PPVA-N3 | 1645465             | DSBG-32-125-PPSA-N3 |
|                      | 160            | 1638849  | DSBG-32-160-PPVA-N3 | 1645466             | DSBG-32-160-PPSA-N3 |
|                      | 200            | 1638850  | DSBG-32-200-PPVA-N3 | 1645467             | DSBG-32-200-PPSA-N3 |
|                      | 250            | 1638851  | DSBG-32-250-PPVA-N3 | 1645468             | DSBG-32-250-PPSA-N3 |
|                      | 320            | 1638852  | DSBG-32-320-PPVA-N3 | 1645469             | DSBG-32-320-PPSA-N3 |
|                      | 400            | 1638853  | DSBG-32-400-PPVA-N3 | 1645470             | DSBG-32-400-PPSA-N3 |
|                      | 500            | 1638854  | DSBG-32-500-PPVA-N3 | 1645471             | DSBG-32-500-PPSA-N3 |
|                      | 1 ... 2800     | 1634781  | DSBG-32-...-PPVA-N3 | 1634560             | DSBG-32-...-PPSA-N3 |
| 40                   | 25             | 1646547  | DSBG-40-25-PPVA-N3  | 1646559             | DSBG-40-25-PPSA-N3  |
|                      | 40             | 1646548  | DSBG-40-40-PPVA-N3  | 1646560             | DSBG-40-40-PPSA-N3  |
|                      | 50             | 1646549  | DSBG-40-50-PPVA-N3  | 1646561             | DSBG-40-50-PPSA-N3  |
|                      | 80             | 1646550  | DSBG-40-80-PPVA-N3  | 1646562             | DSBG-40-80-PPSA-N3  |
|                      | 100            | 1646551  | DSBG-40-100-PPVA-N3 | 1646563             | DSBG-40-100-PPSA-N3 |
|                      | 125            | 1646552  | DSBG-40-125-PPVA-N3 | 1646564             | DSBG-40-125-PPSA-N3 |
|                      | 160            | 1646553  | DSBG-40-160-PPVA-N3 | 1646565             | DSBG-40-160-PPSA-N3 |
|                      | 200            | 1646554  | DSBG-40-200-PPVA-N3 | 1646566             | DSBG-40-200-PPSA-N3 |
|                      | 250            | 1646555  | DSBG-40-250-PPVA-N3 | 1646567             | DSBG-40-250-PPSA-N3 |
|                      | 320            | 1646556  | DSBG-40-320-PPVA-N3 | 1646568             | DSBG-40-320-PPSA-N3 |
|                      | 400            | 1646557  | DSBG-40-400-PPVA-N3 | 1646569             | DSBG-40-400-PPSA-N3 |
|                      | 500            | 1646558  | DSBG-40-500-PPVA-N3 | 1646570             | DSBG-40-500-PPSA-N3 |
|                      | 1 ... 2800     | 1644503  | DSBG-40-...-PPVA-N3 | 1645473             | DSBG-40-...-PPSA-N3 |
| 50                   | 25             | 1646709  | DSBG-50-25-PPVA-N3  | 1646723             | DSBG-50-25-PPSA-N3  |
|                      | 40             | 1646710  | DSBG-50-40-PPVA-N3  | 1646724             | DSBG-50-40-PPSA-N3  |
|                      | 50             | 1646711  | DSBG-50-50-PPVA-N3  | 1646725             | DSBG-50-50-PPSA-N3  |
|                      | 80             | 1646712  | DSBG-50-80-PPVA-N3  | 1646726             | DSBG-50-80-PPSA-N3  |
|                      | 100            | 1646713  | DSBG-50-100-PPVA-N3 | 1646727             | DSBG-50-100-PPSA-N3 |
|                      | 125            | 1646714  | DSBG-50-125-PPVA-N3 | 1646728             | DSBG-50-125-PPSA-N3 |
|                      | 160            | 1646715  | DSBG-50-160-PPVA-N3 | 1646729             | DSBG-50-160-PPSA-N3 |
|                      | 200            | 1646716  | DSBG-50-200-PPVA-N3 | 1646730             | DSBG-50-200-PPSA-N3 |
|                      | 250            | 1646717  | DSBG-50-250-PPVA-N3 | 1646731             | DSBG-50-250-PPSA-N3 |
|                      | 320            | 1646718  | DSBG-50-320-PPVA-N3 | 1646732             | DSBG-50-320-PPSA-N3 |
|                      | 400            | 1646719  | DSBG-50-400-PPVA-N3 | 1646733             | DSBG-50-400-PPSA-N3 |
|                      | 500            | 1646720  | DSBG-50-500-PPVA-N3 | 1646734             | DSBG-50-500-PPSA-N3 |
|                      | 1 ... 2800     | 1646708  | DSBG-50-...-PPVA-N3 | 1646722             | DSBG-50-...-PPSA-N3 |

 Note

Other variants in the modular product system → page 24

## Data sheet

| Ordering data        |                |          |                      | With PPS cushioning |                      |
|----------------------|----------------|----------|----------------------|---------------------|----------------------|
| Piston diam.<br>[mm] | Stroke<br>[mm] | Part no. | Type                 | Part no.            | Type                 |
| 63                   | 25             | 1646740  | DSBG-63-25-PPVA-N3   | 1646754             | DSBG-63-25-PPSA-N3   |
|                      | 40             | 1646741  | DSBG-63-40-PPVA-N3   | 1646755             | DSBG-63-40-PPSA-N3   |
|                      | 50             | 1646742  | DSBG-63-50-PPVA-N3   | 1646756             | DSBG-63-50-PPSA-N3   |
|                      | 80             | 1646743  | DSBG-63-80-PPVA-N3   | 1646757             | DSBG-63-80-PPSA-N3   |
|                      | 100            | 1646744  | DSBG-63-100-PPVA-N3  | 1646758             | DSBG-63-100-PPSA-N3  |
|                      | 125            | 1646745  | DSBG-63-125-PPVA-N3  | 1646760             | DSBG-63-125-PPSA-N3  |
|                      | 160            | 1646746  | DSBG-63-160-PPVA-N3  | 1646761             | DSBG-63-160-PPSA-N3  |
|                      | 200            | 1646747  | DSBG-63-200-PPVA-N3  | 1646762             | DSBG-63-200-PPSA-N3  |
|                      | 250            | 1646748  | DSBG-63-250-PPVA-N3  | 1646763             | DSBG-63-250-PPSA-N3  |
|                      | 320            | 1646749  | DSBG-63-320-PPVA-N3  | 1646764             | DSBG-63-320-PPSA-N3  |
|                      | 400            | 1646750  | DSBG-63-400-PPVA-N3  | 1646765             | DSBG-63-400-PPSA-N3  |
|                      | 500            | 1646751  | DSBG-63-500-PPVA-N3  | 1646766             | DSBG-63-500-PPSA-N3  |
|                      | 1 ... 2800     | 1646739  | DSBG-63-...-PPVA-N3  | 1646753             | DSBG-63-...-PPSA-N3  |
|                      | 80             | 25       | 1646771              | DSBG-80-25-PPVA-N3  | 1646785              |
| 40                   |                | 1646772  | DSBG-80-40-PPVA-N3   | 1646786             | DSBG-80-40-PPSA-N3   |
| 50                   |                | 1646773  | DSBG-80-50-PPVA-N3   | 1646787             | DSBG-80-50-PPSA-N3   |
| 80                   |                | 1646774  | DSBG-80-80-PPVA-N3   | 1646788             | DSBG-80-80-PPSA-N3   |
| 100                  |                | 1646775  | DSBG-80-100-PPVA-N3  | 1646789             | DSBG-80-100-PPSA-N3  |
| 125                  |                | 1646776  | DSBG-80-125-PPVA-N3  | 1646790             | DSBG-80-125-PPSA-N3  |
| 160                  |                | 1646777  | DSBG-80-160-PPVA-N3  | 1646791             | DSBG-80-160-PPSA-N3  |
| 200                  |                | 1646778  | DSBG-80-200-PPVA-N3  | 1646792             | DSBG-80-200-PPSA-N3  |
| 250                  |                | 1646779  | DSBG-80-250-PPVA-N3  | 1646793             | DSBG-80-250-PPSA-N3  |
| 320                  |                | 1646780  | DSBG-80-320-PPVA-N3  | 1646794             | DSBG-80-320-PPSA-N3  |
| 400                  |                | 1646781  | DSBG-80-400-PPVA-N3  | 1646795             | DSBG-80-400-PPSA-N3  |
| 500                  |                | 1646782  | DSBG-80-500-PPVA-N3  | 1646796             | DSBG-80-500-PPSA-N3  |
| 1 ... 2800           |                | 1646770  | DSBG-80-...-PPVA-N3  | 1646784             | DSBG-80-...-PPSA-N3  |
| 100                  |                | 25       | 1646801              | DSBG-100-25-PPVA-N3 | 1646815              |
|                      | 40             | 1646802  | DSBG-100-40-PPVA-N3  | 1646816             | DSBG-100-40-PPSA-N3  |
|                      | 50             | 1646803  | DSBG-100-50-PPVA-N3  | 1646817             | DSBG-100-50-PPSA-N3  |
|                      | 80             | 1646804  | DSBG-100-80-PPVA-N3  | 1646818             | DSBG-100-80-PPSA-N3  |
|                      | 100            | 1646805  | DSBG-100-100-PPVA-N3 | 1646819             | DSBG-100-100-PPSA-N3 |
|                      | 125            | 1646806  | DSBG-100-125-PPVA-N3 | 1646820             | DSBG-100-125-PPSA-N3 |
|                      | 160            | 1646807  | DSBG-100-160-PPVA-N3 | 1646821             | DSBG-100-160-PPSA-N3 |
|                      | 200            | 1646808  | DSBG-100-200-PPVA-N3 | 1646822             | DSBG-100-200-PPSA-N3 |
|                      | 250            | 1646809  | DSBG-100-250-PPVA-N3 | 1646823             | DSBG-100-250-PPSA-N3 |
|                      | 320            | 1646810  | DSBG-100-320-PPVA-N3 | 1646824             | DSBG-100-320-PPSA-N3 |
|                      | 400            | 1646811  | DSBG-100-400-PPVA-N3 | 1646825             | DSBG-100-400-PPSA-N3 |
|                      | 500            | 1646812  | DSBG-100-500-PPVA-N3 | 1646826             | DSBG-100-500-PPSA-N3 |
|                      | 1 ... 2800     | 1646800  | DSBG-100-...-PPVA-N3 | 1646814             | DSBG-100-...-PPSA-N3 |

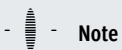

## Note

Other variants in the modular product system → page 24

## Data sheet

| Ordering data        |                |                     |                      |                     |                      |
|----------------------|----------------|---------------------|----------------------|---------------------|----------------------|
| Piston diam.<br>[mm] | Stroke<br>[mm] | With PPV cushioning |                      | With PPS cushioning |                      |
|                      |                | Part no.            | Type                 | Part no.            | Type                 |
| 125                  | 25             | 2159622             | DSBG-125-25-PPVA-N3  | 2159907             | DSBG-125-25-PPSA-N3  |
|                      | 40             | 2159623             | DSBG-125-40-PPVA-N3  | 2159908             | DSBG-125-40-PPSA-N3  |
|                      | 50             | 2159624             | DSBG-125-50-PPVA-N3  | 2159909             | DSBG-125-50-PPSA-N3  |
|                      | 80             | 2159625             | DSBG-125-80-PPVA-N3  | 2159910             | DSBG-125-80-PPSA-N3  |
|                      | 100            | 2159626             | DSBG-125-100-PPVA-N3 | 2159911             | DSBG-125-100-PPSA-N3 |
|                      | 125            | 2159627             | DSBG-125-125-PPVA-N3 | 2159912             | DSBG-125-125-PPSA-N3 |
|                      | 160            | 2159628             | DSBG-125-160-PPVA-N3 | 2159913             | DSBG-125-160-PPSA-N3 |
|                      | 200            | 2159629             | DSBG-125-200-PPVA-N3 | 2159915             | DSBG-125-200-PPSA-N3 |
|                      | 250            | 2159630             | DSBG-125-250-PPVA-N3 | 2159916             | DSBG-125-250-PPSA-N3 |
|                      | 320            | 2159631             | DSBG-125-320-PPVA-N3 | 2159917             | DSBG-125-320-PPSA-N3 |
|                      | 400            | 2159632             | DSBG-125-400-PPVA-N3 | 2159918             | DSBG-125-400-PPSA-N3 |
|                      | 500            | 2159633             | DSBG-125-500-PPVA-N3 | 2159919             | DSBG-125-500-PPSA-N3 |
|                      | 1 ... 2800     | 2158455             | DSBG-125-...-PPVA-N3 | 2158471             | DSBG-125-...-PPSA-N3 |

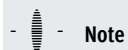
**Note**

Other variants in the modular product system → page 24

## Ordering data – Modular product system

| Ordering table              |   |                                     |                |                |                |                |                |            |             |             |           |
|-----------------------------|---|-------------------------------------|----------------|----------------|----------------|----------------|----------------|------------|-------------|-------------|-----------|
| Size                        | 32  | 40                                  | 50             | 63             | 80             | 100            | 125            | Conditions | Code        | Enter code  |           |
| Module no.                  | <b>1634484</b>  | <b>1645477</b>                      | <b>1646707</b> | <b>1646738</b> | <b>1646769</b> | <b>1646799</b> | <b>2045493</b> |            |             |             |           |
| Function                    | Standards-based cylinder, double-acting, based on ISO 15552 |                                     |                |                |                |                |                |            | <b>DSBG</b> | DSBG        |           |
| Protection against rotation | Without   |                                     |                |                |                |                |                |            |             |             |           |
|                             | With protection against rotation                            |                                     |                |                |                |                |                | –          | [1]         | <b>-Q</b>   |           |
| Running characteristics     | Standard  |                                     |                |                |                |                |                |            |             |             |           |
|                             | Low friction  |                                     |                |                |                |                |                | –          | [2]         | <b>L</b>    |           |
|                             | Constant, slow movement                                     |                                     |                |                |                |                |                |            | [2]         | <b>U</b>    |           |
|                             | Low friction for balancer applications                      |                                     |                |                |                |                |                |            | [3]         | <b>L1</b>   |           |
| Piston diameter [mm]        | 32  | 40                                  | 50             | 63             | 80             | 100            | 125            |            | <b>-...</b> |             |           |
| Stroke [mm]                 | 1 ... 2800  |                                     |                |                |                |                |                |            |             | <b>-...</b> |           |
| Piston rod type             | At one end  |                                     |                |                |                |                |                |            |             |             |           |
|                             | Through piston rod  |                                     |                |                |                |                |                |            |             | <b>-T</b>   |           |
| Piston rod thread type      | Male thread   |                                     |                |                |                |                |                |            |             |             |           |
|                             | Female thread   |                                     |                |                |                |                |                |            | [4]         | <b>F</b>    |           |
| Cushioning                  | Elastic cushioning rings/plates at both ends                |                                     |                |                |                |                |                |            |             | <b>-P</b>   |           |
|                             | Pneumatic cushioning, self-adjusting at both ends           |                                     |                |                |                |                |                |            | [5]         | <b>-PPS</b> |           |
|                             | Pneumatic cushioning, adjustable at both ends               |                                     |                |                |                |                |                |            |             | <b>-PPV</b> |           |
| Position sensing            | Via proximity switch  |                                     |                |                |                |                |                |            |             | <b>A</b>    | A         |
| Standard                    | Based on ISO 15552  |                                     |                |                |                |                |                |            |             |             |           |
|                             | Complies with ISO 15552                                     |                                     |                |                |                |                |                |            |             | <b>-N3</b>  |           |
| Corrosion protection        | Standard  |                                     |                |                |                |                |                |            |             |             |           |
|                             | High corrosion protection                                   |                                     |                |                |                |                |                |            | [6]         | <b>R3</b>   |           |
| Temperature range           | Standard  |                                     |                |                |                |                |                |            |             |             |           |
|                             | [°C]  | Heat-resistant seals up to max. 120 |                |                |                |                |                |            |             | [7]         | <b>T1</b> |
|                             | [°C]  | –40 ... +80                         |                |                |                |                |                |            |             | [7]         | <b>T3</b> |
|                             | [°C]  | 0 ... +150                          |                |                |                |                |                |            |             | [7]         | <b>T4</b> |

- [1] Q Not with L, U, N3, T3, T4, P2, A2, A3, A6  
Only up to stroke of 1500 mm
- [2] L, U Not with T, R3, T1, T3, T4, P2, A2, A3, A6, EX4
- [3] L1 Not with T, PPV, R3, T1, T3, T4, P2, A2, A3, A6, EX4
- [4] F Not with N3, ...L, M...
- [5] PPS Not with T1, T3, T4
- [6] R3 Not with A2, A6, ...V
- [7] T1, T3, T4 Not with P2, A2, A3, EX4

 - **Note**

If characteristic L is used in combination with transverse loads or strokes of above 500 mm, suitable measures must be taken to support the piston rod.

The operating pressure (→ page 10) is applicable for strokes up to 500 mm.

 - **Note**

If characteristic L1 is used in combination with strokes of above 500 mm, suitable measures must be taken to support the piston rod.

The operating pressure (→ page 10) is applicable for strokes up to 500 mm.



## Ordering data – Modular product system

| Ordering table                     |                            |    |          |            |                    |            |            |            |        |            |  |
|------------------------------------|----------------------------|----|----------|------------|--------------------|------------|------------|------------|--------|------------|--|
| Size                               | 32                         | 40 | 50       | 63         | 80                 | 100        | 125        | Conditions | Code   | Enter code |  |
| Protection against particles       | Standard                   |    |          |            |                    |            |            |            |        |            |  |
|                                    | Bellows on bearing cap     |    |          |            |                    |            |            | –          | [8]    | P2         |  |
| Wiper variant                      | None                       |    |          |            |                    |            |            |            |        |            |  |
|                                    | Hard scraper               |    |          |            |                    |            |            |            |        | A2         |  |
|                                    | For unlubricated operation |    |          |            |                    |            |            |            |        | A3         |  |
|                                    | Metal scraper              |    |          |            |                    |            |            |            |        | A6         |  |
| EU certification                   | None                       |    |          |            |                    |            |            |            |        |            |  |
|                                    | II 2GD                     |    |          |            |                    |            |            |            | [9]    | EX4        |  |
| Swivel mounting position [mm]      | Without                    |    |          |            |                    |            |            |            |        |            |  |
|                                    | 0 ... 2800                 |    |          |            |                    |            |            |            |        | ...V       |  |
| Extended piston rod [mm]           | Without                    |    |          |            |                    |            |            |            |        |            |  |
|                                    | 1 ... 500                  |    |          |            |                    |            |            |            | [10]   | ...E       |  |
| Extended piston rod thread [mm]    | Without                    |    |          |            |                    |            |            |            |        |            |  |
|                                    | 1 ... 35                   |    | 1 ... 70 |            |                    |            |            |            | [10]   | ...L       |  |
| Shortened piston rod thread [mm]   | Without                    |    |          |            |                    |            |            |            |        |            |  |
|                                    | –                          |    |          |            | 1 ... 30           |            | 1 ... 44   |            |        | ...S       |  |
| Piston rod thread                  | Standard (→ 17)            |    |          |            |                    |            |            |            |        |            |  |
|                                    | –                          |    |          |            | M16                |            |            | [11]       | -M16   |            |  |
|                                    | –                          |    |          |            | M16x1.5            |            |            | [11]       | -M16P  |            |  |
|                                    | –                          |    |          |            | M20                |            |            | [11]       | -M20   |            |  |
|                                    | –                          |    |          |            | M20x1.5            |            | [11]       | -M20P      |        |            |  |
|                                    | –                          |    |          |            | M24                |            | [11]       | -M24       |        |            |  |
| –                                  |                            |    |          | M27        |                    | [11]       | -M27       |            |        |            |  |
| Thread length of spacer bolts [mm] | Without                    |    |          |            |                    |            |            |            |        |            |  |
|                                    | –                          |    |          |            | On the bearing cap |            |            | [11]       | ...LB2 |            |  |
|                                    | –                          |    |          |            | 20 ... 140         |            | 24 ... 140 |            |        |            |  |
|                                    | –                          |    |          |            | On the end cap     |            |            | [11]       | ...LB3 |            |  |
| –                                  |                            |    |          | 20 ... 140 |                    | 24 ... 140 |            |            |        |            |  |

[8] P2 Not with N3, A2, A3, A6, EX4  
Only for strokes 10 ... 500 mm

[9] EX4 Not with T1, T3, T4, P2, A3, A6, ...LB2, ...LB3

[10] ...E, ...L Only up to stroke of 2000 mm.  
Not with N3

[11] M..., LB... Not with N3

 - Note

The piston rod extension for the bellows is automatically taken into consideration when characteristic P2 is selected. This means that there is no need to specify a value for characteristic ...E.

 - Note

When characteristic ...E is selected in combination with characteristic P2, the part of the piston rod extension ...E is not covered by the bellows.

 - Note

When characteristic P2 is selected in combination with characteristic T (through piston rod), the bellows is mounted at one end only.

 - Note

If a thread smaller than the standard thread is selected for characteristic M... (piston rod thread), this may reduce the load capacity.

 - Note

When characteristic M... is selected, the piston rod nut is not included.

## Accessories

### Foot mounting HNC/CRHNC

Material:

HNC: galvanised steel

CRHNC: high-alloy steel

Free of copper and PTFE

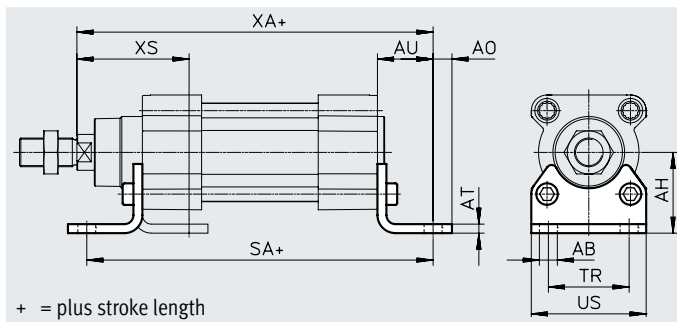

#### Dimensions and ordering data

| For diam. | AB<br>∅ | AH | AO   | AT | AU | SA  | TR | US  | XA    | XS   |
|-----------|---------|----|------|----|----|-----|----|-----|-------|------|
| [mm]      |         |    |      |    |    |     |    |     |       |      |
| 32        | 7       | 32 | 6.5  | 4  | 24 | 142 | 32 | 45  | 143.1 | 46   |
| 40        | 10      | 36 | 9    | 4  | 28 | 161 | 36 | 54  | 161.9 | 52.7 |
| 50        | 10      | 45 | 9.5  | 5  | 32 | 170 | 45 | 64  | 173.8 | 62.6 |
| 63        | 10      | 50 | 12.5 | 5  | 32 | 185 | 50 | 75  | 189.1 | 62.9 |
| 80        | 12      | 63 | 15   | 6  | 41 | 210 | 63 | 93  | 214.6 | 80.4 |
| 100       | 14.5    | 71 | 17.5 | 6  | 41 | 220 | 75 | 110 | 228.5 | 84.3 |
| 125       | 16.5    | 90 | 22   | 8  | 45 | 250 | 90 | 131 | 270   | 102  |

| For diam. | Basic type        |            |               |                    | Corrosion-resistant |            |               |                    |
|-----------|-------------------|------------|---------------|--------------------|---------------------|------------|---------------|--------------------|
|           | CRC <sup>1)</sup> | Weight [g] | Part no.      | Type <sup>2)</sup> | CRC <sup>1)</sup>   | Weight [g] | Part no.      | Type <sup>2)</sup> |
| [mm]      |                   |            |               |                    |                     |            |               |                    |
| 32        | 2                 | 144        | <b>174369</b> | <b>HNC-32</b>      | 4                   | 139        | <b>176937</b> | <b>CRHNC-32</b>    |
| 40        | 2                 | 193        | <b>174370</b> | <b>HNC-40</b>      | 4                   | 188        | <b>176938</b> | <b>CRHNC-40</b>    |
| 50        | 2                 | 353        | <b>174371</b> | <b>HNC-50</b>      | 4                   | 341        | <b>176939</b> | <b>CRHNC-50</b>    |
| 63        | 2                 | 436        | <b>174372</b> | <b>HNC-63</b>      | 4                   | 424        | <b>176940</b> | <b>CRHNC-63</b>    |
| 80        | 2                 | 829        | <b>174373</b> | <b>HNC-80</b>      | 4                   | 809        | <b>176941</b> | <b>CRHNC-80</b>    |
| 100       | 2                 | 1009       | <b>174374</b> | <b>HNC-100</b>     | 4                   | 990        | <b>176942</b> | <b>CRHNC-100</b>   |
| 125       | 2                 | 1902       | <b>174375</b> | <b>HNC-125</b>     | 4                   | 1920       | <b>176943</b> | <b>CRHNC-125</b>   |

1) Corrosion resistance class CRC 2 to Festo standard FN 940070

Moderate corrosion stress. Indoor applications in which condensation can occur. External visible parts with primarily decorative surface requirements which are in direct contact with a normal industrial environment.

Corrosion resistance class CRC 4 to Festo standard FN 940070

Particularly high corrosion stress. Outdoor exposure under extreme corrosive conditions. Parts exposed to aggressive media, e.g. in the chemical or food industries. Such applications may need to be safeguarded by special tests (→ also FN 940082), using appropriate media.

2) Suitable for ATEX

## Accessories

## Flange mounting FNC/CRFNG

Material:

FNC: galvanised steel

CRFNG: high-alloy steel

Free of copper and PTFE

RoHS-compliant

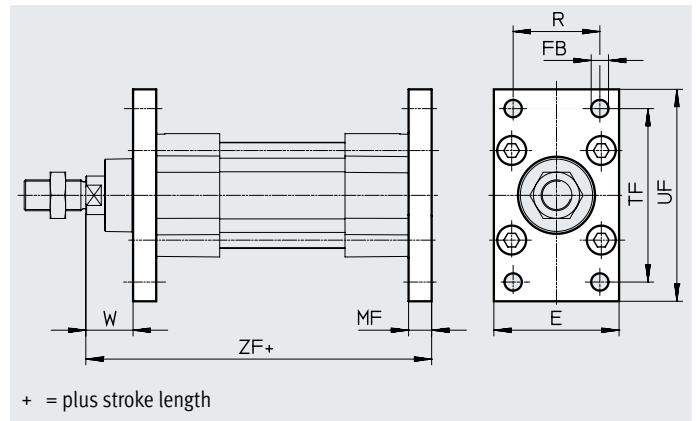

## Dimensions and ordering data

| For diam.<br>[mm] | E   | FB<br>∅<br>H13 | MF | R  | TF  | UF  | W    | ZF    |
|-------------------|-----|----------------|----|----|-----|-----|------|-------|
| 32                | 45  | 7              | 10 | 32 | 64  | 80  | 16   | 129.1 |
| 40                | 54  | 9              | 10 | 36 | 72  | 90  | 18.7 | 143.9 |
| 50                | 65  | 9              | 12 | 45 | 90  | 110 | 23.6 | 153.8 |
| 63                | 75  | 9              | 12 | 50 | 100 | 120 | 23.9 | 169.1 |
| 80                | 93  | 12             | 16 | 63 | 126 | 150 | 29.4 | 189.6 |
| 100               | 110 | 14             | 16 | 75 | 150 | 175 | 33.3 | 203.5 |
| 125               | 132 | 16             | 20 | 90 | 180 | 210 | 45   | 245   |

| For diam.<br>[mm] | Basic type        |               |               |                    | Corrosion-resistant |               |               |                    |
|-------------------|-------------------|---------------|---------------|--------------------|---------------------|---------------|---------------|--------------------|
|                   | CRC <sup>1)</sup> | Weight<br>[g] | Part no.      | Type <sup>2)</sup> | CRC <sup>1)</sup>   | Weight<br>[g] | Part no.      | Type <sup>2)</sup> |
| 32                | 1                 | 221           | <b>174376</b> | <b>FNC-32</b>      | 4                   | 220           | <b>161846</b> | <b>CRFNG-32</b>    |
| 40                | 1                 | 291           | <b>174377</b> | <b>FNC-40</b>      | 4                   | 291           | <b>161847</b> | <b>CRFNG-40</b>    |
| 50                | 1                 | 536           | <b>174378</b> | <b>FNC-50</b>      | 4                   | 526           | <b>161848</b> | <b>CRFNG-50</b>    |
| 63                | 1                 | 679           | <b>174379</b> | <b>FNC-63</b>      | 4                   | 680           | <b>161849</b> | <b>CRFNG-63</b>    |
| 80                | 1                 | 1495          | <b>174380</b> | <b>FNC-80</b>      | 4                   | 1508          | <b>161850</b> | <b>CRFNG-80</b>    |
| 100               | 1                 | 2041          | <b>174381</b> | <b>FNC-100</b>     | 4                   | 2054          | <b>161851</b> | <b>CRFNG-100</b>   |
| 125               | 1                 | 3775          | <b>174382</b> | <b>FNC-125</b>     | 4                   | 3787          | <b>185363</b> | <b>CRFNG-125</b>   |

1) Corrosion resistance class CRC 1 to Festo standard FN 940070

Low corrosion stress. Dry internal application or transport and storage protection. Also applies to parts behind coverings, in the non-visible interior area, and parts which are covered in the application (e.g. drive trunnions).

Corrosion resistance class CRC 4 to Festo standard FN 940070

Particularly high corrosion stress. Outdoor exposure under extreme corrosive conditions. Parts exposed to aggressive media, e.g. in the chemical or food industries. Such applications may need to be safeguarded by special tests (→ also FN 940082), using appropriate media.

2) Suitable for ATEX

## Accessories

### Trunnion flange ZNCF/CRZNG

Material:

ZNCF: stainless steel casting

CRZNG: electropolished stainless steel casting

Free of copper and PTFE

RoHS-compliant

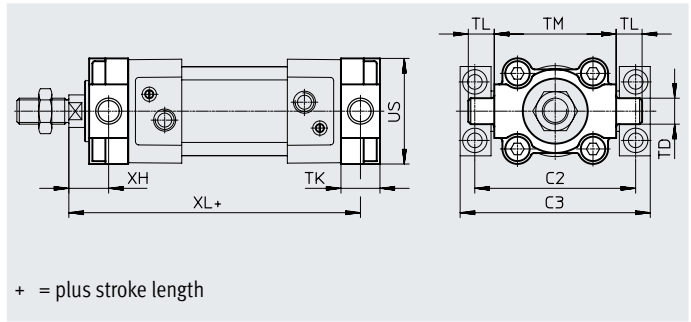

#### Dimensions and ordering data

| For diam.<br>[mm] | C2  | C3  | TD<br>∅<br>e9 | TK | TL | TM  | US  | XH   | XL    |
|-------------------|-----|-----|---------------|----|----|-----|-----|------|-------|
| 32                | 71  | 86  | 12            | 16 | 12 | 50  | 45  | 18   | 127.1 |
| 40                | 87  | 105 | 16            | 20 | 16 | 63  | 54  | 18.7 | 143.9 |
| 50                | 99  | 117 | 16            | 24 | 16 | 75  | 64  | 23.6 | 153.8 |
| 63                | 116 | 136 | 20            | 24 | 20 | 90  | 75  | 23.9 | 169.1 |
| 80                | 136 | 156 | 20            | 28 | 20 | 110 | 93  | 31.4 | 187.6 |
| 100               | 164 | 189 | 25            | 38 | 25 | 132 | 110 | 30.3 | 206.5 |
| 125               | 192 | 217 | 25            | 50 | 25 | 160 | 131 | 40   | 250   |

| For diam.<br>[mm] | Basic type        |               |          |                    | Corrosion-resistant |               |          |                    |
|-------------------|-------------------|---------------|----------|--------------------|---------------------|---------------|----------|--------------------|
|                   | CRC <sup>1)</sup> | Weight<br>[g] | Part no. | Type <sup>2)</sup> | CRC <sup>1)</sup>   | Weight<br>[g] | Part no. | Type <sup>2)</sup> |
| 32                | 2                 | 150           | 174411   | ZNCF-32            | 4                   | 150           | 161852   | CRZNG-32           |
| 40                | 2                 | 285           | 174412   | ZNCF-40            | 4                   | 285           | 161853   | CRZNG-40           |
| 50                | 2                 | 473           | 174413   | ZNCF-50            | 4                   | 473           | 161854   | CRZNG-50           |
| 63                | 2                 | 687           | 174414   | ZNCF-63            | 4                   | 687           | 161855   | CRZNG-63           |
| 80                | 2                 | 1296          | 174415   | ZNCF-80            | 4                   | 1296          | 161856   | CRZNG-80           |
| 100               | 2                 | 2254          | 174416   | ZNCF-100           | 4                   | 2254          | 161857   | CRZNG-100          |
| 125               | 2                 | 3484          | 174417   | ZNCF-125           | 4                   | 3484          | 185362   | CRZNG-125          |

1) Corrosion resistance class CRC 2 to Festo standard FN 940070

Moderate corrosion stress. Indoor applications in which condensation can occur. External visible parts with primarily decorative surface requirements which are in direct contact with a normal industrial environment.

Corrosion resistance class CRC 4 to Festo standard FN 940070

Particularly high corrosion stress. Outdoor exposure under extreme corrosive conditions. Parts exposed to aggressive media, e.g. in the chemical or food industries. Such applications may need to be safeguarded by special tests (→ also FN 940082), using appropriate media.

2) Suitable for ATEX

## Accessories

### Trunnion support LNZG

Material:  
 Trunnion support: anodised aluminium  
 Plain bearing: plastic  
 Free of copper and PTFE  
 RoHS-compliant

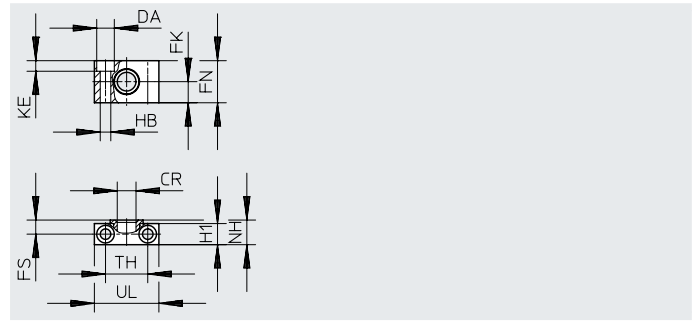

#### Dimensions and ordering data

| For diam.<br>[mm] | CR<br>∅<br>D11 | DA<br>∅<br>H13 | FK<br>∅<br>±0.1 | FN | FS   | H1   | HB<br>∅<br>H13 | KE  | NH   | TH<br>±0.2 | UL | CRC <sup>1)</sup> | Weight<br>[g] | Part no. | Type         |
|-------------------|----------------|----------------|-----------------|----|------|------|----------------|-----|------|------------|----|-------------------|---------------|----------|--------------|
| 32                | 12             | 11             | 15              | 30 | 10.5 | 15   | 6.6            | 6.8 | 18   | 32         | 46 | 2                 | 83            | 32959    | LNZG-32      |
| 40, 50            | 16             | 15             | 18              | 36 | 12   | 18   | 9              | 9   | 21   | 36         | 55 | 2                 | 129           | 32960    | LNZG-40/50   |
| 63, 80            | 20             | 18             | 20              | 40 | 13   | 20   | 11             | 11  | 23   | 42         | 65 | 2                 | 178           | 32961    | LNZG-63/80   |
| 100, 125          | 25             | 20             | 25              | 50 | 16   | 24.5 | 14             | 13  | 28.5 | 50         | 75 | 2                 | 306           | 32962    | LNZG-100/125 |

1) Corrosion resistance class CRC 2 to Festo standard FN 940070

Moderate corrosion stress. Indoor applications in which condensation can occur. External visible parts with primarily decorative surface requirements which are in direct contact with a normal industrial environment.

### Trunnion support CRLNZG

Material:  
 High-alloy steel  
 Free of copper and PTFE  
 RoHS-compliant

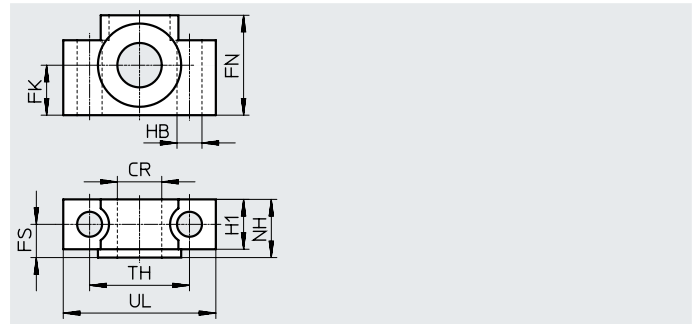
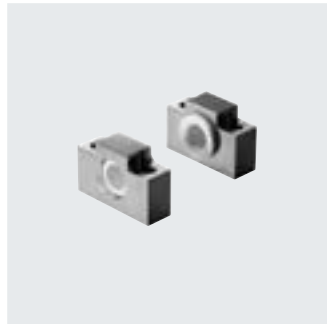

#### Dimensions and ordering data

| For diam.<br>[mm] | CR<br>∅<br>D11 | FK<br>∅<br>±0.1 | FN | FS   | H1   | HB<br>∅<br>H13 | NH   | TH<br>±0.2 | UL | CRC <sup>1)</sup> | Weight<br>[g] | Part no. | Type           |
|-------------------|----------------|-----------------|----|------|------|----------------|------|------------|----|-------------------|---------------|----------|----------------|
| 32                | 12             | 15              | 30 | 10.5 | 15   | 6.6            | 18   | 32         | 46 | 4                 | 205           | 161874   | CRLNZG-32      |
| 40, 50            | 16             | 18              | 36 | 12   | 18   | 9              | 21   | 36         | 55 | 4                 | 323           | 161875   | CRLNZG-40/50   |
| 63, 80            | 20             | 20              | 40 | 13   | 20   | 11             | 23   | 42         | 65 | 4                 | 435           | 161876   | CRLNZG-63/80   |
| 100, 125          | 25             | 25              | 50 | 16   | 24.5 | 14             | 28.5 | 50         | 75 | 4                 | 739           | 161877   | CRLNZG-100/125 |

1) Corrosion resistance class CRC 4 to Festo standard FN 940070

Particularly high corrosion stress. Outdoor exposure under extreme corrosive conditions. Parts exposed to aggressive media, e.g. in the chemical or food industries. Such applications may need to be safeguarded by special tests (→ also FN 940082), using appropriate media.

## Accessories

### Swivel flange SNC

Material:  
Die-cast aluminium  
RoHS-compliant

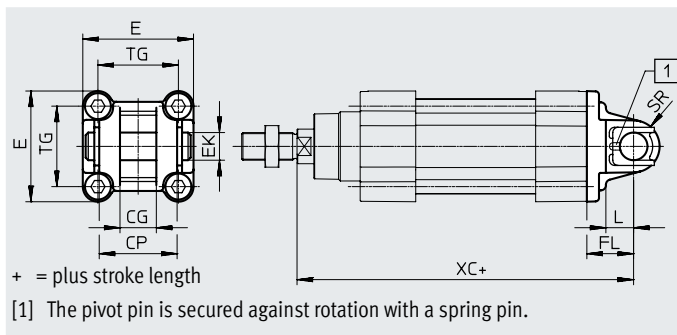

#### Dimensions and ordering data

| For diam. | CG  | CP  | E                        | EK<br>∅<br>H9 | FL<br>±0.2 | L  | SR | TG   | XC    | CRC <sup>1)</sup> | Weight<br>[g] | Part no.      | Type <sup>2)</sup> |
|-----------|-----|-----|--------------------------|---------------|------------|----|----|------|-------|-------------------|---------------|---------------|--------------------|
| [mm]      | H14 | h14 |                          |               |            |    |    |      |       |                   |               |               |                    |
| 32        | 14  | 34  | 45 <sup>+0.2/-0.5</sup>  | 10            | 22         | 13 | 10 | 32.5 | 141.1 | 1                 | 93            | <b>174383</b> | <b>SNC-32</b>      |
| 40        | 16  | 40  | 54 <sup>-0.5</sup>       | 12            | 25         | 16 | 12 | 38   | 158.9 | 1                 | 140           | <b>174384</b> | <b>SNC-40</b>      |
| 50        | 21  | 45  | 64 <sup>-0.6</sup>       | 16            | 27         | 16 | 12 | 46.5 | 168.8 | 1                 | 234           | <b>174385</b> | <b>SNC-50</b>      |
| 63        | 21  | 51  | 75 <sup>-0.6</sup>       | 16            | 32         | 21 | 16 | 56.5 | 189.1 | 1                 | 331           | <b>174386</b> | <b>SNC-63</b>      |
| 80        | 25  | 65  | 93 <sup>-0.8</sup>       | 20            | 36         | 22 | 16 | 72   | 209.6 | 1                 | 618           | <b>174387</b> | <b>SNC-80</b>      |
| 100       | 25  | 75  | 110 <sup>+0.3/-0.8</sup> | 20            | 41         | 27 | 20 | 89   | 228.5 | 1                 | 865           | <b>174388</b> | <b>SNC-100</b>     |
| 125       | 37  | 97  | 131 <sup>-0.8</sup>      | 30            | 50         | 30 | 25 | 110  | 275   | 1                 | 1728          | <b>174389</b> | <b>SNC-125</b>     |

1) Corrosion resistance class CRC 1 to Festo standard FN 940070

Low corrosion stress. Dry internal application or transport and storage protection. Also applies to parts behind coverings, in the non-visible interior area, and parts which are covered in the application (e.g. drive trunnions).

2) Suitable for ATEX

## Accessories

**Swivel flange**  
**SNCB/SNCB-...-R3**

Material:

SNCB: die-cast aluminium

SNCB-...-R3: die-cast aluminium with  
protective coating

Free of copper and PTFE

RoHS-compliant

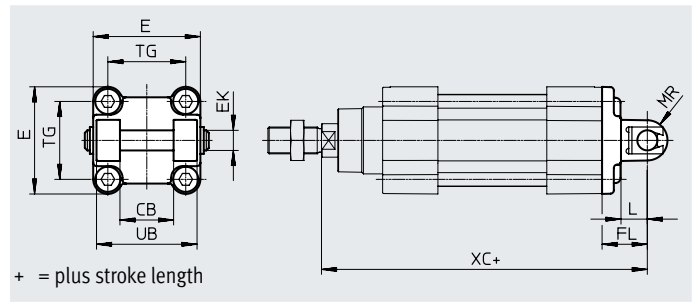
**Dimensions and ordering data**

| For diam. | CB  | E                        | EK<br>∅ | FL   | L  | MR   | TG   | UB  | XC    |
|-----------|-----|--------------------------|---------|------|----|------|------|-----|-------|
| [mm]      | H14 |                          | H9/e8   | ±0.2 |    | -0.5 |      | h14 |       |
| 32        | 26  | 45 <sup>+0.2/-0.5</sup>  | 10      | 22   | 13 | 8.5  | 32.5 | 45  | 141.1 |
| 40        | 28  | 54 <sub>-0.5</sub>       | 12      | 25   | 16 | 12   | 38   | 52  | 158.9 |
| 50        | 32  | 64 <sub>-0.6</sub>       | 12      | 27   | 16 | 12   | 46.5 | 60  | 168.8 |
| 63        | 40  | 75 <sub>-0.6</sub>       | 16      | 32   | 21 | 16   | 56.5 | 70  | 189.1 |
| 80        | 50  | 93 <sub>-0.8</sub>       | 16      | 36   | 22 | 16   | 72   | 90  | 209.6 |
| 100       | 60  | 110 <sup>+0.3/-0.8</sup> | 20      | 41   | 27 | 20   | 89   | 110 | 228.5 |
| 125       | 70  | 131 <sub>-0.8</sub>      | 25      | 50   | 30 | 25   | 110  | 130 | 275   |

| For diam.<br>[mm] | Basic type        |               |               |                 | R3 – High corrosion protection |               |               |                    |
|-------------------|-------------------|---------------|---------------|-----------------|--------------------------------|---------------|---------------|--------------------|
|                   | CRC <sup>1)</sup> | Weight<br>[g] | Part no.      | Type            | CRC <sup>1)</sup>              | Weight<br>[g] | Part no.      | Type               |
| 32                | 1                 | 103           | <b>174390</b> | <b>SNCB-32</b>  | 3                              | 100           | <b>176944</b> | <b>SNCB-32-R3</b>  |
| 40                | 1                 | 155           | <b>174391</b> | <b>SNCB-40</b>  | 3                              | 151           | <b>176945</b> | <b>SNCB-40-R3</b>  |
| 50                | 1                 | 232           | <b>174392</b> | <b>SNCB-50</b>  | 3                              | 228           | <b>176946</b> | <b>SNCB-50-R3</b>  |
| 63                | 1                 | 375           | <b>174393</b> | <b>SNCB-63</b>  | 3                              | 371           | <b>176947</b> | <b>SNCB-63-R3</b>  |
| 80                | 1                 | 636           | <b>174394</b> | <b>SNCB-80</b>  | 3                              | 632           | <b>176948</b> | <b>SNCB-80-R3</b>  |
| 100               | 1                 | 1035          | <b>174395</b> | <b>SNCB-100</b> | 3                              | 986           | <b>176949</b> | <b>SNCB-100-R3</b> |
| 125               | 1                 | 1860          | <b>174396</b> | <b>SNCB-125</b> | 3                              | 1776          | <b>176950</b> | <b>SNCB-125-R3</b> |

1) Corrosion resistance class CRC 1 to Festo standard FN 940070

Low corrosion stress. Dry internal application or transport and storage protection. Also applies to parts behind coverings, in the non-visible interior area, and parts which are covered in the application (e.g. drive trunnions).

Corrosion resistance class CRC 3 to Festo standard FN 940070

High corrosion stress. Outdoor exposure under moderate corrosive conditions. Externally visible parts with primarily functional surface requirements which are in direct contact with a normal industrial environment.

## Accessories

### Swivel flange SNCS/CRSNCS/SNCS-...-R3

Material:  
 SNCS 32 ... 50:  
 Die-cast aluminium  
 SNCS 63 ... 125:  
 Wrought aluminium alloy  
 CRSNCS 32 ... 80:  
 High-alloy stainless steel  
 SNCS-...-R3 100 ... 125:  
 Wrought aluminium alloy with  
 protective coating  
 RoHS-compliant

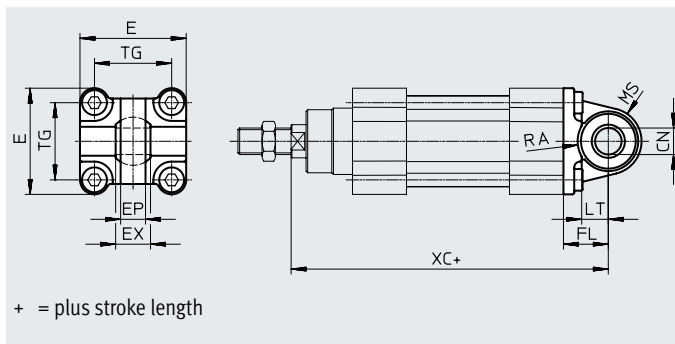

#### Dimensions and ordering data

| For diam.<br>[mm] | CN<br>∅              |                | E           |             | EP<br>±0.2 | EX | FL<br>±0.2 |
|-------------------|----------------------|----------------|-------------|-------------|------------|----|------------|
|                   | DSBG-...             | DSBG-...-R3    | DSBG-...    | DSBG-...-R3 |            |    |            |
| 32                | 10 <sup>+0.013</sup> | 10+0.015/-0.04 | 45+0.2/-0.5 | 45-0.5      | 10.5       | 14 | 22         |
| 40                | 12 <sup>+0.015</sup> | 12+0.018/-0.04 | 54-0.5      | 54-0.5      | 12         | 16 | 25         |
| 50                | 16 <sup>+0.015</sup> | 16+0.018/-0.04 | 64-0.6      | 64-0.6      | 15         | 21 | 27         |
| 63                | 16 <sup>+0.015</sup> | 16+0.018/-0.04 | 74.5±0.5    | 75-0.6      | 15         | 21 | 32         |
| 80                | 20 <sup>+0.018</sup> | 20+0.021/-0.04 | 92.2±0.8    | 93-0.8      | 18         | 25 | 36         |
| 100               | 20 <sup>+0.018</sup> | 20+0.021/-0.04 | 109+1/-0.7  | 109+1/-0.7  | 18         | 25 | 41         |
| 125               | 30 <sup>+0.018</sup> | 30+0.021/-0.04 | 132+1/-0.7  | 132+1/-0.7  | 25         | 37 | 50         |

| For diam.<br>[mm] | LT | MS                 |                    | RA         |                   | TG   | XC    |
|-------------------|----|--------------------|--------------------|------------|-------------------|------|-------|
|                   |    | DSBG               | DSBG-...-R3        | DSBG<br>+1 | DSBG-...-R3<br>+1 |      |       |
| 32                | 13 | 15 <sup>+0.5</sup> | 15 <sup>+0.5</sup> | 14.5       | 14.5              | 32.5 | 141.1 |
| 40                | 16 | 17 <sup>+0.5</sup> | 17 <sup>+0.5</sup> | 17.5       | 17.5              | 38   | 158.9 |
| 50                | 16 | 20 <sup>+0.5</sup> | 20 <sup>+0.5</sup> | 18.5       | 19                | 46.5 | 168.8 |
| 63                | 21 | 23-0.5             | 22 <sup>+0.5</sup> | 23         | 23                | 56.5 | 189.1 |
| 80                | 22 | 28-0.5             | 27 <sup>+0.5</sup> | 25         | 25                | 72   | 209.6 |
| 100               | 27 | 30±0.5             | 30±0.5             | 95         | 100               | 89   | 228.5 |
| 125               | 30 | 39±0.5             | 39±0.5             | 100        | 100               | 110  | 275   |

| For diam.<br>[mm] | Basic type        |               |          |          | High corrosion protection |               |          |             |
|-------------------|-------------------|---------------|----------|----------|---------------------------|---------------|----------|-------------|
|                   | CRC <sup>1)</sup> | Weight<br>[g] | Part no. | Type     | CRC <sup>1)</sup>         | Weight<br>[g] | Part no. | Type        |
| 32                | 1                 | 86            | 174397   | SNCS-32  | 4                         | 161           | 2895920  | CRSNCS-32   |
| 40                | 1                 | 122           | 174398   | SNCS-40  | 4                         | 239           | 2895921  | CRSNCS-40   |
| 50                | 1                 | 216           | 174399   | SNCS-50  | 4                         | 403           | 2895922  | CRSNCS-50   |
| 63                | 2                 | 281           | 174400   | SNCS-63  | 4                         | 576           | 2895923  | CRSNCS-63   |
| 80                | 2                 | 557           | 174401   | SNCS-80  | 4                         | 1173          | 2895924  | CRSNCS-80   |
| 100               | 2                 | 683           | 174402   | SNCS-100 | 3                         | 684           | 2895925  | SNCS-100-R3 |
| 125               | 2                 | 1369          | 174403   | SNCS-125 | 3                         | 1369          | 2895926  | SNCS-125-R3 |

1) Corrosion resistance class CRC 1 to Festo standard FN 940070  
 Low corrosion stress. Dry internal application or transport and storage protection. Also applies to parts behind coverings, in the non-visible interior area, and parts which are covered in the application (e.g. drive trunnions).  
 Corrosion resistance class CRC 2 to Festo standard FN 940070  
 Moderate corrosion stress. Indoor applications in which condensation can occur. External visible parts with primarily decorative surface requirements which are in direct contact with a normal industrial environment.

Corrosion resistance class CRC 3 to Festo standard FN 940070  
 High corrosion stress. Outdoor exposure under moderate corrosive conditions. Externally visible parts with primarily functional surface requirements which are in direct contact with a normal industrial environment.

Corrosion resistance class CRC 4 to Festo standard FN 940070  
 Particularly high corrosion stress. Outdoor exposure under extreme corrosive conditions. Parts exposed to aggressive media, e.g. in the chemical or food industries. Such applications may need to be safeguarded by special tests (→ also FN 940082), using appropriate media.



## Accessories

### Swivel flange SNCL

Material:  
Die-cast aluminium  
Free of copper and PTFE  
RoHS-compliant

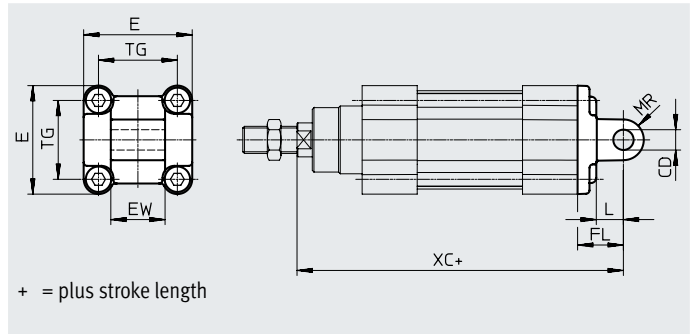





#### Dimensions and ordering data

| For diam.<br>[mm] | CD<br>∅<br>H9 | E                        | EW<br>h12 | FL<br>±0.2 | L  | MR | TG   | XC    | CRC <sup>1)</sup> | Weight<br>[g] | Part no. | Type     |
|-------------------|---------------|--------------------------|-----------|------------|----|----|------|-------|-------------------|---------------|----------|----------|
| 32                | 10            | 45 <sup>+0.2/-0.5</sup>  | 26        | 22         | 13 | 10 | 32.5 | 141.1 | 1                 | 71            | 174404   | SNCL-32  |
| 40                | 12            | 54 <sup>-0.5</sup>       | 28        | 25         | 16 | 12 | 38   | 158.9 | 1                 | 95            | 174405   | SNCL-40  |
| 50                | 12            | 64 <sup>-0.6</sup>       | 32        | 27         | 16 | 12 | 46.5 | 168.8 | 1                 | 158           | 174406   | SNCL-50  |
| 63                | 16            | 75 <sup>-0.6</sup>       | 40        | 32         | 21 | 16 | 56.5 | 189.1 | 1                 | 225           | 174407   | SNCL-63  |
| 80                | 16            | 93 <sup>-0.8</sup>       | 50        | 36         | 22 | 16 | 72   | 209.6 | 1                 | 436           | 174408   | SNCL-80  |
| 100               | 20            | 110 <sup>+0.3/-0.8</sup> | 60        | 41         | 27 | 20 | 89   | 228.5 | 1                 | 606           | 174409   | SNCL-100 |
| 125               | 25            | 131 <sup>-0.8</sup>      | 70        | 50         | 30 | 25 | 110  | 275   | 1                 | 1135          | 174410   | SNCL-125 |

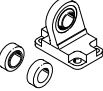

1) Corrosion resistance class CRC 1 to Festo standard FN 940070



Low corrosion stress. Dry internal application or transport and storage protection. Also applies to parts behind coverings, in the non-visible interior area, and parts which are covered in the application (e.g. drive trunnions).

## Accessories

| Ordering data – Mounting components  |              |          |          | Data sheets → Internet: clevis foot   |              |          |           |
|--|--------------|----------|----------|---|--------------|----------|-----------|
| Designation  | For diameter | Part no. | Type     | Designation   | For diameter | Part no. | Type      |
| <b>Clevis foot LNG</b>   |              |          |          | <b>Clevis foot LSN</b>  |              |          |           |
|  | 32           | 33890    | LNG-32   |  | 32           | 5561     | LSN-32    |
|  | 40           | 33891    | LNG-40   |   | 40           | 5562     | LSN-40    |
|  | 50           | 33892    | LNG-50   |   | 50           | 5563     | LSN-50    |
|  | 63           | 33893    | LNG-63   |   | 63           | 5564     | LSN-63    |
|  | 80           | 33894    | LNG-80   |   | 80           | 5565     | LSN-80    |
|  | 100          | 33895    | LNG-100  |   | 100          | 5566     | LSN-100   |
|  | 125          | 33896    | LNG-125  |   | 125          | 6987     | LSN-125   |
| <b>Clevis foot LSNG</b>  |              |          |          | <b>Clevis foot LSNSG</b>  |              |          |           |
|  | 32           | 31740    | LSNG-32  |  | 32           | 31747    | LSNSG-32  |
|  | 40           | 31741    | LSNG-40  |   | 40           | 31748    | LSNSG-40  |
|  | 50           | 31742    | LSNG-50  |   | 50           | 31749    | LSNSG-50  |
|  | 63           | 31743    | LSNG-63  |   | 63           | 31750    | LSNSG-63  |
|  | 80           | 31744    | LSNG-80  |   | 80           | 31751    | LSNSG-80  |
|  | 100          | 31745    | LSNG-100 |   | 100          | 31752    | LSNSG-100 |
|  | 125          | 31746    | LSNG-125 |   | 125          | 31753    | LSNSG-125 |
| <b>Clevis foot LBG<sup>1)</sup></b>  |              |          |          | <b>Right-angle clevis foot LQG<sup>1)</sup></b>                                   |              |          |           |
|  | 32           | 31761    | LBG-32   |  | 32           | 31768    | LQG-32    |
|  | 40           | 31762    | LBG-40   |   | 40           | 31769    | LQG-40    |
|  | 50           | 31763    | LBG-50   |   | 50           | 31770    | LQG-50    |
|  | 63           | 31764    | LBG-63   |   | 63           | 31771    | LQG-63    |
|  | 80           | 31765    | LBG-80   |   | 80           | 31772    | LQG-80    |
|  | 100          | 31766    | LBG-100  |   | 100          | 31773    | LQG-100   |
|  | 125          | 31767    | LBG-125  |   | 125          | 31774    | LQG-125   |

1) Suitable for ATEX

| Ordering data – Mounting components, corrosion-resistant                           |              |          |           | Data sheets → Internet: crlng  |              |          |           |
|--|--------------|----------|-----------|--|--------------|----------|-----------|
| Designation  | For diameter | Part no. | Type      | Designation  | For diameter | Part no. | Type      |
| <b>Clevis foot CRLNG</b>   |              |          |           | <b>Clevis foot CRLNG</b>   |              |          |           |
|  | 32           | 161840   | CRLNG-32  |  | 32           | 161840   | CRLNG-32  |
|  | 40           | 161841   | CRLNG-40  |  | 40           | 161841   | CRLNG-40  |
|  | 50           | 161842   | CRLNG-50  |  | 50           | 161842   | CRLNG-50  |
|  | 63           | 161843   | CRLNG-63  |  | 63           | 161843   | CRLNG-63  |
|  | 80           | 161844   | CRLNG-80  |  | 80           | 161844   | CRLNG-80  |
|  | 100          | 161845   | CRLNG-100 |  | 100          | 161845   | CRLNG-100 |
|  | 125          | 176951   | CRLNG-125 |  | 125          | 176951   | CRLNG-125 |

| Ordering data – Mounting components, high corrosion protection                     |              |          |            | Data sheets → Internet: clevis foot  |              |          |            |
|--|--------------|----------|------------|--|--------------|----------|------------|
| Designation  | For diameter | Part no. | Type       | Designation  | For diameter | Part no. | Type       |
| <b>Clevis foot LBG-R3</b>  |              |          |            | <b>Clevis foot LBG-R3</b>  |              |          |            |
|  | 32           | 2078790  | LBG-32-R3  |  | 32           | 2078790  | LBG-32-R3  |
|  | 40           | 2078792  | LBG-40-R3  |  | 40           | 2078792  | LBG-40-R3  |
|  | 50           | 2078794  | LBG-50-R3  |  | 50           | 2078794  | LBG-50-R3  |
|  | 63           | 2078795  | LBG-63-R3  |  | 63           | 2078795  | LBG-63-R3  |
|  | 80           | 2078797  | LBG-80-R3  |  | 80           | 2078797  | LBG-80-R3  |
|  | 100          | 2078799  | LBG-100-R3 |  | 100          | 2078799  | LBG-100-R3 |
|  | 125          | 2078837  | LBG-125-R3 |  | 125          | 2078837  | LBG-125-R3 |

## Accessories

## Ordering data – Piston rod attachments

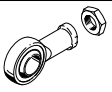
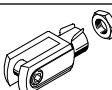
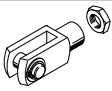
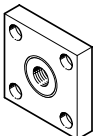
| Designation  | For diameter | Part no. | Type         |
|--|--------------|----------|--------------|
| <b>Rod eye SGS</b>   |              |          |              |
|   | 32           | 9261     | SGS-M10x1.25 |
|  | 40           | 9262     | SGS-M12x1.25 |
|  | 50           | 9263     | SGS-M16x1.5  |
|  | 63           |          |              |
|  | 80           | 9264     | SGS-M20x1.5  |
|  | 100          |          |              |
|  | 125          | 10774    | SGS-M27x2    |
| <b>Rod clevis SG<sup>1)</sup></b>  |              |          |              |
|   | 32           | 6144     | SG-M10x1.25  |
|  | 40           | 6145     | SG-M12x1.25  |
|  | 50           | 6146     | SG-M16x1.5   |
|  | 63           |          |              |
|   | 80           | 6147     | SG-M20x1.5   |
|  | 100          |          |              |
|  | 125          | 14987    | SG-M27x2-B   |
| <b>Coupling piece KSG<sup>1)</sup></b>   |              |          |              |
|  | 32           | 32963    | KSG-M10x1.25 |
|  | 40           | 32964    | KSG-M12x1.25 |
|  | 50           | 32965    | KSG-M16x1.5  |
|  | 63           |          |              |
|  | 80           | 32966    | KSG-M20x1.5  |
|  | 100          |          |              |
|  | 125          | 32967    | KSG-M27x2    |

1) Suitable for ATEX

Data sheets → Internet: piston rod attachment

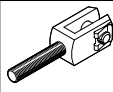
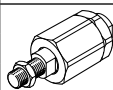
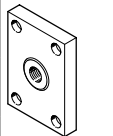
| Designation  | For diameter | Part no. | Type         |
|--|--------------|----------|--------------|
| <b>Rod clevis SGA<sup>1)</sup></b>   |              |          |              |
|   | 32           | 32954    | SGA-M10x1.25 |
|  | 40           | 10767    | SGA-M12x1.25 |
|  | 50           | 10768    | SGA-M16x1.5  |
|  | 63           |          |              |
|  | 80           | 10769    | SGA-M20x1.5  |
|  | 100          |          |              |
|  | 125          | 10770    | SGA-M27x2    |
| <b>Self-aligning rod coupler FK<sup>1)</sup></b>                                   |              |          |              |
|   | 32           | 6140     | FK-M10x1.25  |
|  | 40           | 6141     | FK-M12x1.25  |
|  | 50           | 6142     | FK-M16x1.5   |
|  | 63           |          |              |
|  | 80           | 6143     | FK-M20x1.5   |
|  | 100          |          |              |
|  | 125          | 10485    | FK-M27x2     |
| <b>Coupling piece KSZ<sup>1)</sup></b>   |              |          |              |
|  | 32           | 36125    | KSZ-M10x1.25 |
|  | 40           | 36126    | KSZ-M12x1.25 |
|  | 50           | 36127    | KSZ-M16x1.5  |
|  | 63           |          |              |
|  | 80           | 36128    | KSZ-M20x1.5  |
|  | 100          |          |              |
|  | 125          | -        | -            |

## Ordering data – Piston rod attachments, corrosion-resistant

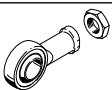
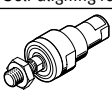
| Designation   | For diameter | Part no. | Type           |
|---|--------------|----------|----------------|
| <b>Rod eye CRSGS</b>  |              |          |                |
|  | 32           | 195582   | CRSGS-M10x1.25 |
|   | 40           | 195583   | CRSGS-M12x1.25 |
|   | 50           | 195584   | CRSGS-M16x1.5  |
|   | 63           |          |                |
|   | 80           | 195585   | CRSGS-M20x1.5  |
|   | 100          |          |                |
|   | 125          | 195586   | CRSGS-M27x2    |
| <b>Self-aligning rod coupler CRFK<sup>1)</sup></b>                                  |              |          |                |
|  | 32           | 2305778  | CRFK-M10x1.25  |
|   | 40           | 2305779  | CRFK-M12x1.25  |
|   | 50           | 2490673  | CRFK-M16x1.5   |
|   | 63           |          |                |
|   | 80           | 2545677  | CRFK-M20x1.5   |
|   | 100          |          |                |
|   |              |          |                |

1) Suitable for ATEX

Data sheets → Internet: piston rod attachment

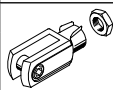
| Designation   | For diameter | Part no. | Type          |
|---|--------------|----------|---------------|
| <b>Rod clevis CRSG<sup>1)</sup></b>   |              |          |               |
|  | 32           | 13569    | CRSG-M10x1.25 |
|   | 40           | 13570    | CRSG-M12x1.25 |
|   | 50           | 13571    | CRSG-M16x1.5  |
|   | 63           |          |               |
|   | 80           | 13572    | CRSG-M20x1.5  |
|   | 100          |          |               |
|   | 125          | 185361   | CRSG-M27x2    |

## Accessories

### Bellows kit DADB



| General technical data                          |      | 32  | 40         | 50         | 63         | 80         | 100        |
|---|------|---|------------|------------|------------|------------|------------|
| Type DADB-V6-                                   |      |   |            |            |            |            |            |
| Max. stroke range of the cylinder <sup>1)</sup> | [mm] | 10 ... 500  | 10 ... 500 | 10 ... 500 | 10 ... 500 | 10 ... 500 | 10 ... 500 |
| Type of mounting                                |      | Via threaded pin  |            |            |            |            |            |
| Mounting position                               |      | Any   |            |            |            |            |            |
| Media resistance                                |      | Dust, chippings, oil, grease, fuel (→ Internet: media resistance) |            |            |            |            |            |
| Ambient temperature <sup>2)</sup>               | [°C] | -10 ... +80   |            |            |            |            |            |
| Degree of protection                            |      | IP54  |            |            |            |            |            |
| Corrosion resistance CRC <sup>3)</sup>          |      | 3   |            |            |            |            |            |

1) In combination with the bellows kit DADB

2) Note operating range of proximity switches and cylinder

3) Corrosion resistance class CRC 3 to Festo standard FN 940070

High corrosion stress. Outdoor exposure under moderate corrosive conditions. Externally visible parts with primarily functional surface requirements which are in direct contact with a normal industrial environment.

### Materials

#### Sectional view

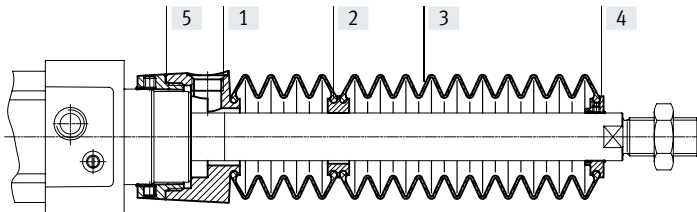

#### Bellows

|     |                   |                         |
|-----|-------------------|-------------------------|
| [1] | Connection        | Polyamide               |
| [2] | Adapter           | Polyamide               |
| [3] | Bellows           | NBR                     |
| [4] | End piece         | Polyamide               |
| [5] | Connector         | Polyamide               |
| -   | O-ring            | NBR                     |
|     | Note on materials | Free of copper and PTFE |
|     |                   | RoHS-compliant          |

| Weight [g]    |  | 32  | 40  | 50  | 63  | 80  | 100 |
|---------------|--|-----|-----|-----|-----|-----|-----|
| Type DADB-V6- |  |     |     |     |     |     |     |
| Stroke [mm]   |  |     |     |     |     |     |     |
| 10 ... 50     |  | 29  | 42  | 71  | 69  | 99  | 124 |
| 51 ... 125    |  | 41  | 56  | 91  | 89  | 127 | 152 |
| 126 ... 175   |  | 52  | 68  | 105 | 103 | 140 | 165 |
| 176 ... 250   |  | 66  | 85  | 129 | 127 | 193 | 218 |
| 251 ... 300   |  | 79  | 100 | 147 | 145 | 231 | 255 |
| 301 ... 350   |  | 92  | 115 | 166 | 164 | 268 | 293 |
| 351 ... 375   |  | 92  | 115 | 167 | 165 | 259 | 284 |
| 376 ... 425   |  | 104 | 129 | 185 | 183 | 296 | 321 |
| 426 ... 475   |  | 117 | 144 | 204 | 202 | 334 | 359 |
| 476 ... 500   |  | 117 | 144 | 205 | 203 | 324 | 349 |

## Accessories

### Travel speed $v$ as a function of tubing length $l$

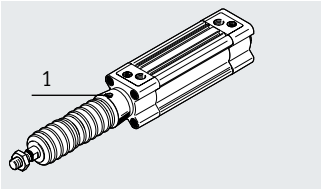

The bellows kit is a leak-free system. To prevent unwanted media from being drawn in, the supply and exhaust air for the kit must be ducted via a pressure

compensation hole in the connection part [1]. The pressure generated in the bellows kit by the positioning motion is primarily defined by the travel speed and the

tubing length. The recommended tubing length based on the travel speed of the drive can be read from the graph.

#### Advancing

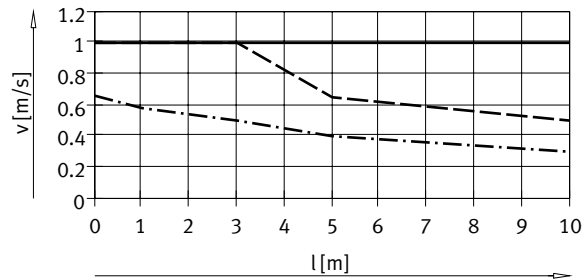

- Diameter 32/50/63
- · - · - Diameter 40
- - - Diameter 80/100

#### Retracting

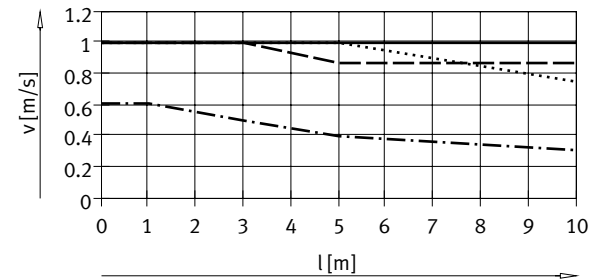

- Diameter 32
- · - · - Diameter 40
- - - Diameter 50/63
- Diameter 80/100

#### Note

The push-in fittings in the adjacent table must be used for the pressure compensation hole. Silencers can be used as an alternative. This reduces the travel speed slightly.

#### Tube size and push-in fitting for pressure compensation hole

| $\varnothing$ [mm] | Tubing O.D. [mm] | Push-in fitting |                    |
|--------------------|------------------|-----------------|--------------------|
|                    |                  | Part no.        | Type               |
| 32, 40             | 8                | 186109          | QS-G1/8-8-I        |
|                    |                  | 578376          | NPQH-DK-G18-Q8-P10 |
|                    |                  | 578362          | NPQH-D-G18-S8-P10  |
| 50, 63, 80, 100    | 12               | 186350          | QS-G1/4-12         |
|                    |                  | 578344          | NPQH-D-G14-Q12-P10 |
|                    |                  | 578366          | NPQH-D-G14-S12-P10 |

Accessories

Dimensions

Download CAD data → [www.festo.com](http://www.festo.com)

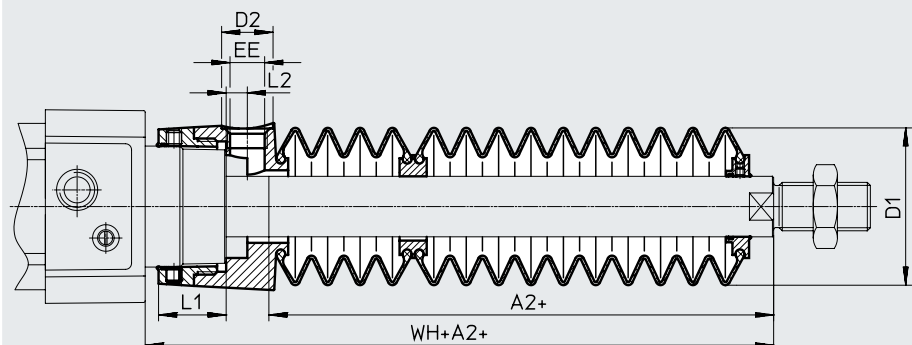

+ = plus stroke length

| ∅<br>Stroke<br>[mm] | 32               |            |     |       |      |     |       | 40               |            |    |      |      |     |       |
|---------------------|------------------|------------|-----|-------|------|-----|-------|------------------|------------|----|------|------|-----|-------|
|                     | A2 <sup>1)</sup> | D1<br>max. | D2  | EE    | L1   | L2  | WH+A2 | A2 <sup>1)</sup> | D1<br>max. | D2 | EE   | L1   | L2  | WH+A2 |
| 10 ... 50           | 29               | 38         | 14  | G1/8  | 12.9 | 5.4 | 55    | 28               | 46         | 14 | G1/8 | 16.3 | 5.4 | 56.7  |
| 51 ... 125          | 47               |            |     |       |      |     | 73    | 43               |            |    |      |      |     | 71.7  |
| 126 ... 175         | 61               |            |     |       |      |     | 87    | 56               |            |    |      |      |     | 84.7  |
| 176 ... 250         | 80               |            |     |       |      |     | 106   | 72               |            |    |      |      |     | 100.7 |
| 251 ... 300         | 96               |            |     |       |      |     | 122   | 86               |            |    |      |      |     | 114.7 |
| 301 ... 350         | 112              |            |     |       |      |     | 138   | 100              |            |    |      |      |     | 128.7 |
| 351 ... 375         | 114              |            |     |       |      |     | 140   | 101              |            |    |      |      |     | 129.7 |
| 376 ... 425         | 130              |            |     |       |      |     | 156   | 115              |            |    |      |      |     | 143.7 |
| 426 ... 475         | 145              |            |     |       |      |     | 171   | 130              |            |    |      |      |     | 158.7 |
| 476 ... 500         | 147              | 173        | 131 | 159.7 |      |     |       |                  |            |    |      |      |     |       |

| ∅<br>Stroke<br>[mm] | 50               |            |     |       |       |    |       | 63               |            |    |      |      |    |       |
|---------------------|------------------|------------|-----|-------|-------|----|-------|------------------|------------|----|------|------|----|-------|
|                     | A2 <sup>1)</sup> | D1<br>max. | D2  | EE    | L1    | L2 | WH+A2 | A2 <sup>1)</sup> | D1<br>max. | D2 | EE   | L1   | L2 | WH+A2 |
| 10 ... 50           | 28               | 57         | 17  | G1/4  | 22.35 | 7  | 63.6  | 28               | 57         | 17 | G1/4 | 22.4 | 7  | 63.9  |
| 51 ... 125          | 46               |            |     |       |       |    | 81.6  | 46               |            |    |      |      |    | 81.9  |
| 126 ... 175         | 56               |            |     |       |       |    | 91.6  | 56               |            |    |      |      |    | 91.9  |
| 176 ... 250         | 73               |            |     |       |       |    | 108.6 | 73               |            |    |      |      |    | 108.9 |
| 251 ... 300         | 86               |            |     |       |       |    | 121.6 | 86               |            |    |      |      |    | 121.9 |
| 301 ... 350         | 97               |            |     |       |       |    | 132.6 | 97               |            |    |      |      |    | 132.9 |
| 351 ... 375         | 105              |            |     |       |       |    | 140.6 | 105              |            |    |      |      |    | 140.9 |
| 376 ... 425         | 116              |            |     |       |       |    | 151.6 | 116              |            |    |      |      |    | 151.9 |
| 426 ... 475         | 126              |            |     |       |       |    | 161.6 | 126              |            |    |      |      |    | 161.9 |
| 476 ... 500         | 134              | 169.6      | 134 | 169.9 |       |    |       |                  |            |    |      |      |    |       |

| ∅<br>Stroke<br>[mm] | 80               |            |     |       |    |    |       | 100              |            |    |      |    |    |       |
|---------------------|------------------|------------|-----|-------|----|----|-------|------------------|------------|----|------|----|----|-------|
|                     | A2 <sup>1)</sup> | D1<br>max. | D2  | EE    | L1 | L2 | WH+A2 | A2 <sup>1)</sup> | D1<br>max. | D2 | EE   | L1 | L2 | WH+A2 |
| 10 ... 50           | 25               | 93         | 17  | G1/4  | 28 | 4  | 70.4  | 25               | 93         | 17 | G1/4 | 28 | 4  | 74.3  |
| 51 ... 125          | 37               |            |     |       |    |    | 82.4  | 37               |            |    |      |    |    | 86.3  |
| 126 ... 175         | 49               |            |     |       |    |    | 94.4  | 49               |            |    |      |    |    | 98.3  |
| 176 ... 250         | 62               |            |     |       |    |    | 107.4 | 62               |            |    |      |    |    | 111.3 |
| 251 ... 300         | 74               |            |     |       |    |    | 119.4 | 74               |            |    |      |    |    | 123.3 |
| 301 ... 350         | 86               |            |     |       |    |    | 131.4 | 86               |            |    |      |    |    | 135.3 |
| 351 ... 375         | 87               |            |     |       |    |    | 132.4 | 87               |            |    |      |    |    | 136.3 |
| 376 ... 425         | 98               |            |     |       |    |    | 143.4 | 98               |            |    |      |    |    | 147.3 |
| 426 ... 475         | 110              |            |     |       |    |    | 155.4 | 110              |            |    |      |    |    | 159.3 |
| 476 ... 500         | 111              | 156.4      | 111 | 160.3 |    |    |       |                  |            |    |      |    |    |       |

1) The dimension corresponds to the E value (piston rod extension) of the drive

## Accessories

## Ordering data – Bellows kit

An extended piston rod (order code E) is absolutely essential when using a bellows kit → Ordering data – Modular product system.

The necessary dimension for order code E as a function of piston diameter and cylinder stroke as well as the corresponding bellows kit is indicated in the table below:

## Order example:

Selected standards-based cylinder:  
DSBG-32-320-PPV-A...

The dimension for the corresponding E value (see table):  
112 mm

Complete order reference for standards-based cylinder:

DSBG-32-320-PPV-A-...-112E

The corresponding bellows kit:

DADB-V6-32-S301-350

| Cylinder data |             |                 | Bellows kit         |                     | Cylinder data |             |                      | Bellows kit |                      |
|---------------|-------------|-----------------|---------------------|---------------------|---------------|-------------|----------------------|-------------|----------------------|
| ∅             | Stroke      | Dimension for E | Part no.            | Type                | ∅             | Stroke      | Dimension for E      | Part no.    | Type                 |
| [mm]          | [mm]        | [mm]            |                     |                     | [mm]          | [mm]        | [mm]                 |             |                      |
| 32            | 10 ... 50   | 29              | 553271              | DADB-V6-32-S10-50   | 40            | 10 ... 50   | 28                   | 553291      | DADB-V6-40-S10-50    |
|               | 51 ... 125  | 47              | 553273              | DADB-V6-32-S51-125  |               | 51 ... 125  | 43                   | 553293      | DADB-V6-40-S51-125   |
|               | 126 ... 175 | 61              | 553275              | DADB-V6-32-S126-175 |               | 126 ... 175 | 56                   | 553295      | DADB-V6-40-S126-175  |
|               | 176 ... 250 | 80              | 553277              | DADB-V6-32-S176-250 |               | 176 ... 250 | 72                   | 553297      | DADB-V6-40-S176-250  |
|               | 251 ... 300 | 96              | 553279              | DADB-V6-32-S251-300 |               | 251 ... 300 | 86                   | 553399      | DADB-V6-40-S251-300  |
|               | 301 ... 350 | 112             | 553281              | DADB-V6-32-S301-350 |               | 301 ... 350 | 100                  | 553301      | DADB-V6-40-S301-350  |
|               | 351 ... 375 | 114             | 553283              | DADB-V6-32-S351-375 |               | 351 ... 375 | 101                  | 553303      | DADB-V6-40-S351-375  |
|               | 376 ... 425 | 130             | 553285              | DADB-V6-32-S376-425 |               | 376 ... 425 | 115                  | 553305      | DADB-V6-40-S376-425  |
|               | 426 ... 475 | 145             | 553287              | DADB-V6-32-S426-475 |               | 426 ... 475 | 130                  | 553307      | DADB-V6-40-S426-475  |
| 476 ... 500   | 147         | 553289          | DADB-V6-32-S476-500 | 476 ... 500         | 131           | 553309      | DADB-V6-40-S476-500  |             |                      |
| 50            | 10 ... 50   | 28              | 553311              | DADB-V6-50-S10-50   | 63            | 10 ... 50   | 28                   | 553331      | DADB-V6-63-S10-50    |
|               | 51 ... 125  | 46              | 553313              | DADB-V6-50-S51-125  |               | 51 ... 125  | 46                   | 553333      | DADB-V6-63-S51-125   |
|               | 126 ... 175 | 56              | 553315              | DADB-V6-50-S126-175 |               | 126 ... 175 | 56                   | 553335      | DADB-V6-63-S126-175  |
|               | 176 ... 250 | 73              | 553317              | DADB-V6-50-S176-250 |               | 176 ... 250 | 73                   | 553337      | DADB-V6-63-S176-250  |
|               | 251 ... 300 | 86              | 553319              | DADB-V6-50-S251-300 |               | 251 ... 300 | 86                   | 553339      | DADB-V6-63-S251-300  |
|               | 301 ... 350 | 97              | 553321              | DADB-V6-50-S301-350 |               | 301 ... 350 | 97                   | 553341      | DADB-V6-63-S301-350  |
|               | 351 ... 375 | 105             | 553323              | DADB-V6-50-S351-375 |               | 351 ... 375 | 105                  | 553343      | DADB-V6-63-S351-375  |
|               | 376 ... 425 | 116             | 553325              | DADB-V6-50-S376-425 |               | 376 ... 425 | 116                  | 553345      | DADB-V6-63-S376-425  |
|               | 426 ... 475 | 126             | 553327              | DADB-V6-50-S426-475 |               | 426 ... 475 | 126                  | 553347      | DADB-V6-63-S426-475  |
| 476 ... 500   | 134         | 553329          | DADB-V6-50-S476-500 | 476 ... 500         | 134           | 553349      | DADB-V6-63-S476-500  |             |                      |
| 80            | 10 ... 50   | 25              | 553351              | DADB-V6-80-S10-50   | 100           | 10 ... 50   | 25                   | 553371      | DADB-V6-100-S10-50   |
|               | 51 ... 125  | 37              | 553353              | DADB-V6-80-S51-125  |               | 51 ... 125  | 37                   | 553373      | DADB-V6-100-S51-125  |
|               | 126 ... 175 | 49              | 553355              | DADB-V6-80-S126-175 |               | 126 ... 175 | 49                   | 553375      | DADB-V6-100-S126-175 |
|               | 176 ... 250 | 62              | 553357              | DADB-V6-80-S176-250 |               | 176 ... 250 | 62                   | 553377      | DADB-V6-100-S176-250 |
|               | 251 ... 300 | 74              | 553359              | DADB-V6-80-S251-300 |               | 251 ... 300 | 74                   | 553379      | DADB-V6-100-S251-300 |
|               | 301 ... 350 | 86              | 553361              | DADB-V6-80-S301-350 |               | 301 ... 350 | 86                   | 553381      | DADB-V6-100-S301-350 |
|               | 351 ... 375 | 87              | 553363              | DADB-V6-80-S351-375 |               | 351 ... 375 | 87                   | 553383      | DADB-V6-100-S351-375 |
|               | 376 ... 425 | 98              | 553365              | DADB-V6-80-S376-425 |               | 376 ... 425 | 98                   | 553385      | DADB-V6-100-S376-425 |
|               | 426 ... 475 | 110             | 553367              | DADB-V6-80-S426-475 |               | 426 ... 475 | 110                  | 553387      | DADB-V6-100-S426-475 |
| 476 ... 500   | 111         | 553369          | DADB-V6-80-S476-500 | 476 ... 500         | 111           | 553389      | DADB-V6-100-S476-500 |             |                      |

## Accessories

### Multi-position kit DPNC

Material:  
 Flange: wrought aluminium alloy  
 Threaded pins, hex nuts: galvanised steel

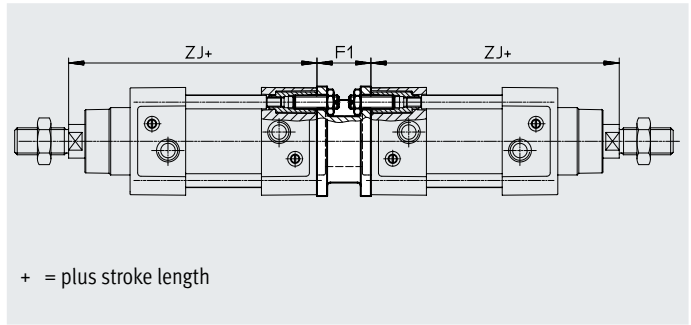
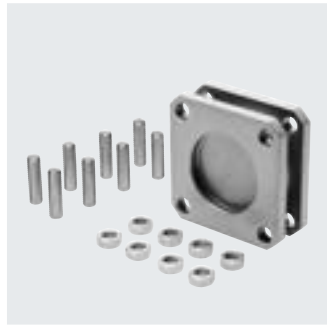

| Dimensions and ordering data |    |       |                      |        |          |                    |
|------------------------------|----|-------|----------------------|--------|----------|--------------------|
| For diam.                    | F1 | ZJ    | Max. complete stroke | Weight | Part no. | Type <sup>1)</sup> |
| [mm]                         |    | +1.8  | [mm]                 | [g]    |          |                    |
| 32                           | 27 | 119.1 | 500                  | 292    | 174418   | DPNC-32            |
| 40                           | 27 | 133.9 | 800                  | 410    | 174419   | DPNC-40            |
| 50                           | 32 | 141.8 | 800                  | 335    | 174420   | DPNC-50            |
| 63                           | 28 | 157.1 | 700                  | 390    | 174421   | DPNC-63            |
| 80                           | 38 | 173.6 | 1000                 | 847    | 174422   | DPNC-80            |
| 100                          | 38 | 187.5 | 900                  | 1200   | 174423   | DPNC-100           |
| 125                          | 48 | 225   | 1000                 | 2102   | 174424   | DPNC-125           |

1) Suitable for ATEX

#### Note

The maximum overall stroke length must not be exceeded when combining cylinders and multi-position kits.

### Connecting two cylinders with identical piston diameters to form a three or four-position cylinder

A three or four-position cylinder consists of two separate cylinders whose piston rods advance in opposing directions.

This means that depending on the actuation and stroke pattern, this type of cylinder can assume up to four positions. In each case the cylinder is moved precisely

against a stop. Note that when one end of the piston rod is fixed, the cylinder barrel

executes the movement. The line connections to the cylinder must be flexible.

#### To achieve 3 positions

Two cylinders with identical stroke length must be connected together.

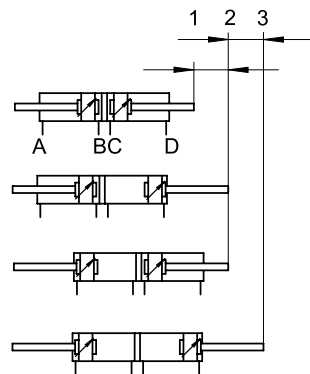

#### To achieve 4 positions

Two cylinders with different stroke lengths must be connected together.

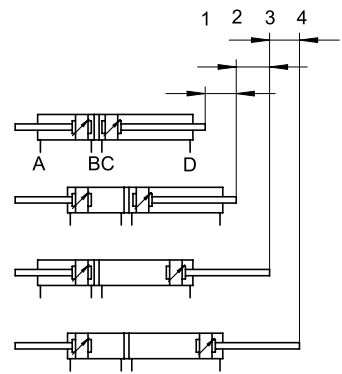



## Accessories

## Ordering data – Guide units for fixed strokes (recirculating ball bearing guide only)

Data sheets → Internet: festo.com

| Stroke<br>[mm]         | Part no. | Type <sup>1)</sup> | Stroke<br>[mm]          | Part no. | Type <sup>1)</sup> |
|------------------------|----------|--------------------|-------------------------|----------|--------------------|
|                        |          |                    |                         |          |                    |
| <b>For diam. 32 mm</b> |          |                    | <b>For diam. 40 mm</b>  |          |                    |
| 10 ... 50              | 34493    | FENG-32-50-KF      | 10 ... 50               | 34499    | FENG-40-50-KF      |
| 10 ... 100             | 34494    | FENG-32-100-KF     | 10 ... 100              | 34500    | FENG-40-100-KF     |
| 10 ... 160             | 34495    | FENG-32-160-KF     | 10 ... 160              | 34501    | FENG-40-160-KF     |
| 10 ... 200             | 34496    | FENG-32-200-KF     | 10 ... 200              | 34502    | FENG-40-200-KF     |
| 10 ... 250             | 150289   | FENG-32-250-KF     | 10 ... 250              | 34503    | FENG-40-250-KF     |
| 10 ... 320             | 34497    | FENG-32-320-KF     | 10 ... 320              | 34504    | FENG-40-320-KF     |
| 10 ... 400             | 150290   | FENG-32-400-KF     | 10 ... 400              | 150291   | FENG-40-400-KF     |
| 10 ... 500             | 34498    | FENG-32-500-KF     | 10 ... 500              | 34505    | FENG-40-500-KF     |
| <b>For diam. 50 mm</b> |          |                    | <b>For diam. 63 mm</b>  |          |                    |
| 10 ... 50              | 34506    | FENG-50-50-KF      | 10 ... 50               | 34513    | FENG-63-50-KF      |
| 10 ... 100             | 34507    | FENG-50-100-KF     | 10 ... 100              | 34514    | FENG-63-100-KF     |
| 10 ... 160             | 34508    | FENG-50-160-KF     | 10 ... 160              | 34515    | FENG-63-160-KF     |
| 10 ... 200             | 34509    | FENG-50-200-KF     | 10 ... 200              | 34516    | FENG-63-200-KF     |
| 10 ... 250             | 34510    | FENG-50-250-KF     | 10 ... 250              | 34517    | FENG-63-250-KF     |
| 10 ... 320             | 34511    | FENG-50-320-KF     | 10 ... 320              | 34518    | FENG-63-320-KF     |
| 10 ... 400             | 150292   | FENG-50-400-KF     | 10 ... 400              | 34519    | FENG-63-400-KF     |
| 10 ... 500             | 34512    | FENG-50-500-KF     | 10 ... 500              | 34520    | FENG-63-500-KF     |
| <b>For diam. 80 mm</b> |          |                    | <b>For diam. 100 mm</b> |          |                    |
| 10 ... 50              | 34521    | FENG-80-50-KF      | 10 ... 50               | 34529    | FENG-100-50-KF     |
| 10 ... 100             | 34522    | FENG-80-100-KF     | 10 ... 100              | 34530    | FENG-100-100-KF    |
| 10 ... 160             | 34523    | FENG-80-160-KF     | 10 ... 160              | 34531    | FENG-100-160-KF    |
| 10 ... 200             | 34524    | FENG-80-200-KF     | 10 ... 200              | 34532    | FENG-100-200-KF    |
| 10 ... 250             | 34525    | FENG-80-250-KF     | 10 ... 250              | 34533    | FENG-100-250-KF    |
| 10 ... 320             | 34526    | FENG-80-320-KF     | 10 ... 320              | 34534    | FENG-100-320-KF    |
| 10 ... 400             | 34527    | FENG-80-400-KF     | 10 ... 400              | 34535    | FENG-100-400-KF    |
| 10 ... 500             | 34528    | FENG-80-500-KF     | 10 ... 500              | 34536    | FENG-100-500-KF    |

## Ordering data – Guide units for variable strokes

Data sheets → Internet: festo.com

| For diameter<br>[mm] | Stroke<br>[mm] | With recirculating ball bearing guide |                    | With plain-bearing guide |                    |
|----------------------|----------------|---------------------------------------|--------------------|--------------------------|--------------------|
|                      |                | Part no.                              | Type <sup>1)</sup> | Part no.                 | Type <sup>1)</sup> |
| 32                   | 10 ... 500     | 34487                                 | FENG-32-...-KF     | 34481                    | FENG-32-...-GF     |
| 40                   | 10 ... 500     | 34488                                 | FENG-40-...-KF     | 34482                    | FENG-40-...-GF     |
| 50                   | 10 ... 500     | 34489                                 | FENG-50-...-KF     | 34483                    | FENG-50-...-GF     |
| 63                   | 10 ... 500     | 34490                                 | FENG-63-...-KF     | 34484                    | FENG-63-...-GF     |
| 80                   | 10 ... 500     | 34491                                 | FENG-80-...-KF     | 34485                    | FENG-80-...-GF     |
| 100                  | 10 ... 500     | 34492                                 | FENG-100-...-KF    | 34486                    | FENG-100-...-GF    |

1) Suitable for ATEX

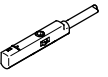
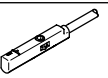

## Accessories

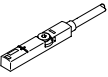
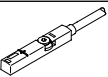
| Ordering data – Proximity switches for T-slot, magneto-resistive                 |  |                  |                       |                           |          | Data sheets → Internet: smt |
|--|--|------------------|-----------------------|---------------------------|----------|-----------------------------|
|  | Type of mounting   | Switching output | Electrical connection | Cable length [m]          | Part no. | Type                        |
| <b>N/O contact</b>   |  |                  |                       |                           |          |                             |
|  | Insertable in the slot from above, flush with the cylinder profile, short design | PNP              | Cable, 3-wire         | 2.5                       | 574335   | SMT-8M-A-PS-24V-E-2.5-OE    |
|  |  |                  | Plug M8x1, 3-pin      | 0.3                       | 574334   | SMT-8M-A-PS-24V-E-0.3-M8D   |
|  |  |                  | Plug M12x1, 3-pin     | 0.3                       | 574337   | SMT-8M-A-PS-24V-E-0.3-M12   |
|  |  | NPN              | Cable, 3-wire         | 2.5                       | 574338   | SMT-8M-A-NS-24V-E-2.5-OE    |
| Plug M8x1, 3-pin   | 0.3  |                  | 574339                | SMT-8M-A-NS-24V-E-0.3-M8D |          |                             |
| <b>N/C contact</b>   |  |                  |                       |                           |          |                             |
|  | Insertable in the slot from above, flush with the cylinder profile, short design | PNP              | Cable, 3-wire         | 7.5                       | 574340   | SMT-8M-A-PO-24V-E-7.5-OE    |



| Ordering data – Proximity switches for T-slot, magnetic reed                      |  |                  |                       |                  |          | Data sheets → Internet: sme |
|---|--|------------------|-----------------------|------------------|----------|-----------------------------|
|   | Type of mounting   | Switching output | Electrical connection | Cable length [m] | Part no. | Type                        |
| <b>N/O contact</b>  |  |                  |                       |                  |          |                             |
|   | Insertable in the slot from above, flush with the cylinder profile | Contacting       | Cable, 3-wire         | 2.5              | 543862   | SME-8M-DS-24V-K-2.5-OE      |
|   |  |                  |                       | 5.0              | 543863   | SME-8M-DS-24V-K-5.0-OE      |
|   |  |                  | Cable, 2-wire         | 2.5              | 543872   | SME-8M-ZS-24V-K-2.5-OE      |
|   |  |                  |                       | Plug M8x1, 3-pin | 0.3      | 543861                      |
| <b>N/C contact</b>  |  |                  |                       |                  |          |                             |
|  | Insertable in the slot from above, flush with the cylinder profile | Contacting       | Cable, 3-wire         | 7.5              | 546799   | SME-8M-DO-24V-K-7.5-OE      |

| Ordering data – Proximity sensor for T-slot, NAMUR                                 |  |                  |                       |                  |          | Data sheets → Internet: sdbt |
|--|--|------------------|-----------------------|------------------|----------|------------------------------|
|  | Type of mounting   | Switching output | Electrical connection | Cable length [m] | Part no. | Type                         |
| <b>N/O contact</b>   |  |                  |                       |                  |          |                              |
|  | Insertable in the slot from above, flush with the cylinder profile | NAMUR            | Cable, 2-wire         | 5                | 579071   | SDBT-MS-20NL-ZN-E-5-LE-EX6   |
|  |  |                  |                       | 10               | 579072   | SDBT-MS-20NL-ZN-E-10-LE-EX6  |

| Ordering data – Safety clip for ATEX zone  |  |           |  | Part no. | Type       |
|--|--|-----------|--|----------|------------|
|  | Description  | For size  |  |          |            |
|  | <ul style="list-style-type: none"> <li>Protects "equipment that is not intrinsically safe" against simple disconnection, here the plug of the proximity switch SMT and connecting cable NEBU</li> <li>ATEX category: gas: II 3G / dust: II 3D</li> </ul> | Plug M8x1 |  | 548067   | NEAU-M8-GD |

| Ordering data – Connecting cables  |                               |                              |                  |          | Data sheets → Internet: nebu |
|--|-------------------------------|------------------------------|------------------|----------|------------------------------|
|  | Electrical connection, left   | Electrical connection, right | Cable length [m] | Part no. | Type                         |
|  | Straight socket, M8x1, 3-pin  | Cable, open end, 3-wire      | 2.5              | 541333   | NEBU-M8G3-K-2.5-LE3          |
|  |                               |                              | 5                | 541334   | NEBU-M8G3-K-5-LE3            |
|  | Straight socket, M12x1, 5-pin | Cable, open end, 3-wire      | 2.5              | 541363   | NEBU-M12G5-K-2.5-LE3         |
|  |                               |                              | 5                | 541364   | NEBU-M12G5-K-5-LE3           |
|  | Angled socket, M8x1, 3-pin    | Cable, open end, 3-wire      | 2.5              | 541338   | NEBU-M8W3-K-2.5-LE3          |
|  |                               |                              | 5                | 541341   | NEBU-M8W3-K-5-LE3            |
|  | Angled socket, M12x1, 5-pin   | Cable, open end, 3-wire      | 2.5              | 541367   | NEBU-M12W5-K-2.5-LE3         |
|  |                               |                              | 5                | 541370   | NEBU-M12W5-K-5-LE3           |

## Accessories

| Ordering data – Mounting kits for proximity switches SME/SMT-8                    |              |   |          |               |
|---|--------------|---|----------|---------------|
|   | For diameter | Materials   | Part no. | Type          |
|  | 32 ... 100   | Rail: anodised wrought aluminium alloy<br>Screws: high-alloy stainless steel<br>Free of copper and PTFE | 537806   | SMBZ-8-32/100 |
|  | 125          |   | 1451483  | DASP-M4-125-A |

| Ordering data – Mounting kit for proximity switches SME/SMT-8                     |              |   |                   |          | Data sheets → Internet: smbr |
|---|--------------|---|-------------------|----------|------------------------------|
|   | For diameter | Mounting                                    | CRC <sup>1)</sup> | Part no. | Type                         |
|  | 32 ... 100   | On the cylinder barrel using clamping strap | 4                 | 538937   | SMBR-8-8/100-S6              |

1) Corrosion resistance class CRC 4 to Festo standard FN 940070

Particularly high corrosion stress. Outdoor exposure under extreme corrosive conditions. Parts exposed to aggressive media, e.g. in the chemical or food industries. Such applications may need to be safeguarded by special tests (→ also FN 940082), using appropriate media.

## Position transmitter

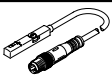
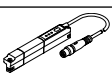

The position transmitter continuously senses the position of the piston.

It has an analogue output with an output signal in proportion to the piston position.

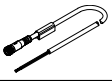
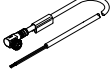
| Ordering data – Position transmitters for T-slot                                    |            |                          |                 |          |                                   |                           |                  | Data sheets → Internet: position transmitter |                              |
|---|------------|--------------------------|-----------------|----------|-----------------------------------|---------------------------|------------------|--|------------------------------|
|   | For diam.  | Position measuring range | Analogue output |          | Type of mounting                  | Electrical connection     | Cable length [m] | Part no.                                     | Type                         |
|   |            |                          | [V]             | [mA]     |                                   |                           |                  |  |                              |
|  | 32 ... 125 | 0 ... 40                 | 0 ... 10        | –        | Insertable in the slot from above | Plug M8x1, 4-pin, in-line | 0.3              | 553744                                       | SMAT-8M-U-E-0.3-M8D          |
|  | 32 ... 125 | 0 ... 50                 | –               | 4 ... 20 | Insertable in the slot from above | Plug M8x1, 4-pin, in-line | 0.3              | 1531265                                      | SDAT-MHS-M50-1L-SA-E-0.3-M8  |
|   |            | 0 ... 80                 |                 |          |                                   |                           |                  | 1531266                                      | SDAT-MHS-M80-1L-SA-E-0.3-M8  |
|   |            | 0 ... 100                |                 |          |                                   |                           |                  | 1531267                                      | SDAT-MHS-M100-1L-SA-E-0.3-M8 |
|   |            | 0 ... 125                |                 |          |                                   |                           |                  | 1531268                                      | SDAT-MHS-M125-1L-SA-E-0.3-M8 |
|   |            | 0 ... 160                |                 |          |                                   |                           |                  | 1531269                                      | SDAT-MHS-M160-1L-SA-E-0.3-M8 |
|   |            | 0 ... 50                 |                 |          |                                   |                           |                  | 8115394                                      | SDAT-MHS-M50-1L-SV-E-0.3-M8  |

| Ordering data – Connecting cables   |                              |                              |                  |          | Data sheets → Internet: nebu |
|---|------------------------------|------------------------------|------------------|----------|------------------------------|
|   | Electrical connection, left  | Electrical connection, right | Cable length [m] | Part no. | Type                         |
|  | Straight socket, M8x1, 4-pin | Cable, open end, 4-wire      | 2.5              | 541342   | NEBU-M8G4-K-2.5-LE4          |
|   |                              |                              | 5                | 541343   | NEBU-M8G4-K-5-LE4            |
|  | Angled socket, M8x1, 4-pin   | Cable, open end, 4-wire      | 2.5              | 541344   | NEBU-M8W4-K-2.5-LE4          |
|   |                              |                              | 5                | 541345   | NEBU-M8W4-K-5-LE4            |

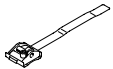
## Accessories

| Ordering data – Proximity switch in block design, pneumatic                      |                 |   |               | Data sheets → Internet: smpo |                         |
|--|-----------------|---|---------------|------------------------------|-------------------------|
|  | Mounting        | Pneumatic connection                        | Part no.      | Type                         |                         |
| <b>3/2-way valve, normally closed</b>  |                 |   |               |                              |                         |
|  | Via accessories | Barbed fitting for tubing I.D. 3 mm         | <b>31008</b>  | <b>SMPO-1-H-B</b>            |                         |
| Ordering data – Mounting kit for proximity switch SMPO-1                         |                 |   |               | Data sheets → Internet: smbs |                         |
|  | For diameter    | Mounting                                    | Part no.      | Type                         |                         |
|  | 32 ... 100 mm   | On the cylinder barrel using clamping strap | <b>151226</b> | <b>SMBS-2</b>                |                         |
| Ordering data – One-way flow control valves                                      |                 |   |               | Data sheets → Internet: grla |                         |
|  |                 | Connection                                  | Material      | Part no.                     | Type                    |
|  |                 | Thread                                      |               |                              |                         |
| <b>For exhaust air</b>   |                 |   |               |                              |                         |
|  | G1/8            | 4   | Metal design  | <b>193143</b>                | <b>GRLA-1/8-QS-4-D</b>  |
|  |                 | 6   |               | <b>193144</b>                | <b>GRLA-1/8-QS-6-D</b>  |
|  |                 | 8   |               | <b>193145</b>                | <b>GRLA-1/8-QS-8-D</b>  |
|  | G1/4            | 6   |               | <b>193146</b>                | <b>GRLA-1/4-QS-6-D</b>  |
|  |                 | 8   |               | <b>193147</b>                | <b>GRLA-1/4-QS-8-D</b>  |
|  |                 | 10  |               | <b>193148</b>                | <b>GRLA-1/4QS-10-D</b>  |
|  | G3/8            | 6   |               | <b>193149</b>                | <b>GRLA-3/8-QS-6-D</b>  |
|  |                 | 8   |               | <b>193150</b>                | <b>GRLA-3/8-QS-8-D</b>  |
|  |                 | 10  |               | <b>193151</b>                | <b>GRLA-3/8-QS-10-D</b> |
|  | G1/2            | 12  |               | <b>193152</b>                | <b>GRLA-1/2-QS-12-D</b> |