

Parallel gripper DHPL

FESTO



Key features

At a glance

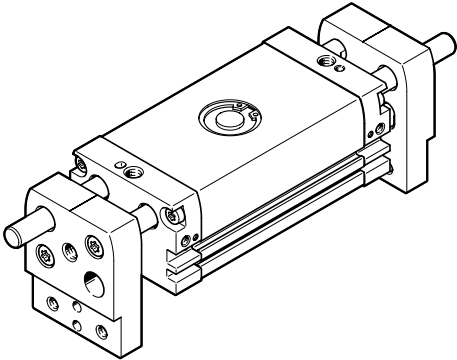

- Compact and sturdy design
- Ideal for gripping larger parts
- The grippers can absorb a high torque due to the guided gripper jaws.
- Double-acting piston drive
- Variable gripping direction: internal or external gripping
- Proximity switches can be mounted via T-slot or C-slot

Cushioning

The drive is fitted with pneumatic end-position cushioning, which can be adapted by the operator for maximum performance according to the moving mass and speed.

Position sensing

The position sensing function uses proximity switches to sense any required positions.

Note

Engineering software
Gripper selection
→ www.festo.com

Key features

Supply ports

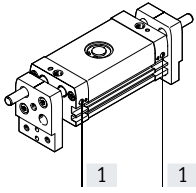

- [1] Compressed air supply ports

Mounting options

External gripper fingers

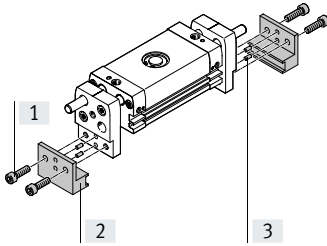

- [1] Screws
- [2] Gripper finger (produced in-house by the customer)
- [3] Centring pin

From above

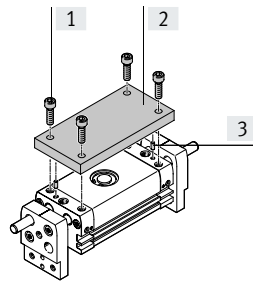
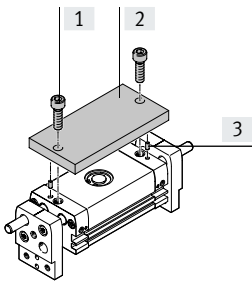

From underneath

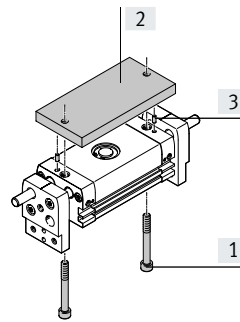

- [1] Screws
- [2] Mounting plate (produced in-house by the customer)
- [3] Centring pin

From the rear

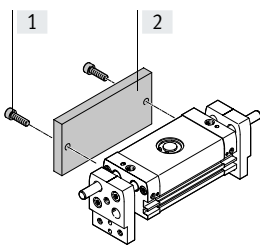

- [1] Screws
- [2] Mounting plate (produced in-house by the customer)

Note

These grippers are not suitable for the following or similar applications:

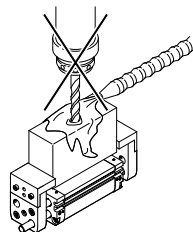

- Machining
- Aggressive media

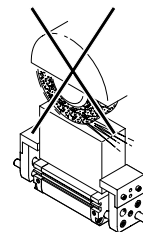

- Grinding dust

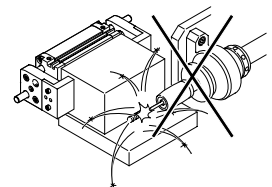

- Welding spatter

Peripherals overview

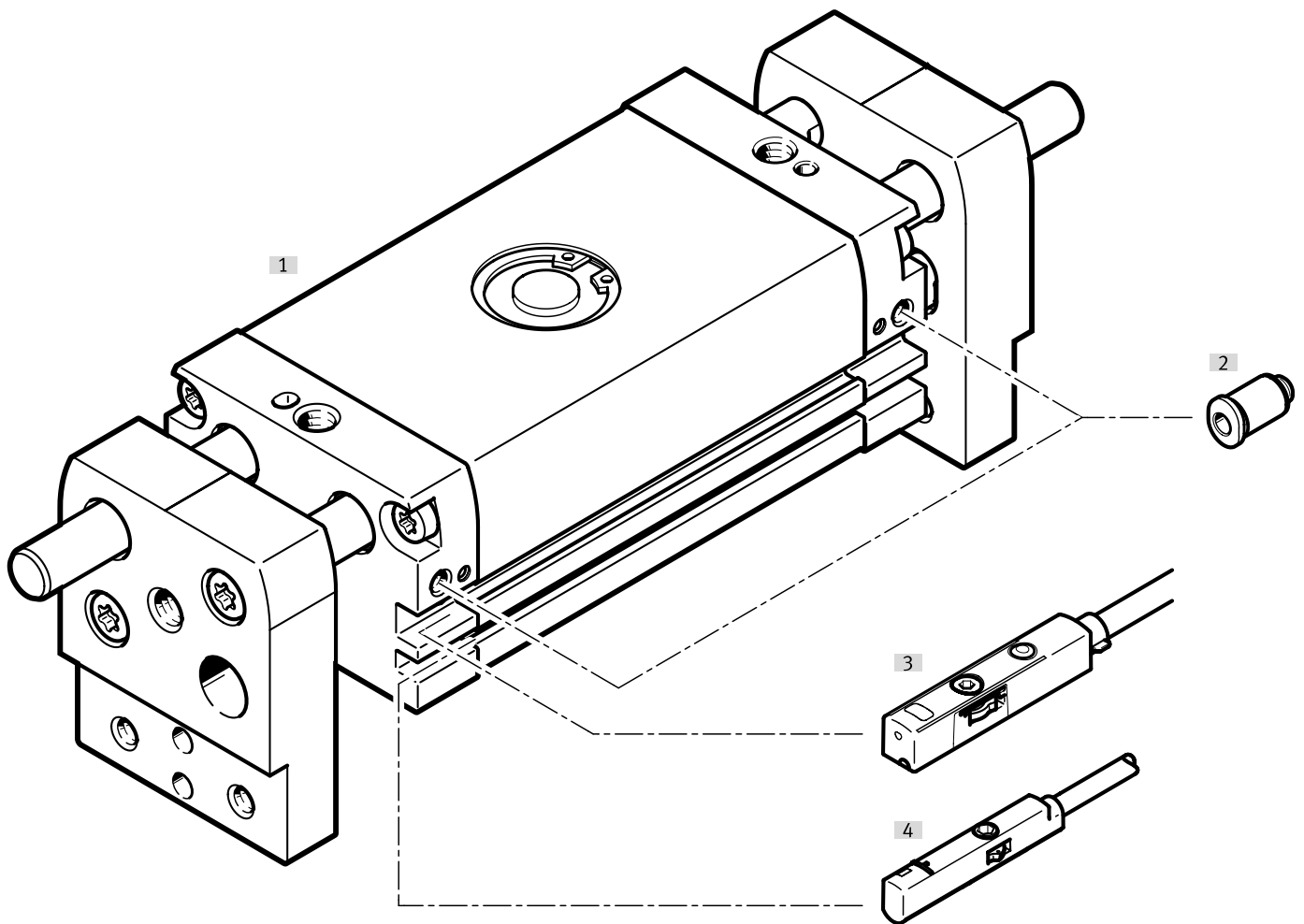

Accessories			
Type/order code	Description		→ Page/Internet
[1] Parallel gripper DHPL	Basic drive, double-acting		5
[2] Push-in fitting QS	For connecting tubing with standard O.D.		qs
[3] Proximity switch SMT-8/SDBT-MSB/SDBT-MSX	<ul style="list-style-type: none"> • For T-slot • For position sensing 		18
Position transmitters SDAS/SDAT	<ul style="list-style-type: none"> • For T-slot • For detecting the current position 		19
[4] Proximity switch SMT-10/SDBC-MSB	<ul style="list-style-type: none"> • For C-slot • For position sensing 		18

Type codes

001	Series
DHPL	Parallel gripper

002	Size
10	10
16	16
20	20
25	25
32	32
40	40

003	Complete stroke [mm]
20	20
30	30
40	40
50	50
60	60
70	70
80	80
100	100
120	120
160	160
200	200

004	Cushioning
P	Elastic cushioning rings/plates on both sides

005	Position sensing
A	For proximity sensor

Data sheet

Function
Double-acting



www.festo.com

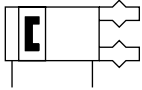

- - Size
10 ... 40 mm

- - Total stroke
20 ... 200 mm



General technical data

Size	10		16		20		25		32		40	
Total stroke	20 mm	60 mm	30 mm	80 mm	40 mm	100 mm	50 mm	120 mm	70 mm	160 mm	100 mm	200 mm
Stroke per gripper jaw	10 mm	30 mm	15 mm	40 mm	20 mm	50 mm	25 mm	60 mm	35 mm	80 mm	50 mm	100 mm
Design	Gear rack/pinion											
Mode of operation	Double-acting											
Guide	Plain-bearing guide											
Gripper function	Parallel											
Cushioning	Elastic cushioning rings/pads at both ends											
Number of gripper jaws	2											
Max. load per external gripper finger ¹⁾	54 g		93 g		170 g		305 g		498 g		801 g	
Pneumatic connection	M5								G1/8			
Gripper repetition accuracy ²⁾	0.03 mm											
Rotational symmetry	0.2 mm											
Max. interchangeability	0.2 mm											
Max. operating frequency of gripper	2 Hz	1.5 Hz	2 Hz	1.5 Hz	2 Hz	1.5 Hz	2 Hz	1.5 Hz	1 Hz	0.6 Hz	1 Hz	0.6 Hz
Position sensing	Via proximity switch											
Type of mounting	Optionally with through-hole	Optionally: direct fastening via thread, with through-hole										
Mounting position	Any											

¹⁾ Applies to unthrottled operation

²⁾ Under constant exposure to operating conditions, end-position drift occurs in the direction of movement of the gripper jaws, at 100 consecutive strokes

Operating and environmental conditions

Size	10	16	20	25	32	40
Operating pressure ¹⁾	0.25 ... 0.8 MPa		0.15 ... 0.8 MPa			
Operating pressure ²⁾	36 ... 116 psi		21.75 ... 116 psi			
Operating pressure ³⁾	2.5 ... 8 bar		1.5 ... 8 bar			
Operating medium	Compressed air to ISO 8573-1:2010 [7:4:4]					
Note on the operating/pilot medium	Lubricated operation possible (in which case lubricated operation will always be required)					
Ambient temperature ⁴⁾	-10 ... 60°C					
Maintenance interval	Lifetime lubrication					
Corrosion resistance class CRC ⁵⁾	1 - Low corrosion stress					

¹⁾ DHPL-10: After a longer period of downtime, the min. operating pressure of 0.25 MPa (2.5 bar, 36 psi) may increase to 0.4 MPa (4 bar, 58 psi).

²⁾ DHPL-10: After a longer period of downtime, the min. operating pressure of 0.25 MPa (2.5 bar, 36 psi) may increase to 0.4 MPa (4 bar, 58 psi).

³⁾ DHPL-10: After a longer period of downtime, the min. operating pressure of 0.25 MPa (2.5 bar, 36 psi) may increase to 0.4 MPa (4 bar, 58 psi).

⁴⁾ Note operating range of proximity switches

⁵⁾ Corrosion resistance class CRC 1 to Festo standard FN 940070

Low corrosion stress. Dry internal application or transport and storage protection. Also applies to parts behind covers, in the non-visible interior area, or parts which are covered in the application (e.g. drive trunnions).

Data sheet

Weight

Size	10		16		20		25		32		40	
Total stroke	20 mm	60 mm	30 mm	80 mm	40 mm	100 mm	50 mm	120 mm	70 mm	160 mm	100 mm	200 mm
Product weight	251 g	377 g	499 g	802 g	883 g	1407 g	1447 g	2297 g	2634 g	4154 g	4480 g	6480 g

Materials

Size	10	16	20	25	32	40
O-ring material	NBR					
Housing material	Anodised wrought aluminium alloy					
Cover material	Anodised wrought aluminium alloy					
Cover cap material	Anodised wrought aluminium alloy					
End plate material	Anodised wrought aluminium alloy					
Gripper jaw material	Anodised wrought aluminium alloy					
Piston rod material	High-alloy stainless steel					
Piston seal material	TPE-U(PU)					
Gear rack material	High-alloy stainless steel					
Material of screws	Galvanised steel					
Note on materials	RoHS-compliant					

Measured gripping force with a lever arm of 20 mm

Size	10		16		20		25		32		40	
Total stroke	20 mm	60 mm	30 mm	80 mm	40 mm	100 mm	50 mm	120 mm	70 mm	160 mm	100 mm	200 mm
Total gripping force at 0.6 MPa (6 bar, 87 psi), closing	38 N	44 N	130 N	142 N	230 N	238 N	360 N	380 N	570 N	600 N	924 N	992 N
Total gripping force at 0.6 MPa (6 bar, 87 psi), opening	60 N	68 N	180 N	190 N	310 N	316 N	470 N	490 N	760 N	800 N	1100 N	1180 N
Gripping force per gripper jaw at 0.6 MPa (6 bar, 87 psi) closing	19 N	22 N	65 N	71 N	115 N	119 N	180 N	190 N	285 N	300 N	462 N	496 N
Gripping force per gripper jaw at 0.6 MPa (6 bar, 87 psi) opening	30 N	34 N	90 N	95 N	155 N	158 N	235 N	245 N	380 N	400 N	550 N	590 N

Opening and closing times

Size	10		16		20		25		32		40	
Total stroke	20 mm	60 mm	30 mm	80 mm	40 mm	100 mm	50 mm	120 mm	70 mm	160 mm	100 mm	200 mm
Min. opening time at 0.6 MPa (6 bar, 87 psi) ¹⁾	41 ms	110 ms	53 ms	157 ms	71 ms	189 ms	81 ms	201 ms	112 ms	272 ms	220 ms	427 ms
Min. closing time at 0.6 MPa (6 bar, 87 psi) ²⁾	70 ms	174 ms	75 ms	221 ms	108 ms	274 ms	116 ms	274 ms	209 ms	473 ms	281 ms	524 ms

1) The indicated opening and closing times [ms] were measured at room temperature at an operating pressure of 6 bar with a horizontally mounted gripper without additional gripper fingers. The grippers must be throttled for larger loads [g]. Opening and closing times must then be adjusted accordingly.

2) The indicated opening and closing times [ms] were measured at room temperature at an operating pressure of 6 bar with a horizontally mounted gripper without additional gripper fingers. The grippers must be throttled for larger loads [g]. Opening and closing times must then be adjusted accordingly.

Data sheet

Characteristic load values at the gripper jaws

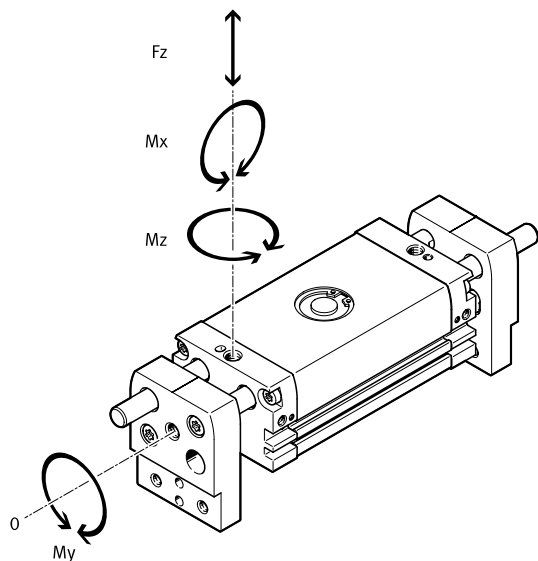

The indicated permissible forces and torques apply to a single gripper jaw. The indicated values include the lever arm, additional weight forces caused by the workpiece or external gripper fingers, as well as forces which occur during movement. The zero coordinate line (gripper jaw guide) must be taken into consideration when calculating torques.

Size	10	16	20	25	32	40
Maximum force on gripper jaw F_z , static	40 N	240 N	280 N	320 N	750 N	
Maximum torque on gripper jaw M_x , static	0.5 Nm	3.5 Nm	5 Nm	6.5 Nm	18 Nm	22 Nm
Maximum torque on gripper jaw M_y , static	0.5 Nm	3.5 Nm	5 Nm	6.5 Nm	18 Nm	22 Nm
Maximum torque on gripper jaw M_z , static	0.5 Nm	3.5 Nm	5 Nm	6.5 Nm	18 Nm	22 Nm

Gripper jaw backlash

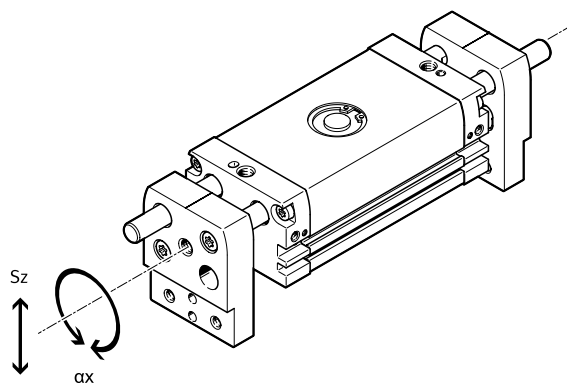

The plain-bearing guide used in the grippers means that there is backlash between the gripper jaws and the housing. The values listed in the table apply when new.

Size	10	16	20	25	32	40
Max. gripper jaw backlash S_z ¹⁾	0.064 mm	0.072 mm	0.068 mm	0.064 mm	0.066 mm	0.065 mm
Max. gripper jaw angular backlash a_x, a_y ²⁾	0.22 deg	0.15 deg	0.14 deg	0.13 deg	0.12 deg	0.1 deg

1) The values apply only when the gripper is open.

2) The values apply only when the gripper is open.

Data sheet

Mass moments of inertia

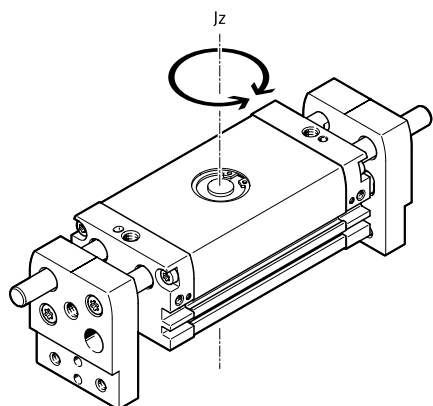

Mass moment of inertia of the parallel grippers in relation to the central axis, without external gripper fingers, without load.

Gripper closed; gripper open

Size	10	16	20	25	32	40
Total stroke	20 mm	30 mm	40 mm	50 mm	70 mm	100 mm
Mass moment of inertia	1.6 kgcm ² ; 2.2 kgcm ²	4.8 kgcm ² ; 9.6 kgcm ²	4.3 kgcm ² ; 6.6 kgcm ²	9.7 kgcm ² ; 12.6 kgcm ²	15.4 kgcm ² ; 23.5 kgcm ²	49.3 kgcm ² ; 104.5 kgcm ²
Size	60	80	120	160	200	250
Total stroke	60 mm	80 mm	120 mm	160 mm	200 mm	250 mm
Mass moment of inertia	50.4 kgcm ² ; 76.4 kgcm ²	118.1 kgcm ² ; 258.9 kgcm ²	101.8 kgcm ² ; 176.1 kgcm ²	315.8 kgcm ² ; 727 kgcm ²	249.5 kgcm ² ; 487.2 kgcm ²	786.9 kgcm ² ; 1625 kgcm ²

Data sheet

Gripping force F_h per gripper jaw as a function of the operating pressure and lever arm x

The gripping forces as a function of the operating pressure and lever arm can be determined from the following graphs.

- 3 bar
- · - · 6 bar
- - - 8 bar

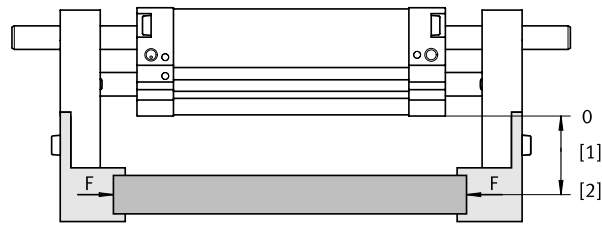

- [1] Lever arm x
- [2] Load point

External gripping (closing)

DHPL-10-20-...-A

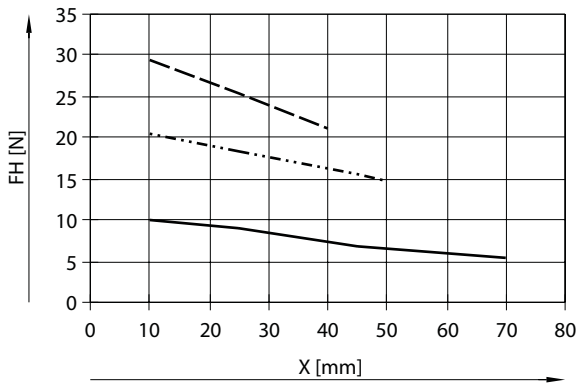

DHPL-10-60-...-A

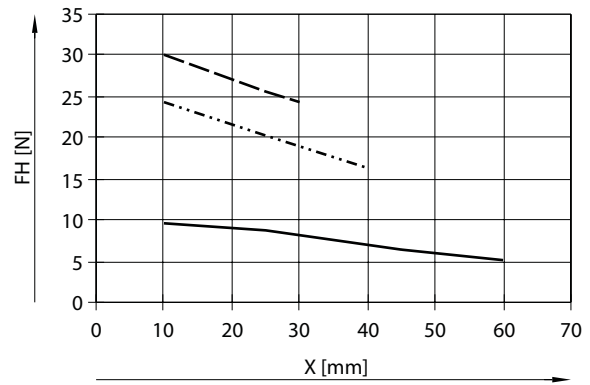

DHPL-16-30-...-A

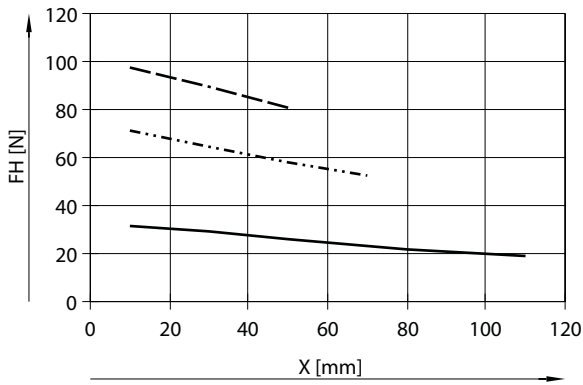

DHPL-16-80-...-A

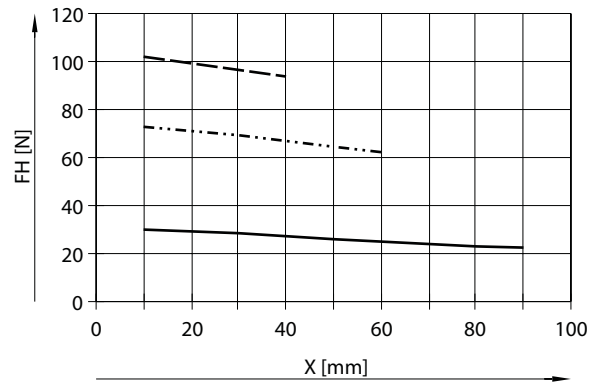

DHPL-20-40-...-A

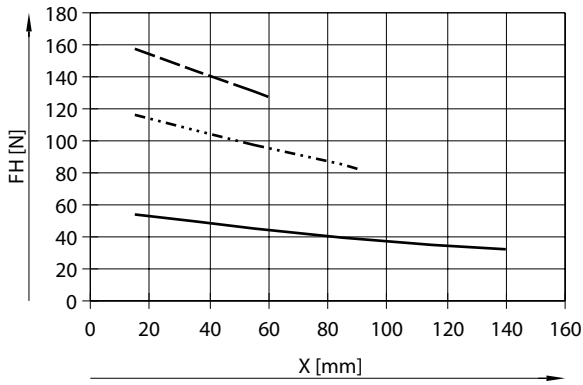

DHPL-20-100-...-A

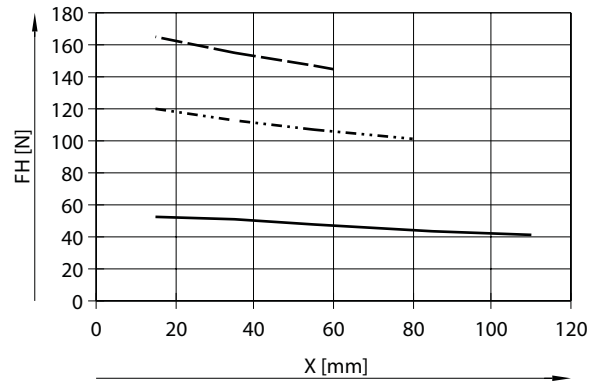

Data sheet

Gripping force F_h per gripper jaw as a function of the operating pressure and lever arm x

The gripping forces as a function of the operating pressure and lever arm can be determined from the following graphs.

- 3 bar
- · - · 6 bar
- - - 8 bar

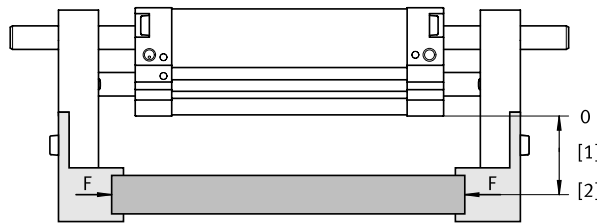

- [1] Lever arm x
- [2] Load point

External gripping (closing)

DHPL-25-50-...-A

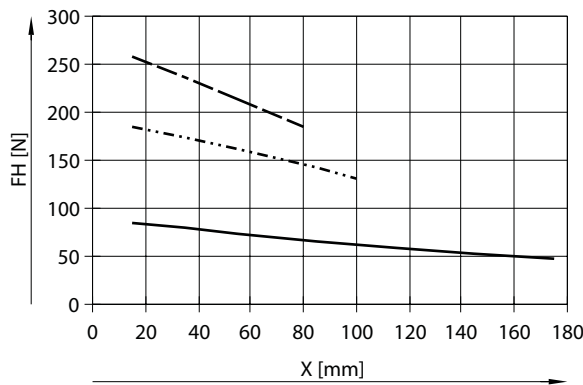

DHPL-25-120-...-A

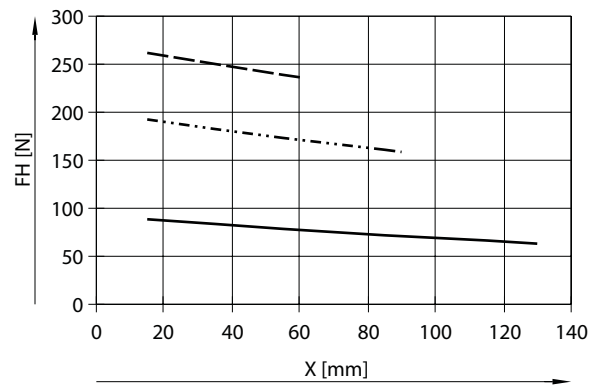

DHPL-32-70-...-A

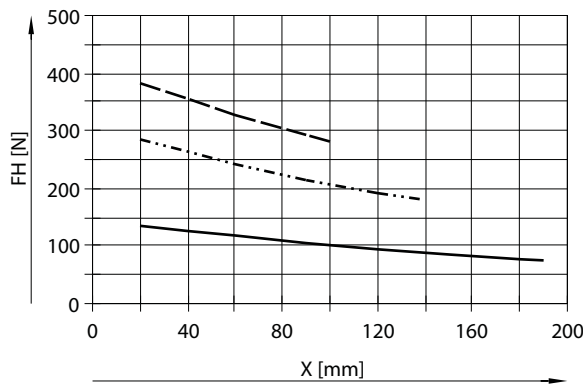

DHPL-32-160-...-A

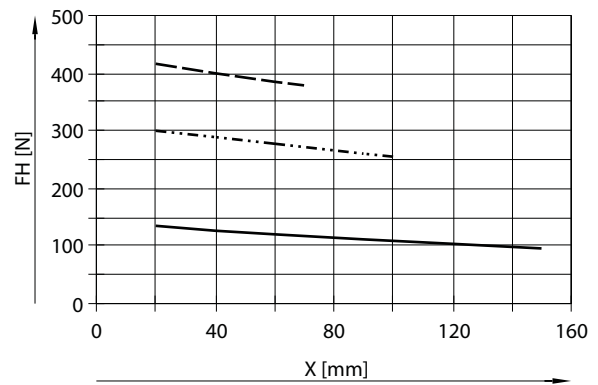

DHPL-40-100-...-A

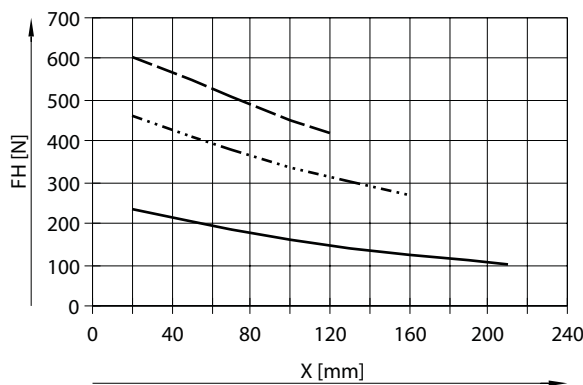

DHPL-40-200-...-A

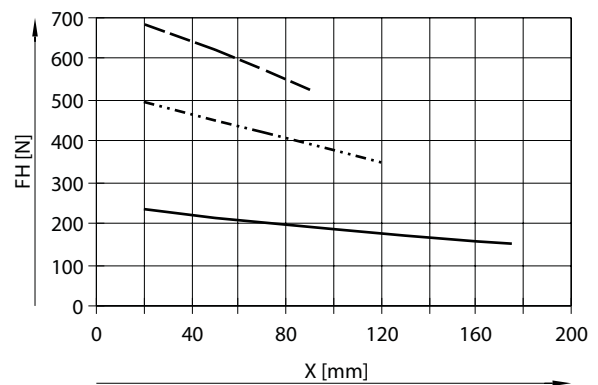

Data sheet

Gripping force F_h per gripper jaw as a function of the operating pressure and lever arm x

The gripping forces as a function of the operating pressure and lever arm can be determined from the following graphs.

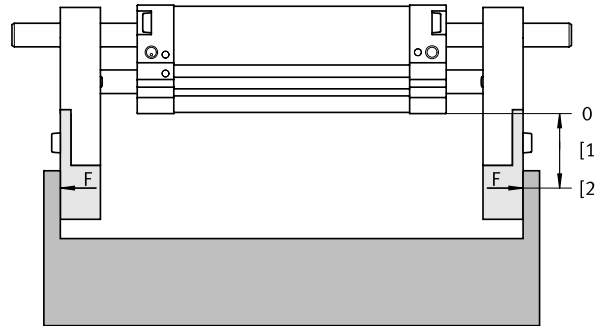

- 3 bar
- · - · 6 bar
- - - 8 bar

- [1] Lever arm x
- [2] Load point

Internal gripping (opening)

DHPL-10-20-...-A

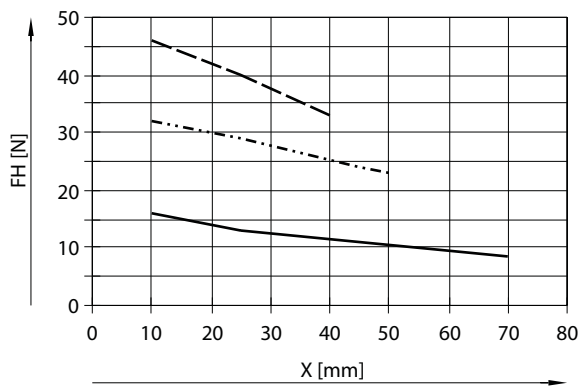

DHPL-10-60-...-A

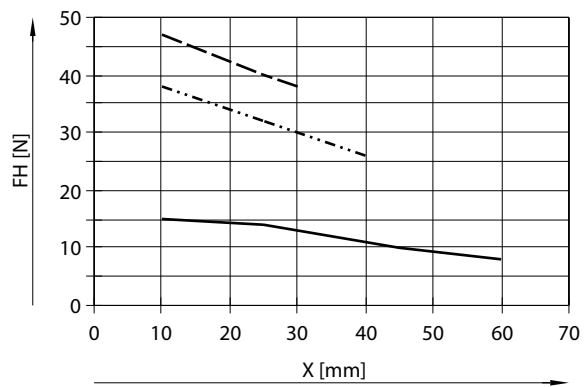

DHPL-16-30-...-A

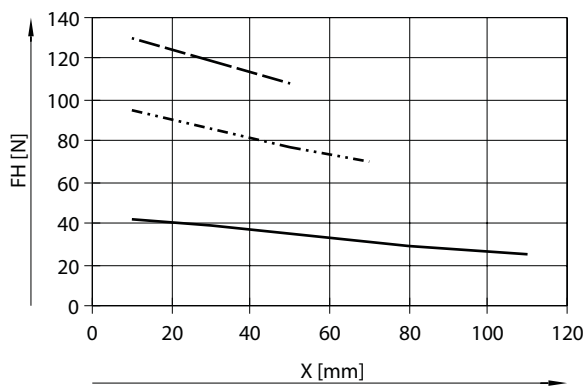

DHPL-16-80-...-A

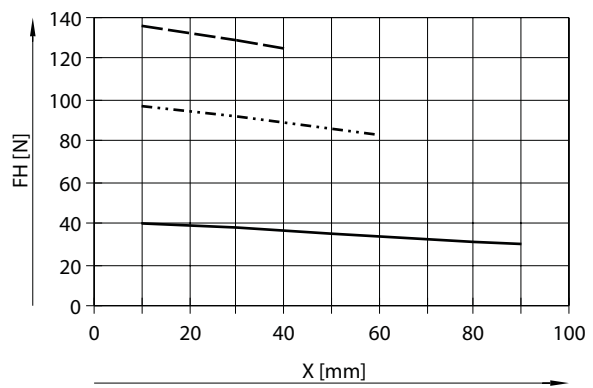

DHPL-20-40-...-A

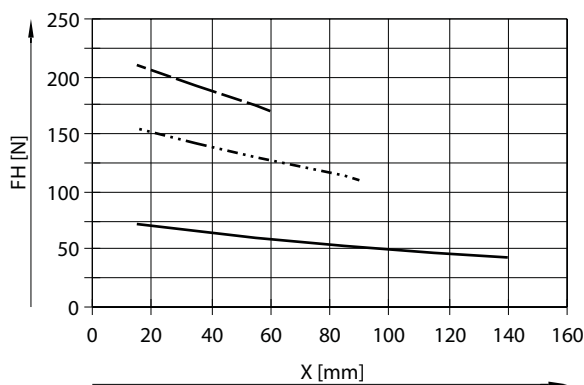

DHPL-20-100-...-A

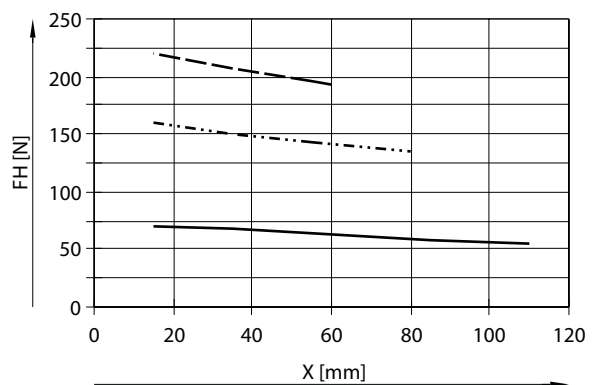

Data sheet

Gripping force F_h per gripper jaw as a function of the operating pressure and lever arm x

The gripping forces as a function of the operating pressure and lever arm can be determined from the following graphs.

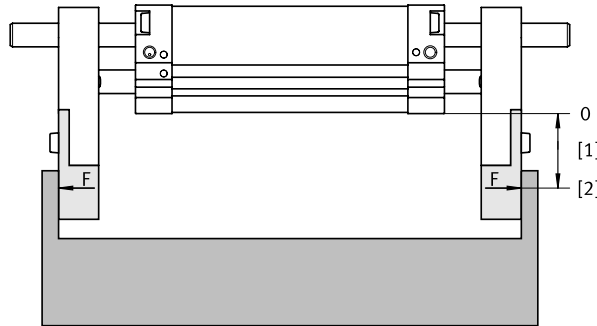

- 3 bar
- · - · 6 bar
- - - 8 bar

- [1] Lever arm x
- [2] Load point

Internal gripping (opening)

DHPL-25-50-...-A

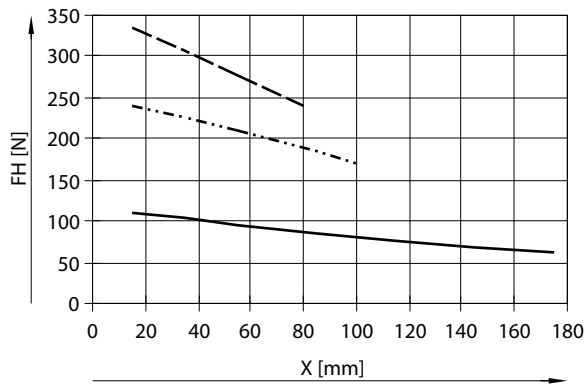

DHPL-25-120-...-A

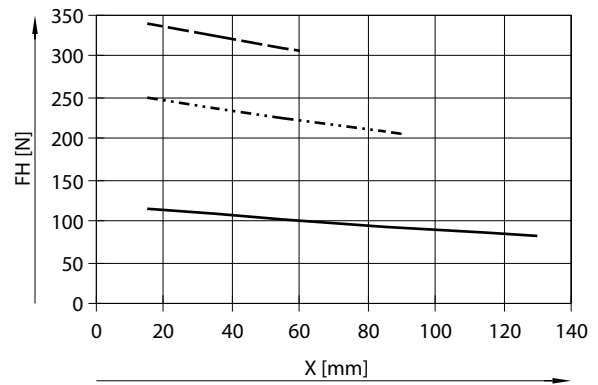

DHPL-32-70-...-A

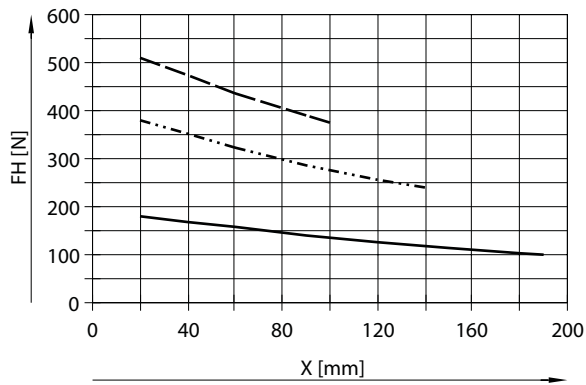

DHPL-32-160-...-A

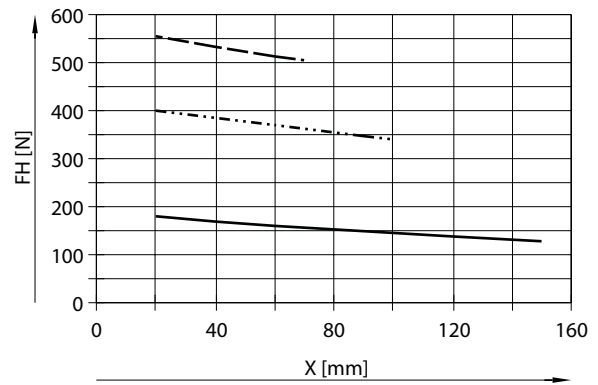

DHPL-40-100-...-A

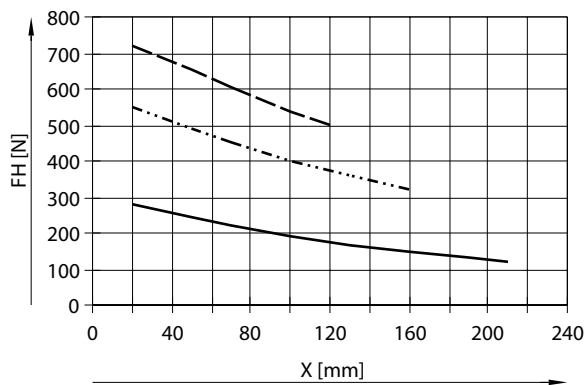

DHPL-40-200-...-A

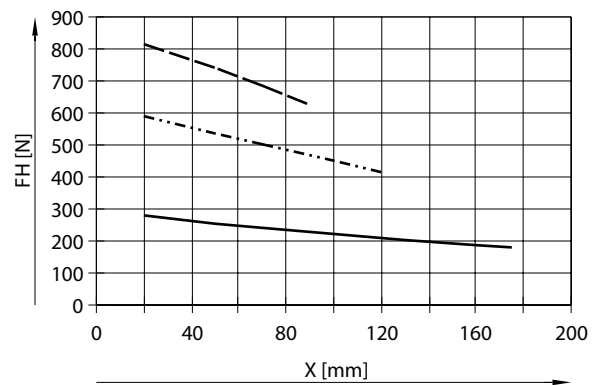

Data sheet

Gripping force F_h per gripper jaw at 6 bar as a function of lever arm x and eccentricity a and b

The following formula must be used to calculate the lever arm x with eccentric gripping:

$$X = \sqrt{a^2 + b^2}$$

The gripping force F_h can be read from the graphs (→ page 10) using the calculated value x .

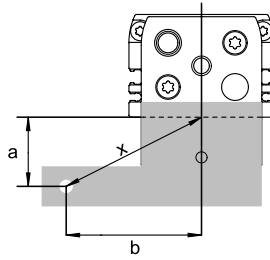

Calculation example

Assuming:

Distance $a = 40$ mm

Distance $b = 45$ mm

Required:

The gripping force at 6 bar with a DHPL-25-50-P-A, used as an external gripper

Procedure:

Calculating the lever arm x

$$x = \sqrt{40^2 + 45^2}$$

$x = 60$ mm

The graph (→ page 10) gives a value of $F_h = 160$ N for the gripping force.

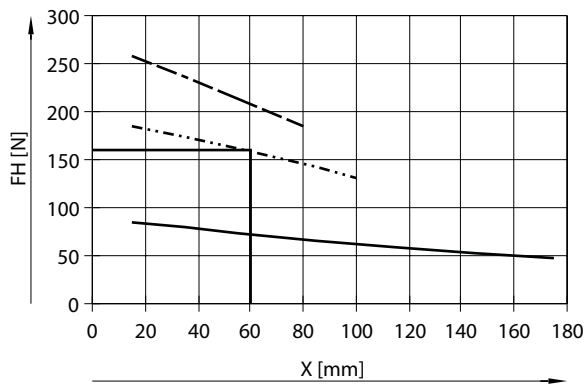

Data sheet

Dimensions

Download CAD data → www.festo.com

DHPL-10 ... 20

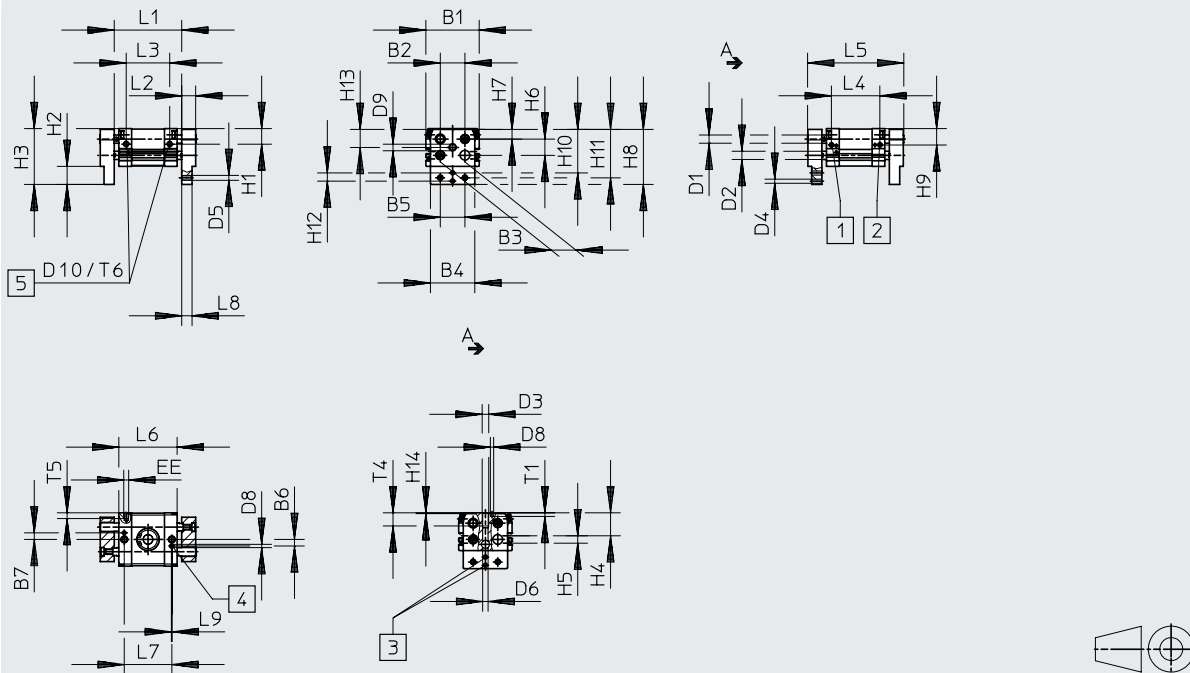

- [1] Compressed air supply port, opening
- [2] Compressed air supply port, closing
- [3] Centring holes
- [4] Centring hole, slot
- [5] Thread for mounting the gripper from the rear

Size	Stroke	B1	B2	B3	B4	B5	B6	B7	D1	D2	D3	D4	D5	D6	D8	D9
[mm]	[mm]	±0.2			±0.25	±0.15		±0.1	∅	∅		∅ H9		∅ H13	H9	
10	20	44	20	18	34	20	6	6	6	6	M6	3	M4	4.5	3	M4x0.5
	60															
16	30	55	22	23	43	25	9	9	8	8	M8	4	M5	5.5	4	M6x0.5
	80															
20	40	65	30	30	54	30	8	8	10	10	M8	5	M6	6.5	4	M8x1
	100															

Size	Stroke	D10	EE	H1	H2	H3	H4	H5	H6	H7	H8	H9	H10	H11	H12	H13
[mm]	[mm]			±0.35	±0.25	±0.7						±0.35	±0.15	±0.15	±0.05	±0.15
10	20	M4	M5	11.5	15.5	46.5	18	8	12.5	9	46	10	34.5	38.5	8	15
	60															
16	30	M5	M5	16	19.5	58.5	24	8	17.5	10	58	16.5	44.5	49.5	10	20
	80															
20	40	M6	M5	19	22	68	28	9	19.8	11.7	67	20	53	59	10	22
	100															

Size	Stroke	H14	L1		L2	L3	L4	L5	L6	L7	L8	L9	T1	T4	T5	T6
			Gripper closed ±0.7	Gripper open ±0.7												
[mm]	[mm]				±0.1	±0.25	±0.25	±1	±0.25	±0.25	±0.05		±0.2			
10	20	0.5	56	76	10	42.2	33	77	51	42	7	1	4	12	3.5	5
	60															
16	30	0.5	68	98	13	47	45	96	60	48	9	1	3	16	6	7
	80															
20	40	1	82	122	17	53	59	117	71	58	12.5	1	4.5	16	7	7
	100															

Data sheet

Dimensions

Download CAD data → www.festo.com

DHPL-25 ... 40

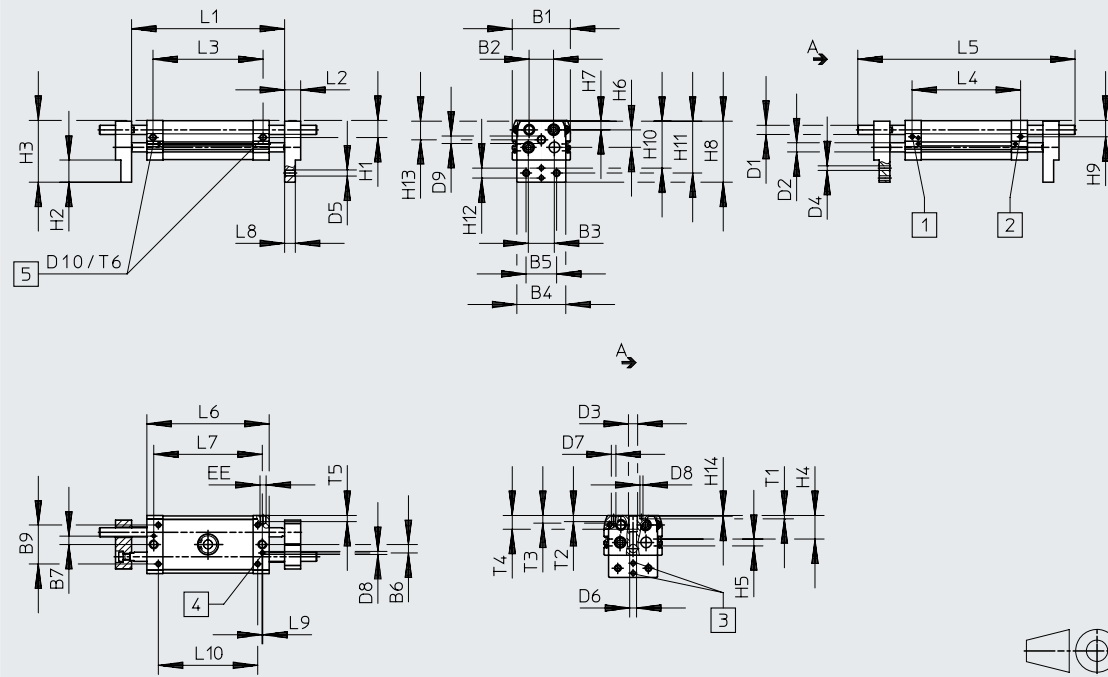

- [1] Compressed air supply port, opening
- [2] Compressed air supply port, closing
- [3] Centring holes
- [4] Centring hole, slot
- [5] Thread for mounting the gripper from the rear

Size	Stroke	B1	B2	B3	B4	B5	B6	B7	B9	D1 ∅	D2 ∅	D3	D4 ∅ H9	D5	D6 ∅ H13	D7	D8	D9	
[mm]	[mm]	±0.2			±0.25	±0.15		±0.1	±0.1										
25	50	76	32	34	64	40	11	11	51	12	12	M12	6	M8	9	M6	4	M10x1	
	120																		
32	70	82	37	70	50	12	12	60	16	16	-	10	M10	10	M8	6	M12x1		
	160																		
40	100	98	44	45	86	60	76	-	10	M12	11	M10	6	M14x1					
	200																		

Size	Stroke	D10	EE	H1	H2	H3	H4	H5	H6	H7	H8	H9	H10	H11	H12	H13	H14	L2
[mm]	[mm]			±0.35	±0.25	±0.7						±0.35	±0.15	±0.15	±0.05	±0.15		±0.1
25	50	M8	M5	22.5	29	81	30.9	9	22.9	11.5	80	21.5	61.5	68	13	24.4	1	21
	120																	
32	70	G1/8	25	32	100	34.5	24	31	14.5	99	24.5	76.5	84	15	30	24		
	160																	
40	100	M10	30.5	38	117	41.5	26	37	16.5	116	30.5	87	98	20	34	28		
	200																	

Size	Stroke	L1		L3	L4	L5	L6	L7	L8	L9	L10	T1	T2	T3	T4	T5	T6
		Gripper closed ±0.7	Gripper open ±0.7														
[mm]	[mm]			±0.25	±0.25	±1	±0.25	±0.25	±0.05		±0.15	±0.2					
25	50	100	150	72	70	142	88	70	14	1	58	4.5	8	10	18	6	8
	120																
32	70	150	220	88	86	186	110	86	15	86	6	16	18	24	10	11	
	160																176
40	100	188	288	118	118	254	148	116	18	116	8	20	23	79	10	15	
	200																214

Data sheet

Ordering data			
Size [mm]	Stroke [mm]	Parallel gripper	
		Part no.	Type
10	20	8112216	DHPL-10-20-P-A
	60	8112215	DHPL-10-60-P-A
16	30	8112217	DHPL-16-30-P-A
	80	8112218	DHPL-16-80-P-A
20	40	8112220	DHPL-20-40-P-A
	100	8112219	DHPL-20-100-P-A
25	50	8112222	DHPL-25-50-P-A
	120	8112221	DHPL-25-120-P-A
32	70	8112223	DHPL-32-70-P-A
	160	8112224	DHPL-32-160-P-A
40	100	8112225	DHPL-40-100-P-A
	200	8112226	DHPL-40-200-P-A

Accessories

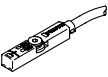
Ordering data – Proximity switch for T-slot, magneto-resistive							Data sheets → Internet: smt
	Type of mounting	Switching output	Electrical connection	Cable length [m]	Part no.	Type	
N/O							
	Inserted in the slot from above, flush with the cylinder profile, short design	PNP	Cable, 3-wire	2.5	574335	SMT-8M-A-PS-24V-E-2,5-OE	
			Cable, 2-wire	5	8165237	SMT-8M-A-ZS-24V-E-5,0-OE	
			Plug M8x1, 3-pin	0.3	574334	SMT-8M-A-PS-24V-E-0,3-M8D	
		NPN	Cable, 3-wire	2.5	574338	SMT-8M-A-NS-24V-E-2,5-OE	
			Plug M8x1, 3-pin	0.3	574339	SMT-8M-A-NS-24V-E-0,3-M8D	

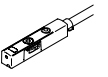

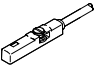
Ordering data – Proximity switch for T-slot, magnetic Hall							Data sheets → Internet: sdbt
	Type of mounting	Switching output	Electrical connection	Cable length [m]	Part no.	Type	
N/O or N/C contact, switchable							
	Inserted in the slot from above, flush with the cylinder profile, short design	PNP, switchable to NPN	Plug M8x1, 3-pin	0.3	8059120	SDBT-MSX-1L-PU-E-0.3-N-M8	
			Cable, 3-wire	2.5	8059121	SDBT-MSX-1L-PU-E-2.5-N-LE	
		NPN, switchable to NPN	Plug M8x1, 3-pin	0.3	8059123	SDBT-MSX-1L-NU-E-0.3-N-M8	
			Cable, 3-wire	2.5	8059124	SDBT-MSX-1L-NU-E-2.5-N-LE	

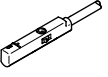
Ordering data – Proximity switch for T-slot, magneto-resistive							Data sheets → Internet: sdbt
	Type of mounting	Switching output	Electrical connection	Cable length [m]	Part no.	Type	
N/O or N/C contact, switchable							
	Inserted in the slot from above, flush with the cylinder profile, short design	PNP	Plug M8x1, 3-pin	0.3	8150174	SDBT-MSB-1L-PU-K-0.3-M8	
			Cable, 3-wire	2	8150171	SDBT-MSB-1L-PU-K-2-LE	
		NPN	Plug M8x1, 3-pin	0.3	8150175	SDBT-MSB-1L-NU-K-0.3-M8	
			Cable, 3-wire	2	8150172	SDBT-MSB-1L-NU-K-2-LE	
		Non-contacting, 2-wire	Cable, 2-wire	2	8150173	SDBT-MSB-1L-ZU-K-2-LE	

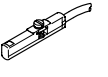
Ordering data – Proximity switch for C-slot, magneto-resistive							Data sheets → Internet: smt
	Type of mounting	Switching output	Electrical connection, outlet direction of connection	Cable length [m]	Part no.	Type	
N/O							
	Inserted in the slot from above	PNP	Cable, 3-wire, in-line	2.5	551373	SMT-10M-PS-24V-E-2.5-L-OE	
			Plug M8x1, 3-pin, in-line	0.3	551375	SMT-10M-PS-24V-E-0.3-L-M8D	
		NPN	Cable, 3-wire, in-line	2.5	551377	SMT-10M-NS-24V-E-2.5-L-OE	
			Plug M8x1, 3-pin, in-line	0.3	551379	SMT-10M-NS-24V-E-0.3-L-M8D	
		Non-contacting, 2-wire	Cable, 2-wire, in-line	2.5	551382	SMT-10M-ZS-24V-E-2.5-L-OE	

Bestellangaben – Näherungsschalter für Rundnut, magneto-resistiv							Data sheets → Internet: sdbc
	Type of mounting	Switching output	Electrical connection, outlet direction of connection	Cable length [m]	Part no.	Type	
N/O							
	Inserted in the slot from above	PNP	Cable, 3-wire, in-line	2	8139723	SDBC-MSB-1L-PU-K-2-LE	
			Plug M8x1, 3-pin, in-line	0.3	8139726	SDBC-MSB-1L-PU-K-0.3-M8	
		NPN	Cable, 3-wire, in-line	2	8139724	SDBC-MSB-1L-NU-K-2-LE	
			Plug M8x1, 3-pin, in-line	0.3	8139727	SDBC-MSB-1L-NU-K-0.3-M8	
		Non-contacting, 2-wire	Cable, 2-wire, in-line	2	8139725	SDBC-MSB-1L-ZU-K-2-LE	

Accessories



Ordering data – Connecting cables						Data sheets → Internet: nebu
	Electrical connection, left	Electrical connection, right	Cable length [m]	Part no.	Type	
	Straight socket, M8x1, 3-pin	Cable, open end, 3-wire	2.5	541333	NEBU-M8G3-K-2.5-LE3	
			5	541334	NEBU-M8G3-K-5-LE3	
	Angled socket, M8x1, 3-pin	Cable, open end, 3-wire	2.5	541338	NEBU-M8W3-K-2.5-LE3	
			5	541341	NEBU-M8W3-K-5-LE3	

Position transmitters

The position transmitter continuously senses the position of the piston. It has an analogue output with an output signal relative to the piston position.

Ordering data – Position transmitters for T-slot								Data sheets → Internet: sdas
	Position measuring range	Description	Type of mounting	Electrical connection	Cable length [m]	Part no.	Type	
	≤ 52	Choice of two operating modes: • Two adjustable switching outputs • IO-Link	Inserted in the slot from above	Plug M8x1, 4-pin, in-line	0.3	8063974	SDAS-MHS-M40-1L-PNLK-PN-E-0.3-M8	

Ordering data – Position transmitters for T-slot								Data sheets → Internet: sdat
	Position measuring range	Analogue output [V] [mA]		Type of mounting	Electrical connection	Cable length [m]	Part no.	Type
	0 ... 50	–	4 ... 20	Inserted in the slot from above	Plug M8x1, 4-pin, in-line	0.3	1531265	SDAT-MHS-M50-1L-SA-E-0.3-M8
	0 ... 80						1531266	SDAT-MHS-M80-1L-SA-E-0.3-M8
	0 ... 100						1531267	SDAT-MHS-M100-1L-SA-E-0.3-M8
	0 ... 125						1531268	SDAT-MHS-M125-1L-SA-E-0.3-M8
	0 ... 160						1531269	SDAT-MHS-M160-1L-SA-E-0.3-M8

Ordering data – Connecting cables						Data sheets → Internet: nebu
	Electrical connection, left	Electrical connection, right	Cable length [m]	Part no.	Type	
	Straight socket, M8x1, 4-pin	Cable, open end, 4-wire	2.5	541342	NEBU-M8G4-K-2.5-LE4	
			5	541343	NEBU-M8G4-K-5-LE4	
	Angled socket, M8x1, 4-pin	Cable, open end, 4-wire	2.5	541344	NEBU-M8W4-K-2.5-LE4	
			5	541345	NEBU-M8W4-K-5-LE4	