

Twin-piston drives DGTZ

FESTO



Key features

At a glance

Drive and guide unit in a single housing

- Minimal space requirement
- Minimal mounting time
- Drive available with one or two end plates
- Wide range of mounting options
- Perfect for use in the electronics industry: materials free of copper

Sturdy and precise

- Good protection against torsion
- High rigidity
- Maintenance-free

High resistance to torques and transverse loads

- Plain-bearing guide: high rigidity thanks to large-diameter guide rods and two plain-bearing bushes

Large stroke range

- Standard strokes of up to 100 mm
- Variable strokes of up to 200 mm

Mounting options

Flat from above

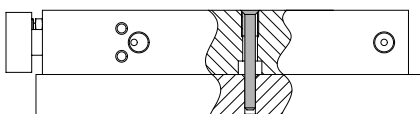

Flat from underneath

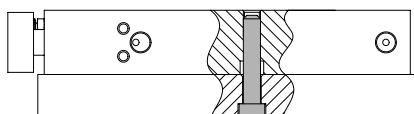

Flat from the side

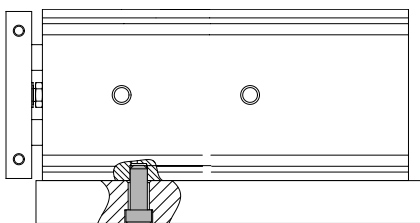

Note

Make sure that the drives are mounted correctly

Additional information is available at www.festo.com/sp → User documentation

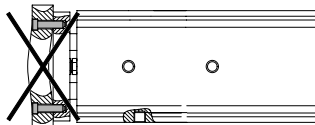

- Distortion-free

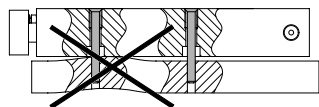

- On even surfaces

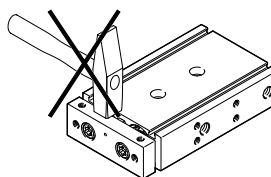

- Protect the end plate, the piston rods and the housing

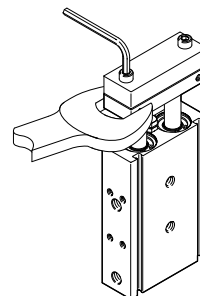

Peripherals overview

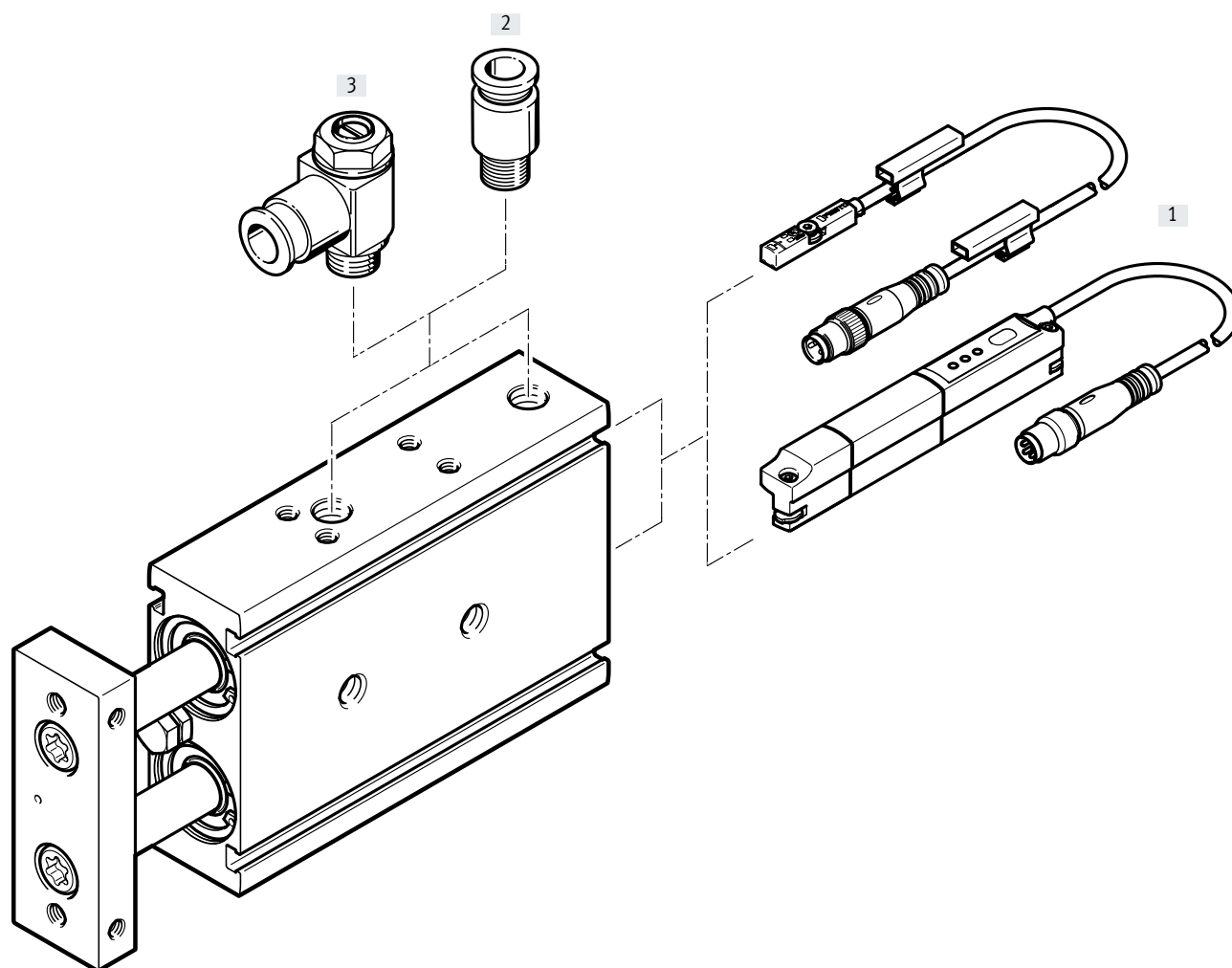

Accessories		Description	Piston Ø			→ Page/Internet
Type/order code			6	10, 16, 20	25, 32	
[1]	Proximity switch SDBC-MSB	For position sensing	■	■	–	26
	Proximity switch SMT-10		■	■	–	26
	Proximity switch SME/SMT-8		–	–	■	28
	Position transmitters SMAT/SDAT	For detecting the current position	–	–	■	28
[2]	Push-in fitting QS	For connecting compressed air tubing with standard O.D.	■	■	■	qs
[3]	One-way flow control valve GRLA	For regulating speed	■	■	■	28

Type codes

001	Series
DGTZ	Twin cylinder

002	Guide
GF	Plain bearing

003	Piston diameter
6	6
10	10
16	16
20	20
25	25
32	32

004	Stroke
10	10
20	20
30	30
40	40
50	50
60	60
70	70
80	80
90	90
100	100

005	Stroke
...	51 ... 200

006	Piston rod design
	One end plate
J	Two end plates

007	Piston rod type
	At one end
T	Through piston rod

008	Cushioning
P	Elastic cushioning rings/plates on both sides



009	Position sensing
A	For proximity sensor

Datasheet

Function

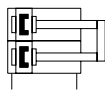
DGTZ-GF-...-P-A





-  - Diameter
6 ... 32 mm
-  - Stroke length
10 ... 200 mm

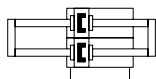

Function

DGTZ-GF-...-J-T-P-A



-  - Diameter
6 ... 32 mm
-  - Stroke length
10 ... 200 mm

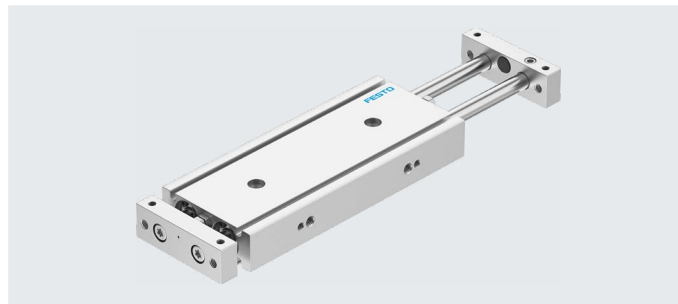

General technical data		6	10	16	20	25	32
Piston \varnothing		6	10	16	20	25	32
Design		Guide					
Mode of operation		Double-acting					
Guide		Plain-bearing guide					
Pneumatic connection		M5				G1/8	
Stroke	[mm]	10 ... 60	10 ... 150	10 ... 200			
Adjustable end-position range/length	[mm]	10					
Cushioning		Elastic cushioning rings/pads at both ends					
Position sensing		Via proximity switch					
Mounting position		Any					

Operating and environmental conditions		6	10	16	20	25	32
Piston \varnothing		6	10	16	20	25	32
Operating medium		Compressed air to ISO 8573-1:2010 [7:4:4]					
Note on the operating/pilot medium		Lubricated operation possible (in which case lubricated operation will always be required)					
Operating pressure							
One end plate	[MPa]	0.2 ... 0.8	0.15 ... 0.8	0.1 ... 0.8			
	[psi]	29 ... 116	21.75 ... 116	14.5 ... 116			
	[bar]	2 ... 8	1.5 ... 8	1 ... 8			
Two end plates and through piston rod	[MPa]	0.2 ... 0.8		0.12 ... 0.8			
	[psi]	29 ... 116		17.4 ... 116			
	[bar]	2 ... 8		1.2 ... 8			
Ambient temperature	[°C]	-10 ... +80					
Operating mode of the drive unit		Yoke					
		Two yokes					
Corrosion resistance class CRC ¹⁾		1					

1) Corrosion resistance class CRC 1 to Festo standard FN 940070

Low corrosion stress. Dry internal application or transport and storage protection. Also applies to parts behind covers, in the non-visible interior area, and parts which are covered in the application (e.g. drive trunnions).

Datasheet

Speeds [m/s]						
Stroke [mm]	Piston ø					
	6	10	16	20	25	32
One end plate						
Advancing $v_{min}/v_{max}^{1)}$						
50	0.06/1	-				
150	-	0.04/1	-			
200	-	0.04/1		0.02/1	0.02/0.7	
Retracting $v_{min}/v_{max}^{1)}$						
50	0.07/1	-				
150	-	0.05/1	-			
200	-	0.03/1		0.02/1	0.02/0.8	0.02/0.6
Two end plates and through piston rod						
Advancing and retracting $v_{min}/v_{max}^{1)}$						
50	0.06/0.5	-				
150	-	0.04/0.5	-			
200	-	0.03/0.5			0.02/0.5	0.01/0.5

1) To avoid damage to the cylinder, the speed must be throttled. This also applies during operation without additional load.
The maximum speed must not be exceeded.

Forces [N] and impact energy [J]						
Piston ø	Piston ø					
	6	10	16	20	25	32
One end plate						
Theoretical force at 0.6 MPa (6 bar, 87 psi), advancing						
	34	94	242	376	590	966
Theoretical force at 0.6 MPa (6 bar, 87 psi), retracting						
	18.6	60	181	283	454	724
Two end plates and through piston rod						
Theoretical force at 0.6 MPa (6 bar, 87 psi), advancing and retracting						
	18.6	60	181	283	454	724
Max. impact energy at the end positions						
	0.01	0.08	0.15	0.2	0.3	0.4

Permissible impact velocity:

$$v = \sqrt{\frac{2 \cdot E}{m_1 + m_2}}$$

Maximum permissible mass:

$$m_2 = \frac{2 \cdot E}{v^2} - m_1$$

v Permissible impact velocity
E Max. impact energy
m₁ Moving mass (drive)
m₂ Moving payload

 **Note**
These specifications represent the maximum values that can be achieved. The maximum permissible impact energy must be observed.

Datasheet

Weights [g] ¹⁾						
Piston ø	6	10	16	20	25	32
One end plate						
Basic weight at 0 mm stroke	65.5	115	236	374	563	966
Additional weight per 10 mm stroke	16.5	20	27	37	53	83.5
Moving mass with 0 mm stroke	15	35.5	80	138.5	209	421
Additional moving mass per 10 mm stroke	2	4.5	8	12.5	18	31.5
Two end plates and through piston rod						
Basic weight at 0 mm stroke	112	201	370	595	882	1628
Additional weight per 10 mm stroke	17	24.5	35	50	71	114
Moving mass with 0 mm stroke	25.5	64	133	228	319	655.5
Additional moving mass per 10 mm stroke	4	9	16	25	35.6	62

1) The weights were determined mathematically and may deviate by ±15%.

Materials

Sectional view

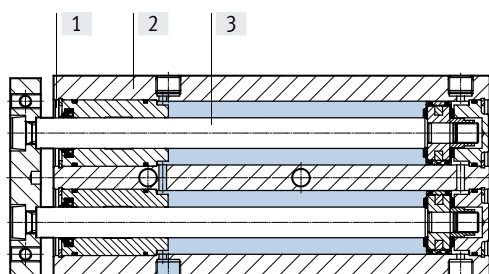

Linear drives	
[1] Cover	Wrought aluminium alloy
[2] Housing	Anodised wrought aluminium alloy
[3] Piston rod	High-alloy stainless steel
– Seals	NBR
	HNBR
	TPE-U
Note on materials	RoHS-compliant
	Copper-free
	Free of paint-wetting impairment substances
	Contains paint-wetting impairment substances
PWIS conformity	VDMA24364 zone III

Datasheet

Maximum payload F [N]

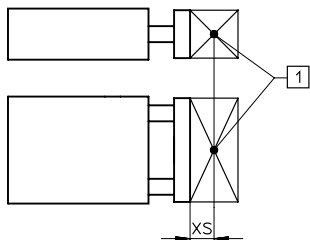

[1] Centre of gravity of payload

Piston \varnothing	6	10	16	20	25	32
XS [mm]	5	5	20	20	20	20

Stroke [mm]	Piston \varnothing					
	6	10	16	20	25	32
One end plate						
10	1.6	6.3	9.5	16.5	22.4	33.9
20	1.2	5.1	8.1	14.2	19.3	29.3
30	0.9	4.3	7	12.4	16.8	25.6
40	0.8	3.6	6.1	10.9	14.7	22.5
50	0.6	3.1	5.4	9.7	13	19.9
60	0.5	2.7	4.7	8.6	11.5	17.6
70	-	2.3	4.2	7.7	10.3	15.6
80	-	2	3.7	6.8	9.1	13.8
90	-	-	3.3	6.1	8.1	12.2
100	-	-	2.9	5.5	7.2	10.8
Two end plates and through piston rod						
10	2.1	7.2	13.6	22.5	33.5	39.4
20	1.8	6.8	13.1	21.6	32.1	38
30	1.7	6.4	12.6	20.9	31	36.8
40	1.5	6	12.3	20.3	30.2	35.9
50	1.3	5.5	12.1	19.9	29.6	35.1
80	-	-	11.5	18.9	28.2	33.5
100	-	-	11.3	18.5	27.5	32.7

Maximum payload F [N] as a function of stroke l [mm]

One end plate

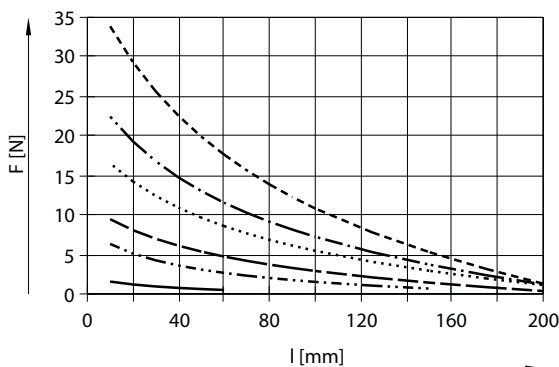

- \varnothing 6
- · - · - \varnothing 10
- - - \varnothing 16
- · · · · \varnothing 20
- · - · - \varnothing 25
- - - \varnothing 32

Two end plates and through piston rod

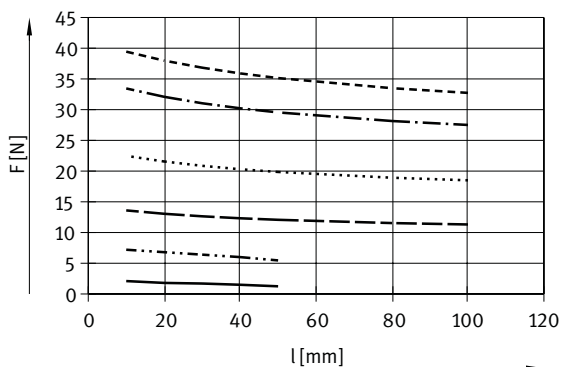

- \varnothing 6
- · - · - \varnothing 10
- - - \varnothing 16
- · · · · \varnothing 20
- · - · - \varnothing 25
- - - \varnothing 32

Datasheet

Permissible torque load M [Nm]

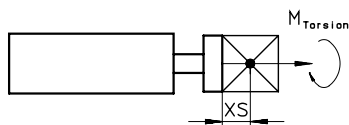

Piston \varnothing	6	10	16	20	25	32
XS [mm]	5	5	20	20	20	20

Stroke [mm]	Piston \varnothing					
	6	10	16	20	25	32

One end plate						
10	0.0125	0.0633	0.1182	0.2396	0.3929	0.7621
20	0.0096	0.0511	0.1009	0.2064	0.3378	0.6602
30	0.0759	0.0425	0.0873	0.1798	0.2939	0.5768
40	0.0061	0.0360	0.0763	0.1582	0.2579	0.5072
50	0.0050	0.0308	0.0670	0.1399	0.2279	0.4479
60	-	0.0267	0.0592	0.1245	0.2020	0.3968
70	-	0.0231	0.0523	0.1111	0.1796	0.3517
80	-	0.0202	0.0464	0.0991	0.1598	0.3116
90	-	-	0.0411	0.0887	0.1424	0.2756
100	-	-	0.0363	0.0791	0.1266	0.2432

Two end plates and through piston rod						
10	0.0168	0.0720	0.1700	0.3260	0.5854	0.8874
20	0.0144	0.0680	0.1631	0.3126	0.5616	0.8546
30	0.0136	0.0640	0.1580	0.3025	0.5432	0.8287
40	0.0120	0.0600	0.1540	0.2944	0.5289	0.8078
50	0.0100	0.0546	0.1509	0.2880	0.5171	0.7907
80	-	-	0.1443	0.2743	0.4926	0.7535
100	-	-	0.1414	0.2683	0.4814	0.7364

Permissible torque load M [Nm] as a function of stroke l [mm]

One end plate

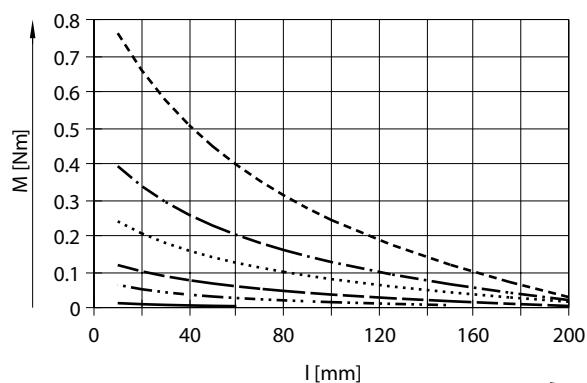

- $\varnothing 6$
- · - · - $\varnothing 10$
- - - $\varnothing 16$
- · · · · $\varnothing 20$
- · - · - $\varnothing 25$
- - - $\varnothing 32$

Two end plates and through piston rod

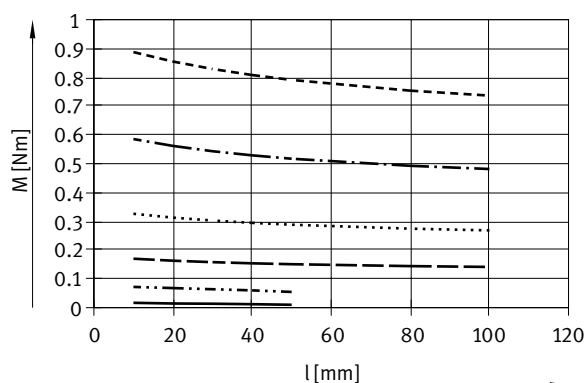

- $\varnothing 6$
- · - · - $\varnothing 10$
- - - $\varnothing 16$
- · · · · $\varnothing 20$
- · - · - $\varnothing 25$
- - - $\varnothing 32$

Note

Design tool → www.festo.com/engineeringtools

Datasheet

Torsional backlash ρ

Plain-bearing guide GF in retracted state, without load

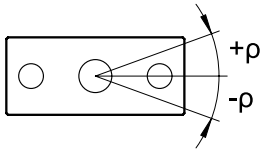

Piston \varnothing	6	10	16	20	25	32
Torsional backlash [°]	±0.1					

Deflection of end plate

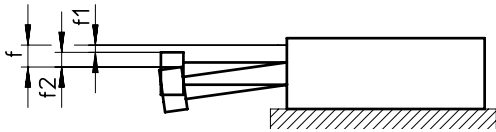

$$f = f_1 + f_2$$

f = total deflection of the end plate

f_1 = deflection due to average bearing clearance (GF)

bearing clearance GF with production tolerance ±0.01 mm

f_2 = deflection due to lateral force

Datasheet

Deflection f_1 due to bearing clearance as a function of stroke l (with no load)

One end plate

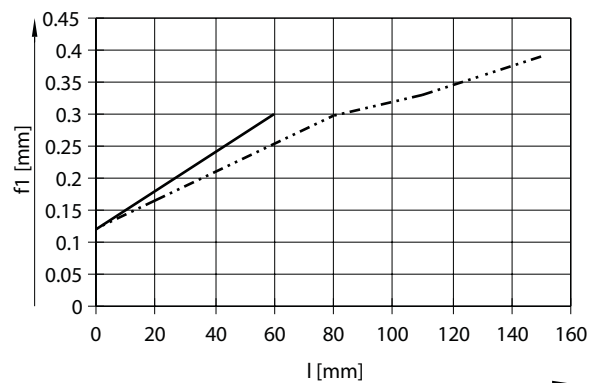

— $\varnothing 6$
- · - · - $\varnothing 10$

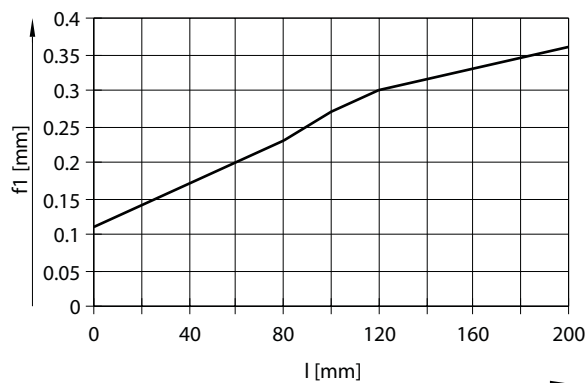

— $\varnothing 16 \dots 32$

Two end plates and through piston rod

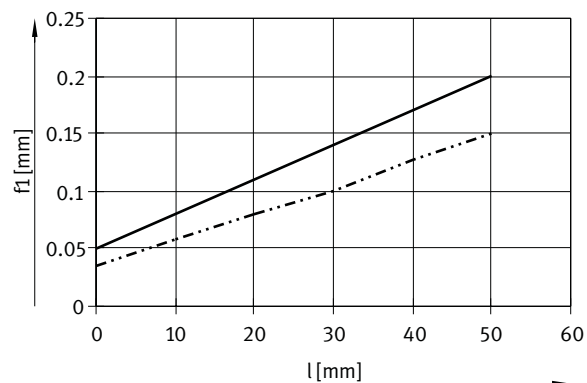

— $\varnothing 6$
- · - · - $\varnothing 10$

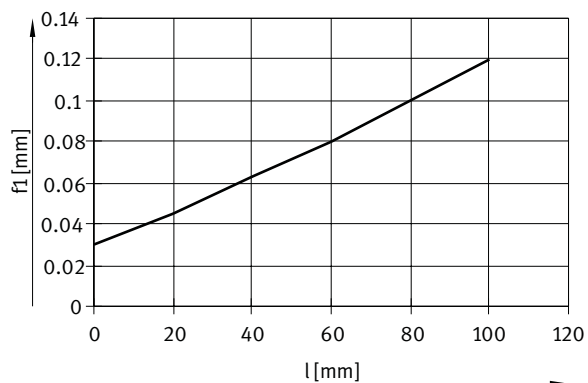

— $\varnothing 16 \dots 32$

Datasheet

Dimensions – One end plate

Download CAD data → www.festo.com

∅ 6

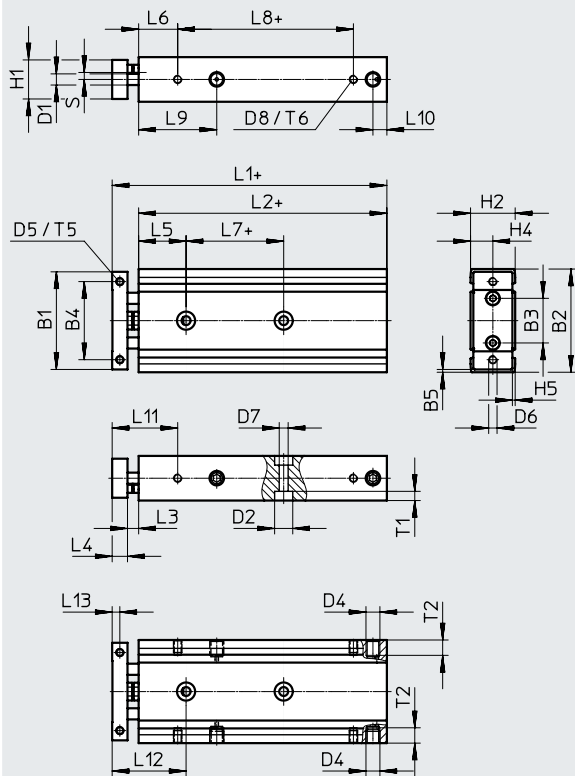

+ = plus stroke length

Datasheet

∅	Stroke	B1	B2	B3	B4	B5	D1 ∅	D2 ∅	D4	D5	D6	D7 ∅
[mm]	[mm]											
6	10 ... 60	35	37	16	28	1	4	6.5	M5	M3	M3	3.2

∅	Stroke	D8	H1	H2	H4	H5	L1	L2	L3	L4	L5	L6
[mm]	[mm]											
6	10 ... 50	M3	14	16	8	1	48.5 ¹⁾	39 ¹⁾	4	5.5	17	14
	108.5						99					

1) Plus stroke length

∅	Stroke	L9	L10	L11	L12	L13	S	T1	T2	T5	T6
[mm]	[mm]										
6	10 ... 60	28	5	23.5	26.5	2.8	2.5	3.3	5.5	6	4.5

Piston ∅ 6		
Stroke [mm]	L7	L8
10	15	23
20	20	33
30	25	43
40	30	53
50	35	63
51 ... 60	35	63

Datasheet

Dimensions – Two end plates and through piston rod

Download CAD data → www.festo.com

∅ 6

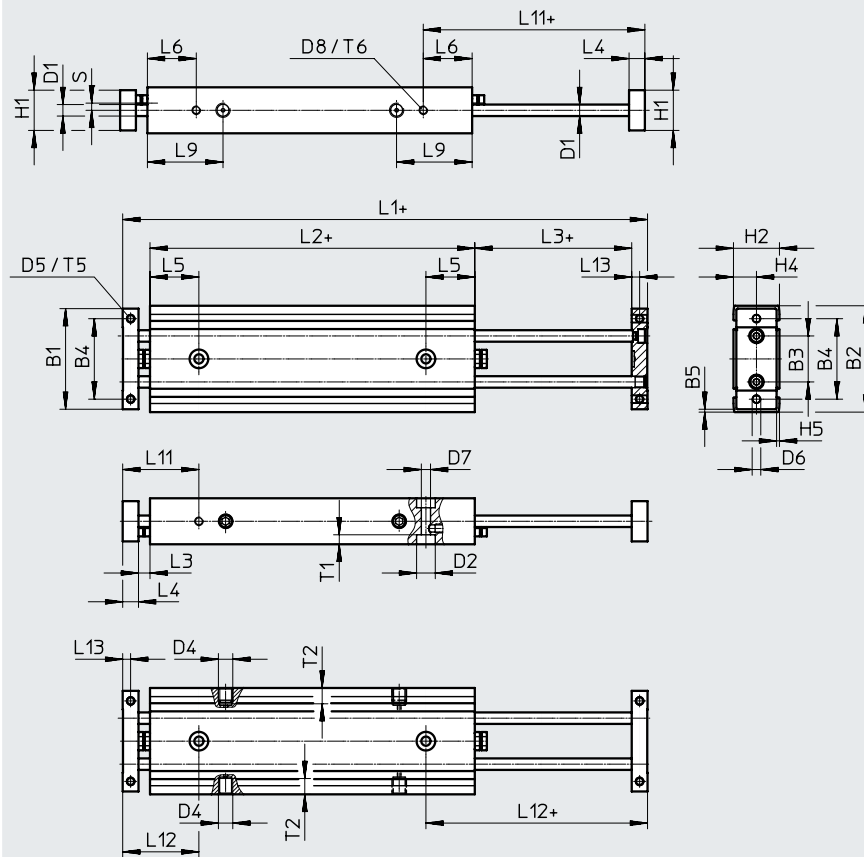

+ = plus stroke length

Datasheet

∅	Stroke	B1	B2	B3	B4	B5	D1 ∅	D2 ∅	D4	D5	D6	D7 ∅	D8	H1	H2	H4	H5
[mm]	[mm]																
6	10 ... 60	35	37	16	28	1	4	6.5	M5	M3	M3	3.2	M3	14	16	8	1

∅	Stroke	L1	L2	L3	L4	L5	L6	L9	L11	L12	L13	S	T1	T2	T5	T6
[mm]	[mm]															
6	10	103	73	4	5.5	17	17	27	26.5	26.5	2.75	2.5	3.3	5.5	6	4.5
	20	123	83													
	30	143	93													
	40	163	103													
	50	183	113													
	51 ... 60	143 ¹⁾	123													

1) Plus stroke length

Datasheet

Dimensions – One end plate

Download CAD data → www.festo.com

∅ 10 ... 16

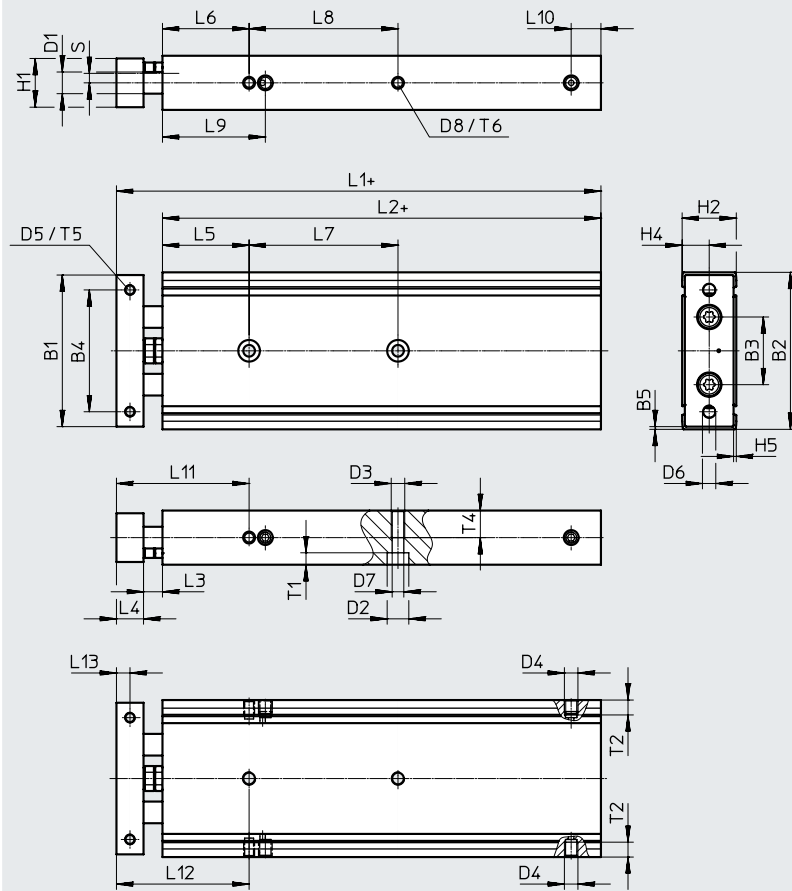

+ = plus stroke length

Datasheet

∅	Stroke	B1	B2	B3	B4	B5	D1 ∅	D2 ∅	D3	D4	D5	D6	D7 ∅
[mm]	[mm]												
10	10 ... 150	44	46	20	35	1	6	6.5	M4	M5	M3	M4	3.4
16	10 ... 200	56	58	25	45	1	8	8	M5	M5	M4	M5	4.3

∅	Stroke	D8	H1	H2	H4	H5	L1	L2	L3	L4	L5	L6	L9
[mm]	[mm]												
10	10 ... 80	M3	15	17	8.5	1	60 ¹⁾	46 ¹⁾	6	8	23	23	34
	81 ... 100						164	150					
	101 ... 125						189	175					
	126 ... 150						214	200					
16	10 ... 100	M4	18	20	10	1	79 ¹⁾	62 ¹⁾	7	10	32	32	38
	101 ... 125						204	187					
	126 ... 150						229	212					
	151 ... 175						254	237					
	176 ... 200						279	262					

1) Plus stroke length

∅	Stroke	L10	L11	L12	L13	S	T1	T2	T4	T5	T6
[mm]	[mm]										
10	10 ... 80	5	37	37	4	2.5	3.3	5.5	7	6	4.5
	81 ... 150	9									
16	10 ... 200	11	49	49	5	3.5	4.4	5.5	9	7	5.5

Piston ∅ 10			Piston ∅ 16		
Stroke [mm]	L7	L8	Stroke [mm]	L7	L8
10	20		10	20	
20	30		20	25	
30	40		30	35	
40	40		40	35	
50	40		50	35	
60	50		60	45	
70	50		70	45	
80	50		80	45	
81 ... 100	60		90	55	
101 ... 125	70		100	55	
126 ... 150	80		101 ... 125	65	
			126 ... 150	75	
			151 ... 175	85	
			176 ... 200	85	

Datasheet

Dimensions – Two end plates and through piston rod

Download CAD data → www.festo.com

∅ 10 ... 16

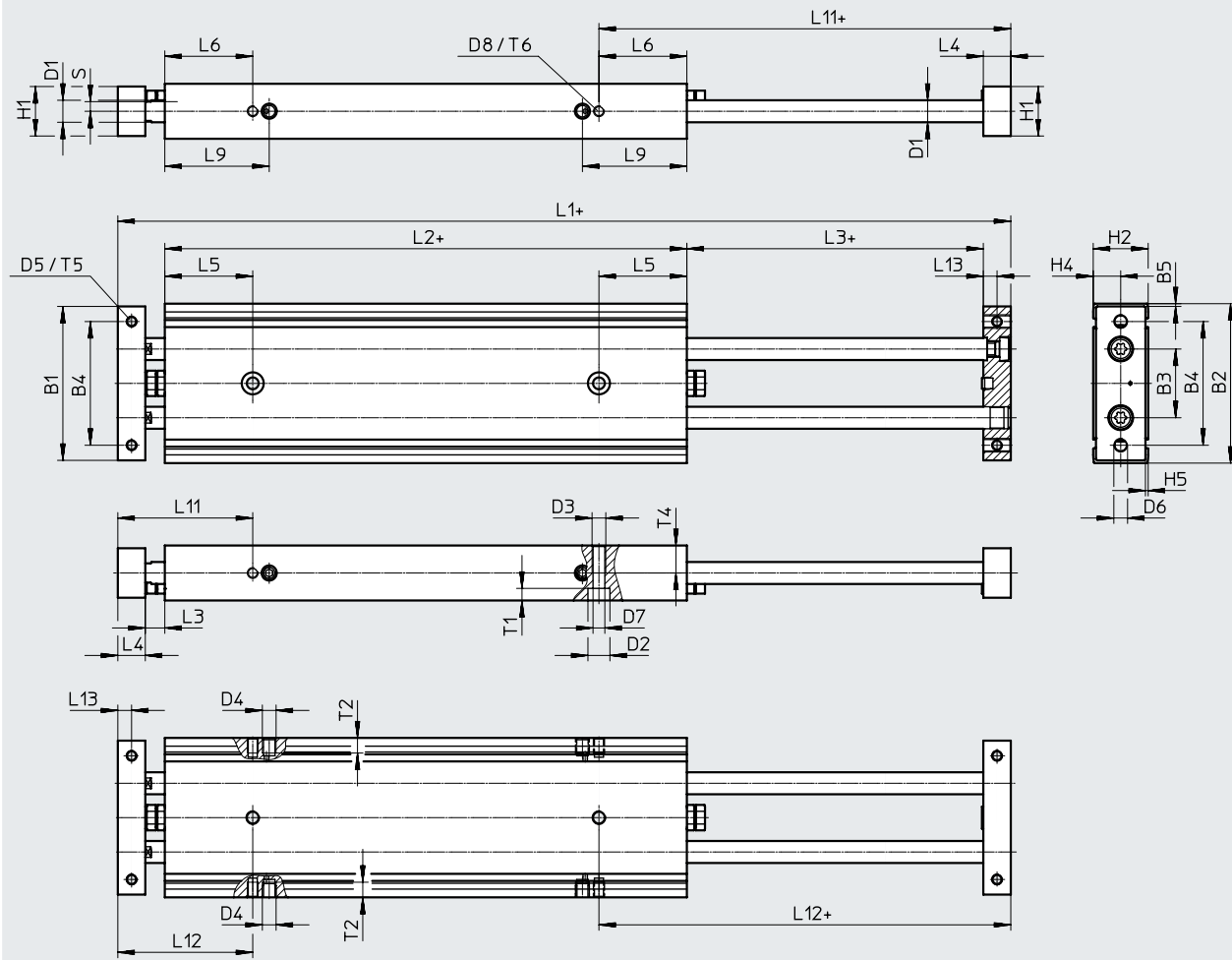

+ = plus stroke length

Datasheet

∅	Stroke	B1	B2	B3	B4	B5	D1 ∅	D2 ∅	D3	D4	D5	D6	D7 ∅	D8	H1	H2	H4	H5
[mm]	[mm]																	
10	10 ... 150	44	46	20	35	1	6	6.5	M4	M5	M3	M4	3.4	M3	15	17	8.5	1
16	10 ... 200	56	58	25	45	1	8	8	M5	M5	M4	M5	4.3	M4	18	20	10	1

∅	Stroke	L1	L2	L3	L4	L5	L6	L9	L11	L12	L13	S	T1	T2	T4	T5	T6
[mm]	[mm]																
10	10	125	86	6	8	23	23	34	37	37	4	2.5	3.3	5.5	7	6	4.5
	20	145	96														
	30	165	106														
	40	185	116														
	50	205	126														
	51 ... 75	180 ¹⁾	151														
	76 ... 100	205 ¹⁾	176														
	101 ... 125	230 ¹⁾	201														
126 ... 150	255 ¹⁾	226															
16	10	145	100	7	10	32	32	38	49	49	5	3.5	4.4	5.5	9	7	5.5
	20	165	110														
	30	185	120														
	40	205	130														
	50	225	140														
	80	285	170														
	100	325	190														
	101 ... 125	250 ¹⁾	215														
	126 ... 150	275 ¹⁾	240														
	151 ... 175	300 ¹⁾	265														
176 ... 200	325 ¹⁾	290															

1) Plus stroke length

Datasheet

Dimensions – One end plate

Download CAD data → www.festo.com

∅ 20 ... 32

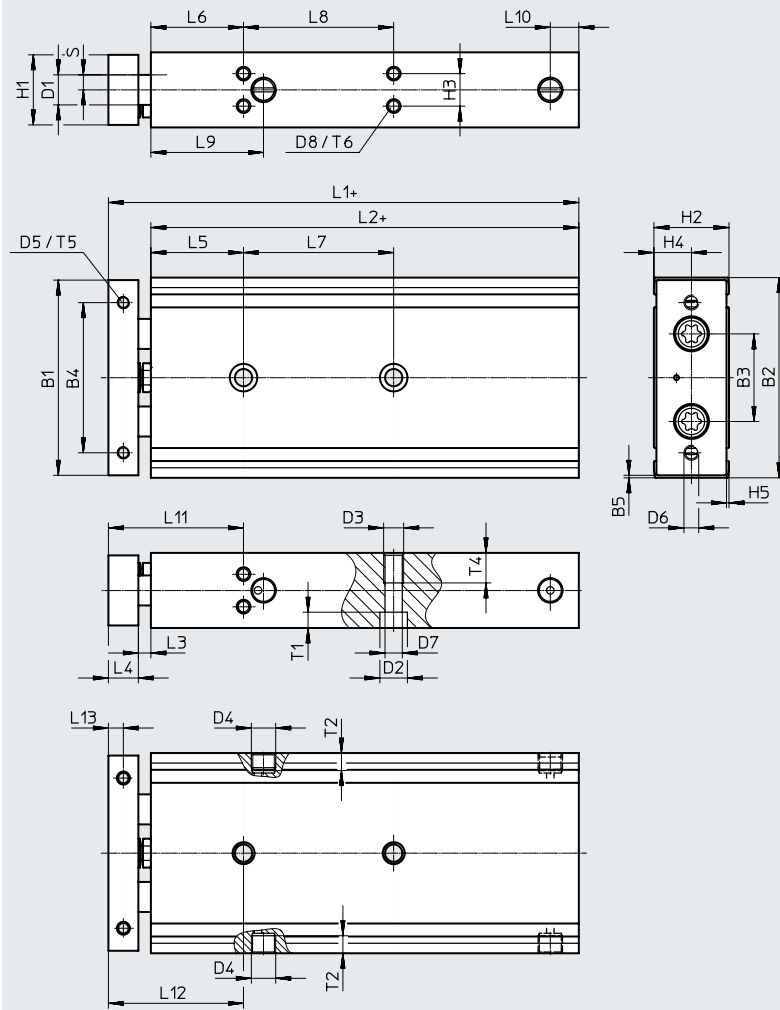

+ = plus stroke length

Datasheet

∅ [mm]	Stroke [mm]	B1	B2	B3	B4	B5	D1 ∅	D2 ∅	D3	D4	D5	D6	D7 ∅
20	10 ... 200	62	64	29	50	1	10	9.5	M6	M5	M4	M5	5.5
25		78	80	35	60	1	12	11	M8	G1/8	M5	M6	6.9
32		94	96	45	75	1	16	11	M8	G1/8	M5	M6	6.9

∅ [mm]	Stroke [mm]	D8	H1	H2	H3	H4	H5	L1	L2	L3	L4	L5	L6
20	10 ... 100	M4	23	25	9.5	12.5	1	86.5 ¹⁾	69.5 ¹⁾	5	12	37	37
	101 ... 125							211.5	194.5				
	126 ... 150							236.5	219.5				
	151 ... 175							261.5	244.5				
	176 ... 200							286.5	269.5				
25	10 ... 100	M5	28	30	13	15	1	88 ¹⁾	71 ¹⁾	5	12	37	37
	101 ... 125							213	196				
	126 ... 150							238	221				
	151 ... 175							263	246				
	176 ... 200							288	271				
32	10 ... 100	M5	36	38	20	19	1	97 ¹⁾	76 ¹⁾	5	16	39	39
	101 ... 125							222	201				
	126 ... 150							247	226				
	151 ... 175							272	251				
	176 ... 200							297	276				

1) Plus stroke length

∅ [mm]	Stroke [mm]	L9	L10	L11	L12	L13	S	T1	T2	T4	T5	T6
20	10 ... 200	42.5	12	54	54	6	6	5.3	5.5	10	8	5.5
25		45	11.4	54	54	6	6	6.3	7	12	9	7.5
32		49.5	11.6	60	60	8	8	6.3	7	12	10	7.5

Piston ∅ 20, 25			Piston ∅ 32		
Stroke [mm]	L7	L8	Stroke [mm]	L7	L8
10	25		10	30	
20	30		20	40	
30	40		30	50	
40	40		40	50	
50	40		50	50	
60	60		60	70	
70	60		70	70	
80	60		80	70	
90	60		90	70	
100	60		100	70	
101 ... 125	80		101 ... 125	90	
126 ... 150	80		126 ... 150	90	
151 ... 175	100		151 ... 175	110	
176 ... 200	100		176 ... 200	110	

Datasheet

Dimensions – Two end plates and through piston rod

Download CAD data → www.festo.com

∅ 20 ... 32

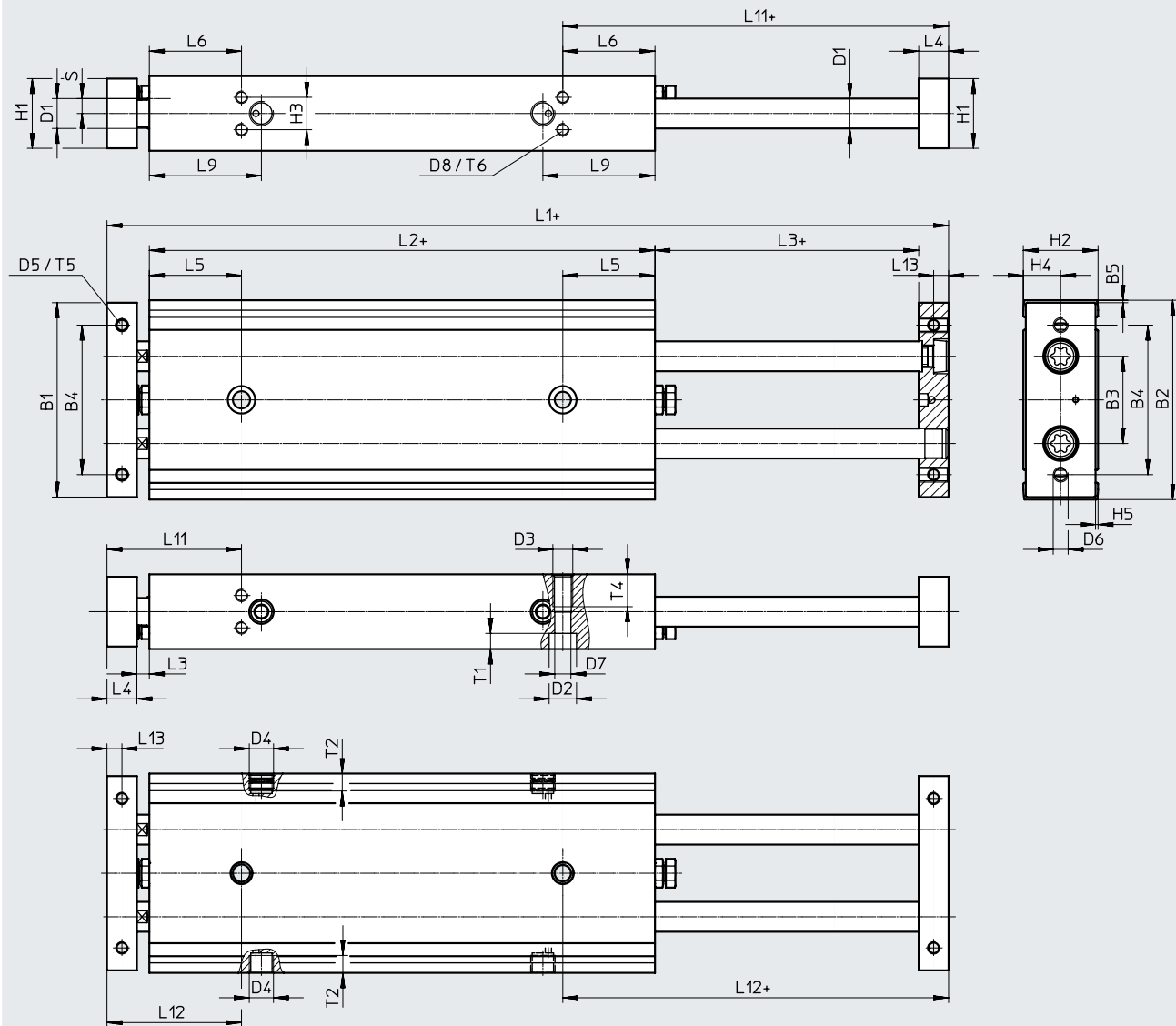

+ = plus stroke length

Datasheet

∅ [mm]	Stroke [mm]	B1	B2	B3	B4	B5	D1 ∅	D2 ∅	D3	D4	D5	D6
20	10 ... 200	62	64	29	50	1	10	9.5	M6	M5	M4	M5
25		78	80	35	60	1	12	11	M8	G1/8	M5	M6
32		94	96	45	75	1	16	11	M8	G1/8	M5	M6

∅ [mm]	Stroke [mm]	D7 ∅	D8	H1	H2	H3	H4	H5	L1	L2	L3	L4
20	10	5.5	M4	23	25	9.5	12.5	1	156	111	5	12
	20								176	121		
	30								196	131		
	40								216	141		
	50								236	151		
	80								296	181		
	100								336	201		
	101 ... 125								261 ¹⁾	226		
	126 ... 150								286 ¹⁾	251		
	151 ... 175								311 ¹⁾	276		
	176 ... 200								336 ¹⁾	301		
25	10	6.9	M5	28	30	13	15	1	158	113	5	12
	20								178	123		
	30								198	133		
	40								218	143		
	50								238	153		
	80								298	183		
	100								338	203		
	101 ... 125								263 ¹⁾	228		
	126 ... 150								288 ¹⁾	253		
	151 ... 175								313 ¹⁾	278		
	176 ... 200								338 ¹⁾	303		
32	10	6.9	M5	36	38	20	19	1	180	127	5	16
	20								200	137		
	30								220	147		
	40								240	157		
	50								260	167		
	80								320	197		
	100								360	217		
	101 ... 125								285 ¹⁾	242		
	126 ... 150								310 ¹⁾	267		
	151 ... 175								335 ¹⁾	292		
	176 ... 200								360 ¹⁾	317		

1) Plus stroke length

∅ [mm]	Stroke [mm]	L5	L6	L9	L11	L12	L13	S	T1	T2	T4	T5	T6
20	10 ... 200	37	37	42.5	54	54	6	6	5.3	5.5	10	8	5.5
25		37	37	45	54	54	6	6	6.3	7	12	9	7.5
32		39	39	49.5	60	60	8	8	6.3	7	12	10	7.5

Datasheet

Ordering data – One end plate			Part no.	Type
Stroke [mm]	∅ 6 mm			
10	8100542	DGTZ-GF-6-10-P-A		
20	8100543	DGTZ-GF-6-20-P-A		
30	8100544	DGTZ-GF-6-30-P-A		
40	8100545	DGTZ-GF-6-40-P-A		
50	8100546	DGTZ-GF-6-50-P-A		
51 ... 60 ¹⁾	8116420	DGTZ-GF-6-...-P-A		
Stroke [mm]	∅ 10 mm			
10	8100554	DGTZ-GF-10-10-P-A		
20	8100555	DGTZ-GF-10-20-P-A		
30	8100556	DGTZ-GF-10-30-P-A		
40	8100557	DGTZ-GF-10-40-P-A		
50	8100558	DGTZ-GF-10-50-P-A		
60	8100559	DGTZ-GF-10-60-P-A		
70	8100560	DGTZ-GF-10-70-P-A		
80	8100561	DGTZ-GF-10-80-P-A		
81 ... 150 ¹⁾	8116418	DGTZ-GF-10-...-P-A		
Stroke [mm]	∅ 16 mm			
10	8100570	DGTZ-GF-16-10-P-A		
20	8100571	DGTZ-GF-16-20-P-A		
30	8100572	DGTZ-GF-16-30-P-A		
40	8100573	DGTZ-GF-16-40-P-A		
50	8100574	DGTZ-GF-16-50-P-A		
60	8100575	DGTZ-GF-16-60-P-A		
70	8100576	DGTZ-GF-16-70-P-A		
80	8100577	DGTZ-GF-16-80-P-A		
90	8100578	DGTZ-GF-16-90-P-A		
100	8100579	DGTZ-GF-16-100-P-A		
101 ... 200 ¹⁾	8116417	DGTZ-GF-16-...-P-A		
Stroke [mm]	∅ 25 mm			
10	8100637	DGTZ-GF-25-10-P-A		
20	8100638	DGTZ-GF-25-20-P-A		
30	8100639	DGTZ-GF-25-30-P-A		
40	8100640	DGTZ-GF-25-40-P-A		
50	8100641	DGTZ-GF-25-50-P-A		
60	8100642	DGTZ-GF-25-60-P-A		
70	8100643	DGTZ-GF-25-70-P-A		
80	8100644	DGTZ-GF-25-80-P-A		
90	8100645	DGTZ-GF-25-90-P-A		
100	8100646	DGTZ-GF-25-100-P-A		
101 ... 200 ¹⁾	8116422	DGTZ-GF-25-...-P-A		
Stroke [mm]	∅ 32 mm			
10	8100657	DGTZ-GF-32-10-P-A		
20	8100658	DGTZ-GF-32-20-P-A		
30	8100659	DGTZ-GF-32-30-P-A		
40	8100660	DGTZ-GF-32-40-P-A		
50	8100661	DGTZ-GF-32-50-P-A		
60	8100662	DGTZ-GF-32-60-P-A		
70	8100663	DGTZ-GF-32-70-P-A		
80	8100664	DGTZ-GF-32-80-P-A		
90	8100665	DGTZ-GF-32-90-P-A		
100	8100666	DGTZ-GF-32-100-P-A		
101 ... 200 ¹⁾	8116424	DGTZ-GF-32-...-P-A		

1) Strokes freely selectable in 1 mm increments.

Datasheet

Ordering data – Two end plates and through piston rod			Part no.	Type
Stroke [mm]	∅ 6 mm			
10	8103467	DGTZ-GF-6-10-J-T-P-A		
20	8103468	DGTZ-GF-6-20-J-T-P-A		
30	8103469	DGTZ-GF-6-30-J-T-P-A		
40	8103470	DGTZ-GF-6-40-J-T-P-A		
50	8103471	DGTZ-GF-6-50-J-T-P-A		
51 ... 60 ¹⁾	8150885	DGTZ-GF-6-...-J-T-P-A		
Stroke [mm]	∅ 10 mm			
10	8103497	DGTZ-GF-10-10-J-T-P-A		
20	8103498	DGTZ-GF-10-20-J-T-P-A		
30	8103499	DGTZ-GF-10-30-J-T-P-A		
40	8103500	DGTZ-GF-10-40-J-T-P-A		
50	8103501	DGTZ-GF-10-50-J-T-P-A		
51 ... 150 ¹⁾	8150886	DGTZ-GF-10-...-J-T-P-A		
Stroke [mm]	∅ 16 mm		∅ 20 mm	
10	8103427	DGTZ-GF-16-10-J-T-P-A	8103487	DGTZ-GF-20-10-J-T-P-A
20	8103428	DGTZ-GF-16-20-J-T-P-A	8103488	DGTZ-GF-20-20-J-T-P-A
30	8103429	DGTZ-GF-16-30-J-T-P-A	8103489	DGTZ-GF-20-30-J-T-P-A
40	8103430	DGTZ-GF-16-40-J-T-P-A	8103490	DGTZ-GF-20-40-J-T-P-A
50	8103431	DGTZ-GF-16-50-J-T-P-A	8103491	DGTZ-GF-20-50-J-T-P-A
80	8103432	DGTZ-GF-16-80-J-T-P-A	8103492	DGTZ-GF-20-80-J-T-P-A
100	8103433	DGTZ-GF-16-100-J-T-P-A	8103493	DGTZ-GF-20-100-J-T-P-A
101 ... 200 ¹⁾	8150887	DGTZ-GF-16-...-J-T-P-A	8150888	DGTZ-GF-20-...-J-T-P-A
Stroke [mm]	∅ 25 mm		∅ 32 mm	
10	8103457	DGTZ-GF-25-10-J-T-P-A	8103513	DGTZ-GF-32-10-J-T-P-A
20	8103458	DGTZ-GF-25-20-J-T-P-A	8103514	DGTZ-GF-32-20-J-T-P-A
30	8103459	DGTZ-GF-25-30-J-T-P-A	8103515	DGTZ-GF-32-30-J-T-P-A
40	8103460	DGTZ-GF-25-40-J-T-P-A	8103516	DGTZ-GF-32-40-J-T-P-A
50	8103461	DGTZ-GF-25-50-J-T-P-A	8103517	DGTZ-GF-32-50-J-T-P-A
80	8103462	DGTZ-GF-25-80-J-T-P-A	8103518	DGTZ-GF-32-80-J-T-P-A
100	8103463	DGTZ-GF-25-100-J-T-P-A	8103519	DGTZ-GF-32-100-J-T-P-A
101 ... 200 ¹⁾	8150889	DGTZ-GF-25-...-J-T-P-A	8150890	DGTZ-GF-32-...-J-T-P-A

1) Strokes freely selectable in 1 mm increments.



Accessories

Proximity switches for piston \varnothing 6 ... 20

Ordering data – Proximity switches for C-slot, magneto-resistive							Datasheets → Internet: sdbc
	Type of mounting	Switching output	Electrical connection, outlet direction of connection	Cable length [m]	Part no.	Type	
N/O							
	Inserted in the slot from above	PNP	Cable, 3-wire, in-line	2	8139723	SDBC-MSB-1L-PU-K-2-LE	
			Plug M8x1, 3-pin, in-line	0.3	8139726	SDBC-MSB-1L-PU-K-0.3-M8	
		NPN	Cable, 3-wire, in-line	2	8139724	SDBC-MSB-1L-NU-K-2-LE	
			Plug M8x1, 3-pin, in-line	0.3	8139727	SDBC-MSB-1L-NU-K-0.3-M8	
		Non-contacting, 2-wire	Cable, 2-wire, in-line	2	8139725	SDBC-MSB-1L-ZU-K-2-LE	

Ordering data – Proximity switches for C-slot, magneto-resistive							Datasheets → Internet: smt
	Type of mounting	Switching output	Electrical connection, outlet direction of connection	Cable length [m]	Part no.	Type	
N/O							
	Inserted in the slot from above	PNP	Cable, 3-wire, in-line	2.5	551373	SMT-10M-PS-24V-E-2.5-L-OE	
			Cable, 3-wire, lateral	2.5	551374	SMT-10M-PS-24V-E-2.5-Q-OE	
			Plug M8x1, 3-pin, in-line	0.3	551375	SMT-10M-PS-24V-E-0.3-L-M8D	
			Plug M8x1, 3-pin, lateral	0.3	551376	SMT-10M-PS-24V-E-0.3-Q-M8D	
		NPN	Cable, 3-wire, in-line	2.5	551377	SMT-10M-NS-24V-E-2.5-L-OE	
			Cable, 3-wire, lateral	2.5	551378	SMT-10M-NS-24V-E-2.5-Q-OE	
			Plug M8x1, 3-pin, in-line	0.3	551379	SMT-10M-NS-24V-E-0.3-L-M8D	
			Plug M8x1, 3-pin, lateral	0.3	551380	SMT-10M-NS-24V-E-0.3-Q-M8D	
		Non-contacting, 2-wire	Cable, 2-wire, in-line	2.5	551382	SMT-10M-ZS-24V-E-2.5-L-OE	
			Cable, 2-wire, lateral	2.5	551383	SMT-10M-ZS-24V-E-2.5-Q-OE	

Ordering data – Proximity switches for C-slot, magneto-resistive							Datasheets → Internet: smt
	Type of mounting	Switching output	Electrical connection, outlet direction of connection	Cable length [m]	Part no.	Type	
N/O							
	Inserted in the slot from the side	PNP	Cable, 3-wire, lateral	2.5	547862	SMT-10G-PS-24V-E-2.5Q-OE	
			Plug M8x1, 3-pin, lateral	0.3	547863	SMT-10G-PS-24V-E-0.3Q-M8D	
		NPN	Cable, 3-wire, lateral	2.5	8065030	SMT-10G-NS-24V-E-2.5Q-OE	
			Plug M8x1, 3-pin, lateral	0.3	8065029	SMT-10G-NS-24V-E-0.3Q-M8D	

Ordering data – Connecting cables							Datasheets → Internet: nebu
	Electrical connection, left	Electrical connection, right	Cable length [m]	Part no.	Type		
	Straight socket, M8x1, 3-pin	Cable, open end, 3-wire	2.5	541333	NEBU-M8G3-K-2.5-LE3		
			5	541334	NEBU-M8G3-K-5-LE3		
	Angled socket, M8x1, 3-pin	Cable, open end, 3-wire	2.5	541338	NEBU-M8W3-K-2.5-LE3		
			5	541341	NEBU-M8W3-K-5-LE3		

Accessories

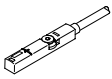

Proximity switches for piston \varnothing 25 ... 32

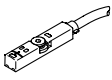
Ordering data – Proximity switches for T-slot, magnetic reed							Datasheets → Internet: sme
	Type of mounting	Switching output	Electrical connection	Cable length [m]	Part no.	Type	
N/O							
	Inserted in the slot from above, flush with the cylinder profile	Contacting	Cable, 3-wire	2.5	543862	SME-8M-DS-24V-K-2.5-OE	
				5.0	543863	SME-8M-DS-24V-K-5.0-OE	
			Cable, 2-wire	2.5	543872	SME-8M-ZS-24V-K-2.5-OE	
			Plug M8x1, 3-pin	0.3	543861	SME-8M-DS-24V-K-0.3-M8D	

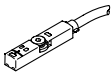
Ordering data – Proximity switch for T-slot, magneto-resistive							Datasheets → Internet: smt
	Type of mounting	Switching output	Electrical connection	Cable length [m]	Part no.	Type	
N/O							
	Inserted in the slot from above, flush with the cylinder profile, short design	PNP	Cable, 3-wire	2.5	574335	SMT-8M-A-PS-24V-E-2.5-OE	
			Cable, 3-wire	5	574336	SMT-8M-A-PS-24V-E-5.0-OE	
			Plug M8x1, 3-pin	0.3	574334	SMT-8M-A-PS-24V-E-0.3-M8D	
		NPN	Plug M12x1, 3-pin	0.3	574337	SMT-8M-A-PS-24V-E-0.3-M12	
			Cable, 3-wire	2.5	574338	SMT-8M-A-NS-24V-E-2.5-OE	
			Plug M8x1, 3-pin	0.3	574339	SMT-8M-A-NS-24V-E-0.3-M8D	

N/C							
	Inserted in the slot from above, flush with the cylinder profile, short design	PNP	Cable, 3-wire	7.5	574340	SMT-8M-A-PO-24V-E-7.5-OE	

Ordering data – Proximity switch for T-slot, magneto-resistive							Datasheets → Internet: smt
	Type of mounting	Switching output	Electrical connection, outlet direction of connection	Cable length [m]	Part no.	Type	
N/O							
	Inserted in the slot from the side	PNP	Cable, 3-wire, lateral	2.5	547859	SMT-8G-PS-24V-E-2.5Q-OE	
			Plug M8x1, 3-pin, lateral	0.3	547860	SMT-8G-PS-24V-E-0.3Q-M8D	
		NPN	Cable, 3-wire, lateral	2.5	8065028	SMT-8G-NS-24V-E-2.5Q-OE	
			Plug M8x1, 3-pin, lateral	0.3	8065027	SMT-8G-NS-24V-E-0.3Q-M8D	

Ordering data – Connecting cables							Datasheets → Internet: nebu
	Electrical connection, left	Electrical connection, right	Cable length [m]	Part no.	Type		
	Straight socket, M8x1, 3-pin	Cable, open end, 3-wire	2.5	541333	NEBU-M8G3-K-2.5-LE3		
			5	541334	NEBU-M8G3-K-5-LE3		
	Straight socket, M12x1, 5-pin	Cable, open end, 3-wire	2.5	541363	NEBU-M12G5-K-2.5-LE3		
			5	541364	NEBU-M12G5-K-5-LE3		
	Angled socket, M8x1, 3-pin	Cable, open end, 3-wire	2.5	541338	NEBU-M8W3-K-2.5-LE3		
			5	541341	NEBU-M8W3-K-5-LE3		
	Angled socket, M12x1, 5-pin	Cable, open end, 3-wire	2.5	541367	NEBU-M12W5-K-2.5-LE3		
			5	541370	NEBU-M12W5-K-5-LE3		

Accessories

Position transmitters for piston diameter 25 ... 32

The position transmitter continuously senses the position of the piston.
It has an analogue output with an output signal relative to the piston position.

Ordering data – Position transmitters for T-slot

Datasheets → Internet: position transmitter

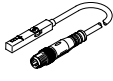
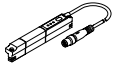
	Position measuring range	Analogue output [V] [mA]		Type of mounting	Electrical connection	Cable length [m]	Part no.	Type
	0 ... 40	0 ... 10	–	Inserted in the slot from above	Plug M8x1, 4-pin, in-line	0.3	553744	SMAT-8M-U-E-0.3-M8D ¹⁾
	0 ... 50	–	4 ... 20	Inserted in the slot from above	Plug M8x1, 4-pin, in-line	0.3	1531265	SDAT-MHS-M50-1L-SA-E-0.3-M8
	0 ... 80						1531266	SDAT-MHS-M80-1L-SA-E-0.3-M8
	0 ... 100						1531267	SDAT-MHS-M100-1L-SA-E-0.3-M8
	0 ... 125						1531268	SDAT-MHS-M125-1L-SA-E-0.3-M8
	0 ... 160						1531269	SDAT-MHS-M160-1L-SA-E-0.3-M8

1) Only with piston diameter 25

Ordering data – Connecting cables

Datasheets → Internet: nebu

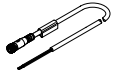
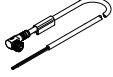
	Electrical connection, left	Electrical connection, right	Cable length [m]	Part no.	Type
	Straight socket, M8x1, 4-pin	Cable, open end, 4-wire	2.5	541342	NEBU-M8G4-K-2.5-LE4
			5	541343	NEBU-M8G4-K-5-LE4
	Angled socket, M8x1, 4-pin	Cable, open end, 4-wire	2.5	541344	NEBU-M8W4-K-2.5-LE4
			5	541345	NEBU-M8W4-K-5-LE4

Ordering data – One-way flow control valves

Datasheets → Internet: grla

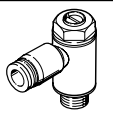
	Connection		Material	Part no.	Type
	Thread	For tubing O.D.			
	M5	3	Metal design	193137	GRLA-M5-QS-3-D
		4		193138	GRLA-M5-QS-4-D
		6		193139	GRLA-M5-QS-6-D
	G1/8	3		193142	GRLA-1/8-QS-3-D
		4		193143	GRLA-1/8-QS-4-D
		6		193144	GRLA-1/8-QS-6-D
		8		193145	GRLA-1/8-QS-8-D