

## Modular electrical terminal CPX

**FESTO**

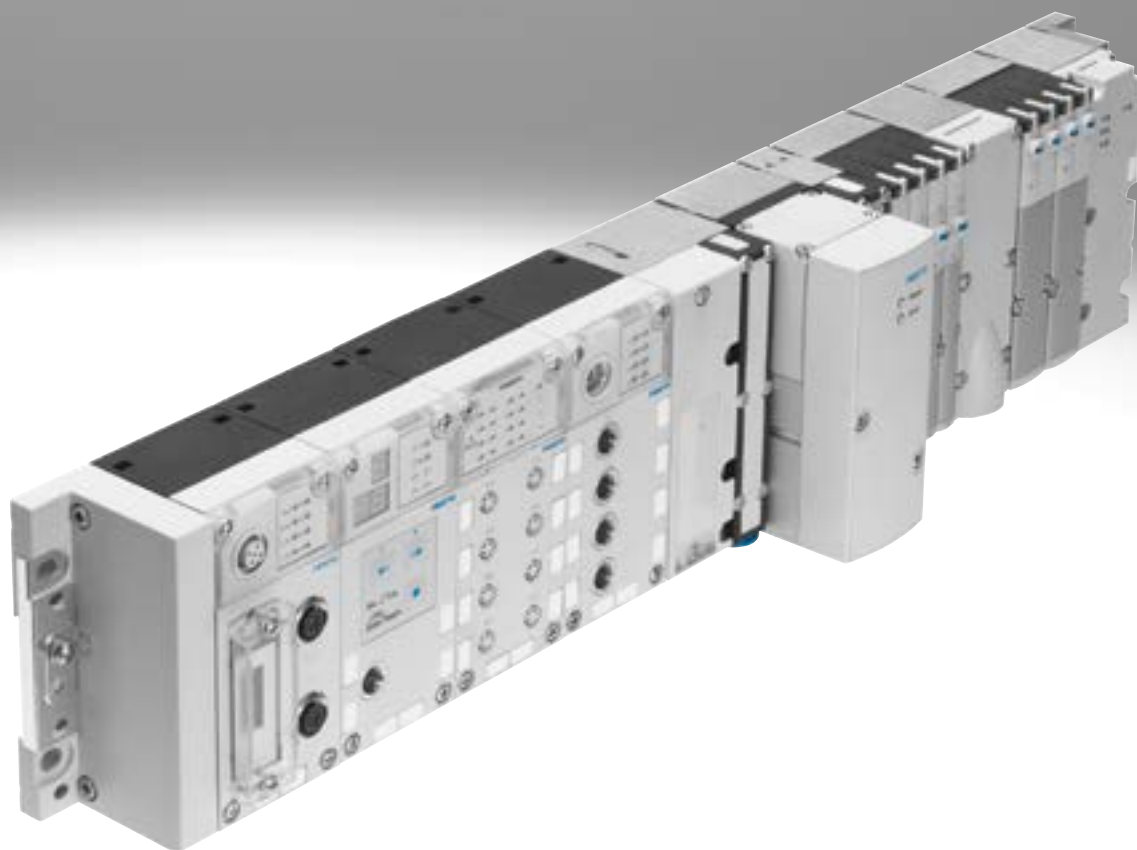

## Key features



## Key features

## Installation concept

- Choice of several valve terminals for different applications:
  - MPA-S
  - MPA-L
  - VTSA/VTSA-F/VTSA-F-CB
- Economical from the smallest configuration up to the maximum number of modules
- Up to 9 electrical input/output modules plus bus node and pneumatic interface/electronics modules for valves
- Extensive range of functions and connection options for the electrical modules
- Choice of connection technology for technically and economically optimised connections
- Can be used as a dedicated remote I/O module

## Electrics

- High operating voltage tolerance ( $\pm 25\%$ )
- Choice of M12x1, M18, 7/8" or AIDA push-pull connection for power supply
- Open to all fieldbus protocols and Ethernet
- Optional function and technology modules for preprocessing
- IT services and TCP/IP such as remote maintenance, remote diagnostics, web server, SMS and e-mail alert
- Digital inputs and outputs, 4-/8-/16-way, optionally available with individual channel diagnostics
- Analogue inputs and outputs, 2-way/4-way, optionally with HART protocol
- Pressure inputs
- Temperature inputs
- Controllers for pneumatic and electric axes
- IP65 and IP67 or IP20

## Mounting

- Wall or H-rail mounting, also on mobile units
- Conversions/extensions are possible at any time, individual linking with CPX metal design
- Modular system offering a range of configuration options
- Fully assembled and tested unit
- Reduced costs for selection, ordering, assembly and commissioning thanks to the central CPX terminal
- Choice of pneumatic components for optimised control chain
- Decentralised, subordinate CPI installation system improves cycle times by up to 30%
- Safe and convenient earthing thanks to earthing plate

## Operation

- Fast troubleshooting thanks to an extensive selection of LEDs (some of which are multi-coloured) on the bus node and on all I/O modules
- Supports module and channel-oriented diagnostics
- Fieldbus/Ethernet remote diagnostics
- Innovative diagnostic support with integrated web server/web monitor or maintenance tool with USB adapter for PC
- Optimised commissioning thanks to parameterisable functions
- Reliable servicing with connection blocks and modules that are quick to replace without changing the wiring

## Key features

### Pneumatic variants of the CPX terminal

The electrical terminal CPX is a modular peripheral system for valve terminals.

The system is specifically designed so that the valve terminal can be adapted to suit a wide range of different applications.

The modular system design lets you configure the number of valves, inputs and additional outputs to suit the application.

#### With valve terminal – decentralised

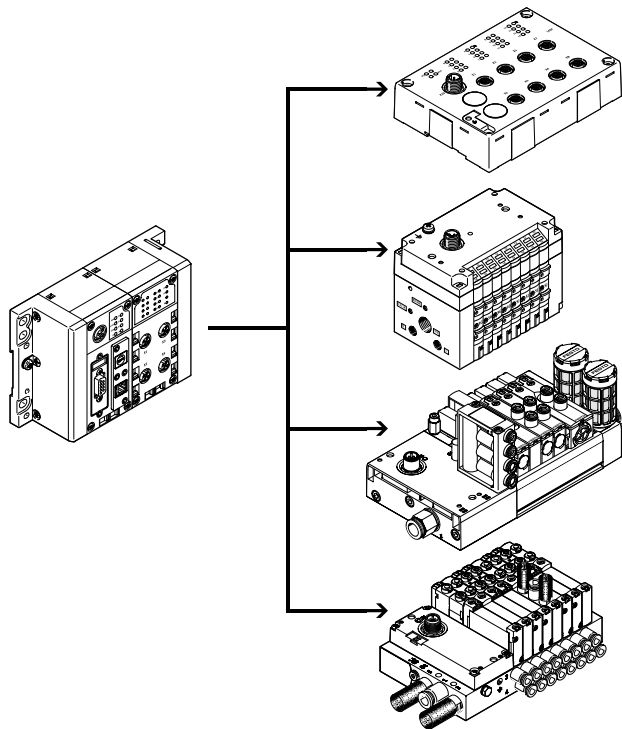

#### With valve terminal MPA-S – centralised

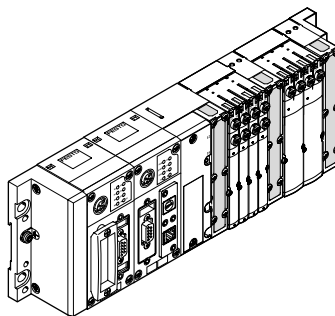

#### With valve terminal VTSA – centralised

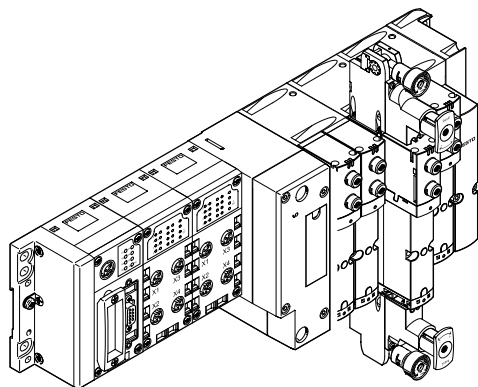

#### In metal design with valve terminal VTSA – centralised

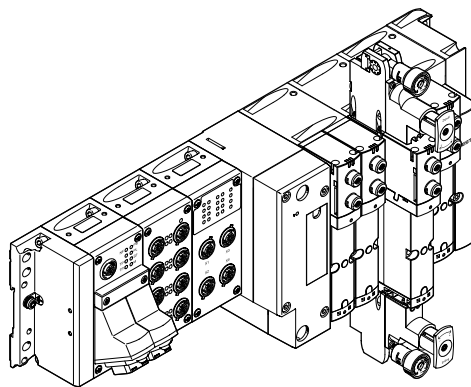

## Key features

### Variants of the CPX terminal controller (with bus node, without preprocessing)

#### Bus node

Different bus nodes are used for integration in the control systems of various manufacturers.

The CPX terminal can therefore be operated on over 90% of the most commonly used fieldbus systems:

- PROFIBUS DP
- PROFINET
- INTERBUS
- DeviceNet
- CANopen

- CC-Link

Integration in universal networks based on Ethernet opens up new possibilities. Faster data transmission, real-time capability and above all additional IT services such as file transfer, web server, web monitor as integrated website in the CPX terminal, text message/e-mail alerts, etc. open up a wide range of synergies.

These include standardised and universal communication technology across all areas, including operating level, management level and field level in the production environment, with protection to IP65, IP67.

The following protocols are supported:

- EtherNet/IP
- Modbus/TCP
- PROFINET
- POWERLINK

- EtherCAT
- Sercos III

#### Bus node

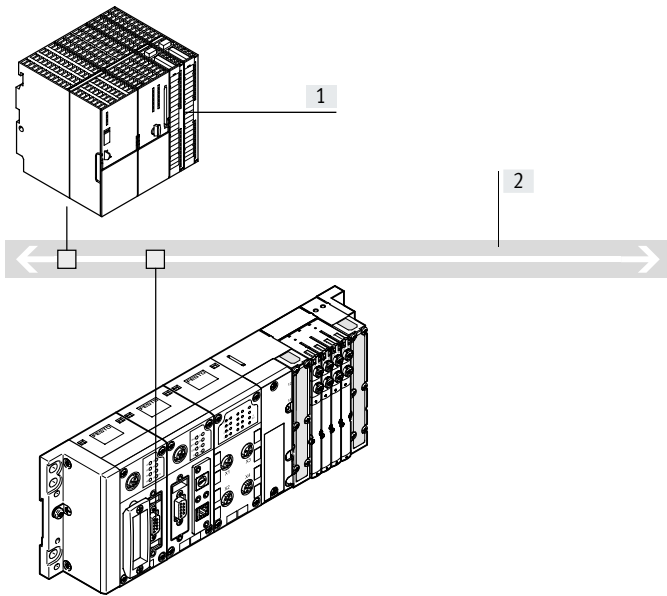

- [1] Higher-order controller (PLC)  
[2] Fieldbus

- Communication with the higher-order controller via fieldbus
- No preprocessing
- Fieldbus protocol dependent on CPX bus node used
- More than 90 I/Os, depending on bus node used

#### Industrial Ethernet bus node

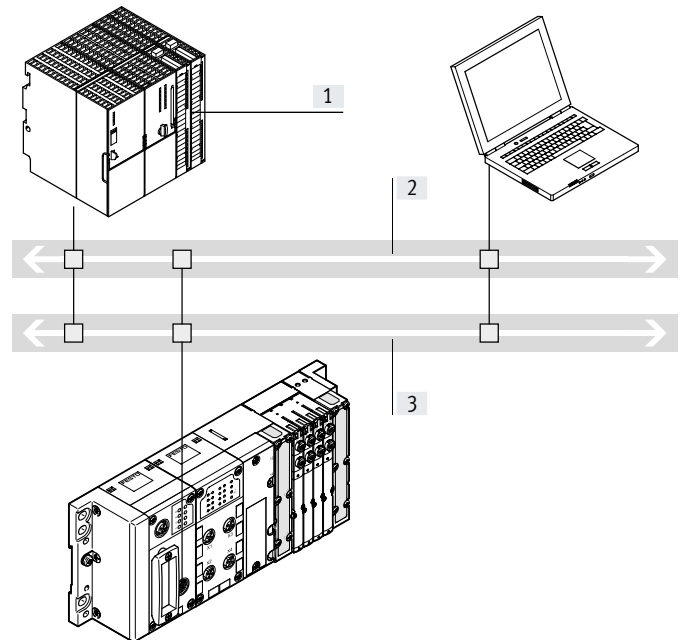

- [1] Higher-order controller (PLC)  
[2] Fieldbus  
[3] IT services:

- Web
- Email
- Data transmission

- Connection to a higher-order controller directly via EtherNet/IP, Modbus/TCP, POWERLINK, EtherCAT or PROFINET
- No preprocessing
- Monitoring via Ethernet and web applications
- More than 300 I/Os

#### Note

Every electrical interface can be combined with an appropriate number of I/O modules and/or pneumatic components, depending on its address capacity.

Likewise, every pneumatic variant of the CPX terminal can be operated with every electrical interface variant.



## Key features

### Variants of the CPX terminal controller (with preprocessing in the control block)

#### Control block

The optional front end controllers CPX-CEC enable simultaneous access via Ethernet, in parallel with a bus node, as well as stand-alone preprocessing.

Access via Modbus/TCP and EasyIP is also possible.

Commissioning, programming, and diagnostics using the Festo software tool FST with hardware configurator.

#### With control block in stand-alone mode

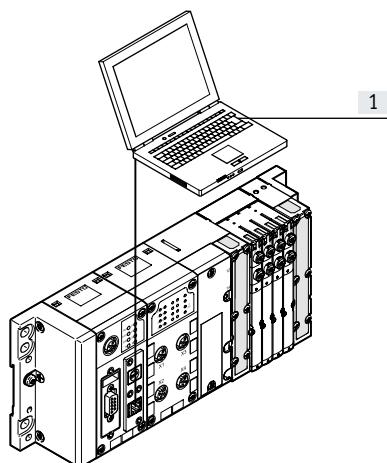

[1] CODESYS/FST

- Decentralised controller with direct machine mounting
- Downloading programs via Ethernet (or via the programming interface)
- Supports full expansion of all CPX peripherals
- More than 300 I/Os

Can be successfully used in the following applications:

- Stand-alone individual workstations
- Interlinked, stand-alone sub-systems
- Automation using IT technology

#### With control block in Festo EasyIP mode

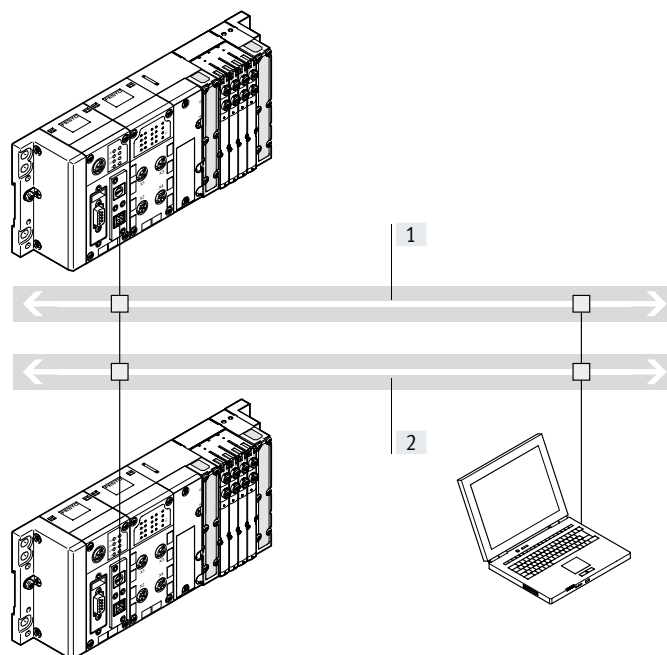

[1] Industrial Ethernet

[2] IT services:

- Web
- Email
- Data transmission

- Fast preprocessing of the CPX peripherals in the control block
- Exchange of any data between the control blocks via EasyIP
- Remote diagnostics
- No higher-order controller is required
- More than 300 I/Os per CPX control block

## Key features

### Variants of the CPX terminal controller (with preprocessing in the control block)

With control block as remote controller on Ethernet

Remote controller via Ethernet as the preprocessing unit for decentralised, stand-alone sub-systems using IT technology.

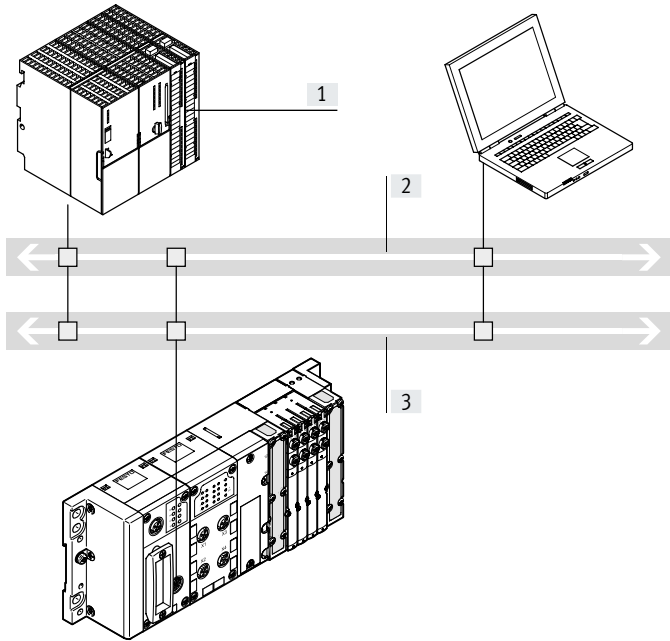

- [1] Higher-order controller (PLC)
- [2] Industrial Ethernet
- [3] IT services:
  - Web
  - Email
  - Data transmission

- Connection to a higher-order controller via Ethernet, no further bus node is required
- Monitoring via Ethernet and web applications
- Preprocessing of the CPX peripherals by CPX control block
- More than 300 I/Os

With control block as remote controller on the fieldbus

Fieldbus remote controller (combination with bus nodes for INTERBUS, PROFIBUS DP, PROFINET, CANopen, DeviceNet, CC-Link, POWERLINK, Sercos III or EtherCAT) as the preprocessing unit for decentralised, stand-alone subsystems.

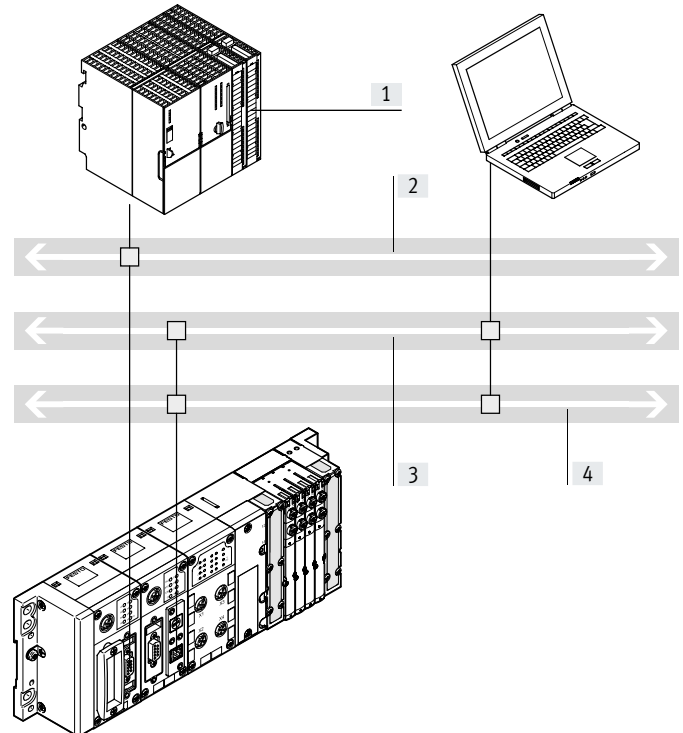

- [1] Higher-order controller (PLC)
- [2] Fieldbus
- [3] Industrial Ethernet
- [4] IT services:
  - Web
  - Email
  - Data transmission

- Fast preprocessing of the CPX peripherals in the control block
- Communication with the higher-order controller via fieldbus
- Optional additional monitoring via Ethernet and web applications
- Downloading programs via programming interface
- More than 300 I/Os, bus node is only used for communication with the higher-order PLC
- Option of two bus nodes for redundant communication configuration

## Key features

## Variants of the CPX terminal controller (with preprocessing in the control block)

With control block as CANopen fieldbus master

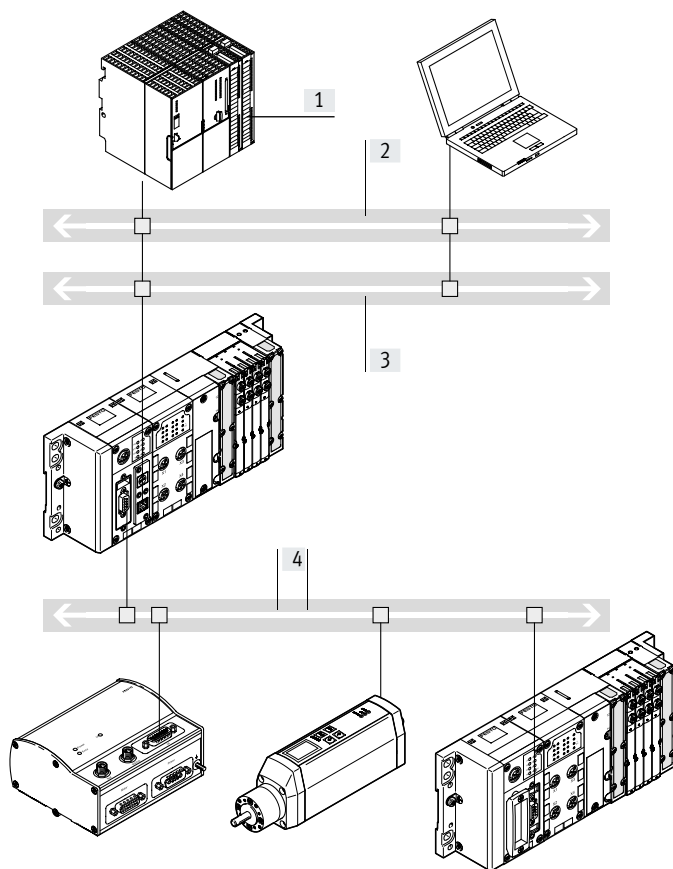

- [1] Higher-order controller (PLC)
- [2] Industrial Ethernet
- [3] IT services:
  - Web
  - Email
  - Data transmission
- [4] Fieldbus (CANopen)

## Features:

- Connection to a higher-order controller via Ethernet, no further bus node is required
- Monitoring via Ethernet
- Preprocessing of the CPX peripherals by CPX control block
- More than 300 I/Os
- Up to 128 stations with repeater technology on CANopen

## Operating modes:

- Remote controller on Ethernet
- Control block in Festo EasyIP mode

## Key features

### Connection of inputs and outputs to the CPX terminal

Digital and analogue CPX I/O modules

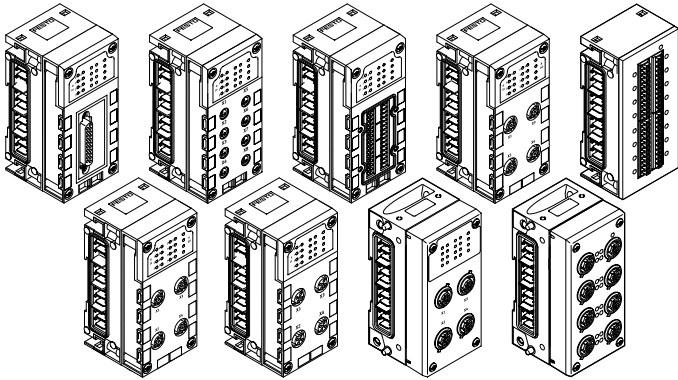

### Electrical connection

The connection technology for sensors and additional actuators offers a wide range of digital and analogue input and output modules and is freely selectable – as appropriate to your standard or the application. Plastic or metal connection blocks can be combined as required:

- Metal version
  - M12-5POL
- Plastic version:
  - M12-5POL
  - M12-5-PIN with quick lock and metal thread
  - M12-8POL
  - M8-3POL
  - M8-4POL
  - Sub-D
  - Harax®
  - CageClamp® (with cover also to IP65, IP67)
  - Screw/spring-loaded terminal

### With CPX-CP interface

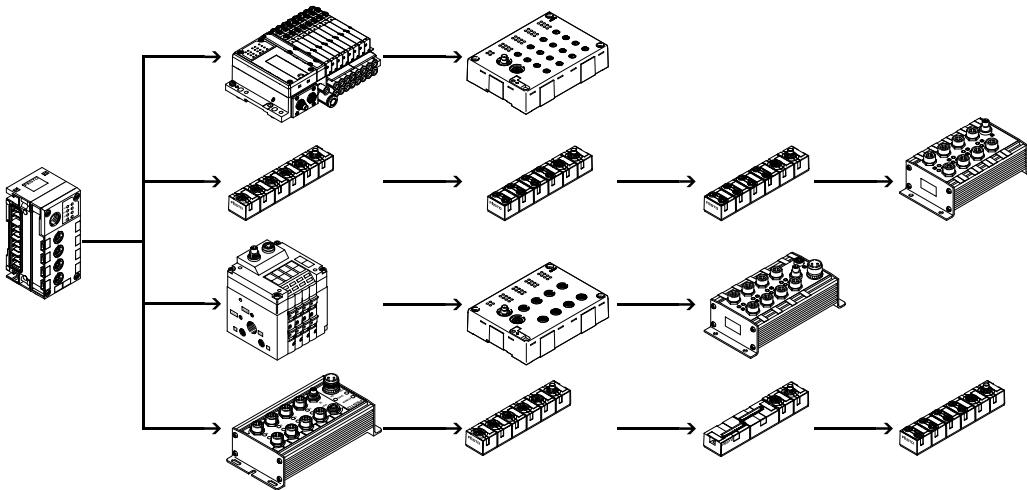

- Up to 4 strings per CP interface possible.
- Up to 4 subordinate CP modules can be combined in one string.
- Up to 32 I/Os can be connected per string.
- Modules with M8, M12 and terminal connection
- Several CP interface modules can be combined in one CPX terminal (depending on the controller used).
- Combination of centralised CPX I/O modules and decentrally mounted I/O modules of the installation system CPI.

### Combined centralised and decentralised electrical connection (valve terminal with CP interface/output module)

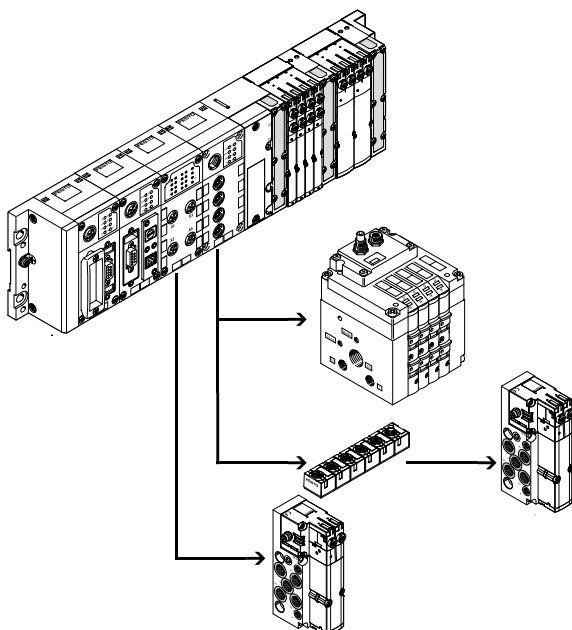

- Scalable to different requirements within a system
- One control interface in the system, reduces installation complexity with closely and widely spaced actuators
- Enables an optimum electrical and pneumatic control chain

## Key features

### Connection of inputs and outputs to the CPX terminal

With CPX-CTEL interface

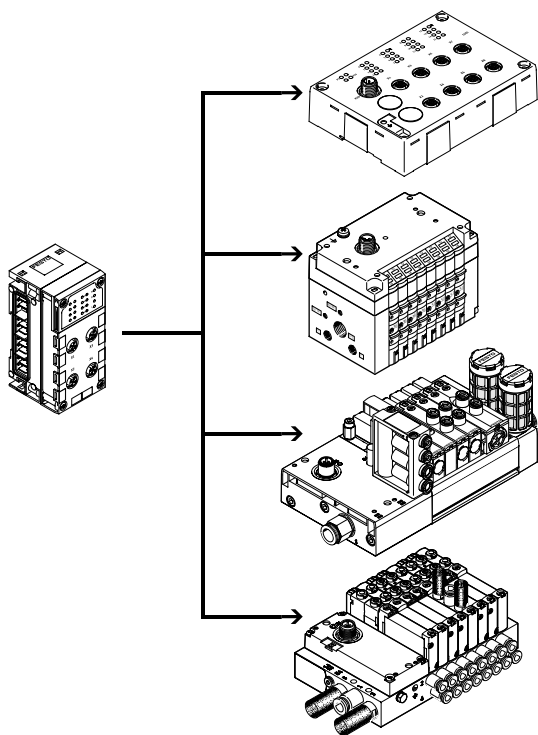

- Up to 4 devices with individual electronic protection per CPX CTEL master
- Max. 64 inputs/64 outputs per I-Port interface
- The maximum length of a string is 20 m.
- Input modules with 16 digital inputs (connection technology M8 3-pin and M12 5-pin)
- Valve terminals with I-Port interface (up to 48 solenoid coils, different valve functions)

Several CPX CTEL masters can be combined on one CPX terminal (depending on the controller used).

Combination of central CPX I/O modules and decentrally mounted I/O modules with I-Port interface.

With CPX-CTEL-2 interface

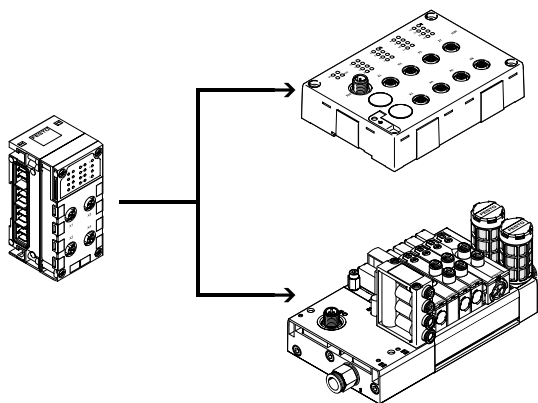

- Up to 2 IO-Link devices with individual electronic protection per CPX-CTEL-2 interface
- Max. 16-byte inputs/16-byte outputs per IO-Link device
- The maximum length of a string is 20 m.

Several CPX-CTEL-2 interfaces can be combined on one CPX terminal (depending on the controller used).

Combination of central CPX I/O modules and decentrally mounted I/O modules with IO-Link interface.

## Key features

### Connection of inputs and outputs to the CPX terminal

Electric drives with axis interface CPX-CM-HPP

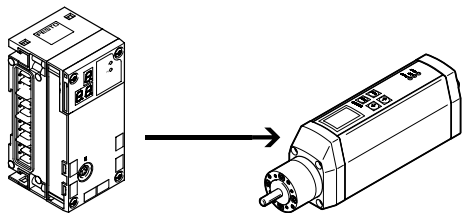

- Max. 4 individual electric axes possible per CPX-CM-HPP
- No programming required
- Standardised communication with the drives via the Festo Handling and Positioning Profile (FHPP)
- The control component is independent of the bus node used

### Pneumatic drives with CPX-CMAX/CMPX

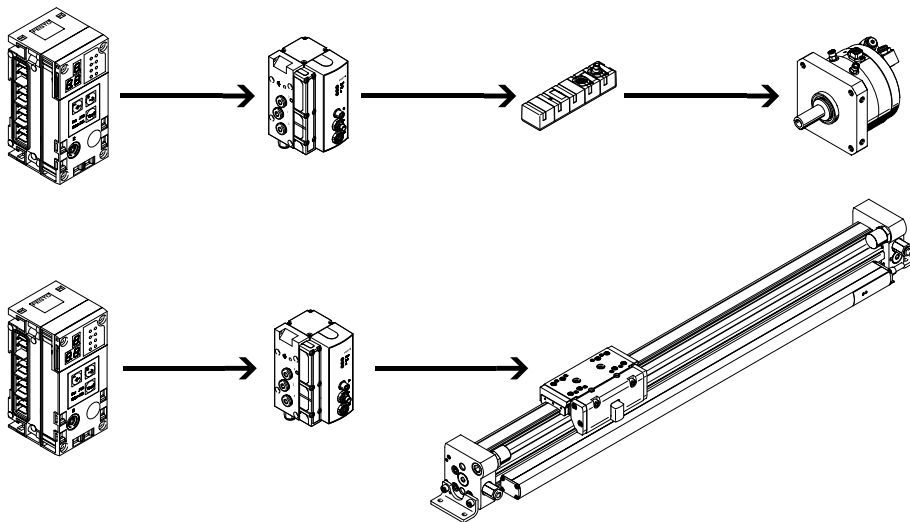

#### CPX-CMAX

- Position and force control, directly actuated or selected from one of 64 configurable positioning sets
- The configurable record sequencing function enables simple functional sequences to be realised
- Auto identification detects every station with its device data on the controller
- Control of a brake or clamping unit via the proportional directional control valve VPWP
- Up to 7 modules (max. 7 axes) can be operated in parallel and independently of each other
- Commissioning via the Festo configuration software FCT or via fieldbus

#### CPX-CMPX

- Fast travel between the mechanical end stops of the cylinder, stopping gently and without impact in the end position
- Fast commissioning via control panel, fieldbus or handheld terminal
- Improved downtime control
- Control of a brake or clamping unit via the proportional directional control valve VPWP
- Max. 9 end-position controllers can be actuated depending on the fieldbus
- All system data can be read and written via the fieldbus, including the mid-positions, for example:

## Key features

### Ordering

The CPX terminal with valve terminal is fully assembled according to your order specifications and individually tested. The finished valve terminal consists of the electrical peripherals including the desired actuation and the selected components of the VTSA (ISO), VTSA-F, VTSA-F-CB, MPA-S or MPA-L modules. The CPX terminal with valve terminal is ordered using two separate order codes.

One order code defines the electrical peripherals type CPX, while the other specifies the pneumatic components of the valve terminal.

The electrical peripherals type CPX can also be configured without a valve terminal and can be used on a fieldbus. To order this, only the order code for the electrical peripherals is required.

The order lists for the pneumatic components can be found at

- Internet: vtsa  
(Valve terminal VTSA)
- Internet: vtsa-f  
(Valve terminal VTSA-F)
- Internet: vtsa-f-cb  
(Valve terminal VTSA-F-CB)
- Internet: mpa-s  
(Valve terminal MPA-S)
- Internet: mpa-l  
(Valve terminal MPA-L)

The order lists for the CP/CPI components can be found at

- Internet: ctec  
(Installation system CPI)

The order lists for the CTEU/CTEL components can be found at

- Internet: cteu  
(I-Port interface/IO-Link)

## Peripherals overview

### Complete overview of modules

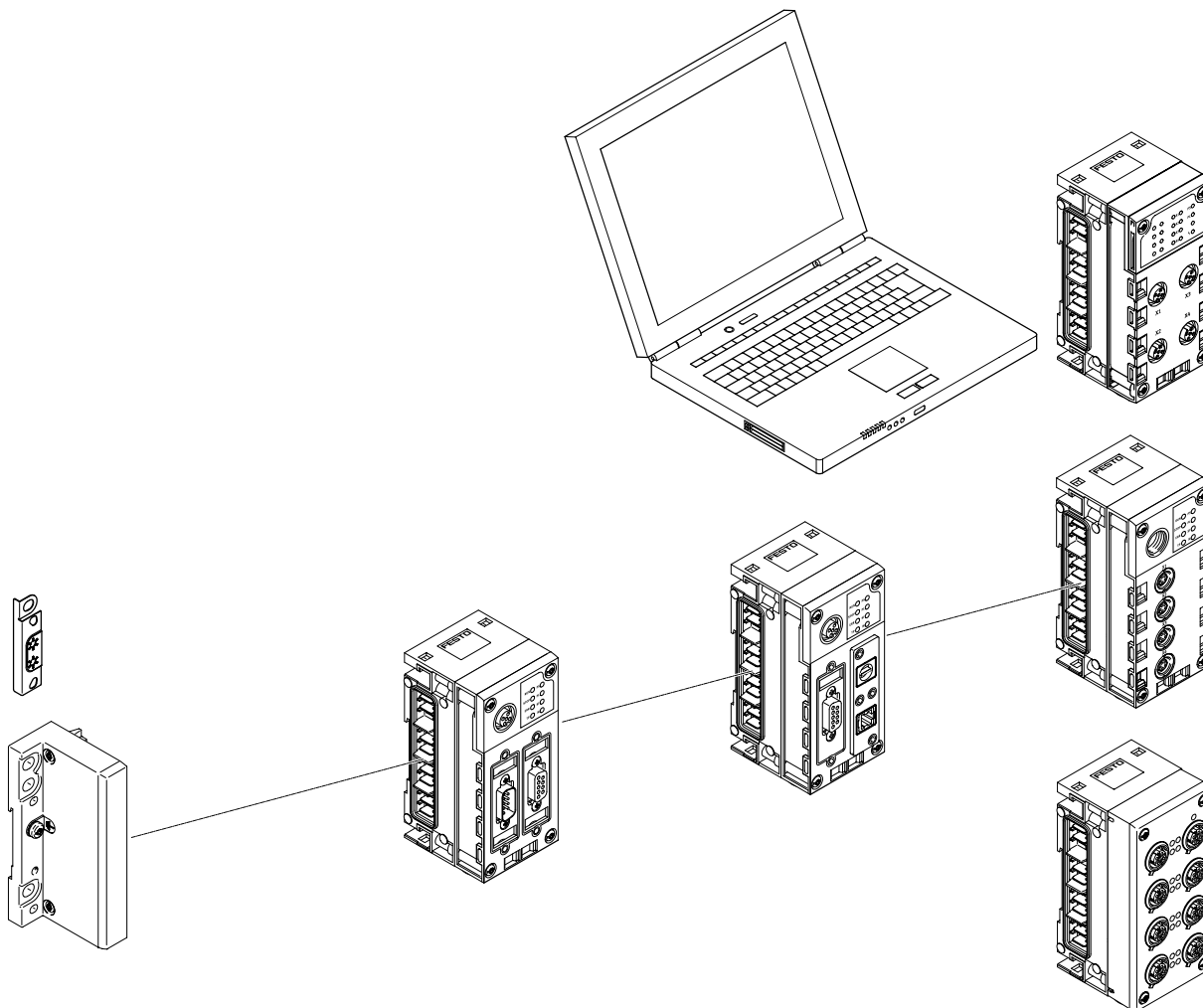

#### End plate

- Mounting holes for wall mounting
- Functional earth connection
- Special earthing plate for safe and easy connection to the machine bed or H-rail
- External power supply for the entire system

#### Bus node

- Fieldbus/Industrial Ethernet connection using various types of connection technology
- Setting fieldbus parameters via DIL switch
- Display of fieldbus and peripheral equipment status via LED
- PROFINET to AIDA standard in metal housing, fast start-up

#### Gateway

- Separate CPX combination
- Data gathering for connected components
- Secure data transfer to a central storage location (MQTT broker)

#### Control block

- Preprocessing, stand-alone controller or remote unit CPX-CEC
- Connection via Ethernet TCP/IP or Sub-D programming interface
- Setting operating modes via DIL switch and program selection via rotary switch
- CPX-CMX products for controlling axes

#### Web monitor

- Website integrated in the CPX terminal
- Dynamic status indication
- Online diagnostics
- SMS/e-mail alert

#### CP interface/CTEL interface

- Interfaces for decentralised installation systems, thus optimising the pneumatic control chains (short tubes/short cycle times)
- Actuation for I/O modules and valve terminals
- Power supply and bus interface via the same cable

#### Input/output modules

- Combination of
- Interlinking block
  - Electronics module
  - Connection block



## Peripherals overview

## Complete overview of modules

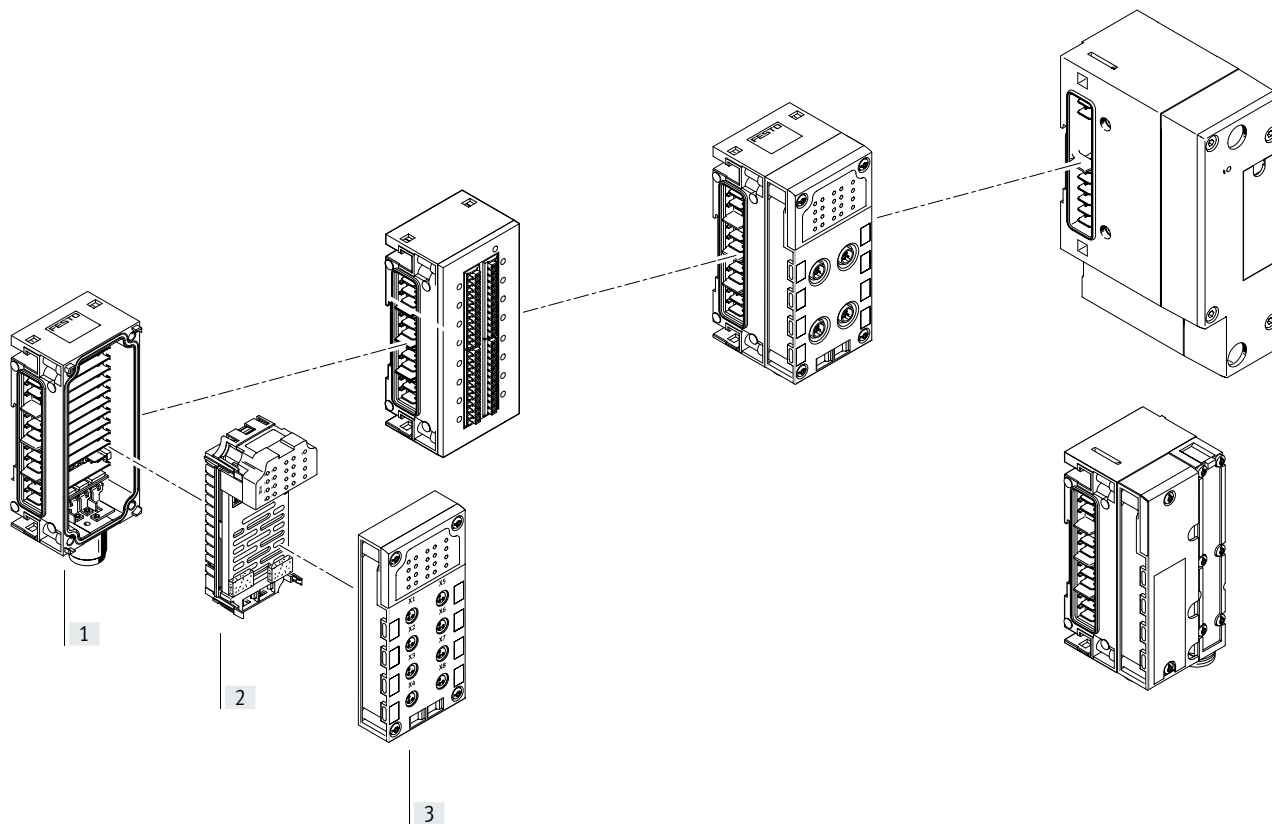

## Input/output modules

## [1] Interlinking block

- Internal linking of the power supply and serial communication
- External power supply for the entire system
- Additional supply for outputs or valves
- Transmission of the power supply
- Connection accessories for M12x1, M18, 7/8" or AIDA push-pull
- Plastic design: linking with tie rods
- Metal design: individually linked using M6 screws, individually expandable

## [2] Electronics module

- Digital inputs for connecting the sensors
- Digital outputs for activating additional actuators
- Analogue inputs
- Temperature inputs (analogue)
- Analogue outputs
- PROFIsafe input module for safety-oriented sensor technology
- PROFIsafe shut-off module with two digital outputs for shutting off the supply voltage for valves

## [3] Connection block

- Choice of 8 connection technology variants
- Degree of protection IP65, IP67 or IP20
- Can be combined with the electronics modules
- Connection accessories: M8/M12/Sub-D/quick connector
- Connecting cables: M8/M12/Sub-D etc.
- Modular system for M8/M12 connecting cables
- M12 connection technology for the metal design

## Pneumatic interface

- Actuation of the solenoid coils
- MPA-S
- MPA-L
- VTSA/VTSA-F/VTSA-F-CB
- Actuation of pressure sensors
- Control of proportional pressure regulators

## Peripherals overview

### Individual overview of modules

#### Bus node

→ Page 72

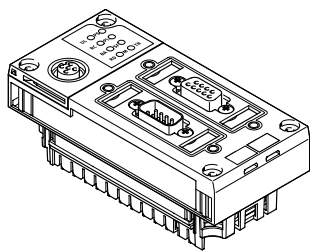

Bus node for

- PROFIBUS DP
  - INTERBUS
  - DeviceNet
  - CANopen
  - CC-Link
  - EtherNet/IP
- PROFINET
  - POWERLINK
  - EtherCAT
  - Sercos III

#### Control block

→ Page 65

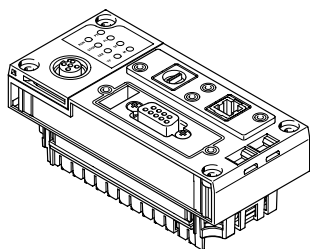

CPX-CEC

- Programming with CODESYS
- Ethernet interface
- Modbus/TCP
- EasyIP
- CANopen master

#### Gateway

→ Page 58

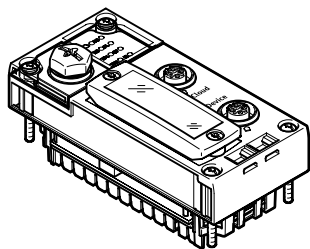

CPX-IOT

- Continuous transfer of operating data from connected Festo components to a central storage location (user-specific MQTT broker)
- Ethernet interface

#### CP interface

→ Page 125

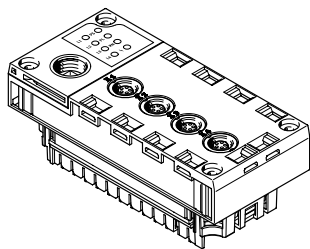

Interface CPX-CP

- 4 CP strings
- Max. 4 modules per string
- 32 inputs/32 outputs per string
- CPI functionality

#### CTEL interface

→ Page 130

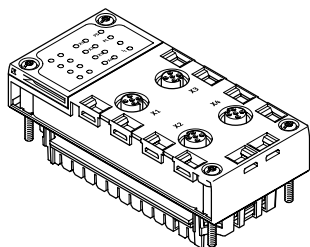

CPX-CTEL interface

- CTEL master
- Max. 4 devices with individual electronic protection
- Max. 64 inputs/64 outputs per I-Port interface
- The maximum length of a string is 20 m

#### Electrical interface CPX-CTEL-2

→ Page 136

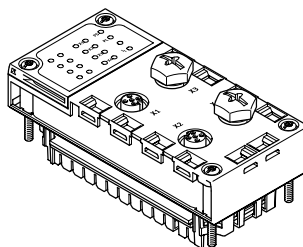

CPX-CTEL-2 interface

- Master for IO-Link
- Max. 2 devices with individual electronic protection
- Process data length of the inputs and outputs is limited to 16 bytes for inputs and 16 bytes for outputs per port
- The maximum length of a string is 20 m

## Peripherals overview

### Individual overview of modules

Modules for actuating electric drive units

→ Page 141

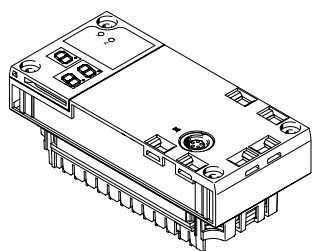

#### CPX-CM-HPP

- Axis interface
- CAN bus for up to 4 individual electric axes

Modules for controlling pneumatic drive units

→ Page 144

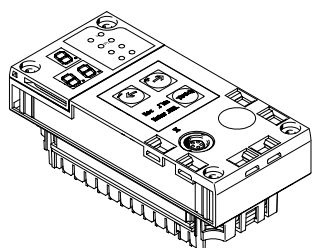

#### CPX-CMAX

- Axis controller
- Position and force control
- 64 configurable positioning records
- Auto-identification
- Control of a brake or clamping unit via the proportional directional control valve VPWP

#### CPX-CMPX

- End-position controller
- Fast travel between the mechanical end stops of the cylinder
- Smooth travel into the end position
- Improved downtime control
- Control of a brake via the proportional directional control valve VPWP

#### CPX-CMIX

- Measuring module
- CAN input (Festo specification) for measuring signal
- Recording the absolute position values or speed values of the connected drive

Plastic connection block

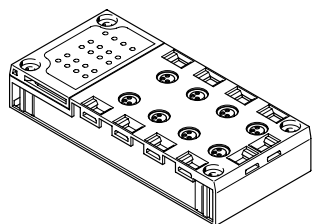

Direct machine mounting  
(degree of protection IP65, IP67)

- M8-3POL
- M8-4POL
- M12-5POL
- M12-5POL quick lock, shielded with metal thread
- M12-8POL
- Sub-D
- Quick connector
- Spring-loaded terminal with cover

Protected fitting space  
(degree of protection IP20)

- Spring-loaded terminal

Shielding concept

- Optional screening plate for connection blocks with M12 connection technology

Metal connection block

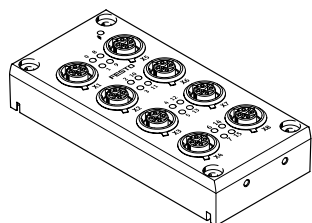

Direct machine mounting  
(degree of protection IP65, IP67)

- M12-5POL

Connection block including electronics module and interlinking block

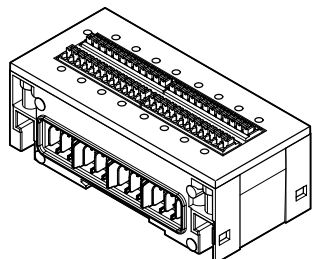

Installation in the control cabinet  
(degree of protection IP20)

- Plastic connection block
- Spring-loaded terminal
- Digital input module with 16 inputs
- Digital I/O module with 8 inputs and 8 outputs

## Peripherals overview

### Individual overview of modules

#### Connection block for NAMUR sensors and HART input/output module

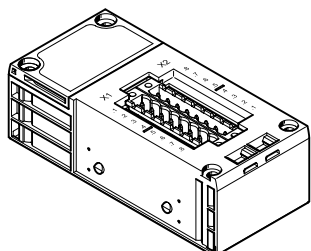

- Direct machine mounting  
(connection block to IP65)
- M12-4POL

- Protected fitting space  
(connection block to IP20)
- Screw terminal
  - Spring-loaded terminal

#### Digital electronics module for inputs/outputs

→ Page 153

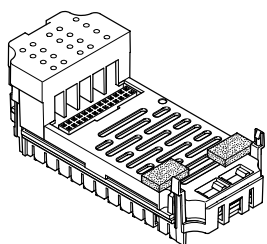

- Digital inputs
- 4 digital inputs
  - 8 digital inputs NPN
  - 8 digital inputs PNP
  - 8 digital inputs PNP with individual channel diagnostics
  - 16 digital inputs
  - 16 digital inputs with individual channel diagnostics

- Digital outputs
- 4 digital outputs (1 A per channel, individual channel diagnostics)
  - 8 digital outputs (0.5 A per channel, individual channel diagnostics)
  - 8 digital outputs (2.1 A/50 W lamp load per channel pair, individual channel diagnostics)

- Multi I/O modules
- 8 digital inputs and 8 digital outputs
  - 2 digital inputs (counter channels, connection to various encoders) and 2 digital outputs (directly controlled by the input values)

#### Digital electronics module for NAMUR sensors

→ Page 158

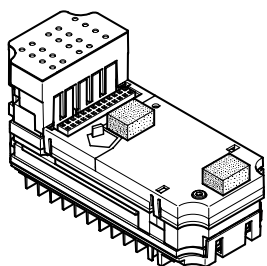

- Digital inputs
- 8 digital inputs for NAMUR sensors or wired mechanical contacts

#### Analogue electronics module for inputs/outputs

→ Page 194

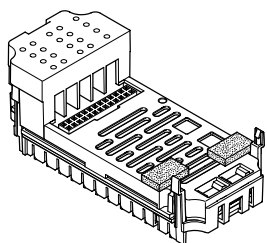

- Analogue inputs
- 2 analogue inputs (0 ... 10 V DC, 0 ... 20 mA, 4 ... 20 mA)
  - 4 analogue inputs (1 ... 5 V, 0 ... 10 V, -5 ... +5 V, -10 ... +10 V, 0 ... 20 mA, 4 ... 20 mA, -20 ... +20 mA)
  - 4 analogue inputs with HART protocol

- Analogue temperature inputs
- 4 analogue inputs for temperature measurement (Pt100, Pt200, Pt500, Pt1000, Ni100, Ni120, Ni500, Ni1000)
  - 4 analogue inputs for temperature measurement (thermocouple and PT1000 sensor for cold-junction compensation)

- Analogue outputs
- 2 analogue outputs (0 ... 10 V DC, 0 ... 20 mA, 4 ... 20 mA)
  - 4 analogue outputs with HART protocol

#### PROFIsafe input module

→ Page 162

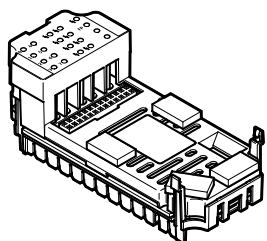

- Digital inputs
- 8 digital inputs
  - 11 function modes
  - 5 independent clock outputs

#### PROFIsafe shut-off module

→ Page 213

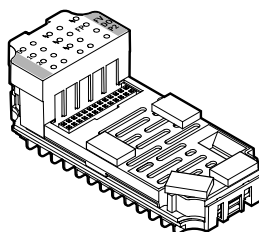

- Digital outputs
- 2 digital outputs
  - Supply voltage for valves can be shut off

## Peripherals overview

## Individual overview of modules

Analogue electronics module for pressure inputs

→ Page 199

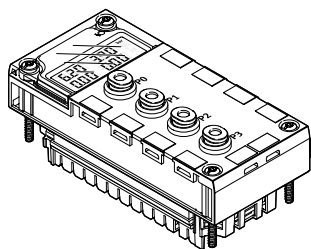

Analogue inputs

- 4 analogue pressure inputs (0 ... 10 bar, -1 ... +1 bar)

Plastic interlinking block – Interlinking using tie rods

→ Page 222

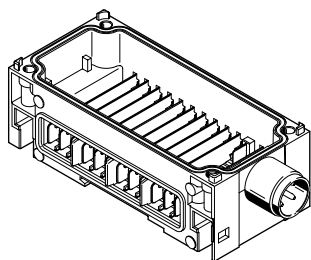

System linking

- Different voltages for supplying the modules
- Serial communication between the modules

System supply

- M18, 4-pin
- 7/8" 4-pin or 5-pin

In addition to system linking, power supply for the

- Electronics plus sensors (16 A)
- Valves plus actuators (16 A)

Additional supply

In addition to system linking, power supply for the

- Actuators (16 A per supply)

Power supply for the

- Valves (16 A per supply)

Expandability

- Can be expanded using an interlinking block with tie rod CPX-ZA-1-E

Metal interlinking block – Individual linking

→ Page 223

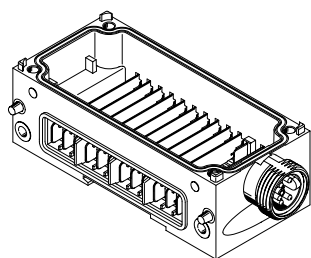

System linking

- Different voltages for supplying the modules
- Serial communication between the modules

System supply

- 7/8" 4-pin or 5-pin
- M12x1, L-coded, 5-pin
- AIDA push-pull

In addition to system linking, power supply for the

- Electronics plus sensors (16 A)
- Valves plus actuators (16 A)

Additional supply

In addition to system linking, power supply for the

- Actuators (16 A per supply)

Power supply for the

- Valves (16 A per supply)

System forwarding

In addition to system linking, transmission of power supply from the

- Electronics plus sensors (16 A)
- Valves plus actuators (16 A)

to a further CPX terminal or another consuming device.

Expandability

- Can be expanded as required by up to 10 interlinking blocks

-  - Note

Plastic interlinking blocks (tie rods) and metal interlinking blocks (individual linked) cannot be combined due to their different interlinking systems.

-  - Note

The 7/8" supply is subject to the following restrictions due to the available accessories:

- 5-pin 8 A
- 4-pin 10 A

-  - Note

Appropriate interlinking blocks (CPX-...-VL) must be used in ATEX environments as per the certification (→ page 49). The maximum supply is limited to 8 A for these modules.

## Peripherals overview

### Individual overview of modules

Pneumatic interface MPA-S

→ Page 239

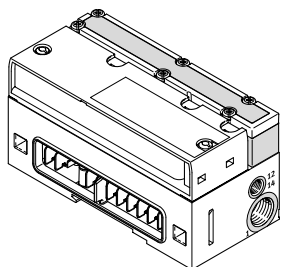

- Valve terminal
- MPA1 (360 l/min)
  - MPA14 (550 l/min)
  - MPA2 (700 l/min)
  - Up to 128 solenoid coils
  - Up to 16 modules can be configured
  - For CPX plastic design
  - For CPX metal design
  - Actuation of pressure sensors
  - Proportional pressure regulators
  - Pressure sensors
  - Proportional pressure regulators

Pneumatic interface MPA-L

→ Page 241

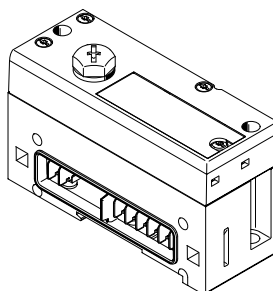

- Valve terminal
- MPA1 (360 l/min)
  - MPA14 (670 l/min)
  - MPA2 (870 l/min)
  - Up to 32 solenoid coils
  - For CPX plastic design

Pneumatic interface VTSA/VTSA-F

→ Page 242

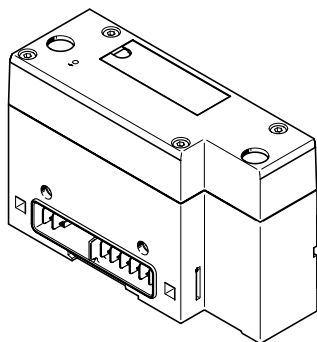

- Valve terminal (valve flow rate according to width)
- 18 mm (700 l/min)
  - 26 mm (1350 l/min)
  - 42 mm (1300 l/min)
  - 52 mm (2900 l/min)
  - 65 mm (4000 l/min)
  - Max. 32 valve positions/max. 32 solenoid coils
  - For CPX plastic design
  - For CPX metal design

Pneumatic interface VTSA-F-CB

→ Page 244

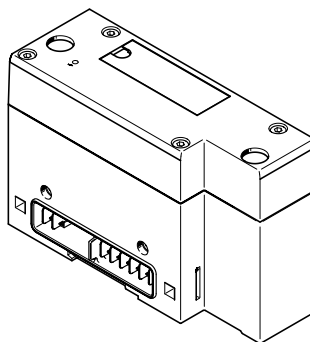

- Valve terminal (valve flow rate according to width)
- 18 mm (700 l/min)
  - 26 mm (1350 l/min)
  - 42 mm (1300 l/min)
  - 52 mm (2900 l/min)
  - Max. 24 valve positions/max. 24 solenoid coils
  - For CPX plastic design
  - For CPX metal design

Pneumatic interface VTSA-F-CB

→ Page 244

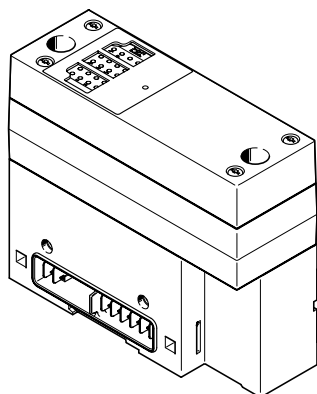

- Valve terminal (valve flow rate according to width)
- 18 mm (700 l/min)
  - 26 mm (1350 l/min)
  - 42 mm (1300 l/min)
  - 52 mm (2900 l/min)
  - Max. 24 valve positions/max. 24 solenoid coils
  - For CPX metal design
  - With 3 voltage zones within the valve terminal that can be securely shut down via fieldbus
  - With 2 voltage zones within the valve terminal that can be securely shut down via fieldbus and one power supply for external consuming devices that can be securely shut down via fieldbus

Pneumatic interface VTSA-F-CB

→ Page 244

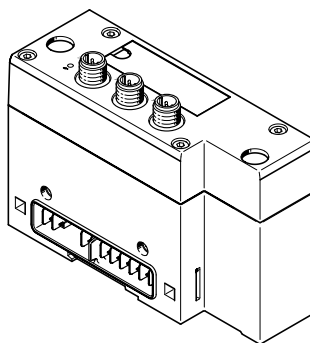

- Valve terminal (valve flow rate according to width)
- 18 mm (700 l/min)
  - 26 mm (1350 l/min)
  - 42 mm (1300 l/min)
  - 52 mm (2900 l/min)
  - Max. 24 valve positions/max. 24 solenoid coils
  - For CPX plastic design
  - For CPX metal design
  - 3 external voltage supplies for voltage zones within the valve terminal that can be shut down individually

## Peripherals overview

## Individual overview of modules

## End plate for plastic/metal design

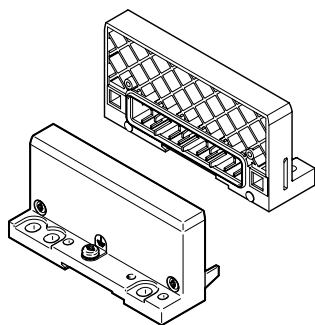

## End plate

- Left-hand
- Right-hand (for using the CPX terminal without valves)

## End plate with system supply

→ Page 218

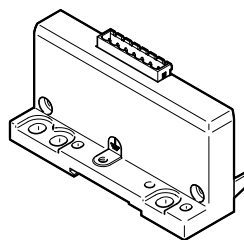

## End plate

- Left-hand
- For plastic design
- Different voltages for supplying the CPX terminal

## End plate with extension

→ Page 220

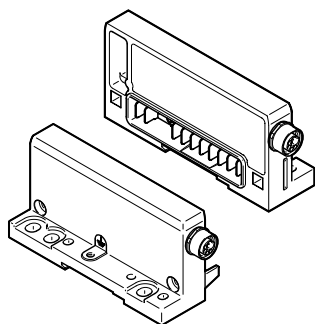

## End plate

- Left-hand
- Right-hand
- Enables the CPX terminal to be separated into two interconnected units (series)
- Simplifies control cabinet installation
- For plastic or metal design

## Earthing plate (for end plate for plastic design)

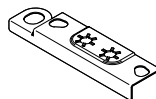

## Earthing plate

- For safe and easy connection to the machine bed or H-rail, suitable for right-hand and left-hand end plate
- Assembly and earthing in a single processing step, which means:
  - 50% time saving
  - No additional material required

## General basic data and guidelines

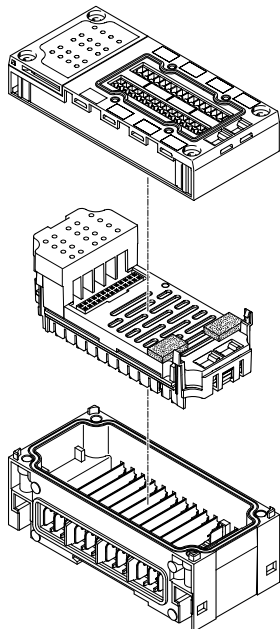

## Max. 11 modules in total:

- One bus node and/or one control block, freely positionable
- Up to 9 additional input/output modules, freely positionable
- An additional pneumatic interface always positioned as the last module on the right-hand side
  - For VTSA, VTSA-F: Fixed operating range, set using DIL switch
  - For VTSA-F-CB: Fixed operating range
  - For MPA-S: 16 MPA modules can be configured
  - For MPA-L: Fixed operating range, set using rotary switch
- Address capacity max. 512 inputs and 512 outputs, depending on bus node or control block
- One interlinking block with system supply
- Multiple interlinking blocks with additional supplies
  - Always positioned to the right of the interlinking block with system supply
- With just a few exceptions, the connection blocks can be freely combined with the electronics modules for inputs/outputs, either in metal or plastic design (→ table below)
- The electronics modules for inputs/outputs can be combined with various interlinking blocks

- Plastic interlinking blocks (tie rods) and metal interlinking blocks (individual linked) cannot be combined due to their different interlinking systems.

## Peripherals overview

Combinations of connection blocks and digital input modules						
	Digital electronics modules					
	CPX-4DE	CPX-8DE	CPX-8DE-D	CPX-8NDE	CPX-P-8DE-N	CPX-F8DE-P
<b>Connection blocks, plastic design</b>						
CPX-AB-8-M8-3POL	■	■	■	■	-	-
CPX-AB-8-M8X2-4POL	-	-	-	-	-	-
CPX-P-AB-4XM12-4POL	-	-	-	-	■	-
CPX-AB-4-M12x2-5POL	■	■	■	■	-	-
CPX-AB-4-M12x2-5POL-R	■	■	■	■	-	-
CPX-AB-8-M12X2-5POL	-	-	-	-	-	-
CPX-AB-4-M12-8POL	-	-	-	-	-	-
CPX-AB-8-KL-4POL	■	■	■	■	-	■
CPX-P-AB-2XKL-8POL	-	-	-	-	■	-
CPX-AB-1-SUB-BU-25POL	■	■	■	■	-	-
CPX-AB-4-HAR-4POL	■	■	■	■	-	-
CPX-AB-ID-P	-	-	-	-	-	■
<b>Connection blocks, metal design</b>						
CPX-M-AB-4-M12X2-5POL	■	■	■	■	-	■
CPX-M-AB-4-M12X2-5POL-T	-	-	-	-	-	■
CPX-M-AB-8-M12X2-5POL	-	-	-	-	-	-
<b>Combinations of connection blocks and digital input modules</b>						
	Digital electronics modules					
	CPX-16DE	CPX-L-16DE	CPX-M-16DE-D			
<b>Connection blocks, plastic design</b>						
CPX-AB-8-M8-3POL	-	-	-			
CPX-AB-8-M8X2-4POL	■	-	-			
CPX-P-AB-4XM12-4POL	-	-	-			
CPX-AB-4-M12x2-5POL	-	-	-			
CPX-AB-4-M12x2-5POL-R	-	-	-			
CPX-AB-8-M12X2-5POL	-	-	■			
CPX-AB-4-M12-8POL	-	-	-			
CPX-AB-8-KL-4POL	■	-	-			
CPX-P-AB-2XKL-8POL	-	-	-			
CPX-AB-1-SUB-BU-25POL	■	-	-			
CPX-AB-4-HAR-4POL	-	-	-			
CPX-AB-ID-P	-	-	-			
<b>Connection blocks, metal design</b>						
CPX-M-AB-4-M12X2-5POL	-	-	-			
CPX-M-AB-4-M12X2-5POL-T	-	-	-			
CPX-M-AB-8-M12X2-5POL	-	-	■			



## Peripherals overview

Combinations of connection blocks and digital output modules or multi I/O modules								
	Digital electronics modules							
	CPX-4DA	CPX-8DA	CPX-8DA-H	CPX-8DE-8DA	CPX-L-8DE-8DA	CPX-2ZE2DA	CPX-FVDA-P2	
<b>Connection blocks, plastic design</b>								
CPX-AB-8-M8-3POL	■	■	-	-	-	-	-	
CPX-AB-8-M8X2-4POL	■	■	■	-	-	-	-	
CPX-P-AB-4XM12-4POL	-	-	-	-	-	-	-	
CPX-AB-4-M12x2-5POL	■	■	-	-	-	-	-	
CPX-AB-4-M12x2-5POL-R	■	■	■	-	-	-	-	
CPX-AB-8-M12X2-5POL	-	-	-	-	-	-	-	
CPX-AB-4-M12-8POL	-	-	-	■	-	-	-	
CPX-AB-8-KL-4POL	■	■	■	■	-	-	■	
CPX-P-AB-2XKL-8POL	-	-	-	-	-	-	-	
CPX-AB-1-SUB-BU-25POL	■	■	■	■	-	-	-	
CPX-AB-4-HAR-4POL	■	■	-	-	-	-	-	
CPX-AB-ID-P	-	-	-	-	-	-	-	
<b>Connection blocks, metal design</b>								
CPX-M-AB-4-M12X2-5POL	■	■	■	-	-	-	■	
CPX-M-AB-4-M12X2-5POL-T	-	-	-	-	-	-	-	
CPX-M-AB-8-M12X2-5POL	-	-	-	-	-	-	-	
<b>Combinations of connection blocks and analogue electronics modules for inputs/outputs</b>								
	Analogue electronics modules							
	CPX-4AE-4AA-H	CPX-2AE-U-I	CPX-4AE-U-I	CPX-4AE-I	CPX-2AA-U-I	CPX-4AE-P	CPX-4AE-T	CPX-4AE-TC
<b>Connection blocks, plastic design</b>								
CPX-AB-8-M8-3POL	-	-	-	-	-	-	-	-
CPX-AB-8-M8X2-4POL	-	-	-	-	-	-	-	-
CPX-P-AB-4XM12-4POL	■	-	-	-	-	-	-	-
CPX-AB-4-M12x2-5POL	-	■	■	■	■	-	■	■
CPX-AB-4-M12x2-5POL-R	-	■	■	■	■	-	■	■
CPX-AB-8-M12X2-5POL	-	-	-	-	-	-	-	-
CPX-AB-4-M12-8POL	-	-	-	-	-	-	-	-
CPX-AB-8-KL-4POL	-	■	■	■	■	-	■	■
CPX-P-AB-2XKL-8POL	■	-	-	-	-	-	-	-
CPX-AB-1-SUB-BU-25POL	-	■	■	■	■	-	-	-
CPX-AB-4-HAR-4POL	-	-	-	-	-	-	■	-
CPX-AB-ID-P	-	-	-	-	-	-	-	-
<b>Connection blocks, metal design</b>								
CPX-M-AB-4-M12X2-5POL	-	■	■	■	■	-	■	■
CPX-M-AB-4-M12X2-5POL-T	-	-	-	-	-	-	-	-
CPX-M-AB-8-M12X2-5POL	-	-	-	-	-	-	-	-

## Key features – Electrical components

### Electrical connection – Connection block

CPX-AB-8-M8-3POL with connection socket M8, 3-pin

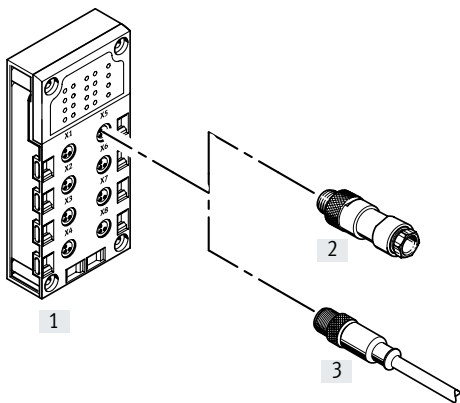

- Compact for pre-assembled individual connection
- 8 sockets
- 3-pin design for connecting one channel per socket



#### Note

Festo delivers pre-assembled M8/M12 connecting cables (NEBU modular system) on request:

- Tailored to the application
- Perfectly fitting
- Easy to install

Combination of connection block and electrical connection technology

Connection block	Connection technology	Plug/connecting cable	Connection technology
[1] CPX-AB-8-M8-3POL	Socket M8, 3-pin	[2] SEA-GS-M8	Solder lugs
		[2] SEA-3GS-M8-S	Screw terminals
		[3] NEBU-...-M8G3 (modular system for choice of connecting cables)	Socket, M8, 3-pin
			Socket, M8, 4-pin
			Socket, M12, 5-pin
		Open cable end	

## Key features – Electrical components

### Electrical connection – Connection block

CPX-AB-8-M8X2-4POL with connection socket M8, 4-pin

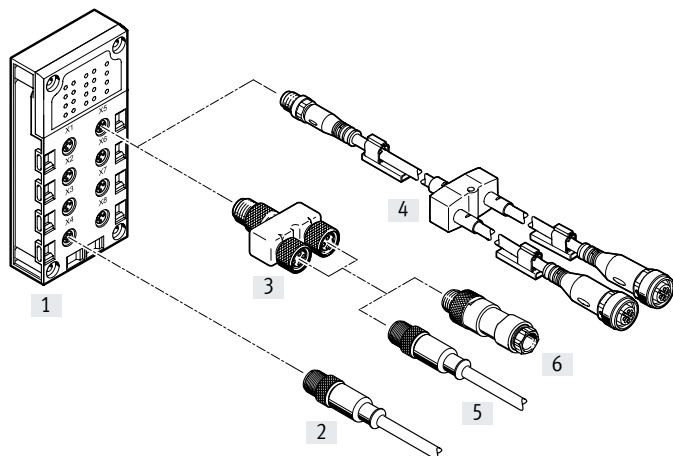

- Compact for pre-assembled individual connection
- 8 sockets
- 4-pin design for connection of 2 channels per socket

Combination of connection block and electrical connection technology

Connection block	Connection technology	Plug/connecting cable	Connection technology	Plug/connecting cable	Connection technology
[1] CPX-AB-8-M8X2-4POL	Socket, M8, 4-pin	[2] NEBU-...-M8G4 (modular system for choice of connecting cables)	Socket, M8, 3-pin	-	-
			Socket M8, 4-pin	-	-
			Socket, M12, 5-pin	-	-
			Open cable end	-	-
		[3] NEDY-L2R1-V1-M8G3-N-M8G4 (T-adapter)	1x plug M8, 4-pin to 2x socket, M8, 3-pin	[6] SEA-GS-M8	Solder lugs
				[6] SEA-3GS-M8-S	Screw terminals
				[5] NEBU-...-M8G3 (modular system for choice of connecting cables)	Socket, M8, 3-pin Socket, M8, 4-pin Socket, M12, 5-pin Open cable end
		[4]NEDY-... (modular system for all types of sensor/ actuator distributor)	2x socket, M8, 3-pin	-	-
			2x socket, M8, 4-pin	-	-
			2x socket, M12, 5-pin	-	-
			2x socket, type A	-	-
			2x socket, type B	-	-
			2x socket, type C	-	-
			2x socket, plug pattern H	-	-
			2x socket, plug pattern ZB	-	-
2x socket, plug pattern ZC	-	-			
2x open cable end	-	-			

## Key features – Electrical components

### Electrical connection – Connection block

CPX-AB-4-M12x2-5POL and CPX-AB-4-M12x2-5PPOL-R with connection socket M12, 5-pin

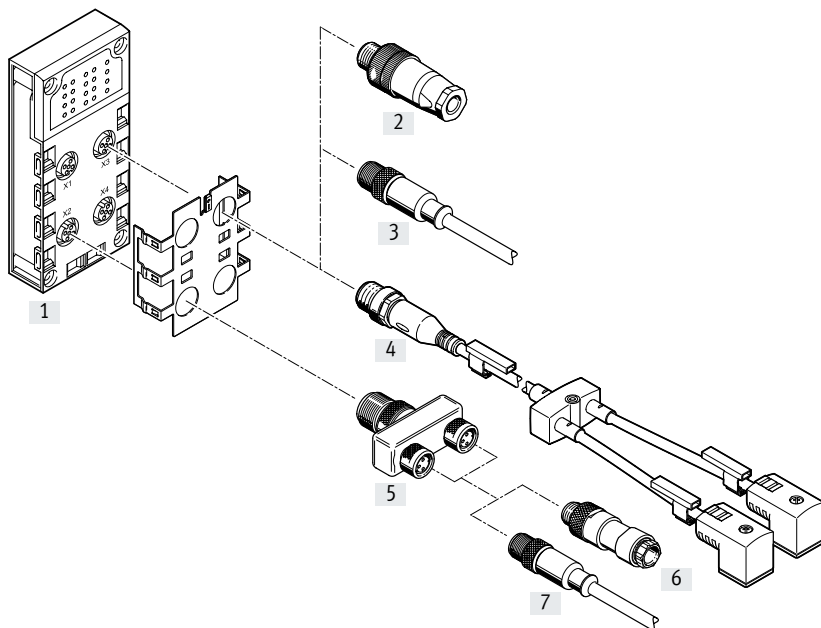

- Suitable for self-assembly and sturdy with 2 channels per connection
- 4 sockets
- 5-pin design per connection
- Version ...-R with quick lock technology and metal thread for shielding
- With two channels per connection, the corresponding input signals can be easily connected via a T-adapter and conventional cables with M8 connection.

## Key features – Electrical components

Combination of connection block and electrical connection technology					
Connection block	Connection technology	Plug/connecting cable	Connection technology	Plug/connecting cable	Connection technology
[1] CPX-AB-4-M12x2-5POL CPX-AB-4-M12x2-5POL-R	Socket, M12, 5-pin	[2] SEA-GS-7	Screw terminals	–	–
		[2] SEA-4GS-7-2.5	Screw terminals	–	–
		[2] SEA-GS-9	Screw terminals	–	–
		[2] SEA-M12-5GS-PG7	Screw terminals	–	–
		[2] SEA-GS-11-DUO	Screw terminals, for two cables	–	–
		[2] SEA-5GS-11-DUO	Screw terminals, for two cables	–	–
		[3] NEBU-...-M12G5 (modular system for choice of connecting cables)	Socket, M8, 4-pin Socket, M12, 5-pin Open cable end	– – –	– – –
		[4] NEDY-... (modular system for all types of sensor/actuator distributor)	2x socket, M8, 3-pin 2x socket, M8, 4-pin 2x socket, M12, 5-pin 2x socket, type A 2x socket, type B 2x socket, type C 2x socket, plug pattern H 2x socket, plug pattern ZB 2x socket, plug pattern ZC 2x open cable end	– – – – – – – – – –	– – – – – – – – – –
		[5] NEDY-L2R1-V1-M8G3-N-M12G4 (T-adapter)	Plug M12, 4-pin to 2x socket, M8, 3-pin	–	–
		[5] NEDY-L2R1-V1-M12G5-N-M12G4 (T-adapter)	Plug M12, 4-pin to 2x socket M12, 5-pin	–	–
				[6] SEA-GS-M8	Solder lugs
				[6] SEA-3GS-M8-S	Screw terminals
				[7] NEBU-...-M8G3 (modular system for choice of connecting cables)	Socket, M8, 3-pin Socket, M8, 4-pin Socket, M12, 5-pin Open cable end
				[6] SEA-GS-7	Screw terminals
				[6] SEA-4GS-7-2.5	Screw terminals
				[6] SEA-GS-9	Screw terminals
				[6] SEA-M12-5GS-PG7	Screw terminals
				[6] SEA-GS-11-DUO	Screw terminals, for two cables
				[6] SEA-5GS-11-DUO	Screw terminals, for two cables
				[7] NEBU-...-M12G5 (modular system for choice of connecting cables)	Socket, M8, 4-pin Socket, M12, 5-pin Open cable end

## Key features – Electrical components

### Electrical connection – Connection block (metal design)

CPX-M-AB-4-M12X2-5POL and CPX-M-AB-4-M12X2-5POL-T with connection socket M12, 5-pin

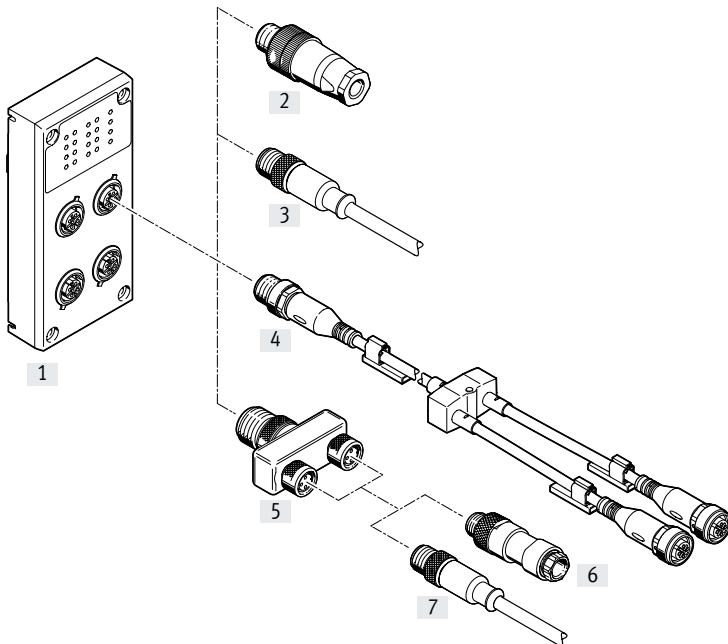

- Suitable for self-assembly and sturdy with 2 channels per connection
- 4 sockets
- 5-pin design per connection
- With two channels per connection, the corresponding input signals can be easily connected via a T-adaptor and conventional cables with M8 connection.

CPX-M-AB-8-M12X2-5POL and CPX-AB-8-M12X2-5POL with connection socket M12, 5-pin

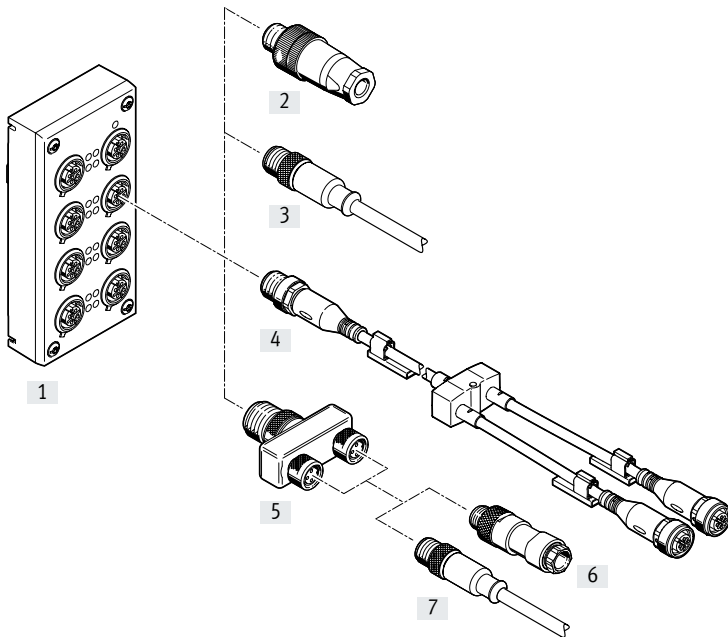

- Suitable for self-assembly and sturdy with 2 channels per connection
- 8 sockets
- 5-pin design per socket
- With two channels per connection, the corresponding input signals can be easily connected via a T-adaptor and conventional connecting cables with M8 connection.

 **Note**  
Max. 4 T-adapters (NEDY) can be mounted on a connection block.

## Key features – Electrical components

Combination of connection block and electrical connection technology					
Connection block	Connection technology	Plug/connecting cable	Connection technology	Plug/connecting cable	Connection technology
[1] CPX-M-AB-4-M12X2-5POL CPX-M-AB-4-M12X2-5POL-T CPX-M-AB-8-M12X2-5POL CPX-AB-8-M12X2-5POL	Socket, M12, 5-pin	[2] SEA-GS-7	Screw terminals	–	–
		[2] SEA-4GS-7-2.5	Screw terminals	–	–
		[2] SEA-GS-9	Screw terminals	–	–
		[2] SEA-M12-5GS-PG7	Screw terminals	–	–
		[2] SEA-GS-11-DUO	Screw terminals, for two cables	–	–
		[2] SEA-5GS-11-DUO	Screw terminals, for two cables	–	–
		[3] NEBU-...-M12G5	Socket, M8, 4-pin	–	–
		(modular system for choice of connecting cables)	Socket, M12, 5-pin	–	–
			Open cable end	–	–
		[4] NEDY-... (modular system for all types of sensor/ actuator distributor)	2x socket, M8, 3-pin	–	–
			2x socket, M8, 4-pin	–	–
			2x socket, M12, 5-pin	–	–
			2x socket, type A	–	–
			2x socket, type B	–	–
			2x socket, type C	–	–
			2x socket, plug pattern H	–	–
			2x socket, plug pattern ZB	–	–
			2x socket, plug pattern ZC	–	–
			2x open cable end	–	–
		[5] NEDY-L2R1-V1-M8G3-N-M12G4 (T-adapter)	Plug M12, 4-pin to 2x socket, M8, 3-pin	[6] SEA-GS-M8	Solder lugs
				[6] SEA-3GS-M8-S	Screw terminals
		[5] NEDY-L2R1-V1-M12G5-N-M12G4 (T-adapter)	Plug M12, 4-pin to 2x socket M12, 5-pin	[7] NEBU-...-M8G3 (modular system for choice of connecting cables)	Socket, M8, 3-pin
					Socket, M8, 4-pin
					Socket, M12, 5-pin
					Open cable end
				[6] SEA-GS-7	Screw terminals
				[6] SEA-4GS-7-2.5	Screw terminals
				[6] SEA-GS-9	Screw terminals
				[6] SEA-M12-5GS-PG7	Screw terminals
				[6] SEA-GS-11-DUO	Screw terminals, for two cables
				[6] SEA-5GS-11-DUO	Screw terminals, for two cables
[7] NEBU-...-M12G5 (modular system for choice of connecting cables)	Socket, M8, 4-pin				
	Socket, M12, 5-pin				
	Open cable end				

## Key features – Electrical components

### Electrical connection – Connection block with M12, 4-pin connection

CPX-P-AB-4XM12-4POL

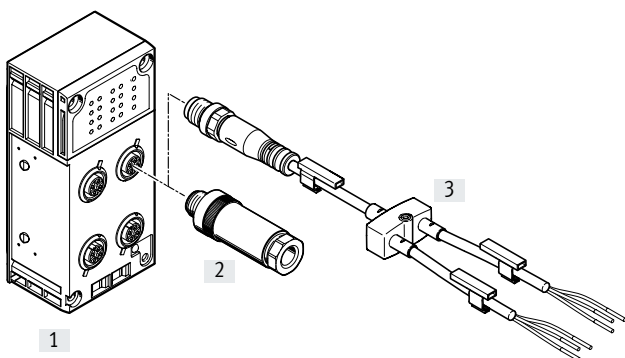

- Suitable for self-assembly and sturdy
- 4 sockets
- 4-pin design per connection

Combination of connection block and electrical connection technology

Connection block	Connection technology	Plug/connecting cable	Connection technology
[1] CPX-P-AB-4XM12-4POL	Socket, M12, 4-pin	[2] SEA-GS-HAR-4POL	Insulation displacement connector
		[2] SEA-4GS-7-2.5	Screw terminal
		[2] SEA-GS-7	Screw terminal
		[2] SEA-GS-9	Screw terminal
		[3] NEDY-... (modular system for all types of sensor/actuator distributor)	2x open cable end

### Electrical connection – Connection block with clamping connector

CPX-P-AB-2XKL-8POL

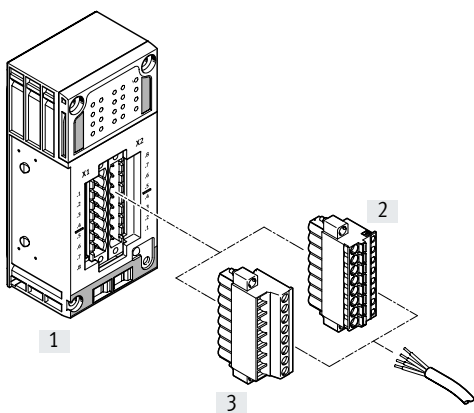

- Quick connection technology for use in control cabinets
- Spring-loaded terminals or screw terminals
- Wire cross sections 0.2 ... 2.5 mm<sup>2</sup>

Combination of connection block and electrical connection technology

Connection block	Connection technology	Plug/connecting cable	Connection technology
[1] CPX-P-AB-2XKL-8POL	Plug, 8-pin	[2] NECU-L3G8-C1	Spring-loaded terminals
		[3] NECU-L3G8-C2	Screw terminals



## Key features – Electrical components

## Electrical connection – Connection block

CPX-AB-4-M12-8POL with connection socket M12, 8-pin

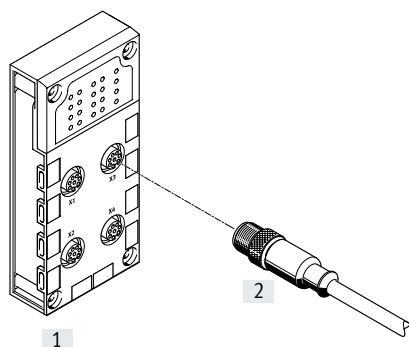

- Connection to cylinder/valve combinations with max. 3 inputs and 2 outputs
- 4 sockets
- 8-pin design per socket

## Combination of connection block and electrical connection technology

Connection block	Connection technology	Plug/connecting cable	Connection technology
[1] CPX-AB-4-M12-8POL	Socket, M12, 8-pin	[2] KM12-8GD8GS-2-PU (pre-assembled connecting cable)	Socket, M12, 8-pin

## CPX-AB-8-KL-4POL, CPX-2ZE2DA with spring-loaded terminal connection

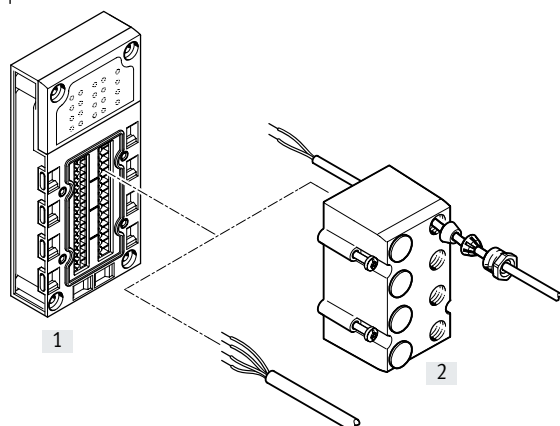

- Quick connection technology for use in control cabinets
- 32 spring-loaded terminals
- 4 spring-loaded terminals per channel
- Wire cross-sections 0.05 ... 1.5 mm<sup>2</sup>
- Optional cover with fittings for IP65, IP67 connection
  - 8 through-holes M9
  - 1 through-hole M16
  - Blanking plug
  - For I/O distributors, control desks or individual sensors/actuators

## Combination of connection block and electrical connection technology

Connection block	Connection technology	Plug/connecting cable	Connection technology
[1] CPX-AB-8-KL-4POL CPX-2ZE2DA	Spring-loaded terminals, 32-pin	[2] AK-8KL (cover)	–

## Key features – Electrical components

### Electrical connection – Connection block

CPX-AB-1-SUB-BU-25POL with Sub-D connection, 25-pin

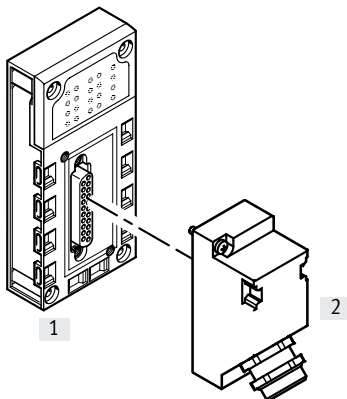

- Multi-pin connection for I/O distributor or control desk
- One socket
- 25-pin design

Combination of connection block and electrical connection technology

Connection block	Connection technology	Plug/connecting cable	Connection technology
[1] CPX-AB-1-SUB-BU-25POL	Sub-D socket, 25-pin	[2] SD-SUB-D-ST25	Crimp contacts

CPX-AB-4-HAR-4POL with quick connector

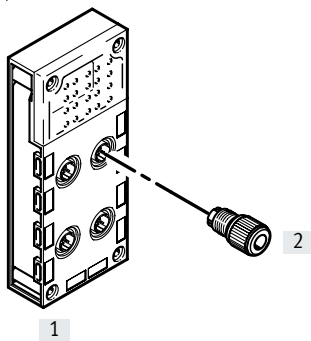

- Sturdy quick connection technology for individual connections
- 4 sockets
- 4-pin design per socket

Combination of connection block and electrical connection technology

Connection block	Connection technology	Plug/connecting cable	Connection technology
[1] CPX-AB-4-HAR-4POL	Socket, quick connector, 4-pin	[2] SEA-GS-HAR-4POL	Insulation displacement connectors

## Key features – Mounting

## Hood

Description

→ Page 254

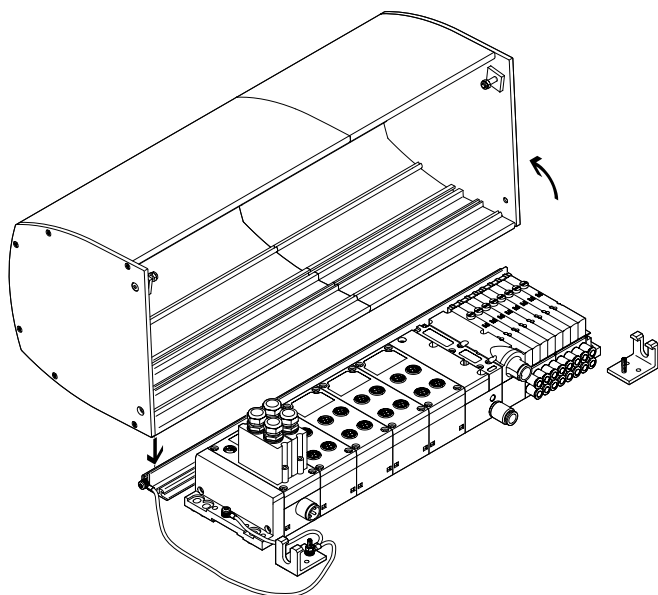

The CPX hood CAFC is a space- and cost-saving alternative to a control cabinet.

It is designed as an extruded aluminum profile and is installed on a mounting plate.

The valve terminal (CPX with MPA-S or MPA-L) is well protected and is quick to install without the need for complex cabinet through feed for connecting cables and tubing.

The rail and the two mounting brackets are mounted on a base plate. The hood is attached to the retaining rail and secured with two screws. There is also a stand-by position (latching of the hood in the open position).

The hood is locked using two side screws (which meet the requirements for a special lock in compliance with ATEX).

The CPX hood can be ordered online using the valve terminal configurator.

## Advantages of the CPX hood

- Impact protection (min. 7 J) for the modules underneath in combination with a suitable mounting plate provided by the user
- Protection against electrostatic discharge by using electrically conductive materials and the option of connecting an earth wire
- Protection against disconnection of live plugs (by securing the hood with at least one special fastener to EN 60079-0, 9.2 and 20)
- UV protection for the CPX and MPA modules underneath

## Points to note when using the CPX hood

- Only in combination with valve terminal MPA-S and MPA-L
- No bus nodes with push-pull connection (CPX-M-FB34, CPX-M-FB35, CPX-M-FB45)
- CPX power supply via angled plugs, no T plugs, no push-pull
- Electrical supply plate/additional supply only possible with angled plug
- No MPA vertical stacking
- Use of larger fittings (for tubing O.D. 12 mm and larger) only possible with the angled design
- Ducted exhaust air only with elbow connector
- The permissible ambient temperature range of the valve terminal is reduced by 5°C.

 **Note**

The CPX hood has no influence on the ATEX classification of the valve terminal or of the CPX terminal.

The CPX hood has no influence on the IP degree of protection of the valve terminal or of the CPX terminal.

The CPX hood does not protect against the effects of the weather in installations that are not in enclosed spaces.

## Key features – Mounting

### Hood Mounting

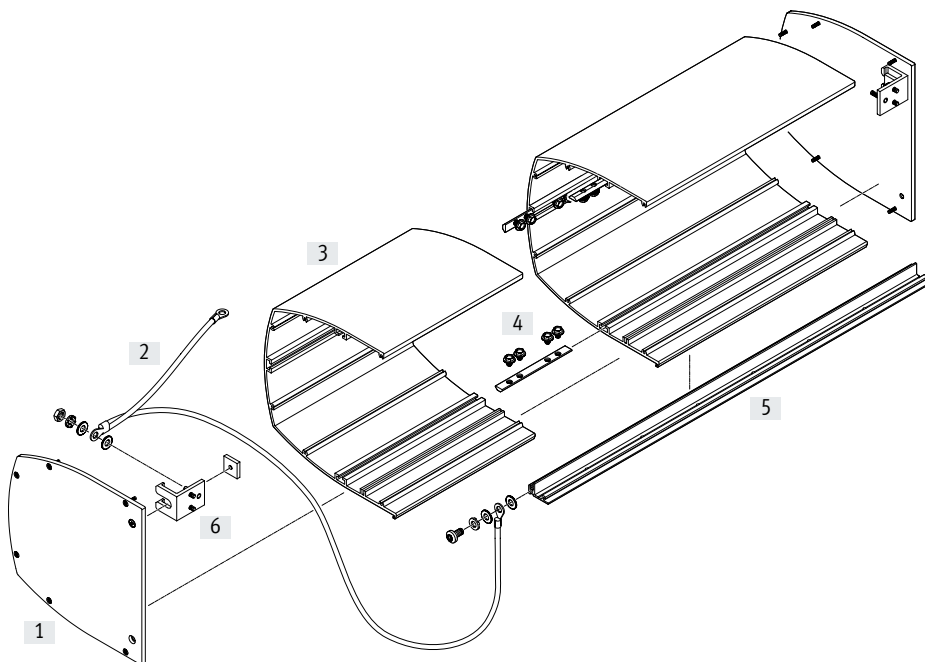

#### Procedure:

- Assemble the rail and mounting bracket included in the mounting kit
- Attach the earthing cable
- Assemble the hood (if applicable, screw together several hood sections and attach the side covers)
- Attach and secure the hood

- [1] Side cover
- [2] Earthing cable
- [3] Hood section
- [4] Slot nut with screws, for joining the hood sections
- [5] Rail
- [6] Mounting bracket

#### Technical data

##### Weight:

- Hood: approx. 500 g per 100 mm of length
- Mounting rail: approx. 550 g per 1000 mm of length
- Side pieces: approx. 500 g per side

- Ambient temperature –5 ... +50°C

- RoHS-compliant

#### Plug coding

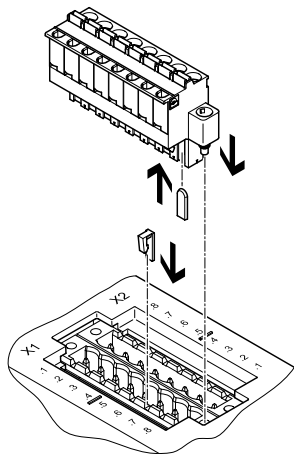

The connection block CPX-P-AB-2XKL-8POL and the sockets NECU-L3G8 can be matched to one another using the coding elements CPX-P-KDS-AB-2XKL.

This reduces the possibility of the socket being plugged back into an incorrect slot after being disconnected from the CPX terminal (connection safeguard).

## Key features – Mounting

### Extension

#### Functional principle

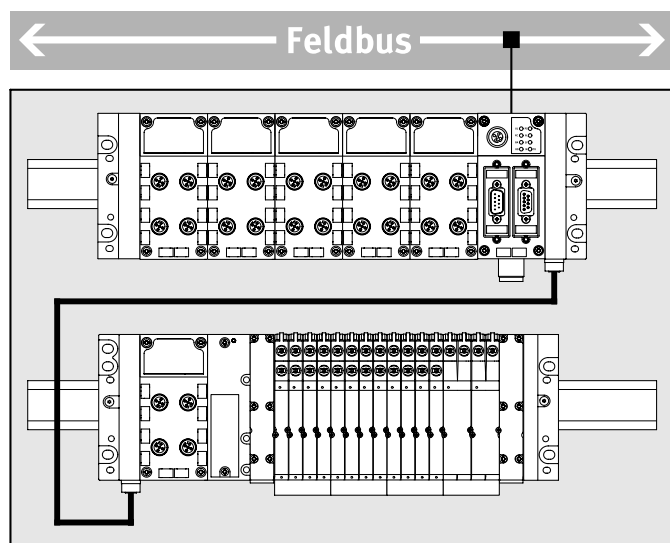

The extension enables the CPX terminal to be separated into or configured as two interconnected units (series). The two parts are controlled by a common bus node or control block. A comprehensive CPX terminal can fit into limited installation spaces more easily as two more compact units.

#### Applications:

- Installation in a control cabinet on two levels, one beneath the other
- Installation in two separate control cabinets
- Installation of part of the CPX terminal inside and part outside the control cabinet
- Spatial separation of electrics and pneumatics

#### Performance limits

- A maximum of 10 CPX modules can be installed in the first row
  - A maximum of 8 CPX modules and a pneumatic interface can be installed in the second row
- The number of CPX modules and solenoid coils is also limited by:
- the address space made available by the control block/bus node
  - their address requirement
  - their current consumption

#### Optimisation

- The maximum possible performance or maximum number of modules can only be achieved if the following conditions are observed:
- The control block/bus node is installed in the first row, on the far right, on an interlinking block with system supply
  - The connecting cable between the first and second row is max. 2 m long
  - An interlinking block with additional supply for valves is situated in the second row

#### Configuration rules

- The extension limits the power supply for the sensors and electronics for the CPX terminal as a whole as follows:
- First row max. 6 A
  - Second row max. 2 A
  - First and second row together, max. 6 A
- If the 3 m connecting cable is used, the following restrictions apply:
- There can only be one CPX module in the second row
  - An additional supply for valves is required in order to connect a valve terminal
- When positioning output modules in the second row, a corresponding power supply in the second row is required:
- Install an interlinking block with additional supply for outputs in the second row to the left of the first output module

## Key features – Mounting

Extension – Permissible CPX modules	Type	First row	Second row
Control blocks	CPX-CEC	Permissible, at least one control block or bus node required	Not permissible
Bus node	CPX-FB CPX-M-FB	Permissible, at least one control block or bus node required	Not permissible
Gateway	CPX-IOT	Not permissible	Not permissible
Technology modules	CPX-CP CPX-CTEL CPX-CTEL-2 CPX-CM-HPP CPX-CMAX CPX-CMPX CPX-CMIX	Permissible	Not permissible
Input/output modules	CPX	Permissible	Permissible
PROFIsafe shut-off module	CPX-FVDA-P2	Not permissible	Not permissible
Interlinking block/end plate with system supply	CPX-EPL-EV-S CPX-GE-EV-S CPX-M-GE-EV-S	Permissible, at least one interlinking block/end plate with system supply required	Not permissible
Interlinking block with additional supply	CPX-GE-EV-Z CPX-M-GE-EV-Z CPX-GE-EV-V	Permissible	Permissible
Interlinking block without power supply	CPX-GE-EV CPX-M-GE-EV	Permissible	Permissible
Interlinking block with system forwarding	CPX-M-GE-EV-W	Not permissible	Not permissible
Pneumatic interface	VMPA-FB	Not permissible	Permissible
	VMPAL-EPL-CPX	Not permissible	Permissible
	VABA-S6-1	Not permissible	Permissible
	VABA-S6-1...CB	Not permissible	Not permissible

## Key features – Mounting

Extension – Maximum number of CPX modules/solenoid coils		
Special features of the design	First row	Second row
<b>CPX terminal with valve terminal</b>		
Connecting cable 3 m	10 CPX modules	Valve terminal MPA-S with: <ul style="list-style-type: none"> <li>• Pneumatic interface for CPX metal interlinking module</li> <li>• Electrical supply plate VMPA-FB-SP directly after the pneumatic interface</li> <li>• Electronics modules with galvanic isolation</li> <li>• 128 solenoid coils (64 valve positions)</li> </ul>
		Valve terminal VTSA/VTSA-F with: <ul style="list-style-type: none"> <li>• 1 CPX module with interlinking block with additional supply for valves</li> <li>• 32 solenoid coils (32 valve positions)</li> </ul>
<b>CPX terminal without valve terminal</b>		
• Control block/bus node not in position on the far right of the first row	10 CPX modules	• 2 ... 5 CPX modules, depending on the control block/bus node used
• Control block/bus node in position on the far right of the first row	10 CPX modules	• 4 ... 8 CPX modules, depending on the control block/bus node used
<b>CPX terminal with valve terminal MPA-S</b>		
–	10 CPX modules	• 2 ... 5 CPX modules and connection blocks MPA-S, depending on the control block/bus node used
• Electrical supply plates VMPA-FB-SP • Electronics modules with galvanic isolation	10 CPX modules	• 2 ... 5 CPX modules, depending on the control block/bus node used • Up to 128 solenoid coils (64 valve positions)
• Control block/bus node in position on the far right of the first row • CPX-FB11 or CPX-CEC not possible	10 CPX modules	• 4 ... 5 CPX modules and connection blocks MPA-S, depending on the control block/bus node used
• CPX-FB13 or CPX-FB36 • Control block/bus node in position on the far right of the first row • Interlinking block with system supply in position on the far right of the first row	10 CPX modules	• 8 CPX modules and connection blocks MPA-S
• CPX-FB13 or CPX-FB36 • Control block/bus node in position on the far right of the first row • Interlinking block with additional supply for valves in position on the far right of the first row	10 CPX modules	• 8 CPX modules and connection blocks MPA-S
• CPX-FB13 or CPX-FB36 • Control block/bus node in position on the far right of the first row • Interlinking block with additional supply for valves in second row	10 CPX modules	• 8 CPX modules and connection blocks MPA-S

## Key features – Mounting

Extension – Maximum number of CPX modules/solenoid coils Special features of the design	First row	Second row
<b>CPX terminal with valve terminal MPA-L</b>		
–	10 CPX modules	<ul style="list-style-type: none"> <li>• 2 CPX modules (at least one CPX module required)</li> <li>• 16 solenoid coils (valve widths 10 mm and 14 mm) or 8 solenoid coils (valve width 20 mm)</li> </ul>
• Interlinking block with additional supply for valves in second row	10 CPX modules	<ul style="list-style-type: none"> <li>• 2 CPX modules (at least one CPX module required)</li> <li>• 32 solenoid coils (32 valve positions)</li> </ul>
<b>CPX terminal with valve terminal VTSA/VTSA-F</b>		
–	10 CPX modules	<ul style="list-style-type: none"> <li>• 2 CPX modules</li> <li>• 12 solenoid coils (valve widths 18 mm, 26 mm and 42 mm) or 6 solenoid coils (valve widths 52 mm and 65 mm)</li> </ul>
• Interlinking block with additional supply for valves in second row	10 CPX modules	<ul style="list-style-type: none"> <li>• 2 CPX modules</li> <li>• 32 solenoid coils (32 valve positions)</li> </ul>



## Key features – Mounting

### Mounting options

Valve terminals with CPX terminal support different mounting options for direct machine mounting with a high degree of protection and control cabinet installation.

#### H-rail mounting

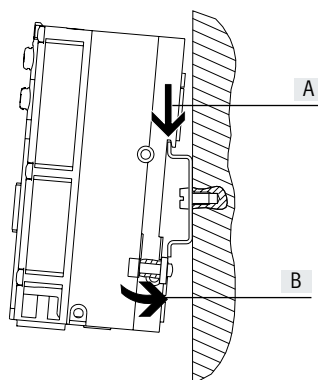

The H-rail mounting is part of the rear profile of the CPX interlinking blocks. The CPX terminal can be attached to the H-rail using the H-rail mounting kit. The CPX terminal is first hooked onto the H-rail (see arrow [A]),

then swivelled onto the H-rail and secured in place with the clamping element (see arrow [B]).

The optional earthing plate enables a connection to be established to the machine potential/earth in one easy step.

The following mounting kit is needed for H-rail mounting:

- CPX-CPA-BG-NRH

This facilitates mounting of the CPX terminal on H-rails to EN 60715.

An additional mounting kit may be required for combination with valve terminals.

#### Wall mounting

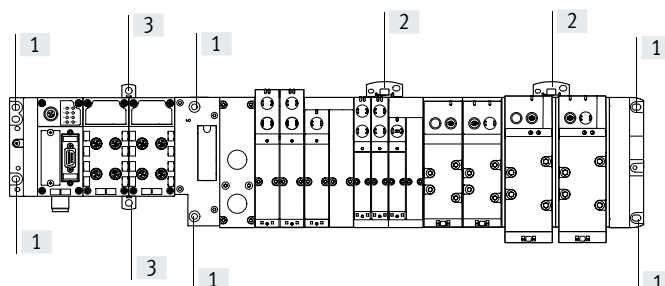

The end plates of the CPX terminal, the valve terminal and the pneumatic interface include mounting holes [1] for wall mounting. Additional mountings [2] for the CPX terminal are available for longer valve terminals.

These mountings differ depending on the design of the CPX terminal (plastic or metal).

In the case of 4 and more interlinking blocks, additional wall mountings must be used every 100 ...150 mm:

- Type CPX-M-BG-RW (metal design). These wall mountings are screwed in at the top on the CPX module.
- Type CPX-BG-RW (plastic design). These wall mountings are hooked in at the top and bottom between the CPX modules.

## Key features – Mounting

### CPX terminal in plastic design

Additional mountings

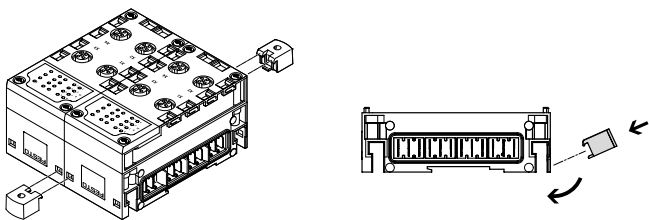

For longer valve terminals, there are additional mounting components for the CPX terminal that can be fitted between two modules.

#### Note

For CPX terminals with 4 or more interlinking blocks, you need additional mounting components of type CPX-BG-RW every 100 or 150 mm. These are supplied pre-assembled.

### Interlinking with tie rods

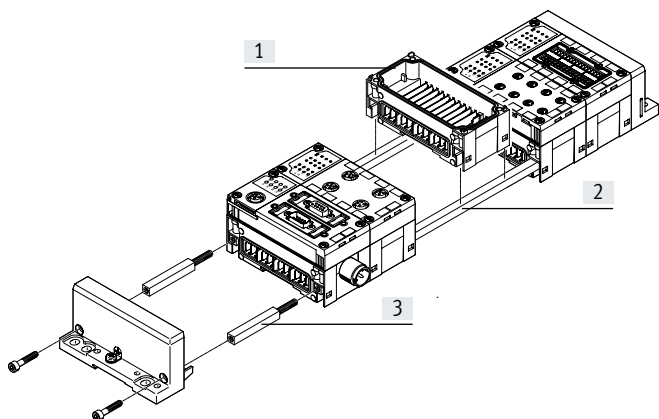

The mechanical connection between the CPX modules is created using special tie rods [2]. The entire unit can be assembled using two screws in the end plates.

The tie rod ensures that the unit has a high mechanical load-bearing capacity and is therefore the mechanical “backbone” of the CPX terminal.

The open design allows interlinking blocks [1] to be replaced when already mounted.

With the tie rod extension kit [3] an extra module can be added to the CPX terminal.

### CPX terminal in metal design

Additional mountings

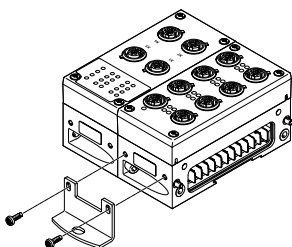

For longer valve terminals, there are additional mounting brackets for the CPX terminal that can be screwed onto the interlinking blocks.

The mounting bracket CPX-M-BG-VT-2X enables a CPX terminal with valve terminal VTSA/VTSA-F/VTSA-F-CB to be mounted on a support system.

#### Note

In the case of CPX terminals with 4 or more interlinking blocks, additional mounting brackets of the type CPX-M-BG-RW must be used every 100 or 150 mm. These are supplied pre-assembled.

### Linking with screws

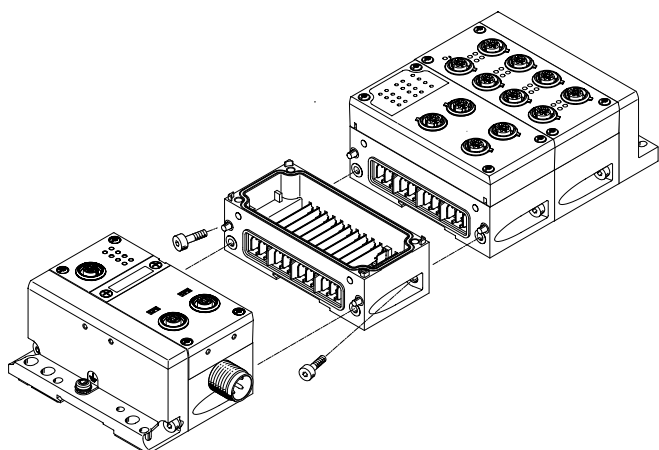

The CPX modules are mechanically connected using an angled fitting. The CPX terminal can thus be expanded at any time.

## Key features – Power supply

## Power supply concept

General

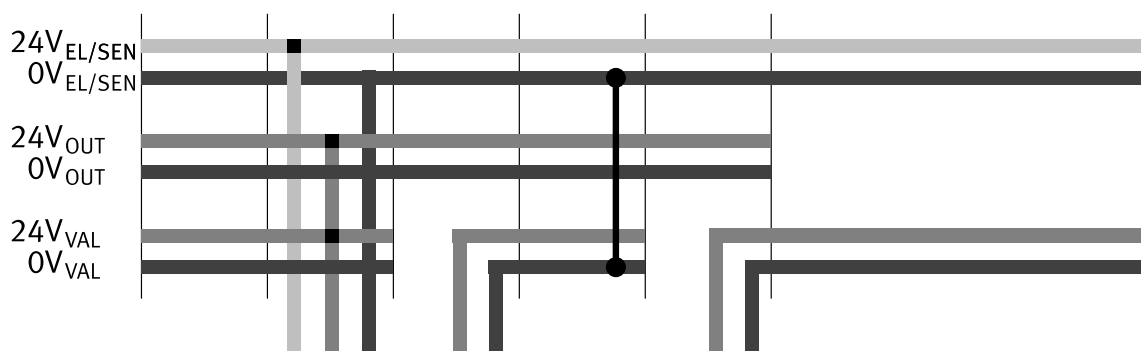
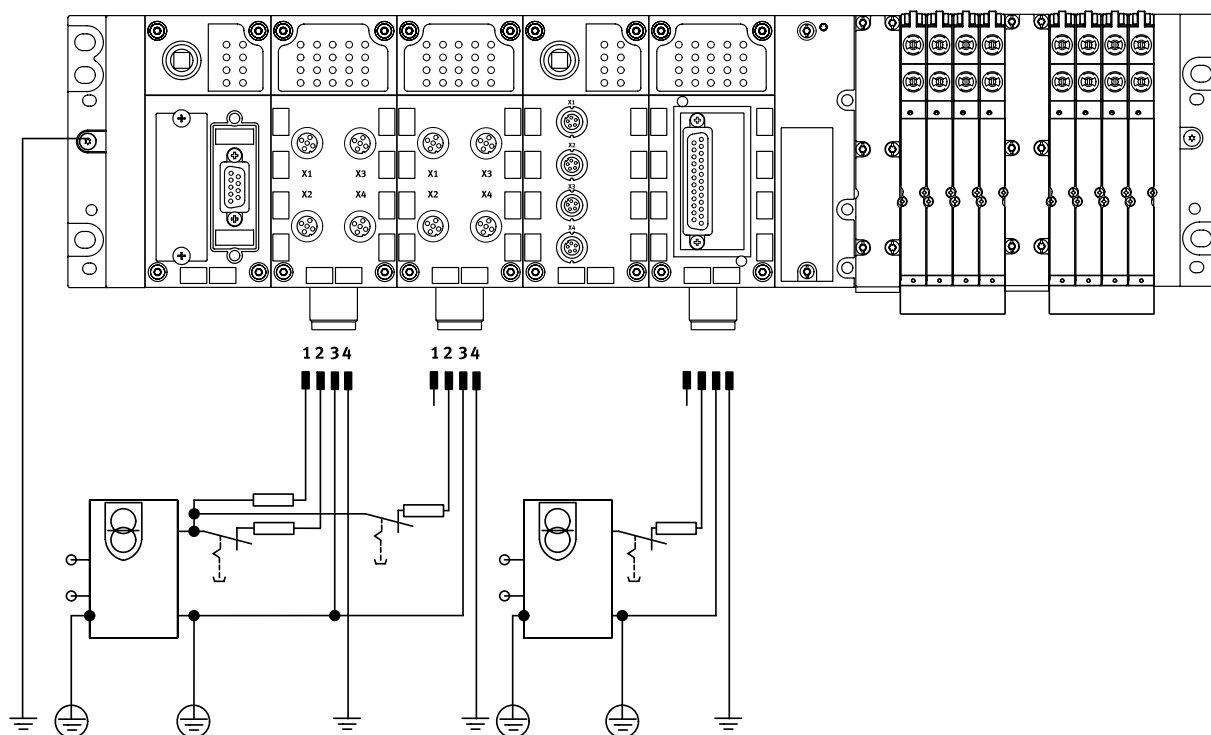

The use of decentralised devices on the fieldbus – particularly with a high degree of protection for direct machine mounting – demands a flexible power supply concept.

A valve terminal with CPX is, in principle, supplied with all voltages via a single connection.

A distinction is made between the supply for

- Electronics plus sensors
- Valves plus actuators

in this case.

Selectable connection technology:

- M18
- 7/8"
- M12x1
- AIDA push-pull

## Interlinking blocks

Interlinking blocks represent the backbone of the CPX terminal with all supply lines. They provide the power supply for the modules used on them as well as their bus connections.

Many applications require the CPX terminal to be separated into voltage zones. This applies in particular to the separate disconnection of solenoid coils and outputs.

The interlinking blocks provide either an easy-to-install central power supply for the entire CPX terminal or galvanically isolated, all-pin disconnectable potential groups/voltage segments.

## Key features – Power supply

## Interlinking blocks

## With system supply

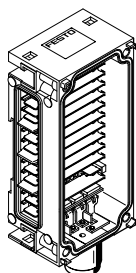

## Plastic design

- CPX-GE-EV-S
- CPX-GE-EV-S-7/8-4POL
- CPX-GE-EV-S-7/8-5POL

## Metal design

- CPX-M-GE-EV-S-7/8-CIP-4P
- CPX-M-GE-EV-S-7/8-5POL
- CPX-M-GE-EV-S-M12-5POL
- CPX-M-GE-EV-S-PP-5POL

## Connection technology

- M18, 4-pin
- 7/8" 4-pin
- 7/8" 5-pin

## Connection technology

- 7/8" 4-pin
- 7/8" 5-pin
- M12x1, L-coded, 5-pin
- AIDA push-pull, 5-pin

## Power supply

- For CPX terminal modules and connected sensors
- For valves that are connected to the CPX terminal via a pneumatic interface
- For actuators that are connected to the output modules of the CPX terminal

## Without power supply

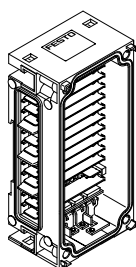

## Plastic design

- CPX-GE-EV

## Metal design

- CPX-M-GE-EV
- CPX-M-GE-EV-FVO

-

-

-

## With additional supply for outputs

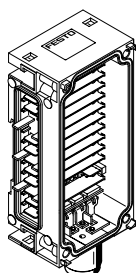

## Plastic design

- CPX-GE-EV-Z
- CPX-GE-EV-Z-7/8-4POL
- CPX-GE-EV-Z-7/8-5POL

## Metal design

- CPX-M-GE-EV-Z-7/8-5POL
- CPX-M-GE-EV-Z-PP-5POL

## Connection technology

- M18, 4-pin
- 7/8" 4-pin
- 7/8" 5-pin

## Connection technology

- 7/8" 5-pin
- AIDA push-pull, 5-pin

## Power supply

- For actuators that are connected to output modules of the CPX terminal

## With additional supply for valves

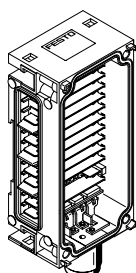

## Plastic design

- CPX-GE-EV-V
- CPX-GE-EV-V-7/8-4POL

## Connection technology

- M18, 4-pin
- 7/8" 4-pin

## Power supply

- For valves that are connected to the CPX terminal via a pneumatic interface

 **Note**  
For 7/8":

- Commercially available accessories are often limited to max. 8 A

 **Note**

The valve terminal MPA-S has either a 7/8" 5-pin, 7/8" 4-pin, 3-pin M18 or 5-pin AIDA push-pull power supply for one or more valve voltage zones. Galvanically isolated, all-pin disconnectable with voltage monitoring in the following MPA module.

 **Note**

Suitable versions of the interlinking blocks with M18 and 7/8", 5-pin connection are available (CPX-GE-EV-...-VL and CPX-M-GE-EV-...-VL) for use in ATEX environments as per certification (→ page 49). The maximum current supply for these interlinking blocks is 8 A.

## Key features – Power supply

### Interlinking blocks

With system forwarding

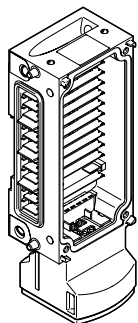

#### Metal design

- CPX-M-GE-EV-W-M12-5POL

#### Connection technology

- M12x1, L-coded, 5-pin

#### Voltage transmission

- For a further CPX terminal

## Key features – Diagnostics

### Diagnostics

System performance

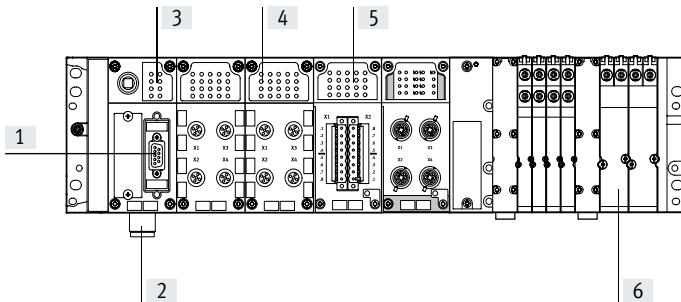

- [1] Diagnostics via bus interface
- [2] Undervoltage monitoring
- [3] Diagnostic overview LED
  - Fieldbus status
  - CPX status
- [4] Status and diagnostic LED for module and I/O channels
- [5] Module and channel-specific diagnostics
- [6] Valve-specific diagnostic module and solenoid coils
- [7] MPA pressure sensor – integrated solution on the fieldbus
  - Pre-assembled for channels 1, 3, 5 and external pressures

Detailed diagnostic functions are needed in order to quickly locate the causes of errors in the electrical installation and therefore reduce downtimes in production plants.

A basic distinction is made between on-the-spot diagnostics using LEDs or a diagnostic interface and diagnostics using a bus interface.

The CPX terminal supports on-the-spot diagnostics via a row of LEDs. This is separate from the connection area and therefore provides good visual access to status and diagnostic information.

Module and channel-specific diagnostics are supported, for example:

- Undervoltage detection for outputs and valves
- Short circuit detection for sensors, outputs and valves
- Open-load detection for a missing solenoid coil
- Storage of the last 40 causes of errors with error start and error end

The diagnostic messages can be read out via the bus interface in the higher-order controller and visualised for the central recording and evaluation of error causes. This is done using the individual fieldbus-specific channels. CPX-CECs also offer the option of access via the integrated Ethernet interface (remote maintenance via PC/web applications).

### Overview of LEDs on the bus node

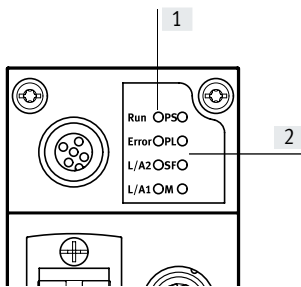

[1] Fieldbus-specific LEDs  
On each bus node, a maximum of 4 fieldbus-specific LEDs display the fieldbus communication status of the CPX terminal with the higher-order controller.

[2] CPX-specific LEDs  
A further 4 CPX-specific LEDs provide non-fieldbus-specific information about the status of the CPX terminal, for example:

- Power system
- Power load
- System fault
- Modify parameters

### Input/output module status and diagnostic LEDs

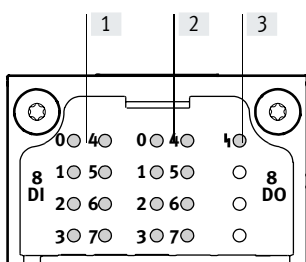

[1] Status LEDs for the inputs and outputs  
Each input and output channel is assigned a status LED.

[2] Channel-oriented diagnostic LEDs  
Depending on the module design, another diagnostic LED is available for each I/O channel

[3] Group diagnostic LEDs  
An LED displays the group diagnostics for each module

## Key features – Diagnostics

### Diagnostics

Display on a PC

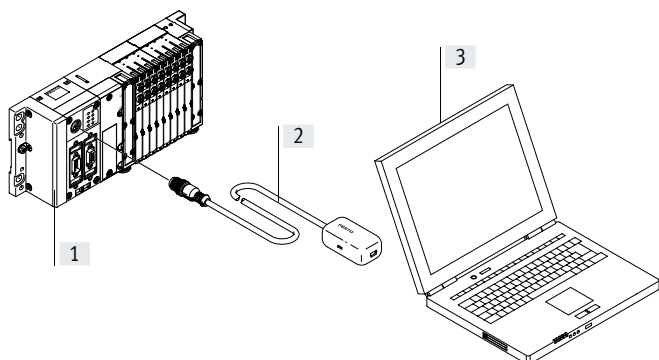

- [1] CPX terminal with valve terminal
- [2] Adapter diagnostic interface to USB
- [3] Laptop/portable device with USB interface and installed FMT software
  - Fault location and type
  - Without programming
  - Storing the configuration
  - Preparing screenshots

### Data gathering via gateway

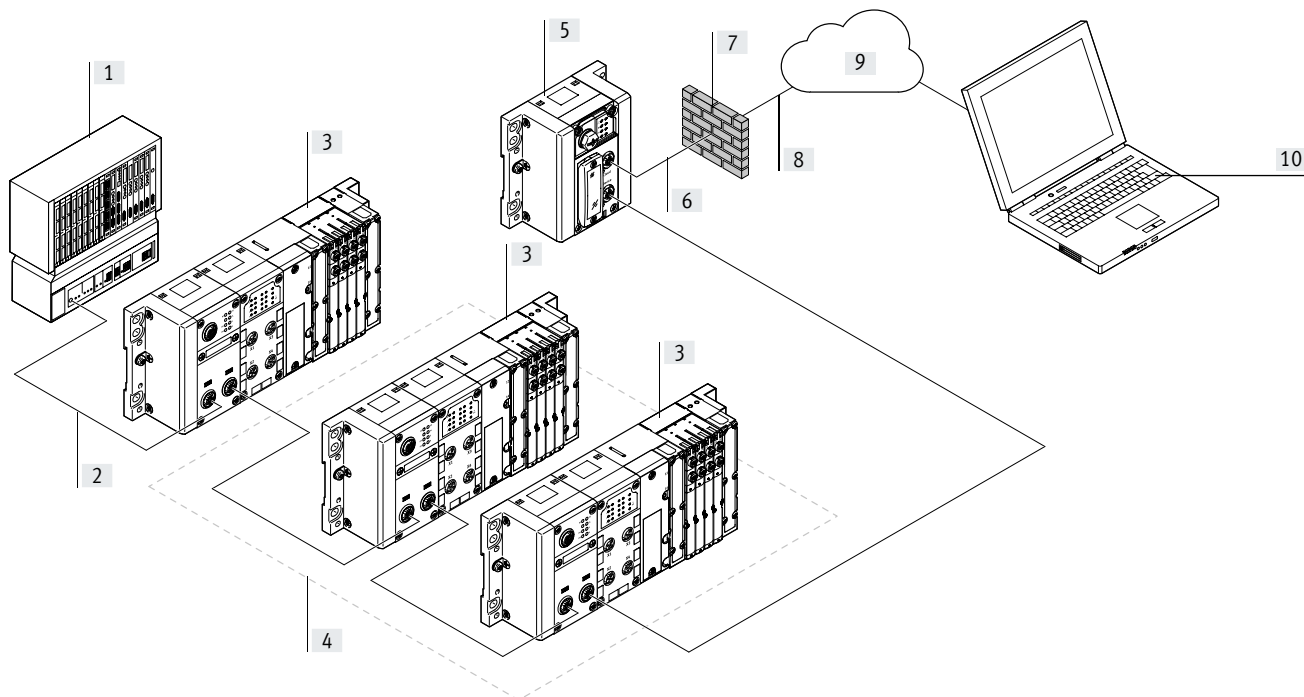

- [1] PLC to machine/system controller (no direct internet connection)
- [2] Bus system from the controller to the system parts (e.g. PROFINET)
- [3] Festo components with bus connection with serial linking
- [4] Components from which the CPX-IOT is collecting and transferring data
- [5] Gateway CPX-IOT
- [6] Internet connection
- [7] Customer firewall or other security precautions
- [8] Transferring data to a central storage location (MQTT broker) using secure protocols
- [9] Central storage location (user-specific MQTT broker) provided by Festo
- [10] Simple decentralised evaluation of data using adapted programs (apps) for the components that are being monitored

## Key features – Parameterisation

## Parameterisation

Changes to the application are often required during commissioning. The parameterisable characteristics of the CPX modules mean that functions can be very easily changed using configuration software. This reduces the number of modules needed and, consequently, the amount of storage space required.

It is therefore possible, for example, to reduce the input debounce time for an input module – normally 3 ms – to 0.1 ms on a "fast" input module for faster processes, or to set the response of a valve following a fieldbus interruption.

Depending on the modules used, parameterisation can be carried out via the following interfaces:

- Ethernet
- Fieldbus
- Control block direct interface (programming interface)

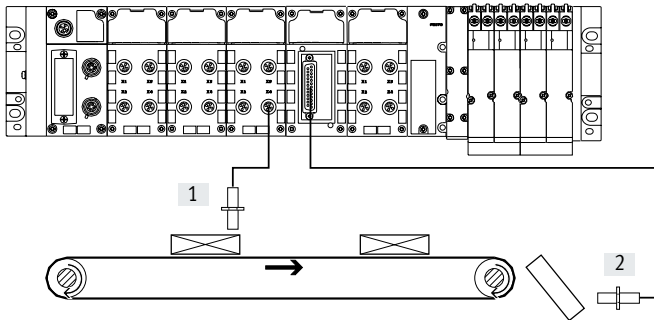

- [1] Input debounce time 3 ms  
[2] Input debounce time 0.1 ms



## Key features – Addressing

## Addressing

The various CPX modules occupy a different number of I/O addresses within the CPX system. The maximum address space for bus nodes depends on the performance of the fieldbus systems.

Maximum system configuration:

- 1 bus node or control block
- 9 I/O modules
- 1 pneumatic interface (e.g. pneumatic interface MPA-S with up to 16 MPA connection blocks)

The maximum system configuration can be limited in individual cases by exceeding the address space.



## Note

Please refer to the detailed description of the configuration/addressing rules in the technical data for CPX bus nodes.

## Overview – Address space for CPX bus node and control block

	Protocol	Max. total		Max. digital		Max. analogue	
		Inputs	Outputs	Inputs	Outputs	Inputs	Outputs
CPX-CEC	<ul style="list-style-type: none"> <li>• CODESYS Level 2</li> <li>• TCP/IP</li> <li>• Easy IP</li> <li>• Modbus TCP</li> </ul>	512 bits	512 bits	512 DI	512 DO	32 AI	18 AO
CPX-FB6	INTERBUS	96 bits	96 bits	96 DI	96 DO	6 AI	6 AO
CPX-FB11	DeviceNet	512 bits	512 bits	512 DI	512 DO	32 AI	18 AO
CPX-FB13	PROFIBUS	512 bits	512 bits	512 DI	512 DO	32 AI	18 AO
CPX-FB14	CANopen	256 bits	256 bits	64 DI (+ 64 DI)	64 DO (+ 64 DO)	8 AI (+ 8 AI)	8 AO (+ 8 AO)
CPX-M-FB21	INTERBUS (FOC)	96 bits	96 bits	96 DI	96 DO	6 AI	6 AO
CPX-FB23-24	CC-Link	512 bits	512 bits	512 DI	512 DO	32 AI	18 AO
CPX-FB33	PROFINET RT	512 bits	512 bits	512 DI	512 DO	32 AI	18 AO
CPX-M-FB34	PROFINET RT	512 bits	512 bits	512 DI	512 DO	32 AI	18 AO
CPX-M-FB35	PROFINET RT	512 bits	512 bits	512 DI	512 DO	32 AI	18 AO
CPX-FB36	EtherNet/IP	512 bits	512 bits	512 DI	512 DO	32 AI	18 AO
CPX-FB37	EtherCAT	512 bits	512 bits	512 DI	512 DO	32 AI	18 AO
CPX-FB39	Sercos III	512 bits	512 bits	512 DI	512 DO	32 AI	18 AO
CPX-FB40	POWERLINK	512 bits	512 bits	512 DI	512 DO	32 AI	18 AO
CPX-FB43	PROFINET RT	512 bits	512 bits	512 DI	512 DO	32 AI	18 AO
CPX-M-FB44	PROFINET RT	512 bits	512 bits	512 DI	512 DO	32 AI	18 AO
CPX-M-FB45	PROFINET RT	512 bits	512 bits	512 DI	512 DO	32 AI	18 AO

## Note

The bandwidth of the bus nodes can be restricted by the choice of module and the maximum number of modules.

## Example – CPX-FB6 (INTERBUS)

	Digital inputs	Digital outputs	Remarks
3x CPX-8DE	24	–	<ul style="list-style-type: none"> <li>• The address space is occupied by 7 CPX I/O modules plus pneumatic interface</li> <li>• No additional modules can be configured</li> </ul>
1x CPX-8DE-8DA	8	8	
2x CPX-2AE	64	–	
1x CPX-2AA	–	32	
3x VMPA1	–	24	
Allocated address space	96	96	

DI = Digital inputs (1 bit)

DO = Digital outputs (1 bit)

AO = Analogue outputs (16 bits)

AI = Analogue inputs (16 bits)

## Key features – Addressing

Overview – Allocated addresses for CPX modules		
	Inputs [bit]	Outputs [bit]
CPX-CP-4-FB	16, 32, 48, 64, 80, 96, 128 <sup>1)</sup>	16, 32, 48, 64, 80, 96, 128 <sup>1)</sup>
CPX-CTEL-4-M12-5POL	0, 64, 128, 192, 256 <sup>1)</sup>	0, 64, 128, 192, 256 <sup>1)</sup>
CPX-CTEL-2-M12-5POL-LK	64, 128, 192, 256 <sup>1)</sup>	64, 128, 192, 256 <sup>1)</sup>
CPX-CM-HPP	256	256
CPX-CMAX-C1-1	64	64
CPX-CMPX-C1-H1	48	48
CPX-CMIX-M1-1	48	48
CPX-4DE	4	–
CPX-8DE	8	–
CPX-8DE-D	8	–
CPX-8NDE	8	–
CPX-P-8DE-N	16	8
CPX-P-8DE-N (inputs configured as counter)	80	16
CPX-F8DE-P	48	56
CPX-16DE	16	–
CPX-M-16DE-D	16	–
CPX-L-16DE-16-KL-3POL	16	–
CPX-4DA	–	4
CPX-8DA	–	8
CPX-8DA-H	–	8
CPX-8DE-8DA	8	8
CPX-L-8DE-8DA-16-KL-3POL	8	8
CPX-2ZE2DA	96	96
CPX-4AE-4AA-H	0, 16, 32, 48, 64, 128, 144, 160, 176, 192 <sup>1)</sup>	0, 16, 32, 48, 64 <sup>1)</sup>
CPX-2AE-U-I	2 x 16	–
CPX-4AE-U-I	4 x 16	–
CPX-4AE-I	4 x 16	–
CPX-4AE-P-B2	4 x 16	–
CPX-4AE-P-D10	4 x 16	–
CPX-4AE-T	4 x 16	–
CPX-4AE-TC	4 x 16	–
CPX-2AA-U-I	–	2 x 16
CPX-FVDA-P2	48	48
VMPA1-FB-EMS-8	–	8
VMPA1-FB-EMG-8	–	8
VMPA2-FB-EMS-4	–	4
VMPA2-FB-EMG-4	–	4
VMPA1-FB-EMS-D2-8	–	8
VMPA1-FB-EMG-D2-8	–	8
VMPA2-FB-EMS-D2-4	–	4
VMPA2-FB-EMG-D2-4	–	4
VMPA-FB-PS-1	16	–
VMPA-FB-PS-3/5	16	–
VMPA-FB-PS-P1	16	–
VMPA-FB-EMG-P1	16	16
VMPAL-EPL-CPX	–	4, 8, 16, 24, 32 <sup>1)</sup>
VABA-S6-1-X1	–	8, 16, 24, 32 <sup>1)</sup>
VABA-S6-1-X2	–	8, 16, 24, 32 <sup>1)</sup>
VABA-S6-1-X2-D	8, 16, 24, 32 <sup>1)</sup>	8, 16, 24, 32 <sup>1)</sup>
VABA-S6-1-X1-CB	–	8, 16, 24 <sup>1)</sup>
VABA-S6-1-X2-CB	–	8, 16, 24 <sup>1)</sup>
VABA-S6-1-X2-F1-CB	–	8, 16, 24 <sup>1)</sup>
VABA-S6-1-X2-F2-CB	–	8, 16, 24 <sup>1)</sup>
VABA-S6-1-X1-3V-CB	–	8, 16, 24 <sup>1)</sup>
VABA-S6-1-X2-3V-CB	–	8, 16, 24 <sup>1)</sup>

1) Dependent on the DIL switch setting on the module

## Data sheet

-  - Module width  
50 mm



-  - **Note**

The data given here apply to the CPX system. If components that conform to lower values are used in the system, the specification for the entire system is reduced to the values for those components.

**Example**

Degree of protection IP65/IP67 applies only to the fully assembled system with fitted plugs or covers (which must also conform to IP65/IP67).

If components with a lower degree of protection are used, the protection level of the entire system is reduced to the degree of protection of the component with the lowest degree of protection, for example CageClamp connection block with degree of protection IP20 or MPA pneumatics with degree of protection IP65.

General technical data		
Module no.		197330
Max. number of modules <sup>1)</sup>	Control block	1
	Bus node	1
	I/O modules/CP interface/CTEL interface/electrical interface CPX-CTEL-2/multi-axis interface	9
	Pneumatic interface	1
Max. address capacity	Inputs [byte]	64
	Outputs [byte]	64
Internal cycle time	[ms]	< 1
Configuration support		Fieldbus-specific
LED displays	Bus node/control block/gateway	Up to 4 LEDs, bus-specific 4 LEDs, CPX-specific • PS = Power system • PL = Power load • SF = System fault • M = Modify parameter/forcing active
		I/O modules
	Pneumatic interface	One centralised diagnostic LED Valve status LED on valve
Diagnostics		<ul style="list-style-type: none"> <li>• Channel and module-oriented diagnostics for inputs/outputs and valves</li> <li>• Detection of module undervoltage for the different potential values</li> <li>• Storage of the last 40 errors with timestamp (acyclic access)</li> </ul>

1) A maximum of 11 modules in total can be combined (e.g. 1 control block + 9 I/O modules + 1 pneumatic interface, or 1 control block + 1 bus node + 8 I/O modules + 1 pneumatic interface)

## Data sheet

General technical data		
Module no.		197330
Parameterisation		Module-specific and entire system, for example: <ul style="list-style-type: none"> <li>• Diagnostic behaviour</li> <li>• Condition monitoring</li> <li>• Profile of inputs</li> <li>• Fail-safe response of outputs and valves</li> </ul>
Commissioning support		Forcing of inputs and outputs
Degree of protection to EN 60529		IP65, IP67
Nominal operating voltage	[V DC]	24
Operating voltage range	[V DC]	18 ... 30
Power supply	Interlinking block with system supply Electronics plus sensors Actuators plus valves	[A] [A] 16 (8/10 with 7/8" supply, 5-pin/4-pin) 16 (8/10 with 7/8" supply, 5-pin/4-pin)
	Additional supply Actuators	[A] 16 (8/10 with 7/8" supply, 5-pin/4-pin)
	Additional supply for valves	[A] 16 (10 with 7/8" supply, 4-pin)
Current consumption		Depending on system configuration
Mains buffering (bus electronics only)	[ms]	10
Power supply connection		M18, 4-pin 7/8" 5-pin 7/8" 4-pin AIDA push-pull, 5-pin
Fuse concept		Per module with electronic fuses
Tests	Vibration test to DIN IEC 68	• With wall mounting: Severity level 2 • With H-rail mounting: Severity level 1
	Shock test to DIN IEC 68	• With wall mounting: Severity level 2 • With H-rail mounting: Severity level 1
PWIS classification		Free of paint-wetting impairment substances
Immunity to interference		EN 61000-6-2 (industry)
Emitted interference		EN 61000-6-4 (industry)
Isolation test for galvanically isolated circuits to IEC 1131 Part 2	[V DC]	500
Galvanic isolation of electrical voltages	[V DC]	80
Protection against direct and indirect contact		PELV
Materials		End plates: Die-cast aluminium
Grid dimension	[mm]	50
Operating and environmental conditions		
Module no.		197330
Ambient temperature	[°C]	-5 ... +50
Storage temperature	[°C]	-20 ... +70

## Data sheet

Certifications and approvals – Maximum values	
Module no.	197330
ATEX category gas	II 3G
Type of ignition protection for gas	Ex nA IIC T4 X Gc
Explosion-proof ambient temperature [°C]	$-5 \leq T_a \leq +50$
CE marking (see declaration of conformity)	To EU Explosion Protection Directive (ATEX)
	To EU EMC Directive <sup>1)</sup>
	To EU RoHS Directive
KC mark	KC EMC
Degree of protection to EN 60529	IP65, IP67
Certification	c UL us - Recognized (OL)
	RCM
Explosion protection certification outside the EU	EPL Gc (Ru)

1) For information about the area of use, see the EC declaration of conformity at: [www.festo.com/catalogue/...](http://www.festo.com/catalogue/...) → Support/Downloads.

If the devices are subject to usage restrictions in residential, commercial or light-industrial environments, further measures for the reduction of the emitted interference may be necessary.

 **Note**

The values indicated represent the maximum performance limits that can be achieved with the fully assembled product. Depending on the individual components used, the val-

ue actually achieved for the overall product may be lower. You can select e.g. the individual components required to achieve the ATEX category by choosing the corre-

sponding features in the online product configurator:

→ Internet:cpx



## Data sheet

Weights [g]						
Control block	CEC	155	CP interface	CP	139	
	CEC...V3	135	CTEL interface	CTEL	110	
Bus node	FB6	125	Electrical interface	CTEL-2	110	
	FB11	120	Axis interface	CM-HPP	140	
	FB13	115	Axis controller	CMAX	140	
	FB14	115	End-position controller	CMPX	140	
	FB21	1255	Measuring module	CMIX	140	
	FB23-24	115	Plastic connection block	8-way, M8 3-pin	62	
	FB33	280		8-way, M8 4-pin	65	
	FB34	280		4-way, M12 5-pin	60	
	FB35	280		4-way, M12 5-pin, quick lock, shielded with metal thread	87	
	FB36	125		8-way, M12 5-pin	76	
	FB37	125		4-way, M12 8-pin	65	
	FB39	125		Spring-loaded terminal, 32-pin	75	
	FB40	125		Sub-D 25-pin	72	
	FB43	185		4-way, quick connector 4-pin	78	
	FB44	280		8-way, DIL switch	57	
	FB45	280	Connection block for NAMUR and HART module	4-way, M12 4-pin	120	
	Gateway	IOT	130	Clamping connector 8-pin	100	
I/O module	4 digital outputs	42	Metal connection block	4-way, M12 5-pin	112	
	4 digital inputs	39	4-way, M12 5-pin, pulsed sensor supply	110		
	8 digital inputs	39	8-way, M12 5-pin	152		
	8 digital inputs, positive logic (PNP), enhanced diagnostic function	45	Plastic interlinking block	Without power supply	108	
	8 digital inputs, negative logic (NPN)	40		System supply	125	
	8 digital inputs to NAMUR	100	Interlinking block, metal	Without power supply	169	
	16 digital inputs, internal electronic fuse per module	41		System supply, 7/8" 4-pin	228	
	16 digital inputs, internal electronic fuse per channel pair, for CPX in metal	46		System supply, 7/8" 5-pin	187	
	16 digital inputs, for CPX in plastic, including interlinking block and connection block with spring-loaded terminals	167		System supply, M12x1	279	
	8 digital inputs, 8 digital outputs	48		System supply, push-pull	279	
	8 digital inputs, 8 digital outputs, for CPX in plastic, including interlinking block and connection block with spring-loaded terminals	171	System forwarding, M12x1	279		
	8 digital outputs, power supply 0.5 A per channel	49	Tie rods	1-way	41	
	8 digital outputs, power supply 2.1 A per channel pair	48		2-way	71	
	2 analogue current or voltage inputs	48		3-way	97	
	4 analogue current inputs	47		4-way	127	
	2 analogue current or voltage outputs	49		5-way	156	
	4 analogue inputs/outputs, HART	77.4		6-way	173	
	2 or 4 analogue temperature inputs	47		7-way	199	
	4 analogue temperature inputs, with 2-wire connection for a PT1000 sensor for cold junction compensation	46		8-way	247	
	4 analogue pressure inputs	115		9-way	274	
	4 analogue pressure inputs	115		10-way	301	
	PROFIsafe	Shut-off module	50	End plate for plastic design	Left-hand	110
	Input module	46	Left-hand, with system supply		145	
	Counter module	2ZE2DA	130	Right-hand	110	
				End plate for metal design	Left-hand	113
				Right-hand	113	
				End plate with extension	Left-hand	190
			Right-hand		175	
			Pneumatic interface	MPA-S	238.4	
				VTSA/VTSA-F	590	
				VTSA-F-CB without voltage zones	560	
				VTSA-F-CB with safe voltage zones	734	
				VTSA-F-CB with safe voltage zones and power supply for external consuming devices	754	
				VTSA-F-CB with external power supply	580	

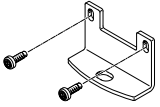
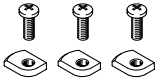
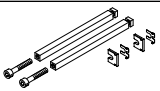
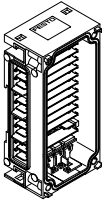
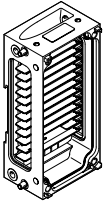
## Data sheet



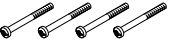
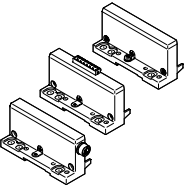
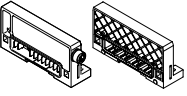
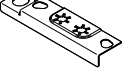
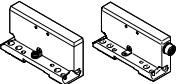
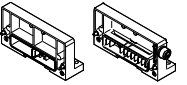
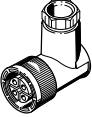
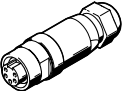
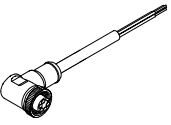
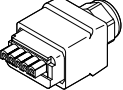

Ordering data – Accessories		Part no.	Type
Designation			
<b>Mounting</b>			
	Attachment for wall mounting (for long valve terminals, 10 pieces), design for plastic manifold sub-bases	529040	CPX-BG-RW-10x
	Attachment for wall mounting, version for metal manifold sub-bases	2 mounting brackets, 4 screws	550217 CPX-M-BG-RW-2X
		1 mounting bracket, 2 screws	2721419 CPX-M-BG-VT-2X
	Mounting for H-rail	CPX without pneumatic components	526032 CPX-CPA-BG-NRH
		CPX-VTSA	
		CPX-VTSA-F	
		CPX-MPA	
<b>Tie rod</b>			
	Tie rod CPX	Extension, 1 module	525418 CPX-ZA-1-E
		1-module	195718 CPX-ZA-1
		2-module	195720 CPX-ZA-2
		3-module	195722 CPX-ZA-3
		4-module	195724 CPX-ZA-4
		5-module	195726 CPX-ZA-5
		6-module	195728 CPX-ZA-6
		7-module	195730 CPX-ZA-7
		8-module	195732 CPX-ZA-8
		9-module	195734 CPX-ZA-9
10-module	195736 CPX-ZA-10		
<b>Plastic interlinking block</b>			
	Without power supply	–	195742 CPX-GE-EV
	With system supply	M18	195746 CPX-GE-EV-S
		M18, for ATEX environment	8022170 CPX-GE-EV-S-VL
		7/8" – 4-pin	541248 CPX-GE-EV-S-7/8-4POL
		7/8" – 5-pin	541244 CPX-GE-EV-S-7/8-5POL
		7/8" – 5-pin, for ATEX environment	8022172 CPX-GE-EV-S-7/8-5POL-VL
	With additional supply for outputs	M18	195744 CPX-GE-EV-Z
		M18, for ATEX environment	8022166 CPX-GE-EV-Z-VL
		7/8" – 4-pin	541250 CPX-GE-EV-Z-7/8-4POL
		7/8" – 5-pin	541246 CPX-GE-EV-Z-7/8-5POL
		7/8" – 5-pin, for ATEX environment	8022173 CPX-GE-EV-Z-7/8-5POL-VL
	With additional supply for valves	M18	533577 CPX-GE-EV-V
		M18, for ATEX environment	8022171 CPX-GE-EV-V-VL
7/8" – 4-pin		541252 CPX-GE-EV-V-7/8-4POL	
<b>Interlinking block, metal</b>			
	Without power supply	–	550206 CPX-M-GE-EV
		For CPX-FVDA-P2 only	567806 CPX-M-GE-EV-FVO
	With system supply	7/8" – 4-pin	568956 CPX-M-GE-EV-S-7/8-CIP-4P
		7/8" – 5-pin	550208 CPX-M-GE-EV-S-7/8-5POL
		7/8" – 5-pin, for ATEX environment	8022165 CPX-M-GE-EV-S-7/8-5POL-VL
		M12x1, L-coded, 5-pin	8098392 CPX-M-GE-EV-S-M12-5POL
		Push-pull – 5-pin	563057 CPX-M-GE-EV-S-PP-5POL
		7/8" – 5-pin	550210 CPX-M-GE-EV-Z-7/8-5POL
	With additional supply for outputs	7/8" – 5-pin, for ATEX environment	8022158 CPX-M-GE-EV-Z-7/8-5POL-VL
		Push-pull – 5-pin	563058 CPX-M-GE-EV-Z-PP-5POL
		M12x1, L-coded, 5-pin	8098391 CPX-M-GE-EV-W-M12-5POL

## Data sheet

Ordering data – Accessories				
Designation		Part no.	Type	
<b>Mounting accessories</b>				
	Screws for mounting the bus node/connection block on the plastic interlinking block	Bus node/metal connection block	550218	CPX-DPT-30X32-S-4X
	Screws for mounting the bus node/connection block on the metal interlinking block	Bus node/plastic connection block	550219	CPX-M-M3x22-4x
		Bus node/metal connection block	550216	CPX-M-M3x22-S-4x
<b>End plates for plastic design</b>				
	Left-hand end plate	–	195716	CPX-EPL-EV
		With system supply	576315	CPX-EPL-EV-S
		With extension	576314	CPX-EPL-EV-X
	Right-hand end plate	–	195714	CPX-EPR-EV
		With extension	576313	CPX-EPR-EV-X
	Earthing component for right-hand/left-hand end plate	5 pieces	538892	CPX-EPFE-EV
<b>End plates for metal design</b>				
	Left-hand end plate	–	550212	CPX-M-EPL-EV
		With extension	576317	CPX-M-EPL-EV-X
	Right-hand end plate	–	550214	CPX-M-EPR-EV
		With extension	576316	CPX-M-EPR-EV-X
<b>Power supply</b>				
	Plug socket for mains connection M18x1, straight, 4-pin	For 1.5 mm <sup>2</sup>	18493	NTSD-GD-9
		For 2.5 mm <sup>2</sup>	18526	NTSD-GD-13.5
	Plug socket for mains connection M18x1, angled, 4-pin	For 1.5 mm <sup>2</sup>	18527	NTSD-WD-9
		For 2.5 mm <sup>2</sup>	533119	NTSD-WD-11
	Plug socket for mains connection 7/8", straight, 5-pin	0.25 ... 2.0 mm <sup>2</sup>	543107	NECU-G78G5-C2
	Plug socket for mains connection 7/8", straight, 4-pin	0.25 ... 2.0 mm <sup>2</sup>	543108	NECU-G78G4-C2
	Plug socket for mains connection 7/8", angled, 5-pin – open cable end, 5-wire	2 m	573855	NEBU-G78W5-K-2-N-LE5
	Push-pull power supply socket, plug pattern PP, fulfils requirements to AIDA	5-pin	5195383	NECU-M-PPG5PP-C1-PN
	Straight plug, spring-loaded terminal, for left-hand end plate with system supply	7-pin	576319	NECU-L3G7-C1

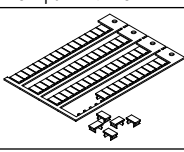

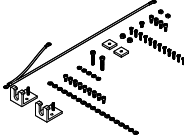
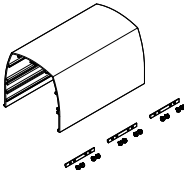
## Data sheet

Ordering data – Accessories		Part no.	Type
Designation			
Inscription labels			
	Inscription labels 6x10 mm, 64 pieces, in frame	18576	IBS-6x10
Hood			
	Mounting rail for attaching the hood	1000 mm	572256 CAFC-X1-S
	Mounting kit for CPX hood		572257 CAFC-X1-BE
	Hood section for CPX terminal including mounting attachments for connecting several hood sections in series.	200 mm	572258 CAFC-X1-GAL-200
		300 mm	572259 CAFC-X1-GAL-300
User documentation			
	CPX system manual	German	526445 P.BE-CPX-SYS-DE
		English	526446 P.BE-CPX-SYS-EN
		Spanish	526447 P.BE-CPX-SYS-ES
		French	526448 P.BE-CPX-SYS-FR
		Italian	526449 P.BE-CPX-SYS-IT

## Data sheet

### User documentation – General information

Comprehensive user documentation is vital for the fast and reliable use of fieldbus components.

The manuals provided by Festo contain step-by-step instructions for using the CPX terminal:

1. Installation
2. Commissioning and parameterisation
3. Diagnostics

Application-oriented explanations are provided for integrating the CPX terminal in the programming and configuration software of the various controller manufacturers.

Use the order code to select the language you want.

The manuals for the configuration you have ordered are supplied automatically.

The documents can be downloaded quickly and easily from the Festo website → [www.festo.com](http://www.festo.com).



### Overview – User documentation

Type	Title	Description
<b>Pneumatics</b>		
P.BE-VTSA-44-...	Valve terminals with VTSA and VTSA-F pneumatics	Instructions on assembly, installation, commissioning and diagnostics of the VTSA and VTSA-F pneumatic components.
P.BE-MPA-...	Valve terminals with MPA-S pneumatics	Instructions on assembly, installation, commissioning and diagnostics of the MPA-S pneumatic components.
MPAL-VI-...	Valve terminal	Instructions on assembly, installation, commissioning and diagnostics of the MPA-L pneumatic components.

## Data sheet

Overview – User documentation		
Type	Title	Description
<b>Electronics</b>		
P.BE-CPX-SYS...	System description, installation and commissioning	Overview of the design, components and mode of operation of the CPX terminal; installation and commissioning instructions as well as basic principles of parameterisation.
CPX-FVDA-P2...	PROFIsafe shut-off module	Connection technology and assembly, installation and commissioning instructions for the PROFIsafe shut-off module of the type CPX-FVDA-P2.
P.BE-CPX-EA...	CPX-EA modules, digital	Connection technology and assembly, installation and commissioning instructions for digital input and output modules of type CPX... as well as the VTSA/VTSA-F and MPA-S/L pneumatic interface.
P.BE-CPX-P-EA...	Input module CPX-P-8DE-N	Connection technology and assembly, installation and commissioning instructions for the digital input module for NAMUR sensors of type CPX-P-8DE-N.
CPX-F8DE-P...	Input module CPX-F8DE-N	Connection technology and assembly, installation and commissioning instructions for the PROFIsafe input module of type CPX-F8DE-P.
P.BE-CPX-2ZE2DA...	I/O-module CPX-2ZE2DA	Connection technology and assembly, installation and commissioning instructions for counter modules of type CPX-2ZE2DA.
P.BE-CPX-AX...	CPX-EA modules, analogue	Connection technology and assembly, installation and commissioning instructions for analogue input and output modules of type CPX... as well as pressure sensors and proportional pressure regulators.
P.BE-CPX-CP...	CPX CP interface	Instructions on assembly, installation, commissioning and diagnostics of the CP interface.
P.BE-CPX-CTEL...	CPX CTEL interface	Instructions on assembly, installation, commissioning and diagnostics of the CPX CTEL master.
P.BE-CPX-CTEL-LK...	Electrical interface CPX-CTEL-2	Instructions on assembly, installation, commissioning and diagnostics for the CPX electrical interface for IO-Link.
CPX-CM-HPP...	CPX axis interface	Instructions on assembly, installation, commissioning and diagnostics of the CPX axis interface (CM-HPP).
P.BE-CPX-CMAX-SYS...	CPX axis controller	Instructions on assembly, installation, commissioning and diagnostics of the CPX axis controller (CMAX).
P.BE-CPX-CMAX-CONTROL...	CPX axis controller	Information on control, diagnostics and parameterisation of the axis controller via the fieldbus.
P.BE-CPX-CMPX-SYS...	CPX end-position controller	Instructions on assembly, installation, commissioning and diagnostics of the CPX end-position controller (CMPX).
P.BE-CPX-CMIX...	CPX measuring module	Instructions on assembly, installation, commissioning and diagnostics of the CPX measuring module (CMIX).
P.BE-CPX-FB... CPX...	CPX bus node	Instructions on assembly, installation, commissioning and diagnostics of the relevant bus node.
CPX-(M)-FB33_35/43_45...	CPX bus node for PROFINET	Instructions on assembly, installation, commissioning and diagnostics of the relevant bus node.
P.BE-CPX-CEC...	CPX CODESYS controller (control block)	Instructions on assembly, installation, commissioning and diagnostics of the relevant control block.

## User documentation – GSD, EDS, ...

Device description files and icons are used to explain the integration of the CPX terminal in the configuration software of the various controller manufacturers.

These can be downloaded quickly and easily from [www.festo.com](http://www.festo.com).

## Data sheet – CPX Maintenance Tool

**Function**

The CPX Maintenance Tool (CPX-FMT) combines service software with a connecting adapter. The service software is a tool for the design, parameterisation and online diagnostics of the CPX terminal.

The USB-to-M12 adapter features built-in galvanic isolation (between CPX and PC) and enables a PC to be connected to the diagnostic interface of the CPX terminal.

- Adapters
- Software on CD-ROM

**Application**

Only from Festo

The CPX-FMT software enables access to CPX valve terminals via Ethernet with the bus nodes EtherNet/IP (FB 36), Sercos III (FB 39) and PROFINET (FB 33, FB 34, FB 35, FB 41, FB 45). The bus nodes or control blocks can be connected directly to a PC via a USB adapter from Festo. Diagnostic data such as the error trace or module diagnostics can be read out and parameters can be modified in plain text.

The data can be used directly on a PC. There is an option, for example, to send screenshots of a configuration or the current error trace directly via e-mail. In addition, CPX configurations can also be saved and archived directly as a CPX-FMT project. Undocumented changes can subsequently be identified using the online/offline comparison function.

On-site tests such as the actuation of valves or the emulation of sensor feedback (in both cases called "forcing"), for example, can be carried out without an existing controller infrastructure.

It must be noted that with the CPX-FMT, only local parameters on the CPX valve terminal can be changed and saved. The configuration of the networks or controller software cannot be influenced.

<b>General technical data</b>		
Type		NEFC-M12G5-0.3-U1G5
System requirements	PC	IBM-compatible
	Drive	CD-ROM
	Interfaces	USB port (specification USB 1.1 or higher)
	Operating system	Microsoft Windows 2000 or XP
Function range		<ul style="list-style-type: none"> <li>• Configuration and parameterisation</li> <li>• Reading out of system, module, channel diagnostics and error trace</li> <li>• Saving of the configuration as a project</li> <li>• Integration of plug-ins/links to self-executing programs</li> </ul>
Scope of delivery		<ul style="list-style-type: none"> <li>• Adapter, M12, 5-pin to mini USB socket</li> <li>• CD-ROM with installation program</li> </ul>
Type of mounting		Screw-in
Electrical connection		Plug M12x1, 5-pin
Adapter cable composition		4 x 0.34 mm <sup>2</sup>
Cable length	[m]	0.3
Degree of protection to EN 60529		IP20
CE marking (see declaration of conformity)		To EU EMC Directive
Ambient temperature	[°C]	-5 ... +50
Material	Housing	ABS
	Cable sheath	PUR
	Pin contact	Gold-plated brass
Note on materials		RoHS-compliant

## Data sheet – CPX Maintenance Tool

## Dimensions

Download CAD data → [www.festo.com](http://www.festo.com)

- [1] Mini B 5P USB port
- [2] Plug M12x1, 5-pin

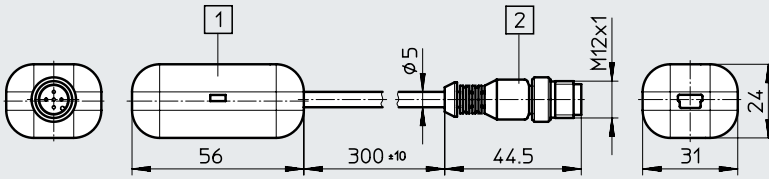

## Ordering data

Designation	Part no.	Type
 CPX Maintenance Tool (CPX-FMT), software and USB-to-M12 adapter	<b>547432</b>	<b>NEFC-M12G5-0.3-U1G5</b>

## Data sheet – CPX-IOT gateway

- Industrial Ethernet
- TCP/IP
- OPC UA
- Web interface

Gateway for continuous transfer of operating data from connected Festo components to a central storage location (MQTT broker).

Comprehensive status information for the gateway is displayed using 7 specific LEDs.

The gateway can only be used as a combination with end plates and an interlinking block; no additional CPX modules are possible.



### Application

#### Data collection

The CPX-IOT gateway gathers information and transfers it to a central storage location (user-specific MQTT broker).

The transfer takes place using secure protocols. The customer can only connect to the internet via a firewall.

The extent of the data gathered and transferred is determined by the evaluation software (app).

#### Advantages:

- The central controller of the machine or system does not require an internet connection
- Operating data are available outside the system

#### Prerequisites

- Connected components must have corresponding evaluation software (app)
- Internet connection
- Components to be monitored have an Industrial Ethernet interface
- MQTT broker

Information that can be evaluated (depending on the software):

- (Energy) consumption monitoring
- Preventive maintenance
- Visualisation of overall equipment effectiveness
- Identification data
- Diagnostic data
- Parameter data
- Operating status data

### Interfaces

Onward communication between the gateway and the central storage location (MQTT broker) is via an Industrial Ethernet interface with M12x1 plug, D-coded to IEC 947-5-2.

The operating mode of the gateway is set using a rotary switch. This enables simple interruption of this network connection on site.

Communication with the components being monitored is also via an Industrial Ethernet interface with M12x1 plug, D-coded to IEC 947-5-2.

Both connections have auto-negotiation and crossover detection as factory settings.

## Data sheet – CPX-IOT gateway

## Design

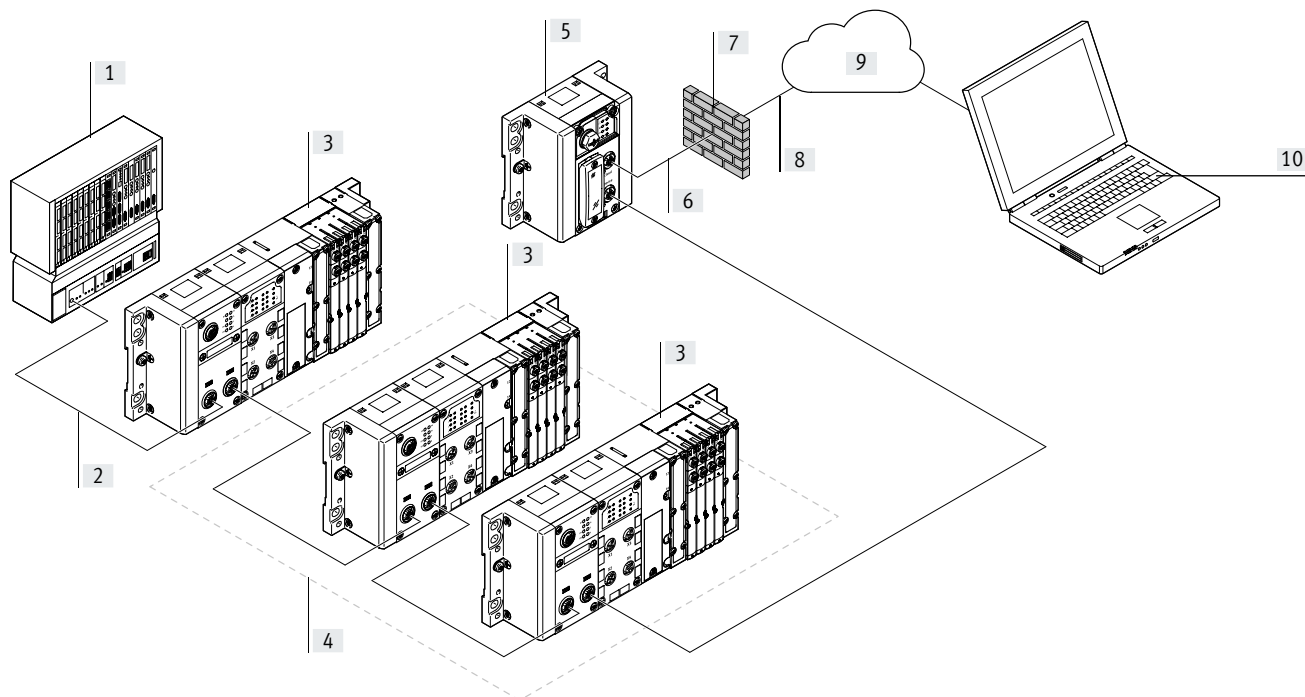

- |  |   |  |  |
|--|---|--|--|
| [1] PLC to machine/system controller (no direct internet connection)   | [3] Festo components with bus connection with serial linking              | [6] Internet connection  | [9] Central storage location (user-specific MQTT broker) provided by Festo   |
| [2] Bus system from the controller to the system parts (e.g. PROFINET) | [4] Components from which the CPX-IOT is collecting and transferring data | [7] Customer firewall or other security precautions                                      | [10] Simple decentralised evaluation of data using adapted programs (apps) for the components that are being monitored |
|  | [5] Gateway CPX-IOT   | [8] Transferring data to a central storage location (MQTT broker) using secure protocols |  |

## Data sheet – CPX-IOT gateway

General technical data		
Type		CPX-IOT
Fieldbus interface	Protocol	Ethernet OPC UA
	Function	Bus connection to Ethernet-based Festo devices
	Connection type	Socket
	Connection technology	M12x1, D-coded to EN 61076-2-101
	Number of pins/wires	4
	Galvanic isolation	Yes
	Transmission rate	[Mbps] 100
Ethernet interface	Protocol	TCP/IP
	Function	Connection to MQTT broker
	Connection type	Socket
	Connection technology	M12x1, D-coded to EN 61076-2-101
	Number of pins/wires	4
	Transmission rate	[Mbps] 10 [Mbps] 100
CPU data		Dual core 533 MHz 256 MB RAM
Configuration support		Integrated web server
Diagnostics via LED		Modify
		Module location
		Network status
		Network status port 1
		Network status port 2
		Power supply, electronics/sensors
		Power supply load
		System error
Control elements		Rotary switch for setting operating mode
		DIL switch for resetting to delivery status
IP address setting		DHCP
		Static via web server
Technical data – Electrics		
Nominal operating voltage DC for electronics/sensors	[V DC]	24
Permissible voltage fluctuations for electronic system/sensors	[%]	±25
Power failure buffering	[ms]	10
Intrinsic current consumption at nominal operating voltage for electronic system/sensors	[mA]	Typically 80
Protection against direct and indirect contact		PELV
Technical data – Mechanical components		
Type of mounting		With H-rail
Product weight	[g]	130
Grid dimension	[mm]	50
Dimensions W x L x H	[mm]	50 x 107 x 50
Materials		
Housing		PA
Note on materials		RoHS-compliant



## Data sheet – CPX-IOT gateway

Operating and environmental conditions		
Ambient temperature	[°C]	- 5... +50
Storage temperature	[°C]	- 20... +70
Relative humidity	[%]	95
		Non-condensing
Corrosion resistance class CRC <sup>1)</sup>		0
CE marking (see declaration of conformity) <sup>3)</sup>		To EU EMC Directive <sup>2)</sup>
Degree of protection		IP65
		IP67

- 1) Corrosion resistance class CRC 0 to Festo standard FN 940070  
No corrosion stress. Applies to small, visually unimportant standards-based parts such as threaded pins, circlips and clamping sleeves which are usually only available on the market in a phosphated or burnished version (and possibly oiled) as well as to ball bearings (for components < CRC 3) and plain bearings.
- 2) For information about the area of use, see the EC declaration of conformity at: [www.festo.com/catalogue/...](http://www.festo.com/catalogue/...) → Support/Downloads.  
If the devices are subject to usage restrictions in residential, commercial or light-industrial environments, further measures for the reduction of the emitted interference may be necessary.
- 3) Additional information: [www.festo.com/catalogue/...](http://www.festo.com/catalogue/...) → Support/Downloads.

Safety characteristics	
Shock resistance	Shock test with severity level 1 to FN 942017-5 and EN 60068-2-27
Vibration resistance	Transport application test with severity level 1 to FN 942017-4 and EN 60068-2-6

## Connection and display components

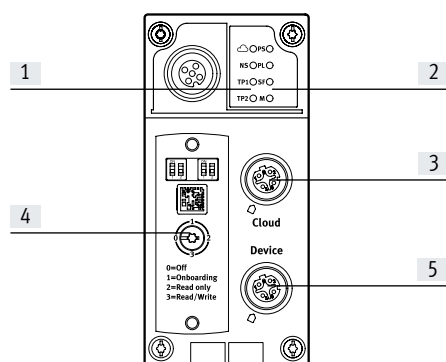

- [1] Network-specific LED displays
- [2] Gateway-specific LED displays
- [3] Connection to MQTT broker  
(M12x1 socket, 4-pin, D-coded)
- [4] Transparent switch cover
- [5] Bus connection to Ethernet-based  
Festo devices (M12x1 socket,  
4-pin, D-coded)

## Pin allocation for MQTT broker connection and bus connection to Ethernet-based Festo devices







Terminal allocation	Pin	Signal	Designation
<b>M12x1 socket, D-coded</b>			
	1	TD+	Transmitted data+
	2	RD+	Received data+
	3	TD-	Transmitted data-
	4	RD-	Received data-
	Housing	Shielding	Connected to functional earth (FE) via RC link

## Data sheet – CPX-IOT gateway

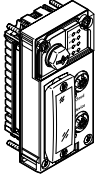
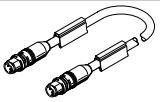

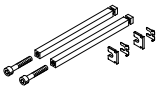
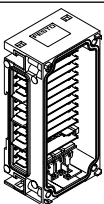
Combinations of interlinking blocks and gateway		
Interlinking blocks	Part no.	Gateway
		CPX-IOT
CPX-GE-EV-S	195746	■
CPX-GE-EV-S-VL	8022170	-
CPX-GE-EV-S-7/8-4POL	541248	-
CPX-GE-EV-S-7/8-5POL	541244	■
CPX-GE-EV-S-7/8-5POL-VL	8022172	-
CPX-M-GE-EV-S-7/8-CIP-4P	568956	-
CPX-M-GE-EV-S-7/8-5POL	550208	-
CPX-M-GE-EV-S-7/8-5POL-VL	8022165	-
CPX-M-GE-EV-S-PP-5POL	563057	-
CPX-GE-EV	195742	■
CPX-M-GE-EV	550206	-
CPX-M-GE-EV-FVO	567806	-
CPX-GE-EV-Z	195744	-
CPX-GE-EV-Z-VL	8022166	-
CPX-GE-EV-Z-7/8-4POL	541250	-
CPX-GE-EV-Z-7/8-5POL	541246	-
CPX-GE-EV-Z-7/8-5POL-VL	8022173	-
CPX-M-GE-EV-Z-7/8-5POL	550210	-
CPX-M-GE-EV-Z-7/8-5POL-VL	8022158	-
CPX-M-GE-EV-S-M12-5POL	8098392	-
CPX-M-GE-EV-Z-PP-5POL	563058	-
CPX-GE-EV-V	533577	-
CPX-GE-EV-V-VL	8022171	-
CPX-GE-EV-V-7/8-4POL	541252	-
CPX-M-GE-EV-W-M12-5POL	8098391	-

Combinations of end plates and gateway		
End plates	Part no.	Gateway
		CPX-IOT
CPX-EPL-EV	195716	■
CPX-EPL-EV-S	576315	■
CPX-EPL-EV-X	576314	-
CPX-EPR-EV	195714	■
CPX-EPR-EV-X	576313	-

## Data sheet – CPX-IOT gateway

Ordering data				Part no.	Type
Designation					
Gateway					
				8069773	CPX-IOT
Bus connection					
	Connecting cable, straight plug, M12x1, 4-pin, D-coded	Straight plug, M12x1, 4-pin, D-coded	0.5 m	8040446	NEBC-D12G4-ES-0.5-S-D12G4-ET
			1 m	8040447	NEBC-D12G4-ES-1-S-D12G4-ET
			3 m	8040448	NEBC-D12G4-ES-3-S-D12G4-ET
			5 m	8040449	NEBC-D12G4-ES-5-S-D12G4-ET
			10 m	8040450	NEBC-D12G4-ES-10-S-D12G4-ET
		Straight plug, RJ45, 8-pin	1 m	8040451	NEBC-D12G4-ES-1-S-R3G4-ET
			3 m	8040452	NEBC-D12G4-ES-3-S-R3G4-ET
			5 m	8040453	NEBC-D12G4-ES-5-S-R3G4-ET
		Open end, 4-wire	10 m	8040454	NEBC-D12G4-ES-10-S-R3G4-ET
5 m	8040456		NEBC-LE4-ES-5-D12G4-ET		
	Cover cap for sealing unused bus connections (10 pieces)			165592	ISK-M12
Tie rod					
	Tie rod CPX	Tie rod CPX	1-module	195718	CPX-ZA-1
Interlinking block					
	Without power supply		–	195742	CPX-GE-EV
	With system supply		M18	195746	CPX-GE-EV-S
			7/8" – 5-pin	541244	CPX-GE-EV-S-7/8-5POL
End plates					
	Left-hand end plate	Without supply		195716	CPX-EPL-EV
		With system supply		576315	CPX-EPL-EV-S
	Right-hand end plate	–		195714	CPX-EPR-EV
		Earthing component for right-hand/left-hand end plate		5 pieces	538892

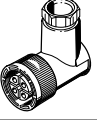
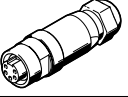
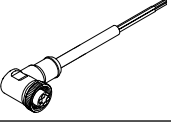
## Data sheet – CPX-IOT gateway

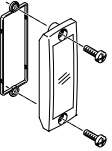
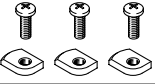
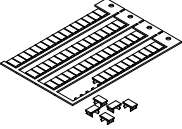
Ordering data				Part no.	Type
Designation					
Power supply					
	Plug socket for mains connection M18x1, 4-pin	Straight	For 1.5 mm <sup>2</sup>	18493	NTSD-GD-9
			For 2.5 mm <sup>2</sup>	18526	NTSD-GD-13.5
		Angled	For 1.5 mm <sup>2</sup>	18527	NTSD-WD-9
			For 2.5 mm <sup>2</sup>	533119	NTSD-WD-11
	Plug socket for mains connection 7/8", straight, 5-pin		0.25 ... 2.0 mm <sup>2</sup>	543107	NECU-G78G5-C2
	Plug socket for mains connection 7/8", angled, 5-pin – open cable end, 5-wire		2 m	573855	NEBU-G78W5-K-2-N-LE5
	Straight plug, spring-loaded terminal, for left-hand end plate with system supply		7-pin	576319	NECU-L3G7-C1
Cover					
	Inspection cover, transparent			533334	AK-SUB-9/15-B
Mounting					
	Mounting for H-rail			526032	CPX-CPA-BG-NRH
Inscription labels					
	Inscription labels 6x10 mm, 64 pieces, in frame			18576	IBS-6x10

## Data sheet – CODESYS controller

- Industrial Ethernet
- TCP/IP
- EasyIP
- Web interface
- Email
- Data transfer

The CODESYS controller is a modern control system for CPX terminals that enables programming with CODESYS to IEC 61131-3.

The power supply to and communication with other modules takes place via the interlinking block.

In addition to network connections, LEDs are also provided for the bus status, operating status of the PLC and CPX peripherals information, as are switching elements and a diagnostic interface for CPX-FMT.



### Application

#### Bus connection

The CPX-CEC is a remote controller that can be connected to a higher-order PLC via the bus nodes of the CPX terminal or via Ethernet.

At the same time, it is possible to operate the CPX-CEC as a compact stand-alone controller directly on the machine.

#### Communication protocols

- Fieldbus via CPX bus nodes
- Modbus/TCP
- EasyIP

#### Operating modes

- Stand-alone
- Remote controller, fieldbus
- Remote controller, Ethernet

### Setting options

The CPX-CEC has the following interfaces for monitoring, programming and commissioning:

- For the CPX-FMT
- Ethernet interface for IT applications
- Remote diagnostics

The operating mode and fieldbus protocol are set using the DIL switch on the CPX-CEC.

The integrated web server offers a convenient means of querying data saved in the CPX-CEC.

### Features

- Easy control of valve terminal configurations with MPA, VTSA
- Diagnostics with flexible monitoring options for pressure, flow rate, cylinder operating time, air consumption

- Activation of decentralised installation systems on the basis of CPI control of applications in proportional pneumatics
- AS-Interface control via gateway

- Connection to all fieldbuses as a remote controller and for preprocessing
- Control of electric actuators as individual axes via CANopen (CPX-CEC-C1/-M1)

- Early warnings and visualisation options
- Servo-pneumatic applications

## Data sheet – CODESYS controller

General technical data		
Protocol		CODESYS Level 2
		EasyIP
		Modbus TCP
		TCP/IP
Processing time		Approx. 200 µs/1 k instructions
Programming software		CODESYS provided by Festo
Programming language		To IEC 61131-3
		Sequential function chart (SFC)
		Instruction list (IL)
		Function chart (FCH), additional continuous function chart (CFC)
		Ladder diagram (LD)
Programming	Operating language	German, English
	Support for file handling	Yes
Device-specific diagnostics		Diagnostic memory
		Channel and module-oriented diagnostics
		Undervoltage/short-circuit modules
LED displays	Bus-specific	TP: Link/traffic
	Product-specific	RUN: PLC status
		STOP: PLC status
		ERR: PLC runtime error
		PS: Electronics supply, sensor supply
		PL: Load supply
		SF: System fault
		M: Modify/forcing active
IP address setting		DHCP
		Via CODESYS
		Via MMI
Function blocks		CPX diagnostic status, copy CPX diagnostic trace, read CPX module diagnostics, and more
Dimensions (including interlinking block) W x L x H	[mm]	50 x 107 x 55

Materials	
Housing	PA-reinforced
	PC
Note on materials	RoHS-compliant

Operating and environmental conditions		
Ambient temperature	[°C]	-5 ... +50
Storage temperature	[°C]	-20 ... +70
Relative humidity	[%]	95, non-condensing
Corrosion resistance class CRC <sup>1)</sup>		2

1) Corrosion resistance class CRC 2 to Festo standard FN 940070

Moderate corrosion stress. Indoor applications in which condensation can occur. External visible parts with primarily decorative surface requirements which are in direct contact with a normal industrial environment.

Electrical data			
Nominal operating voltage		[V DC]	24
Load voltage	Nominal operating voltage	[V DC]	24
	With pneumatics type VTSA	[V DC]	21.6 ... 26.4
	With pneumatics type MPA	[V DC]	18 ... 30
	Without pneumatics	[V DC]	18 ... 30
Power failure buffering		[ms]	10
Intrinsic current consumption at nominal operating voltage		[mA]	Typically 85
Degree of protection to EN 60529			IP65, IP67

## Data sheet – CODESYS controller

Technical data				CPX-CEC-C1	CPX-CEC-C1-V3	CPX-CEC-M1-V3
Type						
Additional functions			Motion functions for electric drives		SoftMotion functions for electric drives	
CPU data	Flash	[MB]	32	32	32	
	RAM	[MB]	32	256	256	
	Processor	[MHz]	400	800	800	
Control interface			CAN bus		CAN bus	
Parameterisation			CODESYS V2.3		CODESYS V3	
Configuration support			CODESYS V2.3		CODESYS V3	
Program memory, user program			[MB]	4	16	16
Flags			CODESYS variable concept			
	Remanent data	[kB]	30	28	28	
	Global data memory	[MB]	8	–	–	
Control elements			DIL switch for CAN termination			
			Rotary switch for RUN/STOP			
Total number of axes			31	127	31	
Ethernet	Number		1			
	Connection technology		RJ45 socket, 8-pin			
	Data transmission speed	[Mbps]	10/100			
	Supported protocols		TCP/IP, EasyIP, Modbus TCP			
Fieldbus interface	Number		1			
	Connection technology		Sub-D plug, 9-pin			
	Data transmission speed, can be set via software	[kbps]	125, 250, 500, 800, 1000	125, 250, 500, 800, 1000	125, 250, 500, 800, 1000	
	Supported protocols		CAN bus			
	Galvanic isolation		Yes			

Technical data				CPX-CEC	CPX-CEC-S1-V3
Type					
CPU data	Flash	[MB]	32	32	
	RAM	[MB]	32	256	
	Processor	[MHz]	400	800	
Parameterisation			CODESYS V2.3		CODESYS V3
Configuration support			CODESYS V2.3		CODESYS V3
Additional functions			Diagnostic functions		
			RS232 communication function		
Program memory, user program			[MB]	4	16
Flags			CODESYS variable concept		
	Remanent data	[kB]	30	28	
	Global data memory	[MB]	8	–	
Control elements			Rotary switch for RUN/STOP		
Ethernet	Number		1		
	Connection technology		RJ45 socket, 8-pin		
	Data transmission speed	[Mbps]	10/100		
	Supported protocols		TCP/IP, EasyIP, Modbus TCP		
Data interface	Number		1		
	Connection technology		Sub-D socket, 9-pin		
	Data transmission speed	[kbps]	9.6 ... 230.4		
	Supported protocols		RS232 interface		
	Max. cable length	[m]	–	30	
Galvanic isolation		Yes			

## Data sheet – CODESYS controller

**Connection and display elements CPX-CEC-C1/-M1**

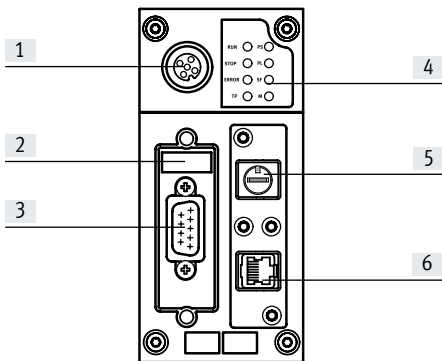

- [1] CPX-FMT connection
- [2] DIL switch
- [3] Fieldbus interface (Sub-D plug, 9-pin)
- [4] Status LEDs, bus-specific and product-specific
- [5] RUN/STOP rotary switch
- [6] Ethernet interface (RJ45 socket, 8-pin)

**Pin allocation – CPX-CEC-C1/-M1**

	Pin	Signal	Meaning
<b>Fieldbus interface, Sub-D plug</b>			
	1	n.c.	Not connected
	2	CAN_L	CAN low
	3	CAN_GND	CAN ground
	4	n.c.	Not connected
	5	CAN_SHLD	Connection to functional earth FE
	6	CAN_GND	CAN ground (optional) <sup>1)</sup>
	7	CAN_H	CAN high
	8	n.c.	Not connected
	9	n.c.	Not connected
Housing	Shielding	Plug housing must be connected to FE	
<b>Ethernet interface, RJ45 plug</b>			
	1	TD+	Transmitted data+
	2	TD-	Transmitted data-
	3	RD+	Received data+
	4	n.c.	Not connected
	5	n.c.	Not connected
	6	RD-	Received data-
	7	n.c.	Not connected
	8	n.c.	Not connected
Housing	Shielding	Shielding	

1) If a servo drive is connected to an external power supply, CAN ground (optional), pin 6, cannot be used on the CPX-CEC-C1/-M1.



## Data sheet – CODESYS controller

## Connection and display elements CPX-CEC/CPX-CEC-S1-V3

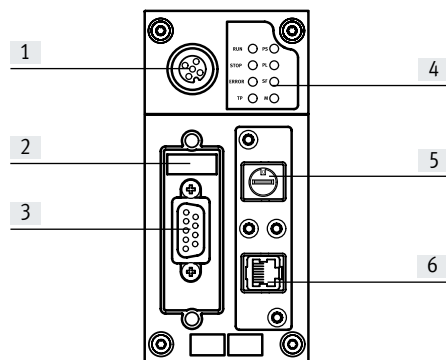







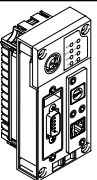
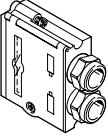

- [1] CPX-FMT connection
- [2] DIL switch
- [3] RS232 interface  
(Sub-D socket, 9-pin)
- [4] Status LEDs, bus-specific and  
product-specific
- [5] RUN/STOP rotary switch
- [6] Ethernet interface (RJ45 socket,  
8-pin)

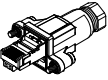

## Pin allocation – CPX-CEC/CPX-CEC-S1-V3

	Pin	Signal	Meaning
<b>RS 232 interface, Sub-D socket</b>			
	1	n.c.	Not connected
	2	RxD	Received data
	3	TxD	Transmitted data
	4	n.c.	Not connected
	5	GND	Data reference potential
	6	n.c.	Not connected
	7	n.c.	Not connected
	8	n.c.	Not connected
	9	n.c.	Not connected
	Shielding	Shielding	Connection to functional earth
<b>Ethernet interface, RJ45 plug</b>			
	1	TD+	Transmitted data+
	2	TD-	Transmitted data-
	3	RD+	Received data+
	4	n.c.	Not connected
	5	n.c.	Not connected
	6	RD-	Received data-
	7	n.c.	Not connected
	8	n.c.	Not connected
	Housing	Shielding	Shielding

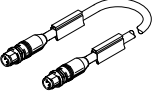
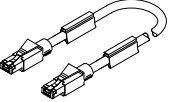
## Data sheet – CODESYS controller

Ordering data					Part no.	Type
Designation						
<b>Control block</b>						
	Motion functions for electric drives		CODESYS V2.3	155 g	567347	CPX-CEC-C1
			CODESYS V3	135 g	3473128	CPX-CEC-C1-V3
	SoftMotion functions for electric drives		CODESYS V3	135 g	3472765	CPX-CEC-M1-V3
	RS232 communication function		CODESYS V2.3	155 g	567346	CPX-CEC
			CODESYS V3	135 g	3472425	CPX-CEC-S1-V3
<b>Fieldbus interface</b>						
	Sub-D plug, 9-pin, for CANopen				532219	FBS-SUB-9-BU-2x5POL-B
	Micro style bus connection, 2xM12 for DeviceNet/CANopen				525632	FBA-2-M12-5POL
	Socket for micro style connection, M12				18324	FBSD-GD-9-5POL
	Plug for micro style connection, M12				175380	FBS-M12-5GS-PG9
	Open style bus connection for 5-pin terminal strip for DeviceNet/CANopen				525634	FBA-1-SL-5POL
	Terminal strip for open style connection, 5-pin				525635	FBSD-KL-2x5POL
<b>Ethernet interface</b>						
	RJ45 plug		Degree of protection IP 65, IP67		534494	FBS-RJ45-8-GS
	Cover for RJ45 connection		Degree of protection IP 65, IP67		534496	AK-RJ45
	Straight plug, RJ45, 8-pin	Straight plug, M12x1, 4-pin, D-coded	Degree of protection IP20	1 m	8040451	NEBC-D12G4-ES-1-S-R3G4-ET
				3 m	8040452	NEBC-D12G4-ES-3-S-R3G4-ET
				5 m	8040453	NEBC-D12G4-ES-5-S-R3G4-ET
				10 m	8040454	NEBC-D12G4-ES-10-S-R3G4-ET
	Straight plug, RJ45, 8-pin	Straight plug, RJ45, 8-pin	Degree of protection IP20	1 m	8040455	NEBC-R3G4-ES-1-S-R3G4-ET

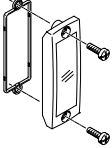
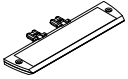
## Data sheet – CODESYS controller

Ordering data		Part no.	Type
Designation			
Covers and attachments			
	Inspection cover, transparent, for Sub-D connection	533334	AK-SUB-9/15-B
	Inscription label holder for connection block	536593	CPX-ST-1
User documentation			
	Manual for control block CPX-CEC	German	569121 P.BE-CPX-CEC-DE
		English	569122 P.BE-CPX-CEC-EN

## Data sheet – INTERBUS bus node



Bus node for handling communication between the electrical terminal CPX and a higher-order master via INTERBUS.

The bus node is provided with system supply via the interlinking block and processes communication with the I/O modules.

The status of the CPX terminal is displayed as a common message via 4 CPX-specific LEDs.

The fieldbus communication status is displayed via 4 INTERBUS-specific LEDs.

**Application**

## Bus connection

The bus connection is established via a 9-pin Sub-D socket and a 9-pin Sub-D plug with a typical INTERBUS pin allocation.

The bus connector plugs (with degree of protection IP65/IP67 from Festo or degree of protection IP20 from other manufacturers) facilitate the connection of the incoming and outgoing bus cable.

The outgoing bus plug contains the typical INTERBUS RBST bridge to identify the outgoing bus connection.

The Sub-D interfaces are designed for controlling network components with a fibre-optic cable connection.

## INTERBUS implementation

The CPX-FB6 supports the INTERBUS protocol to EN 50254.

In addition to cyclic I/O exchange, the optional PCP channel can be used for parameterisation and diagnostic functions.

The PCP channel provides access to advanced system information and allows parameterisation while the controller is running via the user program.

An example of this is access to the integrated diagnostic memory function, i.e. storage of the last 40 errors with timestamp, module, channel and error type.

With its address capacity of 96 inputs and 96 outputs, the CPX-FB6 supports a large number of I/O module configurations, including pneumatic interface.

**Note**

If the PCP channel is used, the maximum number of possible process data bits is reduced by 16.

## Points to note in connection with CPX-CEC

When a bus node is combined with a control block (CPX-CEC, in the fieldbus remote controller operating mode), the connected I/Os and/or valves, sensors and actuators are controlled via the CPX control block.

In this case, the bus node only provides the communication interface to the PLC.

Communication between the control block and CPX bus node takes place by interlinking the CPX modules and takes up the following address capacity in the CPX system:

- 8 byte outputs

- 8 byte inputs

The following address capacity remains in the control block or CPX system for activating the peripherals:

- 56 byte inputs

- 56 byte outputs

## Data sheet – INTERBUS bus node

General technical data			
Type	CPX-FB6		
Fieldbus interface	Socket and plug, Sub-D, 9-pin		
Baud rate	[Mbps]	0.5 and 2	
Bus type	Remote bus		
ID code	1, 2 or 3 (configuration-specific) 243 (PCP-channel activated)		
Profile	12 (I/O device)		
PCP channel	Yes, 16 bit (optional via DIL switch)		
Configuration support	Icons for CMD software		
Max. number of process data bits	Inputs	[bit]	96
	Outputs	[bit]	96
LED displays (bus-specific)	UL = Operating voltage for INTERBUS interface RC = Remote bus check BA = Bus active RD = Remote bus disable TR= Transmit/receive		
Device-specific diagnostics	Via peripherals error		
Parameterisation	<ul style="list-style-type: none"> <li>Start-up parameterisation via user functions (CMD)</li> <li>Via PCP communication</li> </ul>		
Additional functions	<ul style="list-style-type: none"> <li>Storage of the last 40 errors with timestamp (access via PCP)</li> <li>8-bit system status in image table for inputs</li> <li>2-byte inputs and 2-byte outputs, system diagnostics in process image</li> </ul>		
Control elements	DIL switch		
Operating voltage	Nominal value	[V DC]	24 (reverse polarity protected)
	Permissible range	[V DC]	18 ... 30
	Power failure buffering	[ms]	10
Current consumption			[mA]
Degree of protection to EN 60529	Typically 200		
Temperature range	Operation	[°C]	IP65, IP67
	Storage/transport	[°C]	-5 ... +50
Materials	-20 ... +70		
Grid dimension			[mm]
Dimensions (including interlinking block) W x L x H			[mm]
Product weight			[g]

 **Note**

Please observe the general limits and guidelines for the system when configuring the electrical modules.

## Data sheet – INTERBUS bus node

### Connection and display components

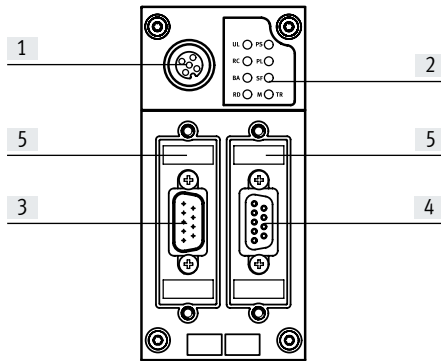

- [1] INTERBUS-specific LEDs
- [2] CPX-specific status LEDs
- [3] Fieldbus interface incoming (Sub-D plug, 9-pin)
- [4] Fieldbus interface outgoing (Sub-D socket, 9-pin)
- [5] DIL switch







### Pin allocation for INTERBUS interface

Pin allocation for Sub-D	Pin	Signal	Designation	Pin	Pin allocation for M12
<b>Incoming</b>					
	1	DO1	Data out	1	
	2	DI1	Data in	3	
	3	GND	Reference conductor/ground	5	
	4	n.c.	Not connected	2	
	5	n.c.	Not connected	4	
	6	/DO1	Data out inverse		
	7	/DI1	Data in inverse		
	8	n.c.	Not connected		
	9	n.c.	Not connected		
	Housing	Shielding	Connection to FE (functional earth) via R/C combination	Housing	
<b>Outgoing</b>					
	1	DO2	Data out	1	
	2	DI2	Data in	3	
	3	GND	Reference conductor/ground	5	
	4	n.c.	Not connected	2	
	5	+5 V	Station detection <sup>1)</sup>	4	
	6	/DO2	Data out inverse		
	7	/DI2	Data in inverse		
	8	n.c.	Not connected		
	9	RBST	Station detection <sup>1)</sup>		
	Housing	Shielding	Connection to FE (functional earth)	Housing	

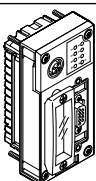
The incoming interface is galvanically isolated from the CPX peripherals. The plug housing is connected to the functional earth FE of the CPX terminal via an R/C combination.

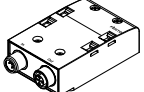
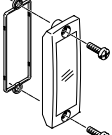
1) The CPX terminal contains the protocol chip SUP1 3 OPC. This ensures automatic detection of additional connected INTERBUS stations. There is therefore no need for a bridge between pin 5 and pin 9.

## Data sheet – INTERBUS bus node

Ordering data		Part no.	Type
Designation			
Bus node			
	INTERBUS bus node	<b>195748</b>	<b>CPX-FB6</b>
Bus connection			
	Sub-D plug	Incoming	<b>532218</b> <b>FBS-SUB-9-BU-IB-B</b>
		Outgoing	<b>532217</b> <b>FBS-SUB-9-GS-IB-B</b>
	Connection block M12 adapter (B-coded)	<b>534505</b>	<b>CPX-AB-2-M12-RK-IB</b>
	Inspection cover, transparent	<b>533334</b>	<b>AK-SUB-9/15-B</b>
	Inscription label holder for connection block	<b>536593</b>	<b>CPX-ST-1</b>
	5-pin M12 to mini USB socket adapter and controller software	<b>547432</b>	<b>NEFC-M12G5-0.3-U1G5</b>
User documentation			
	User documentation for bus node CPX-FB6	German	<b>526433</b> <b>P.BE-CPX-FB6-DE</b>
		English	<b>526434</b> <b>P.BE-CPX-FB6-EN</b>
		Spanish	<b>526435</b> <b>P.BE-CPX-FB6-ES</b>
		French	<b>526436</b> <b>P.BE-CPX-FB6-FR</b>
		Italian	<b>526437</b> <b>P.BE-CPX-FB6-IT</b>

## Data sheet – DeviceNet bus node



Bus node for handling communication between the electrical terminal CPX and a DeviceNet network.

The bus node is provided with system supply via the interlinking block and processes communication with the I/O modules.

The status of the CPX terminal is displayed as a common message via 4 CPX-specific LEDs.

The fieldbus communication status is displayed via the three DeviceNet-specific LEDs.

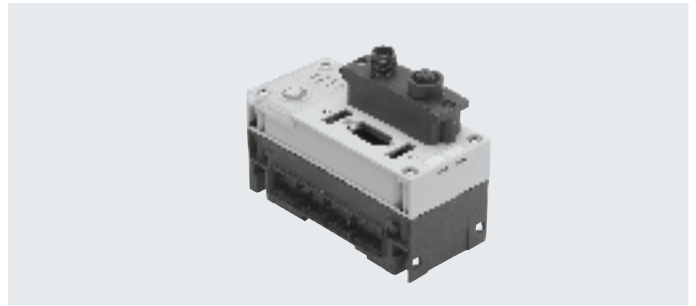

### Application

#### Bus connection

The bus connection can be selected when ordering, either micro style as 2xM12 round plugs or open style as a terminal strip with IP20 protection.

Both connection types have the function of an integrated T-distributor with incoming and outgoing bus line.

#### DeviceNet implementation

The CPX-FB11 operates with the Predefined Master/Slave Connection Set as a Group 2 Only Server.

The polled I/O, change of state or cyclic method is used for the transmission of cyclic I/O data. The type of transmission can be selected in the network configuration.

The device diagnostics for all bus nodes CPX-FB11 is effectively gathered via strobed I/O and displayed in the input table of the controller.

In addition to cyclic data transmission, acyclic communication is supported through explicit messaging, which enables detailed device diagnostics and parameterisation.

A comprehensive EDS file supports the display of acyclic data. It is also possible to display system information and assign parameters while the controller is running via the user program or the configuration software.

An example of this is access to the integrated diagnostic memory function, i.e. storage of the last 40 errors with timestamp, module, channel and error type.

With its address capacity of 64 byte inputs and 64 byte outputs, the CPX-FB11 supports any configuration of I/O modules, including pneumatic interface.

#### Points to note in connection with CPX-CEC

When a bus node is combined with a control block (CPX-CEC, in the fieldbus remote controller operating mode), the connected I/Os and/or valves, sensors and actuators are controlled via the CPX control block.

In this case, the bus node only provides the communication interface to the PLC.

Communication between the control block and CPX bus node takes place by interlinking the CPX modules and takes

up the following address capacity in the CPX system:

- 8 byte outputs
- 8 byte inputs

The following address capacity remains in the control block or CPX system for activating the peripherals:

- 56 byte inputs
- 56 byte outputs



## Data sheet – DeviceNet bus node

General technical data			
Type	CPX-FB11		
Fieldbus interface	Either <ul style="list-style-type: none"> <li>• Micro style bus connection: 2xM12 with degree of protection IP65, IP67</li> <li>• Open style bus connection: 5-pin terminal strip, IP20</li> </ul>		
Baud rate	[kbps]	125, 250, 500	
Addressing range	0 ... 63 Set using DIL switch		
Product	Type	Communication adapter (12 dec.)	
	Code	4554 dec.	
Types of communication	Polled I/O, change of state/cyclic, strobed I/O and explicit messaging		
Configuration support	EDS file and bitmaps		
Max. address capacity	Inputs	[byte]	64
	Outputs	[byte]	64
LED displays (bus-specific)	MS = Module status NS = Network status IO = I/O status		
Device-specific diagnostics	Module and channel-oriented diagnostics via manufacturer-specific diagnostic object		
Parameterisation	<ul style="list-style-type: none"> <li>• Module and system parameterisation via configuration interface in plain text (EDS)</li> <li>• Online in run or program mode</li> </ul>		
Additional functions	<ul style="list-style-type: none"> <li>• Storage of the last 40 errors with timestamp (access via EDS)</li> <li>• 8-bit system status in image table for inputs</li> <li>• 2-byte inputs and 2-byte outputs, system diagnostics in process image</li> </ul>		
Control elements	DIL switch		
Operating voltage	Nominal value	[V DC]	24
	Permissible range	[V DC]	18 ... 30
	Power failure buffering	[ms]	10
Current consumption		[mA]	Typically 200
Degree of protection to EN 60529	IP65, IP67		
Temperature range	Operation	[°C]	-5 ... +50
	Storage/transport	[°C]	-20 ... +70
Materials	Reinforced PA, PC		
Grid dimension		[mm]	50
Dimensions (including interlinking block) W x L x H		[mm]	50 x 107 x 50
Product weight		[g]	120

 **Note**

Please observe the general limits and guidelines for the system when configuring the electrical modules.

## Data sheet – DeviceNet bus node

### Connection and display components

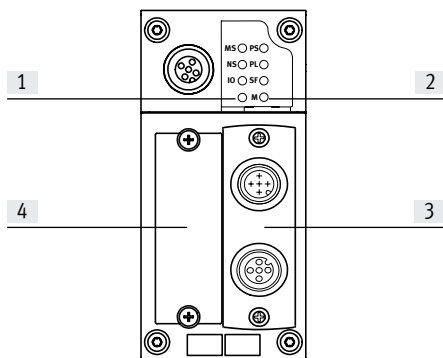





- [1] Bus-specific LEDs
- [2] CPX-specific status LEDs
- [3] Selectable fieldbus interface
  - Micro style
  - Open style
- [4] DIL switch cover

### Pin allocation for the DeviceNet interface

Terminal allocation	Pin	Signal-specific wire colour <sup>1)</sup>	Signal	Designation
<b>Sub-D plug</b>				
	1	–	n.c.	Not connected
	2	Blue	CAN_L	Received/transmitted data low
	3	Black	0 V bus	0 V CAN interface
	4	–	n.c.	Not connected
	5	Bare	Shielding	Connection to housing
	6	–	n.c.	Not connected
	7	White	CAN_H	Received/transmitted data high
	8	–	n.c.	Not connected
	9	Red	24 V DC bus	24 V DC supply CAN interface
<b>Micro style bus connection (M12), incoming/outgoing</b>				
<b>Incoming</b>				
	1	Bare	Shielding	Connection to housing
	2	Red	24 V DC bus	24 V DC supply CAN interface
	3	Black	0 V bus	0 V CAN interface
	4	White	CAN_H	Received/transmitted data high
	5	Blue	CAN_L	Received/transmitted data low
<b>Outgoing</b>				
	1	Bare	Shielding	Connection to housing
	2	Red	24 V DC bus	24 V DC supply CAN interface
	3	Black	0 V bus	0 V CAN interface
	4	White	CAN_H	Received/transmitted data high
	5	Blue	CAN_L	Received/transmitted data low
<b>Open style bus connection</b>				
	1	Black	0 V bus	0 V CAN interface
	2	Blue	CAN_L	Received/transmitted data low
	3	Bare	Shielding	Connection to housing
	4	White	CAN_H	Received/transmitted data high
	5	Red	24 V DC bus	24 V DC supply CAN interface
<b>7/8" bus connection</b>				
	1	Black	Shielding	Connection to housing
	2	Blue	24 V DC	24 V DC supply CAN interface
	3	Bare	0 V	0 V CAN interface
	4	White	CAN_H	Received/transmitted data high
	5	Red	CAN_L	Received/transmitted data low

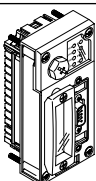
1) Typical of DeviceNet connecting cables

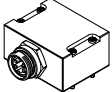
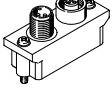
## Data sheet – DeviceNet bus node

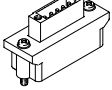
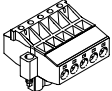
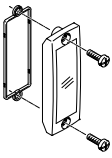
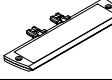
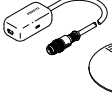
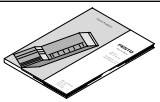
Ordering data		Part no.	Type	
Designation				
Bus node				
	DeviceNet bus node	526172	CPX-FB11	
Bus connection				
	Sub-D plug	532219	FBS-SUB-9-BU-2x5POL-B	
	Connection block, 9-pin Sub-D socket, 5-pin 7/8" plug	571052	CPX-AB-1-7/8-DN	
	Micro style bus connection, 2xM12	525632	FBA-2-M12-5POL	
	Socket for micro style connection, M12	18324	FBSD-GD-9-5POL	
	Plug for micro style connection, M12	175380	FBS-M12-5GS-PG9	
	Open style bus connection for 5-pin terminal strip	525634	FBA-1-SL-5POL	
	Terminal strip for open style connection, 5-pin	525635	FBSD-KL-2x5POL	
	Inspection cover, transparent	533334	AK-SUB-9/15-B	
	Inscription label holder for connection block	536593	CPX-ST-1	
	5-pin M12 to mini USB socket adapter and controller software	547432	NEFC-M12G5-0.3-U1G5	
User documentation				
	User documentation for bus node CPX-FB11	German	526421	P.BE-CPX-FB11-DE
		English	526422	P.BE-CPX-FB11-EN
		Spanish	526423	P.BE-CPX-FB11-ES
		French	526424	P.BE-CPX-FB11-FR
		Italian	526425	P.BE-CPX-FB11-IT

## Data sheet – PROFIBUS bus node



Bus node for handling communication between the electrical terminal CPX and a higher-order master via PROFIBUS DP.

The bus node is provided with system supply via the interlinking block and processes communication with the I/O modules.

The status of the CPX terminal is displayed as a common message via 4 CPX-specific LEDs.

The fieldbus communication status is displayed via the PROFIBUS-specific error LED.



### Application

#### Bus connection

The bus connection is established via a 9-pin Sub-D socket with a typical PROFIBUS allocation (to EN 50170).

The bus connector plug (with degree of protection IP65/IP67 from Festo or degree of protection IP20 from other manufacturers) facilitates the connection of an incoming and an outgoing bus cable.

An active bus terminal can be connected using the DIL switch integrated in the plug.

The Sub-D interface is designed for controlling network components with a fibre-optic cable connection.

#### PROFIBUS DP implementation

The CPX-FB13 supports the PROFIBUS DP protocol to EN 50170 Volume 2 for cyclic I/O exchange, parameterisation and diagnostic functions (DPV0).

In addition to DPV0, acyclic communication to the advanced specification DPV1 is supported. DPV1 provides acyclic access to advanced system information and allows parameterisation while the controller is running via the user program.

An example of this is access to the integrated diagnostic memory function, i.e. storage of the last 40 errors with timestamp, module, channel and error type.

With its address capacity of 64 byte inputs and 64 byte outputs, the CPX-FB13 supports any configuration of I/O modules, including pneumatic interface.

#### Points to note in connection with CPX-CEC

When a bus node is combined with a control block (CPX-CEC, in the fieldbus remote controller operating mode), the connected I/Os and/or valves, sensors and actuators are controlled via the CPX control block.

In this case, the bus node only provides the communication interface to the PLC.

Communication between the control block and CPX bus node takes place by interlinking the CPX modules and takes up the following address capacity in the CPX system:

- 8 byte outputs
  - 8 byte inputs
- The following address capacity remains in the control block or CPX system for activating the peripherals:
- 56 byte inputs
  - 56 byte outputs

## Data sheet – PROFIBUS bus node

General technical data			
Type	CPX-FB13		
Fieldbus interface	Sub-D socket, 9-pin (EN 50170) Galvanically isolated 5 V		
Baud rate	[Mbps]	0.0096 ... 12	
Addressing range	1 ... 125 Set using DIL switch		
Product family	4: Valves		
ID number	0x059E		
Types of communication	DPV0: Cyclic communication DPV1: Acyclic communication		
Configuration support	GSD file and bitmaps		
Max. address capacity	Inputs	[byte]	64
	Outputs	[byte]	64
LED displays (bus-specific)	BF: Bus fault		
Device-specific diagnostics	Identifier and channel-oriented diagnostics to EN 50170 (PROFIBUS standard)		
Parameterisation	<ul style="list-style-type: none"> <li>Start-up parameterisation via configuration interface in plain text (GSD)</li> <li>Acyclic parameterisation via DPV1</li> </ul>		
Additional functions	<ul style="list-style-type: none"> <li>Storage of the last 40 errors with timestamp (access via DPV1)</li> <li>8-bit system status in image table for inputs</li> <li>2-byte inputs and 2-byte outputs, system diagnostics in process image</li> </ul>		
Control elements	DIL switch		
Operating voltage	Nominal value	[V DC]	24
	Permissible range	[V DC]	18 ... 30
	Power failure buffering	[ms]	10
Current consumption	[mA]		Typically 200
Degree of protection to EN 60529	IP65, IP67		
Temperature range	Operation	[°C]	-5 ... +50
	Storage/transport	[°C]	-20 ... +70
Materials	Reinforced PA, PC		
RoHS status	RoHS-compliant according to EU directive		
Grid dimension	[mm]		50
Dimensions (including interlinking block) W x L x H	[mm]		50 x 107 x 50
Product weight	[g]		115

 **Note**

Please observe the general limits and guidelines for the system when configuring the electrical modules.

## Data sheet – PROFIBUS bus node

### Connection and display components

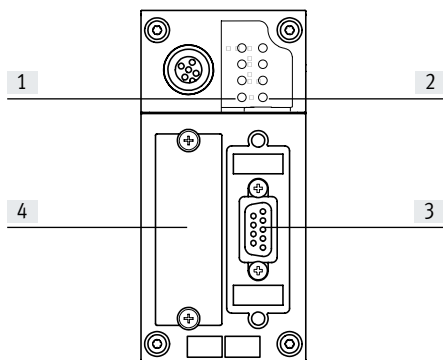

- [1] Bus status LEDs/bus fault
- [2] CPX-specific status LEDs
- [3] Fieldbus interface (Sub-D socket, 9-pin)
- [4] DIL switch cover

### Pin allocation for PROFIBUS DP interface



Terminal allocation	Pin	Signal	Designation
<b>Sub-D socket</b>			
	1	n.c.	Not connected
	2	n.c.	Not connected
	3	RxD/TxD-P	Received/transmitted data P
	4	CNTR-P <sup>1)</sup>	Repeater control signal
	5	DGND	Data reference potential (M5V)
	6	VP	Supply voltage (P5V)
	7	n.c.	Not connected
	8	RxD/TxD-N	Received/transmitted data N
	9	n.c.	Not connected
Housing	Shielding	Connection to housing	
<b>Bus connection M12 adapter (B-coded)</b>			
<b>Incoming</b>			
	1	n.c.	Not connected
	2	RxD/TxD-N	Received/transmitted data N
	3	n.c.	Not connected
	4	RxD/TxD-P	Received/transmitted data P
	5 and M12	Shielding	Connection to FE (functional earth)
<b>Outgoing</b>			
	1	VP	Supply voltage (P5V)
	2	RxD/TxD-N	Received/transmitted data N
	3	DGND	Data reference potential (M5V)
	4	RxD/TxD-P	Received/transmitted data P
	5 and M12	Shielding	Connection to FE (functional earth)

1) The repeater control signal CNTR-P is realised as a TTL signal.

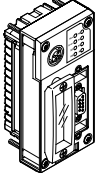
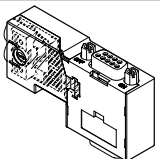
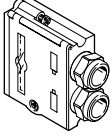
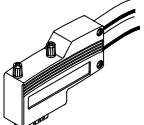
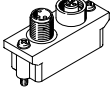
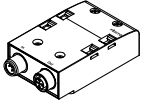
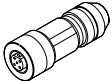
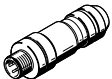
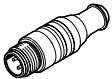
## Data sheet – PROFIBUS bus node

Ordering data		Part no.	Type
Designation			
<b>Bus node</b>			
	PROFIBUS bus node	<b>195740</b>	<b>CPX-FB13</b>
<b>Bus connection</b>			
	Sub-D plug, straight, with terminating resistor and programming interface	<b>574589</b>	<b>NECU-S1W9-C2-APB</b>
	Sub-D plug, straight	<b>532216</b>	<b>FBS-SUB-9-GS-DP-B</b>
	Sub-D plug, angled	<b>533780</b>	<b>FBS-SUB-9-WS-PB-K</b>
	Bus connection M12 adapter (B-coded)	<b>533118</b>	<b>FBA-2-M12-5POL-RK</b>
	Connection block M12 adapter (B-coded)	<b>541519</b>	<b>CPX-AB-2-M12-RK-DP</b>
	5-pin M12x1 straight socket, for self-assembly of a connecting cable compatible with FBA-2-M12-5POL-RK and CPX-AB-2-M12-RK-DP	<b>1067905</b>	<b>NECU-M-B12G5-C2-PB</b>
	Plug M12x1, 5-pin, straight, for self-assembly of a connecting cable compatible with FBA-2-M12-5POL-RK and CPX-AB-2-M12-RK-DP	<b>1066354</b>	<b>NECU-M-S-B12G5-C2-PB</b>
	Terminating resistor, M12, B-coded for PROFIBUS	<b>1072128</b>	<b>CACR-S-B12G5-220-PB</b>

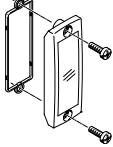
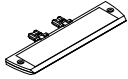
## Data sheet – PROFIBUS bus node

Ordering data		Part no.	Type	
Designation				
<b>Bus connection</b>				
	Inspection cover, transparent	533334	AK-SUB-9/15-B	
	Inscription label holder for connection block M12	536593	CPX-ST-1	
	5-pin M12 to mini USB socket adapter and controller software	547432	NEFC-M12G5-0.3-U1G5	
<b>User documentation</b>				
	User documentation for bus node CPX-FB13	German	526427	P.BE-CPX-FB13-DE
		English	526428	P.BE-CPX-FB13-EN
		Spanish	526429	P.BE-CPX-FB13-ES
		French	526430	P.BE-CPX-FB13-FR
		Italian	526431	P.BE-CPX-FB13-IT



## Data sheet – CANopen bus node



Bus node for handling communication between the electrical terminal CPX and a CANopen network master or CANopen network.

The bus node is provided with system supply via the interlinking block and processes communication with the I/O modules.

The status of the CPX terminal is displayed as a common message via 4 CPX-specific LEDs.

The different CANopen statuses and the fieldbus communication status are visualised via 3 additional LEDs.

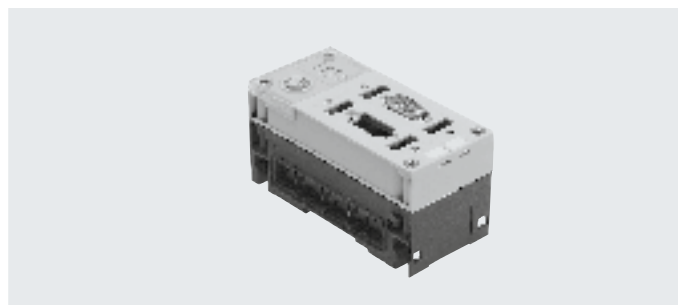

### Application

#### Bus connection

The bus connection is established via a 9-pin Sub-D plug (pin) as per the CAN in Automation (CiA) specification DS 102 with additional 24 V CAN transceiver supply (option as per DS 102).

The bus connector plug (with degree of protection IP65/IP67 from Festo or degree of protection IP20 from other manufacturers) facilitates the connection of an incoming and an outgoing bus cable.

There are 4 contacts available for the 4 wires (CAN\_L, CAN\_H, 24 V, 0 V) of the incoming and outgoing bus cables respectively.

#### CANopen implementation

The CPX-FB14 supports the CANopen protocol in accordance with the specifications DS 301 V4.01 and DS 401 V2.0.

Implementation is based on the CiA Predefined Connection Set.

There are 4 PDOs available for fast I/O data exchange.

Enhanced system information can also be accessed via SDO communication. SDO communication also facilitates parameterisation before network start-up or while the controller is running via the user program.

An example of this is access to the integrated diagnostic memory function, i.e. storage of the last 40 errors with timestamp, module, channel and error type.

With its address capacity, the CPX-FB14 supports a large number of I/O module configurations, including pneumatic interface.

By default, 8 byte digital inputs and 8 byte digital outputs can be addressed via PDO 1.

8 analogue input channels and 8 analogue output channels can be addressed via PDO 2 and 3. Status and diagnostic information can be evaluated via PDO 4.

Additional 8 byte digital inputs and outputs as well as 8 analogue input and output channels can be addressed via mapping.

#### Points to note in connection with CPX-CEC

When a bus node is combined with a control block (CPX-CEC, in the fieldbus remote controller operating mode), the connected I/Os and/or valves, sensors and actuators are controlled via the CPX control block.

In this case, the bus node only provides the communication interface to the PLC.

Communication between the control block and CPX bus node takes place by interlinking the CPX modules and takes

up the following address capacity in the CPX system:

- 8 byte outputs
- 8 byte inputs

The following address capacity remains in the control block or CPX system for activating the peripherals:

- 56 byte inputs
- 56 byte outputs

## Data sheet – CANopen bus node

General technical data			
Type	CPX-FB14		
Fieldbus interface	Sub-D plug, 9-pin (to DS 102) Bus interface galvanically isolated via optocoupler 24 V supply for CAN interface via bus		
Baud rate	[kbps]	125, 250, 500 and 1000 can be set via DIL switch	
Addressing range	Node ID 1 ... 127 Set using DIL switch		
Product family	Digital inputs and outputs		
Communication profile	DS 301, V4.01		
Device profile	DS 401, V2.0		
Number	PDO	4 Tx/4 Rx	
	SDO	1 server SDO	
Configuration support	EDS file and bitmaps		
Max. address capacity	Inputs	[byte]	16 digital, 16 analogue channels
	Outputs	[byte]	16 digital, 16 analogue channels
LED displays (bus-specific)	MS = Module status NS = Network status IO = I/O status		
Device-specific diagnostics	Via emergency message Object 1001, 1002 and 1003		
Parameterisation	Via SDO		
Additional functions	<ul style="list-style-type: none"> <li>• Storage of the last 40 errors with timestamp (access via SDO)</li> <li>• 8-bit system status via transmit PDO 4 (default)</li> <li>• 2-byte inputs and 2-byte outputs, system diagnostics via PDO 4</li> <li>• Minimum boot-up</li> <li>• Variable PDO mapping</li> <li>• Emergency message</li> <li>• Node guarding</li> <li>• Heart beat</li> </ul>		
Control elements	DIL switch		
Operating voltage	Nominal value	[V DC]	24
	Permissible range	[V DC]	18 ... 30
	Power failure buffering	[ms]	10
Current consumption			[mA] Typically 200
Degree of protection to EN 60529	IP65, IP67		
Temperature range	Operation	[°C]	-5 ... +50
	Storage/transport	[°C]	-20 ... +70
Materials	Reinforced PA, PC		
Grid dimension			[mm] 50
Dimensions (including interlinking block) W x L x H			[mm] 50 x 107 x 50
Product weight			[g] 115

 **Note**

Please observe the general limits and guidelines for the system when configuring the electrical modules.

## Data sheet – CANopen bus node

## Connection and display components

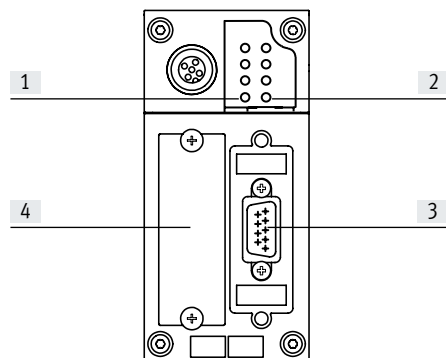





- [1] Bus-specific LEDs
- [2] CPX-specific status LEDs
- [3] Fieldbus interface (Sub-D plug, 9-pin)
- [4] DIL switch cover

## Pin allocation of the CANopen interface

Terminal allocation	Pin	Signal	Designation
<b>Sub-D plug</b>			
	1	n.c.	Not connected
	2	CAN_L	Received/transmitted data low
	3	CAN_GND	0 V CAN interface
	4	n.c.	Not connected
	5	CAN_SHLD	Optional shielded connection
	6	GND	Ground <sup>1)</sup>
	7	CAN_H	Received/transmitted data high
	8	n.c.	Not connected
	9	CAN_V+	24 V DC supply CAN interface
Housing	Shielding	Connection to FE (functional earth)	
<b>Micro style bus connection (M12)</b>			
<b>Incoming</b>			
	1	Shielding	Connection to FE (functional earth)
	2	CAN_V+	24 V DC supply CAN interface
	3	CAN_GND	0 V CAN interface
	4	CAN_H	Received/transmitted data high
	5	CAN_L	Received/transmitted data low
<b>Outgoing</b>			
	1	Shielding	Connection to FE (functional earth)
	2	CAN_V+	24 V DC supply CAN interface
	3	CAN_GND	0 V CAN interface
	4	CAN_H	Received/transmitted data high
	5	CAN_L	Received/transmitted data low
<b>Open style bus connection</b>			
	1	CAN_GND	0 V CAN interface
	2	CAN_L	Received/transmitted data low
	3	Shielding	Connection to FE (functional earth)
	4	CAN_H	Received/transmitted data high
	5	CAN_V+	24 V DC supply CAN interface

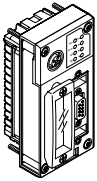
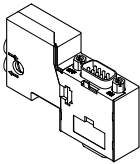
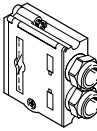
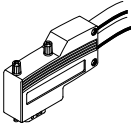
1) Connected internally via Pin 3

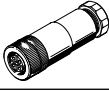
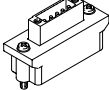
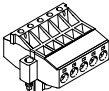
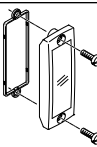
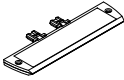
## Data sheet – CANopen bus node

Ordering data		Part no.	Type
Designation			
Bus node			
	CANopen bus node	526174	CPX-FB14
Bus connection			
	Sub-D socket for CANopen with terminating resistor and programming interface	574588	NECU-S1W9-C2-ACO
	Sub-D socket	532219	FBS-SUB-9-BU-2x5POL-B
	Sub-D socket, angled	533783	FBS-SUB-9-WS-CO-K
	Connection block, 9-pin Sub-D socket, 5-pin 7/8" plug	571052	CPX-AB-1-7/8-DN
	Micro style bus connection, 2xM12, 5-pin	525632	FBA-2-M12-5POL
	Fieldbus socket for micro style connection, M12, 5-pin	18324	FBSD-GD-9-5POL
	Plug for micro style connection, M12, 5-pin	175380	FBS-M12-5GS-PG9
	Open style bus connection	525634	FBA-1-SL-5POL
	Terminal strip for open style connection, 5-pin	525635	FBSD-KL-2x5POL
	Inspection cover, transparent	533334	AK-SUB-9/15-B
	Inscription label holder for connection block	536593	CPX-ST-1
	5-pin M12 to mini USB socket adapter and controller software	547432	NEFC-M12G5-0.3-U1G5
User documentation			
	User documentation for bus node CPX-FB14	German	526409 P.BE-CPX-FB14-DE
		English	526410 P.BE-CPX-FB14-EN
		Spanish	526411 P.BE-CPX-FB14-ES
		French	526412 P.BE-CPX-FB14-FR
		Italian	526413 P.BE-CPX-FB14-IT

## Data sheet – INTERBUS bus node



Bus node for handling communication between the electrical terminal CPX and a higher-order master via INTERBUS.

The bus node processes communication with the I/O modules.

The status of the CPX terminal is displayed as a common message via 4 CPX-specific LEDs.

The fieldbus communication status is displayed via 6 INTERBUS-specific LEDs.

**Application**

## Bus connection

The bus connection is established via a socket with INTERBUS Rugged Line connection technology and an associated plug, with fibre-optic cables used for the combined power supply to the valve terminal and data transmission.

The bus node is used as a remote I/O. It supports processing of max. 96 inputs and 96 outputs or max. 6 analogue I/O channels.

The I/O area is divided into:

- Digital IO
- Analogue I/O
- System status/system diagnostics (optional)
- PCP channel (optional)

## INTERBUS implementation

The CPX-M-FB21 supports the INTERBUS protocol to EN 50254. In addition to cyclic I/O exchange, the optional PCP channel can be used for parameterisation and diagnostic functions.

An example of this is access to the integrated diagnostic memory function, i.e. storage of the last 40 errors with timestamp, module, channel and error type.

The PCP channel provides access to advanced system information and assigns operation parameters while the controller is running via the user program.

**Note**

If the PCP channel is used, the maximum number of possible process data bits is reduced by 16.

## Points to note in connection with CPX-FB21

- Remote Controller operating mode is not supported. A CPX-CEC cannot be used in combination with CPX-M-FB21 in a CPX terminal.
- Power is supplied via the fieldbus connection. It is therefore not possible to use an interlinking block with system supply within a CPX terminal with CPX-M-FB21.
- Only the valve terminals VTSA and VTSA-F with pneumatic interface VABA-S6-1-X2 can be selected as the pneumatic part.

## Data sheet – INTERBUS bus node

General technical data			
Type	CPX-M-FB21		
Fieldbus interface	Rugged Line fibre-optic cable connection		
Baud rate	[Mbps]	0.5 and 2	
Bus type	Remote bus		
Max. address capacity	Inputs	[bit]	96
	Outputs	[bit]	96
LED displays	INTERBUS-specific		BA = Bus active FO1 = Fibre-optic cable 1 FO2 = Fibre-optic cable 2 RC = Remote bus check RD = Remote bus disable UL = Operating voltage for INTERBUS interface
	CPX-specific		M = Parameterisation SF = System fault US1 = Electronics supply, sensor supply US2 = Load supply
Device-specific diagnostics	<ul style="list-style-type: none"> <li>Diagnostic memory</li> <li>Channel and module-oriented diagnostics</li> <li>Undervoltage of modules</li> </ul>		
Parameterisation	<ul style="list-style-type: none"> <li>Diagnostic behaviour</li> <li>Fail-safe response</li> <li>Forcing of channels</li> <li>Signal setup</li> <li>System parameters</li> </ul>		
Additional functions	<ul style="list-style-type: none"> <li>Module and system parameterisation via operator units</li> <li>System status can be displayed using process data</li> <li>Additional diagnostic interface for operator units</li> </ul>		
Control elements	DIL switch		
Operating voltage	Nominal value	[V DC]	24 (reverse polarity protected)
	Permissible range	[V DC]	18 ... 30
Intrinsic current consumption at nominal operating voltage		[mA]	Typically 90
Degree of protection to EN 60529	IP65, IP67		
Temperature range	Operation	[°C]	-5 ... +50
	Storage/transport	[°C]	-20 ... +70
CE marking (see declaration of conformity)	To EU EMC Directive		
Information on materials: Housing	Aluminium		
Note on materials	RoHS-compliant		
Grid dimension		[mm]	50
Dimensions (including interlinking block) W x L x H		[mm]	100 x 110 x 130
Product weight	CPX-FB21	[g]	1255

 **Note**

Please observe the general limits and guidelines for the system when configuring the electrical modules.

## Data sheet – INTERBUS bus node

## Connection and display components

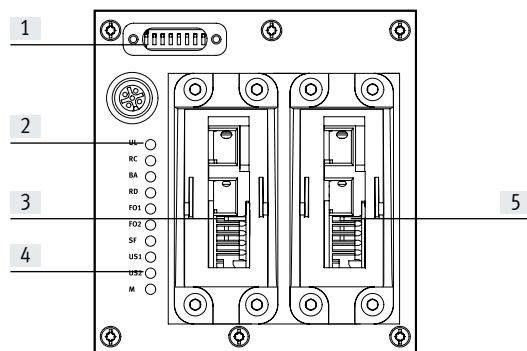



- [1] DIL switch
- [2] INTERBUS-specific LEDs
- [3] Fieldbus connection, incoming
- [4] CPX-specific status LEDs
- [5] Fieldbus connection, outgoing

## Pin allocation for INTERBUS interface

FOC pin allocation	Pin	Wire colour	Designation
<b>Incoming</b>			
	A	Black	Transmitted data
	B	Orange	Received data
	1	–	24 V supply for electronics and inputs
	2	–	0 V supply for electronics and inputs
	3	–	24 V supply for valves and outputs
	4	–	0 V supply for valves and outputs
5	–	Functional earth	
<b>Outgoing</b>			
	A	Orange	Transmitted data
	B	Black	Received data
	1	–	24 V supply for electronics and inputs
	2	–	0 V supply for electronics and inputs
	3	–	24 V supply for valves and outputs
	4	–	0 V supply for valves and outputs
5	–	Functional earth	

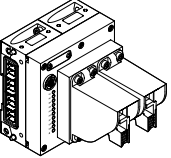
Data sheet – INTERBUS bus node

Ordering data		Part no.	Type	
Designation				
Bus node				
	INTERBUS bus node, incoming and outgoing fieldbus interface	572221	CPX-M-FB21	
Bus connection				
	Cover plate for covering the DIL switches	572818	CPX-M-FB21-IB-RL	
User documentation				
	User documentation for bus node CPX-M-FB21	German	575107	P.BE-CPX-FB20/21-DE
		English	575108	P.BE-CPX-FB20/21-EN
		Spanish	575109	P.BE-CPX-FB20/21-ES
		French	575110	P.BE-CPX-FB20/21-FR
		Italian	575111	P.BE-CPX-FB20/21-IT



## Data sheet – CC-Link bus node

# CC-Link

Bus node for handling communication between the electrical terminal CPX and a higher-order master for Control & Communication-Link (CC-Link) from Mitsubishi.

The bus node is provided with system supply via the interlinking block and processes communication with the I/O modules.

The status of the CPX terminal is displayed as a common message via 4 CPX-specific LEDs.

The fieldbus communication status is displayed via 4 CC-Link-specific LEDs.



## Application

### Bus connection

The bus connection can be selected when ordering and is established via a screw terminal with degree of protection IP20, a Sub-D plug with degree of

protection IP65/IP67 from Festo or degree of protection IP20 from other manufacturers.

Both connection types have the function of an integrated T-distributor and thus support the connection of an incoming and outgoing bus cable.

### CC-Link implementation

The CPX bus node CPX-FB23-24 optionally supports the CC-Link versions 2.0 (as function module F24) and 1.1 (as function module F23).

These designations are also found in the system diagram for the CPX Maintenance Tool (CPX-FMT) from Festo.

Function module F24 corresponds to CC-Link version 2.0 and supports a maximum of four stations per slave, up to an address capacity of 64 bytes of digital I/O and 64 bytes of analogue I/O in each case.

It is possible to optimise the configuration of the addressing in terms of either cycle time or station.

Function module F23 corresponds to CC-Link version 1.1 and supports a maximum of four stations per slave, up to an address capacity of 32 bytes of digital I/O and 14 bytes of analogue I/O in each case.

The function module and option are set using the DIL switch on the CPX bus node.

### Points to note in connection with CPX-CEC

When a bus node is combined with a control block (CPX-CEC, in the fieldbus remote controller operating mode), the connected I/Os and/or valves, sensors and actuators are controlled via the CPX control block.

In this case, the bus node only provides the communication interface to the PLC.

Communication between the control block and CPX bus node takes place by interlinking the CPX modules and takes

up the following address capacity in the CPX system:

- 8 byte outputs
- 8 byte inputs

The following address capacity remains in the control block or CPX system for activating the peripherals:

- 56 byte inputs
- 56 byte outputs

## Data sheet – CC-Link bus node

General technical data				
Type	CPX-FB23-24			
Fieldbus interface	Either <ul style="list-style-type: none"> <li>• Sub-D socket, 9-pin</li> <li>• Sub-D plug, for self-assembly</li> <li>• Screw terminal strip, IP20</li> </ul>			
Baud rate	[kbps]	156 ... 10000		
Protocol	CC-Link			
Max. address capacity, inputs	FB23	RWr	[byte]	32
		Rx	[byte]	14
	FB24	RWr	[byte]	64
		Rx	[byte]	64
Max. address volume for outputs	FB23	RWw	[byte]	32
		Ry	[byte]	14
	FB24	RWw	[byte]	64
		Ry	[byte]	64
LED displays (bus-specific)	RUN = Communication status ERROR = Communication error SD = Send data RD = Receive data			
Device-specific diagnostics	<ul style="list-style-type: none"> <li>• Diagnostic memory</li> <li>• Channel and module-oriented diagnostics</li> <li>• Undervoltage of modules</li> </ul>			
Parameterisation	<ul style="list-style-type: none"> <li>• Diagnostic behaviour</li> <li>• Fail-safe response</li> <li>• Forcing of channels</li> <li>• Signal setup</li> <li>• System parameters</li> </ul>			
Additional functions	<ul style="list-style-type: none"> <li>• System status can be displayed using process data</li> <li>• Additional diagnostic interface for operator units</li> </ul>			
Control elements	DIL switch			
Operating voltage	Nominal value	[V DC]	24	
	Permissible range	[V DC]	18 ... 30	
Current consumption		[mA]	Typically 200	
Degree of protection to EN 60529	IP65, IP67			
Temperature range	Operation	[°C]	-5 ... +50	
	Storage/transport	[°C]	-20 ... +70	
Materials	Reinforced PA, PC			
Grid dimension		[mm]	50	
Dimensions (including interlinking block) W x L x H		[mm]	50 x 107 x 50	
Product weight		[g]	115	

 **Note**

Please observe the general limits and guidelines for the system when configuring the electrical modules.

## Data sheet – CC-Link bus node

### Connection and display components

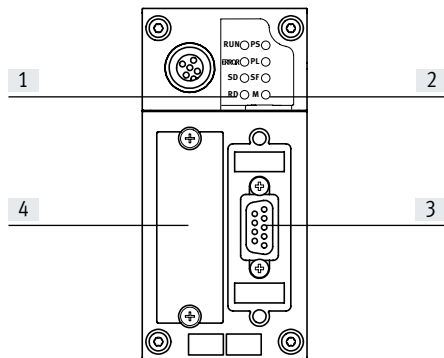



- [1] Bus-specific status LEDs
- [2] CPX-specific status LEDs
- [3] Fieldbus interface (Sub-D socket, 9-pin)
- [4] DIL switch cover

#### Pin allocation for the CC-Link interface

Terminal allocation	Pin	Signal	Designation
<b>Sub-D socket</b>			
	1	n.c.	Not connected
	2	DA	Data A
	3	DG	Data reference potential
	4	n.c.	Not connected
	5	FE <sup>1)</sup>	Functional earth
	6	n.c.	Not connected
	7	DB	Data B
	8	n.c.	Not connected
	9	n.c.	Not connected
<b>Screw terminal bus connection</b>			
	1	FG	Functional earth/housing
	2	SLD	Shielding
	3	DG	Data reference potential
	4	DB	Data B
	5	DA	Data A

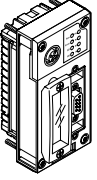
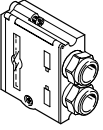
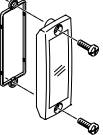
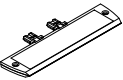
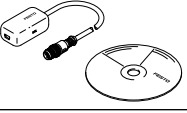
## Data sheet – CC-Link bus node

Ordering data		Part no.	Type
Designation			
Bus node			
	CC-Link bus node	526176	CPX-FB23-24
Bus connection			
	Sub-D plug	532220	FBS-SUB-9-GS-2x4POL-B
	Inspection cover, transparent	533334	AK-SUB-9/15-B
	Inscription label holder for connection block	536593	CPX-ST-1
	5-pin M12 to mini USB socket adapter and controller software	547432	NEFC-M12G5-0.3-U1G5
User documentation			
	User documentation for bus node CPX-FB23-24	German	526403 P.BE-CPX-FB23-24-DE
		English	526404 P.BE-CPX-FB23-24-EN
		Chinese	8026069 P.BE-CPX-FB23-24-ZH

## Data sheet – PROFINET bus node, M12, D-coded



Bus node for operating the CPX valve terminal on PROFINET.

The bus node is provided with system supply via the interlinking block and processes communication with the I/O modules.

The status of the CPX terminal is displayed as a common message via 4 CPX-specific LEDs.

The fieldbus communication status is displayed via three bus-specific LEDs.



### Application

#### Bus connection

The bus connection is established via two M12 sockets, D-coded to IEC 61076-2-101 with degree of protection IP65, IP67.

Both connections are equivalent 100BaseTX Ethernet ports with integrated auto MDI functionality (crossover and patch cables can be used) that are brought together via an internal switch.

- Maximum segment length 100 m
- Transmission rate 100 Mbps

#### PROFINET implementation

The bus nodes support the PROFINET protocol on the basis of the Ethernet standard and TCP/IP technology to IEEE802.3.

This guarantees a data exchange with a high data transmission rate, for example I/O data from sensors, actuators or robot controllers, PLCs or process equipment. In addition, non-real-time critical information such as diagnostic

information, configuration information, etc. can be transferred. The Ethernet bandwidth is sufficient to transfer both data types (real-time and non-real-time) in parallel.

The bus node features LEDs for bus status and CPX peripheral information as well as switch elements, memory stick and a diagnostic interface. The

purpose of the memory stick is to guarantee fast replacement of the bus node in the event of an error. PROFINET provides the user with access to all peripherals, diagnostic data and parameter data of the CPX valve terminal. The bus node can be used as a remote I/O or remote controller. All information relevant to the CPX can be read out

and, dependent on the function, changed via CPX-FMT.

#### Points to note in connection with CPX-CEC

When a bus node is combined with a control block (CPX-CEC, in the fieldbus remote controller operating mode), the connected I/Os and/or valves, sensors and actuators are controlled via the CPX control block.

In this case, the bus node only provides the communication interface to the PLC.

Communication between the control block and CPX bus node takes place by interlinking the CPX modules and takes

up the following address capacity in the CPX system:

- 8 byte outputs
- 8 byte inputs

The following address capacity remains in the control block or CPX system for activating the peripherals:

- 56 byte inputs
- 56 byte outputs

## Data sheet – PROFINET bus node, M12, D-coded

General technical data			CPX-FB33	CPX-FB43
Type			2x socket, M12, 4-pin, D-coded	
Fieldbus interface			2x socket, M12, 4-pin, D-coded	
Baud rate		[Mbps]	100	
Protocol			PROFINET RT PROFINET IRT	
Max. address capacity	Inputs	[byte]	64	
	Outputs	[byte]	64	
LED displays	(bus-specific)		M/P = Maintenance/PROFenergy NF = Network fault TP1 = Network active port 1 TP2 = Network active port 2	
	(product-specific)		M = Modify, parameterisation PL = Load supply PS = Electronic supply, sensor supply SF = System fault	
Device-specific diagnostics			<ul style="list-style-type: none"> <li>Channel and module-oriented diagnostics</li> <li>Undervoltage of modules</li> <li>Diagnostic memory</li> </ul>	
Configuration support			GSDML file	
Parameterisation			<ul style="list-style-type: none"> <li>System parameters</li> <li>Diagnostic behaviour</li> <li>Signal setup</li> <li>Fail-safe response</li> <li>Forcing of channels</li> </ul>	
Additional functions			<ul style="list-style-type: none"> <li>Start-up parameterisation in plain text via fieldbus</li> <li>Fast start-up (FSU)</li> <li>Channel-oriented diagnostics via fieldbus</li> <li>Acyclic data access via fieldbus and via Ethernet</li> <li>System status can be displayed using process data</li> <li>Additional diagnostic interface for operator unit</li> </ul>	
				<ul style="list-style-type: none"> <li>I&amp;M</li> <li>LLDP</li> <li>MRP</li> <li>MRPD</li> <li>MQTT</li> <li>PROFIsafe</li> <li>PROFenergy</li> <li>S2 system redundancy</li> </ul>
Control elements			<ul style="list-style-type: none"> <li>DIL switch</li> <li>Optional memory card</li> </ul>	<ul style="list-style-type: none"> <li>DIL switch</li> </ul>
Operating voltage	Nominal value	[V DC]	24	
	Permissible range	[V DC]	18 ... 30	
Current consumption		[mA]	Typically 120	Typically 70
Degree of protection to EN 60529			IP65, IP67	
Temperature range	Operation	[°C]	- 5... +50	
	Storage/transport	[°C]	-20 ... +70	
Certification				RCM
Materials	Housing		Die-cast aluminium	
Note on materials				RoHS-compliant
Dimensions (including interlinking block) W x L x H		[mm]	50 x 107 x 50	50 x 107 x 50
Product weight		[g]	280	185

 **Note**  
Please observe the general limits and guidelines for the system when configuring the electrical modules.

 **Note**  
Always use the correct screws for the interlinking block; this depends on whether the block is made of metal or plastic:

- Self-tapping screws for plastic interlinking blocks
- Screws with metric thread for metal interlinking blocks

## Data sheet – PROFINET bus node, M12, D-coded

### Connection and display components

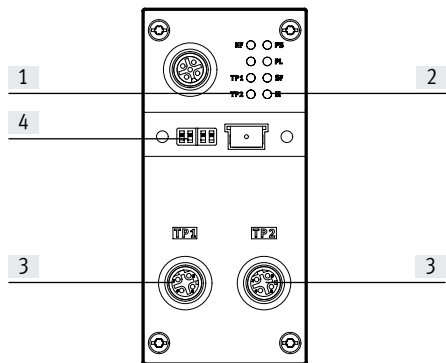



- [1] Bus-specific status LEDs
- [2] CPX-specific status LEDs
- [3] Fieldbus interface (M12 socket, 4-pin, D-coded)
- [4] Transparent cover for DIL switch and memory card

### Pin allocation for the fieldbus interface

Terminal allocation	Pin	Signal	Designation
<b>Socket, M12, D-coded</b>			
	1	TD+	Transmitted data+
	2	RD+	Received data+
	3	TD-	Transmitted data-
	4	RD-	Received data-
	Housing		Shielding

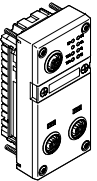
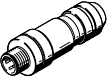
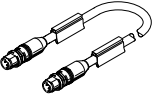
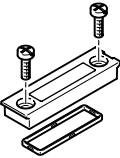
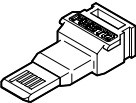
Data sheet – PROFINET bus node, M12, D-coded

Ordering data				Part no.	Type
Bus node					
	PROFINET bus node	–		548755	CPX-FB33
		<ul style="list-style-type: none"> <li>• I&amp;M</li> <li>• LLDP</li> <li>• MRP</li> <li>• MRPD</li> <li>• PROFlenergy</li> <li>• S2 system redundancy</li> </ul>		8110369	CPX-FB43
Bus connection					
	Plug M12x1, 4-pin, D-coded			543109	NECU-M-S-D12G4-C2-ET
	Connecting cable, straight plug, M12x1, 4-pin, D-coded	Straight plug, M12x1, 4-pin, D-coded	0.5 m	8040446	NEBC-D12G4-ES-0.5-S-D12G4-ET
			1 m	8040447	NEBC-D12G4-ES-1-S-D12G4-ET
			3 m	8040448	NEBC-D12G4-ES-3-S-D12G4-ET
			5 m	8040449	NEBC-D12G4-ES-5-S-D12G4-ET
			10 m	8040450	NEBC-D12G4-ES-10-S-D12G4-ET
		Straight plug, RJ45, 8-pin	1 m	8040451	NEBC-D12G4-ES-1-S-R3G4-ET
			3 m	8040452	NEBC-D12G4-ES-3-S-R3G4-ET
			5 m	8040453	NEBC-D12G4-ES-5-S-R3G4-ET
Open end, 4-wire	10 m	8040454	NEBC-D12G4-ES-10-S-R3G4-ET		
5 m	8040456	NEBC-LE4-ES-5-D12G4-ET			
	Transparent cover for DIL switch and memory card			548757	CPX-AK-P
	Memory card for PROFINET bus node, 2MB			4798288	CPX-SK-3
	Cover cap for sealing unused bus connections (10 pieces)			165592	ISK-M12
User documentation					
	Electronics manual, CPX bus node, type CPX-FB33	German		548759	CPX-(M)-FB33_35/43_45-DE
		English		548760	CPX-(M)-FB33_35/43_45-EN
		Spanish		548761	CPX-(M)-FB33_35/43_45-ES
		French		548762	CPX-(M)-FB33_35/43_45-FR
		Italian		548763	CPX-(M)-FB33_35/43_45-IT



## Data sheet – PROFINET bus node, push-pull RJ45



Bus node for operating the CPX valve terminal on PROFINET.

The bus node is provided with system supply via the interlinking block and processes communication with the I/O modules.

The status of the CPX terminal is displayed as a common message via 4 CPX-specific LEDs.

The fieldbus communication status is displayed via 4 bus-specific LEDs.



### Application

#### Bus connection

The bus connection is established via two RJ45 push-pull sockets to IEC 61076-3-106 and IEC 60603 with degree of protection IP65, IP67.

Both connections are equivalent 100BaseTX Ethernet ports with integrated auto MDI functionality (crossover and patch cables can be used) that are brought together via an internal switch.

- Maximum segment length 100 m
- Transmission rate 100 Mbps

#### PROFINET implementation

The bus nodes support the PROFINET protocol on the basis of the Ethernet standard and TCP/IP technology to IEEE802.3.

This guarantees a data exchange with a high data transmission rate, for example I/O data from sensors, actuators or robot controllers, PLCs or process equipment. In addition, non-real-time critical information such as diagnostic

information, configuration information, etc. can be transferred.

The Ethernet bandwidth is sufficient to transfer both data types (real-time and non-real-time) in parallel.

The bus nodes feature LEDs for bus status and CPX peripheral information as well as switch elements and a diagnostic interface. An optional memory

card available with the CPX-M-34 guarantees fast replacement of the bus node in the event of a fault. PROFINET provides the user with access to all peripherals, diagnostic data and parameter data of the CPX valve terminal. The bus node can be used as a remote I/O or remote controller. All information relevant to the CPX can be read out

and, dependent on the function, changed via CPX-FMT.

#### Points to note in connection with CPX-CEC

When a bus node is combined with a control block (CPX-CEC, in the fieldbus remote controller operating mode), the connected I/Os and/or valves, sensors and actuators are controlled via the CPX control block.

In this case, the bus node only provides the communication interface to the PLC.

Communication between the control block and CPX bus node takes place by interlinking the CPX modules and takes

up the following address capacity in the CPX system:

- 8/16 byte outputs
- 8/16 byte inputs

The following address capacity remains in the control block or CPX system for activating the peripherals:

- 56/48 byte inputs
- 56/48 byte outputs

## Data sheet – PROFINET bus node, push-pull RJ45

General technical data			CPX-M-FB34	CPX-M-FB44
Type				
Fieldbus interface			2x RJ45 push-pull socket, AIDA	
Baud rate	[Mbps]		100	
Protocol			PROFINET RT PROFINET IRT	
Max. address capacity	Inputs	[byte]	64	
	Outputs	[byte]	64	
LED displays	(bus-specific)		M/P = Maintenance/PROFenergy NF = Network fault TP1 = Network active port 1 TP2 = Network active port 2	
	(product-specific)		M = Modify, parameterisation PL = Load supply PS = Electronic supply, sensor supply SF = System fault	
Device-specific diagnostics			<ul style="list-style-type: none"> <li>Channel and module-oriented diagnostics</li> <li>Undervoltage of modules</li> <li>Diagnostic memory</li> </ul>	
Configuration support			GSDML file	
Parameterisation			<ul style="list-style-type: none"> <li>System parameters</li> <li>Diagnostic behaviour</li> <li>Signal setup</li> <li>Fail-safe response</li> <li>Forcing of channels</li> </ul>	
Additional functions			<ul style="list-style-type: none"> <li>Start-up parameterisation in plain text via fieldbus</li> <li>Fast start-up (FSU)</li> <li>Channel-oriented diagnostics via fieldbus</li> <li>Acyclic data access via fieldbus and via Ethernet</li> <li>System status can be displayed using process data</li> <li>Additional diagnostic interface for operator unit</li> </ul>	
				<ul style="list-style-type: none"> <li>I&amp;M</li> <li>LLDP</li> <li>MRP</li> <li>MRPD</li> <li>MQTT</li> <li>PROFIsafe</li> <li>PROFenergy</li> <li>S2 system redundancy</li> </ul>
Control elements			<ul style="list-style-type: none"> <li>DIL switch</li> <li>Optional memory card</li> </ul>	<ul style="list-style-type: none"> <li>DIL switch</li> </ul>
Operating voltage	Nominal value	[V DC]	24	
	Permissible range	[V DC]	18 ... 30	
Intrinsic current consumption at nominal operating voltage		[mA]	Typically 120	Typically 70
Degree of protection to EN 60529			IP65, IP67	
Temperature range	Operation	[°C]	– 5... +50	
	Storage/transport	[°C]	–20 ... +70	
Certification				RCM
Housing material			Die-cast aluminium	
Note on materials				RoHS-compliant
Dimensions (including interlinking block) W x L x H		[mm]	50 x 107 x 80	
Product weight		[g]	280	

 **Note**  
Please observe the general limits and guidelines for the system when configuring the electrical modules.

 **Note**  
Always use the correct screws for the interlinking block; this depends on whether the block is made of metal or plastic:

- Self-tapping screws for plastic interlinking blocks
- Screws with metric thread for metal interlinking blocks

## Data sheet – PROFINET bus node, push-pull RJ45

### Connection and display components

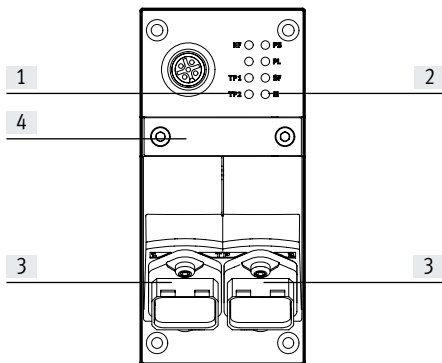





- [1] Bus-specific status LEDs
- [2] CPX-specific status LEDs
- [3] Fieldbus interface (RJ45 socket, 8-pin)
- [4] DIL switch and memory card

### Pin allocation for the fieldbus interface

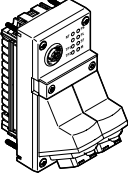
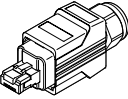
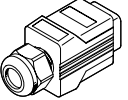
Terminal allocation	Pin	Signal	Designation
<b>RJ45 socket</b>			
	1	TD+	Transmitted data+
	2	TD-	Transmitted data-
	3	RD+	Received data+
	4	n.c.	Not connected
	5	n.c.	Not connected
	6	RD-	Received data-
	7	n.c.	Not connected
	8	n.c.	Not connected
	Housing	Shielding	Shielding

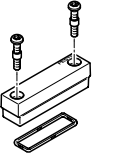
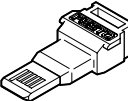
## Data sheet – PROFINET bus node, push-pull RJ45

Ordering data		Part no.	Type
Designation			
Bus node			
	PROFINET bus node	–	548751 CPX-M-FB34
		<ul style="list-style-type: none"> <li>• I&amp;M</li> <li>• LLDP</li> <li>• MRP</li> <li>• MRPD</li> <li>• PROFlenergy</li> <li>• S2 system redundancy</li> </ul>	8110370 CPX-M-FB44
Bus connection			
	RJ45 plug, 8-pin, push-pull		552000 FBS-RJ45-PP-GS
	Cover cap for bus connection		548753 CPX-M-AK-C
	Cover cap for bus connection		2873540 CPX-M-AK-D
	Cover for DIL switch and memory card		548754 CPX-M-AK-M
	Memory card for PROFINET bus node CPX-M-FB34, 2MB		4798288 CPX-SK-3
User documentation			
	Electronics manual, CPX bus node, type CPX-M-FB34	German	548759 CPX-(M)-FB33_35/43_45-DE
		English	548760 CPX-(M)-FB33_35/43_45-EN
		Spanish	548761 CPX-(M)-FB33_35/43_45-ES
		French	548762 CPX-(M)-FB33_35/43_45-FR
		Italian	548763 CPX-(M)-FB33_35/43_45-IT

## Data sheet – PROFINET bus node, push-pull SCRJ



Bus node for operating the CPX valve terminal on PROFINET.

The bus node is provided with system supply via the interlinking block and processes communication with the I/O modules.

The status of the CPX terminal is displayed as a common message via 4 CPX-specific LEDs.

The fieldbus communication status is displayed via three bus-specific LEDs.



### Application

#### Bus connection

The bus connection is established via SCRJ push-pull sockets to IEC 61754-24 (fibre-optic cable, AIDA standard) with degree of protection IP65, IP67.

The connections on the CPX bus node are equivalent 100BaseFX Ethernet ports that are brought together via an internal switch.

Fibre-optic cables made from plastic (POF, 980/1000 µm) are also suitable for transmission.

- Maximum segment length 50 m
- Transmission rate 100 Mbps
- Supports LLDP and SNMP

#### PROFINET implementation

The bus nodes support the PROFINET protocol on the basis of the Ethernet standard and TCP/IP technology to IEEE802.3.

This guarantees a data exchange with a high data transmission rate, for example I/O data from sensors, actuators or robot controllers, PLCs or process equipment. In addition, non-real-time critical information such as diagnostic

information, configuration information, etc. can be transferred.

The Ethernet bandwidth is sufficient to transfer both data types (real-time and non-real-time) in parallel.

The bus node features LEDs for bus status and CPX peripheral information as well as switch elements, memory stick and a diagnostic interface. The

purpose of the memory stick is to guarantee fast replacement of the bus node in the event of a fault. PROFINET provides the user with access to all peripheral, diagnostic and parameter data for the CPX valve terminal. The bus node can be used as a remote I/O or remote controller. All information relevant to the CPX can be read out

and, dependent on the function, changed via CPX-FMT.

#### Points to note in connection with CPX-CEC

When a bus node is combined with a control block (CPX-CEC, in the fieldbus remote controller operating mode), the connected I/Os and/or valves, sensors and actuators are controlled via the CPX control block.

In this case, the bus node only provides the communication interface to the PLC.

Communication between the control block and CPX bus node takes place by interlinking the CPX modules and takes

up the following address capacity in the CPX system:

- 8/16 byte outputs
- 8/16 byte inputs

The following address capacity remains in the control block or CPX system for activating the peripherals:

- 56/48 byte inputs
- 56/48 byte outputs

## Data sheet – PROFINET bus node, push-pull SCRJ

General technical data			CPX-M-FB35	CPX-M-FB45
Type				
Fieldbus interface			2x SCRJ push-pull socket, AIDA	
Baud rate	[Mbps]		100	
Protocol			PROFINET RT PROFINET IRT	
Max. address capacity	Inputs	[byte]	64	
	Outputs	[byte]	64	
LED displays	(bus-specific)		M/P = Maintenance/PROFenergy NF = Network fault TP1 = Network active port 1 TP2 = Network active port 2	
	(product-specific)		M = Modify, parameterisation PL = Load supply PS = Electronic supply, sensor supply SF = System fault	
Device-specific diagnostics			<ul style="list-style-type: none"> <li>Channel and module-oriented diagnostics</li> <li>Undervoltage of modules</li> <li>Diagnostic memory</li> </ul>	
Configuration support			GSDML file	
Parameterisation			<ul style="list-style-type: none"> <li>System parameters</li> <li>Diagnostic behaviour</li> <li>Signal setup</li> <li>Fail-safe response</li> <li>Forcing of channels</li> </ul>	
Additional functions			<ul style="list-style-type: none"> <li>Start-up parameterisation in plain text via fieldbus</li> <li>Fast start-up (FSU)</li> <li>Channel-oriented diagnostics via fieldbus</li> <li>Acyclic data access via fieldbus and via Ethernet</li> <li>System status can be displayed using process data</li> <li>Additional diagnostic interface for operator unit</li> </ul>	
				<ul style="list-style-type: none"> <li>I&amp;M</li> <li>LLDP</li> <li>MRP</li> <li>MRPD</li> <li>MQTT</li> <li>PROFIsafe</li> <li>PROFenergy</li> <li>S2 system redundancy</li> </ul>
Control elements			DIL switch, optional memory card	DIL switch
Operating voltage	Nominal value	[V DC]	24	
	Permissible range	[V DC]	18 ... 30	
Intrinsic current consumption at nominal operating voltage		[mA]	Typically 150	Typically 145
Certification			–	RCM
Degree of protection to EN 60529			IP65, IP67	
Temperature range	Operation	[°C]	– 5... +50	
	Storage/transport	[°C]	–20 ... +70	
Housing material			Die-cast aluminium	
Note on materials			RoHS-compliant	
Grid dimension		[mm]	50	
Dimensions (including interlinking block) W x L x H		[mm]	50 x 107 x 80	
Product weight		[g]	280	

 **Note**  
Please observe the general limits and guidelines for the system when configuring the electrical modules.

 **Note**  
Always use the correct screws for the interlinking block; this depends on whether the block is made of metal or plastic:

- Self-tapping screws for plastic interlinking blocks
- Screws with metric thread for metal interlinking blocks

## Data sheet – PROFINET bus node, push-pull SCRJ

## Connection and display components

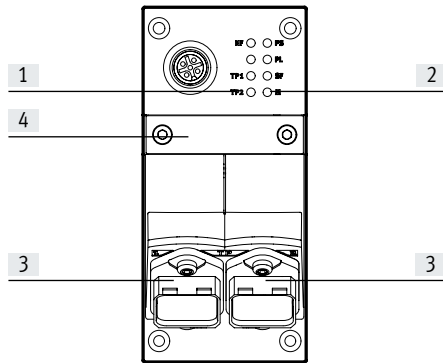

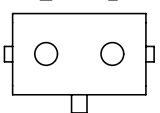

- [1] Bus-specific status LEDs
- [2] CPX-specific status LEDs
- [3] Fieldbus interface (SCRJ) socket, 2-pin)
- [4] DIL switch and memory card

## Pin allocation for the fieldbus interface

Terminal allocation	Pin	Signal	Designation
<b>SCRJ socket</b>			
	1	TX	Outgoing
	2	Rx	Incoming

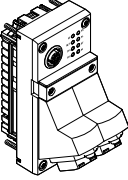
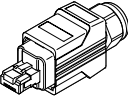
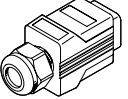
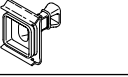
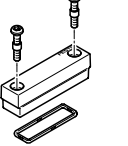
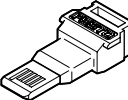
## Data sheet – PROFINET bus node, push-pull SCRJ

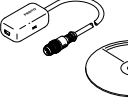
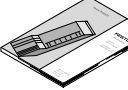
Ordering data		Part no.	Type
Designation			
Bus node			
	2x SCRJ push-pull socket, AIDA	–	548749 CPX-M-FB35
		<ul style="list-style-type: none"> <li>• I&amp;M</li> <li>• LLDP</li> <li>• MRP</li> <li>• MRPD</li> <li>• PROFlenergy</li> <li>• S2 system redundancy</li> </ul>	8110371 CPX-M-FB45
Bus connection			
	SCRJ plug, 2-pin, push-pull		571017 FBS-SCRJ-PP-GS
	Cover cap for bus connection		548753 CPX-M-AK-C
	Cover cap for bus connection		2873540 CPX-M-AK-D
	Cover for DIL switch and memory card		548754 CPX-M-AK-M
	Memory card for PROFINET bus node CPX-M-FB35, 2MB		4798288 CPX-SK-3
	Screws for attaching an inscription label to the bus node (12 pieces)		550222 CPX-M-M2.5X8-12X
	5-pin M12 to mini USB socket adapter and controller software		547432 NEFC-M12G5-0.3-U1G5
User documentation			
	Electronics manual, CPX bus node, type CPX-M-FB35 and CPX-M-FB45	German	548759 CPX-(M)-FB33_35/43_45-DE
		English	548760 CPX-(M)-FB33_35/43_45-EN
		Spanish	548761 CPX-(M)-FB33_35/43_45-ES
		French	548762 CPX-(M)-FB33_35/43_45-FR
		Italian	548763 CPX-(M)-FB33_35/43_45-IT



## Data sheet – EtherNet/IP bus node

- Industrial Ethernet
- EtherNet/IP
- Web interface

Bus node for handling communication between the electrical terminal CPX and the Ethernet/IP network.

The bus node is provided with system supply via the interlinking block and processes communication with the I/O modules.

The status of the CPX terminal is displayed as a common message via 4 CPX-specific LEDs.

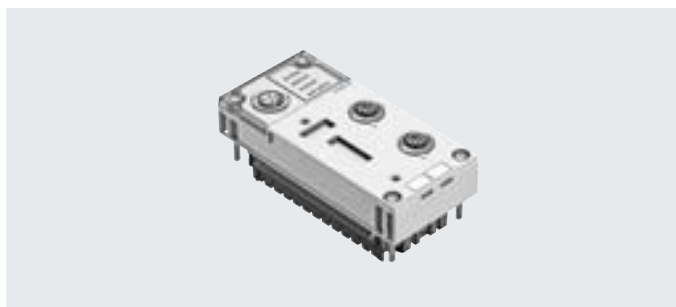

### Application

#### Bus connection

The bus connection is established via an M12 plug, D-coded to IEC 947-5-2 with degree of protection IP65, IP67.

EtherNet/IP is an open bus system based on the Ethernet standard and TCP/IP technology (IEEE802.3).

#### EtherNet/IP implementation

The CPX-FB36 supports the two operating modes: remote I/O and remote controller.

In remote I/O operating mode, all functions of the CPX valve terminal are di-

rectly controlled by the Ethernet/IP master (host).

In addition to activation via a bus system, it is possible to use IT technologies. An integrated web server enables diagnostic data to be visualised via

HTML. Various programs support direct access to the device data from the automation network.

The Ethernet/IP node for CPX supports the transmission technology that con-

forms to DIN EN 50173/CAT 5 as an integrated interface.

#### Points to note in connection with CPX-CEC

When a bus node is combined with a control block (CPX-CEC, in the fieldbus remote controller operating mode), the connected I/Os and/or valves, sensors and actuators are controlled via the CPX control block.

In this case, the bus node only provides the communication interface to the PLC.

Communication between the control block and CPX bus node takes place by interlinking the CPX modules and takes

up the following address capacity in the CPX system:

- 8 byte outputs
- 8 byte inputs

The following address capacity remains in the control block or CPX system for activating the peripherals:

- 56 byte inputs
- 56 byte outputs

## Data sheet – EtherNet/IP bus node

General technical data			
Type	CPX-FB36		
Fieldbus interface	2x M12x1 socket, 4-pin, D-coded		
Baud rate	[Mbps]	10/100	
Protocol	EtherNet/IP Modbus TCP		
Max. address capacity, inputs	[byte]	64	
Max. address volume for outputs	[byte]	64	
LED displays (bus-specific)	MS = Module status NS = network status TP1 = Network active port 1 TP2 = Network active port 2		
Device-specific diagnostics	<ul style="list-style-type: none"> <li>Module and channel-oriented diagnostics</li> <li>Undervoltage of modules</li> <li>Diagnostic memory</li> </ul>		
Configuration support	<ul style="list-style-type: none"> <li>EDS file</li> <li>L5K export with CPX-FMT</li> </ul>		
Parameterisation	<ul style="list-style-type: none"> <li>Diagnostic behaviour</li> <li>Fail-safe response</li> <li>Forcing of channels</li> <li>Idle mode characteristics</li> <li>Signal setup</li> <li>System parameters</li> </ul>		
Additional functions	<ul style="list-style-type: none"> <li>EtherNet/IP Quickconnect</li> <li>Ring topology (DLR)</li> <li>Acyclic data access via "Explicit Message" and Ethernet</li> <li>Integrated switch</li> <li>IP addressing via DHCP, DIL switch or operator unit</li> <li>Channel-oriented diagnostics via fieldbus</li> <li>Start-up parameterisation in plain text via fieldbus</li> <li>System status can be displayed using process data</li> <li>Additional diagnostic interface for operator units</li> </ul>		
Control elements	DIL switch		
Operating voltage	Nominal value	[V DC]	24
	Permissible range	[V DC]	18 ... 30
Current consumption at nominal voltage		[mA]	Typically 100
Degree of protection to EN 60529	IP65, IP67		
Temperature range	Operation	[°C]	- 5... +50
	Storage/transport	[°C]	-20 ... +70
Materials	PA-reinforced		
Note on materials	RoHS-compliant		
Grid dimension		[mm]	50
Dimensions (including interlinking block) W x L x H		[mm]	50 x 107 x 50
Product weight		[g]	125

 **Note**

Please observe the general limits and guidelines for the system when configuring the electrical modules.

## Data sheet – EtherNet/IP bus node

### Connection and display components

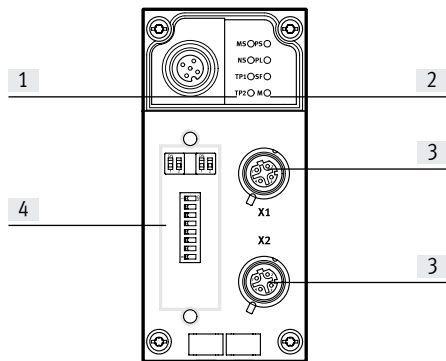



- [1] Bus-specific status LEDs
- [2] CPX-specific status LEDs
- [3] Fieldbus interface (M12 socket, 4-pin, D-coded)
- [4] Transparent DIL switch cover

#### Pin allocation for the fieldbus interface

Terminal allocation	Pin	Signal	Designation
<b>Socket, M12, D-coded</b>			
	1	TD+	Transmitted data+
	2	RD+	Received data+
	3	TD-	Transmitted data-
	4	RD-	Received data-
	Housing	FE	Shielding

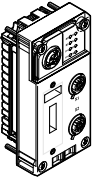
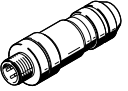
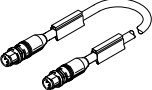
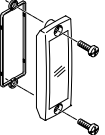
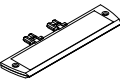
## Data sheet – EtherNet/IP bus node

Ordering data				Part no.	Type
Bus node					
	EtherNet/IP bus node			1912451	CPX-FB36
Bus connection					
	Plug M12x1, 4-pin, D-coded			543109	NECU-M-S-D12G4-C2-ET
	Connecting cable, straight plug, M12x1, 4-pin, D-coded	Straight plug, M12x1, 4-pin, D-coded	0.5 m	8040446	NEBC-D12G4-ES-0.5-S-D12G4-ET
			1 m	8040447	NEBC-D12G4-ES-1-S-D12G4-ET
			3 m	8040448	NEBC-D12G4-ES-3-S-D12G4-ET
			5 m	8040449	NEBC-D12G4-ES-5-S-D12G4-ET
			10 m	8040450	NEBC-D12G4-ES-10-S-D12G4-ET
	Straight plug, RJ45, 8-pin	1 m	8040451	NEBC-D12G4-ES-1-S-R3G4-ET	
		3 m	8040452	NEBC-D12G4-ES-3-S-R3G4-ET	
		5 m	8040453	NEBC-D12G4-ES-5-S-R3G4-ET	
		10 m	8040454	NEBC-D12G4-ES-10-S-R3G4-ET	
Open end, 4-wire	5 m	8040456	NEBC-LE4-ES-5-D12G4-ET		
	Inspection cover, transparent			533334	AK-SUB-9/15-B
	Inscription label holder for connection block			536593	CPX-ST-1
	5-pin M12 to mini USB socket adapter and controller software			547432	NEFC-M12G5-0.3-U1G5
User documentation					
	User documentation for bus node CPX-FB36		German	8024074	CPX-FB36-DE
			English	8024075	CPX-FB36-EN
			Spanish	8024076	CPX-FB36-ES
			French	8024077	CPX-FB36-FR
			Italian	8024078	CPX-FB36-IT
			Chinese	8024079	CPX-FB36-ZH

## Data sheet – EtherCAT bus node



Bus node for operating the CPX valve terminal on EtherCAT.

The bus node is provided with system supply via the interlinking block and processes communication with the I/O modules.

The status of the CPX terminal is displayed as a common message via 4 CPX-specific LEDs.

The fieldbus communication status is displayed via 4 bus-specific LEDs.

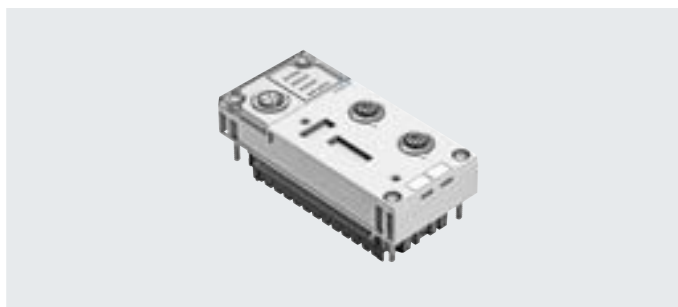

### Application

#### Bus connection

The bus connection is established via two sockets M12x1, D-coded to IEC 61076-2-101 with degree of protection IP65, IP67.

Both connections are equivalent 100BaseTX Ethernet ports with integrated auto MDI functionality (crossover and patch cable can be used) that are brought together via an internal switch.

- Maximum segment length 100 m
- Transmission rate 100 Mbps

#### EtherCAT implementation

The CPX-FB37 supports the EtherCAT protocol on the basis of the Ethernet standard and TCP/IP technology to IEEE802.3.

This guarantees a data exchange with a high data transmission rate, for example I/O data from sensors, actuators or robot controllers, PLCs or process equipment. In addition, non-real-time critical information such as diagnostic information, configuration information, etc. can be transferred.

The data bandwidth is sufficient to transfer both data types (real-time and non-real-time) in parallel.

The bus node features LEDs for bus status and CPX peripheral information as well as switch elements and a diagnostic interface. The bus node can be used as a remote I/O or remote controller. All information relevant to the CPX can be read out and, dependent on the function, changed via CPX-FMT. The functions MDP (modular device profile) and CoE (CAN over EtherCAT) enable easy access to parameters and diagnostic data via EtherCAT.

Specific EtherCAT functions:

- CoE (parameters and diagnostics or fail-safe mode): all module parameters can be set
- FoE (file over EtherCAT) makes it possible to download firmware easily
- EoE (Ethernet over EtherCAT): diagnostic data can be retrieved easily using a browser
- MDP (modular device profile): easy configuration using a module selection box
- Hot Connect, easy replacement of an EtherCAT CPX terminal
- DC (distributed clocks), time-synchronised data transmission

#### Points to note in connection with CPX-CEC

When a bus node is combined with a control block (CPX-CEC, in the fieldbus remote controller operating mode), the connected I/Os and/or valves, sensors and actuators are controlled via the CPX control block.

In this case, the bus node only provides the communication interface to the PLC.

Communication between the control block and CPX bus node takes place by interlinking the CPX modules and takes

up the following address capacity in the CPX system:

- 8/16 byte outputs
- 8/16 byte inputs

The following address capacity remains in the control block or CPX system for activating the peripherals:

- 56/48 byte inputs
- 56/48 byte outputs

## Data sheet – EtherCAT bus node

General technical data			
Type	CPX-FB37		
Fieldbus interface	2x M12x1 socket, 4-pin, D-coded		
Baud rate	[Mbps]	100	
Protocol	EtherCAT		
Max. address capacity	Inputs	[byte]	64
	Outputs	[byte]	64
LED displays	Bus-specific		Error = Communication error L/A1 = Network active port 1 L/A2 = Network active port 2 Run = Communication status
	Product-specific		M = Modify, parameterisation PL = Load supply PS = Electronic supply, sensor supply SF = System fault
Device-specific diagnostics	<ul style="list-style-type: none"> <li>Channel and module-oriented diagnostics</li> <li>Undervoltage of modules</li> <li>Diagnostic memory</li> </ul>		
Configuration support	ESI file		
Parameterisation	<ul style="list-style-type: none"> <li>System parameters</li> <li>Diagnostic behaviour</li> <li>Signal setup</li> <li>Fail-safe response</li> <li>Forcing of channels</li> </ul>		
Additional functions	<ul style="list-style-type: none"> <li>System status can be displayed using process data</li> <li>Additional diagnostic interface for operator units</li> <li>Emergency message</li> <li>Acyclic data access via fieldbus</li> <li>Diagnostics object</li> <li>Compatibility mode with CPX-FB38</li> <li>Modular device profile (MDP)</li> <li>Variable PDO mapping</li> </ul>		
Control elements	DIL switch		
Operating voltage	Nominal value	[V DC]	24
	Permissible range	[V DC]	18 ... 30
Current consumption			Typically 100 [mA]
Degree of protection to EN 60529	IP65, IP67		
Temperature range	Operation	[°C]	- 5... +50
	Storage/transport	[°C]	-20 ... +70
Materials	Housing		PA-reinforced
Note on materials	RoHS-compliant		
Grid dimension			[mm] 50
Dimensions (including interlinking block) W x L x H			[mm] 50 x 107 x 50
Product weight			[g] 125

 - **Note**

Please observe the general limits and guidelines for the system when configuring the electrical modules.

 - **Note**

Always use the correct screws for the interlinking block; this depends on whether the block is made of metal or plastic:

- Self-tapping screws for plastic interlinking blocks
- Screws with metric thread for metal interlinking blocks

## Data sheet – EtherCAT bus node

## Connection and display components

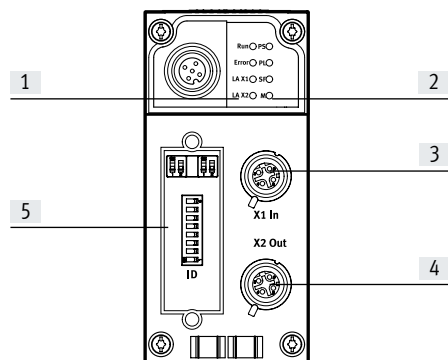





- [1] Bus-specific status LEDs
- [2] CPX-specific status LEDs
- [3] Fieldbus interface, input (socket M12x1, 4-pin, D-coded)
- [4] Fieldbus interface, output (socket M12x1, 4-pin, D-coded)
- [5] DIL switch

## Pin allocation for the fieldbus interface

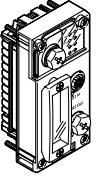
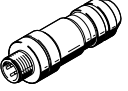
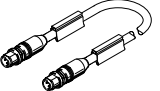
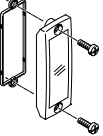
Terminal allocation	Pin	Signal	Designation
<b>M12x1 socket, D-coded</b>			
	1	TD+	Transmitted data+
	2	RD+	Received data+
	3	TD-	Transmitted data-
	4	RD-	Received data-
	Housing	FE	Shielding

## Data sheet – EtherCAT bus node

Ordering data		Part no.	Type		
Designation					
Bus node					
	EtherCAT bus node	2735960	CPX-FB37		
Bus connection					
	Plug M12x1, 4-pin, D-coded	543109	NECU-M-S-D12G4-C2-ET		
	Connecting cable, straight plug, M12x1, 4-pin, D-coded	Straight plug, M12x1, 4-pin, D-coded	0.5 m	8040446	NEBC-D12G4-ES-0.5-S-D12G4-ET
			1 m	8040447	NEBC-D12G4-ES-1-S-D12G4-ET
			3 m	8040448	NEBC-D12G4-ES-3-S-D12G4-ET
			5 m	8040449	NEBC-D12G4-ES-5-S-D12G4-ET
			10 m	8040450	NEBC-D12G4-ES-10-S-D12G4-ET
		Straight plug, RJ45, 8-pin	1 m	8040451	NEBC-D12G4-ES-1-S-R3G4-ET
			3 m	8040452	NEBC-D12G4-ES-3-S-R3G4-ET
			5 m	8040453	NEBC-D12G4-ES-5-S-R3G4-ET
		10 m	8040454	NEBC-D12G4-ES-10-S-R3G4-ET	
	Open end, 4-wire	5 m	8040456	NEBC-LE4-ES-5-D12G4-ET	
	Inspection cover, transparent	533334	AK-SUB-9/15-B		
	Cover cap for sealing unused bus connections (10 pieces)	165592	ISK-M12		
	Inscription label holder for connection block	536593	CPX-ST-1		
	5-pin M12 to mini USB socket adapter and controller software	547432	NEFC-M12G5-0.3-U1G5		
User documentation					
	Electronics manual, CPX bus node, type CPX-FB37	German	8029674	P.BE-CPX-FB37-DE	
		English	8029675	P.BE-CPX-FB37-EN	
		Spanish	8029676	P.BE-CPX-FB37-ES	
		French	8029677	P.BE-CPX-FB37-FR	
		Italian	8029678	P.BE-CPX-FB37-IT	
		Chinese	8029679	P.BE-CPX-FB37-ZH	



## Data sheet – Sercos III bus node

- Sercos
- Web interface

Bus node for handling communication between the electrical terminal CPX and the Sercos III network.

The bus node is provided with system supply via the interlinking block and processes communication with the I/O modules.

The status of the CPX terminal is displayed as a common message via 4 CPX-specific LEDs.

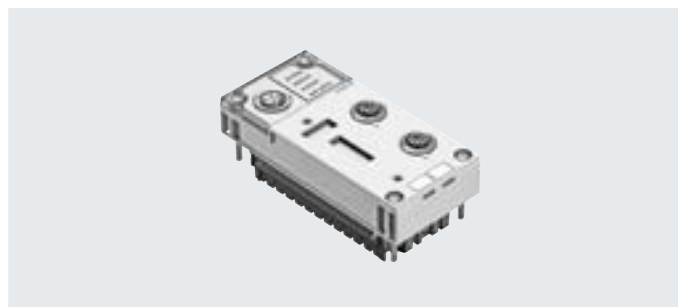

### Application

#### Bus connection

The bus connection is established via two M12x1 plugs, D-coded to IEC 947-5-2 with degree of protection to IP65, IP67. The connections are equipped with automatic detection for the incoming and outgoing connection.

The Sercos III bus node can be used to connect the CPX valve terminal to the standardised Sercos III bus.

Sercos III uses the Ethernet standard (IEEE802.3) and TCP/IP technology for communication in an industrial environment.

Industry-compatible Sercos III devices enable data to be exchanged with a higher data transmission rate, such as data from sensors, actuators or controllers.

Non-real-time critical information, such as diagnostics or configuration information, can also be transferred.

#### Web servers

In addition to activation via a bus system, it is possible to use IT technologies. An integrated web server enables

diagnostic data to be visualised via HTML. Various programs support direct

access to the device data from the automation network.

#### Points to note in connection with CPX-CEC

The CPX-FB39 supports the operating modes remote I/O and remote controller.

In remote I/O operating mode, all functions of the CPX valve terminal are directly controlled by the Sercos controller.

When a bus node is combined with a control block (CPX-CEC, in the fieldbus

remote controller operating mode), the connected I/Os and/or valves, sensors and actuators are controlled via the CPX control block.

In this case, the bus node only provides the communication interface to the PLC.

Communication between the control block and CPX bus node takes place by

interlinking the CPX modules and takes up the following address capacity in the CPX system:

- 8/16 byte outputs
- 8/16 byte inputs

The following address capacity remains in the control block or CPX system for activating the peripherals:

- 56/48 byte inputs

## Data sheet – Sercos III bus node

General technical data			
Type	CPX-FB39		
Fieldbus interface	2x M12x1 socket, D-coded, 4-pin		
Baud rate	[Mbps]	100 full/half duplex	
Protocol	Sercos III		
Max. address capacity	Inputs	[byte]	64
	Outputs	[byte]	64
LED displays	Bus-specific		S = Sercos LED SD = Sercos sub-device LED TP1 = Network active port 1 TP2 = Network active port 2
	Product-specific		M = Modify, parameterisation PL = Load supply PS = Electronics supply, sensor supply SF = System fault
Device-specific diagnostics			
<ul style="list-style-type: none"> <li>• Module and channel-oriented diagnostics</li> <li>• Undervoltage of modules</li> <li>• Diagnostic memory</li> </ul>			
Configuration support			
SDDML file			
Parameterisation			
<ul style="list-style-type: none"> <li>• Diagnostic behaviour</li> <li>• Fallback output data</li> <li>• Forcing of channels</li> <li>• Signal setup</li> <li>• System parameters</li> </ul>			
Additional functions			
<ul style="list-style-type: none"> <li>• Acyclic and cyclic data access via Sercos</li> <li>• IP addressing via Sercos parameters or operator unit</li> <li>• Channel-oriented diagnostics via fieldbus</li> <li>• Start-up parameterisation in plain text via fieldbus</li> <li>• System status can be displayed using process data</li> <li>• Additional diagnostic interface for operator units</li> </ul>			
Control elements			
DIL switch			
Operating voltage	Nominal value	[V DC]	24
	Permissible range	[V DC]	18 ... 30
Current consumption at nominal voltage			[mA]
			Typically 100
Degree of protection to EN 60529			
IP65, IP67			
Temperature range	Operation	[°C]	- 5... +50
	Storage/transport	[°C]	-20 ... +70
Materials			
PA-reinforced			
Note on materials			
RoHS-compliant			
Grid dimension			[mm]
			50
Dimensions (including interlinking block) W x L x H			
			[mm]
			50 x 107 x 50
Product weight			
			[g]
			125

 **Note**

Please observe the general limits and guidelines for the system when configuring the electrical modules.

## Data sheet – Sercos III bus node

### Connection and display components

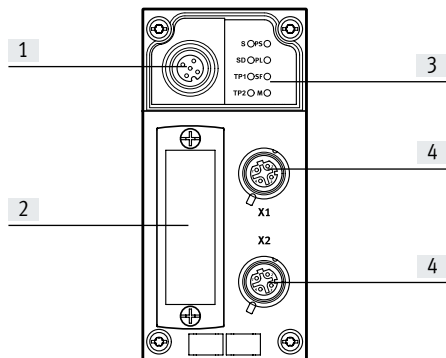

- [1] Service interface for PC with CPX maintenance tool NEFC-M12G5-0.3-U1G5
- [2] Transparent DIL switch cover
- [3] Status LED, bus-specific and CPX-specific
- [4] Fieldbus interface (M12x1 socket, 4-pin, D-coded)

### Pin allocation for the fieldbus interface







Terminal allocation	Pin	Signal	Designation
<b>M12x1 socket, D-coded</b>			
	1	TD+	Transmitted data+
	2	RD+	Received data+
	3	TD-	Transmitted data-
	4	RD-	Received data-
	Housing	FE	Shielding

**Note**

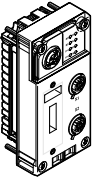
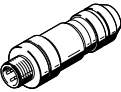
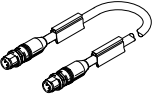
The CPX-FB39 can automatically detect transmitter and receiver cables (auto-MDI/MDI-X auto-crossover).

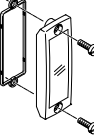
RD and TD signal pairs are automatically swapped if required.

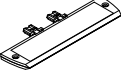
## Data sheet – Sercos III bus node

Ordering data		Part no.	Type		
<b>Bus node</b>					
	Ethernet Sercos III bus node	<b>2093101</b>	<b>CPX-FB39</b>		
<b>Bus connection</b>					
	Plug M12x1, 4-pin, D-coded	<b>543109</b>	<b>NECU-M-S-D12G4-C2-ET</b>		
	Connecting cable, straight plug, M12x1, 4-pin, D-coded	Straight plug, M12x1, 4-pin, D-coded	0.5 m	<b>8040446</b>	<b>NEBC-D12G4-ES-0.5-S-D12G4-ET</b>
			1 m	<b>8040447</b>	<b>NEBC-D12G4-ES-1-S-D12G4-ET</b>
			3 m	<b>8040448</b>	<b>NEBC-D12G4-ES-3-S-D12G4-ET</b>
			5 m	<b>8040449</b>	<b>NEBC-D12G4-ES-5-S-D12G4-ET</b>
			10 m	<b>8040450</b>	<b>NEBC-D12G4-ES-10-S-D12G4-ET</b>
			Straight plug, RJ45, 8-pin	1 m	<b>8040451</b>
	3 m	<b>8040452</b>		<b>NEBC-D12G4-ES-3-S-R3G4-ET</b>	
	Open end, 4-wire	5 m	<b>8040453</b>	<b>NEBC-D12G4-ES-5-S-R3G4-ET</b>	
10 m		<b>8040454</b>	<b>NEBC-D12G4-ES-10-S-R3G4-ET</b>		
	5 m	<b>8040456</b>	<b>NEBC-LE4-ES-5-D12G4-ET</b>		
	Inspection cover, transparent	<b>533334</b>	<b>AK-SUB-9/15-B</b>		
	Cover cap for sealing unused bus connections (10 pieces)	<b>165592</b>	<b>ISK-M12</b>		
	Inscription label holder for connection block	<b>536593</b>	<b>CPX-ST-1</b>		
	5-pin M12 to mini USB socket adapter and controller software	<b>547432</b>	<b>NEFC-M12G5-0.3-U1G5</b>		
<b>User documentation</b>					
	User documentation for bus node CPX-FB39	German	<b>8028632</b>	<b>P.BE-CPX-FB39-DE</b>	
		English	<b>8028633</b>	<b>P.BE-CPX-FB39-EN</b>	
		Spanish	<b>8028634</b>	<b>P.BE-CPX-FB39-ES</b>	
		French	<b>8028635</b>	<b>P.BE-CPX-FB39-FR</b>	
		Italian	<b>8028636</b>	<b>P.BE-CPX-FB39-IT</b>	
		Chinese	<b>8028637</b>	<b>P.BE-CPX-FB39-ZH</b>	

## Data sheet – POWERLINK bus node

- Ethernet POWERLINK
- Web interface

Bus node for handling communication between the electrical terminal CPX and the Ethernet POWERLINK network. The bus node is provided with system supply via the interlinking block and processes communication with the I/O modules.

The status of the CPX terminal is displayed as a common message via 4 CPX-specific LEDs.



### Application

#### Bus connection

The bus connection is established via an M12x1 plug, D-coded to IEC 947-5-2 with degree of protection IP65, IP67. Ethernet POWERLINK uses the Ethernet standards and TCP/IP technology (IEEE802.3) for communication in an industrial environment and integrates all CANopen mechanisms.

It includes all the key features of standard Ethernet, including internode communication, hotplug capability and free selection of network topology. Ethernet POWERLINK fulfils the real-time requirements using a mix of timeslot and polling procedures. In other words, defined times are re-

served on the Ethernet cable exclusively for transferring real-time data. Only network participants which have previously been prompted by the controller are able to transmit data during these timeslots.

#### Ethernet POWERLINK implementation

The CPX-FB40 supports the two operating modes: remote I/O and remote controller.

In remote I/O operating mode, all functions of the CPX valve terminal are di-

rectly controlled by the Ethernet POWERLINK master (host). In addition to activation via a bus system, it is possible to use IT technologies. An integrated web server enables diagnostic data to be visualised via

HTML. Various programs support direct access to the device data from the automation network.

The Ethernet POWERLINK node for CPX supports the transmission technology

that conforms to DIN EN 50173/CAT 5 as an integrated interface.

#### Points to note in connection with CPX-CEC

When a bus node is combined with a control block (CPX-CEC, in the fieldbus remote controller operating mode), the connected I/Os and/or valves, sensors and actuators are controlled via the CPX control block.

In this case, the bus node only provides the communication interface to the PLC.

Communication between the control block and CPX bus node takes place by interlinking the CPX modules and takes

up the following address capacity in the CPX system:

- 8 byte outputs
- 8 byte inputs

The following address capacity remains in the control block or CPX system for activating the peripherals:

- 56 byte inputs
- 56 byte outputs

## Data sheet – POWERLINK bus node

General technical data			
Type	CPX-FB40		
Fieldbus interface	2x M12x1 socket, D-coded, 4-pin		
Baud rate	[Mbps]	100	
Protocol	Ethernet PowerLink V2		
Max. address capacity	Inputs	[byte]	64
	Outputs	[byte]	64
LED displays	Bus-specific		BE = POWERLINK error BS = POWERLINK status L/A1 = Link/activity port 1 L/A2 = Link/activity port 2
	Product-specific		M = Modify, parameterisation PL = Load supply PS = Electronic supply, sensor supply SF = System fault
Device-specific diagnostics	<ul style="list-style-type: none"> <li>Module and channel-oriented diagnostics</li> <li>Undervoltage of modules</li> <li>Diagnostic memory</li> </ul>		
Configuration support	<ul style="list-style-type: none"> <li>XDC file</li> <li>XDD file</li> </ul>		
Parameterisation	<ul style="list-style-type: none"> <li>Diagnostic behaviour</li> <li>Fail-safe response</li> <li>Forcing of channels</li> <li>Signal setup</li> <li>System parameters</li> </ul>		
Additional functions	<ul style="list-style-type: none"> <li>Acyclic data access via "SDO" and Ethernet</li> <li>Integrated hub</li> <li>IP addressing via DHCP, DIL switch or operator unit</li> <li>Channel-oriented diagnostics via fieldbus</li> <li>Start-up parameterisation in plain text via fieldbus</li> <li>System status can be displayed using process data</li> <li>Additional diagnostic interface for operator units</li> </ul>		
Control elements	DIL switch		
Operating voltage	Nominal value	[V DC]	24
	Permissible range	[V DC]	18 ... 30
	Reverse polarity protection	For operating voltage	
Current consumption at nominal voltage	[mA]	Typically 100	
Degree of protection to EN 60529	IP65, IP67		
Temperature range	Operation	[°C]	- 5... +50
	Storage/transport	[°C]	-20 ... +70
Materials	PA-reinforced		
Note on materials	RoHS-compliant		
Grid dimension	[mm]	50	
Dimensions (including interlinking block) W x L x H	[mm]	50 x 107 x 50	
Product weight	[g]	125	

 **Note**

Please observe the general limits and guidelines for the system when configuring the electrical modules.

## Data sheet – POWERLINK bus node

### Connection and display components

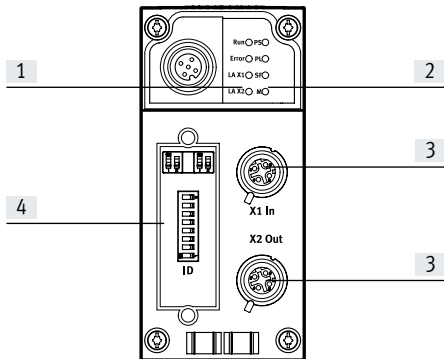





- [1] Bus-specific status LEDs
- [2] CPX-specific status LEDs
- [3] Fieldbus interface (M12x1 socket, 4-pin, D-coded)
- [4] Transparent DIL switch cover

### Pin allocation for the fieldbus interface

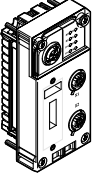
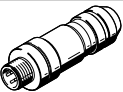
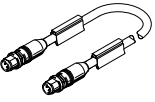
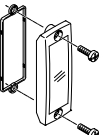
Terminal allocation	Pin	Signal	Designation
<b>M12x1 socket, D-coded</b>			
	1	TD+	Transmitted data+
	2	RD+	Received data+
	3	TD-	Transmitted data-
	4	RD-	Received data-
	Housing	FE	Shielding

## Data sheet – POWERLINK bus node

Ordering data		Part no.	Type		
Designation					
Bus node					
	Ethernet POWERLINK bus node	2474896	CPX-FB40		
Bus connection					
	Plug M12x1, 4-pin, D-coded	543109	NECU-M-S-D12G4-C2-ET		
	Connecting cable, straight plug, M12x1, 4-pin, D-coded	Straight plug, M12x1, 4-pin, D-coded	0.5 m	8040446	NEBC-D12G4-ES-0.5-S-D12G4-ET
			1 m	8040447	NEBC-D12G4-ES-1-S-D12G4-ET
			3 m	8040448	NEBC-D12G4-ES-3-S-D12G4-ET
			5 m	8040449	NEBC-D12G4-ES-5-S-D12G4-ET
			10 m	8040450	NEBC-D12G4-ES-10-S-D12G4-ET
		Straight plug, RJ45, 8-pin	1 m	8040451	NEBC-D12G4-ES-1-S-R3G4-ET
			3 m	8040452	NEBC-D12G4-ES-3-S-R3G4-ET
			5 m	8040453	NEBC-D12G4-ES-5-S-R3G4-ET
	Open end, 4-wire	10 m	8040454	NEBC-D12G4-ES-10-S-R3G4-ET	
		5 m	8040456	NEBC-LE4-ES-5-D12G4-ET	
	Inspection cover, transparent	533334	AK-SUB-9/15-B		
	Inscription label holder for connection block	536593	CPX-ST-1		
	5-pin M12 to mini USB socket adapter and controller software	547432	NEFC-M12G5-0.3-U1G5		
User documentation					
	User documentation for bus node CPX-FB40	German	8028650	P.BE-CPX-FB40-DE	
		English	8028651	P.BE-CPX-FB40-EN	
		Spanish	8028652	P.BE-CPX-FB40-ES	
		French	8028653	P.BE-CPX-FB40-FR	
		Italian	8028654	P.BE-CPX-FB40-IT	
		Chinese	8028655	P.BE-CPX-FB40-ZH	



## Data sheet – Interface for CPI system

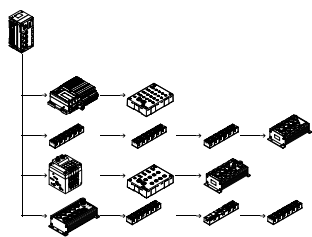

The electrical interface CPX-CP establishes the connection to CP modules of the installation system CPI via pre-assembled connecting cables. The I/O data of the connected valve terminals with CP string extension and CP input and output modules are transferred to the connected CPX bus node and thus via fieldbus to the higher-order controller.

This enables modular centralised and compact decentralised concepts to be established with one system.



### Application

#### CP connection

As well as transmitting the communication data, the max. 4 CP strings of a CPX-CP interface also transmit the power supply to the connected sensors and the load supply to the valves (or outputs). Both circuits are supplied separately with 24 V but using a common reference potential.

The valve terminals with CP string extension (or outputs) are supplied with voltage for the electronics and valves by the interlinking block.

The CP interface allows the following combinations:

- Centralised analogue and digital inputs and outputs of the CPX terminal
- Decentralised digital inputs and outputs of the CP installation system
- Valve/valve terminals that can be connected both centrally and decentrally

### Configuration example – CP interface with CP modules

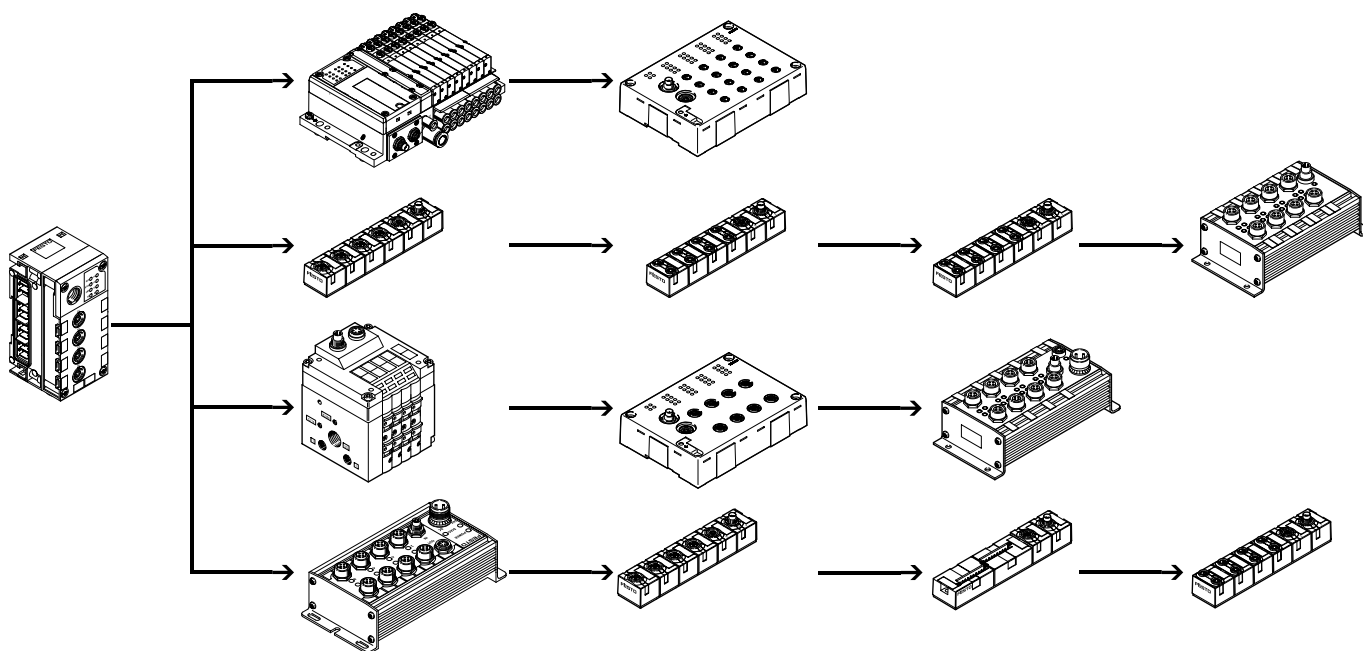

## Data sheet – Interface for CPI system

## Implementation

The CPX-CP interface supports the CPI system:

- Max. 4 individual electronically protected CP strings
- Max. 4 CP modules per string
- Max. 32 inputs/32 outputs per string
- The maximum length of a string is 10 m. If the CP interface is positioned centrally, the CP system can cover an area of 20 m in diameter.
- Modules with CPI functionality

The following CP module variants are available:

- Input modules with 8 or 16 digital inputs (connection technology M8, M12 and CageClamp)
- Output modules with 4 or 8 digital outputs (connection technology M12)
- Valve terminals with CP string extension (up to 32 solenoid coils, different valve functions)

CPI modules support the following functions:

- Module-oriented diagnostics
- Module/channel-oriented parameterisation
- Support of all functions by the CPX-FMT
- Module can be positioned anywhere within the string

Several CP interface modules can be combined in one CPX terminal, depending on the address capacity of the bus node.

Example:

- CPX-FB13 (512 I/O)
- Max. 4 CP interface modules (128 I/O each) possible

 **Note**

When arranging the CP modules it should be taken into consideration that CP input modules without CPI functionality should always be placed at the end of a string.

## Configuration

The following rules apply for a string of a CPX-CP interface:

- Max. one output module or one valve terminal without CPI functionality
- Max. one output module without CPI functionality or one valve terminal with CP string extension
- Any number of CP modules with CPI functionality, up to the maximum limit of 4 modules and/or 32 inputs/32 outputs per string

- Maximum extension:
- 4 input modules and 4 valve terminals/output modules without CPI functionality
- 16 CP modules with CPI functionality

The configuration of the strings with respect to the module type and position of the modules in the string is entered by activating the SAVE key in the CPX-CP interface and saved there permanently.

Saved data are retained even when the CP interface is isolated from the power supply.

The representation of the CP interface within a CPX terminal and thus at the fieldbus is dependent on the characteristics of the relevant fieldbus system. In addition to input and output addressing, this also applies to the representation of the diagnostics and parameterisation of the CP module and the characteristics of the CPI system.

 **Note**

The remanent saving of configuration data means that changes in the configuration or faulty modules are still displayed even after a voltage failure.

## Data sheet – Interface for CPI system

General technical data			
Type	CPX-CP-4-FB		
Brief description	CP interface		
Max. number of	CP strings		4
	CP modules per string		4
	Outputs per string		32
	Inputs per string		32
CP connection	Socket M9, 5-pin		
Baud rate		[kbps]	1000
Cycle time	CP modules without CPI functionality	[ms]	4
	CP modules with CPI functionality	[ms]	2
LED displays	L1 ... 4= Status of the CP string 1 ... 4 PS = Electronics supply, sensor supply PL = Load supply RN = Status of the CP system SF = System fault		
Device-specific diagnostics	Via bus node		
Operating voltage	Nominal value	[V DC]	24 (reverse polarity protected)
	Permissible range	[V DC]	18 ... 30
	Power failure buffering	[ms]	20
Sensor supply voltage		[V DC]	24 ±25% coming from bus node
Actuator load voltage		[V DC]	24 ±10% coming from bus node
Current consumption	Without CP modules	[A]	Max. 0.2
	Per CP string	[A]	Max. 1.6
Degree of protection to EN 60529	IP65, IP67		
Temperature range	Operation	[°C]	-5 ... +50
	Storage/transport	[°C]	-20 ... +70
Materials	PA		
Grid dimension		[mm]	50
Dimensions (including interlinking block) W x L x H		[mm]	50 x 107 x 45
Product weight		[g]	139

 **Note**

Please observe the general limits and guidelines for the system when configuring the electrical modules.

## Data sheet – Interface for CPI system

### Connection and display components

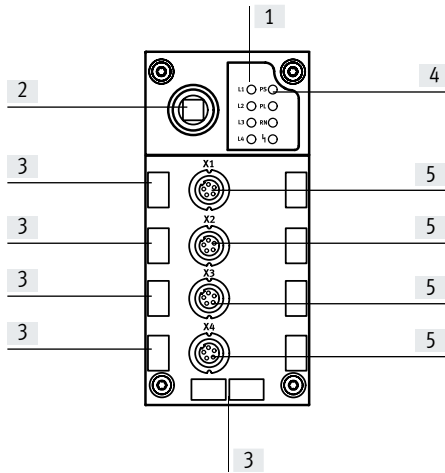

- [1] CP string LEDs
- [2] SAVE key
- [3] Holders for inscription labels (IBS 6x10)
- [4] CPX-specific status LEDs
- [5] CP connections for up to 4 strings (0 ... 3)



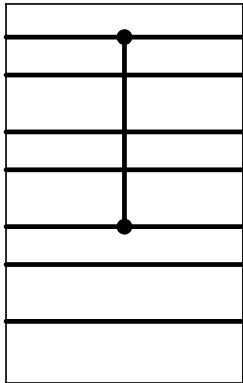

### Power supply

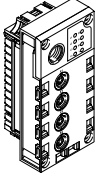

- 0V** Valves
- 24V** Valves
- 0V** Output
- 24V** Output
- 0V** El./Sen.
- 24V** El./Sen.
- FE**

The module combines the 0 V potential of the power supply for electronics and sensors with the 0 V potential of the power supply for valves.  
 If all pins of the valves of a pneumatic interface connected to the right of the CP interface are to be switched off, an appropriate interlinking block with additional supply for valves must be used to the right of the CP interface.

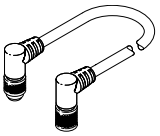
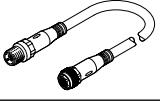
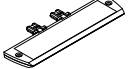
## Data sheet – Interface for CPI system

Ordering data		Part no.	Type
Designation			
CP interface			
	Interface for max. 16 I/O modules and valve terminals of the CPI system	<b>526705</b>	<b>CPX-CP-4-FB</b>
Bus connection			
	Cover cap	M12	<b>165592</b> ISK-M12
	Connecting cable, angled plug, angled socket	0.25 m	<b>540327</b> KVI-CP-3-WS-WD-0.25
		0.5 m	<b>540328</b> KVI-CP-3-WS-WD-0.5
		2 m	<b>540329</b> KVI-CP-3-WS-WD-2
		5 m	<b>540330</b> KVI-CP-3-WS-WD-5
		8 m	<b>540331</b> KVI-CP-3-WS-WD-8
	Connecting cable, straight plug, straight socket	2 m	<b>540332</b> KVI-CP-3-GS-GD-2
		5 m	<b>540333</b> KVI-CP-3-GS-GD-5
		8 m	<b>540334</b> KVI-CP-3-GS-GD-8
	Inscription label holder for connection block	<b>536593</b>	<b>CPX-ST-1</b>
User documentation			
	User documentation for CPX-CP interface	German	<b>539293</b> P.BE-CPX-CP-EN
		English	<b>539294</b> P.BE-CPX-CP-EN
		Spanish	<b>539295</b> P.BE-CPX-CP-ES
		French	<b>539296</b> P.BE-CPX-CP-FR
		Italian	<b>539297</b> P.BE-CPX-CP-IT

## Data sheet – I-Port interface

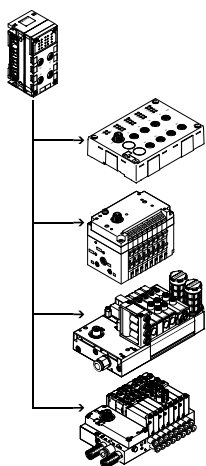

The electrical interface CPX CTEU master establishes the connection to modules of the CTEL/CTEU series that have an I-Port interface (device). The I/O data from the connected devices are transmitted to the connected CPX bus node and thus to the higher-order controller via fieldbus. A maximum of 4 devices can be connected to a CPX CTEU master via corresponding M12 interfaces.



### Application

#### I-Port interface

As well as transmitting the communication data, the I-Port interfaces of a CPX CTEU master also transmit the power supply to the connected sensors and the load supply to the valves (or

outputs). Both circuits are supplied separately with 24 V, using a separate reference potential. The connecting cables with a dual function as signal cable and supply ca-

ble must meet the corresponding increased requirements.

### Configuration example – CPX CTEU master with CTEL modules

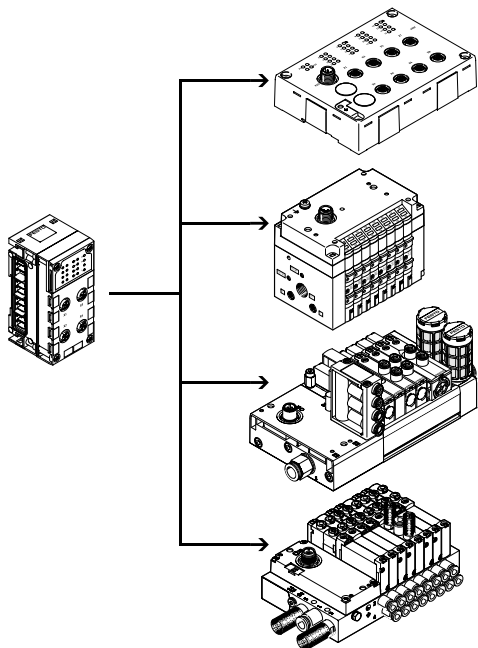

The CPX CTEU master provides 4 external I-Port interfaces, each of which can be connected to a device. I-Port is an interface for exchanging serial data for connecting decentralised modules or valve terminals from Festo. The I-Port interface is based on IO-Link and is compatible with it in certain areas. The connection type corresponds to a star topology. In other words, only one module or valve terminal can be connected to each I-Port.

The limitations with respect to IO-Link include:

- Permanently set baud rate of 230.4 kbps
- SIO mode is not supported
- Max. 32 bytes of input data and 32 bytes of output data
- Only one dump of the master commands is used
- Configuration via IO-DD is not supported.

## Data sheet – I-Port interface

### Implementation

The CPX CTEL master from Festo enables modules with an I-Port interface to be connected to a CPX system:

- Max. 4 devices with individual electronic protection
- Max. 64 inputs/64 outputs per I-Port interface
- The maximum length of a string is 20 m.

The following device variants are available:

- Input modules with 16 digital inputs (connection technology M8 3-pin and M12 5-pin)
- Valve terminals with I-Port interface (up to 48 solenoid coils, different valve functions)

The decentralised arrangement of the modules and valve terminals with I-Port enables them to be mounted close to the cylinders and actuators or sensors to be controlled. This means that the compressed air supply lines and sensor connecting cables used can be shortened, and it may be possible to use smaller valves, thereby saving costs.

Several CPX CTEL masters can be combined in one CPX terminal, depending on the address capacity of the bus node.

Example:

- CPX-FB13 (512 I/O)
- A maximum of 2 CPX CTEL masters is possible (each with 256 I/O)

### Configuration

#### Settings

The exact amount of the I/O bytes made available depends on the requirements of the connected devices or of the correspondingly selected operating mode.

The operating mode or preset configuration of the CPX CTEL master can be specified by the user.

Selecting the operating mode and setting the manual configuration takes place via the DIL switches. These DIL switches are not required during continuous operation and are only accessible in the disassembled state.

#### Manual configuration

In the case of manual configuration (tool change mode), the volume of inputs and outputs in the process image of the CPX system or of the higher-order fieldbus can be defined manually using the DIL switches.

The process image then always has the same scope, regardless of the connected devices.

The I/O length specified always applies to all four I-Ports (max. 8 bytes per I-Port).

#### Automatic configuration

In the case of automatic configuration, the I/O length for each I-Port is determined individually and this value is used to select the appropriate or next highest configuration preset.

### Power supply for I-Port devices

The CPX-CTEL master provides two separate power supplies for the connected devices:

- For operating the device and the inputs connected to it
- For the outputs and valves that are connected to the device

The power supply for the devices and the inputs is provided by the power supply for the electronics and sensors of the CPX terminal.

The power supply for the outputs and valves is provided by the power supply for the valves of the CPX terminal.

The interlinking block with additional supply ensures a separate supply voltage for the valves and outputs. This means it is possible to disconnect this supply voltage separately.

The valves and outputs of the connected I-Port devices can therefore be dis-

connected separately without disconnecting the devices.

## Data sheet – I-Port interface

General technical data			
Type	CPX-CTEL-4-M12-5POL		
Protocol	I-Port		
Max. address capacity	Outputs	[bit]	256
	Inputs	[bit]	256
I-Port connection	4x socket M12, 5-pin, A-coded		
Number of I-Port interfaces	4		
Maximum cable length	[m]	20	
Internal cycle time	[ms]	1 per 8 bits of user data	
Galvanic isolation	Channel – channel	No	
	Channel – internal bus	Yes, with intermediate supply	
LED displays	X1 ... 4 = Status of the I-Port interface 1 ... 4 PS = Electronic supply PL = Load supply - 4 = Module error		
Diagnostics	<ul style="list-style-type: none"> <li>• Communication error</li> <li>• Module short circuit</li> <li>• Module-oriented diagnostics</li> <li>• Undervoltage</li> </ul>		
Parameterisation	<ul style="list-style-type: none"> <li>• Diagnostic behaviour</li> <li>• Failsafe per channel</li> <li>• Forcing per channel</li> <li>• Idle mode per channel</li> <li>• Module parameters</li> <li>• Tool change mode</li> </ul>		
Additional functions	Tool change mode		
Control elements	DIL switch		
Operating voltage	Nominal value	[V DC]	24 (reverse polarity protected)
	Permissible range	[V DC]	18 ... 30
	Power failure buffering	[ms]	10
Intrinsic current consumption at nominal operating voltage	[mA]	Typically 65	
Max. power supply per channel	[A]	4x 1.6	
Max. residual current of outputs per channel	[A]	4x 1.6	
Degree of protection to EN 60529	IP65, IP67		
Temperature range	Operation	[°C]	-5 ... +50
	Storage/transport	[°C]	-20 ... +70
Materials	Reinforced PA, PC		
Note on materials	RoHS-compliant		
Grid dimension	[mm]	50	
Dimensions (including interlinking block) W x L x H	[mm]	50 x 107 x 55	
Product weight	[g]	110	

 **Note**

Please observe the general limits and guidelines for the system when configuring the electrical modules.



## Data sheet – I-Port interface

## Connection and display components

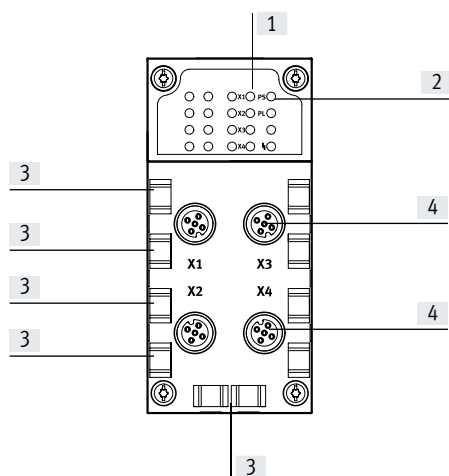

- [1] Status LEDs for I-Port interfaces
- [2] CPX-specific status LEDs
- [3] Holders for inscription labels (IBS 6x10)
- [4] I-Port interfaces for up to 4 devices

## Combinations of bus nodes/control blocks with interface CPX-CTEL

Bus node/control block	Part no.	Interface
		CPX-CTEL-4-M12-5POL
CPX-CEC-C1	567347	■
CPX-CEC-C1-V3	3473128	■
CPX-CEC-M1-V3	3472765	■
CPX-CEC	567346	■
CPX-CEC-S1-V3	3472425	■
CPX-FB11	526172	■
CPX-FB13	195740	■
CPX-FB14	526174	■
CPX-FB23-24	526176	■
CPX-FB33	548755	■
CPX-M-FB34	548751	■
CPX-M-FB35	548749	■
CPX-FB36	1912451	■
CPX-FB37	2735960	■
CPX-FB39	2093101	■
CPX-FB40	2474896	■
CPX-FB43	8110369	■
CPX-M-FB44	8110370	■
CPX-M-FB45	8110371	■

## Pin allocation – I-Port interface

Terminal allocation	Pin	Signal	Designation
	1	24 V <sub>SEN</sub>	24 V DC supply voltage for electronics and inputs
	2	24 V <sub>VAL</sub>	24 V DC load voltage supply for valves and outputs
	3	0 V <sub>SEN</sub>	0 V DC supply voltage for electronics and sensors
	4	C/Q I-Port	Communication signal C/Q, data transmission line
	5	0 V <sub>VALVES</sub>	0 V DC load voltage supply for valves and outputs

Data sheet – I-Port interface

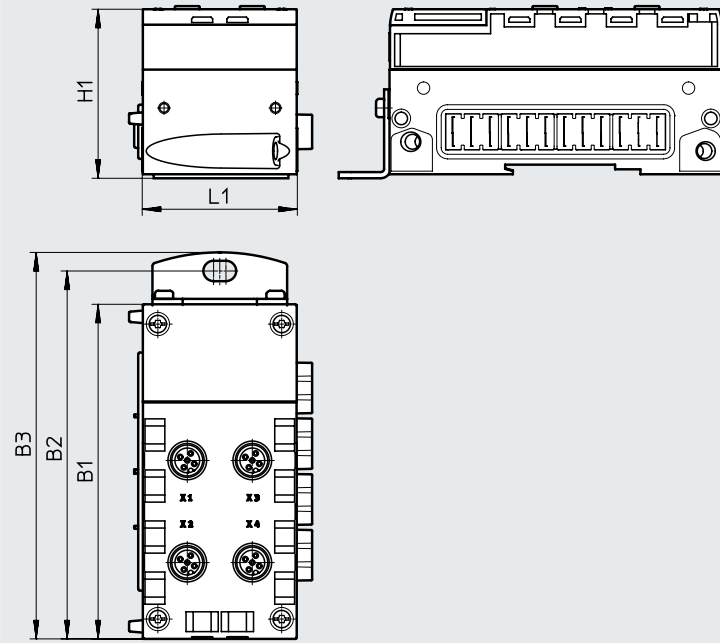

Dimensions

Download CAD data → [www.festo.com](http://www.festo.com)

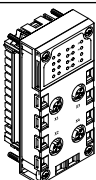

Type	B1	B2	B3	H1	L1
CPX-CTEL-4-M12-5POL	108.1	118.9	124.9	55.1	50

## Data sheet – I-Port interface

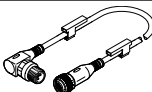
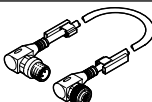
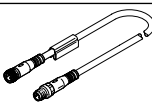
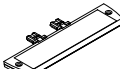
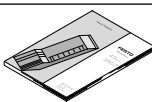
Ordering data		Part no.	Type
Designation			
CPX-CTEL master			
	Interface for a maximum of 4 I/O modules and valve terminals with I-Port interface (devices)	<b>1577012</b>	<b>CPX-CTEL-4-M12-5POL</b>
Bus connection			
	Cover cap	M12	<b>165592</b> ISK-M12
	Connecting cable M12-M12, 5-pin • Straight socket • Angled plug	Cable characteristic: standard	0.5 m <b>8003617</b> NEBU-M12G5-K-0.5-M12W5
			2 m <b>8003618</b> NEBU-M12G5-K-2-M12W5
	Connecting cable M12-M12, 5-pin • Angled socket • Angled plug	Cable characteristic: standard	0.5 m <b>570733</b> NEBU-M12W5-K-0.5-M12W5
			2 m <b>570734</b> NEBU-M12W5-K-2-M12W5
	Connecting cable M12-M12, 5-pin • Straight socket • Straight plug	Cable characteristic: suitable for use with energy chains	5 m <b>574321</b> NEBU-M12G5-E-5-Q8N-M12G5
			7.5 m <b>574322</b> NEBU-M12G5-E-7.5-Q8N-M12G5
			10 m <b>574323</b> NEBU-M12G5-E-10-Q8N-M12G5
	Inscription label holder for connection block		<b>536593</b> CPX-ST-1
User documentation			
	User documentation CPX-CTEL master	German	<b>574600</b> P.BE-CPX-CTEL-DE
		English	<b>574601</b> P.BE-CPX-CTEL-EN
		Spanish	<b>574602</b> P.BE-CPX-CTEL-ES
		French	<b>574603</b> P.BE-CPX-CTEL-FR
		Italian	<b>574604</b> P.BE-CPX-CTEL-IT

## Data sheet – IO-Link interface

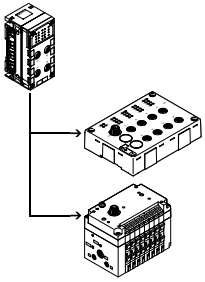

The electrical interface CPX-CTEL-2-... enables the connection of modules with IO-Link interface (IO-Link device) to the CPX terminal. The I/O data from the connected devices are transmitted to the connected CPX bus node and thus to the higher-order controller via fieldbus.

A maximum of two IO-Link devices can be connected to an electrical interface CPX-CTEL-2-... via the corresponding M12 interfaces.



### Application

The communication system IO-Link is used to exchange serial data from decentralised function modules (devices) at the field level.

The electrical interface CPX-CTEL-2-... provides two external IO-Link interfaces,

each of which can be connected to a device.

The connection type corresponds to a star topology, which means that only one device can be connected to each port.

The address space that the module makes available and assigns accordingly in the CPX system can be configured according to various presettings. Selecting the operating mode and setting the manual configuration takes place via the DIL switches.

These DIL switches are not required during continuous operation and are only accessible in the disassembled state.

### Restrictions

The interfaces (ports) of electrical interface CPX-CTEL-2-... support the connection of IO-Link devices with few limitations.

- The process data length of the inputs and outputs is limited to 16 bytes each per port
- The driver strength on the C/Q line is limited to 250 mA
- SIO mode is not supported

### Power supply for devices

The electrical interface CPX-CTEL-2-... provides two separate power supplies for the connected devices:

- For operating the device and the inputs connected to it
- For the outputs and valves that are connected to the device

The power supply for the devices and the inputs is provided by the power

supply for the electronics and sensors of the CPX terminal.

The power supply for the outputs and valves is provided by the power supply for the valves of the CPX terminal.

The interlinking block with additional supply ensures a separate supply voltage for the valves and outputs. This

means it is possible to disconnect this supply voltage separately.

The valves and outputs of the connected I-Port devices can therefore be disconnected separately without disconnecting the devices.

## Data sheet – IO-Link interface

General technical data			
Type	CPX-CTEL-2-M12-5POL-LK		
Protocol	IO-Link, master version V 1.0		
Max. address capacity	Outputs	[bit]	256
	Inputs	[bit]	256
I-Port connection	2x socket M12, 5-pin, A-coded		
Number of IO-Link interfaces	2		
Maximum cable length	[m]	20	
Internal cycle time	[ms]	1 per 8 bits of user data	
Galvanic isolation	Channel – channel	No	
	Channel – internal bus	Yes, with intermediate supply	
LED displays	X1 ... 2 = Status of the IO-Link interface 1 ... 2 PS = Electronic supply PL = Load supply  = Module error		
Diagnostics	<ul style="list-style-type: none"> <li>• Communication error</li> <li>• Module short circuit</li> <li>• Module-oriented diagnostics</li> <li>• Undervoltage</li> </ul>		
Parameterisation	<ul style="list-style-type: none"> <li>• Diagnostic behaviour</li> <li>• Failsafe per channel</li> <li>• Forcing per channel</li> <li>• Idle mode per channel</li> <li>• Module parameters</li> </ul>		
Additional functions	–		
Control elements	DIL switch		
Operating voltage	Nominal value	[V DC]	24 (reverse polarity protected)
	Permissible range	[V DC]	18 ... 30
	Power failure buffering	[ms]	10
Intrinsic current consumption at nominal operating voltage	[mA]	Typically 65	
Max. power supply per channel	[A]	2x 1.6	
Max. residual current of outputs per channel	[A]	2x 1.6	
Degree of protection to EN 60529	IP65, IP67		
Temperature range	Operation	[°C]	–5 ... +50
	Storage/transport	[°C]	–20 ... +70
Materials	Reinforced PA, PC		
Note on materials	RoHS-compliant		
Grid dimension	[mm]	50	
Dimensions (including interlinking block) W x L x H	[mm]	50 x 107 x 55	
Product weight	[g]	110	

 **Note**

Please observe the general limits and guidelines for the system when configuring the electrical modules.

## Data sheet – IO-Link interface

### Connection and display components

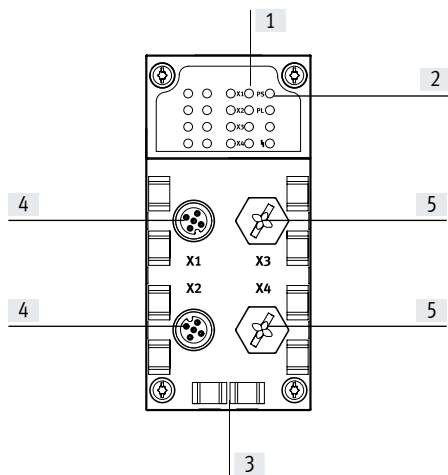

- [1] Status LEDs for I-Port interfaces
- [2] CPX-specific status LEDs
- [3] Holders for inscription labels (IBS 6x10)
- [4] IO-Link interfaces for up to 2 devices
- [5] Unused connections

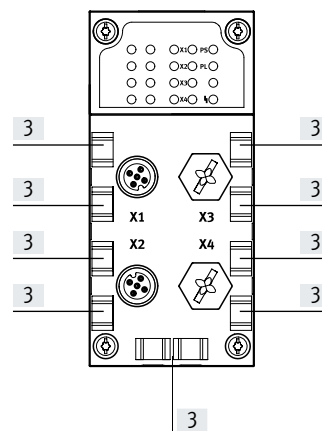

### Combinations of bus nodes/control blocks with interface CPX-CTEL-2

Bus node/control block	Part no.	Interface
		CPX-CTEL-2-M12-5POL-LK
CPX-CEC-C1-V3	3473128	■
CPX-CEC-M1-V3	3472765	■
CPX-CEC-S1-V3	3472425	■
CPX-FB33	548755	■
CPX-M-FB34	548751	■
CPX-M-FB35	548749	■
CPX-FB36	1912451	■
CPX-FB39	2093101	■
CPX-FB43	8110369	■
CPX-M-FB44	8110370	■
CPX-M-FB45	8110371	■

### Pin allocation of IO-Link interface

Terminal allocation	Pin	Signal	Designation
	1	24 V <sub>SEN</sub>	24 V DC supply voltage for electronics and inputs
	2	24 V <sub>VAL</sub>	24 V DC load voltage supply for valves and outputs
	3	0 V <sub>SEN</sub>	0 V DC supply voltage for electronics and sensors
	4	C/Q I-Port	Communication signal C/Q, data transmission line
	5	0 V <sub>VALVES</sub>	0 V DC load voltage supply for valves and outputs



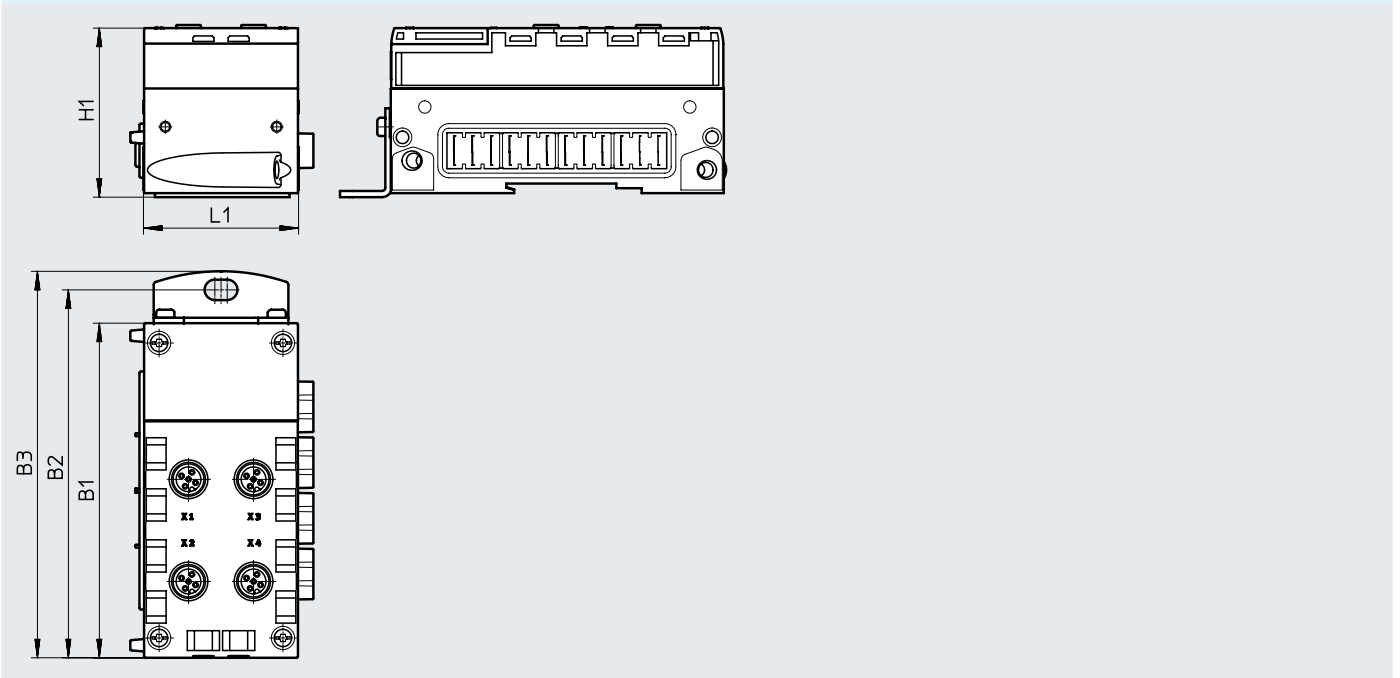

## Data sheet – IO-Link interface

## Dimensions

Download CAD data → [www.festo.com](http://www.festo.com)

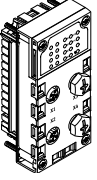
Type	B1	B2	B3	H1	L1
CPX-CTEL-2-M12-5POL-LK	108.1	118.9	124.9	55.1	50

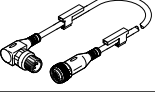
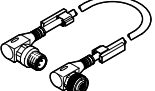
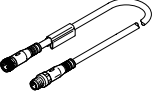
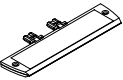
## Data sheet – IO-Link interface

Ordering data				Part no.	Type
CPX CTEL master, IO-Link					
	Interface for max. 2 I/O modules and valve terminals with IO-Link interface (devices)			<b>2900543</b>	<b>CPX-CTEL-2-M12-5POL-LK</b>
Bus connection					
	Cover cap	M12		<b>165592</b>	<b>ISK-M12</b>
	Connecting cable M12-M12, 5-pin • Straight socket • Angled plug	Cable characteristic: standard	0.5 m	<b>8003617</b>	<b>NEBU-M12G5-K-0.5-M12W5</b>
			2 m	<b>8003618</b>	<b>NEBU-M12G5-K-2-M12W5</b>
	Connecting cable M12-M12, 5-pin • Angled socket • Angled plug	Cable characteristic: standard	0.5 m	<b>570733</b>	<b>NEBU-M12W5-K-0.5-M12W5</b>
			2 m	<b>570734</b>	<b>NEBU-M12W5-K-2-M12W5</b>
	Connecting cable M12-M12, 5-pin • Straight socket • Straight plug	Cable characteristic: suitable for use with energy chains	5 m	<b>574321</b>	<b>NEBU-M12G5-E-5-Q8N-M12G5</b>
			7.5 m	<b>574322</b>	<b>NEBU-M12G5-E-7.5-Q8N-M12G5</b>
			10 m	<b>574323</b>	<b>NEBU-M12G5-E-10-Q8N-M12G5</b>
	Inscription label holder for connection block			<b>536593</b>	<b>CPX-ST-1</b>
User documentation					
	User documentation CPX CTEL master	German		<b>8034115</b>	<b>P.BE-CPX-CTEL-LK-DE</b>
		English		<b>8034116</b>	<b>P.BE-CPX-CTEL-LK-EN</b>
		Spanish		<b>8034117</b>	<b>P.BE-CPX-CTEL-LK-ES</b>
		French		<b>8034118</b>	<b>P.BE-CPX-CTEL-LK-FR</b>
		Italian		<b>8034119</b>	<b>P.BE-CPX-CTEL-LK-IT</b>
		Swedish		<b>8034120</b>	<b>P.BE-CPX-CTEL-LK-ZH</b>



## Data sheet – Axis controller for 4 electric axes

The control block CPX-CM-HPP is a module in the CPX terminal for controlling electric drives.

The control component is independent of the bus node used.

This means that Festo's electric drive technology is compatible with all industrial communication interfaces.

The control block does not need to be programmed.

- Max. 4 individual electric axes can be controlled via CAN bus
- No programming required
- Standardised communication with the drives via the Festo Handling and Positioning Profile (FHPP)
- Quick configuration and diagnostics via CPX-FMT
- Simple, flexible and cost-effective programmed.



General technical data		
Fieldbus interface		1x socket M9, 5-pin
Protocol		FHPP
Max. address capacity inputs	[byte]	32
Max. address volume for outputs	[byte]	32
LED display (product-specific)		Error: Fault PL: Power supply
Device-specific diagnostics		Diagnostic memory Channel and module-oriented diagnostics Undervoltage/short circuit of modules
Parameterisation		Forcing of channels System parameters
Configuration support		Operator unit CPX-MMI
Total number of axes		4
Nominal operating voltage	[V DC]	24
Operating voltage range	[V DC]	18 ... 30
Power failure buffering	[ms]	10
Intrinsic current consumption at nominal operating voltage	[mA]	Typically 80
Degree of protection to EN 60529 (with plug inserted)		IP65/IP67
Dimensions W x L x H (including interlinking block)	[mm]	50 x 107 x 55
Product weight (without interlinking block)	[g]	140
Materials		
Housing		PA-reinforced PC
Note on materials		RoHS-compliant
Technical data – Interfaces		
Interface		
Control interface		CAN bus
Baud rate	[Mbps]	1
Operating and environmental conditions		
Ambient temperature	[°C]	-5 ... +50
Storage temperature	[°C]	-20 ... +70
CE marking (see declaration of conformity)		To EU Low Voltage Directive

## Data sheet – Axis controller for 4 electric axes

### Connection and display components

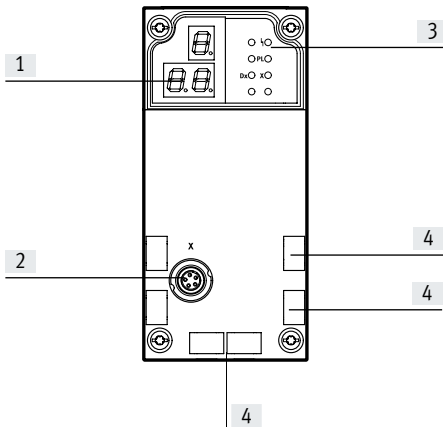

- [1] 3-digit display
- [2] Control interface
- [3] LED display (product-specific)
- [4] Inscription labels



### Pin allocation – Control interface

	Pin	Signal	Meaning
<b>Socket M9, 5-pin</b>			
	1	n.c.	Not connected
	2	n.c.	Not connected
	3	CAN_GND	CAN ground
	4	CAN_H	CAN high
	5	CAN_L	CAN low
	Housing	Shielding	Cable shield must be connected to functional earth (FE)

### Permitted bus nodes/CEC

Bus node/CEC	Protocol	Max. number of CPX-CM-HPP modules
CPX-CEC...	–	0
CPX-FB6	INTERBUS	0
CPX-FB11	DeviceNet	2
CPX-FB13	PROFIBUS	2
CPX-FB14	CANopen	1
CPX-M-FB21	INTERBUS	0
CPX-FB23-24	CC-Link	1 (as function module F23)
		0 (as function module F24)
CPX-FB33	PROFINET RT, M12	2
CPX-M-FB34	PROFINET RT, RJ45	2
CPX-M-FB35	PROFINET RT, SCRJ	2
CPX-FB36	EtherNet/IP	2
CPX-FB37	EtherCAT	2
CPX-FB39	Sercos III	2
CPX-FB40	POWERLINK	2
CPX-FB43	PROFINET RT, M12	2
CPX-M-FB44	PROFINET RT, RJ45	2
CPX-M-FB45	PROFINET RT, SCRJ	2

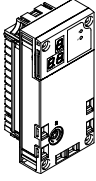
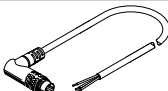
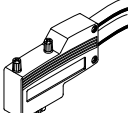
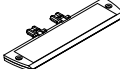
## Data sheet – Axis controller for 4 electric axes

Ordering data – Bus connection				
Designation			Part no.	Type
<b>Control block</b>				
	For actuating up to 4 electric drives via CAN bus		<b>562214</b>	<b>CPX-CM-HPP</b>
<b>Connecting cable</b>				
	Connecting cable	2 m	<b>563711</b>	<b>NEBC-M9W5-K-2-N-LE3</b>
		5 m	<b>563712</b>	<b>NEBC-M9W5-K-5-N-LE3</b>
	Plug for CAN bus interface; Sub-D, 9-pin, without terminating resistor		<b>533783</b>	<b>FBS-SUB-9-WS-CO-K</b>
<b>Inscription labels</b>				
	Inscription label holder for connection block		<b>536593</b>	<b>CPX-ST-1</b>
<b>User documentation</b>				
	Manual – Control block CPX-CM-HPP	German	<b>568683</b>	<b>CPX-CM-HPP-DE</b>
		English	<b>568684</b>	<b>CPX-CM-HPP-EN</b>

## Data sheet – Axis controller for 1 electric axis

The axis controller CPX-CMAX is intended exclusively for use in valve terminals CPX.

**General technical data**
**Operating voltage**

Operating voltage range	[V DC]	18 ... 30
Nominal operating voltage	[V DC]	24
Current consumption at nominal operating voltage	[mA]	200
Fuse protection (short circuit)		Electronic
Power failure buffering	[ms]	10

**Load voltage**

Load voltage range	[V DC]	20 ... 30
Nominal load voltage	[V DC]	24
Permissible load current	[A]	2.5
Fuse protection (short circuit)		Electronic

Number of axis strings		1	
Axes per string		1	
Length of connecting cable to axis	[m]	≤ 30	
Max. number of modules		7	
Display		7-segment display	
Assigned addresses	Outputs	[bit]	8x8
	Inputs	[bit]	8x8
Operating modes			Record mode
			Direct mode
Controller types			Position control
			Force control
Diagnostics			Module-orientated
			Via local 7-segment display
Status indication			Module status
			Power load
			Display/Error Axis X
			MC Axis X

**Control interface**

Data			CAN bus with Festo protocol
			Digital
Electrical connection			5-pin
			M9
			Socket

Materials: Housing			PA-reinforced
Note on materials			RoHS-compliant
Product weight		[g]	140
Dimensions	Length	[mm]	107
	Width	[mm]	50
	Height	[mm]	55

## Data sheet – Axis controller for 1 electric axis

Operating and environmental conditions		
Ambient temperature	[°C]	-5 ... +50
Relative humidity	[%]	5 ... 95, non-condensing
Degree of protection to IEC 60529		IP65

## Connection and display components

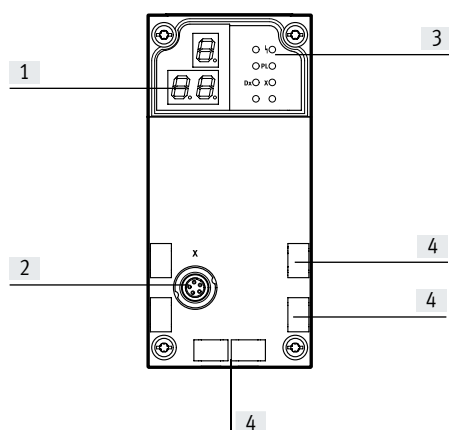

- [1] 3-digit display
- [2] Control interface
- [3] Status LEDs
- [4] Inscription labels

## Pin allocation – Control interface

	Pin	Signal	Designation
	1	+24 V	Nominal operating voltage
	2	+24 V	Load voltage
	3	0 V	Ground
	4	CAN_H	CAN high
	5	CAN_L	CAN low
	Housing	Shielding	Cable shielding



## Permitted bus nodes/CEC

Bus node/CEC	Protocol	Max. number of CMAX modules
CPX-CEC...	-	8
CPX-FB6	INTERBUS	1
CPX-FB11	DeviceNet <sup>1)</sup>	8
CPX-FB13	PROFIBUS <sup>2)</sup>	8
CPX-FB14	CANopen	4
CPX-M-FB21	INTERBUS	1
CPX-FB23-24	CC-Link	4 (as function module F23)
		8 (as function module F24)
CPX-FB33	PROFINET RT, M12	8
CPX-M-FB34	PROFINET RT, RJ45	8
CPX-M-FB35	PROFINET RT, SCRJ	8
CPX-FB36	EtherNet/IP	8
CPX-FB37	EtherCAT	8
CPX-FB39	Sercos III	8
CPX-FB40	POWERLINK	8
CPX-FB43	PROFINET RT, M12	8
CPX-M-FB44	PROFINET RT, RJ45	8
CPX-M-FB45	PROFINET RT, SCRJ	8

1) As of revision 20 (R20)

2) As of revision 23 (R23)

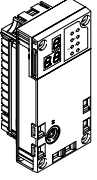
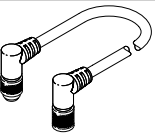
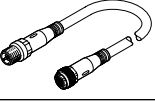
## Data sheet – Axis controller for 1 electric axis

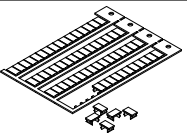
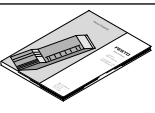
Ordering data		Brief description	Part no.	Type
<b>Axis controller</b>				
	Order code in the CPX configurator: T21		<b>548932</b>	<b>CPX-CMAX-C1-1</b>
<b>Connecting cables</b>				
	Connecting cable with angled plug and angled socket	0.25 m	<b>540327</b>	<b>KVI-CP-3-WS-WD-0.25</b>
		0.5 m	<b>540328</b>	<b>KVI-CP-3-WS-WD-0.5</b>
		2 m	<b>540329</b>	<b>KVI-CP-3-WS-WD-2</b>
		5 m	<b>540330</b>	<b>KVI-CP-3-WS-WD-5</b>
		8 m	<b>540331</b>	<b>KVI-CP-3-WS-WD-8</b>
	Connecting cable with straight plug and straight socket	2 m	<b>540332</b>	<b>KVI-CP-3-GS-GD-2</b>
		5 m	<b>540333</b>	<b>KVI-CP-3-GS-GD-5</b>
		8 m	<b>540334</b>	<b>KVI-CP-3-GS-GD-8</b>
	Connecting component for cabinet through feed		<b>543252</b>	<b>KVI-CP-3-SSD</b>
<b>Screws</b>				
	For mounting on the metal interlinking block		<b>550219</b>	<b>CPX-M-M3X22-4X</b>
<b>Inscription labels</b>				
	Inscription labels 6x10, in frames	64 pieces	<b>18576</b>	<b>IBS-6x10</b>
<b>User documentation</b>				
	Manual – Axis controller CPX-CMAX <sup>1)</sup>	German	<b>559750</b>	<b>P.BE-CPX-CMAX-SYS-DE</b>
		English	<b>559751</b>	<b>P.BE-CPX-CMAX-SYS-EN</b>
		Spanish	<b>559752</b>	<b>P.BE-CPX-CMAX-SYS-ES</b>
		French	<b>559753</b>	<b>P.BE-CPX-CMAX-SYS-FR</b>
		Italian	<b>559754</b>	<b>P.BE-CPX-CMAX-SYS-IT</b>

1) User documentation in paper form is not included in the scope of delivery.

## Data sheet – End-position controller

The end-position controller CPX-CMPX is intended exclusively for use in valve terminals CPX.



### General technical data

Operating voltage			
Operating voltage range	[V DC]	18 ... 30	
Nominal operating voltage	[V DC]	24	
Current consumption at nominal operating voltage	[mA]	80	
Load voltage			
Load voltage range	[V DC]	20 ... 30	
Nominal load voltage	[V DC]	24	
Permissible load current	[A]	2.5	
Number of axes per module		1	
Length of connecting cable to axis	[m]	≤ 30	
Max. number of modules		9	
Display		7-segment display	
Control elements		3 buttons	
Assigned addresses	Outputs	[bit]	6x8
	Inputs	[bit]	6x8
Diagnostics		Module-orientated Via local 7-segment display	
Status indication		Module status	
		Power load	
Control interface			
Data		CAN bus with Festo protocol Digital	
Electrical connection		5-pin	
		M9	
		Socket	
Materials: Housing		PA-reinforced	
Product weight	[g]	140	
Dimensions	Length	[mm]	107
	Width	[mm]	50
	Height	[mm]	55

## Data sheet – End-position controller

### Operating and environmental conditions

Ambient temperature	[°C]	-5 ... +50
Relative humidity	[%]	5 ... 95, non-condensing
Degree of protection to IEC 60529		IP65
CE marking (see declaration of conformity)		To EU EMC Directive

### Connection and display components

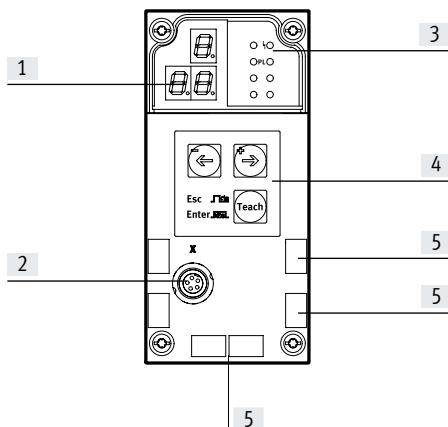

- [1] 3-digit display
- [2] Control interface
- [3] Status LEDs
- [4] Operating buttons
- [5] Inscription labels

### Pin allocation – Control interface

	Pin	Signal	Designation
	1	+24 V	Nominal operating voltage
	2	+24 V	Load voltage
	3	0 V	Ground
	4	CAN_H	CAN high
	5	CAN_L	CAN low
	Housing	Shielding	Cable shielding

### Permitted bus nodes/CEC



Bus node/CEC	Protocol	Max. no. of CMPX modules
CPX-CEC...	-	9
CPX-FB6	INTERBUS	2
CPX-FB11	DeviceNet <sup>1)</sup>	9
CPX-FB13	PROFIBUS <sup>2)</sup>	9
CPX-FB14	CANopen	5
CPX-M-FB21	INTERBUS	2
CPX-FB23-24	CC-Link	5 (as function module F23)
		9 (as function module F24)
CPX-FB33	PROFINET RT, M12	9
CPX-M-FB34	PROFINET RT, RJ45	9
CPX-M-FB35	PROFINET RT, SCRJ	9
CPX-FB36	EtherNet/IP	9
CPX-FB37	EtherCAT	9
CPX-FB39	Sercos III	9
CPX-FB40	POWERLINK	9
CPX-FB43	PROFINET RT, M12	9
CPX-M-FB44	PROFINET RT, RJ45	9
CPX-M-FB45	PROFINET RT, SCRJ	9

1) As of revision 20 (R20)

2) As of revision 23 (R23)

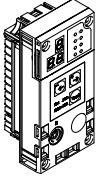
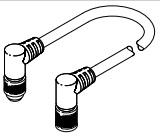
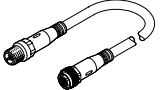

## Data sheet – End-position controller

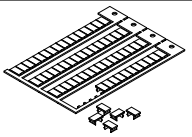
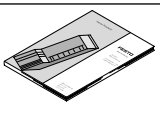
Ordering data		Brief description	Part no.	Type
<b>End-position controller</b>				
	Order code in the CPX configurator: T20		<b>548931</b>	<b>CPX-CMPX-C-1-H1</b>
<b>Connecting cables</b>				
	Connecting cable with angled plug and angled socket	0.25 m	<b>540327</b>	<b>KVI-CP-3-WS-WD-0.25</b>
		0.5 m	<b>540328</b>	<b>KVI-CP-3-WS-WD-0.5</b>
		2 m	<b>540329</b>	<b>KVI-CP-3-WS-WD-2</b>
		5 m	<b>540330</b>	<b>KVI-CP-3-WS-WD-5</b>
		8 m	<b>540331</b>	<b>KVI-CP-3-WS-WD-8</b>
	Connecting cable with straight plug and straight socket	2 m	<b>540332</b>	<b>KVI-CP-3-GS-GD-2</b>
		5 m	<b>540333</b>	<b>KVI-CP-3-GS-GD-5</b>
		8 m	<b>540334</b>	<b>KVI-CP-3-GS-GD-8</b>
	Connecting component for cabinet through feed		<b>543252</b>	<b>KVI-CP-3-SSD</b>
<b>Screws</b>				
	For mounting on the metal interlinking block		<b>550219</b>	<b>CPX-M-M3X22-4X</b>
<b>Inscription labels</b>				
	Inscription labels 6x10, in frames	64 pieces	<b>18576</b>	<b>IBS-6x10</b>
<b>User documentation</b>				
	Manual – End-position controller CPX-CMPX <sup>1)</sup>	German	<b>555479</b>	<b>P.BE-CPX-CMPX-SYS-DE</b>
		English	<b>555480</b>	<b>P.BE-CPX-CMPX-SYS-EN</b>
		Spanish	<b>555481</b>	<b>P.BE-CPX-CMPX-SYS-ES</b>
		French	<b>555482</b>	<b>P.BE-CPX-CMPX-SYS-FR</b>
		Italian	<b>555483</b>	<b>P.BE-CPX-CMPX-SYS-IT</b>

1) User documentation in paper form is not included in the scope of delivery.

## Data sheet – Measuring module for displacement encoder

The measuring module CPX-CMIX is intended exclusively for use in valve terminals CPX.



General technical data			
<b>Operating voltage</b>			
Operating voltage range	[V DC]		18 ... 30
Nominal operating voltage	[V DC]		24
Current consumption at nominal operating voltage	[mA]		80
Short circuit current rating			Yes
Power failure buffering	[ms]		10
Number of axis strings			1
Axes per string			1
Length of connecting cable to axis	[m]		≤ 30
Max. number of modules			9
Display			7-segment display
Assigned addresses	Outputs	[bit]	6x8
	Inputs	[bit]	6x8
Diagnostics			Channel and module-oriented
			Via local 7-segment display
			Undervoltage of modules
Status indication			Undervoltage of measuring system
			Power load
			Error
<b>Control interface</b>			
Data			CAN bus with Festo protocol
			Digital
Electrical connection			5-pin
			M9
			Socket
Materials: Housing			PA-reinforced
Note on materials			RoHS-compliant
Product weight	[g]		140
Dimensions	Length	[mm]	107
	Width	[mm]	50
	Height	[mm]	55

## Data sheet – Measuring module for displacement encoder

Operating and environmental conditions		
Ambient temperature	[°C]	-5 ... +50
Relative humidity	[%]	5 ... 95, non-condensing
Degree of protection to IEC 60529		IP65

## Connection and display components

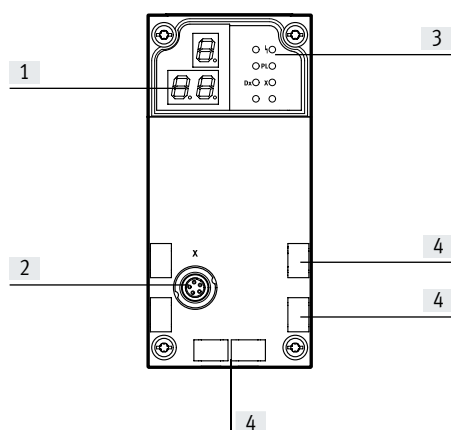

- [1] 3-digit display
- [2] Control interface
- [3] Status LEDs
- [4] Inscription labels

## Pin allocation – Control interface

	Pin	Signal	Designation
	1	+24 V	Nominal operating voltage
	2	+24 V	Load voltage
	3	0 V	Ground
	4	CAN_H	CAN high
	5	CAN_L	CAN low
	Housing	Shielding	Cable shielding



## Permitted bus nodes/CEC

Bus node/CEC	Protocol	Max. number of CMIX modules
CPX-CEC...	-	9
CPX-FB6	INTERBUS	2
CPX-FB11	DeviceNet <sup>1)</sup>	9
CPX-FB13	PROFIBUS <sup>2)</sup>	9
CPX-FB14	CANopen	5
CPX-M-FB21	INTERBUS	2
CPX-FB23-24	CC-Link	5 (as function module F23)
		9 (as function module F24)
CPX-FB33	PROFINET RT, M12	9
CPX-M-FB34	PROFINET RT, RJ45	9
CPX-M-FB35	PROFINET RT, SCRJ	9
CPX-FB36	EtherNet/IP	9
CPX-FB37	EtherCAT	9
CPX-FB39	Sercos III	9
CPX-FB40	POWERLINK	9
CPX-FB43	PROFINET RT, M12	9
CPX-M-FB44	PROFINET RT, RJ45	9
CPX-M-FB45	PROFINET RT, SCRJ	9

1) As of revision 20 (R20)

2) As of revision 23 (R23)

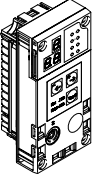
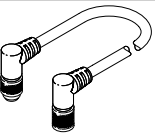
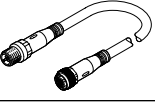
## Data sheet – Measuring module for displacement encoder

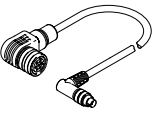
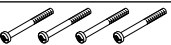
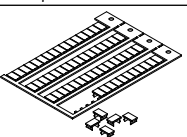
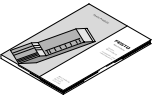
Ordering data		Brief description	Part no.	Type
<b>Measuring module</b>				
	Order code in the CPX configurator: T23		<b>567417</b>	<b>CPX-CMIX-M1-1</b>
<b>Connecting cables</b>				
	Connecting cable with angled plug and angled socket	0.25 m	<b>540327</b>	<b>KVI-CP-3-WS-WD-0.25</b>
		0.5 m	<b>540328</b>	<b>KVI-CP-3-WS-WD-0.5</b>
		2 m	<b>540329</b>	<b>KVI-CP-3-WS-WD-2</b>
		5 m	<b>540330</b>	<b>KVI-CP-3-WS-WD-5</b>
		8 m	<b>540331</b>	<b>KVI-CP-3-WS-WD-8</b>
	Connecting cable with straight plug and straight socket	2 m	<b>540332</b>	<b>KVI-CP-3-GS-GD-2</b>
		5 m	<b>540333</b>	<b>KVI-CP-3-GS-GD-5</b>
		8 m	<b>540334</b>	<b>KVI-CP-3-GS-GD-8</b>
	Connecting component for cabinet through feed		<b>543252</b>	<b>KVI-CP-3-SSD</b>
	For displacement encoder MME: Connection between displacement encoder MME and measuring module CPX-CMIX	2 m	<b>575898</b>	<b>NEBP-M16W6-K-2-M9W5</b>
<b>Screws</b>				
	For mounting on the metal interlinking block		<b>550219</b>	<b>CPX-M-M3X22-4X</b>
<b>Inscription labels</b>				
	Inscription labels 6x10, in frames	64 pieces	<b>18576</b>	<b>IBS-6x10</b>
<b>User documentation</b>				
	Manual – Measuring module CPX-CMIX <sup>1)</sup>	German	<b>567053</b>	<b>P.BE-CPX-CMIX-DE</b>
		English	<b>567054</b>	<b>P.BE-CPX-CMIX-EN</b>
		Spanish	<b>567055</b>	<b>P.BE-CPX-CMIX-ES</b>
		French	<b>567056</b>	<b>P.BE-CPX-CMIX-FR</b>
		Italian	<b>567057</b>	<b>P.BE-CPX-CMIX-IT</b>

1) User documentation in paper form is not included in the scope of delivery.

## Data sheet – Input module, digital

### Function

Digital input modules enable the connection of two-wire and three-wire sensors (proximity switches, inductive or capacitive sensors, etc.).

Depending on the connection block selected, the module supports various connection concepts with different numbers of sockets (single or double allocation).

### Area of application

- Input modules for 24 V DC sensor supply voltage
- PNP or NPN logic
- Supports connection blocks with M12, M8, Sub-D, HARAX and terminal connection
- Module features can be parameterised
- The input module receives the supply voltage for the electronics and the sensors from the interlinking block
- Module protection and diagnostics through integrated electronic protection



General technical data		CPX-4DE	CPX-8DE	CPX-8DE-D	CPX-8NDE
Type					
Number of inputs		4	8	8	8
Max. residual current of inputs per module	[A]	0.7	1	0.7	0.7
Fuse protection		Internal electronic fuse per module	Internal electronic fuse per module	Internal electronic fuse per channel	Internal electronic fuse per module
Intrinsic current consumption at operating voltage	[mA]	Typically 15			
Operating voltage	Nominal value	24			
	Permissible range	18 ... 30			
Galvanic isolation	Channel – channel	No			
	Channel – internal bus	No			
Switching level	Signal 0	≤ 5			≥ 11
	Signal 1	≥ 11			≤ 5
Input debounce time	[ms]	3 (0.1, 10, 20 parameterisable)			
Input characteristic		IEC 1131-T2			
Switching logic		Positive logic (PNP)			Negative logic (NPN)
LED displays	Group diagnostics	1	1	1	1
	Channel diagnostics	–	–	8	–
	Channel status	4	8	8	8
Diagnostics		Short circuit/overload per channel			
Parameterisation		<ul style="list-style-type: none"> <li>• Module monitoring</li> <li>• Behaviour after short circuit</li> <li>• Input debounce time</li> <li>• Signal extension time</li> </ul>			
Degree of protection to EN 60529		Depending on connection block			
Temperature range	Operation	–5 ... +50			
	Storage/transport	–20 ... +70			
Materials		Reinforced PA, PC			
Grid dimension	[mm]	50			
Dimensions (including interlinking block and connection block) W x L x H	[mm]	50 x 107 x 50			
Product weight	[g]	39	39	45	40

## Data sheet – Input module, digital

### Connection and display components

CPX-4DE

CPX-8DE

CPX-8DE-D

CPX-8NDE

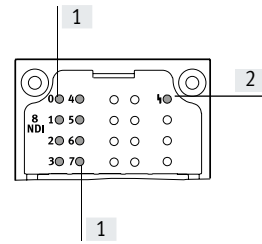
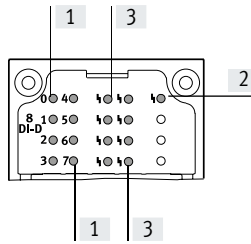
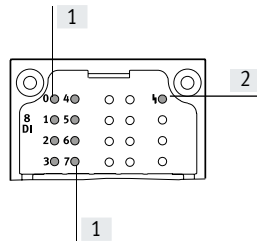
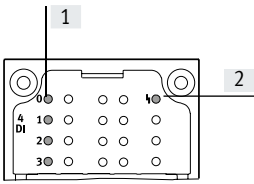

[1] Status LEDs (green)

[2] Error LED (red, module error)

[3] Channel-related error LEDs (red)

For allocation to inputs  
→ Pin allocation for module

### Combinations of connection blocks and digital input modules

Connection blocks	Part no.	Digital input modules			
		CPX-4DE	CPX-8DE	CPX-8DE-D	CPX-8NDE
CPX-AB-8-M8-3POL	195706	■	■	■	■
CPX-AB-4-M12X2-5POL	195704	■	■	■	■
CPX-AB-4-M12X2-5POL-R	541254	■	■	■	■
CPX-AB-8-KL-4POL	195708	■	■	■	■
CPX-AB-1-SUB-BU-25POL	525676	■	■	■	■
CPX-AB-4-HAR-4POL	525636	■	■	■	■
CPX-M-AB-4-M12X2-5POL	549367	■	■	■	■

### Pin allocation



Connection block inputs	CPX-4DE	CPX-8DE, CPX-8DE-D and CPX-8NDE		
<b>CPX-AB-8-M8-3POL</b>				
	X1.1: 24 V <sub>SEN</sub>	X5.1: 24 V <sub>SEN</sub>	X1.1: 24 V <sub>SEN x</sub>	X5.1: 24 V <sub>SEN x+4</sub>
	X1.3: 0 V <sub>SEN</sub>	X5.3: 0 V <sub>SEN</sub>	X1.3: 0 V <sub>SEN x</sub>	X5.3: 0 V <sub>SEN x+4</sub>
	X1.4: Input x	X5.4: Input x+2	X1.4: Input x	X5.4: Input x+4
	X2.1: 24 V <sub>SEN</sub>	X6.1: 24 V <sub>SEN</sub>	X2.1: 24 V <sub>SEN x+1</sub>	X6.1: 24 V <sub>SEN x+5</sub>
	X2.3: 0 V <sub>SEN</sub>	X6.3: 0 V <sub>SEN</sub>	X2.3: 0 V <sub>SEN x+1</sub>	X6.3: 0 V <sub>SEN x+5</sub>
	X2.4: Input x+1	X6.4: Input x+3	X2.4: Input x+1	X6.4: Input x+5
	X3.1: 24 V <sub>SEN</sub>	X7.1: 24 V <sub>SEN</sub>	X3.1: 24 V <sub>SEN x+2</sub>	X7.1: 24 V <sub>SEN x+6</sub>
	X3.3: 0 V <sub>SEN</sub>	X7.3: 0 V <sub>SEN</sub>	X3.3: 0 V <sub>SEN x+2</sub>	X7.3: 0 V <sub>SEN x+6</sub>
X3.4: Input x+1	X7.4: Input x+3	X3.4: Input x+2	X7.4: Input x+6	
X4.1: 24 V <sub>SEN</sub>	X8.1: 24 V <sub>SEN</sub>	X4.1: 24 V <sub>SEN x+3</sub>	X8.1: 24 V <sub>SEN x+7</sub>	
X4.3: 0 V <sub>SEN</sub>	X8.3: 0 V <sub>SEN</sub>	X4.3: 0 V <sub>SEN x+3</sub>	X8.3: 0 V <sub>SEN x+7</sub>	
X4.4: n.c.	X8.4: n.c.	X4.4: Input x+3	X8.4: Input x+7	
<b>CPX-AB-4-M12X2-5POL, CPX-AB-4-M12X2-5POL-R<sup>1)</sup> and CPX-M-AB-4-M12X2-5POL</b>				
	X1.1: 24 V <sub>SEN</sub>	X3.1: 24 V <sub>SEN</sub>	X1.1: 24 V <sub>SEN x</sub>	X3.1: 24 V <sub>SEN x+4</sub>
	X1.2: Input x+1	X3.2: Input x+3	X1.2: Input x+1	X3.2: Input x+5
	X1.3: 0 V <sub>SEN</sub>	X3.3: 0 V <sub>SEN</sub>	X1.3: 0 V <sub>SEN x</sub>	X3.3: 0 V <sub>SEN x+4</sub>
	X1.4: Input x	X3.4: Input x+2	X1.4: Input x	X3.4: Input x+4
	X1.5: FE	X3.5: FE	X1.5: FE	X3.5: FE
	X2.1: 24 V <sub>SEN</sub>	X4.1: 24 V <sub>SEN</sub>	X2.1: 24 V <sub>SEN x+2</sub>	X4.1: 24 V <sub>SEN x+6</sub>
	X2.2: n.c.	X4.2: n.c.	X2.2: Input x+3	X4.2: Input x+7
	X2.3: 0 V <sub>SEN</sub>	X4.3: 0 V <sub>SEN</sub>	X2.3: 0 V <sub>SEN x+2</sub>	X4.3: 0 V <sub>SEN x+6</sub>
	X2.4: Input x+1	X4.4: Input x+3	X2.4: Input x+2	X4.4: Input x+6
	X2.5: FE	X4.5: FE	X2.5: FE	X4.5: FE

1) Speedcon quick lock, additional shielding on metal thread

## Data sheet – Input module, digital

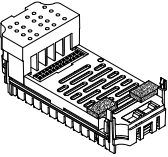
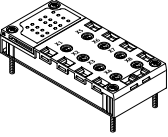
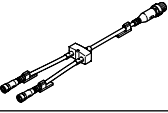

Pin allocation		CPX-4DE		CPX-8DE, CPX-8DE-D and CPX-8NDE	
<b>CPX-AB-8-KL-4POL</b>					
		X1.0: $24 V_{SEN}$ X1.1: $0 V_{SEN}$ X1.2: Input x X1.3: FE  X2.0: $24 V_{SEN}$ X2.1: $0 V_{SEN}$ X2.2: Input x+1 X2.3: FE  X3.0: $24 V_{SEN}$ X3.1: $0 V_{SEN}$ X3.2: Input x+1 X3.3: FE  X4.0: $24 V_{SEN}$ X4.1: $0 V_{SEN}$ X4.2: n.c. X4.3: FE	X5.0: $24 V_{SEN}$ X5.1: $0 V_{SEN}$ X5.2: Input x+2 X5.3: FE  X6.0: $24 V_{SEN}$ X6.1: $0 V_{SEN}$ X6.2: Input x+3 X6.3: FE  X7.0: $24 V_{SEN}$ X7.1: $0 V_{SEN}$ X7.2: Input x+3 X7.3: FE  X8.0: $24 V_{SEN}$ X8.1: $0 V_{SEN}$ X8.2: n.c. X8.3: FE	X1.0: $24 V_{SEN x}$ X1.1: $0 V_{SEN x}$ X1.2: Input x X1.3: FE  X2.0: $24 V_{SEN x+1}$ X2.1: $0 V_{SEN x+1}$ X2.2: Input x+1 X2.3: FE  X3.0: $24 V_{SEN x+2}$ X3.1: $0 V_{SEN x+2}$ X3.2: Input x+2 X3.3: FE  X4.0: $24 V_{SEN x+3}$ X4.1: $0 V_{SEN x+3}$ X4.2: Input x+3 X4.3: FE	X5.0: $24 V_{SEN x+4}$ X5.1: $0 V_{SEN x+4}$ X5.2: Input x+4 X5.3: FE  X6.0: $24 V_{SEN x+5}$ X6.1: $0 V_{SEN x+5}$ X6.2: Input x+5 X6.3: FE  X7.0: $24 V_{SEN x+6}$ X7.1: $0 V_{SEN x+6}$ X7.2: Input x+6 X7.3: FE  X8.0: $24 V_{SEN x+7}$ X8.1: $0 V_{SEN x+7}$ X8.2: Input x+7 X8.3: FE
<b>CPX-AB-1-SUB-BU-25POL</b>					
		1: Input x 2: Input x+1 3: Input x+1 4: n.c. 5: $24 V_{SEN}$ 6: $0 V_{SEN}$ 7: $24 V_{SEN}$ 8: $0 V_{SEN}$ 9: $24 V_{SEN}$ 10: $24 V_{SEN}$ 11: $0 V_{SEN}$ 12: $0 V_{SEN}$ 13: FE Housing: FE	14: Input x+2 15: Input x+3 16: Input x+3 17: n.c. 18: $24 V_{SEN}$ 19: $24 V_{SEN}$ 20: $24 V_{SEN}$ 21: $24 V_{SEN}$ 22: $0 V_{SEN}$ 23: $0 V_{SEN}$ 24: $0 V_{SEN}$ 25: FE Housing: FE	1: Input x 2: Input x+1 3: Input x+2 4: Input x+3 5: $24 V_{SEN x+1}$ 6: $0 V_{SEN x+1}$ 7: $24 V_{SEN x+3}$ 8: $0 V_{SEN x+3}$ 9: $24 V_{SEN x}$ 10: $24 V_{SEN x+2}$ 11: $0 V_{SEN x}$ 12: $0 V_{SEN x+2}$ 13: FE	14: Input x+4 15: Input x+5 16: Input x+6 17: Input x+7 18: $24 V_{SEN x+4}$ 19: $24 V_{SEN x+5}$ 20: $24 V_{SEN x+6}$ 21: $24 V_{SEN x+7}$ 22: $0 V_{SEN x+2 u. 3}$ 23: $0 V_{SEN x+2 u. 3}$ 24: $0 V_{SEN x+2 u. 3}$ 25: FE Housing: FE
<b>CPX-AB-4-HAR-4POL</b>					
		X1.1: $24 V_{SEN}$ X1.2: Input x+1 X1.3: $0 V_{SEN}$ X1.4: Input x  X2.1: $24 V_{SEN}$ X2.2: n.c. X2.3: $0 V_{SEN}$ X2.4: Input x+1	X3.1: $24 V_{SEN}$ X3.2: Input x+3 X3.3: $0 V_{SEN}$ X3.4: Input x+2  X4.1: $24 V_{SEN}$ X4.2: n.c. X4.3: $0 V_{SEN}$ X4.4: Input x+3	X1.1: $24 V_{SEN x}$ X1.2: Input x+1 X1.3: $0 V_{SEN x}$ X1.4: Input x  X2.1: $24 V_{SEN x+2}$ X2.2: Input x+3 X2.3: $0 V_{SEN x+2}$ X2.4: Input x+2	X3.1: $24 V_{SEN x+4}$ X3.2: Input x+5 X3.3: $0 V_{SEN x+4}$ X3.4: Input x+4  X4.1: $24 V_{SEN x+6}$ X4.2: Input x+7 X4.3: $0 V_{SEN x+6}$ X4.4: Input x+6

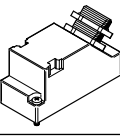
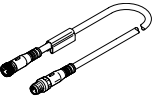
## Data sheet – Input module, digital

Ordering data				Part no.	Type	
Designation						
Input module, digital						
	4 digital inputs, positive logic (PNP)			195752	CPX-4DE	
	8 digital inputs, positive logic (PNP)			195750	CPX-8DE	
	8 digital inputs, positive logic (PNP), enhanced diagnostic function			541480	CPX-8DE-D	
	8 digital inputs, negative logic (NPN)			543813	CPX-8NDE	
Connection block						
	Plastic	8x socket M8, 3-pin		195706	CPX-AB-8-M8-3POL	
		4x socket M12, 5-pin		195704	CPX-AB-4-M12X2-5POL	
		4x socket, M12 with quick-lock technology, 5-pin		541254	CPX-AB-4-M12X2-5POL-R	
		Spring-loaded terminal, 32-pin		195708	CPX-AB-8-KL-4POL	
		1x socket, Sub-D, 25-pin		525676	CPX-AB-1-SUB-BU-25POL	
	4x socket, quick connector, 4-pin		525636	CPX-AB-4-HAR-4POL		
	Metal	4x socket M12, 5-pin		549367	CPX-M-AB-4-M12X2-5POL	
Distributor						
	Modular system for all types of sensor/actuator distributor			–	NEDY-... → Internet: nedy	
	1x plug M12, 4-pin	2x socket M8, 3-pin		8005311	NEDY-L2R1-V1-M8G3-N-M12G4	
		2x socket M12, 5-pin		8005310	NEDY-L2R1-V1-M12G5-N-M12G4	
Plug						
	Plug	M8, 3-pin	Solderable	18696	SEA-GS-M8	
			Screw-in	192009	SEA-3GS-M8-S	
		M12, 4-pin, PG7			18666	SEA-GS-7
		M12, PG7, 4-pin for cable Ø 2.5 mm			192008	SEA-4GS-7-2.5
		M12, 4-pin, PG9			18778	SEA-GS-9
		M12, 4 pin for 2 cables			18779	SEA-GS-11-DUO
	Sub-D plug, 25-pin	M12 for 2 cables, 5-pin		192010	SEA-5GS-11-DUO	
		M12, 5-pin		175487	SEA-M12-5GS-PG7	
			527522	SD-SUB-D-ST25		
Connecting cable						
	Connecting cable M8-M8	0.5 m		541346	NEBU-M8G3-K-0.5-M8G3	
		1.0 m		541347	NEBU-M8G3-K-1-M8G3	
		2.5 m		541348	NEBU-M8G3-K-2.5-M8G3	
		5.0 m		541349	NEBU-M8G3-K-5-M8G3	
	Modular system for a choice of connecting cables			–	NEBU-... → Internet: nebu	

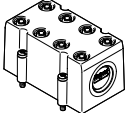
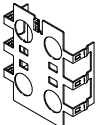

## Data sheet – Input module, digital

Ordering data		Part no.	Type	
Designation				
Cover				
	Cover for CPX-AB-8-KL-4POL (IP65, IP67) • 8 cable through feeds M9 • 1 cable through feed for multi-pin plug	538219	AK-8KL	
	Fittings kit	538220	VG-K-M9	
Screening plate				
	Screening plate for M12 connections	526184	CPX-AB-S-4-M12	
User documentation				
	User documentation	German	526439	P.BE-CPX-EA-DE
		English	526440	P.BE-CPX-EA-EN
		Spanish	526441	P.BE-CPX-EA-ES
		French	526442	P.BE-CPX-EA-FR
		Italian	526443	P.BE-CPX-EA-IT

## Data sheet – Input module, digital, NAMUR

### Function

Digital input modules enable the connection of up to 8 NAMUR sensors (or wired mechanical contacts). In addition, the first 4 channels can alternatively be used as counters or for frequency measurement.

M12 and terminal strip connection technology can be used.

### Area of application

- Input modules for 24 V DC sensor supply voltage
- Module features can be parameterised
- The input module receives the supply voltage for the electronics and the sensors from the interlinking block
- Module protection and diagnostics through integrated electronic protection in each channel



General technical data		CPX-P-8DE-N
Type		CPX-P-8DE-N
Number of inputs		8
Maximum cable length	[m]	200
Input debounce time	[ms]	3 (0, 10, 20 parameterisable)
Fuse protection (short circuit)		Internal electronic fuse per channel
Module current consumption (power supply for electronics)	[mA]	Typically 75
Nominal operating voltage	[V DC]	24 (reverse polarity protected)
Permissible voltage fluctuations	[%]	±25
Power failure buffering	[ms]	20
Residual ripple	[Vss]	0.4
Galvanic isolation	Channel – channel	No
	Channel – internal bus	Yes
Input characteristics		To EN 60947-5-6
Switching level		To EN 60947-5-6
LED displays	Group diagnostics	1
	Channel diagnostics	8
	Channel status	8
Diagnostics		Wire break per channel
		Limit value violation per channel
		Parameterisation error
		Overload per channel
Parameterisation		Data format
		Input debounce time per channel
		Input function per channel
		Replacement value in diagnostic case per channel
		Upper limit value per channel
		Signal extension time per channel
		Gate time per channel
		Monitoring of limit values per channel
		Monitoring of short circuit per channel
		Monitoring of wire break per channel
		Monitoring of parameters
		Lower limit value per channel
		Upper limit value per channel
		Counter configuration per channel
Control elements		DIL switch
Additional functions		Frequency measurement
		Counter function
Degree of protection to EN 60529		Depending on the connection block

## Data sheet – Input module, digital, NAMUR

General technical data		
Grid dimension	[mm]	50
Dimensions (including interlinking block and connection block) W x L x H	[mm]	50 x 107 x 70
Product weight	[g]	100

Materials	
Housing	PA-reinforced PC
Note on materials	RoHS-compliant

Operating and environmental conditions		
Ambient temperature	[°C]	-5 ... +50
Storage temperature	[°C]	-20 ... +70
Relative humidity	[%]	95, non-condensing

## Connection and display components

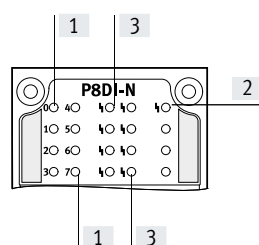

- [1] Status LEDs (green): for allocation to the inputs → pin allocation of the module
- [2] Error LED (red, module error)
- [3] Channel-related error LEDs (red)





Combinations of bus nodes/control blocks with digital input module		
Bus node/control block	Part no.	Digital input module CPX-P-8DE-N
CPX-CEC-C1-V3	3473128	■
CPX-CEC-M1-V3	3472765	■
CPX-CEC-S1-V3	3472425	■
CPX-FB11	526172	■
CPX-FB13	195740	■
CPX-FB14	526174	■
CPX-FB33	548755	■
CPX-M-FB34	548751	■
CPX-M-FB35	548749	■
CPX-FB36	1912451	■
CPX-FB37	2735960	■
CPX-FB43	8110369	■
CPX-M-FB44	8110370	■
CPX-M-FB45	8110371	■

Combinations of connection block and digital input module		
Connection blocks	Part no.	Digital input module CPX-P-8DE-N
CPX-P-AB-4XM12-4POL	565706	■
CPX-P-AB-2XKL-8POL	565704	■

## Data sheet – Input module, digital, NAMUR

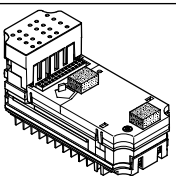
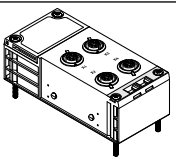
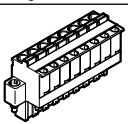
Pin allocation		CPX-P-8DE-N	
Connection block inputs			
<b>CPX-P-AB-4XM12-4POL</b>			
	X1.1: BN+ [0] X1.2: BU- [0] X1.3: BN+ [1] X1.4: BU- [1] X2.1: BN+ [2] X2.2: BU- [2] X2.3: BN+ [3] X2.4: BU- [3]	X3.1: BN+ [4] X3.2: BU- [4] X3.3: BN+ [5] X3.4: BU- [5] X4.1: BN+ [6] X4.2: BU- [6] X4.3: BN+ [7] X4.4: BU- [7]	
<b>CPX-P-AB-2XKL-8POL</b>			
	X1.1: BN+ [0] X1.2: BU- [0] X1.3: BN+ [1] X1.4: BU- [1] X1.5: BN+ [2] X1.6: BU- [2] X1.7: BN+ [3] X1.8: BU- [3]	X2.1: BN+ [4] X2.2: BU- [4] X2.3: BN+ [5] X2.4: BU- [5] X2.5: BN+ [6] X2.6: BU- [6] X2.7: BN+ [7] X2.8: BU- [7]	
<b>Combinations of interlinking block/digital input module</b>			
Interlinking blocks	Part no.	Digital input module	
		CPX-P-8DE-N	
CPX-GE-EV-S	195746	-	
CPX-GE-EV-S-VL	8022170	-	
CPX-GE-EV-S-7/8-4POL	541248	-	
CPX-M-GE-EV-S-7/8-CIP-4P	568956	-	
CPX-GE-EV-S-7/8-5POL	541244	-	
CPX-GE-EV-S-7/8-5POL-VL	8022172	-	
CPX-M-GE-EV-S-7/8-5POL	550208	■	
CPX-M-GE-EV-S-7/8-5POL-VL	8022165	■	
CPX-M-GE-EV-S-M12-5POL	8098392	-	
CPX-M-GE-EV-S-PP-5POL	563057	-	
CPX-GE-EV	195742	-	
CPX-M-GE-EV	550206	■	
CPX-GE-EV-Z	195744	-	
CPX-GE-EV-Z-VL	8022166	-	
CPX-GE-EV-Z-7/8-4POL	541250	-	
CPX-GE-EV-Z-7/8-5POL	541246	-	
CPX-GE-EV-Z-7/8-5POL-VL	8022173	-	
CPX-M-GE-EV-Z-7/8-5POL	550210	■	
CPX-M-GE-EV-Z-7/8-5POL-VL	8022158	■	
CPX-M-GE-EV-Z-PP-5POL	563058	-	
CPX-GE-EV-V	533577	-	
CPX-GE-EV-V-VL	8022171	-	
CPX-GE-EV-V-7/8-4POL	541252	-	
CPX-M-GE-EV-W-M12-5POL	8098391	-	

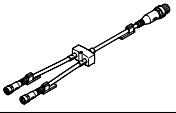
## Data sheet – Input module, digital, NAMUR

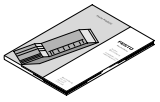
Ordering data		Part no.	Type	
Designation				
Input module, digital, NAMUR				
	8 digital inputs	<b>565933</b>	<b>CPX-P-8DE-N</b>	
Connection block				
	Plastic	4x socket, M12, 4-pin	<b>565706</b> CPX-P-AB-4XM12-4POL	
		2x plug, 8-pin	<b>565704</b> CPX-P-AB-2XKL-8POL	
Plug				
	Socket	8-pin	Spring-loaded terminal	<b>565712</b> NECU-L3G8-C1
			Screw terminal	<b>565710</b> NECU-L3G8-C2
	Plug M12x1, 4-pin, straight, A-coded	Screw terminal	Connection cross section 0.14 ... 0.5 mm <sup>2</sup>	<b>192008</b> SEA-4GS-7-2.5
			Nominal conductor cross section 0.14 ... 0.75 mm <sup>2</sup>	<b>18666</b> SEA-GS-7
			Permissible cable Ø 4 ... 6 mm	
			Connection cross section 0.75 mm <sup>2</sup>	<b>18778</b> SEA-GS-9
	Permissible cable Ø 6 ... 8 mm			
Distributor				
	Modular system for all types of sensor/actuator distributor	–	<b>NEDY-...</b> → Internet: nedy	
Cover				
	Cover cap for closing off unused connections (10 pieces)	For M12 connections	<b>165592</b> ISK-M12	
Coding element				
	To ensure that a coded socket NECU-L3G8 can only be inserted in the matching coded connection block CPX-P-AB-2XKL (96 of each)	For NECU-L3G8	<b>565713</b> CPX-P-KDS-AB-2XKL	
User documentation				
	User documentation	German	<b>575378</b> P.BE-CPX-P-EA-DE	
		English	<b>575379</b> P.BE-CPX-P-EA-EN	
		Spanish	<b>575380</b> P.BE-CPX-P-EA-ES	
		French	<b>575381</b> P.BE-CPX-P-EA-FR	
		Italian	<b>575382</b> P.BE-CPX-P-EA-IT	
		Swedish	<b>575383</b> P.BE-CPX-P-EA-SV	

## Data sheet – Input module, digital, PROFI-safe

**Function**

The PROFI-safe input module has 8 input channels whose signal status is detected for safety reasons, with the information transmitted to a suitable safety controller using the PROFI-safe safety protocol in combination with the appropriate fieldbus (PROFINET or PROFIBUS). This function is exclusively available for safety controllers using the PROFI-safe protocol, profile version 2.4.

**Area of application**

- Input module for 24 V DC sensor supply voltage
- Supports connection blocks with M12 and terminal connection
- Module features can be parameterised
- The input module receives the supply voltage for the electronics and the sensors from the interlinking block
- Module protection and diagnostics through integrated electronic protection

**Description****Module-based passivation**

While channel-based passivation is disabled, the input module, in accordance with PROFI-safe specification, switches all information in the input image to the safe status, even when there is only one channel error.

**Channel-based passivation**

In the case of channel-based passivation, when a channel error occurs, the input module switches the input information of the affected channel pair to 0, depending on the function mode.

- The input information for unaffected channel pairs does not change
- The input module remains integrated.
- The input module indicates the current channel error status to the control unit via the input image.

**Applications**

The inputs on the PROFI-safe input module can be combined for multi-channel sensor applications. Every two inputs form a channel pair, which is set separately with one of 11 function modes.

The function mode has an influence on the evaluation of the input signals, and optionally on the generation of clock signals.

There are 5 independent clock outputs available for safe operation of passive sensors; the pulse patterns are used in some operating modes to detect crossovers in the signal paths.

The entire input module is designed to ensure that the input channels provide either secure data or no data at all, even when an error is present in the system

**Range of applications**

- Use as an input module for a higher-order safety controller. Several input modules can be used together and these monitor mutually independent sensors
- Use of multi-channel sensor applications with up to 8 secure inputs, which can be grouped and are suitable for configuration with the help of 11 different function modes
- Connection of various switches and sensors within the safety chain
- Output of an identifier coded by DIL switch in the connection block CPX-AB-ID-P

**Note**

The safety integrity level, Performance Level and category for the system as a whole correspond to that of the component in the safety chain with the lowest characteristic value.

**Application examples**

- Two-hand control device for starting a function
- Operating mode selector switch with four positions
- Light curtain
- End-position switch
- Emergency stop switch for incidents
- Rotary indexing table
- Acknowledge button with request
- Protective door with two NO switches

## Data sheet – Input module, digital, PROFIsafe

General technical data			
Type	CPX-F8DE-P		
Number of inputs	8		
Safety function	Reliable detection and evaluation of input statuses		
Max. address capacity	Inputs	[byte]	6
	Outputs	[byte]	7
Maximum cable length			[m] 200
Max. power supply	Per module	[A]	3
Current consumption of module			[mA] Typically 35 (power supply for electronics)
Operating voltage	Nominal value	[V DC]	24
	Permissible range	[V DC]	20.4 ... 28.8
Voltage drop per channel			[V] 0.6
Residual ripple			[Vss] 2 within voltage range
Galvanic isolation	Channel – channel	No	
Input characteristics	To IEC 61131-2, type 2		
Switching logic	Inputs	PNP (positive switching)	
Safety integrity level	As per EN 62061		Reliable detection and evaluation of input statuses up to SIL CL3
	As per EN 61508		Reliable detection and evaluation of input statuses up to SIL3
Performance Level	As per ISO 13849		Reliable detection and evaluation of input statuses up to Cat 4 and PL e
Failure rate per hour (PFH)	1.0x 10 <sup>-9</sup>		
Certificate issuing authority	01/205/5444.01/21		
LED displays	Group diagnostics	1	
	Channel diagnostics	8	
	Channel status	8	
	Failsafe protocol active	1	
Diagnostics	<ul style="list-style-type: none"> <li>• Short circuit per channel</li> <li>• Undervoltage</li> <li>• Overvoltage</li> <li>• Excessive temperature</li> <li>• Crossover per channel</li> <li>• Wire break per channel</li> <li>• Communication</li> <li>• Process data error</li> <li>• Self-test</li> </ul>		
Control elements	DIL switch		
Degree of protection to EN 60529	Depending on connection block		
Grid dimension	[mm]	50	
Dimensions (including interlinking block and connection block) W x L x H	[mm]	50 x 107 x 55	
Product weight	[g]	46	

## Data sheet – Input module, digital, PROFIsafe

Materials		
Note on materials		RoHS-compliant
Operating and environmental conditions		
Ambient temperature	[°C]	-5 ... +50
Storage temperature	[°C]	-20 ... +70
CE marking (see declaration of conformity)		To EU Machinery Directive
Certification		c UL us - Recognized (OL)

### Connection and display components

CPX-F8DE-P

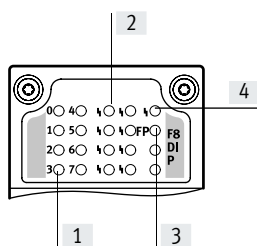

- [1] Channel-related status LEDs (green)
- [2] Channel-related error LEDs (red)
- [3] Fail-safe protocol active (green)
- [4] Error LED (red, module error)

### Combinations of bus nodes/control blocks with PROFIsafe input module

Bus node/control block	Part no.	PROFIsafe input module
		CPX-F8DE-P
CPX-FB13	195740	■
CPX-FB33	548755	■
CPX-M-FB34	548751	■
CPX-M-FB35	548749	■
CPX-FB43	8110369	■
CPX-M-FB44	8110370	■
CPX-M-FB35	8110371	■

#### Note

The PROFIsafe input module CPX-F8DE-P can only be integrated as of software release 21 or release 30 (in the case of CPX-FB13).



## Data sheet – Input module, digital, PROFIsafe

Combinations of connection blocks and PROFIsafe input module		
Connection blocks	Part no.	PROFIsafe input module
		CPX-F8DE-P
CPX-M-AB-4-M12X2-5POL	549367	■
CPX-M-AB-4-M12X2-5POL-T	2639560	■
CPX-AB-8-KL-4POL	195708	■
CPX-AB-ID-P	2639571	■

Pin allocation	
Connection block inputs	CPX-F8DE-P
<b>CPX-M-AB-4-M12X2-5POL</b>	
 <p>X 1      X 3 X 2      X 4</p>	<p>X1.1: 24 V<sub>SEN</sub> X1.2: Input x+1 X1.3: 0 V<sub>SEN</sub> X1.4: Input x X1.5: FE X2.1: 24 V<sub>SEN</sub> X2.2: Input x+3 X2.3: 0 V<sub>SEN</sub> X2.4: Input x+2 X2.5: FE</p> <p>X3.1: 24 V<sub>SEN</sub> X3.2: Input x+5 X3.3: 0 V<sub>SEN</sub> X3.4: Input x+4 X3.5: FE X4.1: 24 V<sub>SEN</sub> X4.2: Input x+7 X4.3: 0 V<sub>SEN</sub> X4.4: Input x+6 X4.5: FE</p>
<b>CPX-M-AB-4-M12X2-5POL-T</b>	
 <p>X1-T      X3-T X2-T      X4-T</p>	<p>X1-T.1: 24 V<sub>SEN x</sub> X1-T.2: Input x+1 X1-T.3: 0 V<sub>SEN</sub> X1-T.4: Input x X1-T.5: 24 V<sub>SEN x+1</sub> X2-T.1: 24 V<sub>SEN x+2</sub> X2-T.2: Input x+3 X2-T.3: 0 V<sub>SEN</sub> X2-T.4: Input x+2 X2-T.5: 24 V<sub>SEN x+3</sub></p> <p>X3-T.1: 24 V<sub>SEN x+4</sub> X3-T.2: Input x+5 X3-T.3: 0 V<sub>SEN</sub> X3-T.4: Input x+4 X3-T.5: 24 V<sub>SEN x+5</sub> X4-T.1: 24 V<sub>SEN x+6</sub> X4-T.2: Input x+7 X4-T.3: 0 V<sub>SEN</sub> X4-T.4: Input x+6 X4-T.5: 24 V<sub>SEN x+7</sub></p>
<b>CPX-AB-8-KL-4POL</b>	
 <p>X1      X5 X2      X6 X3      X7 X4      X8</p>	<p>X1.0: 24 V<sub>SEN</sub> X1.1: 0 V<sub>SEN</sub> X1.2: Input x X1.3: FE X2.0: 24 V<sub>SEN x</sub> X2.1: 24 V<sub>SEN x+1</sub> X2.2: Input x+1 X2.3: FE X3.0: 24 V<sub>SEN</sub> X3.1: 0 V<sub>SEN</sub> X3.2: Input x+2 X3.3: FE X4.0: 24 V<sub>SEN x+2</sub> X4.1: 24 V<sub>SEN x+3</sub> X4.2: Input x+3 X4.3: FE</p> <p>X5.0: 24 V<sub>SEN</sub> X5.1: 0 V<sub>SEN</sub> X5.2: Input x+4 X5.3: FE X6.0: 24 V<sub>SEN x+4</sub> X6.1: 24 V<sub>SEN x+5</sub> X6.2: Input x+5 X6.3: FE X7.0: 24 V<sub>SEN</sub> X7.1: 0 V<sub>SEN</sub> X7.2: Input x+6 X7.3: FE X8.0: 24 V<sub>SEN x+6</sub> X8.1: 24 V<sub>SEN x+7</sub> X8.2: Input x+7 X8.3: FE</p>

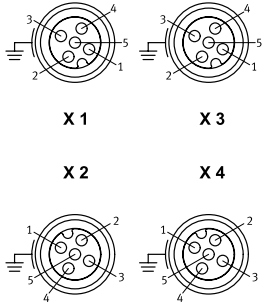
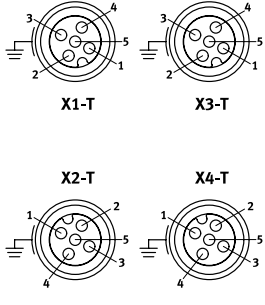
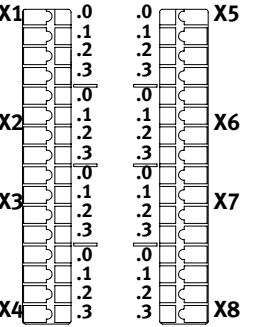
## Data sheet – Input module, digital, PROFIsafe



General technical data	
Type	CPX-AB-ID-P
Certificate issuing authority	01/205/5444.00/15
Degree of protection to EN 60529	IP65
Housing material	PA PC
Note on materials	RoHS-compliant
Corrosion resistance class CRC <sup>1)</sup>	1
Product weight [g]	57

1) Corrosion resistance class CRC 1 to Festo standard FN 940070

Low corrosion stress. Dry indoor application or transport and storage protection. Also applies to parts behind coverings, in the non-visible interior area, and parts which are covered in the application (e.g. drive trunnions).

Combinations of interlinking blocks and PROFIsafe input module		
Interlinking blocks	Part no.	PROFIsafe input module
		CPX-F8DE-P
CPX-GE-EV-S	<b>195746</b>	–
CPX-GE-EV-S-VL	<b>8022170</b>	–
CPX-GE-EV-S-7/8-4POL	<b>541248</b>	–
CPX-GE-EV-S-7/8-5POL	<b>541244</b>	–
CPX-GE-EV-S-7/8-5POL-VL	<b>8022172</b>	–
CPX-M-GE-EV-S-7/8-CIP-4P	<b>568956</b>	■
CPX-M-GE-EV-S-7/8-5POL	<b>550208</b>	■
CPX-M-GE-EV-S-7/8-5POL-VL	<b>8022165</b>	■
CPX-M-GE-EV-S-M12-5POL	<b>8098392</b>	■
CPX-M-GE-EV-S-PP-5POL	<b>563057</b>	■
CPX-GE-EV	<b>195742</b>	–
CPX-M-GE-EV	<b>550206</b>	■
CPX-M-GE-EV-FVO	<b>567806</b>	–
CPX-GE-EV-Z	<b>195744</b>	–
CPX-GE-EV-Z-VL	<b>8022166</b>	–
CPX-GE-EV-Z-7/8-4POL	<b>541250</b>	–
CPX-GE-EV-Z-7/8-5POL	<b>541246</b>	–
CPX-GE-EV-Z-7/8-5POL-VL	<b>8022173</b>	–
CPX-M-GE-EV-Z-7/8-5POL	<b>550210</b>	■
CPX-M-GE-EV-Z-7/8-5POL-VL	<b>8022158</b>	■
CPX-M-GE-EV-Z-PP-5POL	<b>563058</b>	■
CPX-GE-EV-V	<b>533577</b>	–
CPX-GE-EV-V-VL	<b>8022171</b>	–
CPX-GE-EV-V-7/8-4POL	<b>541252</b>	–
CPX-M-GE-EV-W-M12-5POL	<b>8098391</b>	■

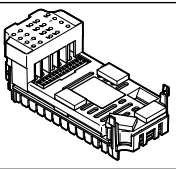
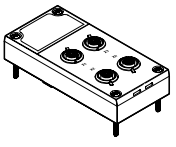
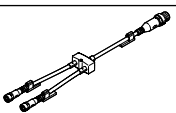
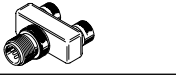
## Data sheet – Input module, digital, PROFI-safe

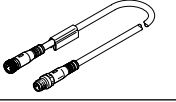
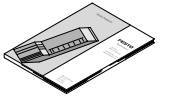
Ordering data		Description	Part no.	Type	
<b>PROFI-safe input module</b>					
	8 digital inputs, positive logic (PNP), for reliable detection and evaluation of input statuses		<b>2597424</b>	<b>CPX-F8DE-P</b>	
<b>Connection block</b>					
	Plastic	Spring-loaded terminal, 32-pin	<b>195708</b>	<b>CPX-AB-8-KL-4POL</b>	
		8-way DIL switch	<b>2639571</b>	<b>CPX-AB-ID-P</b>	
	Metal	4x socket M12, 5-pin	Unpulsed sensor supply	<b>549367</b>	<b>CPX-M-AB-4-M12X2-5POL</b>
			Pulsed sensor supply	<b>2639560</b>	<b>CPX-M-AB-4-M12X2-5POL-T</b>
<b>Distributor</b>					
	Modular system for all types of sensor/actuator distributor		–	<b>NEDY-...</b> → Internet: nedy	
	1x plug M12, 4-pin	2x socket M12, 5-pin	<b>8005310</b>	<b>NEDY-L2R1-V1-M12G5-N-M12G4</b>	
<b>Plug</b>					
	Plug	M12, PG7	<b>18666</b>	<b>SEA-GS-7</b>	
		M12, PG7, 4-pin for cable $\varnothing$ 2.5 mm	<b>192008</b>	<b>SEA-4GS-7-2.5</b>	
		M12, PG9	<b>18778</b>	<b>SEA-GS-9</b>	
		M12 for 2 cables	<b>18779</b>	<b>SEA-GS-11-DUO</b>	
		M12 for 2 cables, 5-pin	<b>192010</b>	<b>SEA-5GS-11-DUO</b>	
		M12, 5-pin	<b>175487</b>	<b>SEA-M12-5GS-PG7</b>	
<b>Connecting cable</b>					
	Modular system for a choice of connecting cables		–	<b>NEBU-...</b> → Internet: nebu	
<b>User documentation</b>					
	User documentation for PROFI-safe input module	German	<b>8035496</b>	<b>CPX-F8DE-P-DE</b>	
		English	<b>8035497</b>	<b>CPX-F8DE-P-EN</b>	
		Spanish	<b>8035498</b>	<b>CPX-F8DE-P-ES</b>	
		French	<b>8035499</b>	<b>CPX-F8DE-P-FR</b>	
		Italian	<b>8035500</b>	<b>CPX-F8DE-P-IT</b>	
		Chinese	<b>8035501</b>	<b>CPX-F8DE-P-ZH</b>	

## Data sheet – Input module, digital, 16 inputs

**Function**

Digital input modules enable the connection of two-wire and three-wire sensors (proximity switches, inductive or capacitive sensors, etc.).

Depending on the connection block selected, the module supports various connection concepts with different numbers of sockets (single or double allocation).

**Area of application**

- Input modules for 24 V DC sensor supply voltage
- PNP logic
- Module features can be parameterised
- The input module receives the supply voltage for the electronics and the sensors from the interlinking block
- Module protection and diagnostics through integrated electronic protection

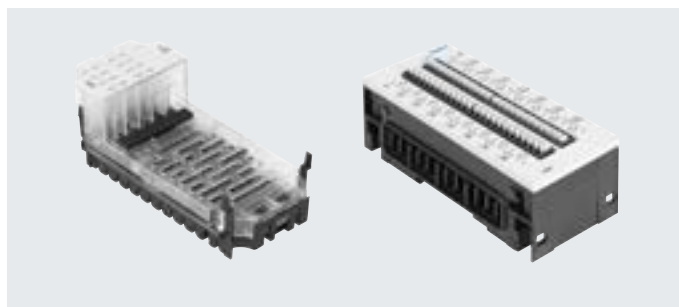

General technical data		CPX-16DE	CPX-M-16DE-D	CPX-L-16DE
Type				
Number of inputs		16	16	16
Max. residual current of inputs per module	[A]	1.8	1.8	1.8
Intrinsic current consumption at operating voltage	[mA]	Typically 15	Typically 34	Typically 15
Fuse protection		Internal electronic fuse per module	Internal electronic fuse per channel pair, additional safety fuse	Internal electronic fuse per module
Nominal operating voltage	[V DC]	24	24	24
Operating voltage range	[V DC]	18 ... 30	18 ... 30	18 ... 30
Galvanic isolation	Channel – channel	No	No	No
	Channel – internal bus	No	No	No
Switching level	Signal 0	[V DC] ≤ 5	≤ 5	≤ 5
	Signal 1	[V DC] ≥ 11	≥ 11	≥ 15
Input debounce time	[ms]	3 (0.1 ms, 10 ms, 20 ms parameterisable)		
Input characteristic		IEC 1131-T2	IEC 1131-T2	IEC 1131-T2, type 01
Switching logic		Positive logic (PNP)	Positive logic (PNP)	Positive logic (PNP)
LED displays	Group diagnostics	1	1	1
	Channel diagnostics	–	16	–
	Channel status	16	16	16
Diagnostics		Short circuit/overload per channel		
Parameterisation		<ul style="list-style-type: none"> <li>• Module monitoring</li> <li>• Behaviour after short circuit</li> <li>• Input debounce time</li> <li>• Signal extension time</li> </ul>		
Degree of protection to EN 60529		Depending on connection block	Depending on connection block	IP20
Temperature range	Operation	[°C] –5 ... +50	–5 ... +50	–5 ... +50
	Storage/transport	[°C] –20 ... +70	–20 ... +70	–20 ... +70
Materials		Reinforced PA, PC	Reinforced PA, PC	PA-reinforced
Note on materials		–	–	RoHS-compliant
Grid dimension	[mm]	50	50	50
Dimensions (including interlinking block and connection block) W x L x H	[mm]	50 x 107 x 50	50 x 107 x 50	50 x 107 x 41
Product weight	[g]	41	46	167

## Data sheet – Input module, digital, 16 inputs

## Connection and display components

## CPX-16DE

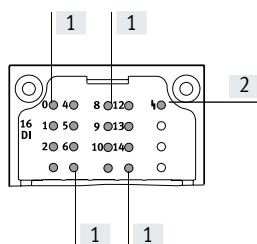

- [1] Status LEDs (green): for allocation to the inputs → pin allocation of the module
- [2] Error LED (red, module error)

## CPX-M-16DE-D

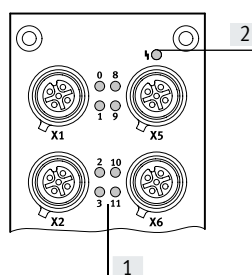

- [1] Common status LEDs (green)/error LEDs (red) for each input signal
- [2] Error LED (red, module error)

## CPX-L-16DE

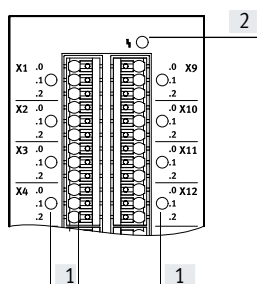

- [1] Status LEDs (green) for each input signal
- [2] Error LED (red, module error)

## Combinations of connection blocks and digital input modules

Connection blocks	Part no.	Digital input modules		
		CPX-16DE	CPX-M-16DE-D	CPX-L-16DE
CPX-AB-8-M8X2-4POL	541256	■	–	–
CPX-AB-8-M12X2-5POL	3606900	–	■	–
CPX-AB-8-KL-4POL	195708	■	–	–
CPX-AB-1-SUB-BU-25POL	525676	■	–	–
CPX-M-AB-8-M12X2-5POL	549335	–	■	–

Data sheet – Input module, digital, 16 inputs

Pin allocation		CPX-16DE
Connection block inputs		
<b>CPX-AB-8-M8x2-4POL</b>		
	<p>X1.1: 24 V<sub>SEN</sub>                      X1.2: Input x+1                      X1.3: 0 V<sub>SEN</sub>                      X1.4: Input x                      X2.1: 24 V<sub>SEN</sub>                      X2.2: Input x+3                      X2.3: 0 V<sub>SEN</sub>                      X2.4: Input x+2                      X3.1: 24 V<sub>SEN</sub>                      X3.2: Input x+5                      X3.3: 0 V<sub>SEN</sub>                      X3.4: Input x+4                      X4.1: 24 V<sub>SEN</sub>                      X4.2: Input x+7                      X4.3: 0 V<sub>SEN</sub>                      X4.4: Input x+6</p>	<p>X5.1: 24 V<sub>SEN</sub>                      X5.2: Input x+9                      X5.3: 0 V<sub>SEN</sub>                      X5.4: Input x+8                      X6.1: 24 V<sub>SEN</sub>                      X6.2: Input x+11                      X6.3: 0 V<sub>SEN</sub>                      X6.4: Input x+10                      X7.1: 24 V<sub>SEN</sub>                      X7.2: Input x+13                      X7.3: 0 V<sub>SEN</sub>                      X7.4: Input x+12                      X8.1: 24 V<sub>SEN</sub>                      X8.1: Input x+15                      X8.3: 0 V<sub>SEN</sub>                      X8.4: Input x+14</p>
<b>CPX-AB-8-KL-4POL</b>		
	<p>X1.0: Input x+8                      X1.1: 24 V<sub>SEN</sub>                      X1.2: Input x                      X1.3: FE                      X2.0: Input x+9                      X2.1: 24 V<sub>SEN</sub>                      X2.2: Input x+1                      X2.3: FE                      X3.0: Input x+10                      X3.1: 24 V<sub>SEN</sub>                      X3.2: Input x+2                      X3.3: FE                      X4.0: Input x+11                      X4.1: 24 V<sub>SEN</sub>                      X4.2: Input x+3                      X4.3: FE</p>	<p>X5.0: Input x+12                      X5.1: 0 V<sub>SEN</sub>                      X5.2: Input x+4                      X5.3: FE                      X6.0: Input x+13                      X6.1: 0 V<sub>SEN</sub>                      X6.2: Input x+5                      X6.3: FE                      X7.0: Input x+14                      X7.1: 0 V<sub>SEN</sub>                      X7.2: Input x+6                      X7.3: FE                      X8.0: Input x+15                      X8.1: 0 V<sub>SEN</sub>                      X8.2: Input x+7                      X8.3: FE</p>
<b>CPX-AB-1-SUB-BU-25POL</b>		
	<p>1: Input x                      2: Input x+1                      3: Input x+2                      4: Input x+3                      5: Input x+9                      6: 24 V<sub>SEN</sub>                      7: Input x+11                      8: 24 V<sub>SEN</sub>                      9: Input x+8                      10: Input x+10                      11: 24 V<sub>SEN</sub>                      12: 24 V<sub>SEN</sub>                      13: FE</p>	<p>14: Input x+4                      15: Input x+5                      16: Input x+6                      17: Input x+7                      18: Input x+12                      19: Input x+13                      20: Input x+14                      21: Input x+15                      22: 0 V<sub>SEN</sub>                      23: 0 V<sub>SEN</sub>                      24: 0 V<sub>SEN</sub>                      25: FE                      Housing: FE</p>

## Data sheet – Input module, digital, 16 inputs

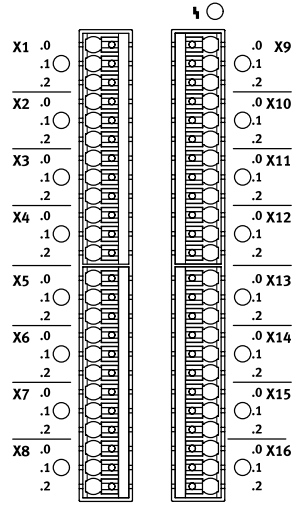

Pin allocation		CPX-M-16DE-D
Connection block inputs		
CPX-M-AB-8-M12X2-5POL and CPX-AB-8-M12X2-5POL		
		X1.1: 24 V <sub>Sx</sub> X1.2: Input x+1 X1.3: 0 V <sub>Sx</sub> X1.4: Input x X1.5: FE
		X2.1: 24 V <sub>Sx+2</sub> X2.2: Input x+3 X2.3: 0 V <sub>Sx+2</sub> X2.4: Input x+2 X2.5: FE
		X3.1: 24 V <sub>Sx+4</sub> X3.2: Input x+5 X3.3: 0 V <sub>Sx+4</sub> X3.4: Input x+4 X3.5: FE
		X4.1: 24 V <sub>Sx+6</sub> X4.2: Input x+7 X4.3: 0 V <sub>Sx+6</sub> X4.4: Input x+6 X4.5: FE
		X5.1: 24 V <sub>Sx+8</sub> X5.2: Input x+9 X5.3: 0 V <sub>Sx+8</sub> X5.4: Input x+8 X5.5: FE
		X6.1: 24 V <sub>Sx+10</sub> X6.2: Input x+11 X6.3: 0 V <sub>Sx+10</sub> X6.4: Input x+10 X6.5: FE
		X7.1: 24 V <sub>Sx+12</sub> X7.2: Input x+13 X7.3: 0 V <sub>Sx+12</sub> X7.4: Input x+12 X7.5: FE
		X8.1: 24 V <sub>Sx+14</sub> X8.2: Input x+15 X8.3: 0 V <sub>Sx+14</sub> X8.4: Input x+14 X8.5: FE

Data sheet – Input module, digital, 16 inputs

Pin allocation		CPX-L-16DE		
Connection block inputs				
	X1	.0	X9	
		.1	.0	
		.2	.1	
	X2	.0	.2	X10
		.1	.0	
		.2	.1	
	X3	.0	.2	X11
		.1	.0	
		.2	.1	
	X4	.0	.2	X12
		.1	.0	
		.2	.1	
	X5	.0	.2	X13
		.1	.0	
		.2	.1	
	X6	.0	.2	X14
		.1	.0	
		.2	.1	
	X7	.0	.2	X15
		.1	.0	
		.2	.1	
	X8	.0	.2	X16
		.1	.0	
		.2	.1	
			.2	
			.0	X1.0: 24 V <sub>SEN</sub>
			.1	X1.1: Input x
			.2	X1.2: 0 V <sub>SEN</sub>
			.0	X2.0: 24 V <sub>SEN</sub>
			.1	X2.1: Input x+1
			.2	X2.2: 0 V <sub>SEN</sub>
			.0	X3.0: 24 V <sub>SEN</sub>
			.1	X3.1: Input x+2
			.2	X3.2: 0 V <sub>SEN</sub>
			.0	X4.0: 24 V <sub>SEN</sub>
			.1	X4.1: Input x+3
			.2	X4.2: 0 V <sub>SEN</sub>
			.0	X5.0: 24 V <sub>SEN</sub>
			.1	X5.1: Input x+4
			.2	X5.2: 0 V <sub>SEN</sub>
			.0	X6.0: 24 V <sub>SEN</sub>
			.1	X6.1: Input x+5
			.2	X6.2: 0 V <sub>SEN</sub>
			.0	X7.0: 24 V <sub>SEN</sub>
			.1	X7.1: Input x+6
			.2	X7.2: 0 V <sub>SEN</sub>
			.0	X8.0: 24 V <sub>SEN</sub>
			.1	X8.1: Input x+7
		.2	X8.2: 0 V <sub>SEN</sub>	
		.0	X9.0: 24 V <sub>SEN</sub>	
		.1	X9.1: Input x+8	
		.2	X9.2: 0 V <sub>SEN</sub>	
		.0	X10.0: 24 V <sub>SEN</sub>	
		.1	X10.1: Input x+9	
		.2	X10.2: 0 V <sub>SEN</sub>	
		.0	X11.0: 24 V <sub>SEN</sub>	
		.1	X11.1: Input x+10	
		.2	X11.2: 0 V <sub>SEN</sub>	
		.0	X12.0: 24 V <sub>SEN</sub>	
		.1	X12.1: Input x+11	
		.2	X12.2: 0 V <sub>SEN</sub>	
		.0	X13.0: 24 V <sub>SEN</sub>	
		.1	X13.1: Input x+12	
		.2	X13.2: 0 V <sub>SEN</sub>	
		.0	X14.0: 24 V <sub>SEN</sub>	
		.1	X14.1: Input x+13	
		.2	X14.2: 0 V <sub>SEN</sub>	
		.0	X15.0: 24 V <sub>SEN</sub>	
		.1	X15.1: Input x+14	
		.2	X15.2: 0 V <sub>SEN</sub>	
		.0	X16.0: 24 V <sub>SEN</sub>	
		.1	X16.1: Input x+15	
		.2	X16.2: 0 V <sub>SEN</sub>	

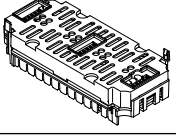
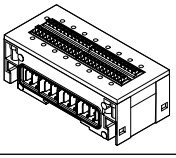
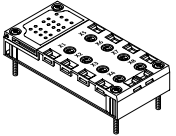
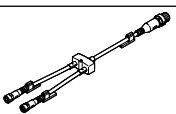

## Data sheet – Input module, digital, 16 inputs

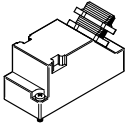
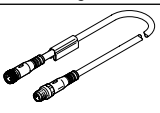
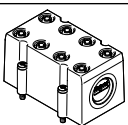
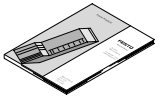
Ordering data		Part no.	Type	
Designation				
Input module, digital				
	16 digital inputs, internal electronic fuse per module	543815	CPX-16DE	
	16 digital inputs, internal electronic fuse per channel pair, for CPX in metal	550202	CPX-M-16DE-D	
	16 digital inputs, internal electronic fuse per module, for CPX in plastic, including interlinking block and connection block with spring-loaded terminals	572606	CPX-L-16DE-16-KL-3POL	
Connection block				
	Plastic	8x socket M8, 4-pin	541256	CPX-AB-8-M8X2-4POL
		8x socket M12, 5-pin	3606900	CPX-AB-8-M12X2-5POL
		Spring-loaded terminal, 32-pin	195708	CPX-AB-8-KL-4POL
		1x socket, Sub-D, 25-pin	525676	CPX-AB-1-SUB-BU-25POL
	Metal	8x socket M12, 5-pin	549335	CPX-M-AB-8-M12X2-5POL
Distributor				
	Modular system for all types of sensor/actuator distributor		–	NEDY-... → Internet: nedy
	1x plug M8, 4-pin	2x socket M8, 3-pin	8005312	NEDY-L2R1-V1-M8G3-N-M8G4
Plug				
	Plug M8, 3-pin	Solderable	18696	SEA-GS-M8
		Screw-in	192009	SEA-3GS-M8-S
	Sub-D plug, 25-pin		527522	SD-SUB-D-ST25
Connecting cable				
	Connecting cable M8-M8	0.5 m	541346	NEBU-M8G3-K-0.5-M8G3
		1.0 m	541347	NEBU-M8G3-K-1-M8G3
		2.5 m	541348	NEBU-M8G3-K-2.5-M8G3
		5.0 m	541349	NEBU-M8G3-K-5-M8G3
	Modular system for a choice of connecting cables		–	NEBU-... → Internet: nebu
Cover				
	Cover for CPX-AB-8-KL-4POL (IP65, IP67) • 8 cable through feeds M9 • 1 cable through feed for multi-pin plug		538219	AK-8KL
	Fittings kit		538220	VG-K-M9
User documentation				
	User documentation	German	526439	P.BE-CPX-EA-DE
		English	526440	P.BE-CPX-EA-EN
		Spanish	526441	P.BE-CPX-EA-ES
		French	526442	P.BE-CPX-EA-FR
		Italian	526443	P.BE-CPX-EA-IT

## Data sheet – Output module, digital

**Function**

Digital outputs control actuators such as individual valves, hydraulic valves, heating controllers and many more. Separate circuits are created using an additional supply. Parallel connection of the outputs of a module enables consuming devices to be controlled with up to 4 A.

**Area of application**

- Output module for 24 V DC supply voltage
- PNP logic
- Module features can be parameterised
- The output module receives the voltage supply for the electronics and the outputs from the interlinking block
- Module protection and diagnostics through integrated electronic protection in each channel

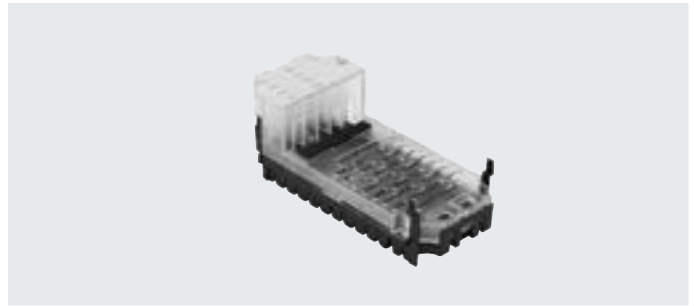

General technical data		CPX-4DA	CPX-8DA	CPX-8DA-H
Type				
Number of outputs		4	8	8
Max. power supply	Per module [A]	4		8.4
	Per channel [A]	1 (24 W lamp load, 4 channels can be connected in parallel)	0.5 (12 W lamp load, 8 channels can be connected in parallel)	2.1 (50 W lamp load), per channel pair
Fuse protection (short circuit)		Internal electronic fuse per channel		
Module current consumption (power supply for electronics)	[mA]	Typically 16		Typically 34
Operating voltage	Nominal value [V DC]	24		
	Permissible range [V DC]	18 ... 30		
Galvanic isolation	Channel – channel	No		
	Channel – internal bus	Yes, with intermediate supply		
Output characteristic		Based on IEC 1131-2		
Switching logic		Positive logic (PNP)		
LED displays	Group diagnostics	1	1	1
	Channel diagnostics	4	8	8
	Channel status	4	8	8
Diagnostics		<ul style="list-style-type: none"> <li>• Short circuit/overload, channel x</li> <li>• Undervoltage of outputs</li> </ul>		
Parameterisation		<ul style="list-style-type: none"> <li>• Module monitoring</li> <li>• Behaviour after short circuit</li> <li>• Fail-safe channel x</li> <li>• Forcing channel x</li> <li>• Idle mode channel x</li> </ul>		
Degree of protection to EN 60529		Depending on connection block		
Temperature range	Operation [°C]	–5 ... +50		
	Storage/transport [°C]	–20 ... +70		
Materials		Reinforced PA, PC		
Grid dimension	[mm]	50		
Dimensions (including interlinking block and connection block) W x L x H	[mm]	50 x 107 x 50		
Product weight	[g]	42	49	48

## Data sheet – Output module, digital

## Connection and display components

CPX-4DA

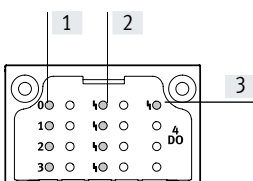

CPX-8DA

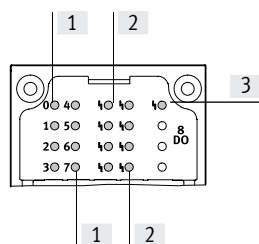

- [1] Status LEDs (yellow): for allocation to outputs → pin allocation of the module  
 [2] Channel-related error LEDs (red)  
 [3] Error LED (red, module error)

## Combinations of connection block and digital output module

Connection blocks	Part no.	Digital output module		
		CPX-4DA	CPX-8DA	CPX-8DA-H
CPX-AB-8-M8-3POL	195706	■	■	–
CPX-AB-8-M8X2-4POL	541256	■	■	■
CPX-AB-4-M12X2-5POL	195704	■	■	–
CPX-AB-4-M12X2-5POL-R	541254	■	■	■
CPX-AB-8-KL-4POL	195708	■	■	■
CPX-AB-1-SUB-BU-25POL	525676	■	■	■
CPX-AB-4-HAR-4POL	525636	■	■	–
CPX-M-AB-4-M12X2-5POL	549367	■	■	■

## Pin allocation

Connection block outputs	CPX-4DA	CPX-8DA
<b>CPX-AB-8-M8-3POL</b>		
	X1.1: n.c. X1.3: 0 V <sub>OUT</sub> X1.4: Output x X2.1: n.c. X2.3: 0 V <sub>OUT</sub> X2.4: Output x+1 X3.1: n.c. X3.3: 0 V <sub>OUT</sub> X3.4: Output x+1 X4.1: n.c. X4.3: 0 V <sub>OUT</sub> X4.4: n.c.	X5.1: n.c. X5.3: 0 V <sub>OUT</sub> X5.4: Output x+2 X6.1: n.c. X6.3: 0 V <sub>OUT</sub> X6.4: Output x+3 X7.1: n.c. X7.3: 0 V <sub>OUT</sub> X7.4: Output x+3 X8.1: n.c. X8.3: 0 V <sub>OUT</sub> X8.4: n.c.
		X1.1: n.c. X1.3: 0 V <sub>OUT</sub> X1.4: Output x X2.1: n.c. X2.3: 0 V <sub>OUT</sub> X2.4: Output x+1 X3.1: n.c. X3.3: 0 V <sub>OUT</sub> X3.4: Output x+2 X4.1: n.c. X4.3: 0 V <sub>OUT</sub> X4.4: Output x+3
		X5.1: n.c. X5.3: 0 V <sub>OUT</sub> X5.4: Output x+4 X6.1: n.c. X6.3: 0 V <sub>OUT</sub> X6.4: Output x+5 X7.1: n.c. X7.3: 0 V <sub>OUT</sub> X7.4: Output x+6 X8.1: n.c. X8.3: 0 V <sub>OUT</sub> X8.4: Output x+7

Data sheet – Output module, digital

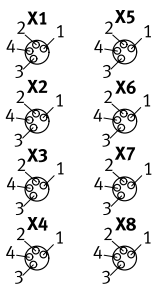
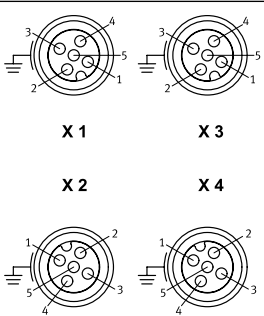
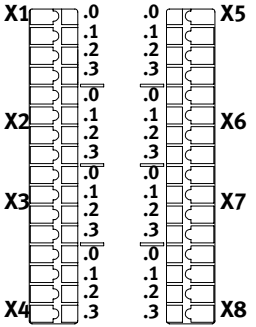
Pin allocation		CPX-4DA		CPX-8DA and CPX-8DA-H	
Connection block outputs		CPX-4DA		CPX-8DA and CPX-8DA-H	
<b>CPX-AB-8-M8X2-4POL</b>					
		X1.1: 0 V <sub>OUT</sub> X1.2: Output x+1 X1.3: 0 V <sub>OUT</sub> X1.4: Output x X2.1: 0 V <sub>OUT</sub> X2.2: n.c. X2.3: 0 V <sub>OUT</sub> X2.4: Output x+1 X3.1: 0 V <sub>OUT</sub> X3.2: Output x+3 X3.3: 0 V <sub>OUT</sub> X3.4: Output x+2 X4.1: 0 V <sub>OUT</sub> X4.2: n.c. X4.3: 0 V <sub>OUT</sub> X4.4: Output x+3	X5.1: 0 V <sub>OUT</sub> X5.2: n.c. X5.3: 0 V <sub>OUT</sub> X5.4: n.c. X6.1: 0 V <sub>OUT</sub> X6.2: n.c. X6.3: 0 V <sub>OUT</sub> X6.4: n.c. X7.1: 0 V <sub>OUT</sub> X7.2: n.c. X7.3: 0 V <sub>OUT</sub> X7.4: n.c. X8.1: 0 V <sub>OUT</sub> x+1 X8.2: n.c. X8.3: 0 V <sub>OUT</sub> x+3 X8.4: n.c.	X1.1: 0 V <sub>OUT</sub> X1.2: Output x+1 X1.3: 0 V <sub>OUT</sub> X1.4: Output x X2.1: 0 V <sub>OUT</sub> X2.2: Output x+3 X2.3: 0 V <sub>OUT</sub> X2.4: Output x+2 X3.1: 0 V <sub>OUT</sub> X3.2: Output x+5 X3.3: 0 V <sub>OUT</sub> X3.4: Output x+4 X4.1: 0 V <sub>OUT</sub> X4.2: Output x+7 X4.3: 0 V <sub>OUT</sub> X4.4: Output x+6	X5.1: 0 V <sub>OUT</sub> X5.2: n.c. X5.3: 0 V <sub>OUT</sub> X5.4: n.c. X6.1: 0 V <sub>OUT</sub> X6.2: n.c. X6.3: 0 V <sub>OUT</sub> X6.4: n.c. X7.1: 0 V <sub>OUT</sub> X7.2: n.c. X7.3: 0 V <sub>OUT</sub> X7.4: n.c. X8.1: 0 V <sub>OUT</sub> X8.2: n.c. X8.3: 0 V <sub>OUT</sub> X8.4: n.c.
<b>CPX-AB-4-M12X2-5POL<sup>1)</sup> and CPX-AB-4-M12X2-5POL-R<sup>2)</sup></b>					
		X1.1: n.c. X1.2: Output x+1 X1.3: 0 V <sub>OUT</sub> X1.4: Output x X1.5: FE X2.1: n.c. X2.2: n.c. X2.3: 0 V <sub>OUT</sub> X2.4: Output x+1 X2.5: FE	X3.1: n.c. X3.2: Output x+3 X3.3: 0 V <sub>OUT</sub> X3.4: Output x+2 X3.5: FE X4.1: n.c. X4.2: n.c. X4.3: 0 V <sub>OUT</sub> X4.4: Output x+3 X4.5: FE	X1.1: n.c. X1.2: Output x+1 X1.3: 0 V <sub>OUT</sub> X1.4: Output x X1.5: FE X2.1: n.c. X2.2: Output x+3 X2.3: 0 V <sub>OUT</sub> X2.4: Output x+2 X2.5: FE	X3.1: n.c. X3.2: Output x+5 X3.3: 0 V <sub>OUT</sub> X3.4: Output x+4 X3.5: FE X4.1: n.c. X4.2: Output x+7 X4.3: 0 V <sub>OUT</sub> X4.4: Output x+6 X4.5: FE
<b>CPX-AB-8-KL-4POL</b>					
		X1.0: n.c. X1.1: 0 V <sub>OUT</sub> X1.2: Output x X1.3: FE X2.0: n.c. X2.1: 0 V <sub>OUT</sub> X2.2: Output x+1 X2.3: FE X3.0: n.c. X3.1: 0 V <sub>OUT</sub> X3.2: Output x+1 X3.3: FE X4.0: n.c. X4.1: 0 V <sub>OUT</sub> X4.2: n.c. X4.3: FE	X5.0: n.c. X5.1: 0 V <sub>OUT</sub> X5.2: Output x+2 X5.3: FE X6.0: n.c. X6.1: 0 V <sub>OUT</sub> X6.2: Output x+3 X6.3: FE X7.0: n.c. X7.1: 0 V <sub>OUT</sub> X7.2: Output x+3 X7.3: FE X8.0: n.c. X8.1: 0 V <sub>OUT</sub> X8.2: n.c. X8.3: FE	X1.0: n.c. X1.1: 0 V <sub>OUT</sub> X1.2: Output x X1.3: FE X2.0: n.c. X2.1: 0 V <sub>OUT</sub> X2.2: Output x+1 X2.3: FE X3.0: n.c. X3.1: 0 V <sub>OUT</sub> X3.2: Output x+2 X3.3: FE X4.0: n.c. X4.1: 0 V <sub>OUT</sub> X4.2: Output x+3 X4.3: FE	X5.0: n.c. X5.1: 0 V <sub>OUT</sub> X5.2: Output x+4 X5.3: FE X6.0: n.c. X6.1: 0 V <sub>OUT</sub> X6.2: Output x+5 X6.3: FE X7.0: n.c. X7.1: 0 V <sub>OUT</sub> X7.2: Output x+6 X7.3: FE X8.0: n.c. X8.1: 0 V <sub>OUT</sub> X8.2: Output x+7 X8.3: FE

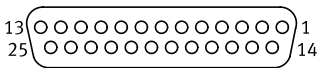
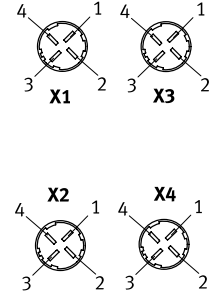

1) Not suitable for CPX-8DA-H.  
 2) Speedcon quick lock, additional shielding on metal thread

## Data sheet – Output module, digital

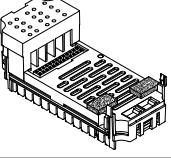
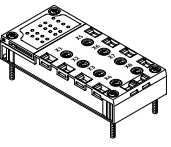
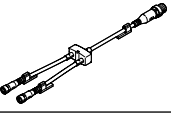

Pin allocation		CPX-4DA		CPX-8DA and CPX-8DA-H	
Connection block outputs		CPX-4DA		CPX-8DA and CPX-8DA-H	
<b>CPX-AB-1-SUB-BU-25POL</b>					
		1: Output x 2: Output x+1 3: Output x+1 4: n.c. 5: n.c. 6: 0 V <sub>OUT</sub> 7: n.c. 8: 0 V <sub>OUT</sub> 9: n.c. 10: n.c. 11: 0 V <sub>OUT</sub> 12: 0 V <sub>OUT</sub> 13: FE	14: Output x+2 15: Output x+3 16: Output x+3 17: n.c. 18: n.c. 19: n.c. 20: n.c. 21: n.c. 22: 0 V <sub>OUT</sub> 23: 0 V <sub>OUT</sub> 24: 0 V <sub>OUT</sub> 25: FE Housing: FE	1: Output x 2: Output x+1 3: Output x+2 4: Output x+3 5: n.c. 6: 0 V <sub>OUT</sub> 7: n.c. 8: 0 V <sub>OUT</sub> 9: n.c. 10: n.c. 11: 0 V <sub>OUT</sub> 12: 0 V <sub>OUT</sub> 13: FE	14: Output x+4 15: Output x+5 16: Output x+6 17: Output x+7 18: n.c. 19: n.c. 20: n.c. 21: n.c. 22: 0 V <sub>OUT</sub> 23: 0 V <sub>OUT</sub> 24: 0 V <sub>OUT</sub> 25: FE Housing: FE
<b>CPX-AB-4-HAR-4POL<sup>1)</sup></b>					
		X1.1: n.c. X1.2: Output x+1 X1.3: 0 V <sub>OUT</sub> X1.4: Output x X2.1: n.c. X2.2: n.c. X2.3: 0 V <sub>OUT</sub> X2.4: Output x+1	X3.1: n.c. X3.2: Output x+3 X3.3: 0 V <sub>OUT</sub> X3.4: Output x+2 X4.1: n.c. X4.2: n.c. X4.3: 0 V <sub>OUT</sub> X4.4: Output x+3	X1.1: n.c. X1.2: Output x+1 X1.3: 0 V <sub>OUT</sub> X1.4: Output x X2.1: n.c. X2.2: Output x+3 X2.3: 0 V <sub>OUT</sub> X2.4: Output x+2	X3.1: n.c. X3.2: Output x+5 X3.3: 0 V <sub>OUT</sub> X3.4: Output x+4 X4.1: n.c. X4.2: Output x+7 X4.3: 0 V <sub>OUT</sub> X4.4: Output x+6

1) Not suitable for CPX-8DA-H.

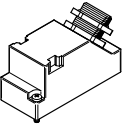
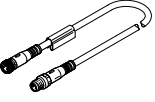
## Data sheet – Output module, digital

Ordering data		Part no.	Type
Designation			
Output module, digital			
	4 digital outputs, power supply 1 A per channel		195754 CPX-4DA
	8 digital outputs, power supply 0.5 A per channel		541482 CPX-8DA
	8 digital outputs, power supply 2.1 A per channel pair		550204 CPX-8DA-H
Connection block			
	Plastic	8x socket M8, 3-pin	195706 CPX-AB-8-M8-3POL
		8x socket M8, 4-pin	541256 CPX-AB-8-M8X2-4POL
		4x socket M12, 5-pin	195704 CPX-AB-4-M12X2-5POL
		4x socket, M12 with quick-lock technology, 5-pin	541254 CPX-AB-4-M12X2-5POL-R
		Spring-loaded terminal, 32-pin	195708 CPX-AB-8-KL-4POL
		1x socket, Sub-D, 25-pin	525676 CPX-AB-1-SUB-BU-25POL
	Metal	4x socket, quick connector, 4-pin	525636 CPX-AB-4-HAR-4POL
		4x socket M12, 5-pin	549367 CPX-M-AB-4-M12X2-5POL
Distributor			
	Modular system for all types of sensor/actuator distributor		– NEDY-... → Internet: nedy
	1x plug M8, 4-pin	2x socket M8, 3-pin	8005312 NEDY-L2R1-V1-M8G3-N-M8G4
	1x plug M12, 4-pin	2x socket M8, 3-pin	8005311 NEDY-L2R1-V1-M8G3-N-M12G4
		2x socket M12, 5-pin	8005310 NEDY-L2R1-V1-M12G5-N-M12G4
Plug			
	Plug	M8 3-pin	Solderable 18696 SEA-GS-M8
			Screw-in 192009 SEA-3GS-M8-S
		M12, PG7	18666 SEA-GS-7
		M12, PG7, 4-pin for cable ø 2.5 mm	192008 SEA-4GS-7-2.5
		M12, PG9	18778 SEA-GS-9
		M12 for 2 cables	18779 SEA-GS-11-DUO
		M12 for 2 cables, 5-pin	192010 SEA-5GS-11-DUO
	M12, 5-pin	175487 SEA-M12-5GS-PG7	
	Sub-D plug, 25-pin		527522 SD-SUB-D-ST25
Connecting cable			
	Connecting cable M8-M8	0.5 m	541346 NEBU-M8G3-K-0.5-M8G3
		1.0 m	541347 NEBU-M8G3-K-1-M8G3
		2.5 m	541348 NEBU-M8G3-K-2.5-M8G3
		5.0 m	541349 NEBU-M8G3-K-5-M8G3
	Modular system for a choice of connecting cables		–

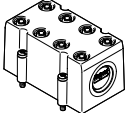
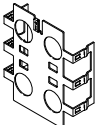
## Data sheet – Output module, digital

Ordering data		Part no.	Type	
Designation				
Cover				
	Cover for CPX-AB-8-KL-4POL (IP65, IP67) • 8 cable through feeds M9 • 1 cable through feed for multi-pin plug	538219	AK-8KL	
	Fittings kit	538220	VG-K-M9	
Screening plate				
	Screening plate for M12 connections	526184	CPX-AB-S-4-M12	
User documentation				
	User documentation	German	526439	P.BE-CPX-EA-DE
		English	526440	P.BE-CPX-EA-EN
		Spanish	526441	P.BE-CPX-EA-ES
		French	526442	P.BE-CPX-EA-FR
		Italian	526443	P.BE-CPX-EA-IT

## Data sheet – Input/output module, digital

## Area of application

- Digital multi I/O module for 24 V DC supply voltage
- Supports connection blocks with Sub-D, terminal connection and M12 connection (8-pin)
- As CPX-L with connection via spring-loaded terminals
- Module features can be parameterised
- The inputs receive the voltage supply for the electronics and the sensors from the interlinking block
- The outputs receive the voltage supply for the electronics and the outputs from the interlinking block
- Module protection and diagnostics through integrated electronic fuse protection for the sensor power supply and integrated electronic fuse protection in each output channel

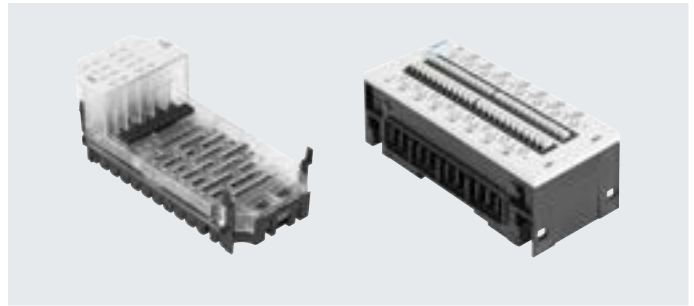

General technical data			CPX-8DE-8DA	CPX-L-8DE-8DA
Type				
Number	Inputs		8	8
	Outputs		8	8
Max. power supply Per module	Sensor supply	[A]	0.7	1.8
	Outputs	[A]	4	2
Max. power supply per channel		[A]	0.5 (12 W lamp load, channels A0 ... A03 can be connected in parallel to A4 ... A7)	0.25 (6 W lamp load)
Fuse protection (short circuit)			Internal electronic fuse per channel	
Intrinsic current consumption at nominal operating voltage		[mA]	Typically 22	Typically 15
Operating voltage	Nominal value	[V DC]	24	24
	Permissible range	[V DC]	18 ... 30	18 ... 30
Galvanic isolation, inputs	Channel – channel		No	No
	Channel – internal bus		No	No
Galvanic isolation, outputs	Channel – channel		No	No
	Channel – internal bus		Yes, with intermediate supply	No
Characteristic curve	Inputs		IEC 1131-T2	IEC 1131-T2, type 01
	Outputs		IEC 1131-T2	IEC 1131-T2
Switching level, inputs	Signal 0	[V DC]	≤ 5	≤ 5
	Signal 1	[V DC]	≥ 11	≥ 15
Input debounce time		[ms]	3 (0.1 ms, 10 ms, 20 ms parameterisable)	
Switching logic			Positive logic (PNP)	Positive logic (PNP)
LED displays	Group diagnostics		1	1
	Channel diagnostics		–	–
	Channel status		16	16
Diagnostics			<ul style="list-style-type: none"> <li>• Short circuit/overload per channel</li> <li>• Undervoltage of outputs</li> </ul>	
Parameterisation			<ul style="list-style-type: none"> <li>• Input debounce time</li> <li>• Failsafe per channel</li> <li>• Forcing per channel</li> <li>• Idle mode per channel</li> <li>• Signal extension time</li> <li>• Module monitoring</li> <li>• Behaviour after short circuit</li> </ul>	
Degree of protection to EN 60529			Depending on connection block	IP20
Temperature range	Operation	[°C]	–5 ... +50	–5 ... +50
	Storage/transport	[°C]	–20 ... +70	–20 ... +70
Materials			Reinforced PA, PC	PA-reinforced
Note on materials			–	RoHS-compliant
Grid dimension		[mm]	50	50
Dimensions (including interlinking block and connection block) W x L x H		[mm]	50 x 107 x 50	50 x 107 x 41
Product weight		[g]	48	171



## Data sheet – Input/output module, digital

### Connection and display components

CPX-8DE-8DA

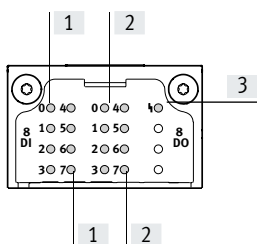

- [1] Status LEDs (green): for allocation to the inputs → pin allocation of the module
- [2] Status LEDs (yellow): for allocation to the inputs → pin allocation of the module
- [3] Error LED (red) (module error)

CPX-L-8DE-8DA

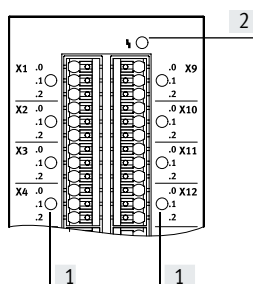

- [1] Status LEDs (green) for each input signal
- [2] Error LED (red, module error)

### Connection block/digital I/O module combinations

Connection blocks	Part no.	Digital I/O module	
		CPX-8DE-8DA	CPX-L-8DE-8DA
CPX-AB-4-M12-8POL	526178	■	-
CPX-AB-8-KL-4POL	195708	■	-
CPX-AB-1-SUB-BU-25POL	525676	■	-

### Pin allocation

Connection block inputs/outputs

CPX-8DE-8DA

#### CPX-AB-4-M12-8POL

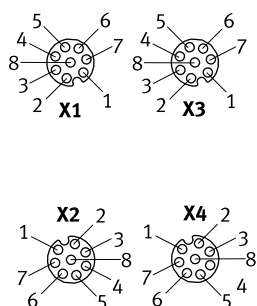

- X1.1: 24 V<sub>SEN</sub>
- X1.2: Input x
- X1.3: Input x+1
- X1.4: 0 V<sub>SEN</sub>
- X1.5: Output x
- X1.6: Output x+1
- X1.7: Input x+4
- X1.8: 0 V<sub>OUT</sub>
- X2.1: 24 V<sub>SEN</sub>
- X2.2: Input x+2
- X2.3: Input x+3
- X2.4: 0 V<sub>SEN</sub>
- X2.5: Output x+2
- X2.6: Output x+3
- X2.7: Input x+6
- X2.8: 0 V<sub>OUT</sub>

- X3.1: 24 V<sub>SEN</sub>
- X3.2: Input x+4
- X3.3: Input x+5
- X3.4: 0 V<sub>SEN</sub>
- X3.5: Output x+4
- X3.6: Output x+5
- X3.7: n.c.
- X3.8: 0 V<sub>OUT</sub>
- X4.1: 24 V<sub>SEN</sub>
- X4.2: Input x+6
- X4.3: Input x+7
- X4.4: 0 V<sub>SEN</sub>
- X4.5: Output x+6
- X4.6: Output x+7
- X4.7: n.c.
- X4.8: 0 V<sub>OUT</sub>

Data sheet – Input/output module, digital

Pin allocation		CPX-8DE-8DA
<b>CPX-AB-8-KL-4POL</b>		
	<p>X1.0: 24 V<sub>SEN</sub>                      X1.1: 0 V<sub>SEN</sub>                      X1.2: Input x                      X1.3: FE</p> <p>X2.0: Input x+4                      X2.1: Input x+5                      X2.2: Input x+1                      X2.3: FE</p> <p>X3.0: 24 V<sub>SEN</sub>                      X3.1: 0 V<sub>SEN</sub>                      X3.2: Input x+2                      X3.3: FE</p> <p>X4.0: Input x+6                      X4.1: Input x+7                      X4.2: Input x+3                      X4.3: FE</p>	<p>X5.0: Output x+4                      X5.1: 0 V<sub>OUT</sub>                      X5.2: Output x                      X5.3: FE</p> <p>X6.0: Output x+5                      X6.1: 0 V<sub>OUT</sub>                      X6.2: Output x+1                      X6.3: FE</p> <p>X7.0: Output x+6                      X7.1: 0 V<sub>OUT</sub>                      X7.2: Output x+2                      X7.3: FE</p> <p>X8.0: Output x+7                      X8.1: 0 V<sub>OUT</sub>                      X8.2: Output x+3                      X8.3: FE</p>
<b>CPX-AB-1-SUB-BU-25POL</b>		
	<p>1: Input x                      2: Input x+1                      3: Input x+2                      4: Input x+3                      5: Input x+4                      6: Input x+5                      7: Input x+6                      8: Input x+7                      9: 24 V<sub>SEN</sub>                      10: 24 V<sub>SEN</sub>                      11: 0 V<sub>SEN</sub>                      12: 0 V<sub>SEN</sub>                      13: FE</p>	<p>14: Output x                      15: Output x+1                      16: Output x+2                      17: Output x+3                      18: Output x+4                      19: Output x+5                      20: Output x+6                      21: Output x+7                      22: 0 V<sub>OUT</sub>                      23: 0 V<sub>OUT</sub>                      24: 0 V<sub>OUT</sub>                      25: FE                      Housing: FE</p>

## Data sheet – Input/output module, digital

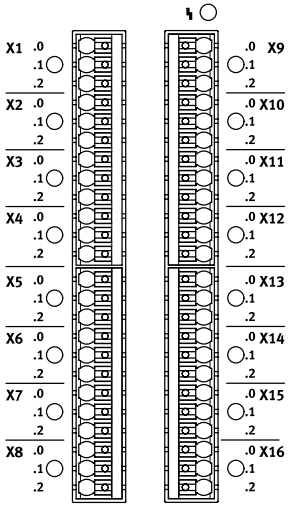
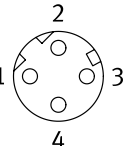
Pin allocation		CPX-L-8DE-8DA	
Connection block inputs			
	<p>X1.0: 24 V<sub>SEN</sub></p> <p>X1.1: Input x</p> <p>X1.2: 0 V<sub>SEN</sub>+out</p> <p>X2.0: 24 V<sub>SEN</sub></p> <p>X2.1: Input x+1</p> <p>X2.2: 0 V<sub>SEN</sub>+out</p> <p>X3.0: 24 V<sub>SEN</sub></p> <p>X3.1: Input x+2</p> <p>X3.2: 0 V<sub>SEN</sub>+out</p> <p>X4.0: 24 V<sub>SEN</sub></p> <p>X4.1: Input x+3</p> <p>X4.2: 0 V<sub>SEN</sub>+out</p> <p>X5.0: 24 V<sub>SEN</sub></p> <p>X5.1: Input x+4</p> <p>X5.2: 0 V<sub>SEN</sub>+out</p> <p>X6.0: 24 V<sub>SEN</sub></p> <p>X6.1: Input x+5</p> <p>X6.2: 0 V<sub>SEN</sub>+out</p> <p>X7.0: 24 V<sub>SEN</sub></p> <p>X7.1: Input x+6</p> <p>X7.2: 0 V<sub>SEN</sub>+out</p> <p>X8.0: 24 V<sub>SEN</sub></p> <p>X8.1: Input x+7</p> <p>X8.2: 0 V<sub>SEN</sub>+out</p>	<p>X9.0: 24 V<sub>SEN</sub></p> <p>X9.1: Output x</p> <p>X9.2: 0 V<sub>SEN</sub>+out</p> <p>X10.0: 24 V<sub>SEN</sub></p> <p>X10.1: Output x+1</p> <p>X10.2: 0 V<sub>SEN</sub>+out</p> <p>X11.0: 24 V<sub>SEN</sub></p> <p>X11.1: Output x+2</p> <p>X11.2: 0 V<sub>SEN</sub>+out</p> <p>X12.0: 24 V<sub>SEN</sub></p> <p>X12.1: Output x+3</p> <p>X12.2: 0 V<sub>SEN</sub>+out</p> <p>X13.0: 24 V<sub>SEN</sub></p> <p>X13.1: Output x+4</p> <p>X13.2: 0 V<sub>SEN</sub>+out</p> <p>X14.0: 24 V<sub>SEN</sub></p> <p>X14.1: Output x+5</p> <p>X14.2: 0 V<sub>SEN</sub>+out</p> <p>X15.0: 24 V<sub>SEN</sub></p> <p>X15.1: Output x+6</p> <p>X15.2: 0 V<sub>SEN</sub>+out</p> <p>X16.0: 24 V<sub>SEN</sub></p> <p>X16.1: Output x+7</p> <p>X16.2: 0 V<sub>SEN</sub>+out</p>	
Interlinking block		CPX-L-8DE-8DA	
	<p>The module combines the 0 V potential of the power supply for electronics and sensors with the 0 V potential of the power supply for outputs in the CPX interlinking module.</p>	<p>If all pins of the outputs of an output module connected to the right of the input/output module are to be switched off, an appropriate interlinking block with additional supply for outputs must be used to the right of the input/output module.</p>	

## Data sheet – Input/output module, digital

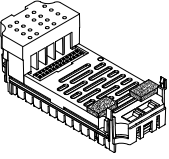
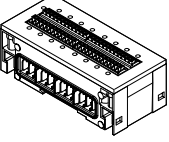
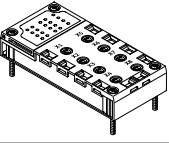
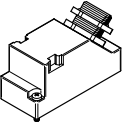
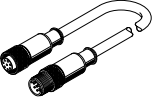
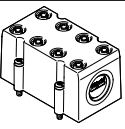
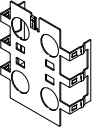
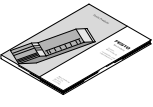
Ordering data		Part no.	Type
Designation			
Input/output module, digital			
	8 digital inputs, 8 digital outputs	526257	CPX-8DE-8DA
	8 digital inputs, 8 digital outputs, for CPX in plastic, including interlinking block and connection block with spring-loaded terminals	572607	CPX-L-8DE-8DA-16-KL-3POL
Connection block			
	Plastic	4x socket M12, 8-pin	526178 CPX-AB-4-M12-8POL
		Spring-loaded terminal, 32-pin	195708 CPX-AB-8-KL-4POL
		1x socket, Sub-D, 25-pin	525676 CPX-AB-1-SUB-BU-25POL
Plug			
	Sub-D plug, 25-pin	527522	SD-SUB-D-ST25
Connecting cable			
	Connecting cable M12	525617	KM12-8GD8GS-2-PU
Cover			
	Cover for CPX-AB-8-KL-4POL (IP65, IP67)	538219	AK-8KL
	<ul style="list-style-type: none"> <li>• 8 cable through feeds M9</li> <li>• 1 cable through feed for multi-pin plug</li> </ul> Fittings kit	538220	VG-K-M9
Screening plate			
	Screening plate for M12 connections	526184	CPX-AB-S-4-M12
User documentation			
	User documentation	German	526439 P.BE-CPX-EA-DE
		English	526440 P.BE-CPX-EA-EN
		Spanish	526441 P.BE-CPX-EA-ES
		French	526442 P.BE-CPX-EA-FR
		Italian	526443 P.BE-CPX-EA-IT

## Data sheet – Counter module, digital

### Function

The counter module has two channels. Depending on the parameterisation, these can independently be used as counter inputs or as incremental value encoder inputs or SSI. The counter module additionally has one output per channel. The outputs can either be controlled by a counter channel or an incremental value encoder channel, i.e. through an event such as "Comparative value reached". Alternatively, outputs can also be controlled via process data.

### Area of application

- Continuous counting
- One-off counting to count limit
- One-off counting to count limit, return to load value
- Periodic counting
- Measurement of frequencies
- Measurement of rotational speeds
- Measurement of duty cycle
- Measurement of position
- Measurement of speed
- Measuring with pulse generators
- Measurement with pulse generators and direction encoders
- Measurement with incremental encoders
- Measurement with SSI absolute encoders

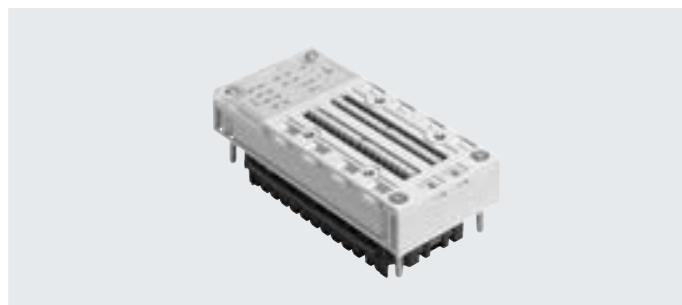

### Description

#### Applications

- |   |  |   |   |
|---|--|---|---|
| <ul style="list-style-type: none"> <li>• Recording travel and speed of a conveyor</li> <li>• Position and speed synchronisation of conveyors and pick &amp; place applications</li> <li>• Counting goods e.g. in packaging installations</li> </ul> | <ul style="list-style-type: none"> <li>• Systems for filling by weight and volume</li> <li>• Monitoring motor speeds</li> <li>• Measuring equipment for determining the position of axis systems (linear, rotational)</li> </ul> | <ul style="list-style-type: none"> <li>• Controlling fast-switching valves</li> <li>• Controlling the opening time of a valve</li> <li>• Activating semiconductor relays</li> </ul> | <ul style="list-style-type: none"> <li>• Temperature monitoring and rotational speed control for drives</li> <li>• Change of direction in fast drives</li> <li>• Control of motors with pulse-width modulation (PWM)</li> </ul> |
|---|--|---|---|

#### Supported devices

- |   |  |  |  |
|---|--|--|--|
| <ul style="list-style-type: none"> <li>• 5 V incremental encoder, single-ended or differential, with two 90° phase offset tracks</li> </ul> | <ul style="list-style-type: none"> <li>• 24 V incremental encoder, single-ended, with two 90° phase offset tracks</li> </ul> | <ul style="list-style-type: none"> <li>• 24 V pulse generator with or without direction level</li> <li>• 24 V direct current motors</li> </ul> | <ul style="list-style-type: none"> <li>• Absolute encoder with SSI interface (13 bits to 25 bits)</li> </ul> |
|---|--|--|--|

## Data sheet – Counter module, digital

General technical data			CPX-2ZE2DA
Type			CPX-2ZE2DA
Number	Inputs		2
	Outputs		2
Max. power supply Per module	Inputs	[A]	2
	Outputs	[A]	10
Max. power supply per channel		[A]	5 (adjustable, 20 W lamp load)
Max. cable length		[m]	30
Fuse protection (short circuit)			Internal electronic fuse per channel
Intrinsic current consumption at nominal operating voltage		[mA]	Typically 35
Operating voltage	Nominal value	[V DC]	24
	Permissible range	[V DC]	18 ... 30
Galvanic isolation, inputs	Channel – channel		No
	Channel – internal bus		No
Galvanic isolation, outputs	Channel – channel		No
	Channel – internal bus		Yes, with intermediate supply
Characteristic curve	Inputs		To IEC 1131-2, type O2
	Outputs		IEC 1131-T2
Switching level	Signal 0	[V DC]	≤ 5
	Signal 1	[V DC]	≥ 11
Input debounce time		[μs]	0.1 (0.2 μs, 0.4 μs, 0.8 μs, 1 μs, 2 μs, 4 μs, 8 μs, 10 μs, 50 μs, 100 μs, 500 μs, 1 ms, 3 ms, 10 ms, 20 ms parameterisable)
Switching logic	Inputs		Positive logic (PNP)
	Outputs		<ul style="list-style-type: none"> <li>• Negative logic (NPN)</li> <li>• Positive logic (PNP)</li> <li>• Push-pull driver</li> </ul>
LED displays	Group diagnostics		1
	Channel diagnostics		2
	Channel status		10
	Module diagnostics		2
Diagnostics			Operating mode-dependent diagnostics
Parameterisation			<ul style="list-style-type: none"> <li>• Switch-on/off delay</li> <li>• Frequency output</li> <li>• Speed measurement</li> <li>• Impulse output</li> <li>• Pulse train</li> <li>• Rotational speed measurement</li> <li>• Frequency measurement</li> <li>• Period duration measurement</li> <li>• Motor operating mode</li> <li>• Determine position</li> <li>• Pulse width modulation</li> <li>• One-off counting</li> <li>• Continuous counting</li> <li>• Periodic counting</li> </ul>
Degree of protection to EN 60529			IP65, IP67
Temperature range	Operation	[°C]	-5 ... +50
	Storage/transport	[°C]	-20 ... +70
Certification			UL – Recognized (OL)
Information on materials: Housing			Plastic
Note on materials			RoHS-compliant
Grid dimension		[mm]	50
Dimensions (including interlinking block and connection block) W x L x H		[mm]	50 x 107 x 50
Product weight		[g]	130

## Data sheet – Counter module, digital

## Connection and display components

CPX-2ZE2DA

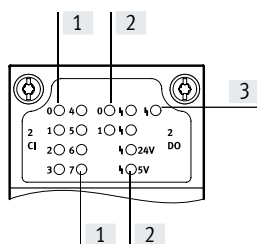



- [1] Status LEDs (green): for allocation to the inputs → pin allocation of the module
- [2] Status LEDs (yellow, red): for allocation to the inputs a pin allocation of the module
- [3] Error LED (red) (module error)

Pin allocation	CPX-2ZE2DA	
Inputs/outputs	Channel 0	Channel 1
	X1.0: Input X1.1: Input X1.2: Input X1.3: Input X2.0: Input X2.1: Input X2.2: 5 V DC X2.3: 0 V X3.0: 24 V DC X3.1: 0 V X3.2: 24 V DC for digital input DI X3.3: Digital input DI X4.0: 0 V for digital input DI X4.1: Digital output DO X4.2: Reference potential for DO X4.3: FE	X5.0: Input X5.1: Input X5.2: Input X5.3: Input X6.0: Input X6.1: Input X6.2: 5 V DC X6.3: 0 V X7.0: 24 V DC X7.1: 0 V X7.2: 24 V DC for digital input DI X7.3: Digital input DI X8.0: 0 V for digital input DI X8.1: Digital output DO X8.2: Reference potential for DO X8.3: FE

**Note**

The allocation and designation of inputs differs fundamentally depending on which type of encoder is connected. Appropriate allocation diagrams can be found in the user documentation for the counter module.

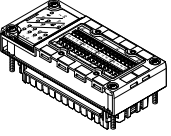
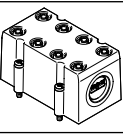
## Data sheet – Counter module, digital

Ordering data		Part no.	Type
Designation			
Counter module, digital			
	2 digital inputs, 2 digital outputs	576046	CPX-2ZE2DA
Cover			
	Cover for CPX-2ZE2DA (IP65, IP67) • 8 cable through feeds M9 • 1 cable through feed for multi-pin plug	538219	AK-8KL
	Fittings kit	538220	VG-K-M9
User documentation			
	User documentation for counter module CPX-2ZE2DA	German	8035733 P.BE-CPX-2ZE2DA-DE
		English	8035734 P.BE-CPX-2ZE2DA-EN
		Spanish	8035735 P.BE-CPX-2ZE2DA-ES
		French	8035736 P.BE-CPX-2ZE2DA-FR
		Italian	8035737 P.BE-CPX-2ZE2DA-IT
		Chinese	8035738 P.BE-CPX-2ZE2DA-ZH



## Data sheet – HART input/output module

### Function

The HART input/output module allows the connection of up to 4 sensors or actuators. The corresponding communication channel is made available for sensors or actuators that communicate using the HART protocol.

With the HART protocol, a conventional analogue 4 ... 20 mA current signal is modulated by a second frequency-modulated signal.

Each of the 4 connections of the module can be configured as inputs or outputs.

### Area of application

- Multi I/O module for 24 V DC supply voltage
- Supports connection blocks with M12 and terminal connection
- Module features can be parameterised
- The module receives the voltage supply for the electronics, outputs and the sensors from the interlinking block
- Module protection and diagnostics through integrated electronic protection

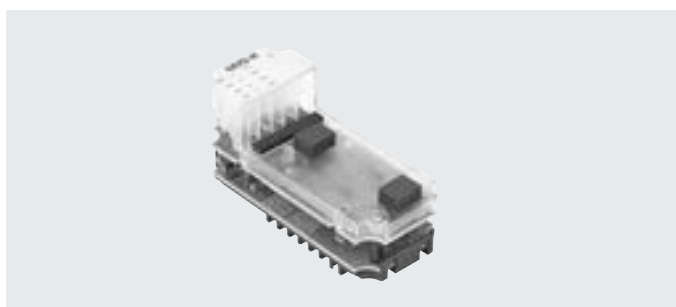

General technical data		CPX-4AE-4AA-H		
Type		CPX-4AE-4AA-H		
Protocol		HART		
Number of selectable analogue inputs/outputs		4		
Type of sensor		0 ... 20 mA	4 ... 20 mA	4 ... 20 mA with HART
Operating voltage	Nominal value	[V DC]	24	
	Permissible range	[V DC]	18 ... 30	
Power failure buffering		[ms]	10	
Intrinsic current consumption at nominal operating voltage		[mA]	Typically 170	
Maximum short circuit current		[mA]	22	
Maximum open circuit voltage		[V]	28.8	
Minimum available sensor voltage		20.7 V DC at 20 mA		
Fuse protection (short circuit)		Internal electronic fuse per channel		
Reverse polarity protection		For all electrical connections		
Galvanic isolation	Channel – channel	No		
	Channel – internal bus	Yes		
Signal range		0 ... 20 mA	4 ... 20 mA	4 ... 20 mA with HART
Data format		15 bits + prefix		
		Scalable to 15 bits		
Maximum load		[Ω]	750	
Maximum input resistance		[Ω]	300	
Maximum cable length		[m]	500	
Basic error limit at 25°C		[%]	±0.1	
Operating error limit related to the ambient temperature range		[%]	±0.3	
Repetition accuracy		0.05% at 20°C		
LED displays	Group diagnostics	1		
	Channel diagnostics	4		
	Channel status	4		
Control elements		DIL switch		
Diagnostics		<ul style="list-style-type: none"> <li>• Wire break per channel</li> <li>• Limit value violation per channel</li> <li>• Short circuit/overload per channel</li> <li>• Parameterisation error</li> <li>• Overflow/underflow</li> <li>• Limit value violation to NE43 per channel</li> </ul>		

## Data sheet – HART input/output module

General technical data	
Parameterisation	<ul style="list-style-type: none"> <li>• Data format</li> <li>• Failsafe per channel</li> <li>• Forcing per channel</li> <li>• Limit value monitoring per channel</li> <li>• Idle mode per channel</li> <li>• Measured value smoothing</li> <li>• Signal range per channel</li> <li>• Monitoring overflow/underflow</li> <li>• Monitoring to NE43, inputs</li> <li>• Monitoring of wire break per channel</li> <li>• Wire break per channel</li> <li>• Limit value violation per channel</li> <li>• Short circuit/overload per channel</li> <li>• Parameterisation error</li> <li>• Overflow/underflow</li> <li>• Limit value violation to NE43 per channel</li> <li>• Number of HART repetitions</li> <li>• Hysteresis for limit values</li> <li>• HART variables (4 pieces)</li> <li>• Behaviour after short circuit/overload</li> </ul>
Degree of protection to EN 60529	Depending on connection block

Technical data – Mechanical components	
Type of mounting	On interlinking block
Product weight	[g] 77.4
Grid dimension	[mm] 50
Dimensions (including interlinking block and connection block) W x L x H	[mm] 50 x 107 x 70

Materials	
Housing	Reinforced PA, PC
Note on materials	RoHS-compliant

Operating and environmental conditions	
Ambient temperature	[°C] -5 ... +50
Storage temperature	[°C] -20 ... +70
Relative humidity	[%] 95, non-condensing
Corrosion resistance class CRC <sup>1)</sup>	1 (when installed)
CE marking (see declaration of conformity) <sup>3)</sup>	To EU EMC Directive <sup>2)</sup>

1) Corrosion resistance class CRC 1 to Festo standard FN 940070

Low corrosion stress. Dry indoor application or transport and storage protection. Also applies to parts behind coverings, in the non-visible interior area, and parts which are covered in the application (e.g. drive trunnions).

2) For information about the area of use, see the EC declaration of conformity at: [www.festo.com/catalogue/...](http://www.festo.com/catalogue/...) → Support/Downloads.

If the devices are subject to usage restrictions in residential, commercial or light-industrial environments, further measures for the reduction of the emitted interference may be necessary.

3) Additional information: [www.festo.com/catalogue/...](http://www.festo.com/catalogue/...) → Support/Downloads.

Safety characteristics	
Shock resistance	Shock test with severity level 2 to FN 942017-5 and EN 60068-2-27
Vibration resistance	Transport application test with severity level 2 to FN 942017-4 and EN 60068-2-6

## Data sheet – HART input/output module

## Connection and display components

CPX-4EA-4AA-H

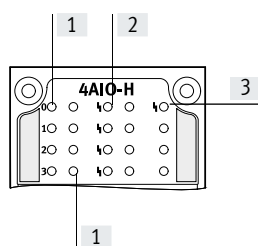

- [1] Status LEDs:  
 – Inputs (green)  
 – Outputs (yellow)  
 → Pin allocation for module
- [2] Error LEDs (red): for allocation to the inputs → pin allocation of the module
- [3] Error LED (red)  
 (module error)

## Combinations of bus nodes/control blocks with HART input/output module

Bus node/control block	Part no.	Protocol	Can be combined as of release	HART variables in process image only	Full HART functionality
CPX-CEC-C1-V3	3473128	CODESYS Level 2	3.5.12.174	–	■
CPX-CEC-M1-V3	3472765	CODESYS Level 2	3.5.12.174	–	■
CPX-CEC-S1-V3	3472425	CODESYS Level 2	3.5.12.174	–	■
CPX-FB11	526172	DeviceNet	25	■	–
CPX-FB13	195740	PROFIBUS	34	–	■
CPX-FB14	526174	CANopen	30	■	–
CPX-FB33	548755	PROFINET RT, M12	33	–	■
CPX-M-FB34	548751	PROFINET RT, RJ45	33	–	■
CPX-M-FB35	548749	PROFINET RT, SCRJ	33	–	■
CPX-FB36	1912451	EtherNet/IP	15	–	■
CPX-FB37	2735960	EtherCAT	7	■	–
CPX-FB43	8110369	PROFINET RT, M12	45	–	■
CPX-M-FB44	8110370	PROFINET RT, RJ45	45	–	■
CPX-M-FB45	8110371	PROFINET RT, SCRJ	45	–	■

## Combinations of connection blocks with HART input/output module

Connection blocks	Part no.	HART input/output module
		CPX-4EA-4AA-H
CPX-P-AB-4XM12-4POL	565706	■
CPX-P-AB-2XKL-8POL	565704	■

## Combinations of connection blocks with interlinking block

Connection blocks	Part no.	Plastic interlinking block	Metal interlinking block
		CPX-GE...	CPX-M-GE...
CPX-P-AB-4XM12-4POL	565706	–	■
CPX-P-AB-2XKL-8POL	565704	■	■





## Data sheet – HART input/output module

Pin allocation		CPX-4AE-4AA-H			
Connection block inputs/outputs		Inputs		Outputs	
<b>CPX-P-AB-4XM12-4POL</b>					
		X1.1: $24 V_{SEN\ x}$ X1.2: 0 V X1.3: Input x X1.4: 0 V X2.1: $24 V_{SEN\ x+1}$ X2.2: 0 V X2.3: Input x+1 X2.4: 0 V	X3.1: $24 V_{SEN\ x+2}$ X3.2: 0 V X3.3: Input x+2 X3.4: 0 V X4.1: $24 V_{SEN\ x+3}$ X4.2: 0 V X4.3: Input x+3 X4.4: 0 V	X1.1: Output I0+ X1.2: 0 V X1.3: – X1.4: 0 V X2.1: Output I1+ X2.2: 0 V X2.3: – X2.4: 0 V	X3.1: Output I2+ X3.2: 0 V X3.3: – X3.4: 0 V X4.1: Output I3+ X4.2: 0 V X4.3: – X4.4: 0 V
<b>CPX-P-AB-2XKL-8POL</b>					
		X1.1: $24 V_{SEN\ x}$ X1.2: 0 V X1.3: Input x X1.4: 0 V X1.5: $24 V_{SEN\ x+1}$ X1.6: 0 V X1.7: Input x+1 X1.8: 0 V	X2.1: $24 V_{SEN\ x+2}$ X2.2: 0 V X2.3: Input x+2 X2.4: 0 V X2.5: $24 V_{SEN\ x+3}$ X2.6: 0 V X2.7: Input x+3 X2.8: 0 V	X1.1: Output I0+ X1.2: 0 V X1.3: – X1.4: 0 V X1.5: Output I1+ X1.6: 0 V X1.7: – X1.8: 0 V	X2.1: Output I2+ X2.2: 0 V X2.3: – X2.4: 0 V X2.5: Output I3+ X2.6: 0 V X2.7: – X2.8: 0 V

 **Note**

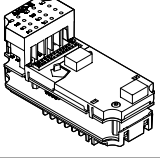
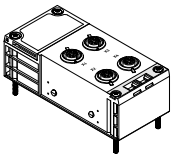
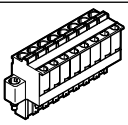
In the case of mixed operation of inputs and outputs in one module, the connections are first assigned input signals and then output signals, in ascending order.

## Data sheet – HART input/output module

Ordering data				Part no.	Type
Designation					
HART input/output module					
	4 analogue inputs/outputs			<b>8059847</b>	<b>CPX-4AE-4AA-H</b>
Connection block					
	Plastic	4x socket, M12, 4-pin		<b>565706</b>	<b>CPX-P-AB-4XM12-4POL</b>
		2x plug, 8-pin		<b>565704</b>	<b>CPX-P-AB-2XKL-8POL</b>
Plug					
	8-pin socket	Spring-loaded terminal	Connection cross section 0.2 ... 2.5 mm <sup>2</sup>	<b>565712</b>	<b>NECU-L3G8-C1</b>
		Screw terminal	Connection cross section 0.2 ... 2.5 mm <sup>2</sup>	<b>565710</b>	<b>NECU-L3G8-C2</b>
	Plug M12x1, 4-pin, straight, A-coded	Screw terminal	Connection cross section 0.14 ... 0.5 mm <sup>2</sup>	<b>192008</b>	<b>SEA-4GS-7-2.5</b>
			Nominal conductor cross section 14 ... 0.75 mm <sup>2</sup>	<b>18666</b>	<b>SEA-GS-7</b>
			Permissible cable $\varnothing$ 4 ... 6 mm		
			Connection cross section 0.75 mm <sup>2</sup>	<b>18778</b>	<b>SEA-GS-9</b>
			Permissible cable $\varnothing$ 6 ... 8 mm		
Cover					
	Cover cap for sealing unused connections M12x1 (10 pieces)			<b>165592</b>	<b>ISK-M12</b>
Coding element					
	To ensure that a coded socket NECU-L3G8 can only be inserted in the matching coded connection block CPX-P-AB-2XKL (96 of each)		For NECU-L3G8	<b>565713</b>	<b>CPX-P-KDS-AB-2XKL</b>

## Data sheet – Input module, analogue

**Function**

Analogue modules control devices with a standardised analogue interface such as pressure switches, temperature, flow rate, filling level, etc.

Depending on the connection block selected, the analogue module supports various connection concepts with different numbers of sockets or terminals.

**Area of application**

- Analogue module for 0 ... 10 V, 0 ... 20 mA or 4 ... 20 mA
- Supports connection blocks with Sub-D, terminal connection and M12 connection
- Analogue module features can be parameterised
- Different data formats available
- Operation with and without galvanic isolation possible
- The analogue module receives the voltage supply for the electronics and the sensors from the interlinking block
- Analogue module protection and diagnostics through integrated electronic fuse protection



General technical data		CPX-2AE-U-I		CPX-4AE-U-I		CPX-4AE-I
		Voltage input	Current input	Voltage input	Current input	Current input
Type						
Number of analogue inputs		2		4		4
Max. power supply per module	[A]	0.7				
Fuse protection		Internal electronic fuse				
Current consumption from 24 V sensor supply (quiescent current)	[mA]	Typically 50				
Current consumption from 24 V sensor supply (at full load)	[A]	Max. 0.7				
Nominal operating voltage for load voltage	[V DC]	24 ±2%				
Nominal operating voltage	[V DC]	24				
Operating voltage range	[V DC]	18 ... 30				
Signal range (parameterisable for each channel with DIL switch or software)		0 ... 10 V	0 ... 20 mA 4 ... 20 mA	1 ... 5 V 0 ... 10 V -5 ... +5 V -10 ... +10 V	0 ... 20 mA 4 ... 20 mA -20 ... +20 mA	0 ... 20 mA 4 ... 20 mA
Operational error limit	[%]	±0.5	–	±0.3	±0.3	±0.6
Basic error limit (at 25°C)	[%]	±0.3	–	±0.2	±0.2	±0.5
Repetition accuracy (at 25°C)	[%]	0.15	0.15	0.1	0.1	0.15
Input resistance		100 kΩ	≤ 100 Ω	100 kΩ	≤ 100 Ω	≤ 100 Ω
Max. permissible input voltage	[V DC]	30	–	-30 ... +30	–	–
Max. permissible input current	[mA]	–	40	–	Internally limited to 60	40
Conversion time per channel	[μs]	Typically 150				
Cycle time (module)	[ms]	≤ 4		≤ 0.5		≤ 10
Data format		12 bits + prefix Scalable to 15 bits		15 bits + prefix Scalable to 15 bits		12 bits + prefix Scalable to 15 bits
Cable length	[m]	Max. 30 (shielded)				

## Data sheet – Input module, analogue

General technical data					
Type		CPX-2AE-U-I	CPX-4AE-U-I	CPX-4AE-I	
Galvanic isolation	Channel – channel	No			
	Channel – internal bus	Yes, with external sensor supply			
LED displays	Group diagnostics	1			
	Channel diagnostics	Via flashing frequency of group diagnostics	4	Via flashing frequency of group diagnostics	
Diagnostics	Wire break per channel				
	Limit value violation per channel				
	Parameterisation error				
	Short circuit, input signal	Overload at input	Short circuit, input signal		
	–	Overflow/underflow	–		
	–	Short circuit in sensor supply	–		
Parameterisation	Data format				
	Forcing per channel				
	Limit value monitoring per channel				
	Measured value smoothing				
	Signal range per channel				
	Monitoring of wire break per channel				
	Behaviour after short circuit				
	–	Behaviour after overload at input	–		
	–	Sensor supply active	–		
	Degree of protection to EN 60529				
Depending on connection block					
Temperature range	Operation	[°C]	–5 ... +50		
	Storage/transport	[°C]	–20 ... +70		
Materials		Reinforced PA, PC			
Note on materials		–	RoHS-compliant	–	
Grid dimension		[mm]	50		
Dimensions (including interlinking block and connection block) W x L x H		[mm]	50 x 107 x 50		
Product weight		[g]	48	46	47

## Data sheet – Input module, analogue

### Connection and display components

CPX-2AE-U-I and CPX-4AE-I

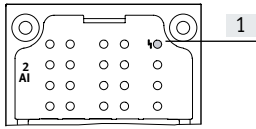

[1] Error LED (red; module error)

CPX-4AE-U-I

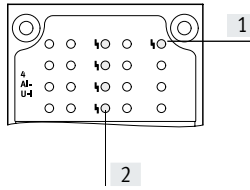

[1] Error LED (red; module error)

[2] Channel-related error LEDs (red)

### Combinations of connection blocks and analogue module

Connection blocks	Part no.	Analogue module		
		CPX-2AE-U-I	CPX-4AE-U-I	CPX-4AE-I
CPX-AB-4-M12X2-5POL	195704	■	■	■
CPX-AB-4-M12X2-5POL-R	541254	■	■	■
CPX-AB-8-KL-4POL	195708	■	■	■
CPX-AB-1-SUB-BU-25POL	525676	■	■	■
CPX-M-AB-4-M12X2-5POL	549367	■	■	■

### Pin allocation

Connection block inputs	CPX-2AE-U-I	CPX-4AE-U-I	CPX-4AE-I
-------------------------	-------------	-------------	-----------

#### CPX-AB-4-M12X2-5POL, CPX-AB-4-M12X2-5POL-R<sup>1)</sup> and CPX-M-AB-4-M12X2-5POL

	X1.1: 24 V <sub>SEN</sub>	X3.1: 24 V <sub>SEN</sub>	X1.1: 24 V <sub>SEN</sub>	X3.1: 24 V <sub>SEN</sub>	X1.1: 24 V <sub>SEN</sub>	X3.1: 24 V <sub>SEN</sub>
	X1.2: Input U0+	X3.2: Input U1+	X1.2: Input 0+	X3.2: Input 2+	X1.2: Input I0+	X3.2: Input I2+
	X1.3: 0 V <sub>SEN</sub>	X3.3: 0 V <sub>SEN</sub>	X1.3: 0 V <sub>SEN</sub>	X3.3: 0 V <sub>SEN</sub>	X1.3: 0 V <sub>SEN</sub>	X3.3: 0 V <sub>SEN</sub>
	X1.4: Input U0-	X3.4: Input U1-	X1.4: Input 0-	X3.4: Input 2-	X1.4: Input I0-	X3.4: Input I2-
	X1.5: FE <sup>2)</sup>	X3.5: FE <sup>2)</sup>	X1.5: FE <sup>2)</sup>	X3.5: FE <sup>2)</sup>	X1.5: FE <sup>2)</sup>	X3.5: FE <sup>2)</sup>
	X2.1: 24 V <sub>SEN</sub>	X4.1: 24 V <sub>SEN</sub>	X2.1: 24 V <sub>SEN</sub>	X4.1: 24 V <sub>SEN</sub>	X2.1: 24 V <sub>SEN</sub>	X4.1: 24 V <sub>SEN</sub>
	X2.2: Input I0+	X4.2: Input I1+	X2.2: Input 1+	X4.2: Input 3+	X2.2: Input I1+	X4.2: Input I3+
	X2.3: 0 V <sub>SEN</sub>	X4.3: 0 V <sub>SEN</sub>	X2.3: 0 V <sub>SEN</sub>	X4.3: 0 V <sub>SEN</sub>	X2.3: 0 V <sub>SEN</sub>	X4.3: 0 V <sub>SEN</sub>
	X2.4: Input I0-	X4.4: Input I1-	X2.4: Input 1-	X4.4: Input 3-	X2.4: Input I1-	X4.4: Input I3-
	X2.5: FE <sup>2)</sup>	X4.5: FE <sup>2)</sup>	X2.5: FE <sup>2)</sup>	X4.5: FE <sup>2)</sup>	X2.5: FE <sup>2)</sup>	X4.5: FE <sup>2)</sup>

#### CPX-AB-8-KL-4POL

	X1.0: 24 V <sub>SEN</sub>	X5.0: 24 V <sub>SEN</sub>	X1.0: 24 V <sub>SEN</sub>	X5.0: 24 V <sub>SEN</sub>	X1.0: 24 V <sub>SEN</sub>	X5.0: 24 V <sub>SEN</sub>
	X1.1: 0 V <sub>SEN</sub>	X5.1: 0 V <sub>SEN</sub>	X1.1: 0 V <sub>SEN</sub>	X5.1: 0 V <sub>SEN</sub>	X1.1: 0 V <sub>SEN</sub>	X5.1: 0 V <sub>SEN</sub>
	X1.2: Input U0-	X5.2: Input U1-	X1.2: Input 0-	X5.2: Input 2-	X1.2: Input I0-	X5.2: Input I2-
	X1.3: FE	X5.3: FE	X1.3: FE	X5.3: FE	X1.3: FE	X5.3: FE
	X2.0: n.c.	X6.0: n.c.	X2.0: n.c.	X6.0: n.c.	X2.0: n.c.	X6.0: n.c.
	X2.1: n.c.	X6.1: n.c.	X2.1: n.c.	X6.1: n.c.	X2.1: n.c.	X6.1: n.c.
	X2.2: Input U0+	X6.2: Input U1+	X2.2: Input 0+	X6.2: Input 2+	X2.2: Input I0+	X6.2: Input I2+
	X2.3: FE	X6.3: FE	X2.3: FE	X6.3: FE	X2.3: FE	X6.3: FE
	X3.0: 24 V <sub>SEN</sub>	X7.0: 24 V <sub>SEN</sub>	X3.0: 24 V <sub>SEN</sub>	X7.0: 24 V <sub>SEN</sub>	X3.0: 24 V <sub>SEN</sub>	X7.0: 24 V <sub>SEN</sub>
	X3.1: 0 V <sub>SEN</sub>	X7.1: 0 V <sub>SEN</sub>	X3.1: 0 V <sub>SEN</sub>	X7.1: 0 V <sub>SEN</sub>	X3.1: 0 V <sub>SEN</sub>	X7.1: 0 V <sub>SEN</sub>
	X3.2: Input I0-	X7.2: Input I1-	X3.2: Input 1-	X7.2: Input 3-	X3.2: Input I1-	X7.2: Input I3-
	X3.3: FE	X7.3: FE	X3.3: FE	X7.3: FE	X3.3: FE	X7.3: FE
	X4.0: n.c.	X8.0: n.c.	X4.0: n.c.	X8.0: n.c.	X4.0: n.c.	X8.0: n.c.
	X4.1: n.c.	X8.1: n.c.	X4.1: n.c.	X8.1: n.c.	X4.1: n.c.	X8.1: n.c.
	X4.2: Input I0+	X8.2: Input I1+	X4.2: Input 1+	X8.2: Input 3+	X4.2: Input I1+	X8.2: Input I3+
	X4.3: FE	X8.3: FE	X4.3: FE	X8.3: FE	X4.3: FE	X8.3: FE

1) Speedcon quick lock, additional shielding on metal thread

2) FE/shield additionally on metal thread





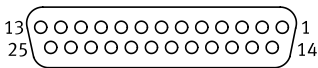

## Data sheet – Input module, analogue

Pin allocation		CPX-2AE-U-I		CPX-4AE-U-I		CPX-4AE-I	
Connection block inputs		CPX-2AE-U-I		CPX-4AE-U-I		CPX-4AE-I	
<b>CPX-AB-1-SUB-BU-25POL</b>							
		1: Input U0-	14: Input U1-	1: Input 0-	14: Input 2-	1: Input I0-	14: Input I2-
		2: Input U0+	15: Input U1+	2: Input 0+	15: Input 2+	2: Input I0+	15: Input I2+
		3: Input I0-	16: Input I1-	3: Input 1-	16: Input 3-	3: Input I1-	16: Input I3-
		4: Input I1+	17: Input I1+	4: Input 1+	17: Input 3+	4: Input I1+	17: Input I3+
		5: n.c.	18: 24 V <sub>SEN</sub>	5: n.c.	18: 24 V <sub>SEN</sub>	5: n.c.	18: 24 V <sub>SEN</sub>
		6: n.c.	19: n.c.	6: n.c.	19: n.c.	6: n.c.	19: n.c.
		7: n.c.	20: 24 V <sub>SEN</sub>	7: n.c.	20: 24 V <sub>SEN</sub>	7: n.c.	20: 24 V <sub>SEN</sub>
		8: n.c.	21: n.c.	8: n.c.	21: n.c.	8: n.c.	21: n.c.
		9: 24 V <sub>SEN</sub>	22: 0 V <sub>SEN</sub>	9: 24 V <sub>SEN</sub>	22: 0 V <sub>SEN</sub>	9: 24 V <sub>SEN</sub>	22: 0 V <sub>SEN</sub>
		10: 24 V <sub>SEN</sub>	23: 0 V <sub>SEN</sub>	10: 24 V <sub>SEN</sub>	23: 0 V <sub>SEN</sub>	10: 24 V <sub>SEN</sub>	23: 0 V <sub>SEN</sub>
		11: 0 V <sub>SEN</sub>	24: 0 V <sub>SEN</sub>	11: 0 V <sub>SEN</sub>	24: 0 V <sub>SEN</sub>	11: 0 V <sub>SEN</sub>	24: 0 V <sub>SEN</sub>
		12: 0 V <sub>SEN</sub>	25: FE	12: 0 V <sub>SEN</sub>	25: FE	12: 0 V <sub>SEN</sub>	25: FE
		13: Shielding <sup>1)</sup>	Housing: FE	13: Shielding <sup>1)</sup>	Housing: FE	13: Shielding <sup>1)</sup>	Housing: FE

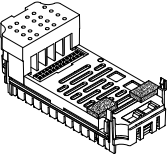
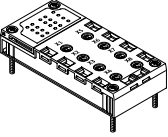
1) Connect shield to functional earth FE

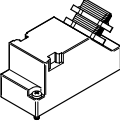
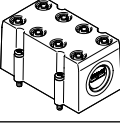
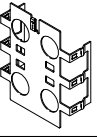
## Data sheet – Input module, analogue

Ordering data		Part no.	Type	
<b>Input module, analogue</b>				
	2 analogue current or voltage inputs	<b>526168</b>	<b>CPX-2AE-U-I</b>	
	4 analogue current or voltage inputs	<b>573710</b>	<b>CPX-4AE-U-I</b>	
	4 analogue current inputs	<b>541484</b>	<b>CPX-4AE-I</b>	
<b>Connection block</b>				
	Plastic	4x socket M12, 5-pin	<b>195704</b>	<b>CPX-AB-4-M12X2-5POL</b>
		4x socket, M12 with quick-lock technology, 5-pin	<b>541254</b>	<b>CPX-AB-4-M12X2-5POL-R</b>
		Spring-loaded terminal, 32-pin	<b>195708</b>	<b>CPX-AB-8-KL-4POL</b>
	Metal	1x socket, Sub-D, 25-pin	<b>525676</b>	<b>CPX-AB-1-SUB-BU-25POL</b>
		4x socket M12, 5-pin	<b>549367</b>	<b>CPX-M-AB-4-M12X2-5POL</b>
<b>Plug</b>				
	Plug M12, 5-pin	<b>175487</b>	<b>SEA-M12-5GS-PG7</b>	
	Sub-D plug, 25-pin	<b>527522</b>	<b>SD-SUB-D-ST25</b>	
<b>Cover</b>				
	Cover for CPX-AB-8-KL-4POL (IP65, IP67)	<b>538219</b>	<b>AK-8KL</b>	
	<ul style="list-style-type: none"> <li>• 8 cable through feeds M9</li> <li>• 1 cable through feed for multi-pin plug</li> </ul> Fittings kit	<b>538220</b>	<b>VG-K-M9</b>	
<b>Screening plate</b>				
	Screening plate for M12 connections	<b>526184</b>	<b>CPX-AB-S-4-M12</b>	
<b>User documentation</b>				
	User documentation	German	<b>526415</b>	<b>P.BE-CPX-AX-DE</b>
		English	<b>526416</b>	<b>P.BE-CPX-AX-EN</b>
		Spanish	<b>526417</b>	<b>P.BE-CPX-AX-ES</b>
		French	<b>526418</b>	<b>P.BE-CPX-AX-FR</b>
		Italian	<b>526419</b>	<b>P.BE-CPX-AX-IT</b>

## Data sheet – Input module, analogue, with pressure sensors

**Function**

The pressure input modules make it possible to process a maximum of 4 pressures. The internal measured value of the sensor (analogue value with 10-bit resolution) is converted into an internal numerical format as appropriate to the parameterisation and made available to the bus node as a process image. It is additionally also possible to combine 2 channels in each case to form a differential pressure channel.

**Area of application**

- Measuring range: 0 ... 10 bar or –1 ... +1 bar
- Choice of units of measurement
- Processing a maximum of 4 pressures per module
- Pressure indication via LCD display
- Direct connection via QS4 push-in connectors
- Error message via CPX
- Channel-oriented diagnostics



General technical data			CPX-4AE-P-B2	CPX-4AE-P-D10
Type				
Number of analogue inputs			4	
Pneumatic connection			QS-4	
Nominal operating voltage	[V DC]		24	
Operating voltage range	[V DC]		18 ... 30	
Intrinsic current consumption	[mA]		Typically 50	
Measured variable			4 x relative or 2 x differential pressure measurement	
Displayable units			<ul style="list-style-type: none"> <li>• kPa</li> <li>• mbar</li> <li>• psi</li> </ul>	
Pressure measuring range	Start value	[bar]	–1	0
	Final value	[bar]	1	10
Internal cycle time		[ms]	5	
Data format			<ul style="list-style-type: none"> <li>• 15 bits + prefix</li> <li>• Binary notation in mbar, kPa, psi</li> </ul>	
LED displays			Group diagnostics	
Diagnostics			<ul style="list-style-type: none"> <li>• Limit value violation per channel</li> <li>• Parameterisation error</li> <li>• Sensor limit per channel</li> </ul>	
Parameterisation			<ul style="list-style-type: none"> <li>• Diagnostic delay per channel</li> <li>• Hysteresis per module</li> <li>• Unit of measurement</li> <li>• Measured value smoothing per channel</li> <li>• Limit value monitoring per channel</li> <li>• Sensor limit per channel</li> <li>• Measurement of relative/differential pressure</li> </ul>	
Degree of protection to EN 60529			IP65, IP67	
Operating medium			Compressed air to ISO 8573-1:2010 [7:4:4]	
Note on the operating/pilot medium			Lubricated operation possible (in which case lubricated operation will always be required)	
Ambient temperature		[°C]	–5 ... 50	
Storage temperature		[°C]	–20 ... 70	
Temperature of medium		[°C]	0 ... 50	
Note on materials			RoHS-compliant	
Materials			Reinforced PA, PC	
Grid dimension		[mm]	50	
Dimensions (including interlinking block) W x L x H		[mm]	50 x 107 x 55	
Product weight		[g]	115	

**Note**

Extreme pneumatic conditions, e.g. high cycle rate with high pressure amplitudes, can damage the sensors.

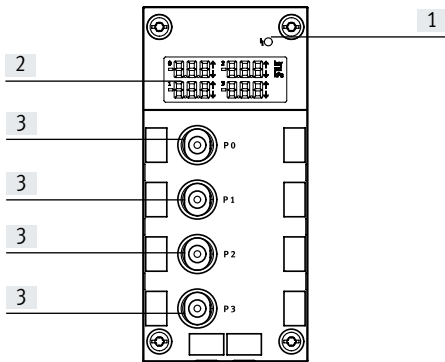

## Data sheet – Input module, analogue, with pressure sensors

### Connection and display components

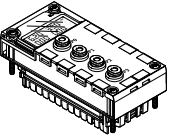
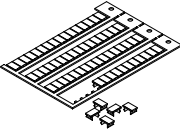

- [1] Error LED (red; module error)
- [2] LCD display with permanent display of the four measured pressures, unit of measurement and if applicable limit value violation
- [3] QS connections

### Ordering data

Designation		Part no.	Type	
	4 analogue pressure inputs, pressure range -1 ... +1 bar	560361	CPX-4AE-P-B2	
	4 analogue pressure inputs, pressure range 0 ... 10 bar	560362	CPX-4AE-P-D10	
<b>Inscription labels</b>				
	Inscription labels 6x10 mm, 64 pieces, in frame	18576	IBS-6x10	
<b>User documentation</b>				
	User documentation	German	526415	P.BE-CPX-AX-DE
		English	526416	P.BE-CPX-AX-EN
		Spanish	526417	P.BE-CPX-AX-ES
		French	526418	P.BE-CPX-AX-FR
		Italian	526419	P.BE-CPX-AX-IT

## Data sheet – Input module, analogue, for temperature inputs

### Function

The CPX-PT100 analogue input module with 4 channels for temperature measurement enables the connection of up to 4 temperature sensors of the type PT100-PT1000, Ni100-Ni1000, etc. The temperature module supports various connection concepts with different numbers of sockets or terminals as appropriate to the connection block selected.

### Area of application

- Temperature module for temperature sensors PT100, PT200, PT500, PT1000, Ni100, Ni120, Ni500, Ni1000
- Supports connection blocks with M12, HARAX and terminal connection
- Temperature module features can be parameterised
- 2-wire, 3-wire and 4-wire connection
- The temperature module is provided with voltage supply for the electronics and the sensors via the interlinking block
- Temperature module protection and diagnostics through integrated electronic fuse protection

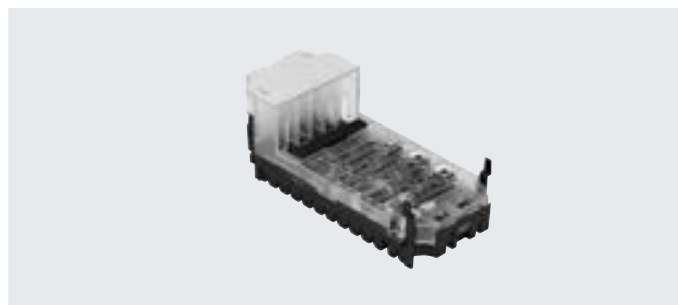

General technical data			
Type			CPX-4AE-T
			Temperature input
Number of analogue inputs			Choice of 2 or 4
Max. power supply per module		[A]	0.7
Fuse protection			Internal electronic fuse for sensor supply
Current consumption from 24 V sensor supply (quiescent current)		[mA]	Typically 50
Sensor supply voltage		[V DC]	24 ±25%
Sensor type (parameterisable for each channel with DIL switch)			PT100, PT200, PT500, PT1000 Ni100, Ni120, Ni500, Ni1000
Temperature range	Pt standard	[°C]	-200 ... +850
	Pt climatic	[°C]	-120 ... +130
	Ni	[°C]	-60 ... +180
Sensor connection technology			2-wire, 3-wire and 4-wire technology
Resolution			15 bits + prefix
Operating error limit relative to input range		[%]	±0.06
Basic error limit (25°C)	Standard	[K]	±0.6
	Pt climatic	[K]	±0.2
Temperature errors relative to input range		[%]	±0.001
Linearity errors (no software scaling)		[%]	±0.02
Repetition accuracy (at 25°C)		[%]	±0.05
Max. line resistance per conductor		[Ω]	10
Max. permissible input voltage		[V]	±30
Cycle time (module)		[ms]	≤ 250

## Data sheet – Input module, analogue, for temperature inputs

General technical data		
Data format		15 bits + prefix, complement of two, binary notation in tenths of a degree
Cable length	[m]	Max. 200 (shielded)
Galvanic isolation	Channel – channel	No
	Channel – internal bus	Yes
LED displays	Group diagnostics	1
	Channel diagnostics	4
Diagnostics		<ul style="list-style-type: none"> <li>• Short circuit/overload, channel</li> <li>• Parameterisation error</li> <li>• Value falling below nominal range/full-scale value</li> <li>• Value exceeding nominal range/full-scale value</li> <li>• Wire break</li> </ul>
Parameterisation		<ul style="list-style-type: none"> <li>• Unit of measurement and interference frequency suppression</li> <li>• Diagnostic message in the event of a wire break or short circuit</li> <li>• Limit monitoring per channel</li> <li>• Sensor connection technology</li> <li>• Sensor type/temperature coefficient, temperature range</li> <li>• Limit value per channel</li> <li>• Measured value smoothing</li> </ul>
Degree of protection to EN 60529		Depending on connection block
Temperature range	Operation	[°C] -5 ... +50
	Storage/transport	[°C] -20 ... +70
Materials		Reinforced PA, PC
Grid dimension	[mm]	50
Dimensions (including interlinking block and connection block) W x L x H	[mm]	50 x 107 x 50
Product weight	[g]	47

### Connection and display components

CPX-4AE-T

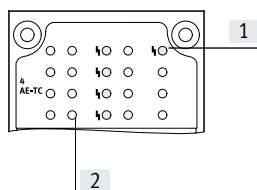

- [1] Error LED (red; module error)
- [2] Channel-related error LEDs (red)

### Combinations of connection blocks and analogue module

Connection blocks	Part no.	Temperature module
		CPX-4AE-T
CPX-AB-4-M12X2-5POL	195704	■
CPX-AB-4-M12X2-5POL-R	541254	■
CPX-AB-8-KL-4POL	195708	■
CPX-AB-4-HAR-4POL	525636	■
CPX-M-AB-4-M12X2-5POL	549367	■



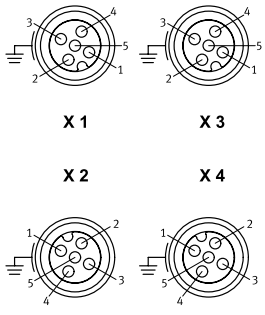
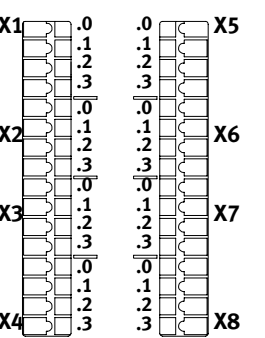
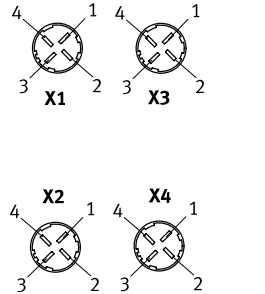

## Data sheet – Input module, analogue, for temperature inputs

Pin allocation		CPX-4AE-T
Connection block inputs		
<b>CPX-AB-4-M12X2-5POL, CPX-AB-4-M12X2-5POL-R<sup>1)</sup> and CPX-M-AB-4-M12X2-5POL</b>		
 <p>X 1      X 3 X 2      X 4</p>	<p>X1.1: Input I0+ X1.2: Input U0+ X1.3: Input I0– X1.4: Input U0– X1.5: FE<sup>2)</sup> X2.1: Input I1+ X2.2: Input U1+ X2.3: Input I1– X2.4: Input U1– X2.5: FE<sup>2)</sup></p>	<p>X3.1: Input I2+ X3.2: Input U2+ X3.3: Input I2– X3.4: Input U2– X3.5: FE<sup>2)</sup> X4.1: Input I3+ X4.2: Input U3+ X4.3: Input I3– X4.4: Input U3– X4.5: FE<sup>2)</sup></p>
<b>CPX-AB-8-KL-4POL</b>		
 <p>X1      X5 X2      X6 X3      X7 X4      X8</p>	<p>X1.0: Input I0+ X1.1: Input I0– X1.2: Input U0– X1.3: FE X2.0: n.c. X2.1: n.c. X2.2: Input U0+ X2.3: FE X3.0: Input I1+ X3.1: Input I1– X3.2: Input U1– X3.3: FE X4.0: n.c. X4.1: n.c. X4.2: Input U1+ X4.3: FE</p>	<p>X5.0: Input I2+ X5.1: Input I2– X5.2: Input U2– X5.3: FE X6.0: n.c. X6.1: n.c. X6.2: Input U12+ X6.3: FE X7.0: Input I3+ X7.1: Input I3– X7.2: Input U3– X7.3: FE X8.0: n.c. X8.1: n.c. X8.2: Input U3+ X8.3: FE</p>
<b>CPX-AB-4-HAR-4POL</b>		
 <p>X1      X3 X2      X4</p>	<p>X1.1: Input I0+ X1.2: Input U0+ X1.3: Input I0– X1.4: Input U0– X2.1: Input I1+ X2.2: Input U1+ X2.3: Input I1– X2.4: Input U1–</p>	<p>X3.1: Input I2+ X3.2: Input U2+ X3.3: Input I2– X3.4: Input U2– X4.1: Input I3+ X4.2: Input U3+ X4.3: Input I3– X4.4: Input U3–</p>

1) Speedcon quick lock, additional shielding on metal thread

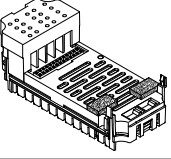
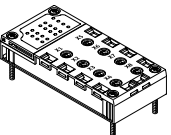
2) FE/shield additionally on metal thread

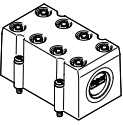
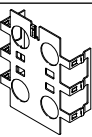
## Data sheet – Input module, analogue, for temperature inputs

Ordering data		Part no.	Type	
Designation				
Input module, analogue				
	2 or 4 analogue temperature inputs	541486	CPX-4AE-T	
Connection block				
	Plastic	4x socket M12, 5-pin	195704	CPX-AB-4-M12X2-5POL
		4x socket, M12 with quick-lock technology, 5-pin	541254	CPX-AB-4-M12X2-5POL-R
		Spring-loaded terminal, 32-pin	195708	CPX-AB-8-KL-4POL
		4x socket, quick connector, 4-pin	525636	CPX-AB-4-HAR-4POL
	Metal	4x socket M12, 5-pin	549367	CPX-M-AB-4-M12X2-5POL
Plug				
	Plug M12, 5-pin	175487	SEA-M12-5GS-PG7	
Cover				
	Cover for CPX-AB-8-KL-4POL (IP65, IP67)	538219	AK-8KL	
	<ul style="list-style-type: none"> <li>• 8 cable through feeds M9</li> <li>• 1 cable through feed for multi-pin plug</li> </ul> Fittings kit	538220	VG-K-M9	
Screening plate				
	Screening plate for M12 connections	526184	CPX-AB-S-4-M12	
User documentation				
	User documentation	German	526415	P.BE-CPX-AX-DE
		English	526416	P.BE-CPX-AX-EN
		Spanish	526417	P.BE-CPX-AX-ES
		French	526418	P.BE-CPX-AX-FR
		Italian	526419	P.BE-CPX-AX-IT



## Data sheet – Input module, analogue, for thermocouple

### Function

The CPX-4AE-TC analogue input module with 4 channels for temperature measurement enables up to 4 thermocouple sensors to be connected.

The channels feature wire break and short circuit detection.

If no cold junction compensation sensor is being used, an internal theoretical value of 25°C can be used (accuracy is impaired).

### Area of application

- Supports connection blocks with M12 and terminal connection
- Temperature module features can be parameterised
- 2-wire connection
- 2-wire connection for a PT1000 sensor for cold junction compensation
- The temperature module is provided with voltage supply for the electronics and the sensors via the interlinking block
- Temperature module protection and diagnostics through integrated electronic fuse protection

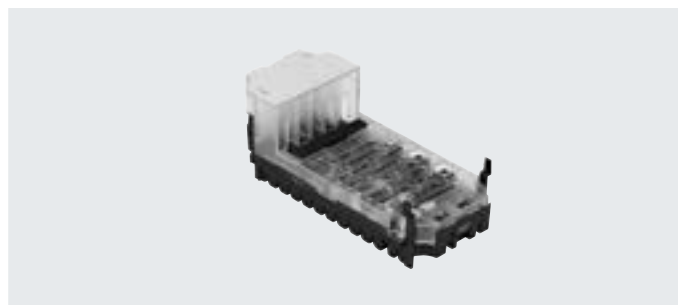

General technical data		CPX-4AE-TC
Type		Temperature input
Number of analogue inputs		4
Fuse protection (short circuit)		Internal electronic fuse per channel
Nominal operating voltage	[V DC]	24
Operating voltage range	[V DC]	18 ... 30
Sensor type (parameterisable for each channel with software)		<ul style="list-style-type: none"> <li>• Type B +400 ... +1820°C, 8 iV/°C</li> <li>• Type E -270 ... +900°C, 60 iV/°C</li> <li>• Type J -200 ... +1200°C, 51 iV/°C</li> <li>• Type K -200 ... +1370°C, 40 iV/°C</li> <li>• Type N -200 ... +1300°C, 38 iV/°C</li> <li>• Type R 0 ... +1760°C, 12 iV/°C</li> <li>• Type S 0 ... +1760°C, 11 iV/°C</li> <li>• Type T -200 ... +400°C, 40 iV/°C</li> </ul>
Sensor connection technology		2-wire technology
Operating error limit relative to ambient temperature	[%]	Max. ±0.6
Basic error limit (at 25°C)	[%]	Max. ±0.4
Repetition accuracy (at 25°C)	[%]	±0.05
Max. line resistance per conductor	[Ω]	10
Max. residual current per module	[mA]	30
Max. permissible input voltage	[V]	±30
Internal cycle time (module)	[ms]	250

## Data sheet – Input module, analogue, for thermocouple

General technical data		
Data format		<ul style="list-style-type: none"> <li>• 15 bits + prefix, complement of two</li> <li>• Binary notation in tenths of a degree</li> </ul>
Cable length	[m]	Max. 50 (shielded)
Galvanic isolation	Channel – channel	No
	Channel – internal bus	Yes
LED displays	Group diagnostics	1
	Channel diagnostics	4
Diagnostics		<ul style="list-style-type: none"> <li>• Parameterisation error</li> <li>• Wire break per channel</li> <li>• Limit value violation per channel</li> </ul>
Parameterisation		<ul style="list-style-type: none"> <li>• Monitoring of wire break per channel</li> <li>• Unit of measurement</li> <li>• Cold-junction compensation</li> <li>• Sensor type per channel</li> <li>• Limit value monitoring per channel</li> <li>• Measured value smoothing</li> </ul>
Degree of protection to EN 60529		Depending on connection block
Temperature range	Operation	[°C] -5 ... +50
	Storage/transport	[°C] -20 ... +70
Materials		Reinforced PA, PC
Grid dimension	[mm]	50
Dimensions (including interlinking block and connection block) W x L x H	[mm]	50 x 107 x 50
Product weight	[g]	46

### Connection and display components

CPX-4AE-TC

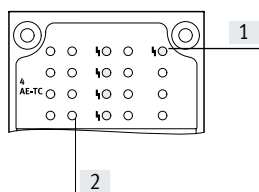

- [1] Error LED (red; module error)
- [2] Channel-related error LEDs (red)

### Combinations of connection blocks and analogue module

Connection blocks	Part no.	Temperature module
		CPX-4AE-TC
CPX-AB-4-M12X2-5POL	195704	■
CPX-AB-4-M12X2-5POL-R	541254	■
CPX-AB-8-KL-4POL	195708	■
CPX-M-AB-4-M12X2-5POL	549367	■



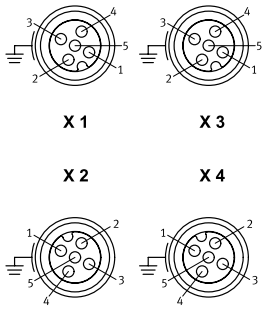
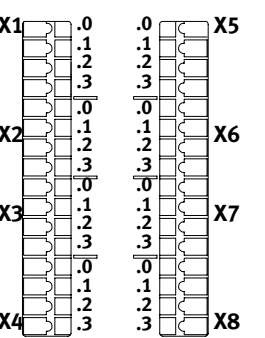

## Data sheet – Input module, analogue, for thermocouple

Pin allocation		CPX-4AE-TC	
Connection block inputs		CPX-4AE-TC	
<b>CPX-AB-4-M12X2-5POL, CPX-AB-4-M12X2-5POL-R<sup>1)</sup> and CPX-M-AB-4-M12X2-5POL</b>			
		X1.1: Cold junction compensation 0+ X1.2: Input signal U0+ X1.3: Cold junction compensation 0- X1.4: Input signal U0- X1.5: FE <sup>2)</sup> X2.1: Cold junction compensation 1+ X2.2: Input signal U1+ X2.3: Cold junction compensation 1- X2.4: Input signal U1- X2.5: FE <sup>2)</sup>	X3.1: Cold junction compensation 2+ X3.2: Input signal U2+ X3.3: Cold junction compensation 2- X3.4: Input signal U2- X3.5: FE <sup>2)</sup> X4.1: Cold junction compensation 3+ X4.2: Input signal U3+ X4.3: Cold junction compensation 3- X4.4: Input signal U3- X4.5: FE <sup>2)</sup>
<b>CPX-AB-8-KL-4POL</b>			
		X1.0: Cold junction compensation 0+ X1.1: Cold junction compensation 0- X1.2: Input signal U0- X1.3: FE X2.0: n.c. X2.1: n.c. X2.2: Input signal U0+ X2.3: FE X3.0: Cold junction compensation 1+ X3.1: Cold junction compensation 1- X3.2: Input signal U1- X3.3: FE X4.0: n.c. X4.1: n.c. X4.2: Input signal U1+ X4.3: FE	X5.0: Cold junction compensation 2+ X5.1: Cold junction compensation 2- X5.2: Input signal U2- X5.3: FE X6.0: n.c. X6.1: n.c. X6.2: Input signal U2+ X6.3: FE X7.0: Cold junction compensation 3+ X7.1: Cold junction compensation 3- X7.2: Input signal U3- X7.3: FE X8.0: n.c. X8.1: n.c. X8.2: Input signal U3+ X8.3: FE

1) Speedcon quick lock, additional shielding on metal thread

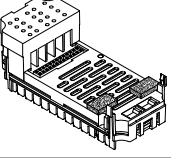
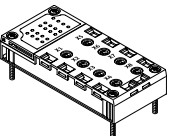
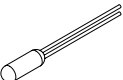
2) FE/shield additionally on metal thread

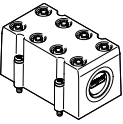
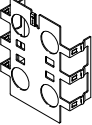
## Data sheet – Input module, analogue, for thermocouple

Ordering data		Part no.	Type	
Designation				
Input module, analogue				
	4 analogue temperature inputs, with 2-wire connection for a PT1000 sensor for cold junction compensation	553594	CPX-4AE-TC	
Connection block				
	Plastic	4x socket M12, 5-pin	195704	CPX-AB-4-M12X2-5POL
		4x socket, M12 with quick-lock technology, 5-pin	541254	CPX-AB-4-M12X2-5POL-R
		Spring-loaded terminal, 32-pin	195708	CPX-AB-8-KL-4POL
	Metal	4x socket M12, 5-pin	549367	CPX-M-AB-4-M12X2-5POL
Cold junction compensation				
	PT1000 temperature sensor for cold junction compensation	553596	CPX-W-PT1000	
Plug				
	Plug M12, 5-pin	175487	SEA-M12-5GS-PG7	
Cover				
	Cover for CPX-AB-8-KL-4POL (IP65, IP67)	538219	AK-8KL	
	<ul style="list-style-type: none"> <li>• 8 cable through feeds M9</li> <li>• 1 cable through feed for multi-pin plug</li> </ul> Fittings kit	538220	VG-K-M9	
Screening plate				
	Screening plate for M12 connections	526184	CPX-AB-S-4-M12	
User documentation				
	User documentation	German	526415	P.BE-CPX-AX-DE
		English	526416	P.BE-CPX-AX-EN
		Spanish	526417	P.BE-CPX-AX-ES
		French	526418	P.BE-CPX-AX-FR
		Italian	526419	P.BE-CPX-AX-IT

## Data sheet – Output module, analogue

### Function

Analogue modules control devices with a standard analogue interface such as proportional valves, etc.

Depending on the connection block selected, the analogue module supports various connection concepts with different numbers of sockets or terminals.

### Area of application

- Analogue module for 0 ... 10 V, 0 ... 20 mA or 4 ... 20 mA
- Supports connection blocks with Sub-D, terminal connection and M12 connection
- Analogue module features can be parameterised
- Different data formats available
- Operation with and without galvanic isolation possible
- The analogue module receives the voltage supply for the electronics and the actuators from the interlinking block
- Analogue module protection and diagnostics through integrated electronic fuse protection



General technical data			
Type		CPX-2AA-U-I	
		Voltage output	Current output
Number of analogue outputs		2	
Max. actuator supply per module [A]		2.8	
Fuse protection		Internal electronic fuse for actuator supply	
Current consumption from 24 V sensor supply (at full load) [mA]		Max. 150	
Current consumption from 24 V actuator supply (at full load) [A]		4 ... 10	
Supply voltage for actuators [V DC]		24 ±25%	
Signal range (parameterisable for each channel with DIL switch or software)		0 ... 10 V DC	0 ... 20 mA 4 ... 20 mA
Resolution [bit]		12	
Number of units		4096	
Absolute accuracy [%]		±0.6	
Linearity errors (no software scaling) [%]		±0.1	
Repetition accuracy (at 25°C) [%]		0.05	
Encoder selection	Load resistance for ohmic load [kΩ]	Min. 1	Max. 0.5
	Load resistance for capacitive load [μF]	Max. 1	–
	Load resistance for inductive load [mH]	–	Max. 1
	Short circuit protection for analogue output	Yes	–
	Short circuit current of analogue output [mA]	Approx. 20	–
	Open circuit voltage [V DC]	–	18
	Destruction limit against externally applied voltage [V DC]	15	
	Actuator connection	2 wires	
Cycle time (module) [ms]	≤ 4		

## Data sheet – Output module, analogue

General technical data			CPX-2AA-U-I	
Type			Voltage output	Current output
Response time	For ohmic load	[ms]	0.1	0.1
	For capacitive load	[ms]	0.7	–
	For inductive load	[ms]	–	0.5
Data format	15 bits + prefix, linear scaling 12 bits right-justified 12 bits left-justified, S7 compatible 12 bits left-justified, S5 compatible			
Cable length	[m]	Max. 30 (shielded)		
LED displays	Group diagnostics	1		
	Channel diagnostics	Yes, via flashing frequency of group diagnostics		
Diagnostics	<ul style="list-style-type: none"> <li>• Short circuit/overload, actuator supply</li> <li>• Parameterisation error</li> <li>• Value falling below nominal range/full-scale value</li> <li>• Value exceeding nominal range/full-scale value</li> <li>• Wire break</li> </ul>			
Parameterisation	<ul style="list-style-type: none"> <li>• Short circuit monitoring, actuator supply</li> <li>• Short circuit monitoring, analogue output</li> <li>• Behaviour after short circuit, actuator supply</li> <li>• Data format</li> <li>• Lower limit value/full-scale value</li> <li>• Upper limit value/full-scale value</li> <li>• Monitoring value falling below nominal range/full-scale value</li> <li>• Monitoring value exceeding nominal range/full-scale value</li> <li>• Monitoring wire break</li> <li>• Signal range</li> </ul>			
Degree of protection to EN 60529	Depending on connection block			
Temperature range	Operation	[°C]	–5 ... +50	
	Storage/transport	[°C]	–20 ... +70	
Materials	Reinforced PA, PC			
Grid dimension	[mm]	50		
Dimensions (including interlinking block and connection block) W x L x H	[mm]	50 x 107 x 50		
Product weight	[g]	49		

## Connection and display components

CPX-2AA-U-I

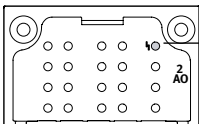

[1] Error LED (red; module error)

## Combinations of connection blocks and analogue module

Connection blocks	Part no.	Analogue module
		CPX-2AA-U-I
CPX-AB-4-M12X2-5POL	195704	■
CPX-AB-4-M12X2-5POL-R	541254	■
CPX-AB-8-KL-4POL	195708	■
CPX-AB-1-SUB-BU-25POL	525676	■
CPX-M-AB-4-M12X2-5POL	549367	■

## Data sheet – Output module, analogue

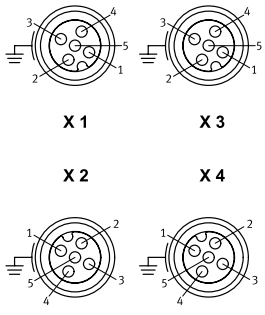
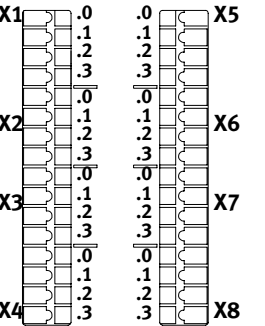
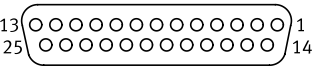



Pin allocation		CPX-2AA-U-I
Connection block outputs		
<b>CPX-AB-4-M12X2-5POL, CPX-AB-4-M12X2-5POL-R<sup>1)</sup>, CPX-M-AB-4-M12X2-5POL</b>		
 <p><b>X 1</b>      <b>X 3</b></p> <p><b>X 2</b>      <b>X 4</b></p>	<p>X1.1: 24 V<sub>OUT</sub></p> <p>X1.2: Output U0+</p> <p>X1.3: 0 V<sub>OUT</sub></p> <p>X1.4: Output GND</p> <p>X1.5: FE<sup>2)</sup></p> <p>X2.1: 24 V<sub>OUT</sub></p> <p>X2.2: Output I0+</p> <p>X2.3: 0 V<sub>OUT</sub></p> <p>X2.4: Output GND</p> <p>X2.5: FE<sup>2)</sup></p>	<p>X3.1: 24 V<sub>OUT</sub></p> <p>X3.2: Output U1+</p> <p>X3.3: 0 V<sub>OUT</sub></p> <p>X3.4: Output GND</p> <p>X3.5: FE<sup>2)</sup></p> <p>X4.1: 24 V<sub>OUT</sub></p> <p>X4.2: Output I1+</p> <p>X4.3: 0 V<sub>OUT</sub></p> <p>X4.4: Output GND</p> <p>X4.5: FE<sup>2)</sup></p>
<b>CPX-AB-8-KL-4POL</b>		
 <p><b>X1</b>    .0    .0    <b>X5</b></p> <p>      .1    .1   </p> <p>      .2    .2   </p> <p>      .3    .3   </p> <p><b>X2</b>    .0    .0    <b>X6</b></p> <p>      .1    .1   </p> <p>      .2    .2   </p> <p>      .3    .3   </p> <p><b>X3</b>    .0    .0    <b>X7</b></p> <p>      .1    .1   </p> <p>      .2    .2   </p> <p>      .3    .3   </p> <p><b>X4</b>    .0    .0    <b>X8</b></p> <p>      .1    .1   </p> <p>      .2    .2   </p> <p>      .3    .3   </p>	<p>X1.0: 24 V<sub>OUT</sub></p> <p>X1.1: 0 V<sub>OUT</sub></p> <p>X1.2: Output GND</p> <p>X1.3: FE</p> <p>X2.0: n.c.</p> <p>X2.1: n.c.</p> <p>X2.2: Output U0+</p> <p>X2.3: FE</p> <p>X3.0: 24 V<sub>OUT</sub></p> <p>X3.1: 0 V<sub>OUT</sub></p> <p>X3.2: Output GDN</p> <p>X3.3: FE</p> <p>X4.0: n.c.</p> <p>X4.1: n.c.</p> <p>X4.2: Output I0+</p> <p>X4.3: FE</p>	<p>X5.0: 24 V<sub>OUT</sub></p> <p>X5.1: 0 V<sub>OUT</sub></p> <p>X5.2: Output GND</p> <p>X5.3: FE</p> <p>X6.0: n.c.</p> <p>X6.1: n.c.</p> <p>X6.2: Output U1+</p> <p>X6.3: FE</p> <p>X7.0: 24 V<sub>OUT</sub></p> <p>X7.1: 0 V<sub>OUT</sub></p> <p>X7.2: Output GND</p> <p>X7.3: FE</p> <p>X8.0: n.c.</p> <p>X8.1: n.c.</p> <p>X8.2: Output I1+</p> <p>X8.3: FE</p>
<b>CPX-AB-1-SUB-BU-25POL</b>		
	<p>1: Output GND</p> <p>2: Output U0+</p> <p>3: Output GND</p> <p>4: Output I0+</p> <p>5: n.c.</p> <p>6: n.c.</p> <p>7: n.c.</p> <p>8: n.c.</p> <p>9: 24 V<sub>OUT</sub></p> <p>10: 24 V<sub>OUT</sub></p> <p>11: 0 V<sub>OUT</sub></p> <p>12: 0 V<sub>OUT</sub></p> <p>13: Shielding<sup>3)</sup></p>	<p>14: Output GND</p> <p>15: Output U1+</p> <p>16: Output GND</p> <p>17: Output I1+</p> <p>18: 24 V<sub>OUT</sub></p> <p>19: n.c.</p> <p>20: 24 V<sub>OUT</sub></p> <p>21: n.c.</p> <p>22: 0 V<sub>OUT</sub></p> <p>23: 0 V<sub>OUT</sub></p> <p>24: 0 V<sub>OUT</sub></p> <p>25: FE</p> <p>Housing: FE</p>

1) Speedcon quick lock, additional shielding on metal thread

2) FE/shield additionally on metal thread

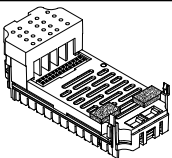
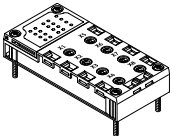
3) Connect shield to functional earth FE

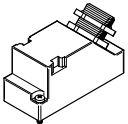
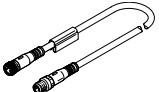
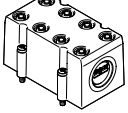
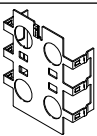
## Data sheet – Output module, analogue

Ordering data		Part no.	Type
Designation			
Output module, analogue			
	2 analogue current or voltage outputs	526170	CPX-2AA-U-I
Connection block			
	Plastic	4x socket M12, 5-pin	195704 CPX-AB-4-M12X2-5POL
		4x socket, M12 with quick-lock technology, 5-pin	541254 CPX-AB-4-M12X2-5POL-R
		Spring-loaded terminal, 32-pin	195708 CPX-AB-8-KL-4POL
	Metal	1x socket, Sub-D, 25-pin	525676 CPX-AB-1-SUB-BU-25POL
		4x socket M12, 5-pin	549367 CPX-M-AB-4-M12X2-5POL
Plug			
	Plug M12, 5-pin	175487	SEA-M12-5GS-PG7
	Sub-D plug, 25-pin	527522	SD-SUB-D-ST25
Connecting cable			
	Modular system for a choice of connecting cables	–	NEBU-... → Internet: nebu
Cover			
	Cover for CPX-AB-8-KL-4POL (IP65, IP67)	538219	AK-8KL
	<ul style="list-style-type: none"> <li>• 8 cable through feeds M9</li> <li>• 1 cable through feed for multi-pin plug</li> </ul> Fittings kit	538220	VG-K-M9
Screening plate			
	Screening plate for M12 connections	526184	CPX-AB-S-4-M12
User documentation			
	User documentation	German	526415 P.BE-CPX-AX-DE
		English	526416 P.BE-CPX-AX-EN
		Spanish	526417 P.BE-CPX-AX-ES
		French	526418 P.BE-CPX-AX-FR
		Italian	526419 P.BE-CPX-AX-IT



## Data sheet – PROFI-safe shut-off module

### Function

The PROFI-safe shut-off module interrupts the contact rails of the interlinking block for valves and outputs. The supply voltage for valves can be switched by the module within the CPX terminal and via a connection block to two consuming devices. Actuation takes place via the bus node (PROFINET) of the CPX terminal.

### Area of application

- Output module for 24 V DC supply voltage
- Shut-off module for supply voltage for valves
- Can only be used with PROFINET or PROFIBUS bus nodes
- The shut-off module is supplied with voltage for the electronics and the outputs by the interlinking block
- The outputs are supplied from the power supply for valves ( $V_{\text{Valves}}$ )

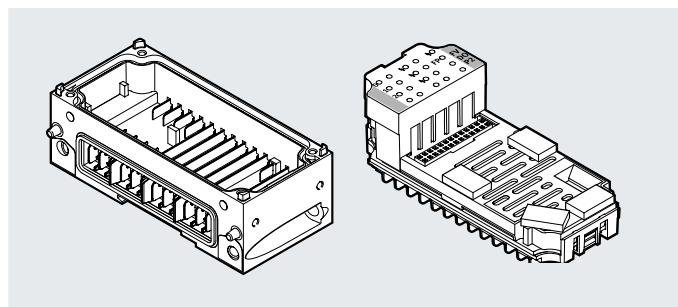

General technical data			CPX-FVDA-P2
Type			CPX-FVDA-P2
Number of outputs			2
Note on outputs			1 internal channel for switching off the supply voltage for valves 2 external outputs
Max. address capacity	Inputs	[B]	6
	Outputs	[B]	6
Maximum cable length			200
Max. power supply	Per module	[A]	5
	Per channel	[A]	1.5
Fuse protection (short circuit)			Internal electronic fuse per channel
Current consumption of module			Typically 65 (power supply for valves)
			Typically 25 (power supply for electronics)
Operating voltage	Nominal value	[V DC]	24
	Permissible range	[V DC]	20.4 ... 28.8
Voltage drop per channel			0.6
Residual ripple			2 within voltage range
Load capacity to FE			400
Max. response time to shut-off command			23
Galvanic isolation	Channel – channel		No
	Channel – internal bus		Yes, with intermediate supply
Switching logic	Outputs		P-M switching
Safety integrity level			Safe switch-off, SIL3
Performance Level			Safe switch-off/category 3, Performance Level e
Failure rate per hour (PFH)			$1.0 \times 10^{-9}$
Certificate issuing authority			01/205/50294/13
LED displays	Group diagnostics		1
	Channel diagnostics		3
	Channel status		3
	Failsafe protocol active		1
Diagnostics			<ul style="list-style-type: none"> <li>• Short circuit/overload per channel</li> <li>• Undervoltage of valves</li> <li>• Cross circuit</li> <li>• Wire break per channel</li> </ul>
Parameterisation			<ul style="list-style-type: none"> <li>• Monitoring of wire break per channel</li> <li>• Diagnostic behaviour</li> </ul>
Degree of protection to EN 60529			Depending on connection block
Grid dimension	[mm]		50
Dimensions (including interlinking block and connection block) W x L x H	[mm]		50 x 107 x 55
Product weight	[g]		50

## Data sheet – PROFIsafe shut-off module

Materials		
Housing		Reinforced PA, PC
Note on materials		RoHS-compliant
Operating and environmental conditions		
Ambient temperature	[°C]	-5 ... +50
Storage temperature	[°C]	-20 ... +70
CE marking (see declaration of conformity)		To EU Machinery Directive
Certification		c UL us - Recognized (OL)

### Connection and display components

CPX-FVDA-P2

[1] Status LEDs (yellow):  
 0: Supply voltage for valves  
 1: X1  
 2: X2

[2] Channel-related error LEDs (red)  
 [3] Fail-safe protocol active (green)  
 [4] Error LED (red, module error)

Combinations of bus nodes/control blocks and PROFIsafe shut-off module		
Bus node/control block	Part no.	PROFIsafe shut-off module
		CPX-FVDA-P2
CPX-FB13	195740	■
CPX-FB33	548755	■
CPX-M-FB34	548751	■
CPX-M-FB35	548749	■
CPX-FB43	8110369	■
CPX-M-FB44	8110370	■
CPX-M-FB35	8110371	■

**Note**  
 The PROFIsafe shut-off module CPX-FVDA-P2 can only be integrated as of software release 21 or release 30 (in the case of CPX-FB13).

## Data sheet – PROFIsafe shut-off module

Combinations of connection blocks and PROFIsafe shut-off module		
Connection blocks	Part no.	PROFIsafe shut-off module
		CPX-FVDA-P2
CPX-M-AB-4-M12X2-5POL	549367	■
CPX-AB-8-KL-4POL	195708	■

Pin allocation	
Connection block outputs	CPX-FVDA-P2

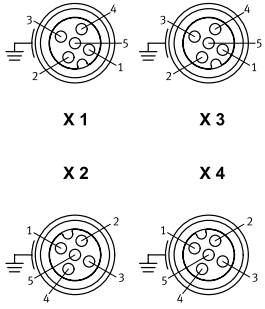
CPX-M-AB-4-M12X2-5POL		
	<p>X1.1: 0 V<sub>OUT</sub> 1 (cannot be switched off)</p> <p>X1.2: 24 V<sub>OUT</sub> 1 (cannot be switched off)</p> <p>X1.3: 0 V<sub>OUT</sub> 1 (can be switched off via fieldbus)</p> <p>X1.4: 24 V<sub>OUT</sub> 1 (can be switched off via fieldbus)</p> <p>X1.5: FE</p> <p>X2.1: 0 V<sub>OUT</sub> 2 (cannot be switched off)</p> <p>X2.2: 24 V<sub>OUT</sub> 2 (cannot be switched off)</p> <p>X2.3: 0 V<sub>OUT</sub> 2 (can be switched off via fieldbus)</p> <p>X2.4: 24 V<sub>OUT</sub> 2 (can be switched off via fieldbus)</p> <p>X2.5: FE</p>	<p>X3.1: n.c.</p> <p>X3.2: n.c.</p> <p>X3.3: n.c.</p> <p>X3.4: n.c.</p> <p>X3.5: FE</p> <p>X4.1: n.c.</p> <p>X4.2: n.c.</p> <p>X4.3: n.c.</p> <p>X4.4: n.c.</p> <p>X4.5: FE</p>

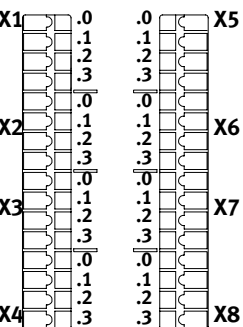
CPX-AB-8-KL-4POL		
	<p>X1.0: 0 V<sub>OUT</sub> 1 (cannot be switched off)</p> <p>X1.1: 0 V<sub>OUT</sub> 1 (can be switched off via fieldbus)</p> <p>X1.2: 24 V<sub>OUT</sub> 1 (can be switched off via fieldbus)</p> <p>X1.3: FE</p> <p>X2.0: n.c.</p> <p>X2.1: n.c.</p> <p>X2.2: 24 V<sub>OUT</sub> 1 (cannot be switched off)</p> <p>X2.3: FE</p> <p>X3.0: 0 V<sub>OUT</sub> 2 (cannot be switched off)</p> <p>X3.1: 0 V<sub>OUT</sub> 2 (can be switched off via fieldbus)</p> <p>X3.2: 24 V<sub>OUT</sub> 2 (can be switched off via fieldbus)</p> <p>X3.3: FE</p> <p>X4.0: n.c.</p> <p>X4.1: n.c.</p> <p>X4.2: 24 V<sub>OUT</sub> 2 (cannot be switched off)</p> <p>X4.3: FE</p>	<p>X5.0: n.c.</p> <p>X5.1: n.c.</p> <p>X5.2: n.c.</p> <p>X5.3: n.c.</p> <p>X6.0: n.c.</p> <p>X6.1: n.c.</p> <p>X6.2: n.c.</p> <p>X6.3: n.c.</p> <p>X7.0: n.c.</p> <p>X7.1: n.c.</p> <p>X7.2: n.c.</p> <p>X7.3: n.c.</p> <p>X8.0: n.c.</p> <p>X8.1: n.c.</p> <p>X8.2: n.c.</p> <p>X8.3: n.c.</p>



## Data sheet – PROFIsafe shut-off module

Combinations of interlinking blocks and PROFIsafe shut-off module		
Interlinking blocks	Part no.	PROFIsafe shut-off module
		CPX-FVDA-P2
CPX-GE-EV-S	195746	-
CPX-GE-EV-S-VL	8022170	-
CPX-GE-EV-S-7/8-4POL	541248	-
CPX-GE-EV-S-7/8-5POL	541244	-
CPX-GE-EV-S-7/8-5POL-VL	8022172	-
CPX-M-GE-EV-S-7/8-CIP-4P	568956	-
CPX-M-GE-EV-S-7/8-5POL	550208	-
CPX-M-GE-EV-S-7/8-5POL-VL	8022165	-
CPX-M-GE-EV-S-M12-5POL	8098392	-
CPX-M-GE-EV-S-PP-5POL	563057	-
CPX-GE-EV	195742	-
CPX-M-GE-EV	550206	-
CPX-M-GE-EV-FVO	567806	■
CPX-GE-EV-Z	195744	-
CPX-GE-EV-Z-VL	8022166	-
CPX-GE-EV-Z-7/8-4POL	541250	-
CPX-GE-EV-Z-7/8-5POL	541246	-
CPX-GE-EV-Z-7/8-5POL-VL	8022173	-
CPX-M-GE-EV-Z-7/8-5POL	550210	-
CPX-M-GE-EV-Z-7/8-5POL-VL	8022158	-
CPX-M-GE-EV-Z-PP-5POL	563058	-
CPX-GE-EV-V	533577	-
CPX-GE-EV-V-VL	8022171	-
CPX-GE-EV-V-7/8-4POL	541252	-
CPX-M-GE-EV-W-M12-5POL	8098391	-

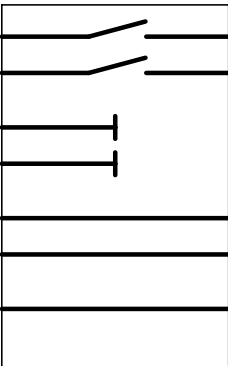
General technical data		
Type		CPX-M-GE-EV-FVO
Nominal operating voltage	[V DC]	24
Acceptable current load (per contact/contact rail)	[A]	16
Degree of protection to EN 60529		Depending on connection block
Ambient temperature	[°C]	-5 ... +50
Note on materials		RoHS-compliant
Materials		Die-cast aluminium
Type of mounting		Angled fitting
Grid dimension	[mm]	50
Dimensions W x L x H	[mm]	50 x 107 x 35
Product weight	[g]	170

Pin allocation			
Circuitry		Pin	Allocation
 <p>0V Valves 24V Valves 0V Output 24V Output 0V El./Sen. 24V El./Sen. FE</p>		-	-
		-	-
		-	-
		-	-
		-	-
		-	-

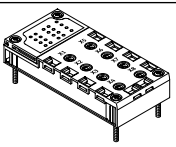
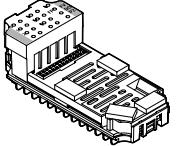
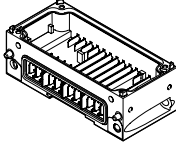
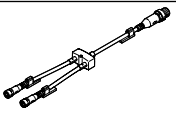
## Data sheet – PROFIsafe shut-off module

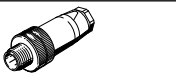
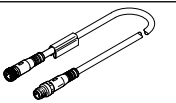
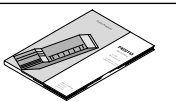
Ordering data		Description	Part no.	Type
<b>PROFIsafe shut-off module</b>				
	Metal connection block	4x socket, M12, 5-pin	<b>549367</b>	<b>CPX-M-AB-4-M12X2-5POL</b>
	Plastic connection block	Spring-loaded terminal, 32-pin	<b>195708</b>	<b>CPX-AB-8-KL-4POL</b>
	Electronics module (can only be used with CPX-M-GE-EV-FVO)	PROFINET, PROFIBUS	<b>1971599</b>	<b>CPX-FVDA-P2</b>
	Metal interlinking block (for CPX-FVDA-P2 only)		<b>567806</b>	<b>CPX-M-GE-EV-FVO</b>
<b>Distributor</b>				
	Modular system for all types of sensor/actuator distributor		–	<b>NEDY...</b> → Internet: nedy
	1x plug M12, 4-pin	2x socket M12, 5-pin	<b>8005310</b>	<b>NEDY-L2R1-V1-M12G5-N-M12G4</b>
<b>Plug</b>				
	Plug	M12, PG7	<b>18666</b>	<b>SEA-GS-7</b>
		M12, PG7, 4-pin for cable $\varnothing$ 2.5 mm	<b>192008</b>	<b>SEA-4GS-7-2.5</b>
		M12, PG9	<b>18778</b>	<b>SEA-GS-9</b>
		M12 for 2 cables	<b>18779</b>	<b>SEA-GS-11-DUO</b>
		M12 for 2 cables, 5-pin	<b>192010</b>	<b>SEA-5GS-11-DUO</b>
M12, 5-pin	<b>175487</b>	<b>SEA-M12-5GS-PG7</b>		
<b>Connecting cable</b>				
	Modular system for a choice of connecting cables		–	<b>NEBU...</b> → Internet: nebu
<b>User documentation</b>				
	User documentation for PROFIsafe shut-off module	German	<b>8022606</b>	<b>CPX-FVDA-P2-DE</b>
		English	<b>8022607</b>	<b>CPX-FVDA-P2-EN</b>
		Spanish	<b>8022608</b>	<b>CPX-FVDA-P2-ES</b>
		French	<b>8022609</b>	<b>CPX-FVDA-P2-FR</b>
		Italian	<b>8022610</b>	<b>CPX-FVDA-P2-IT</b>
		Chinese	<b>8022611</b>	<b>CPX-FVDA-P2-ZH</b>

## Data sheet – End plate with system supply

### Function

End plates form the outer edge of the CPX terminal.

The earth connection and mounting holes for wall or H-rail mounting are located on the left-hand end plate.

The end plate with system supply has contact rails from which the other CPX components on the interlinking modules are supplied with power.

### Area of application

- 24 V DC supply voltage for the electronics of the CPX terminal
- 24 V DC supply voltage for inputs
- 24 V DC supply voltage for valves
- 24 V DC supply voltage for outputs

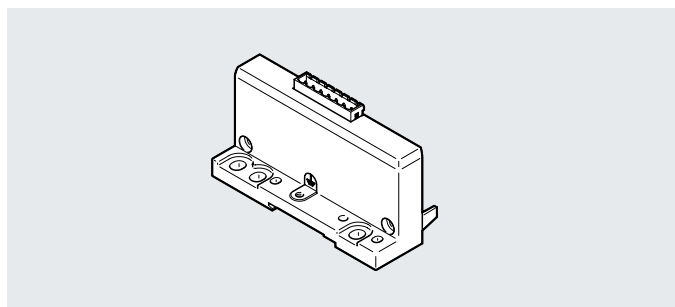

General technical data		
Electrical connection		Plug, 7-pin
Type of mounting		Tie rods
Power supply		System supply
Maximum power supply	[A]	12
Product weight	[g]	145

Materials	
Housing	Die-cast aluminium, painted
Note on materials	RoHS-compliant

Operating and environmental conditions	
Certification	c UL us - Recognized (OL)

Pin allocation		
Circuitry	Pin	Allocation
<b>Plug, 7-pin</b>		
	[1]	0 V power supply for valves
	[2]	24 V DC load voltage supply for valves
	[3]	0 V power supply for outputs
	[4]	24 V DC load voltage supply for outputs
	[5]	0 V power supply for electronics and sensors
	[6]	24 V DC power supply for electronics and sensors
	[7]	FE

## Data sheet – End plate with system supply

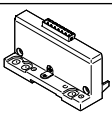
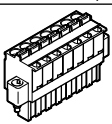
Ordering data		Part no.	Type
End plate with system supply			
	End plate for CPX terminal in plastic design	576315	CPX-EPL-EV-S
Terminal strip			
	Plug, 7-pin, straight	Spring-loaded terminal 576319	NECU-L3G7-C1

## Data sheet – End plate with extension

### Function

End plates form the outer edge of the CPX terminal.  
 The earth connection and mounting holes for wall or H-rail mounting are located on the left-hand end plates.  
 The end plates with extension enable the CPX terminal to be separated into two interconnected terminals. Control is provided via a common bus node or control block.

### Area of application

- Separation of long CPX terminals into two shorter units
- Adaptation for installation in a control cabinet

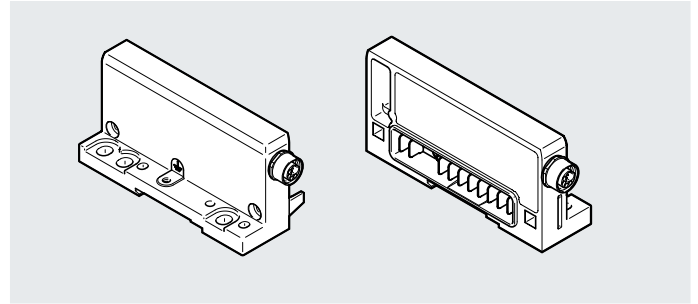

General technical data		
Type	CPX-EP..	CPX-M-EP..
Type of mounting	Tie rods	Angled fitting
Maximum power supply	[A] 6	6
Materials		
Type	CPX-EP..	CPX-M-EP..
Housing	Die-cast aluminium, painted	Die-cast aluminium
Note on materials	RoHS-compliant	RoHS-compliant
Operating and environmental conditions		
Certification	c UL us - Recognized (OL)	



## Data sheet – End plate with extension

Pin allocation – End plate with extension				
Circuitry	Pin	Allocation	Pin	Circuitry
<b>Right-hand end plate (first row)</b>	<b>Round plug, 8-pin</b>			<b>Left-hand end plate (second row)</b>
	M12			
	1	0 V DC supply voltage for electronics and sensors	1	
	2	0 V DC load voltage supply for valves	2	
	3	24 V DC load voltage supply for valves	3	
	4	24 V DC power supply for electronics and sensors	4	
	5	Bus signal	5	
	6	Bus signal	6	
	7	Bus signal	7	
	8	Bus signal	8	
	Housing	FE	Housing	

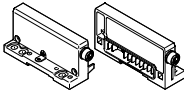
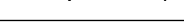
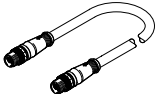
Ordering data					
			Weight [g]	Part no.	Type
End plate with extension					
	For CPX terminal in plastic design	First row, right-hand end plate	190	<b>576313</b>	<b>CPX-EPR-EV-X</b>
		Second row, left-hand end plate	175	<b>576314</b>	<b>CPX-EPL-EV-X</b>
	For CPX terminal in metal design	First row, right-hand end plate	190	<b>576316</b>	<b>CPX-M-EPR-EV-X</b>
		Second row, left-hand end plate	175	<b>576317</b>	<b>CPX-M-EPL-EV-X</b>
Connecting cable					
	8-pin	0.25 m	47	<b>564189</b>	<b>NEBC-F12G8-KH-0.25-N-S-F12G8</b>
		0.5 m	69	<b>564190</b>	<b>NEBC-F12G8-KH-0.5-N-S-F12G8</b>
		1 m	113	<b>564191</b>	<b>NEBC-F12G8-KH-1-N-S-F12G8</b>
		1.5 m	154	<b>564192</b>	<b>NEBC-F12G8-KH-1.5-N-S-F12G8</b>
		2 m	200	<b>576015</b>	<b>NEBC-F12G8-KH-2-N-S-F12G8</b>
		3 m	280	<b>576636</b>	<b>NEBC-F12G8-KH-3-N-S-F12G8</b>

## Data sheet – Interlinking block with system supply

### Function

Interlinking blocks ensure the electrical supply of all other CPX modules. They have contact rails, from which the other CPX components on the interlinking modules are supplied with power. Internal division of the power supply makes it possible to switch off specific areas of the sensors and actuators individually.

### Area of application

- 24 V DC supply voltage for the electronics of the CPX terminal
- 24 V DC supply voltage for inputs
- 24 V DC supply voltage for valves
- 24 V DC supply voltage for outputs



General technical data		
Nominal operating voltage	[V DC]	24
Degree of protection to EN 60529		Depending on connection block
Ambient temperature	[°C]	-5 ... +50
Note on materials		RoHS-compliant
Grid dimension	[mm]	50
Dimensions W x L x H	[mm]	50 x 107 x 35

Technical data – Plastic interlinking blocks		CPX-GE-EV-S				
Type			-VL	-7/8-4POL	-7/8-5POL	-7/8-5POL-VL
Electrical connection		M18	M18	7/8", 4-pin	7/8", 5-pin	7/8", 5-pin
Power supply	Sensors and electronics [A]	Max. 16	Max. 8	Max. 10	Max. 8	Max. 8
	Valves and outputs [A]	Max. 16	Max. 8	Max. 10	Max. 8	Max. 8
Corrosion resistance class (CRC)		1				
Type of mounting		Tie rods				
Materials		PA-reinforced				
Product weight	[g]	125				

1) Corrosion resistance class CRC 1 to Festo standard FN 940070  
 Low corrosion stress. Dry indoor application or transport and storage protection. Also applies to parts behind coverings, in the non-visible interior area, and parts which are covered in the application (e.g. drive trunnions).

## Data sheet – Interlinking block with system supply

Technical data – Metal interlinking blocks		CPX-M-GE-EV-S				
		-7/8-CIP-4P	-7/8-5POL	-M12-5POL	-7/8-5POL-VL	-PP-5POL
Type						
Electrical connection		7/8", 4-pin	7/8", 5-pin	Plug	7/8", 5-pin	AIDA push-pull, 5-pin
				M12x1		
				5-pin		
				L-coded		
Power supply	Sensors and electronics [A]	Max. 10	Max. 8	Max. 16	Max. 8	Max. 16
	Valves and outputs [A]	Max. 10	Max. 8	Max. 16	Max. 8	Max. 16
Corrosion resistance class (CRC)		0				
Type of mounting		Angled fitting				
Materials		Die-cast aluminium				
Certification		–	–	c UL - Recognized (OL)	–	–
Product weight [g]		187	187	266	187	279

1) Corrosion resistance class CRC 0 to Festo standard FN 940070

No corrosion stress. Applies to small, visually unimportant standards-based parts such as threaded pins, circlips and clamping sleeves which are usually only available on the market in a phosphated or burnished version (and possibly oiled) as well as to ball bearings (for components < CRC 3) and plain bearings.

**Note**



Points to note about the interlinking block CPX-M-GE-EV-S-7/8-CIP-4P:

- Must be mounted as the first module to the right of the left-hand end plate
- The functional earth (FE) must be connected via the left-hand end plate
- Only permitted as an interlinking block to a bus node

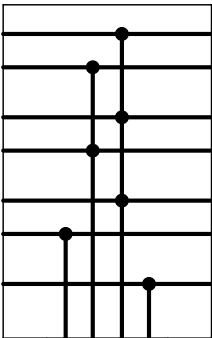
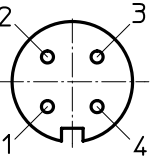
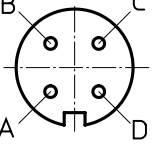
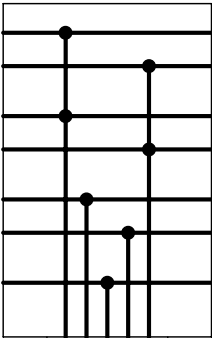
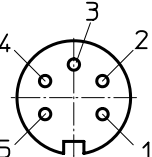
Data sheet – Interlinking block with system supply

Pin allocation – Plastic interlinking blocks		Pin	Allocation																							
Circuitry																										
<b>Round plug, 4-pin</b>																										
	<b>0V</b> Valves <b>24V</b> Valves <b>0V</b> Output <b>24V</b> Output <b>0V</b> El./Sen. <b>24V</b> El./Sen. <b>FE</b>		<table border="1"> <tr> <td>1</td> <td>24 V DC power supply for electronics and sensors</td> </tr> <tr> <td>2</td> <td>24 V DC load voltage supply for valves and outputs</td> </tr> <tr> <td>3</td> <td>0 V</td> </tr> <tr> <td>4</td> <td>FE</td> </tr> </table>	1	24 V DC power supply for electronics and sensors	2	24 V DC load voltage supply for valves and outputs	3	0 V	4	FE															
	1	24 V DC power supply for electronics and sensors																								
2	24 V DC load voltage supply for valves and outputs																									
3	0 V																									
4	FE																									
<table border="1"> <tr> <td><b>M18</b></td> <td>1</td> <td>2</td> <td>3</td> <td>4</td> </tr> <tr> <td><b>7/8"</b></td> <td>A</td> <td>B</td> <td>D</td> <td>C</td> </tr> <tr> <td></td> <td>24V</td> <td>24V</td> <td>0V</td> <td>FE</td> </tr> </table>	<b>M18</b>	1	2	3	4	<b>7/8"</b>	A	B	D	C		24V	24V	0V	FE			<table border="1"> <tr> <td>A</td> <td>24 V DC supply voltage for electronics and sensors</td> </tr> <tr> <td>B</td> <td>24 V DC load voltage supply for valves and outputs</td> </tr> <tr> <td>C</td> <td>FE</td> </tr> <tr> <td>D</td> <td>0V</td> </tr> </table>	A	24 V DC supply voltage for electronics and sensors	B	24 V DC load voltage supply for valves and outputs	C	FE	D	0V
<b>M18</b>	1	2	3	4																						
<b>7/8"</b>	A	B	D	C																						
	24V	24V	0V	FE																						
A	24 V DC supply voltage for electronics and sensors																									
B	24 V DC load voltage supply for valves and outputs																									
C	FE																									
D	0V																									
<b>Round plug, 5-pin</b>																										
	<b>0V</b> Valves <b>24V</b> Valves <b>0V</b> Output <b>24V</b> Output <b>0V</b> El./Sen. <b>24V</b> El./Sen. <b>FE</b>		<table border="1"> <tr> <td>1</td> <td>0 V valves and outputs</td> </tr> <tr> <td>2</td> <td>0 V electronics and sensors</td> </tr> <tr> <td>3</td> <td>FE</td> </tr> <tr> <td>4</td> <td>24 V DC power supply for electronics and sensors</td> </tr> <tr> <td>5</td> <td>24 V DC load voltage supply for valves and outputs</td> </tr> </table>	1	0 V valves and outputs	2	0 V electronics and sensors	3	FE	4	24 V DC power supply for electronics and sensors	5	24 V DC load voltage supply for valves and outputs													
	1	0 V valves and outputs																								
2	0 V electronics and sensors																									
3	FE																									
4	24 V DC power supply for electronics and sensors																									
5	24 V DC load voltage supply for valves and outputs																									
<table border="1"> <tr> <td><b>7/8"</b></td> <td>1</td> <td>2</td> <td>3</td> <td>4</td> <td>5</td> </tr> <tr> <td></td> <td>0V</td> <td>0V</td> <td>FE</td> <td>24V</td> <td>24V</td> </tr> </table>	<b>7/8"</b>	1	2	3	4	5		0V	0V	FE	24V	24V														
<b>7/8"</b>	1	2	3	4	5																					
	0V	0V	FE	24V	24V																					

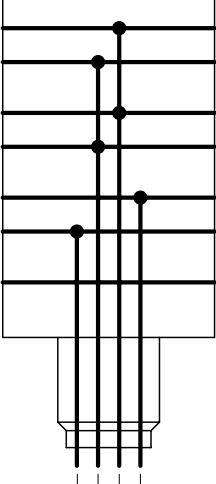
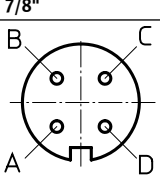

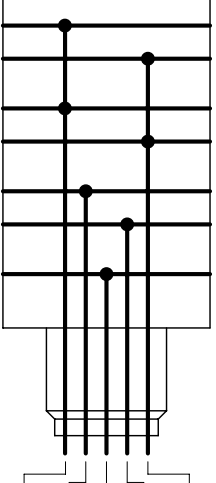
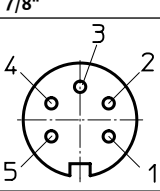
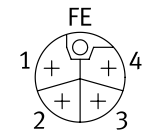
### Data sheet – Interlinking block with system supply

Pin allocation – Metal interlinking blocks		Pin	Allocation																		
Circuitry																					
<b>Round plug, 4-pin</b>																					
 <p>0V Valves 24V Valves 0V Output 24V Output 0V El./Sen. 24V El./Sen. FE</p>	 <p>7/8"</p>	A	24 V DC supply voltage for electronics and sensors																		
		B	24 V DC load voltage supply for valves and outputs																		
		C	0 V DC supply voltage for electronics and sensors																		
		D	0 V DC load voltage supply for valves and outputs																		
		 <b>Note</b> The functional earth (FE) must be connected via the left-hand end plate.																			
<table border="1" data-bbox="151 884 391 940"> <tr> <td>7/8"</td> <td>A</td> <td>B</td> <td>D</td> <td>C</td> </tr> <tr> <td></td> <td>24V</td> <td>24V</td> <td>0V</td> <td>0V</td> </tr> </table>	7/8"	A	B	D	C		24V	24V	0V	0V											
7/8"	A	B	D	C																	
	24V	24V	0V	0V																	
<b>Round plug, 5-pin</b>																					
 <p>0V Valves 24V Valves 0V Output 24V Output 0V El./Sen. 24V El./Sen. FE</p>	 <p>7/8"</p>	1	0 V valves and outputs																		
		2	0 V electronics and sensors																		
		3	FE																		
		4	24 V DC power supply for electronics and sensors																		
		5	24 V DC load voltage supply for valves and outputs																		
		<b>M12</b>																			
		1	24 V DC power supply for electronics and sensors																		
		2	0 V valves and outputs																		
		3	0 V electronics and sensors																		
		4	24 V DC load voltage supply for valves and outputs																		
		FE	FE																		
<table border="1" data-bbox="127 1512 406 1590"> <tr> <td>7/8"</td> <td>1</td> <td>2</td> <td>3</td> <td>4</td> <td>5</td> </tr> <tr> <td>M12</td> <td>2</td> <td>3</td> <td>5</td> <td>1</td> <td>4</td> </tr> <tr> <td></td> <td>0V</td> <td>0V</td> <td>FE</td> <td>24V</td> <td>24V</td> </tr> </table>	7/8"	1	2	3	4	5	M12	2	3	5	1	4		0V	0V	FE	24V	24V			
7/8"	1	2	3	4	5																
M12	2	3	5	1	4																
	0V	0V	FE	24V	24V																

## Data sheet – Interlinking block with system supply

Pin allocation – Metal interlinking blocks		Pin	Allocation												
Circuitry															
<b>5-pin push-pull plug</b>															
	<b>Plug pattern to PROFINET specification</b>														
		1	24 V DC power supply for electronics and sensors												
	2	0 V electronics and sensors													
	3	24 V DC load voltage supply for valves and outputs													
	4	0 V valves and outputs													
	5	FE													
<table border="1"> <tr> <td>PP</td> <td>1</td> <td>2</td> <td>3</td> <td>4</td> <td>5</td> </tr> <tr> <td></td> <td>24V</td> <td>0V</td> <td>24V</td> <td>0V</td> <td>FE</td> </tr> </table>	PP	1	2	3	4	5		24V	0V	24V	0V	FE			
PP	1	2	3	4	5										
	24V	0V	24V	0V	FE										

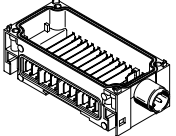
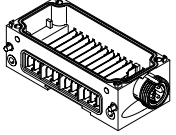
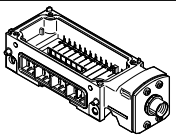
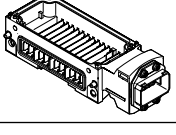
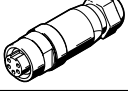
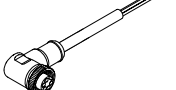
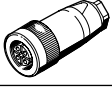
## Data sheet – Interlinking block with system supply

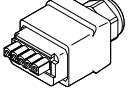
Ordering data				Part no.	Type
Designation					
Interlinking block with system supply					
	M18 connection, plastic interlinking block	4-pin	–	195746	CPX-GE-EV-S
			For ATEX environment	8022170	CPX-GE-EV-S-VL
	7/8" connection, plastic interlinking block	4-pin	–	541248	CPX-GE-EV-S-7/8-4POL
			5-pin	–	541244
	7/8" connection, metal interlinking block	4-pin	–	8022172	CPX-GE-EV-S-7/8-5POL-VL
			5-pin	–	568956
		5-pin	–	550208	CPX-M-GE-EV-S-7/8-5POL
			For ATEX environment	8022165	CPX-M-GE-EV-S-7/8-5POL-VL
	M12x1 L-coded connection, metal interlinking block	5-pin	–	8098392	CPX-M-GE-EV-S-M12-5POL
	Push-pull plug connection (AIDA), metal interlinking block	5-pin	–	563057	CPX-M-GE-EV-S-PP-5POL
Connection sockets 7/8"					
	Power supply socket	5-pin		543107	NECU-G78G5-C2
		4-pin		543108	NECU-G78G4-C2
	Angled socket, 5-pin – open cable end, 5-wire	2 m		573855	NEBU-G78W5-K-2-N-LE5
M18 connection sockets					
	Straight socket, screw terminal	4-pin	PG9	18493	NTSD-GD-9
			PG13.5	18526	NTSD-GD-13.5
	Angled socket, screw terminal	4-pin	PG9	18527	NTSD-WD-9
	Angled socket, screw terminal	4-pin	PG11	533119	NTSD-WD-11
Push-pull power supply socket					
	Socket, spring-loaded terminal, plug pattern PP, fulfils requirements to AIDA	5-pin		5195383	NECU-M-PPG5PP-C1-PN

## Data sheet – Interlinking block with system supply

Ordering data		Part no.	Type
Designation			
Mounting accessories			
	Screws for mounting the bus node/connection block on the plastic interlinking block	Bus node/metal connection block	<b>550218</b> CPX-DPT-30X32-S-4X
	Screws for mounting the bus node/connection block on the metal interlinking block	Bus node/plastic connection block	<b>550219</b> CPX-M-M3x22-4x
		Bus node/metal connection block	<b>550216</b> CPX-M-M3x22-S-4x



## Data sheet – Interlinking block without power supply

### Function

Interlinking blocks ensure the electrical supply of all other CPX modules. They have contact rails, from which the other CPX components on the interlinking modules are supplied with power. Internal division of the power supply makes it possible to switch off specific areas of the sensors and actuators individually.

### Area of application

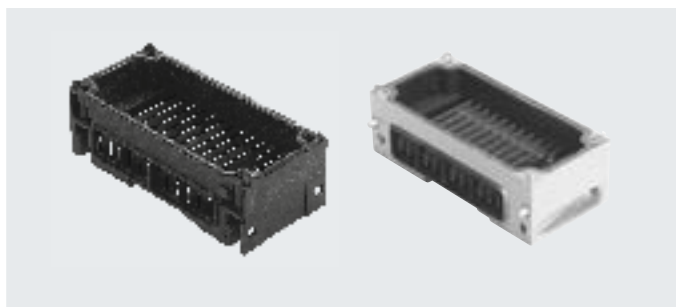

- All voltages are fed through to the next module by means of the interlinking blocks without supply.
- The connected electronics module for inputs/outputs or bus node taps off the required voltage.



General technical data		CPX-GE-EV	CPX-M-GE-EV
Type			
Electrical connection		–	–
Nominal operating voltage	[V DC]	24	24
Acceptable current load (per contact/contact rail)	[A]	16	16
Degree of protection to EN 60529		Depending on connection block	
Ambient temperature	[°C]	–5 ... +50	
Note on materials		RoHS-compliant	
Materials		PA-reinforced	Aluminium
Grid dimension	[mm]	50	
Dimensions W x L x H	[mm]	50 x 107 x 35	
Product weight	[g]	108	169

Pin allocation		Pin	Allocation
Circuitry		–	–
	<b>0V</b> Valves	–	–
	<b>24V</b> Valves	–	–
	<b>0V</b> Output	–	–
	<b>24V</b> Output	–	–
	<b>0V</b> EL./Sen.		
	<b>24V</b> EL./Sen.		
	<b>FE</b>		

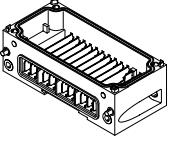
## Data sheet – Interlinking block without power supply

Ordering data		Part no.	Type
Designation			
Interlinking block without power supply			
	Plastic interlinking block	<b>195742</b>	<b>CPX-GE-EV</b>
	Metal interlinking block	<b>550206</b>	<b>CPX-M-GE-EV</b>
Mounting accessories			
	Screws for mounting the bus node/connection block on the plastic interlinking block	Bus node/metal connection block	<b>550218</b> <b>CPX-DPT-30X32-S-4X</b>
		Bus node/plastic connection block	<b>550219</b> <b>CPX-M-M3x22-4x</b>
	Screws for mounting the bus node/connection block on the metal interlinking block	Bus node/metal connection block	<b>550216</b> <b>CPX-M-M3x22-S-4x</b>

## Data sheet – Interlinking block with additional supply for outputs

**Function**

Interlinking blocks ensure the electrical supply of all other CPX modules. They have contact rails, from which the other CPX components on the interlinking modules are supplied with power. Internal division of the power supply makes it possible to switch off specific areas of the sensors and actuators individually.

**Area of application**

- 24 V DC supply voltage for outputs

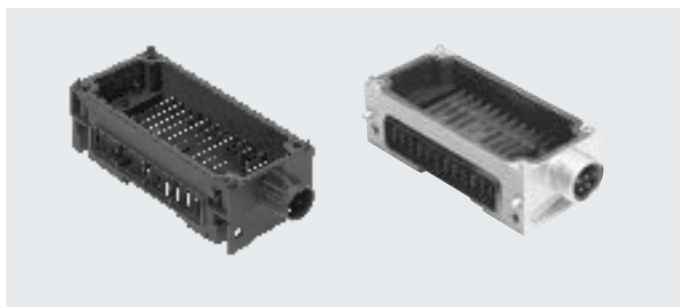

General technical data		
Nominal operating voltage	[V DC]	24
Degree of protection to EN 60529		Depending on connection block
Ambient temperature	[°C]	-5 ... +50
Note on materials		RoHS-compliant
Grid dimension	[mm]	50
Dimensions W x L x H	[mm]	50 x 107 x 35

Technical data – Plastic interlinking blocks					
Type		CPX-GE-EV-Z			
		-VL	-7/8-4POL	-7/8-5POL	-7/8-5POL-VL
Electrical connection		M18	M18	7/8", 4-pin	7/8", 5-pin
Power supply	Outputs [A]	Max. 16	Max. 8	Max. 10	Max. 8
Materials		PA-reinforced			
Product weight	[g]	125			

Technical data – Metal interlinking blocks					
Type		CPX-M-GE-EV-Z			
		-7/8-5POL	-7/8-5POL-VL	-PP-5POL	
Electrical connection		7/8", 5-pin	7/8", 5-pin	AIDA push-pull, 5-pin	
Power supply	Outputs [A]	Max. 8	Max. 8	Max. 16	
Materials		Die-cast aluminium			
Product weight	[g]	187	187	279	

Data sheet – Interlinking block with additional supply for outputs

Pin allocation – Plastic interlinking blocks

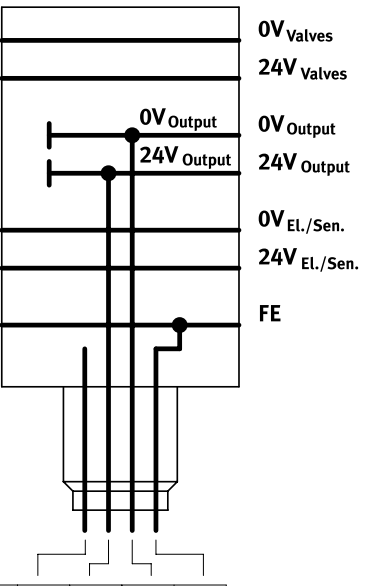
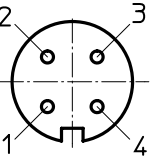
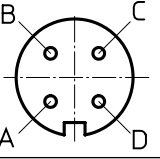

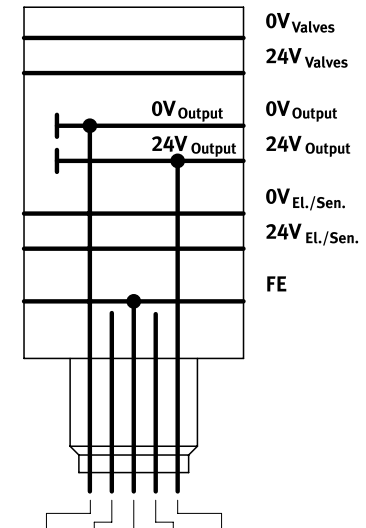
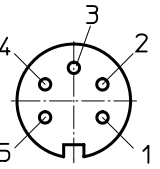
Circuitry		Pin	Allocation																							
<b>Round plug, 4-pin</b>																										
	<table border="1"> <tr> <td><b>M18</b></td> <td>1</td> <td>2</td> <td>3</td> <td>4</td> </tr> <tr> <td><b>7/8"</b></td> <td>A</td> <td>B</td> <td>D</td> <td>C</td> </tr> <tr> <td></td> <td>n.c.</td> <td>24V</td> <td>0V</td> <td>FE</td> </tr> </table>	<b>M18</b>	1	2	3	4	<b>7/8"</b>	A	B	D	C		n.c.	24V	0V	FE		<table border="1"> <tr> <td>1</td> <td>n.c.</td> </tr> <tr> <td>2</td> <td>24 V DC load voltage supply for outputs</td> </tr> <tr> <td>3</td> <td>0 V</td> </tr> <tr> <td>4</td> <td>FE</td> </tr> </table>	1	n.c.	2	24 V DC load voltage supply for outputs	3	0 V	4	FE
		<b>M18</b>	1	2	3	4																				
<b>7/8"</b>	A	B	D	C																						
	n.c.	24V	0V	FE																						
1	n.c.																									
2	24 V DC load voltage supply for outputs																									
3	0 V																									
4	FE																									
			<table border="1"> <tr> <td>A</td> <td>n.c.</td> </tr> <tr> <td>B</td> <td>24 V DC load voltage supply for outputs</td> </tr> <tr> <td>C</td> <td>FE</td> </tr> <tr> <td>D</td> <td>0V</td> </tr> </table>	A	n.c.	B	24 V DC load voltage supply for outputs	C	FE	D	0V															
A	n.c.																									
B	24 V DC load voltage supply for outputs																									
C	FE																									
D	0V																									

<b>Round plug, 5-pin</b>																									
	<table border="1"> <tr> <td><b>7/8"</b></td> <td>1</td> <td>2</td> <td>3</td> <td>4</td> <td>5</td> </tr> <tr> <td></td> <td>0V</td> <td>n.c.</td> <td>FE</td> <td>n.c.</td> <td>24V</td> </tr> </table>	<b>7/8"</b>	1	2	3	4	5		0V	n.c.	FE	n.c.	24V		<table border="1"> <tr> <td>1</td> <td>0 V outputs</td> </tr> <tr> <td>2</td> <td>n.c.</td> </tr> <tr> <td>3</td> <td>FE</td> </tr> <tr> <td>4</td> <td>n.c.</td> </tr> <tr> <td>5</td> <td>24 V DC load voltage supply for outputs</td> </tr> </table>	1	0 V outputs	2	n.c.	3	FE	4	n.c.	5	24 V DC load voltage supply for outputs
		<b>7/8"</b>	1	2	3	4	5																		
	0V	n.c.	FE	n.c.	24V																				
1	0 V outputs																								
2	n.c.																								
3	FE																								
4	n.c.																								
5	24 V DC load voltage supply for outputs																								

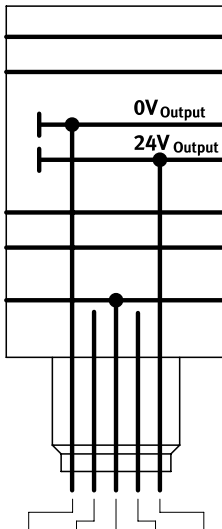
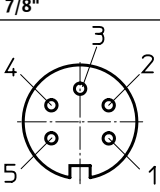
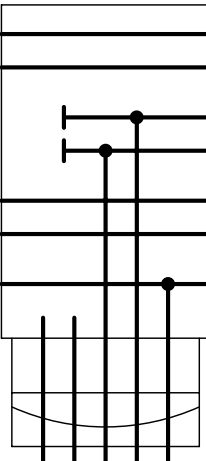
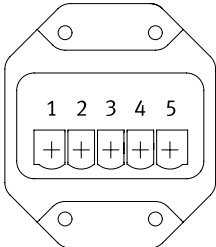
Data sheet – Interlinking block with additional supply for outputs

Pin allocation – Metal interlinking blocks		Pin	Allocation												
Circuitry															
<b>Round plug, 5-pin</b>															
		1	0 V outputs												
		2	n.c.												
		3	FE												
		4	n.c.												
		5	24 V DC load voltage supply for outputs												
<table border="1" data-bbox="127 907 422 974"> <tr> <td>7/8"</td> <td>1</td> <td>2</td> <td>3</td> <td>4</td> <td>5</td> </tr> <tr> <td></td> <td>0V</td> <td>n.c.</td> <td>FE</td> <td>n.c.</td> <td>24V</td> </tr> </table>	7/8"	1	2	3	4	5		0V	n.c.	FE	n.c.	24V			
7/8"	1	2	3	4	5										
	0V	n.c.	FE	n.c.	24V										
<b>5-pin push-pull plug</b>															
		1	n.c.												
		2	n.c.												
		3	24 V DC load voltage supply for outputs												
		4	0 V outputs												
		5	FE												
<table border="1" data-bbox="143 1545 422 1612"> <tr> <td>PP</td> <td>1</td> <td>2</td> <td>3</td> <td>4</td> <td>5</td> </tr> <tr> <td></td> <td>n.c.</td> <td>n.c.</td> <td>24V</td> <td>0V</td> <td>FE</td> </tr> </table>	PP	1	2	3	4	5		n.c.	n.c.	24V	0V	FE			
PP	1	2	3	4	5										
	n.c.	n.c.	24V	0V	FE										

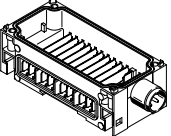
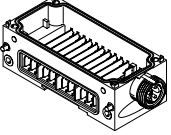
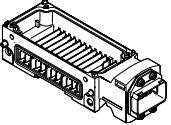
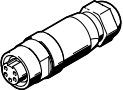
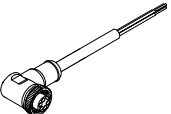
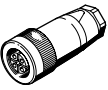
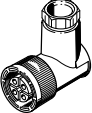
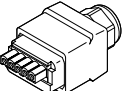
## Data sheet – Interlinking block with additional supply for outputs

Ordering data				Part no.	Type
Designation					
Interlinking block with additional supply for outputs					
	M18 connection, plastic interlinking block	4-pin	–	195744	CPX-GE-EV-Z
	M18 connection, plastic interlinking block	4-pin	For ATEX environment	8022166	CPX-GE-EV-Z-VL
	7/8" connection, plastic interlinking block	4-pin	–	541250	CPX-GE-EV-Z-7/8-4POL
		5-pin	–	541246	CPX-GE-EV-Z-7/8-5POL
		5-pin	For ATEX environment	8022173	CPX-GE-EV-Z-7/8-5POL-VL
	7/8" connection, metal interlinking block	5-pin	–	550210	CPX-M-GE-EV-Z-7/8-5POL
5-pin		For ATEX environment	8022158	CPX-M-GE-EV-Z-7/8-5POL-VL	
	Push-pull plug connection (AIDA), metal interlinking block	5-pin	–	563058	CPX-M-GE-EV-Z-PP-5POL
Connection sockets 7/8"					
	Power supply socket	5-pin		543107	NECU-G78G5-C2
		4-pin		543108	NECU-G78G4-C2
	Angled socket, 5-pin – open cable end, 5-wire	2 m		573855	NEBU-G78W5-K-2-N-LE5
M18 connection sockets					
	Straight socket, screw terminal	4-pin	PG9	18493	NTSD-GD-9
			PG13.5	18526	NTSD-GD-13.5
	Angled socket, screw terminal	4-pin	PG9	18527	NTSD-WD-9
	Angled socket, screw terminal	4-pin	PG11	533119	NTSD-WD-11
Push-pull power supply socket					
	Socket, spring-loaded terminal, plug pattern PP, fulfils requirements to AIDA	5-pin		5195383	NECU-M-PPG5PP-C1-PN
Mounting accessories					
	Screws for mounting the bus node/connection block on the plastic interlinking block	Bus node/metal connection block		550218	CPX-DPT-30X32-S-4X
		Bus node/plastic connection block		550219	CPX-M-M3x22-4x
		Bus node/metal connection block		550216	CPX-M-M3x22-S-4x

## Data sheet – Interlinking block with additional supply for valves

**Function**

Interlinking blocks ensure the electrical supply of all other CPX modules. They have contact rails, from which the other CPX components on the interlinking modules are supplied with power. Internal division of the power supply makes it possible to switch off specific areas of the sensors and actuators individually.

**Area of application**

- 24 V DC supply voltage for valves





General technical data		CPX-GE-EV-V	CPX-GE-EV-VL	CPX-GE-EV-V-7/8-4POL
Type		M18		7/8", 4-pin
Electrical connection		M18		7/8", 4-pin
Nominal operating voltage	[V DC]	24		
Acceptable current load (per contact/contact rail)	[A]	16	8	10
Degree of protection to EN 60529		Depending on connection block		
Ambient temperature	[°C]	-5 ... +50		
Note on materials		RoHS-compliant		
Materials		PA-reinforced		
Grid dimension	[mm]	50		
Dimensions W x L x H	[mm]	50 x 107 x 35		
Product weight	[g]	125		

**Pin allocation – Plastic interlinking blocks**

Circuitry	Pin	Allocation															
<b>Round plug, 4-pin</b>																	
	<b>M18</b> 	<table border="1"> <tr><td>1</td><td>n.c.</td></tr> <tr><td>2</td><td>24 V DC load voltage supply for valves</td></tr> <tr><td>3</td><td>0 V</td></tr> <tr><td>4</td><td>FE</td></tr> </table>	1	n.c.	2	24 V DC load voltage supply for valves	3	0 V	4	FE							
	1	n.c.															
2	24 V DC load voltage supply for valves																
3	0 V																
4	FE																
	<b>7/8"</b> 	<table border="1"> <tr><td>A</td><td>n.c.</td></tr> <tr><td>B</td><td>24 V DC load voltage supply for valves</td></tr> <tr><td>C</td><td>FE</td></tr> <tr><td>D</td><td>0V</td></tr> </table>	A	n.c.	B	24 V DC load voltage supply for valves	C	FE	D	0V							
	A	n.c.															
B	24 V DC load voltage supply for valves																
C	FE																
D	0V																
<table border="1"> <tr> <td><b>M18</b></td> <td>1</td> <td>2</td> <td>3</td> <td>4</td> </tr> <tr> <td><b>7/8"</b></td> <td>A</td> <td>B</td> <td>D</td> <td>C</td> </tr> <tr> <td></td> <td>n.c.</td> <td>24V</td> <td>0V</td> <td>FE</td> </tr> </table>	<b>M18</b>	1	2	3	4	<b>7/8"</b>	A	B	D	C		n.c.	24V	0V	FE		
<b>M18</b>	1	2	3	4													
<b>7/8"</b>	A	B	D	C													
	n.c.	24V	0V	FE													

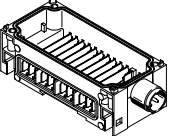
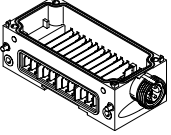
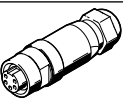
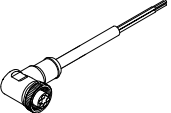
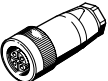
## Data sheet – Interlinking block with additional supply for valves

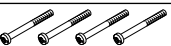
Ordering data				Part no.	Type
Designation					
Interlinking block with additional supply for valves					
	M18 connection, plastic interlinking block	4-pin	–	533577	CPX-GE-EV-V
			For ATEX environment	8022171	CPX-GE-EV-V-VL
	7/8" connection, plastic interlinking block	4-pin	–	541252	CPX-GE-EV-V-7/8-4POL
Connection sockets 7/8"					
	Power supply socket	5-pin		543107	NECU-G78G5-C2
		4-pin		543108	NECU-G78G4-C2
	Angled socket, 5-pin – open cable end, 5-wire	2 m		573855	NEBU-G78W5-K-2-N-LE5
M18 connection sockets					
	Straight socket, screw terminal	4-pin	PG9	18493	NTSD-GD-9
		4-pin	PG13.5	18526	NTSD-GD-13.5
	Angled socket, screw terminal	4-pin	PG9	18527	NTSD-WD-9
	Angled socket, screw terminal	4-pin	PG11	533119	NTSD-WD-11
Mounting accessories					
	Screws for mounting the bus node/connection block on the plastic interlinking block	Bus node/metal connection block		550218	CPX-DPT-30X32-S-4X



## Data sheet – Interlinking block with system forwarding

### Function

Interlinking blocks ensure the electrical supply of all other CPX modules. They have contact rails, from which the other CPX components on the interlinking modules are supplied with power. Internal division of the power supply makes it possible to switch off specific areas of the sensors and actuators individually.

### Area of application

- Forwarding of 24 V DC supply voltage for the electronics of the CPX terminal
- Forwarding of 24 V DC supply voltage for inputs
- Forwarding of 24 V DC supply voltage for valves
- Forwarding of 24 V DC supply voltage for outputs



General technical data		
Nominal operating voltage	[V DC]	24
Degree of protection to EN 60529		Depending on connection block
Ambient temperature	[°C]	-5 ... +50
Note on materials		RoHS-compliant
Grid dimension	[mm]	50
Dimensions W x L x H	[mm]	50 x 107 x 35

Technical data – Metal interlinking blocks			
Type	CPX-M-GE-EV-W-M12-5POL		
Electrical connection	Socket		
	M12x1		
	5-pin		
	L-coded		
Power supply	Sensors and electronics	[A]	Max. 16
	Valves and outputs	[A]	Max. 16
Corrosion resistance class (CRC)	0		
Type of mounting	Angled fitting		
Materials	Die-cast aluminium		
Certification	c UL - Recognized (OL)		
Product weight	[g]	266	

1) Corrosion resistance class CRC 0 to Festo standard FN 940070  
No corrosion stress. Applies to small, visually unimportant standards-based parts such as threaded pins, circlips and clamping sleeves which are usually only available on the market in a phosphated or burnished version (and possibly oiled) as well as to ball bearings (for components < CRC 3) and plain bearings.

### Note

Points to note about the interlinking block CPX-M-GE-EV-W-M12-5POL:

- Must be mounted as the first module to the right or to the left of the system supply
- Only one interlinking block permitted per CPX terminal

## Data sheet – Interlinking block with system forwarding

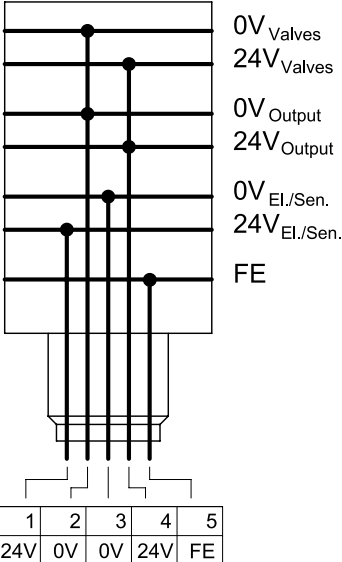
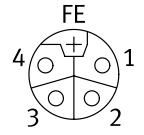
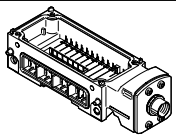
Pin allocation – Metal interlinking blocks																									
Circuitry		Pin	Allocation																						
<b>Round plug, 5-pin</b>																									
 <table border="1" data-bbox="95 862 375 918"> <tr> <td>M12</td> <td>1</td> <td>2</td> <td>3</td> <td>4</td> <td>5</td> </tr> <tr> <td></td> <td>24V</td> <td>0V</td> <td>0V</td> <td>24V</td> <td>FE</td> </tr> </table>	M12	1	2	3	4	5		24V	0V	0V	24V	FE	<p>0V Valves 24V Valves 0V Output 24V Output 0V El./Sen. 24V El./Sen. FE</p>	<p><b>M12</b></p> 	<table border="1"> <tr> <td>1</td> <td>24 V DC power supply for electronics and sensors</td> </tr> <tr> <td>2</td> <td>0 V valves and outputs</td> </tr> <tr> <td>3</td> <td>0 V electronics and sensors</td> </tr> <tr> <td>4</td> <td>24 V DC load voltage supply for valves and outputs</td> </tr> <tr> <td>FE</td> <td>FE</td> </tr> </table>	1	24 V DC power supply for electronics and sensors	2	0 V valves and outputs	3	0 V electronics and sensors	4	24 V DC load voltage supply for valves and outputs	FE	FE
	M12	1	2	3	4	5																			
	24V	0V	0V	24V	FE																				
1	24 V DC power supply for electronics and sensors																								
2	0 V valves and outputs																								
3	0 V electronics and sensors																								
4	24 V DC load voltage supply for valves and outputs																								
FE	FE																								
<b>Ordering data</b>																									
Designation		Part no.	Type																						
Interlinking block with system forwarding																									
	M12x1 L-coded connection, metal interlinking block	5-pin	<b>8098391</b>	<b>CPX-M-GE-EV-W-M12-5POL</b>																					

## Data sheet – Pneumatic interface for valve terminal MPA-S

**Function**

The pneumatic interface VMPA-FB establishes the electromechanical connection between the CPX terminal and the valve terminal MPA-S.

The signals from the bus node are forwarded to the control electronics in the electrical modules of the valve terminal MPA-S via the integrated CPX bus. The bus signal for activating the solenoid coils is converted in the electronics module for max. 8 coils.

From a technical point of view, the individual MPA pneumatic modules each represent a separate electrical module with digital outputs. Valves, which are galvanically isolated, can be supplied with power via the interlinking block CPX-GE-EV-V.

**Area of application**

- Interface to the valve terminal MPA-S
- Max. 128 solenoid coils
- Characteristics of the electronics module of the valve terminal MPA-S can be parameterised; for example, status of the solenoid coils in the event of fieldbus communication being interrupted (fail-safe), individual channel diagnostics can be activated, condition monitoring can be activated individually for each valve
- The pneumatic interface receives the voltage for the electronics and the supply voltage for the valves from the left-hand interlinking block and feeds them through to the electronics modules of the valve terminal MPA-S
- Electronics modules of the valve terminal MPA-S:
  - Undervoltage of valves
  - Short circuit of valves
  - Open load of valves
  - Counter preset reached in condition monitoring



General technical data		VMPA-FB-EPL-G	VMPA-FB-EPL-E
Type			
Number of solenoid coils		128	
Pilot air supply		Internal	External
Pilot air port 12/14		–	M7
Pneumatic connection 1		G1/4	G1/4
Operating pressure	[bar]	3 ... 8	–0.9 ... 10
Pilot pressure	[bar]	3 ... 8	3 ... 8
Nominal operating voltage	[V DC]	24	
Degree of protection to EN 60529		IP65	
Ambient temperature	[°C]	–5 ... +50	
Materials	Cover	PA	
	Housing	Die-cast aluminium	
Product weight	[g]	Approx. 320	

## Accessories – Pneumatic interface for valve terminal MPA-S

### Overview – Pneumatic interface VMPA-FB

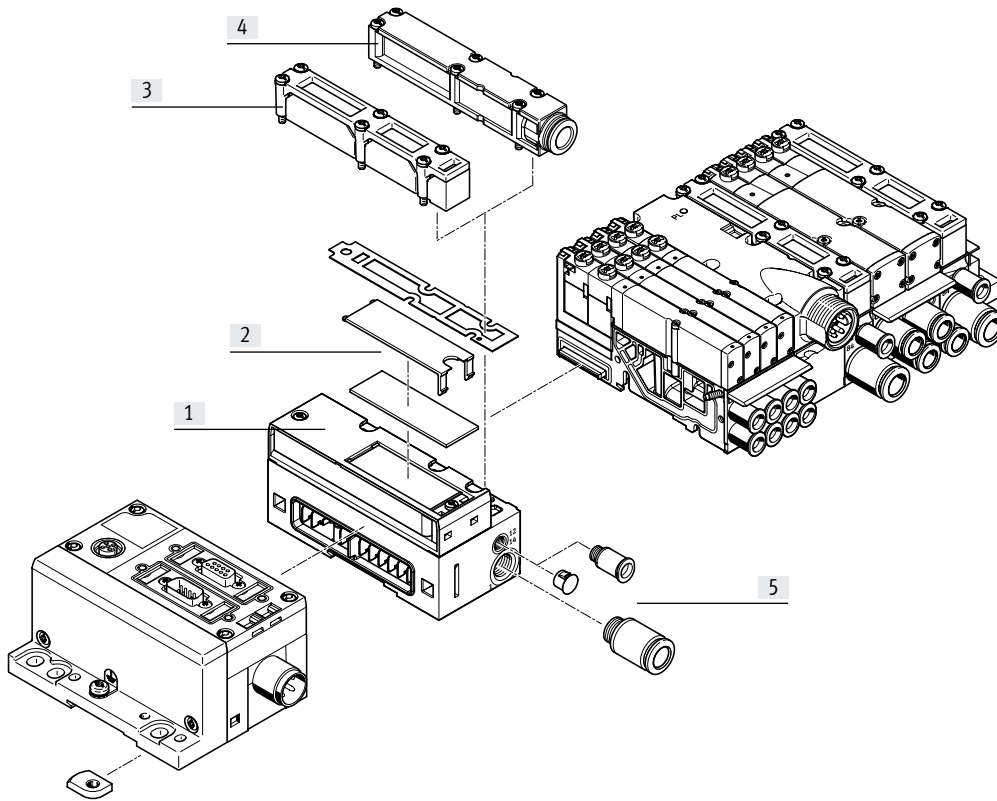

- [1] Pneumatic interface VMPA-FB
- [2] Inscription label
- [3] Flat plate silencer
- [4] Exhaust plate for ducted exhaust air
- [5] Fittings

#### Ordering data

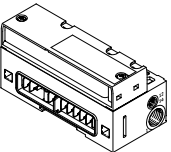
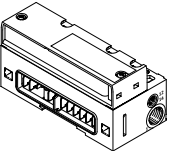
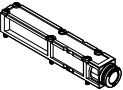
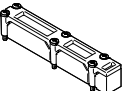
Designation		Part no.	Type
<b>Pneumatic interface for CPX plastic interlinking module</b>			
	Ducted exhaust air, internal pilot air	533370	VMPA-FB-EPL-G
	Ducted exhaust air, external pilot air	533369	VMPA-FB-EPL-E
	Flat plate silencer, internal pilot air	533372	VMPA-FB-EPL-GU
	Flat plate silencer, external pilot air	533371	VMPA-FB-EPL-EU
<b>Pneumatic interface for CPX metal interlinking module</b>			
	Ducted exhaust air, internal pilot air	552286	VMPA-FB-EPLM-G
	Ducted exhaust air, external pilot air	552285	VMPA-FB-EPLM-E
	Flat plate silencer, internal pilot air	552288	VMPA-FB-EPLM-GU
	Flat plate silencer, external pilot air	552287	VMPA-FB-EPLM-EU
<b>Exhaust plate</b>			
	For ducted exhaust air, with 10 mm push-in connector	533375	VMPA-AP
	For ducted exhaust air, with QS-3/8 connector	541629	VMPA-AP-3/8
	Flat plate silencer	533374	VMPA-APU

## Data sheet – Pneumatic interface for valve terminal MPA-L

**Function**

The pneumatic interface VMPAL establishes the electromechanical connection between the terminal CPX and the valve terminal MPA-L.

The bus signal for actuating the solenoid coils is converted in the pneumatic interface for the entire valve terminal.

The interlinking within the valve terminal is identical with the interlinking with multi-pin plug connections.

**Area of application**

- Actuation of the valve terminal MPA-L
- Max. 32 solenoid coils
- The pneumatic interface receives the voltage for the electronics and the supply voltage for the valves from the left-hand interlinking block and feeds them through to the electrical modules of the valve terminal MPA-L

**General technical data**

Type	VMPAL-EPL-CPX	
Number of solenoid coils	32	
Operating pressure	[bar]	-0.9 ... 10
Pilot pressure	[bar]	3 ... 8
Nominal operating voltage	[V DC]	24
Degree of protection to EN 60529	IP67	
Ambient temperature	[°C]	-5 ... +50
Note on materials	RoHS-compliant	

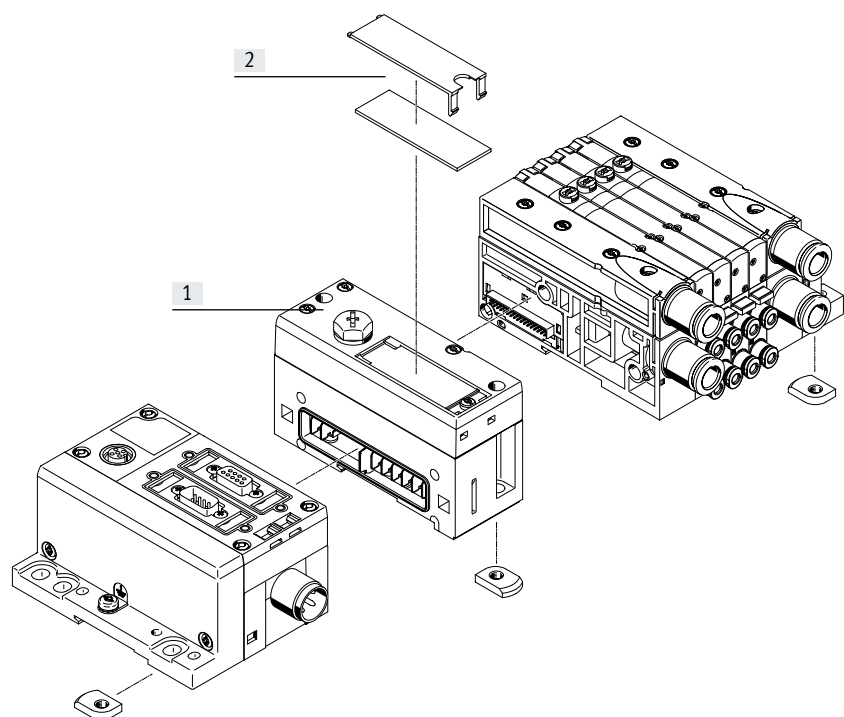
**Overview – Pneumatic interface VMPAL**

- [1] Pneumatic interface VMPAL  
[2] Inscription label

**Ordering data**

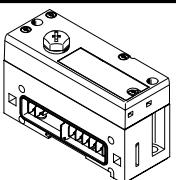
Designation	Part no.	Type
 Pneumatic interface for CPX plastic interlinking module	<b>570783</b>	<b>VMPAL-EPL-CPX</b>

## Data sheet – Pneumatic interface for valve terminal VTSA/VTSA-F

**Function**

The pneumatic interface VTSA provides the electromechanical connection between the terminal CPX and valve terminal VTSA/VTSA-F.

A complete pneumatic control loop system (FB-valve-drive-sensor-FB) can therefore be connected to the fieldbus using the input modules of the CPX terminal.

Different circuits for valves and electrical outputs are implemented using an additional supply. The integrated valve diagnostics enable the causes of errors to be found quickly, increasing system availability.

**Area of application**

- Interface to the valve terminal VTSA and VTSA-F
- Max. 32 solenoid coils
- Address space allocation (configuration) of valve terminals can be set using integrated DIL switches
- Properties of the pneumatic interface can be parameterised, e.g. status of the solenoid coil in the event of fieldbus communication being interrupted (fail-safe)
- The pneumatic interface receives the voltage for the electronics and the supply voltage for the valves from the left-hand interlinking block
- Detection of missing solenoid coils and short circuit monitoring for the valves

**General technical data**

Max. no. of valve positions	16 with double solenoid valves 32 with single solenoid valves		
Valve terminal interface	Type 44, VTSA		
Electrical control	Fieldbus		
Electrical connection	Via CPX		
Diagnostics	Undervoltage of valves		
Parameterisation	Failsafe per channel		
	Forcing per channel		
	Idle mode per channel		
	Module monitoring		
LED displays	1 group diagnostics		
	Channel status on valves		
Fuse protection (short circuit)	Internal electronic fuse per valve output		
Galvanic isolation channel – internal bus	Yes, when using an additional supply for the valves		
Nominal operating voltage	[V DC]	24	
Operating voltage range	[V DC]	21.6 ... 26.4	
Intrinsic current consumption at nominal operating voltage	Electronics	[mA]	Typically 15
	Valves	[mA]	Typically 50
Max. power supply per channel	[A]	0.2	
Max. residual current per module	[A]	4	
Degree of protection	IP65		
	NEMA 4		
Product weight	[g]	590	

## Data sheet – Pneumatic interface for valve terminal VTSA/VTSA-F

Materials	
Housing	Die-cast aluminium
Cover	PA
Note on materials	RoHS-compliant
PWIS conformity	VDMA24364-B1/B2-L
Operating and environmental conditions	
Ambient temperature	[°C] –5 ... +50
Corrosion resistance class CRC <sup>1)</sup>	0
UKCA marking (see declaration of conformity) <sup>2)</sup>	To UK instructions for EMC
	To UK EX instructions
	To UK RoHS instructions

- 1) Corrosion resistance class CRC 0 to Festo standard FN 940070  
No corrosion stress. Applies to small, visually unimportant standards-based parts such as threaded pins, circlips and clamping sleeves which are usually only available on the market in a phosphated or burnished version (and possibly oiled) as well as to ball bearings (for components < CRC 3) and plain bearings.
- 2) For information about the area of use, see the EC declaration of conformity at: [www.festo.com/catalogue/...](http://www.festo.com/catalogue/...) → Support/Downloads.  
If the devices are subject to usage restrictions in residential, commercial or light-industrial environments, further measures for the reduction of the emitted interference may be necessary.

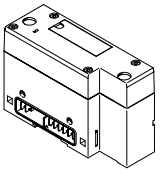
Ordering data				
Designation		Part no.	Type	
	For plastic interlinking block	<b>543416</b>	<b>VABA-S6-1-X1</b>	
	For metal interlinking block	Diagnostics via fieldbus	<b>550663</b>	<b>VABA-S6-1-X2</b>
		Diagnostics via process data image	<b>573613</b>	<b>VABA-S6-1-X2-D</b>

## Data sheet – Pneumatic interface for valve terminal VTSA-F-CB

**Function**

The pneumatic interface provides the electromechanical connection between the terminal CPX and valve terminal VTSA-F-CB.

A complete pneumatic control loop system (FB-valve-drive-sensor-FB) can therefore be connected to the fieldbus using the input modules of the CPX terminal.

Different circuits for valves and electrical outputs are implemented using an additional supply. The integrated valve diagnostics enable the causes of errors to be found quickly, increasing system availability.

**Area of application**

- Interface to valve terminal VTSA-F-CB
- Max. 24 solenoid coils
- Properties of the pneumatic interface can be parameterised, e.g. status of the solenoid coil in the event of fieldbus communication being interrupted (fail-safe)
- The pneumatic interface receives the voltage for the electronics and the supply voltage for the valves from the left-hand interlinking block
- The supply voltage for the valves is provided from the left-hand interlinking block or externally
- Detection of missing solenoid coils and short circuit monitoring for the valves



General technical data		Pneumatic interface		
		Without voltage zones	With safe voltage zones	With external power supply to the valves
Max. no. of valve positions		12 with double solenoid valves 24 with single solenoid valves		
Valve terminal interface		Type 44, VTSA		
Electrical control		Fieldbus		
Electrical connection		Via CPX		
Electrical connection output	Function	–	Safe digital output	–
	Connection type	–	Socket	–
	Connection technology	–	M12x1, A-coded to EN 61076-2-101	–
	Number of pins/wires	–	5	–
Electrical connection, power supply to valves	Function	–	–	–
	Connection type	–	–	Plug
	Connection technology	–	–	3x M12x1, A-coded
	Number of pins/wires	–	–	5
Diagnostics		Wire break per valve coil		
		Short circuit of valves		
		Undervoltage of valves		
Parameterisation		Failsafe per channel		
		Forcing per channel		
		Idle mode per channel		
		Module monitoring		
LED displays		1 group diagnostics	1 group diagnostics	1 group diagnostics
		Channel status on valves	–	Channel status on valves
		–	–	3 load supply



## Data sheet – Pneumatic interface for valve terminal VTSA-F-CB

Technical data – Electrics		Pneumatic interface			
		Without voltage zones	With safe voltage zones	With external power supply to the valves	
Nominal operating voltage	[V DC]	24			
Operating voltage range	[V DC]	21.6 ... 26.4			
Intrinsic current consumption at nominal operating voltage	Electronics	[mA]	Typically 11	<ul style="list-style-type: none"> <li>Typically 45 for electronics without CPX-FVDA-P2</li> <li>Typically 110 for electronics with CPX-FVDA-P2</li> </ul>	Typically 11
	Valves	[mA]	Typically 45	<ul style="list-style-type: none"> <li>Typically 25 for valves without CPX-FVDA-P2</li> <li>Typically 90 for valves with CPX-FVDA-P2</li> </ul>	Typically 45
Max. power supply per channel	[A]	0.2	0.2	0.2	
Max. residual current per module	[A]	6	4.5	6	
Fuse protection (short circuit)		Internal electronic fuse per valve output	Internal electronic fuse per valve output	Internal electronic fuse per valve output	
Galvanic isolation channel – internal bus		Yes, when using an additional supply for the valves	Yes, when using an additional supply for the valves	Yes	

Materials		Pneumatic interface		
		Without voltage zones	With safe voltage zones	With external power supply to the valves
Housing		Die-cast aluminium	–	Die-cast aluminium
Cover		PA	PA	PA
Sub-base		–	Die-cast aluminium	–
Seals		–	NBR	–
Screws		–	Steel	–
Note on materials		RoHS-compliant	RoHS-compliant	RoHS-compliant
PWIS conformity		VDMA24364-B1/B2-L	–	VDMA24364-B1/B2-L

Operating and environmental conditions		Pneumatic interface		
		Without voltage zones	With safe voltage zones	With external power supply to the valves
Ambient temperature	[°C]	–5 ... +50	–5 ... +50	–5 ... +50
Storage temperature	[°C]	–	–20 ... +60	–
Corrosion resistance class CRC <sup>1)</sup>		0	0	0
Shock resistance		–	Shock test with severity level 2 to FN 942017-5 and EN 60068-2-27	–
Vibration resistance		–	Transport application test with severity level 2 to FN 942017-4 and EN 60068-2-6	–
CE marking (see declaration of conformity) <sup>3)</sup>		–	To EU EMC Directive <sup>2)</sup>	–
		–	To EU RoHS Directive	–
Degree of protection		IP65	IP65	IP65
		NEMA 4	–	NEMA 4

1) Corrosion resistance class CRC 0 to Festo standard FN 940070

No corrosion stress. Applies to small, visually unimportant standards-based parts such as threaded pins, circlips and clamping sleeves which are usually only available on the market in a phosphated or burnished version (and possibly oiled) as well as to ball bearings (for components < CRC 3) and plain bearings.

2) For information about the area of use, see the EC declaration of conformity at: [www.festo.com/catalogue/...](http://www.festo.com/catalogue/...) → Support/Downloads.

If the devices are subject to usage restrictions in residential, commercial or light-industrial environments, further measures for the reduction of the emitted interference may be necessary.

3) Additional information: [www.festo.com/catalogue/...](http://www.festo.com/catalogue/...) → Support/Downloads.

## Data sheet – Pneumatic interface for valve terminal VTSA-F-CB

Combinations of bus nodes/control blocks with pneumatic interface					
Bus node/control block	Part no.	Pneumatic interface			
		VABA-...-X1-CB	VABA-...-X2-CB	VABA-...-X2-F1-CB	VABA-...-X2-F2-CB
CPX-FB13	195740	■	■	■	■
CPX-FB33	548755	■	■	■	■
CPX-M-FB34	548751	■	■	■	■
CPX-M-FB35	548749	■	■	■	■
CPX-FB36	1912451	■	■	-	-
CPX-FB37	2735960	■	■	-	-
CPX-FB43	8110369	■	■	■	■
CPX-M-FB44	8110370	■	■	■	■

Ordering data				
	Description	Product weight [g]	Part no.	Type

Pneumatic interface without voltage zones				
	For plastic interlinking block	560	8082877	VABA-S6-1-X1-CB
	For metal interlinking block	560	8082876	VABA-S6-1-X2-CB

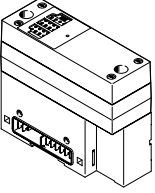
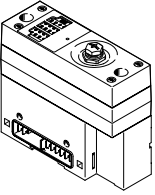
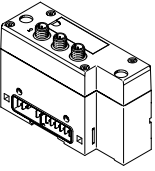
Pneumatic interface with voltage zones				
	For metal interlinking block	Division of the connected valves into up to 3 safe voltage zones	734	8068240 VABA-S6-1-X2-F1-CB
	For metal interlinking block	<ul style="list-style-type: none"> <li>Division of the connected valves into up to 2 safe voltage zones</li> <li>1 external safe voltage zone</li> </ul>	754	8068241 VABA-S6-1-X2-F2-CB
	For plastic interlinking block	<ul style="list-style-type: none"> <li>Division of the connected valves into up to 3 voltage zones</li> <li>External power supply for each voltage zone</li> </ul>	580	8082879 VABA-S6-1-X1-3V-CB
	For metal interlinking block	<ul style="list-style-type: none"> <li>Division of the connected valves into up to 3 voltage zones</li> <li>External power supply for each voltage zone</li> </ul>	580	8082878 VABA-S6-1-X2-3V-CB

## Data sheet

## Dimensions – Plastic interlinking module

Download CAD data → [www.festo.com](http://www.festo.com)

With bus nodes and connection blocks

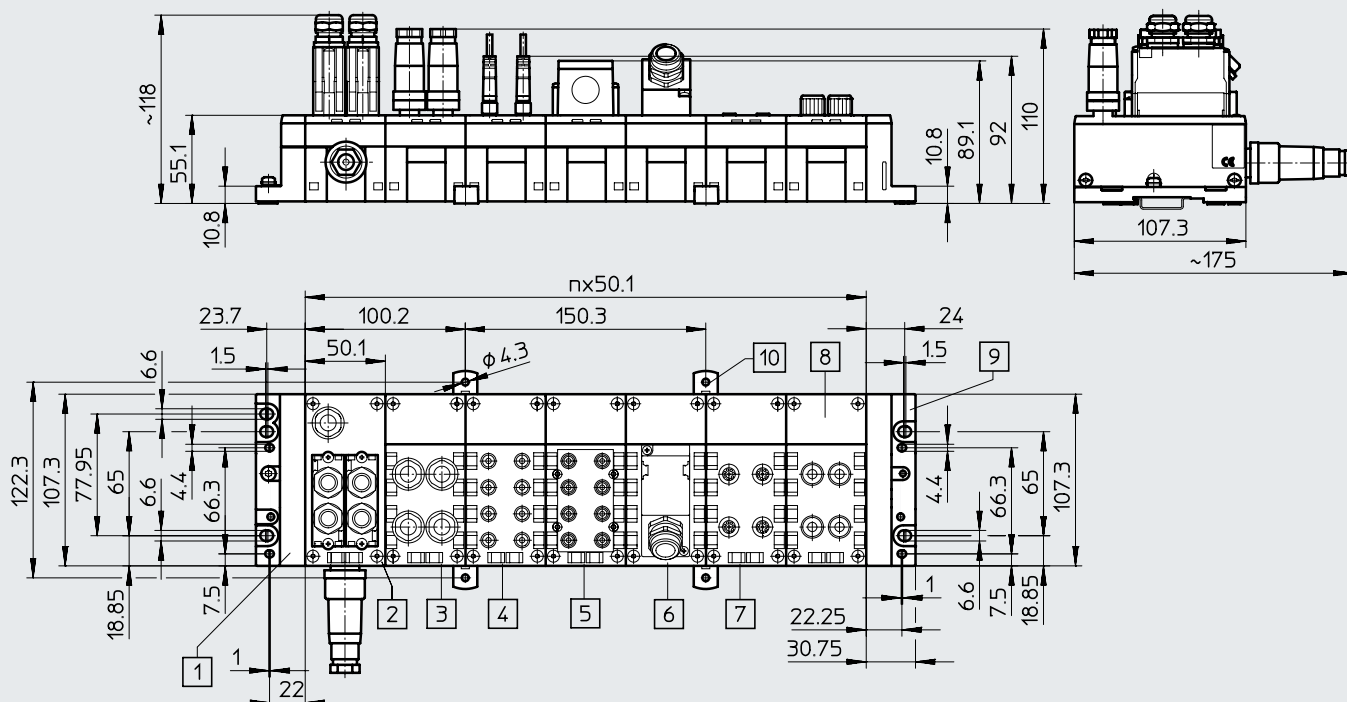

- |   |   |  |                         |
|---|---|--|-------------------------|
| [1] Left-hand end plate (earthing plate optional) | [5] Connection block<br>CPX-AB-8-KL-4POL      | [8] Connection block<br>CPX-AB-4-M12x2-5POL  | n Number of CPX modules |
| [2] Bus node                                      | [6] Connection block<br>CPX-AB-1-SUB-BU-25POL | [9] Right-hand end plate   |                         |
| [3] Connection block<br>CPX-AB-4-M12-8POL         | [7] Connection block<br>CPX-AB-4-HAR-4POL     | [10] Mounting clip for wall mounting<br>(required every 2 ... 3 connection blocks) |                         |
| [4] Connection block<br>CPX-AB-8-M8-3POL          |   |  |                         |

Data sheet

Dimensions – Metal interlinking block

Download CAD data → [www.festo.com](http://www.festo.com)

With bus nodes and connection blocks

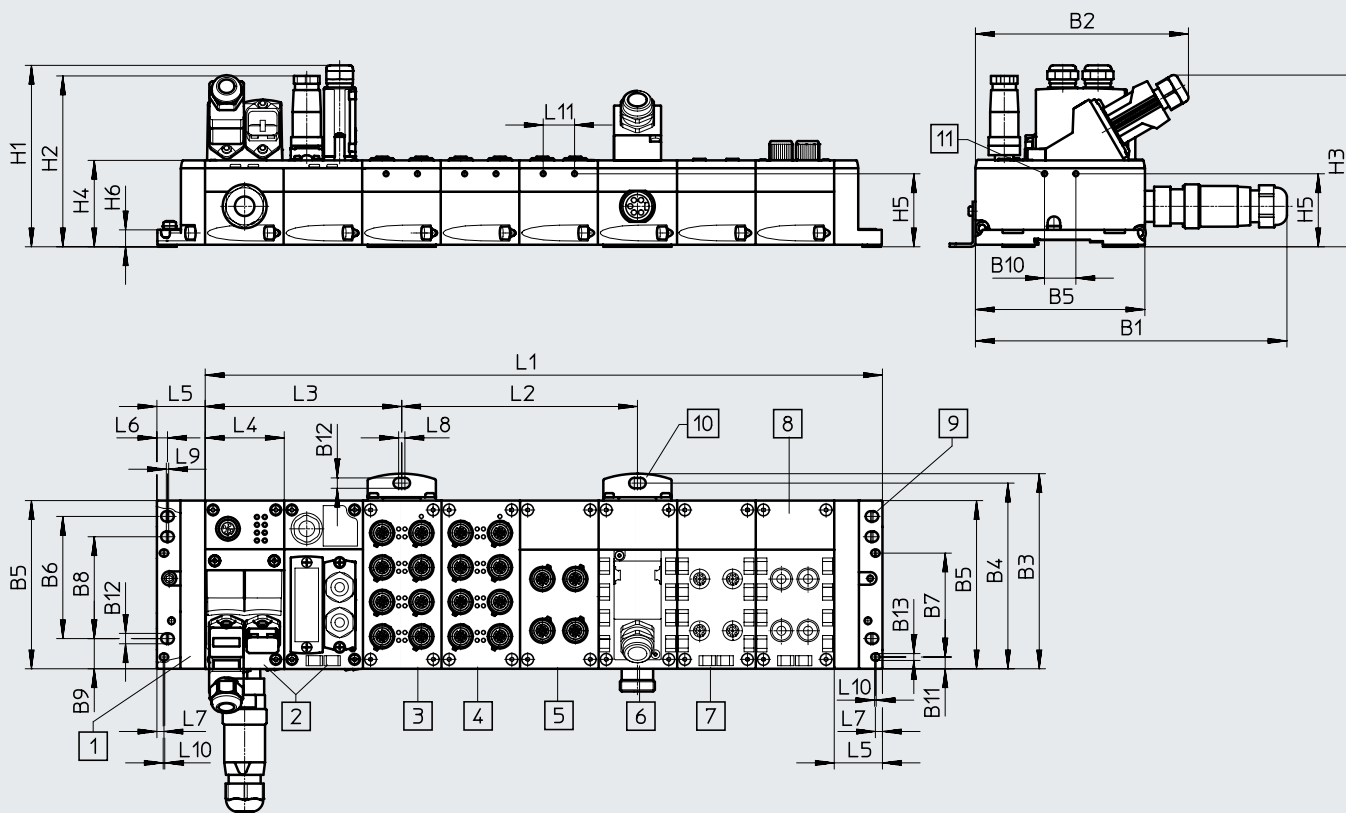

- [1] Left-hand end plate
- [2] Bus node
- [3] Connection block  
CPX-M-AB-8-M12X2-5POL
- [4] Connection block  
CPX-M-AB-8-M12X2-5POL
- [5] Connection block  
CPX-M-AB-4-M12X2-5POL
- [6] Connection block  
CPX-AB-1-SUB-BU-25POL
- [7] Connection block  
CPX-AB-4-M12-8POL
- [8] Connection block  
CPX-AB-4-HAR-4POL
- [9] Right-hand end plate
- [10] Mounting bracket for wall  
mounting
- [11] Hole for self-tapping screw  
M2.5

Type	B1	B2	B3	B4	B5	B6	B7	B8	B9	B10	B11	B12	B13
CPX-M	199	136	124.9	118.85	108.1	77.95	66.3	65	19.25	20	7.9	6.6	4.4

Type	H1	H2	H3	H4	H5	H6
CPX-M	116	109	109.5	55.1	46.55	10.8

Type	L1 <sup>1)</sup>	L2	L3 <sup>2)</sup>	L4	L5 <sup>3)</sup>	L6	L7	L8	L9	L10	L11
CPX-M	$n \times 50.1 + 30.4$	150.3	125.25	50.1	30.4	6.75	4.5	4	1.5	1	20

1) n = Number of CPX modules

# Data sheet

## Dimensions

Download CAD data → [www.festo.com](http://www.festo.com)

With bus node and valve terminal VTSA/VTSA-F/VTSA-F-CB

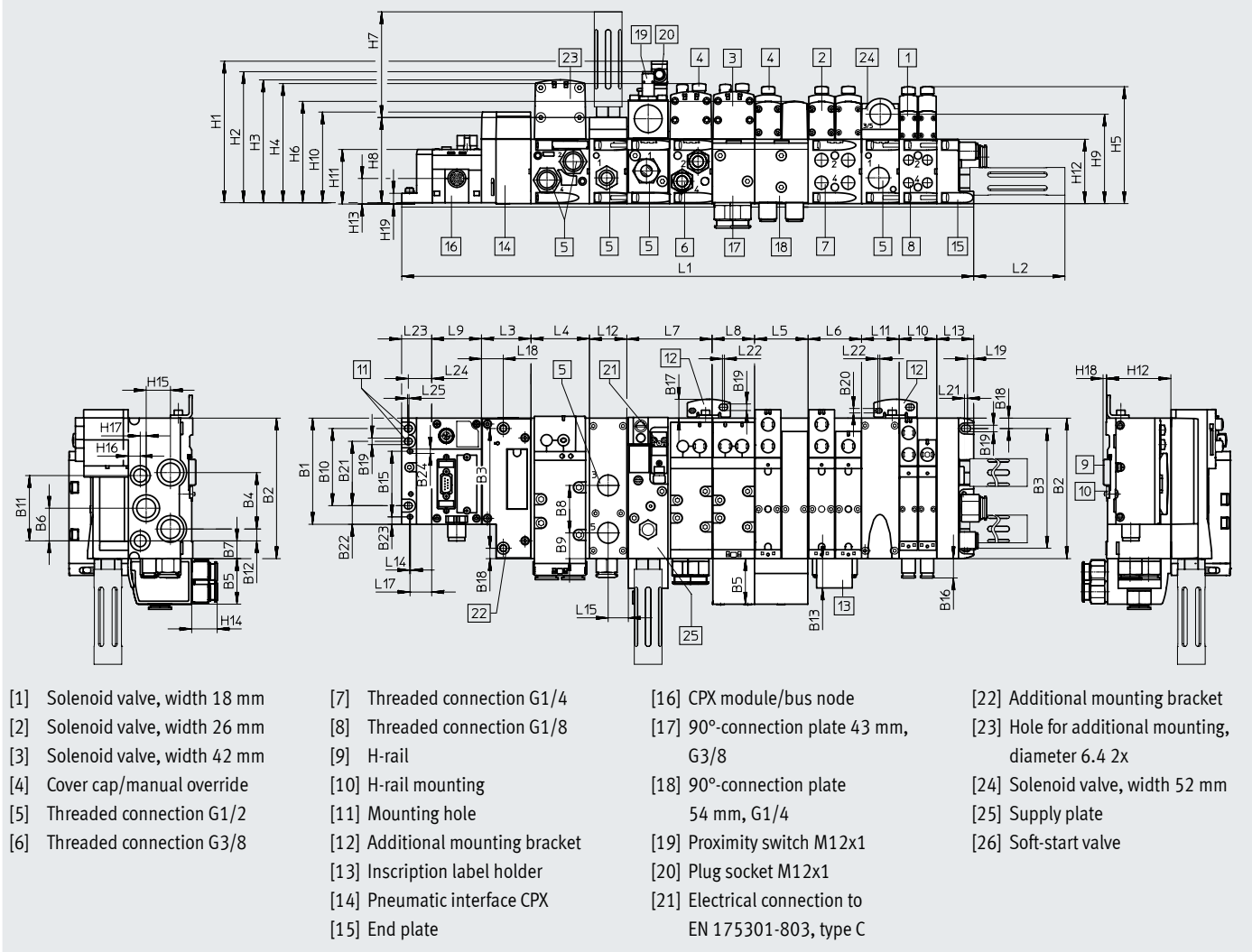

- [1] Solenoid valve, width 18 mm
- [2] Solenoid valve, width 26 mm
- [3] Solenoid valve, width 42 mm
- [4] Cover cap/manual override
- [5] Threaded connection G1/2
- [6] Threaded connection G3/8
- [7] Threaded connection G1/4
- [8] Threaded connection G1/8
- [9] H-rail
- [10] H-rail mounting
- [11] Mounting hole
- [12] Additional mounting bracket
- [13] Inscription label holder
- [14] Pneumatic interface CPX
- [15] End plate
- [16] CPX module/bus node
- [17] 90°-connection plate 43 mm, G3/8
- [18] 90°-connection plate 54 mm, G1/4
- [19] Proximity switch M12x1
- [20] Plug socket M12x1
- [21] Electrical connection to EN 175301-803, type C
- [22] Additional mounting bracket
- [23] Hole for additional mounting, diameter 6.4 2x
- [24] Solenoid valve, width 52 mm
- [25] Supply plate
- [26] Soft-start valve

Dim.	B1	B2	B3	B4	B5	B6	B7	B8	B9	B10	B11	B12	B13	B14	B16	B18	B19	B20	B21	B22	B23	B24
[mm]	107.3	142	121	57	46	33	18	48	26	78	66	12	29.6	23	19.5	10.5	6.6	4.5	65	18.9	7.5	4.4

Dim.	L2	L3	L4	L5	L6	L7	L8	L9	L10	L11	L12	L13	L14	L15	L17	L18	L19	L20	L21	L22
[mm]	92.4	50	n2x59	n01x54	54	n1x43	43	mx50.1	n02x38	nx38	38	37.3	1	20.5	22	22	6.3	5.5	3	2

Dim.	L23	L24	L25	H1	H2	H3	H4	H5	H6	H7	H8	H9	H10	H11	H12	H13	H14	H15	H16	H17	H18	H19
[mm]	30.4	23.7	1.5	143.9	133.3	125	121.3	118.2	103	106.8	87	90.3	92.9	55.1	65	25.8	25.7	24.5	12	6	3.5	10.8

Width	L1 <sup>1)</sup>
40 mm	30.4 + m x 50.1 + 50 + n02 x 38 + n x 38 + 37.3
26 mm	30.4 + m x 50.1 + 50 + n01 x 54 + n x 38 + 37.3
42 mm	30.4 + m x 50.1 + 50 + n1 x 43 + n x 38 + 37.3
52 mm	30.4 + m x 50.1 + 50 + n2 x 59 + n x 38 + 37.3
Mixture of 18 mm, 26 mm, 42 mm and 52 mm	30.4 + m x 50.1 + 50 + n02 x 38 + n01 x 54 + n1 x 43 + n2 x 59 + n x 38 + 37.3

1) n02 Number of manifold sub-bases 38 mm  
 n01 Number of manifold sub-bases 54 mm  
 n1 Number of manifold sub-bases 43 mm  
 n2 Number of manifold sub-bases 59 mm  
 n Number of supply plates (only with end plate with pilot air selector)  
 m Number of CPX modules

† Note: This product conforms to ISO 1179-1 and ISO 228-1.

Data sheet

Dimensions

Download CAD data → [www.festo.com](http://www.festo.com)

With bus node and valve terminal MPA-S

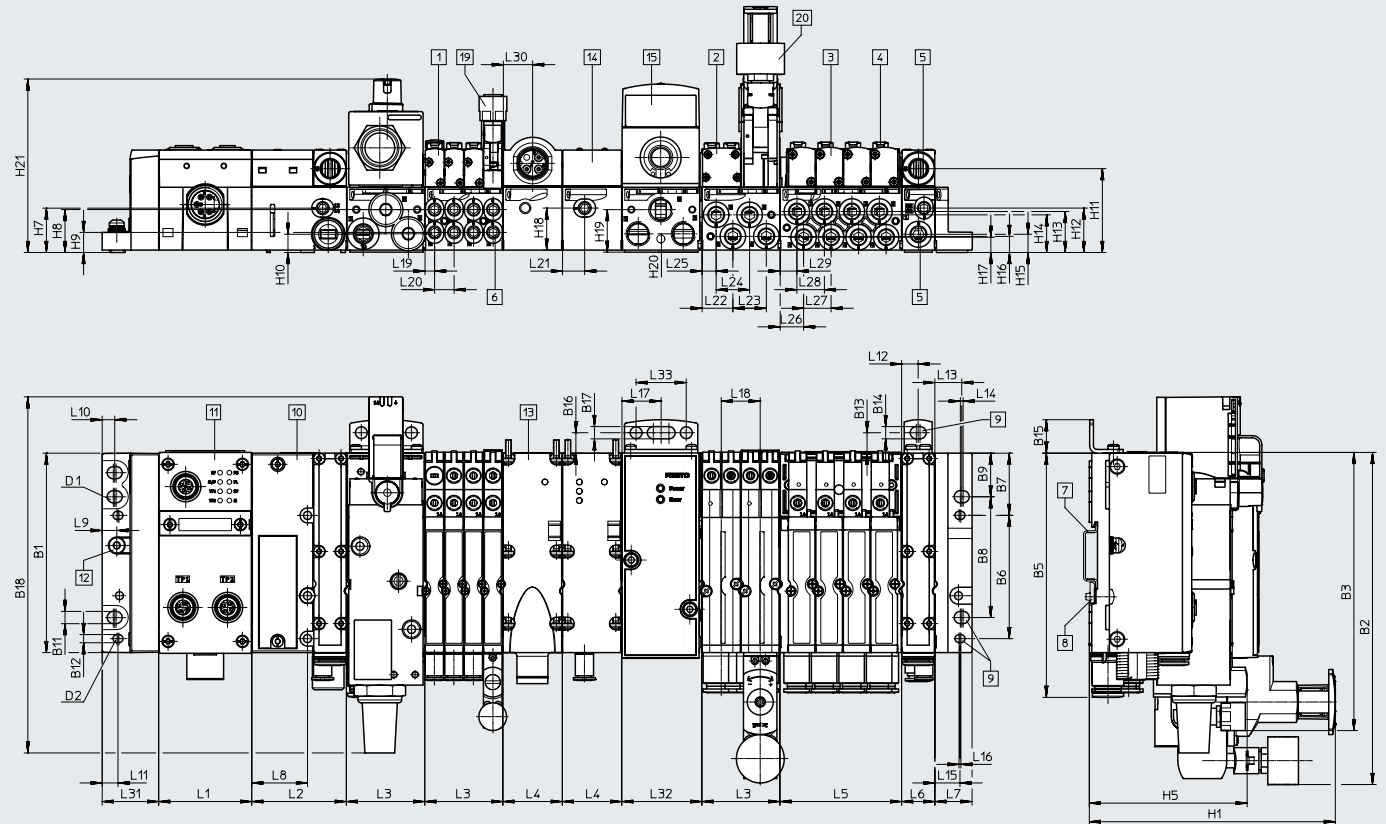

- [1] Solenoid valve, width 10 mm
- [2] Solenoid valve, width 20 mm
- [3] Solenoid valve, width 14 mm
- [4] Manual override
- [5] Supply/exhaust ports
- [6] Working ports
- [7] H-rail
- [8] H-rail mounting
- [9] Mounting holes
- [10] Pneumatic interface VMPA□FB
- [11] CPX module
- [12] Earthing screw
- [13] Electrical supply plate
- [14] Pressure sensor
- [15] Proportional pressure regulator
- [19] Vertical stacking MPA1
- [20] Vertical stacking MPA2

Type	B1	B2	B3	B5	B6	B7	B8	B9	B11	B12	B13	B14	B15	B16	B17	D1	D2
MPA-S	107.3	178	149.2	129	66.4	33.5	65	23.5	6.6	4.4	11	6.6	18	11	6.6	M6	M4

Type	H1	H5	H7	H8	H9	H10	H11	H12	H13	H14	H15	H16	H17	H18	H19	H20	H21
MPA-S	132.3	84.9	23.9	23.1	10.8	9.8	45.1	23.9	22.1	20.3	9.8	8.7	8.2	22.6	22.9	9.9	93.4

Type	L1 <sup>1)</sup>	L2	L3 <sup>2)</sup>	L4	L5 <sup>3)</sup>	L6	L7	L8	L9	L10	L11	L12	L13	L14	L15	L16
MPA-S	m x 50.1	51.3	n x 42	32	o x 65.5	17.9	20	30	7.9	6.8	8.5	9	14.5	1.5	13.5	1

Type	L17	L18	L19	L20	L21	L22	L23	L24	L25	L26	L27	L28	L29	L30	L31	L32	L33
MPA-S	21	21	5.3	10.5	11.9	16.6	18	18	7.6	12.6	14.8	14.8	9	15.8	30.4	42	27

1) m = Number of CPX modules  
 2) n = number of sub-bases with 4 valve positions (width 10 mm) or 2 valve positions (width 20 mm)  
 3) o = number of sub-bases with 4 valve positions (width 14 mm)

## Data sheet

## Dimensions

Download CAD data → [www.festo.com](http://www.festo.com)

With bus node and valve terminal MPA-L

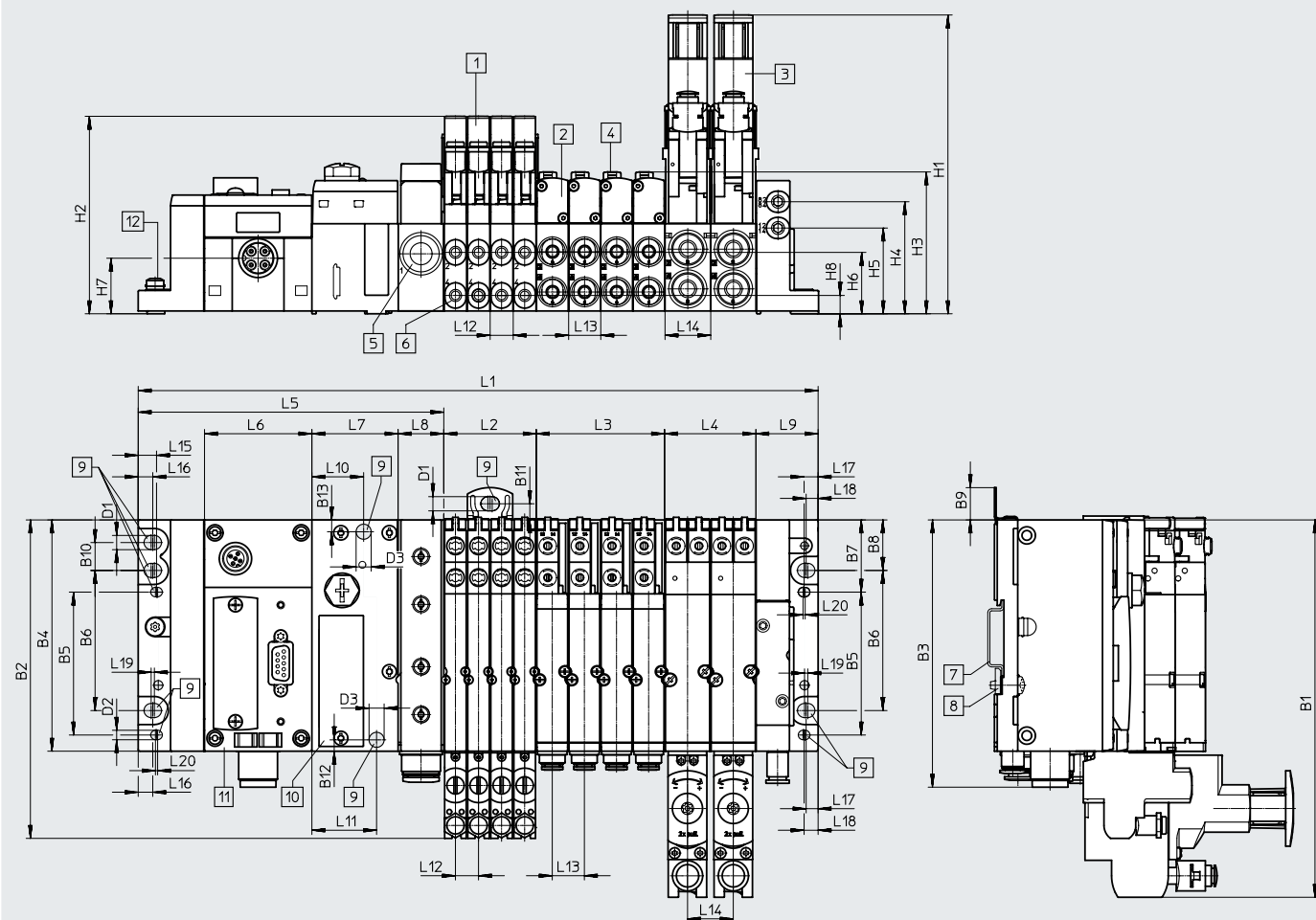

- |                           |                     |   |                     |
|---------------------------|---------------------|---|---------------------|
| [1] Solenoid valve VMPA1  | [5] Supply module   | [9] Mounting holes                        | [11] CPX module     |
| [2] Solenoid valve VMPA14 | [6] Working ports   | [10] Pneumatic interface,<br>CPX terminal | [12] Earthing screw |
| [3] Solenoid valve VMPA2  | [7] H-rail          |   |                     |
| [4] Manual override       | [8] H-rail mounting |   |                     |

Type	L1 <sup>1)</sup>	L2 <sup>1)</sup>	L3 <sup>1)</sup>	L4 <sup>1)</sup>	L5	L6	L7	L8	L9
MPA-L	170.65 + L2 + L3 + L4	m x 10.7	n x 14.9	o x 21.2	142	50	40.1	21.2	28.8



Type	L10	L11	L12	L13	L14	L15	L16	L17	L18	L19	L20
MPA-L	24	30	10.7	14.9	21.2	8.5	6.75	5.55	6.5	1.5	1

Type	B1	B2	B3	B4	B5	B6	B7	B8	B9	B10	B11	B12	B13
MPA-L	175.1	147.8	124	107.3	66.3	65	33.5	23.45	15	12.95	7.5	5.25	5.5

Type	D1	D2	D3	H1	H2	H3	H4	H5	H6	H7	H8
MPA-L	6.6	4.4	7	138.7	92.6	65.7	52	39.8	28.5	25.8	8.5

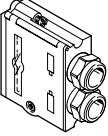

1) m, n, o = number of sub-bases/valve positions (m = width 10 mm, n = width 14 mm, o = width 20 mm)

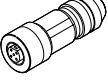
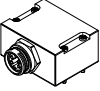
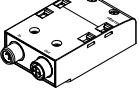
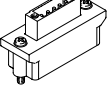
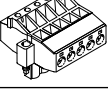
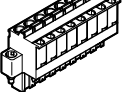
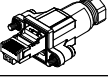
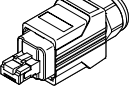
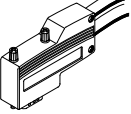
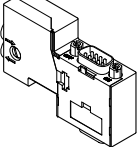
## Accessories





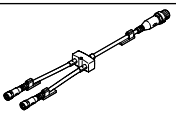

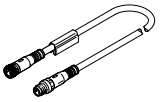
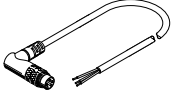
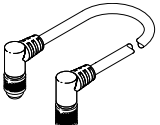
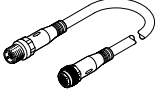
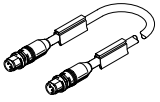
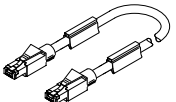
Ordering data – Accessories				Part no.	Type
Designation					
<b>Connectors and accessories</b>					
	Sub-D plug for INTERBUS		Incoming	532218	FBS-SUB-9-BU-IB-B
			Outgoing	532217	FBS-SUB-9-GS-IB-B
	Sub-D plug for DeviceNet/CANopen			532219	FBS-SUB-9-BU-2x5POL-B
	Sub-D plug for PROFIBUS DP			532216	FBS-SUB-9-GS-DP-B
	Sub-D plug for CC-Link			532220	FBS-SUB-9-GS-2x4POL-B
	Sub-D plug			534497	FBS-SUB-9-GS-1x9POL-B
	Bus connection M12 adapter (B-coded) for PROFIBUS DP			533118	FBA-2-M12-5POL-RK
	Micro style bus connection, 2xM12 for DeviceNet/CANopen			525632	FBA-2-M12-5POL
	For micro style connection, M12		Socket	18324	FBSD-GD-9-5POL
			Plug	175380	FBS-M12-5GS-PG9
	M12x1 bus connection, 4-pin (D-coded) for Ethernet			543109	NECU-M-S-D12G4-C2-ET
	For FBA-2-M12-5POL-RK and CPX-AB-2-M12-RK-DP, M12x1, 5-pin, straight		Socket	1067905	NECU-M-B12G5-C2-PB
			Plug	1066354	NECU-M-S-B12G5-C2-PB
	Plug M12x1, 4-pin, straight, A-coded	Screw terminal	Connection cross section 0.14 ... 0.5 mm <sup>2</sup>		192008
Permissible cable $\varnothing$ 4 ... 6 mm			18666	SEA-GS-7	
Permissible cable $\varnothing$ 6 ... 8 mm			18778	SEA-GS-9	
	Connection block, 9-pin Sub-D socket, 5-pin 7/8" plug for DeviceNet			571052	CPX-AB-1-7/8-DN
	Connection block M12 adapter (B-coded)		For PROFIBUS DP	541519	CPX-AB-2-M12-RK-DP
			For INTERBUS	534505	CPX-AB-2-M12-RK-IB
	Open style bus connection for 5-pin terminal strip for DeviceNet/CANopen			525634	FBA-1-SL-5POL
	Terminal strip for open style connection, 5-pin			525635	FBSD-KL-2x5POL
	8-pin socket		Spring-loaded terminal	565712	NECU-L3G8-C1
			Screw terminal	565710	NECU-L3G8-C2
	RJ45/plug			534494	FBS-RJ45-8-GS
	RJ45 plug, 8-pin, push-pull			552000	FBS-RJ45-PP-GS
	Plug SCRJ, 2-pin, push-pull, for CPX-M-FB35 and CPX-M-FB45			571017	FBS-SCRJ-PP-GS
	Plug for CAN bus interface, electric axes Sub-D, 9-pin, without terminating resistor			533783	FBS-SUB-9-WS-CO-K
	Sub-D socket with terminating resistor and programming interface		For CANopen	574588	NECU-S1W9-C2-ACO
	Sub-D plug, straight, with terminating resistor and programming interface		For PROFIBUS	574589	NECU-S1W9-C2-APB



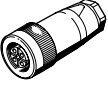
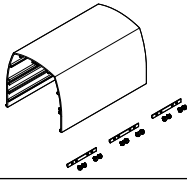

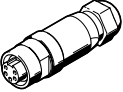
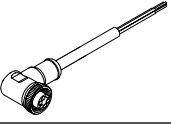
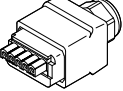

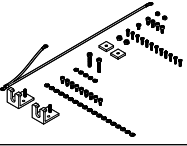
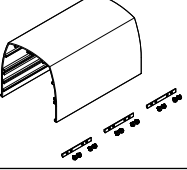
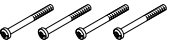

## Accessories

Ordering data – Accessories				Part no.	Type	
Designation						
<b>Distributor</b>						
	Modular system for all types of sensor/actuator distributor			–	NEDY-... → Internet: nedy	
	Push-in T-connector	1x plug M8, 4-pin	2x socket M8, 3-pin	8005312	NEDY-L2R1-V1-M8G3-N-M8G4	
		1x plug M12, 4-pin	2x socket M8, 3-pin	8005311	NEDY-L2R1-V1-M8G3-N-M12G4	
			2x socket M12, 5-pin	8005310	NEDY-L2R1-V1-M12G5-N-M12G4	
<b>Connecting cables</b>						
	Modular system for a choice of connecting cables			–	NEBU-... → Internet: nebu	
	Connecting cable M8-M8, straight plug/straight socket		0.5 m	541346	NEBU-M8G3-K-0.5-M8G3	
			1.0 m	541347	NEBU-M8G3-K-1-M8G3	
			2.5 m	541348	NEBU-M8G3-K-2.5-M8G3	
			5.0 m	541349	NEBU-M8G3-K-5-M8G3	
	Connecting cable M12-M12, 5-pin, straight plug/straight socket		1.5 m	529044	KV-M12-M12-1.5	
			3.5 m	530901	KV-M12-M12-3.5	
			5 m	574321	NEBU-M12G5-E-5-Q8N-M12G5	
	Connecting cable for CPX-CTEL, M12-M12, 5-pin, straight plug/straight socket		7.5 m	574322	NEBU-M12G5-E-7.5-Q8N-M12G5	
			10 m	574323	NEBU-M12G5-E-10-Q8N-M12G5	
			2.0 m	525617	KM12-8GD8GS-2-PU	
		Connecting cable M9, 5-pin, angled plug/open cable end 3-pin		2 m	563711	NEBC-M9W5-K-2-N-LE3
				5 m	563712	NEBC-M9W5-K-5-N-LE3
	Connecting cable M9, angled plug/angled socket		0.25 m	540327	KVI-CP-3-WS-WD-0.25	
			0.5 m	540328	KVI-CP-3-WS-WD-0.5	
			2 m	540329	KVI-CP-3-WS-WD-2	
			5 m	540330	KVI-CP-3-WS-WD-5	
			8 m	540331	KVI-CP-3-WS-WD-8	
	Connecting cable M9, Straight plug/straight socket		2 m	540332	KVI-CP-3-GS-GD-2	
			5 m	540333	KVI-CP-3-GS-GD-5	
			8 m	540334	KVI-CP-3-GS-GD-8	
	Connecting cable, straight plug, M12x1, 4-pin, D-coded	Straight plug, M12x1, 4-pin, D-coded	0.5 m	8040446	NEBC-D12G4-ES-0.5-S-D12G4-ET	
			1 m	8040447	NEBC-D12G4-ES-1-S-D12G4-ET	
			3 m	8040448	NEBC-D12G4-ES-3-S-D12G4-ET	
			5 m	8040449	NEBC-D12G4-ES-5-S-D12G4-ET	
			10 m	8040450	NEBC-D12G4-ES-10-S-D12G4-ET	
			Straight plug, RJ45, 8-pin	1 m	8040451	NEBC-D12G4-ES-1-S-R3G4-ET
				3 m	8040452	NEBC-D12G4-ES-3-S-R3G4-ET
				5 m	8040453	NEBC-D12G4-ES-5-S-R3G4-ET
				10 m	8040454	NEBC-D12G4-ES-10-S-R3G4-ET
				5 m	8040456	NEBC-LE4-ES-5-D12G4-ET
	Connecting cable, Straight plug, RJ45, 8-pin	Straight plug, RJ45, 8-pin	1 m	8040455	NEBC-R3G4-ES-1-S-R3G4-ET	

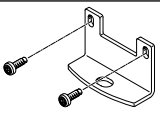
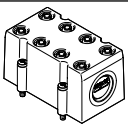
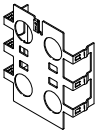
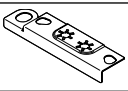
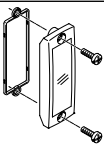
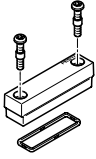
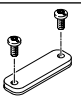

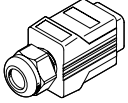



## Accessories

Ordering data – Accessories		Part no.	Type
Designation			
Connectors and accessories – Power supply			
	Plug socket for mains connection M18, straight	For 1.5 mm <sup>2</sup>	18493 NTSD-GD-9
			18526 NTSD-GD-13.5
	Plug socket for mains connection M18, angled	For 1.5 mm <sup>2</sup>	18527 NTSD-WD-9
		For 2.5 mm <sup>2</sup>	533119 NTSD-WD-11
	Power supply socket, straight	7/8" connection, 5-pin	543107 NECU-G78G5-C2
		7/8" connection, 4-pin	543108 NECU-G78G4-C2
	7/8" power supply socket, 5-pin, angled socket/open cable end, 5-wire	2 m	573855 NEBU-G78W5-K-2-N-LE5
	Push-pull power supply socket, plug pattern PP, fulfils requirements to AIDA	5-pin	5195383 NECU-M-PPG5PP-C1-PN
	Straight plug, spring-loaded terminal, for left-hand end plate with system supply	7-pin	576319 NECU-L3G7-C1
Hood			
	Mounting rail for attaching the hood	1000 mm	572256 CAFC-X1-S
	Mounting kit for CPX hood		572257 CAFC-X1-BE
	Hood section for CPX terminal including mounting attachments for connecting several hood sections in series	200 mm	572258 CAFC-X1-GAL-200
		300 mm	572259 CAFC-X1-GAL-300
Screws			
	Screws for mounting the bus node/connection block on the plastic interlinking block	Bus node/metal connection block	550218 CPX-DPT-30X32-S-4X
		Bus node/plastic connection block	550219 CPX-M-M3x22-4x
		Bus node/metal connection block	550216 CPX-M-M3x22-S-4x
	Screws for mounting an inscription label on the bus node (CPX-FB33, CPX-M-FB34, CPX-M-FB35, CPX-M-FB45)	12 pieces	550222 CPX-M-M2.5X8-12X

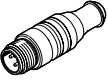
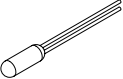
## Accessories

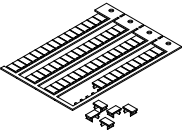
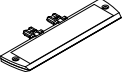
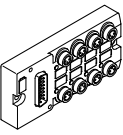
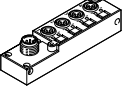
Ordering data – Accessories		Part no.	Type
Designation			
<b>Mounting</b>			
	Attachment for wall mounting (for long valve terminals, 10 pieces)	Version for manifold sub-bases	<b>529040</b> CPX-BG-RW-10x
	Attachment for wall mounting, version for metal manifold sub-bases	2 mounting brackets, 4 screws	<b>550217</b> CPX-M-BG-RW-2X
		1 mounting bracket, 2 screws	<b>2721419</b> CPX-M-BG-VT-2X
<b>Covers and attachments</b>			
	Cover for CPX-AB-8-KL-4POL (IP65, IP67) • 8 cable through feeds M9 • 1 cable through feed for multi-pin plug		<b>538219</b> AK-8KL
	Fittings kit		<b>538220</b> VG-K-M9
	Screening plate for M12 connections		<b>526184</b> CPX-AB-S-4-M12
	Earthing element (5 pieces), for right-hand/left-hand end plate (plastic interlinking blocks)		<b>538892</b> CPX-EPFE-EV
	Inspection cover, transparent		<b>533334</b> AK-SUB-9/15-B
	Transparent cover for DIL switch and memory card		<b>548757</b> CPX-AK-P
	Cover for DIL switch and memory card		<b>548754</b> CPX-M-AK-M
	Cover plate for covering the DIL switches on CPX-M-FB21		<b>572818</b> CPX-M-FB21-IB-RL
	Cover for RJ45 connection		<b>534496</b> AK-RJ45
	Cover cap for RJ45 push-pull connection		<b>548753</b> CPX-M-AK-C
	Cover cap for bus connection		<b>2873540</b> CPX-M-AK-D
	Cover cap for closing off unused connections (10 pieces)	For M8 connections	<b>177672</b> ISK-M8
		For M12 connections	<b>165592</b> ISK-M12
	Coding element, so that a coded socket NECU-L3G8 can only be inserted in the matching coded connection block CPX-P-AB-2XKL (96 of each)	For NECU-L3G8	<b>565713</b> CPX-P-KDS-AB-2XKL

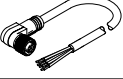
## Accessories

Ordering data – Accessories		Part no.	Type	
Designation				
<b>Function blocks</b>				
	Memory card for PROFINET bus node (CPX-FB33, CPX-M-FB34, CPX-M-FB35), 2 MB	4798288	CPX-SK-3	
	Terminating resistor, M12, B-coded for PROFIBUS	1072128	CACR-S-B12G5-220-PB	
	PT1000 temperature sensor for cold junction compensation	553596	CPX-W-PT1000	
	5-pin M12 to mini USB socket adapter and controller software	547432	NEFC-M12G5-0.3-U1G5	
<b>Inscription labels</b>				
	Inscription labels 6x10 mm, 64 pieces, in frame	18576	IBS-6x10	
	Inscription label holder for connection block	536593	CPX-ST-1	
<b>Multi-pin plug distributor</b>				
	Sub-D plug, 15-pin	8x socket M8, 3-pin	177669	MPV-E/A08-M8
		12x socket M8, 3-pin	177670	MPV-E/A12-M8
	Plug M12, 8 pin	4x socket M8, 3-pin	574586	NEDU-L4R1-M8G3L-M12G8
		6x socket, M8, 3-pin	574587	NEDU-L6R1-M8G3L-M12G8
<b>Connecting cable for multi-pin plug distributor</b>				
	Sub-D socket, 15-pin Open cable end, 15-wire	5 m	177673	KMPV-SUB-D-15-5
		10 m	177674	KMPV-SUB-D-15-10
	Angled socket, M12, 8-pin, Open cable end, 8-wire	Length: 2 m	542256	NEBU-M12W8-K-2-N-LE8
		Length: 5 m	542257	NEBU-M12W8-K-5-N-LE8
		Length: 10 m	570007	NEBU-M12W8-K-10-N-LE8
	Straight socket, M12, 8-pin, Open cable end, 8-wire	Length: 2 m	525616	SIM-M12-8GD-2-PU
		Length: 5 m	525618	SIM-M12-8GD-5-PU
		Length: 10 m	570008	SIM-M12-8GD-10-PU