

CPI installation system

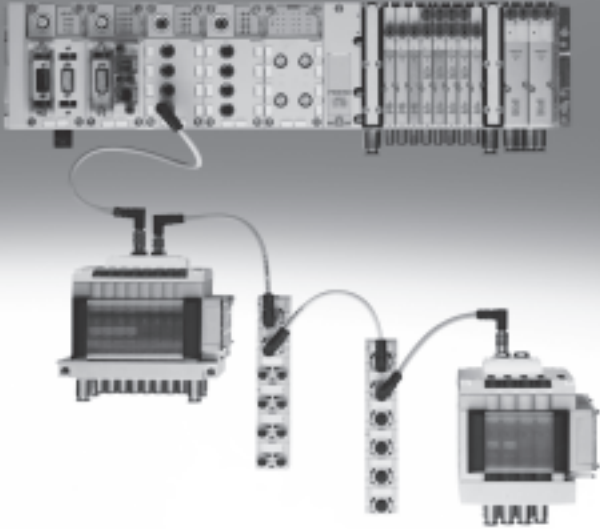

CPI installation system

Key features

FESTO

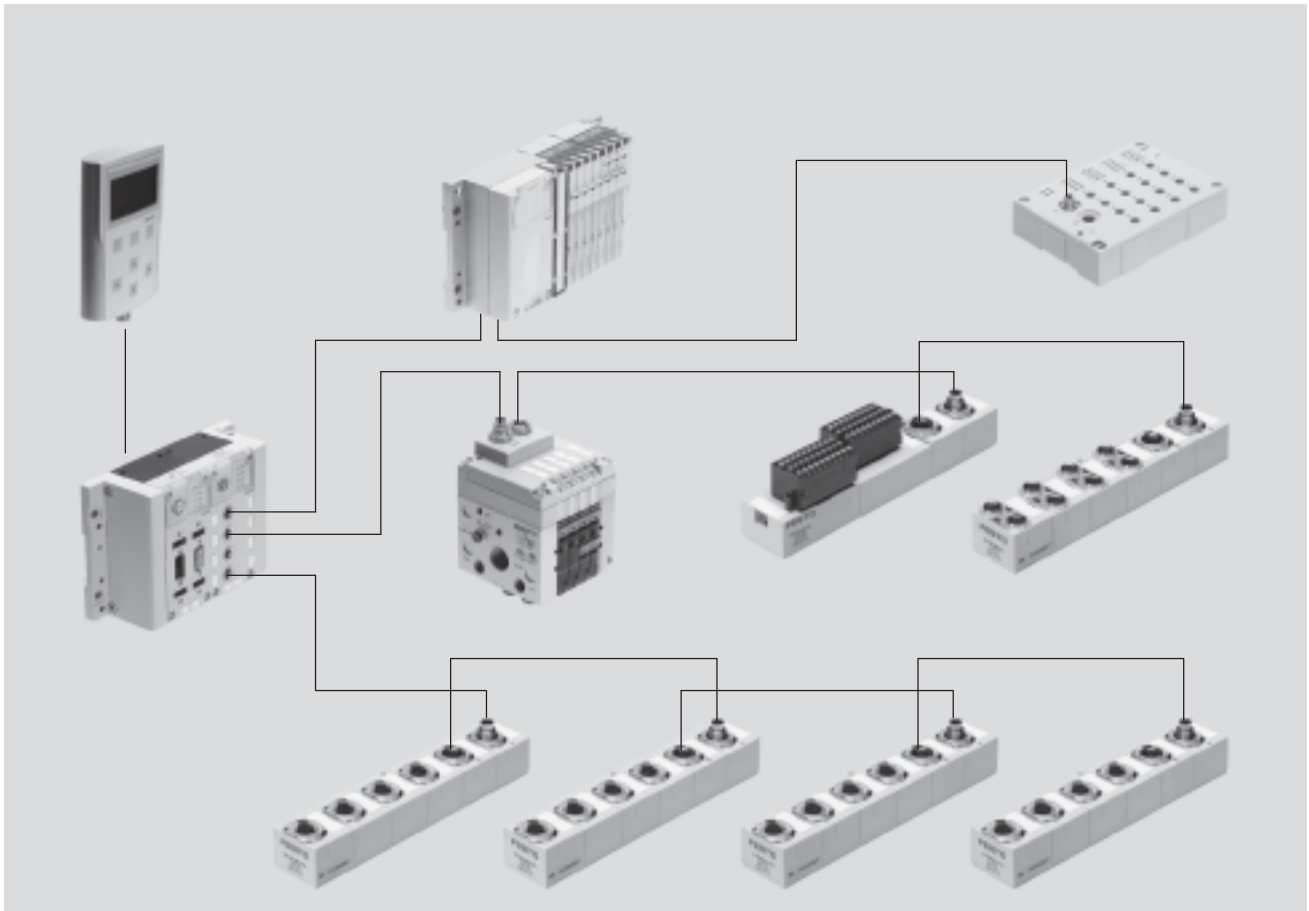

Innovative

- Complete concept for decentralised machine and system structure; centralised and decentralised installation can be combined with the CPX terminal
- Decentralised pneumatics and sensors for fast processes
- Centralised electrics for fieldbus and common power supply
- Flexible configuration of the individual CP strings
- Selectable valve terminal sizes for optimum pneumatic control loop systems
- Performance data as for the CP system with the addition of the comprehensive diagnostic capabilities of the CPX terminal

Sturdy

- Electrical accessories to IP65
- Proven valve terminals CPV (compact), MPA (sturdy, modular), CPV-SC (small, compact) and CPA (modular manifold sub-bases)
- Electrical input and output modules in metal housing or compact in encapsulated plastic housing
- Sturdy connection technology M12, alternatively M8
- IP20 modules for control cabinet installation with spring-loaded terminals or screw terminals

Versatile

- A number of CP interfaces can be combined under one fieldbus node
- Four CP strings up to 10 m in length (radius) facilitate optimum decentralisation
- Max. 32 inputs and 32 outputs/valves per string
- Available valves:
 - Valve terminal type 32 MPA, flow rate max. 700 l/min
 - Valve terminal type 10 CPV, flow rate max. 1,600 l/min
 - Valve terminal type 80 CPV-SC, flow rate max. 170 l/min
 - Valve terminal type 12 CPA, flow rate max. 650 l/min
- Input modules with 8 ... 32 inputs and output modules with 4 ... 8 outputs, each with or without additional power supply
- Universal electrical outputs

Reliable

- Sturdy modules and accessories
- Ready to install system including CP cable (hybrid cable for data and power)
- Polarity-safe and short circuit proof connections
- Valves with separate load voltage supply
- All modules equipped with local diagnostics and status LEDs
- Diagnostics of each CP string via controller/fieldbus
- Intelligent system (save button) "learns" current configuration
- Easy replacement of modules at any time

CPI installation system

Key features

CPI installation system

The CPI system is capable of meeting two completely different requirements and resolves the conflict between extensive decentralised modularisation and electrical installation.

High-speed machines require short cycle times and short pneumatic tubing. The valves must be mounted close to the cylinders. The CPI system was developed to meet these requirements without having to wire each valve individually.

The system integrates the modular valve terminals CPV, the manifold sub-base valve terminal CPA and various input/output modules in a single installation concept.

All CP valve terminals and CP modules are connected using a ready to install CP cable, and are attached to the CP interface. Four modules, for example one CPV valve terminal and one to three CP input modules, make up an installation string that ends at the CP interface.

Scope of features:

- Max. 4 installation strings per CP interface
- Max. 10 metre line length per string (radius)
- Max. 4 CP modules per string
- Max. 32 inputs and max. 32 outputs per string

The number of CP modules that can be connected and the number of inputs/outputs is dependent on the type of CP

module and CP interface. The maximum configuration (4 modules per string, 32 inputs/outputs) is only possible in combination with the CPX terminal and CP modules with CPI functionality.

The CP interface is the central connection point for the valve power supply and the sensor supply. The power supply for the sensors connected to the input modules is separate from the load voltage of the valves.

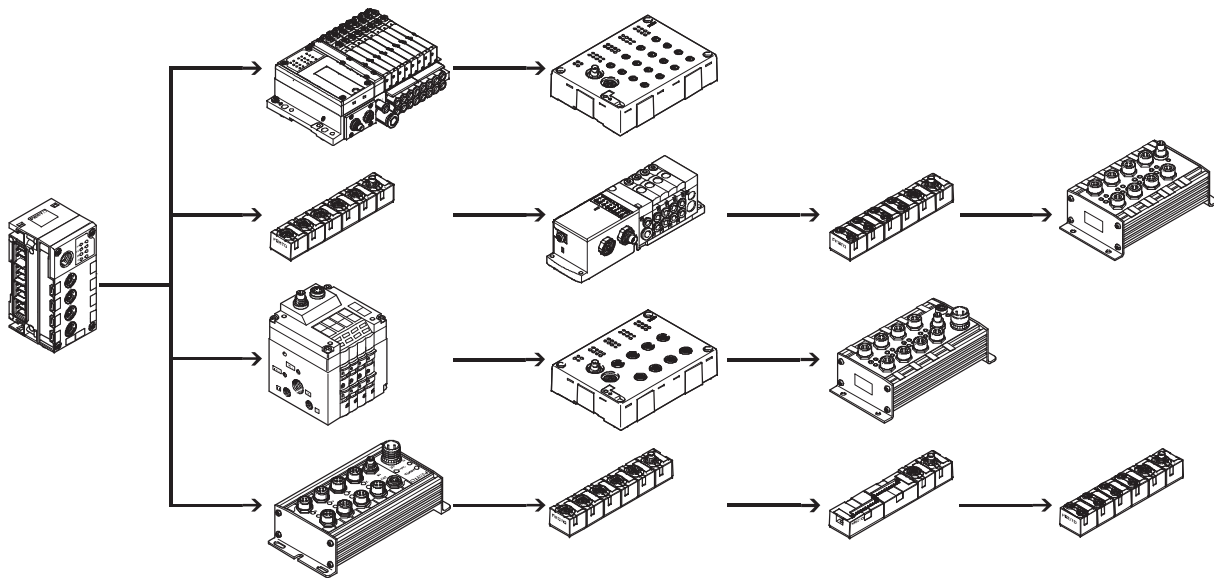

CPI installation system

Key features

FESTO

Node types:

Fieldbus/control block
CPX with CP interface
CPX-...

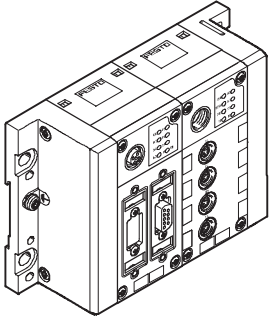

Fieldbus
Type 03/04 with CP interface
CP-FB-...

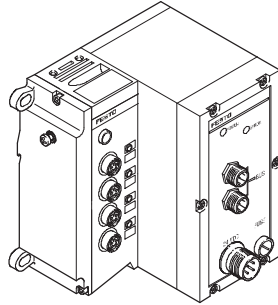

CP fieldbus node

CP-E

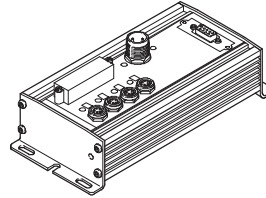

Valve terminal
with CP string extension
CPV, CPA-SC, CPV-SC, CDVI-DN, MPA

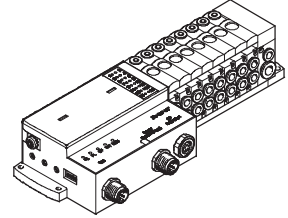

CPI installation system

Ordering system

FESTO

Configurator

Online via: → www.festo.com

Selecting a CPI system using the online catalogue is quick and easy thanks to the convenient configurator provided. This makes it much easier to find the right product.

Components from the CPI system series, type CTEC, are ordered using the order code.

Ordering system for type 55E
→ Internet:ctec

CPI installation system

Peripherals overview

FESTO

Integration of the CPI installation system in various connection concepts

Centralised pneumatic connection (valve terminal)

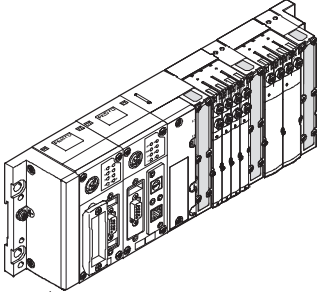

Advantages

- Pneumatic multiple connector plate
- Less tubing required than with individual valves
- Common valve air supply
- Central positioning
- Material, weight and cost savings

Disadvantages

- Only effective with a large number of closely spaced actuators
- Heavier than an individual valve (lower overall weight than the same number of individual valves), which may make assembly on moving systems or in very cramped installation spaces difficult
- Longer tube lengths are occasionally required, ruling out the possibility of optimum pneumatic performance

Decentralised pneumatic connection (individual valve/valve on individual sub-base)

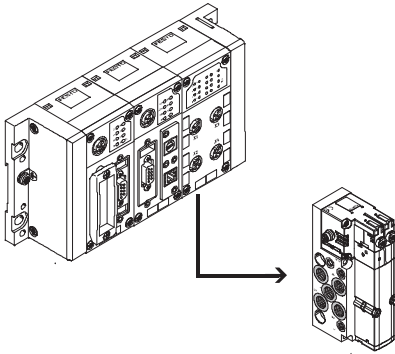

Advantages

- Can be positioned directly at the actuator, can even be integrated
- Short tubing length to the actuator enables short switching times
- Optimum pneumatic timing and performance possible

Disadvantages

- Air supply per valve requires more tubing
- Serial electrical interlinking not advisable/possible
- More complex electrical installation

CPI installation system

Peripherals overview

FESTO

Integration of the CPI installation system in various connection concepts

Centralised electrical connection (multi-pin plug/fieldbus connection/standalone minicontroller)

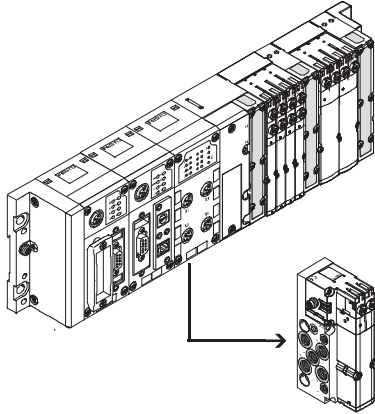

Advantages

- Internal electrical interlinking requires less cabling
- Increased transparency
- Material, weight and cost savings
- Ideal for connecting a large number of closely spaced valves

Disadvantages

- Not suitable for individual, more widely separated applications due to the more complex cabling
- More complex individual components (cables, fieldbus modules)

Decentralised electrical connection (CPI system/individual valve/valve on individual sub-base/valve manifold)

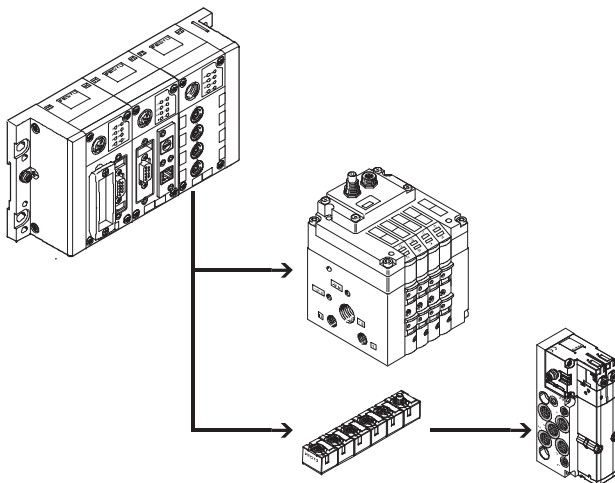

Advantages

- CPI system with reduced installation complexity for groups of actuators/sensors
- Different levels of complexity with widely separated individual components
- Easy replacement of components during servicing
- Optimum pneumatic timing and performance possible

Disadvantages

- Limited spatial expansion possible (CPI system up to 10 m, AS-interface up to 100 m)
- High installation costs

CPI installation system

Peripherals overview

FESTO

Integration of the CPI installation system in various connection concepts

Combined centralised and decentralised connection (valve terminal with CP interface/output module)

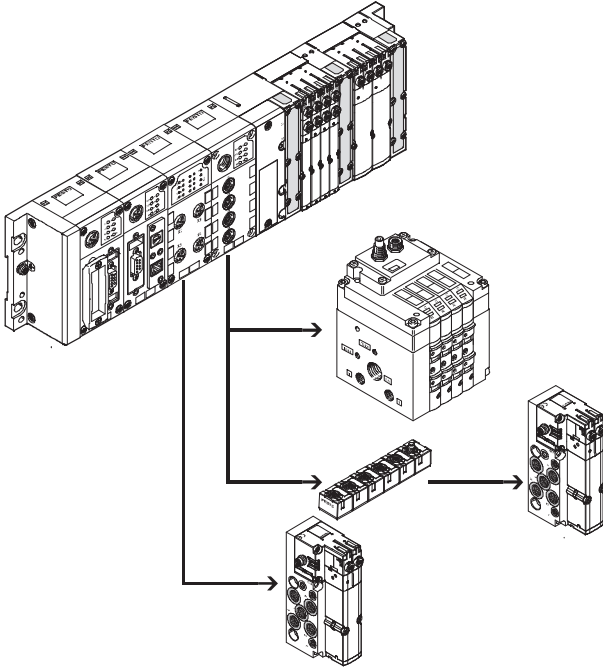

Advantages

- Can be scaled to different requirements within a system
- One control interface in the system, reduces installation complexity with closely and widely spaced actuators
- Enables an optimum electrical and pneumatic control chain

Disadvantages

- Application must at least partially meet the requirements of a centralised connection

Connection of the CPI installation system to a higher-level controller

Fieldbus node/Industrial Ethernet

Different bus nodes are used for integration in the control systems of various manufacturers.

The CPI system can therefore be operated via more than 90% of the most commonly used fieldbus systems.

- Profibus DP
- Profinet
- Interbus
- DeviceNet
- Ethernet IP
- CANopen
- CC-Link

Control block

The optional Front End Controller CPX-FEC enables simultaneous access via Ethernet and an integrated web server, as well as autonomous pre-processing.

- Ethernet
- TCP/IP
- Web

CPI installation system

Peripherals overview

Connection of the CPI installation system to a higher-level controller

Overview

FB6

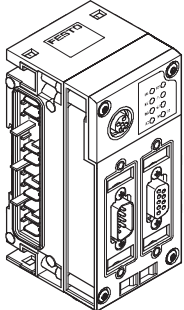

FB11

FB13

FB14

FB23

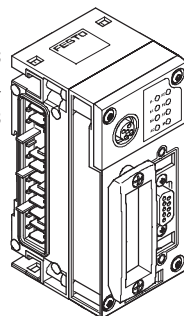

FB32

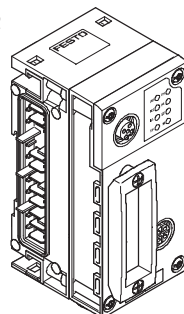

FB33

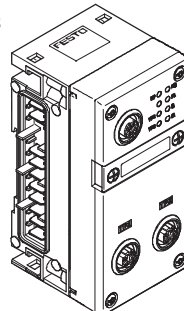

CPX-FEC

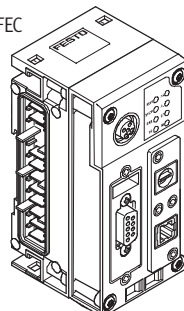

CPX CP interface

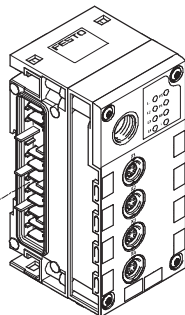

Bus protocol/fieldbus node

Interbus

FB6

Special features

- Up to 96 digital inputs/outputs
- 6 analogue inputs/outputs

DeviceNet

FB11

- Up to 512 digital inputs/outputs
- 18 analogue inputs/outputs

Profibus DP

FB13

- Up to 512 digital inputs/outputs
- 18 analogue inputs/outputs

CANopen

FB14

- Up to 64 digital inputs and 64 digital outputs
- 8 analogue inputs and 8 analogue outputs

CC-Link

FB23

- Up to 64 digital inputs/outputs
- 16 analogue inputs/outputs

Ethernet/IP

FB32

- Up to 128 digital inputs/outputs
- 8 analogue inputs/outputs

PROFINET RT

FB33

- Up to 512 digital inputs/outputs
- 32 analogue inputs/outputs

EtherCAT

FB38

- Up to 512 digital inputs/outputs
- 32 analogue inputs/outputs

Control block FEC

- Modbus TCP
- Easy-IP
- Interbus, DeviceNet, Profibus DP, CANopen and CC-Link via combination with CPX fieldbus node
- TCP/IP and web connection via Ethernet interface
- Up to 512 inputs/outputs
- Several CP interfaces can be connected
- Ethernet fieldbus slave in remote I/O operating mode (T05)
- Autonomous control of the CPI system as a remote controller (T03)

CPI installation system

Peripherals overview

Connection of modules in the CPI installation system

CP interface within the context of the CPX terminal

Using the CP interface as a module of the CPX terminal facilitates the progression from the CP system to the CPI system.

All CP modules are both downwards and upwards compatible and can therefore be used in the CP system and in the CPI system.

This extension has doubled the scalability and range of CP modules that can be used:

- 4 CP strings
- Up to 4 modules per string
- Up to 32 inputs and outputs per CP string

An added advantage of the CPI system is its extremely user-friendly access possibilities via the CPX fieldbus node and the CPX-FEC:

- Data pre-processing
- Diagnostics via software
- Reading out of status information
- Display via permanently installed or mobile unit
- Remote maintenance with CPX-FEC and Ethernet connection

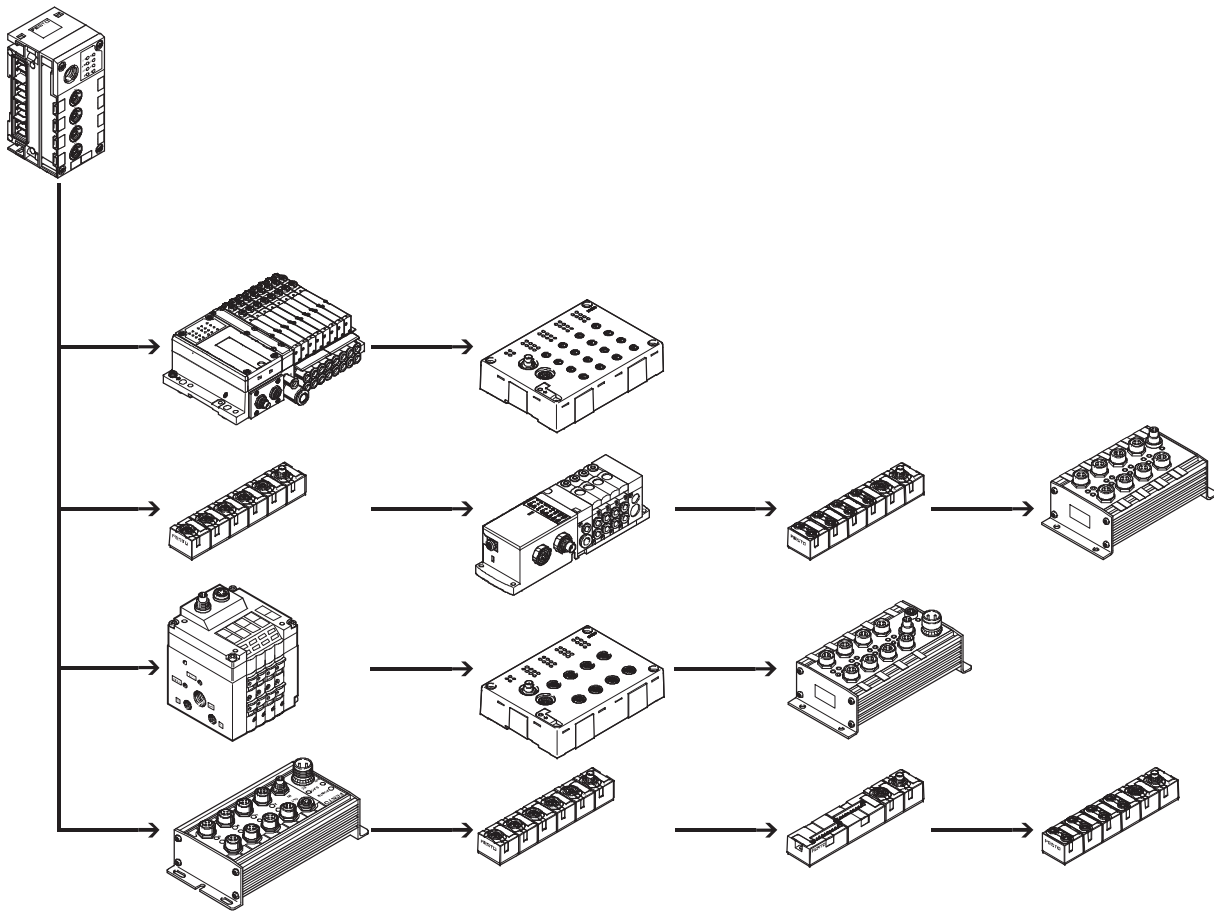

CPI installation system

Connection options

Fieldbus Direct			
Special feature	Application	Characteristics of Fieldbus Direct	
<p>The Fieldbus Direct product range is the most compact way of connecting valves to a fieldbus. The fieldbus node is directly integrated in the electrical actuation of the valve terminal and therefore takes up only a minimal amount of space.</p>	<p>Fieldbus Direct is a system for the compact connection of a valve terminal to nine different fieldbus standards. The most important fieldbus protocols including Profibus, Interbus, DeviceNet and CANopen are supported. The CP string extension option allows the functions and components of the CPI installation system to be used.</p>	<ul style="list-style-type: none"> Extremely compact and space-saving design Low-cost solution for the connection of a small number of valves to the fieldbus Direct front-end integration with a high degree of protection (IP65) Comprehensive diagnostics and condition monitoring 	<p> Note</p> <p>The range of functions and combination options of CPV, CPV-SC, CPA-SC, CDVI and MPA valves are described in detail in</p> <ul style="list-style-type: none"> → Internet: type 80 (Valve terminal CPV-SC) → Internet: cpasc (Valve terminal CPA-SC) → Internet: type 15 (Valve terminal CDVI) → Internet: type 10 (Valve terminal CPV) → Internet: type 32 (Valve terminal MPA)

Fieldbus Direct and CP string extension			
<p>The optional string extension allows a further valve terminal and I/O modules to be connected to the Fieldbus Direct fieldbus node.</p> <ul style="list-style-type: none"> A CP string of the CP system is integrated in the fieldbus node as an extension Different input and output modules as well as CPV, CPA and MPA valve terminals can be connected 	<p>The maximum length of the CP string extension is 10 metres, which means that the extension modules can be mounted directly on-site. All of the required electrical signals including load current supply are transmitted via the CP cable, which in turn means that no further installation is needed on the expansion module.</p>	<p>The CP string interface offers:</p> <ul style="list-style-type: none"> Max. 32 input signals Max. 32 output signals for output modules 24 V DC or solenoid coils Logic and sensor supply for the input modules 	<ul style="list-style-type: none"> Load voltage supply for the valve terminals Logic supply for the output modules

CPI installation system

Connection options

FESTO

Fieldbus Direct with CP string extension

CPV valve terminal

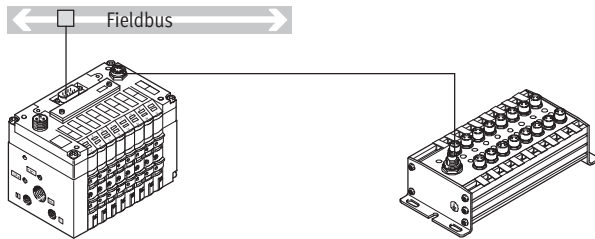

- 4 to 8 valve positions
- DeviceNet
- CANopen
- Profibus DP
- ABB CS31
- Interbus
- Moeller Suconet
- Festo fieldbus
- Beckhoff
- CC-Link
- 4 to 16 solenoid coils

Further information

➔ Internet: type 10

CPA-SC

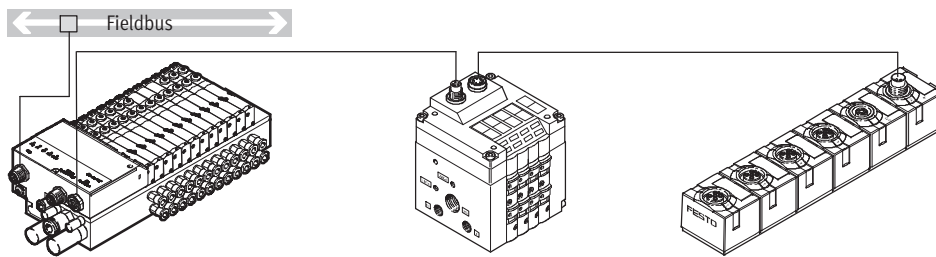

- 4 to 24 valve positions
- DeviceNet connection
- Profibus DP
- 4 to 32 solenoid coils

Further information

➔ Internet: cpasc

CPV-SC

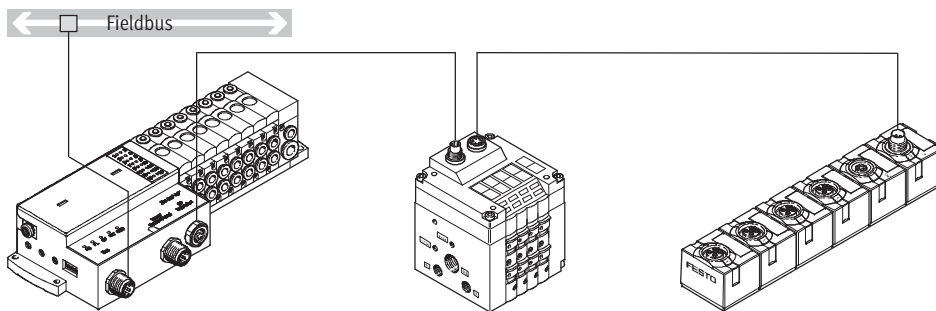

- 4 to 16 valve positions
- DeviceNet connection
- Profibus DP
- 4 to 16 solenoid coils

Further information

➔ Internet: type 80

CDVI-DN

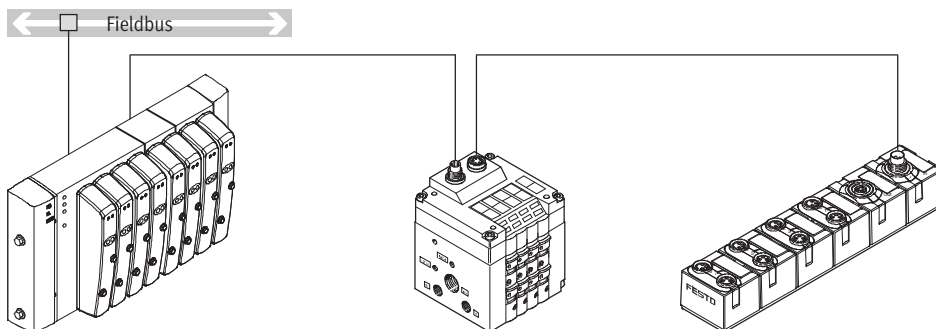

- 4 to 16 valve positions
- DeviceNet connection
- 4 to 24 solenoid coils

Further information

➔ Internet: type 15

CPI installation system

Connection options

Positioning systems

Application

The SPC200 is a position controller (closed loop) and positioning control (open loop) in one. Together with the drive, the displacement encoder and the proportional directional control valve, it forms a closed control loop.

The CP interface option enables the functions and components of the CP installation system to be used.

Properties

- Modular with 9 different plug-in cards
- Wide variety with up to 4 positioning axes, stepper motor axes and the option of operating pneumatic and electrical systems
- Flexible with set selection for positioning tasks with fixed trajectories and program mode with up to 100 programs
- Quick commissioning using the WINPISA diagnostic and programming tool

Positioning systems and CP interface

The plug-in cards for connecting the axis strings facilitate the connection of further input/output modules:

- One CP string of the CP system is possible as an extension
- Various input and output modules as well as CPV valve terminals can be connected

The maximum length of the CP string extension is 10 metres, which means that the extension modules can be mounted directly on-site. All of the required electrical signals including load current supply are transmitted via the CP cable, which in turn means that no further installation is needed on the extension module.

The CP string interface offers:

- 16 input signals
- 16 output signals for output modules 24 V DC or solenoid coils
- Logic and sensor supply for the input modules
- Load voltage supply for the valve terminals
- Logic supply for the output modules

Note
CP input modules can only be connected via a terminating resistor (KZW-M9-R100).

Axis controller SPC200 with CP interface

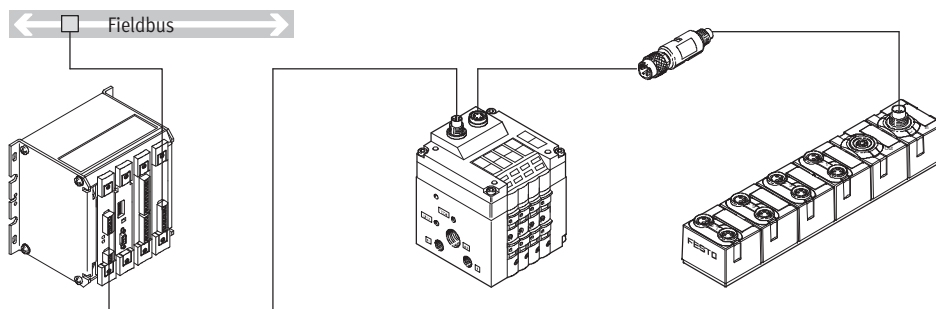

- Max. 64 inputs and 64 outputs via fieldbus
- DeviceNet, Interbus or Profibus connection

Further information
→ Internet: spc200

Compact vision system SBOC-Q/SBOI-Q with CP interface

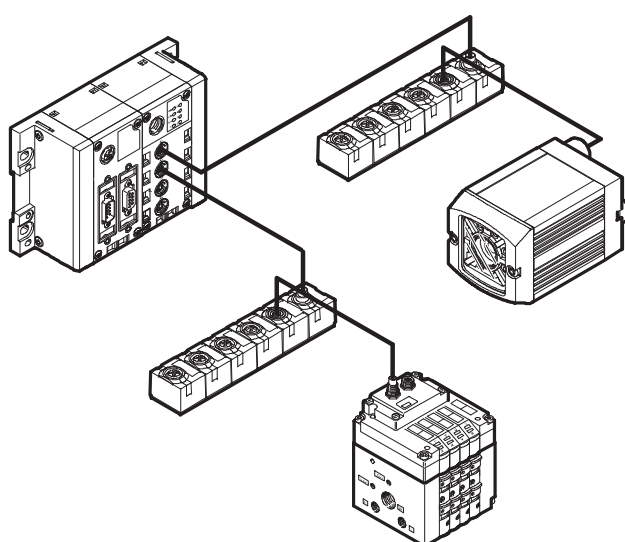

The compact vision system SBOx-Q can be integrated into a Festo CPI network. In this case it functions like a binary module with 16 inputs and outputs.

In combination with a CPX-CPI module and a CPX fieldbus, for example, the camera can be accessed via Profibus DP, Interbus, DeviceNet, CANopen and CC-Link.

- Address requirement: 16 digital inputs/outputs
- CPI connection

Further information
→ Internet: sbo

CPI installation system

Connection options

Connection of input and output modules in the CPI installation system

CP connecting cable



KVI-CP-3-...

Note

The total length of all CP cables in a CP string must not exceed 10 m.

- Pre-assembled cables for connecting the CP modules
- Lengths from 0.25 to 8 metres
- M9 plug/socket, 5-pin
- Straight/angled version in any combination

Further information

➔ Internet: kvi-cp

CP input/output modules in sturdy, universal and compact design or as a valve terminal

The connection technology for the sensors and additional actuators offers a wide range of digital and analogue input and output modules and is freely selectable – depending on your standard or application:

- M12-5PIN
- M8-3PIN
- M8-4PIN
- Spring-loaded terminal or screw terminal technology

The maximum number of inputs/outputs that can be connected to the individual modules can vary depending on the application. The following module sizes are available:

- Input modules with 8, 16 or 32 channels
- Output modules with 4 or 8 channels
- CPV with 4, 6 or 8 valve slices (max. 16 valves)
- MPA with 2 ... 32 valves
- CPV-SC with 4 ... 16 valves
- CPA with 2 ... 16 valves

Valve terminals with CP interface

CPV valve terminal

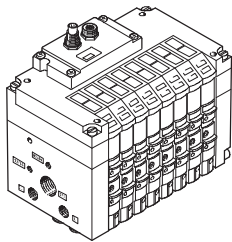

CPV10
CPV14
CPV18

- Max. 16 valves in 8 valve slices
- Highly compact and space-saving
- Width 10, 14, 18 mm
- Nominal flow rate 400/800/1600 l/min
- CPV10 and CPV14 with CPI functionality
- CPV18 with CP functionality

Further information

➔ Internet: type 10 (Valve terminal CPV)

MPA valve terminal

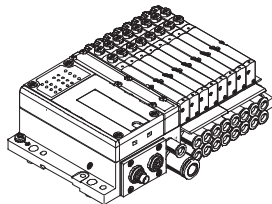

MPA1
MPA2

- Max. 32 valves
- Modular and versatile
- Width 10, 20 mm
- Nominal flow rate 360/700 l/min
- CPI functionality

Further information

➔ Internet: type 32 (Valve terminal MPA)

CPV-SC valve terminal

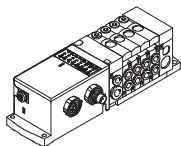

CPV-SC

- Max. 16 valves
- Extremely compact
- Width 10 mm
- Nominal flow rate 170 l/min
- CPI functionality

Further information

➔ Internet: type 80 (Valve terminal CPV-SC)

CPA valve terminal

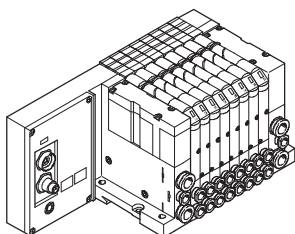

CPA10
CPA14

- Max. 16 valves
- Width 10, 14 mm
- Nominal flow rate 300/600 l/min
- CP functionality

Further information

➔ Internet: type 12 (Valve terminal CPA)

CPI installation system

Key features – Input/output modules

Connection of input and output modules in the CPI installation system

Special features of the CP input/output modules of sturdy design

The sturdy CP input/output modules have a highly resistant aluminium housing and its internal electronic components can be repaired or replaced.

As a CP-E...Z or output modules they have a separate load voltage supply, which means less load on the CP interface and CP cable and more power for

the connected consuming devices. This also facilitates separate disconnection of the consuming devices.

High degree of protection (IP65), surpassed only by the compact CP modules with IP65/67 protection. The only exception is the IP20 protection offered by the module with clamped terminal connection for installation in control cabinets.

CP input modules of sturdy design

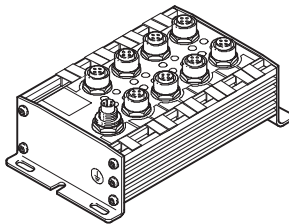

CP-E16-M12x2-5POL
CP-E16N-M12x2

- 16 inputs 24 V DC
- Signal status display via 16 LEDs
- Operating status display
- CP functionality

- M12 plug, double allocation
- 1x M9 CP connection
- PNP/NPN, IP65

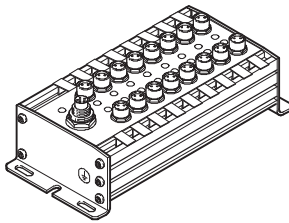

CP-E16-M8
CP-E16N-M8

- 16 inputs 24 V DC
- Signal status display via 16 LEDs
- Operating status display
- CP functionality

- M8 plug, single allocation
- 1x M9 CP connection
- PNP/NPN, IP65

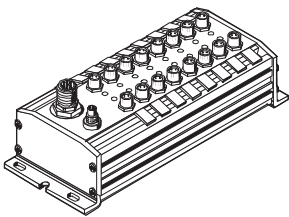

CP-E16-M8-Z

- 16 inputs 24 V DC
- Signal status display via 16 LEDs
- Operating status display
- CP functionality

- Galvanic isolation through additional power supply
- M8 plug, single allocation
- 1x M9 CP connection
- Separate sensor supply
- PNP/NPN, IP65

CP output modules of sturdy design

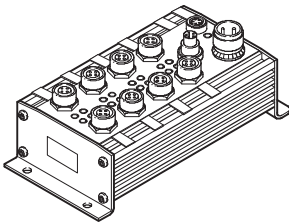

CP-A08-M12-5POL
CP-A08N-M12

- 8 outputs 24 V DC
- Output signal display via 8 LEDs
- Operating status display
- M12 plug, single allocation
- CP functionality

- 2x M9 CP connection
- Separate load voltage
- Outputs resistant to overloads and short circuits
- PNP/NPN, IP65

CPI installation system

Key features – Input/output modules

Connection of input and output modules in the CPI installation system

Special features of the CP input/output modules of economical design

In addition to the sturdy CP input/output modules and the compact CP input/output modules, there are also the economical modules with the design features of the compact modules, but with a greater number of inputs/outputs.

The economical CP modules feature a compact design, coupled with a large number of inputs/outputs.

The modules can be used in connection with the following valve terminals:

- CPV, MPA, CPV-SC, CPA-SC, CDVI, CPA

Application:

- Same function, configuration and commissioning as sturdy or compact CP modules
- Integrated H-rail mounting and earthing plate
- Centrally placed status and diagnostic LEDs
- The economical CP modules and the other CP modules can be operated together on a string

- The maximum number of modules per CP string is as follows:
 - CPI system: max. 4 modules or max. 32 inputs and 32 outputs
 - CP system: one valve terminal/output module and one input module

CP input modules of economical design

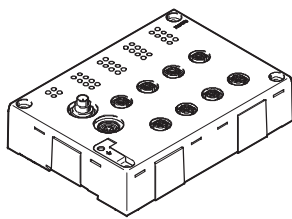

CP-E16-M12-EL

- 16 inputs 24 V DC
- Signal status display via 16 LEDs
- Operating status display (per module and per group of four inputs)
- CPI functionality

- 8x M12 plug, 5-pin, double allocation
- 2x M9 CP connection
- PNP, IP65

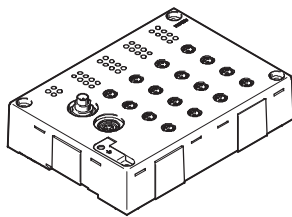

CP-E16-M8-EL

- 16 inputs 24 V DC
- Signal status display via 16 LEDs
- Operating status display (per module and per group of four inputs)
- CPI functionality

- 16x M8 plug, 3-pin, single allocation
- 2x M9 CP connection
- PNP, IP65

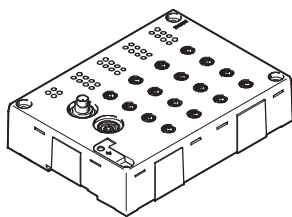

CP-E32-M8-EL

- 32 inputs 24 V DC
- Signal status display via 32 LEDs
- Operating status display (per module)
- CPI functionality

- 16x M8 plug, 4-pin, double allocation
- 2x M9 CP connection
- PNP, IP65

CP output modules of economical design

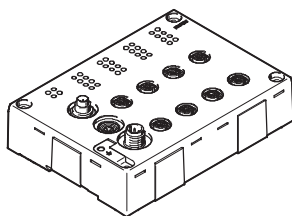

CP-A08-M12-EL-Z

- 8 outputs 24 V DC
- Signal status display via 4 LEDs
- Operating status display (per module and per channel/output)
- CPI functionality

- 8x M12 plug, 5-pin, double allocation
- 2x M9 CP connection
- Outputs resistant to overloads and short circuits
- PNP, IP65

CPI installation system

Key features – Input/output modules

Connection of input and output modules in the CPI installation system

Special features of the CP input/output modules of compact design

In addition to the sturdy and economical CP input/output modules, there is also the compact series of CP input/output modules. These have an optimised, compact design, are made from plastic and are very light. They are, of course, available with the high degree of protection IP65/67 (exception: terminal modules in IP20 for installation in a protected fitting space).

The compact CP modules are designed for use in handling and assembly wherever space requirements and product weight play a role.

The modules can be used in connection with the following valve terminals:

- CPV, MPA, CPV-SC, CPA-SC, CDVI, CPA

Application:

- The modules can be positioned closer to the actuators thanks to the smaller dimensions
- Same function, configuration and commissioning as sturdy or economical CP modules
- The compact CP modules and the other CP modules can be operated together on a string

- The maximum number of modules per CP string is as follows:
 - CPI system: max. 4 modules or max. 32 inputs and 32 outputs
 - CP system: one valve terminal/output module and one input module

CP input modules of compact design

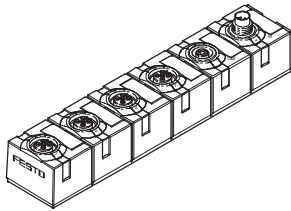

CP-E08-M12x2-CL

- 8 inputs 24 V DC
- Signal status display via 8 LEDs
- Operating status display
- CPI functionality

- 4x M12 plug, 5-pin, double allocation
- 2x M9 CP connection
- PNP, IP65/67

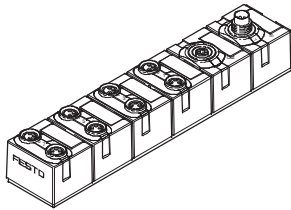

CP-E08-M8-CL

- 8 inputs 24 V DC
- Signal status display via 8 LEDs
- Operating status display
- CPI functionality

- 8x M8 plug, 3-pin, single allocation
- 2x M9 CP connection
- PNP, IP65/67

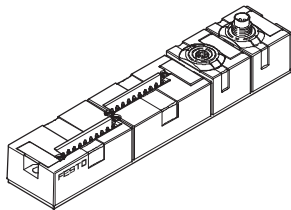

CP-E16-KL-CL

- 16 inputs 24 V DC
- Indirect signal status display via LEDs in the connection set of the tension-spring socket
- Operating status display
- CPI functionality

- Screw terminal or tension-spring sockets
- 2x M9 CP connection
- PNP, IP20

CP output modules of compact design

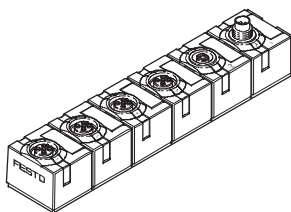

CP-A04-M12x2-CL

- 4 outputs 24 V DC
- Signal status display via 4 LEDs
- Operating status display
- CPI functionality

- 4x M12 plug, 5-pin, double allocation
- 2x M9 CP connection
- Outputs resistant to overloads and short circuits
- PNP, IP65/67

CPI installation system

Key features – Mounting options

FESTO

H-rail mounting

CP interface

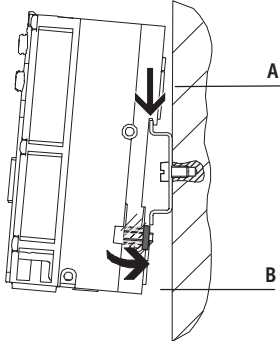

The H-rail mounting is formed in the reverse profile of the CPX interlinking blocks. The CPX terminal can be attached to the H-rail using the H-rail mounting.

The CPX terminal is attached to the H-rail as follows (see arrow A). It is first swivelled on the H-rail and then secured in place with the clamping component (see arrow B).

The following mounting kit is required for H-rail mounting (plus mounting kit for optionally mounted valves):

- CPA-BG-NRH
- This enables mounting on H-rails to EN 60715.

Economical CP modules

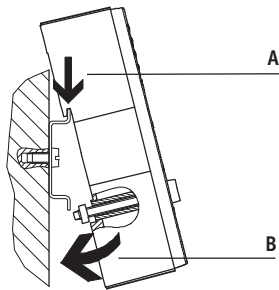

The H-rail mounting is impressed in the reverse profile of the economical CP modules. The modules can be attached to the H-rail using the H-rail mounting.

The module is attached to the H-rail as follows (see arrow A). It is first swivelled on the H-rail and then secured in place with the clamping component (see arrow B).

The scope of delivery includes the following mounting kit for H-rail mounting:

- CP-EL-HS
- This enables mounting on H-rails to EN 60715.

Compact and sturdy CP modules

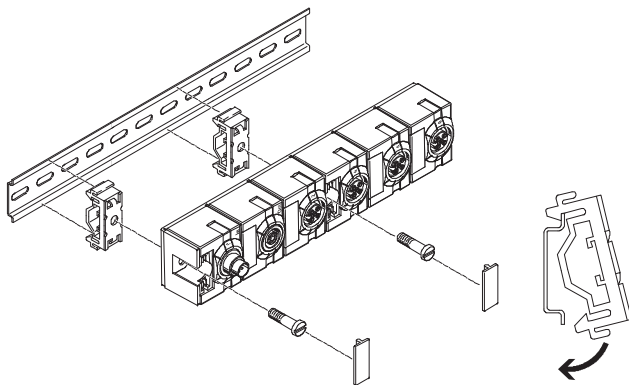

For the CP modules there is a mounting kit that can be used on an H-rail. On the compact CP modules, the mounting holes are covered by inscription labels.

The following mounting kit is required for H-rail mounting:

- CP-TS-HS35
- This enables mounting on H-rails to EN 60715.

CPI installation system

Key features – Mounting options

FESTO

Wall mounting

CP modules

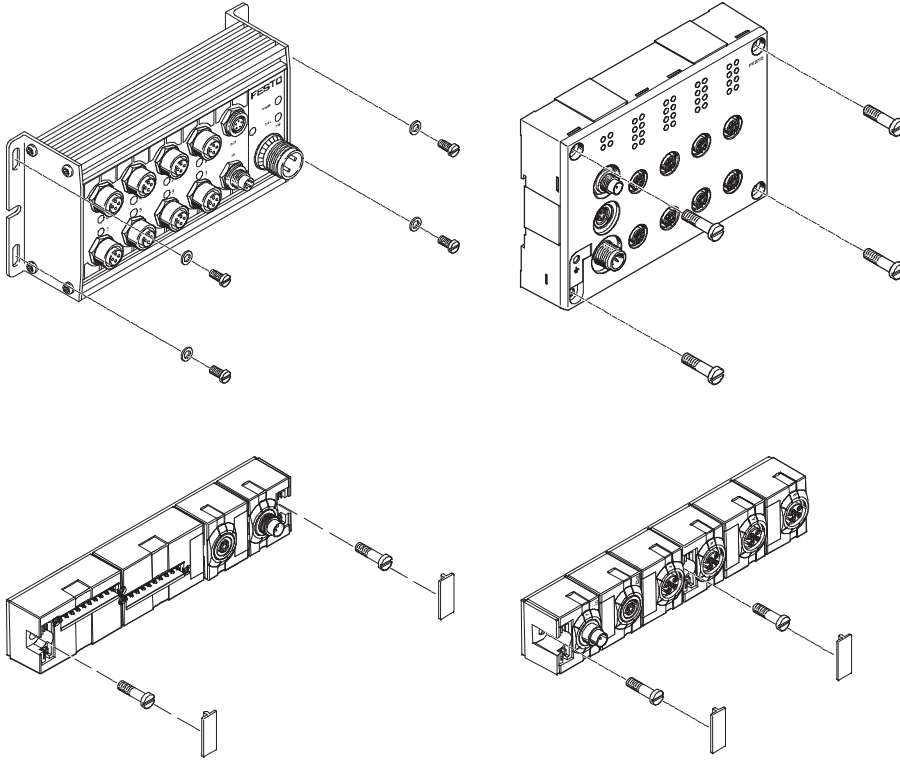

The CP modules (with screws up to 4 mm in diameter) can be mounted on even surfaces in almost any position using the mounting holes.

-  - Note

The mounting holes on the compact CP modules are covered by inscription labels.

CPI installation system

Key features – Inscription system

FESTO

Inscription system

All CP modules have holders for inscription labels.

Inscription labels/holders are not included in the scope of delivery and can be ordered separately.

The labels can be pre-assembled on request.

Robust CP modules

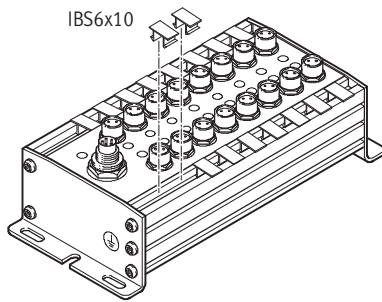

The sturdy CP modules have two slots in which the inscription labels IBS6x10 (Part No. 18576) can be fitted. At least one inscription label can be fitted per connection.

The IBS6x10 are plastic clips that can be printed on, written on or affixed with labels.

Economical CP modules

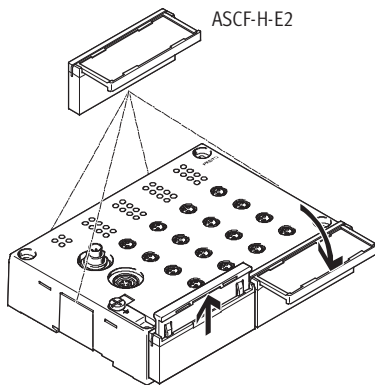

The economical CP modules have six lateral fixtures for one inscription label holder ASCF-H-E2 each (Part No. 547473).

The ASCF-H-E2 are transparent hinged label holders for holding pre-assembled paper inscription labels. The label can be read when the label holder is opened out.

Compact CP modules

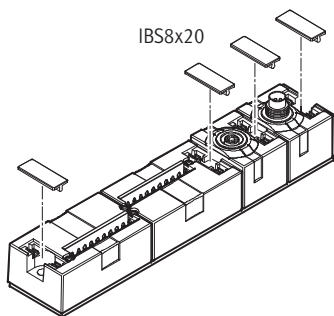

The compact CP modules have a holder for an inscription label IBS8x20 (Part No. 539388) for each connection.

The IBS8x20 are plastic clips that can be printed on, written on or affixed with labels.

CPI installation system

Key features – Power supply

Operating voltage and load current supply

The following functions are made available to the connected modules through the CP cable:

- Connection for data exchange
- Operating voltage for internal electronics
- Load current supply for the connected inputs/sensors and/or outputs/actuators

CP-E...Z or output modules from the sturdy and the economical series have a separate load voltage supply:

- Less load on the CP interface and CP cable
- 0.5 A per output (max. 4 A supply per output module)
- 1 A per 8 inputs
- Separate disconnection of the consuming devices possible

Every module in the CPI system is protected separately against overload with electronic fuses.

The input modules without additional supply provide a maximum sensor supply of 500 mA in the sturdy design, 800 mA in the compact design and

700 mA in the economical design with 16 inputs and 1400 mA with 32 inputs.

The input modules with additional supply provide up to 2 A residual current for the connected sensors.

Example of circuits for additional power supply

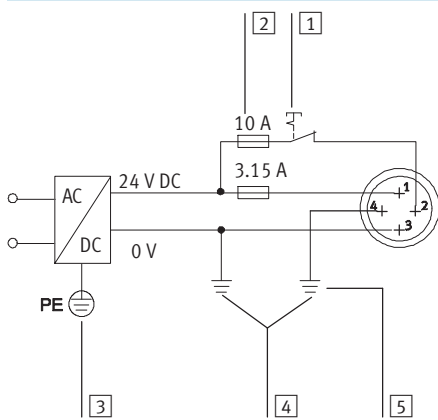

- 1 Load voltage supply (can be disconnected separately)
- 2 External fuses
- 3 Protective earth
- 4 Equipotential bonding
- 5 Earth terminal on pin 4, rated for 12 A

Pin allocation of plug for additional power supply

Pin allocation	Pin	Signal	Designation
	1	24 V DC	Supply for electronics and inputs
	2	24 V DC	Load supply for valves/outputs
	3	0 V	Equipotential bonding
	4	0 V	Earth terminal and equipotential bonding, rated for 12 A

CPI installation system

Key features – Power supply

Power supply concept of the CPX terminal

Circuit diagram for M18 power supply/system supply (example)

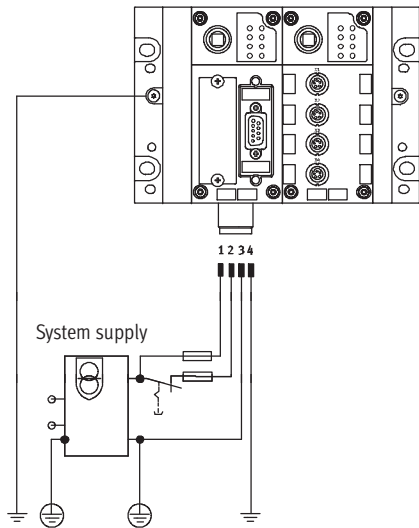

The use of decentralised devices on the fieldbus – particularly with high protection for direct machine mounting – demands a flexible power supply concept.

The CPX terminal facilitates the connection of all voltages via one socket.

A distinction is made between supply for

- electronics and sensors/inputs
- valves
- actuators/outputs

Selectable connecting thread:

- M18
- 7/8"
- AIDA push-pull

 Note

The CP interface connects the 0 V of the power supply for the electronics/inputs and the valves. To prevent overloads, the power must therefore

be supplied using just one power supply module or using power supply units with a common earthed conductor.

Interlinking blocks

Many applications require segmenting of the voltage into zones. This is true in particular of the separate disconnection of connected actuators (solenoid coils/outputs).

The separation of voltages for valves and the realisation of different voltage segments for electrical outputs and sensors are supported by the different

interlinking blocks of the CPX terminal:

- With system supply
- Without power supply
- With additional power supply for electrical outputs
- With additional power supply for valves

The supply voltages are supplied using a

- 4-pin M18 plug
- 4-pin 7/8" plug
- 5-pin 7/8" plug
- AIDA push-pull, 5-pin

 Note

The max. current is limited to 12 A with the 7/8" system supply. When using a conventional pre-assembled cable, the max. current is limited to 8 A.

CPI installation system

Key features – Diagnostics

General limits

System supply

The system supply provides the internal voltage for the entire CPX system with

- max. 16 A for electronics and sensors/inputs
- max. 16 A for actuators/outputs and valves

CP interface

The CP interface and the CP modules connected to the CP interface get their operating voltage from the connection for electronics and sensors/inputs.

The operating voltage for the sensors/actuators connected to the CP modules is supplied from the voltage for valves. The CP interface supplies the

connected CP modules with
The CP interface supplies the connected CP modules with

- max. 1.6 A per CP string

Diagnostics

General information

A comprehensive diagnostic function is available for each string.

The diagnostic information can either be detected via the LEDs on the module and then read out and evaluated via the controller software (non-field-bus-specific) or displayed directly on the CPX terminal via the CPX-MMI and then evaluated and edited.

Diagnostics via LED

- Error in bus communication
- POWER, power supply display for internal electronics
- POWER V, load voltage display for valves
- 0 ... 3, CP string allocation changed or interrupted

There are also bus-specific LED displays.

Diagnostics via control program/CPX-MMI

- Configuration error
- Bus error
- Operating voltage failure
- Falling below voltage tolerance (valves)
- Short circuit in sensor voltage supply

- Operating voltage failure at the output modules
- Short circuit/overload at the output modules
- Connection to one or more CP modules interrupted (valve terminal, input/output modules)

Diagnostics via CPX terminal

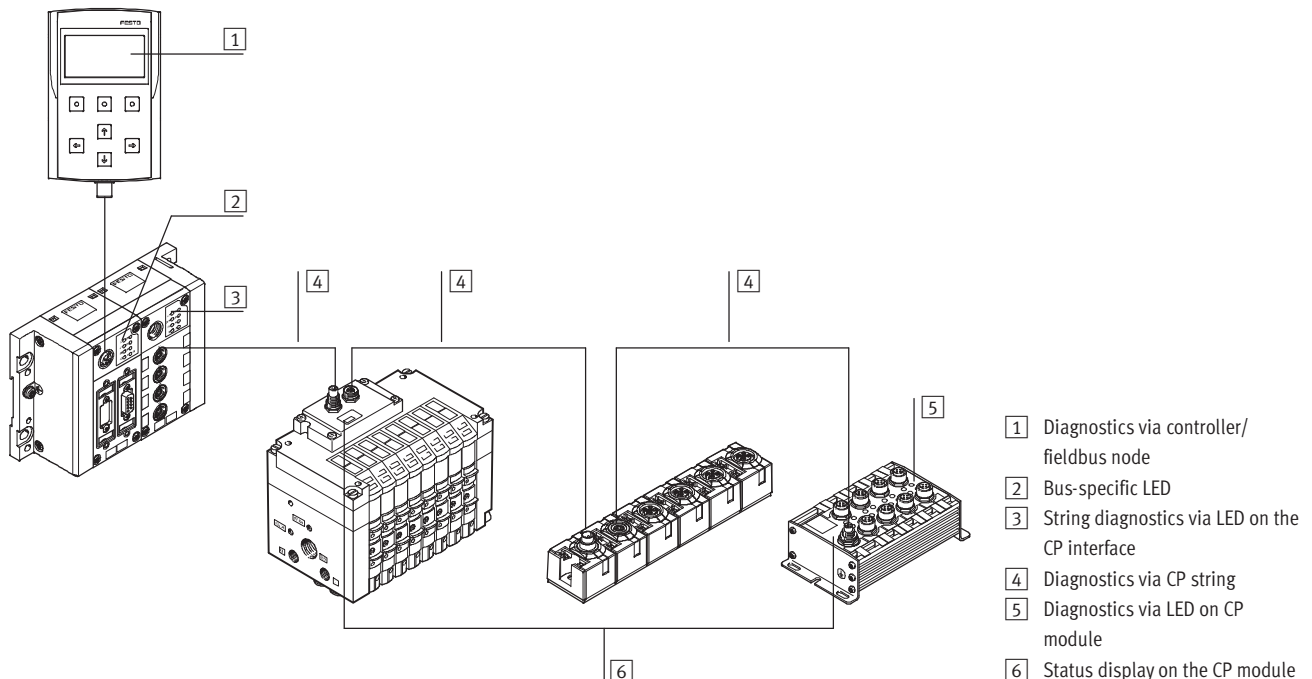

CPI installation system

Key features – CP interface

FESTO

Diagnostics

Diagnostics via CP fieldbus node

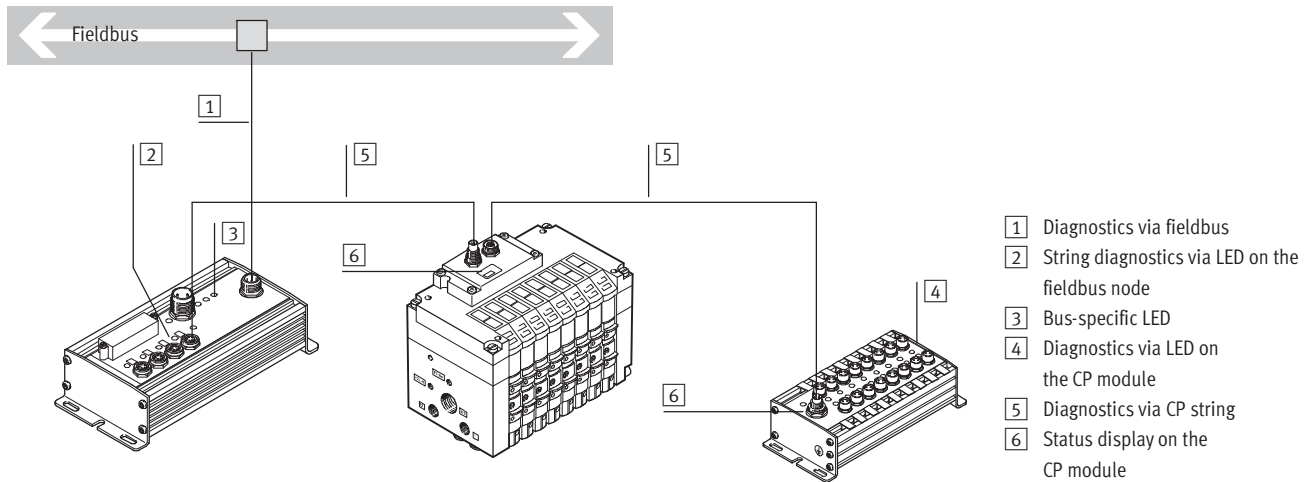

- 1 Diagnostics via fieldbus
- 2 String diagnostics via LED on the fieldbus node
- 3 Bus-specific LED
- 4 Diagnostics via LED on the CP module
- 5 Diagnostics via CP string
- 6 Status display on the CP module

Diagnostic LEDs on the CP modules

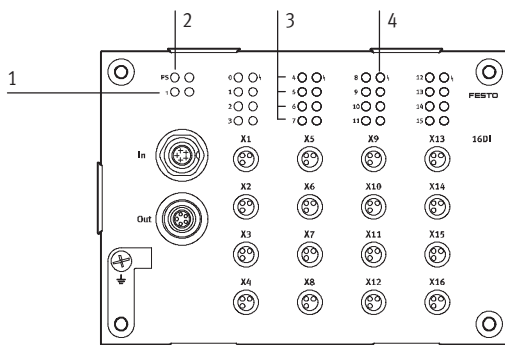

- 1 Status LED for CP communication (PS, green)
- 2 Status LED (module) for short circuit/overload of sensor supply (red)
- 3 Status LEDs for inputs (status display, green)
- 4 Status LED (group, only with CP-E16-...-EL) for short circuit/overload of sensor supply (red)

In addition to the status display per module and per individual channel/input, the economical modules with 16 inputs additionally have a status display for a group of four inputs. The following inputs are combined into groups of four:

- 0 ... 3
- 4 ... 7
- 8 ... 11
- 12 ... 15

Parameterisation

Allocation of the addresses to the individual actuators/outputs or sensors/inputs connected to the CP modules is performed in accordance with the fieldbus node or CPX-FEC used (exception: Interbus node). Address allocation is performed in accordance with the following rules:

- One CP interface provides four strings with a total of 128 inputs and 128 output addresses.
- A used string occupies 32 inputs and 32 output addresses.
- The addresses are permanently allocated to the strings and CP modules in ascending order.
- Unused address space remains reserved for future extensions.

The CP interface checks the configuration of the connected modules each time the system is switched on and during operation. If a deviation from the saved configuration is detected, an appropriate message is output via the controller software and displayed via LED. The configuration detected is stored by pressing the Save button (after the operating voltage is switched on at the CP interface).

The configuration is stored each time the CP interface is switched off and back on. The option is provided of replacing a connected CP module with a module of identical design during operation. Removal of more than one module from the current configuration will be detected as an error; the address spaces of these modules will no longer be actuated.

CPI installation system

Selection aid

System selection aid					
	Modules per string	Outputs/inputs per string	Modules with CP functionality	Modules with CPI functionality	String length [m]
CP system	2	16/16	0 ... 1 input module 0 ... 1 output module	0 ... 1 input module 0 ... 1 output module	0 ... 10
CPI system	4	32/32	0 ... 1 input module 0 ... 1 output module	0 ... 4 input modules 0 ... 4 output modules	0 ... 10

Module selection aid							
	Functionality		Additional power supply	Address requirement		Max. current consumption [A]	→ Page/Internet
	CP	CPI		Inputs	Outputs		
Input modules							
CP-E16-M8	■	-	-	16	-	0.54	47
CP-E16N-M8	■	-	-	16	-	0.59	47
CP-E16-M12x2-5POL	■	-	-	16	-	0.59	47
CP-E16N-M12x2	■	-	-	16	-	0.59	47
CP-E16-M8-Z	■	-	■	16	-	1.04	47
CP-E32-M8-EL	-	■	-	32	-	1.4	53
CP-E16-M8-EL	■	■	-	16	-	0.7	53
CP-E16-M12-EL	■	■	-	16	-	0.7	53
CP-E08-M12-CL	■	■	-	8	-	0.835	59
CP-E08-M8-CL	■	■	-	8	-	0.835	59
CP-E16-KL-CL	■	■	-	16	-	0.835	59
Output modules							
CP-A08-M12-5POL	■	-	■	-	8	2.09	65
CP-A08N-M12	■	-	■	-	8	2.09	65
CP-A08-M12-EL-Z	■	■	■	-	8	4	69
CP-A04-M12-CL	■	■	-	-	4	1.035	73
Connecting cables							
KVI-CP-3-...	■	■	-	-	-	1.6	kvi-cp
Valve terminals							
CPV10-FB-4	■	■	-	-	16	0.327	type 10
CPV10-FB-6	■	■	-	-	16	0.465	type 10
CPV10-FB-8	■	■	-	-	16	0.604	type 10
CPV14-FB-4	■	■	-	-	16	0.419	type 10
CPV14-FB-6	■	■	-	-	16	0.603	type 10
CPV14-FB-8	■	■	-	-	16	0.788	type 10
CPV18-FB-4	■	■	-	-	16	0.624	type 10
CPV18-FB-6	■	■	-	-	16	0.911	type 10
CPV18-FB-8	■	■	-	-	16	1.197	type 10
CPA10	■	-	-	-	16	0.31	type 12
CPA14	■	-	-	-	16	0.5	type 12
MPA	-	■	■	-	32	3.25	type 32
CPV-SC	-	■	-	-	16	0.875	type 80

CPI installation system

Selection aid

FESTO

Accessory selection aid

Connection M8, 3-pin

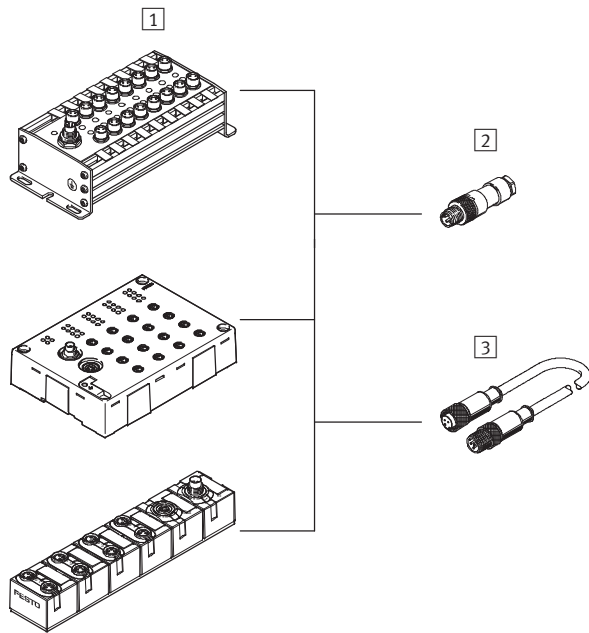

-  - Note

Festo delivers pre-assembled M8/M12 connecting cables (NEBU modular system) on customer request:

- application tailored
- perfectly fitting
- installation saving

1 Input modules
Type
CP-E16-M8
CP-E16N-M8
CP-E16-M8-Z
CP-E16-M8-EL
CP-E08-M8-CL

Plug connector/connecting cable	
Type	Connection technology
2 Plug connector	
SEA-GS-M8	Solder lug
SEA-3GS-M8-S	Screw terminal
3 Connecting cable	
KM8-M8-GSGD-...	Socket M8, 3-pin
NEBU-...-M8G3	Socket M5, 3-pin
	Socket M8, 3-pin
	Socket M8, 4-pin
	Socket M12, 5-pin
	Open cable end

CPI installation system

Selection aid

Accessory selection aid

Connection for inputs M8, 4-pin

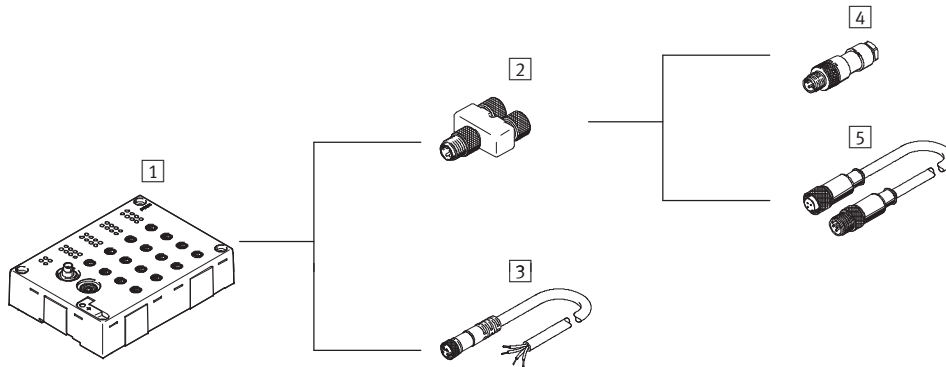

-  - Note

Festo delivers pre-assembled M8/M12 connecting cables (NEBU modular system) on customer request:

- application tailored
- perfectly fitting
- installation saving

1	Input modules
Type	
CP-E32-M8-EL	

Plug connector/connecting cable	
Type	Connection technology
2 T-adaptor	
NEDU-M8D3-M8T4	2x socket M8, 3-pin
3 Connecting cable	
NEBU-...-M8G4	Socket M5, 3-pin
	Socket M8, 3-pin
	Socket M8, 4-pin
	Socket M12, 5-pin
	Open cable end

Plug connector/connecting cable		
Connection technology	Type	Connection technology
4 Plug connector		
Plug M8, 3-pin	SEA-GS-M8	Solder lug
Plug M8, 3-pin	SEA-3GS-M8-S	Screw terminal
5 Connecting cable		
Plug M8, 3-pin	KM8-M8-GSGD-...	Socket M8, 3-pin
Plug M8, 3-pin	NEBU-...-M8G3	Socket M5, 3-pin
		Socket M8, 3-pin
		Socket M8, 4-pin
		Socket M12, 5-pin
		Open cable end

CPI installation system

Selection aid

FESTO

Accessory selection aid

Connection for inputs M12, 4-pin

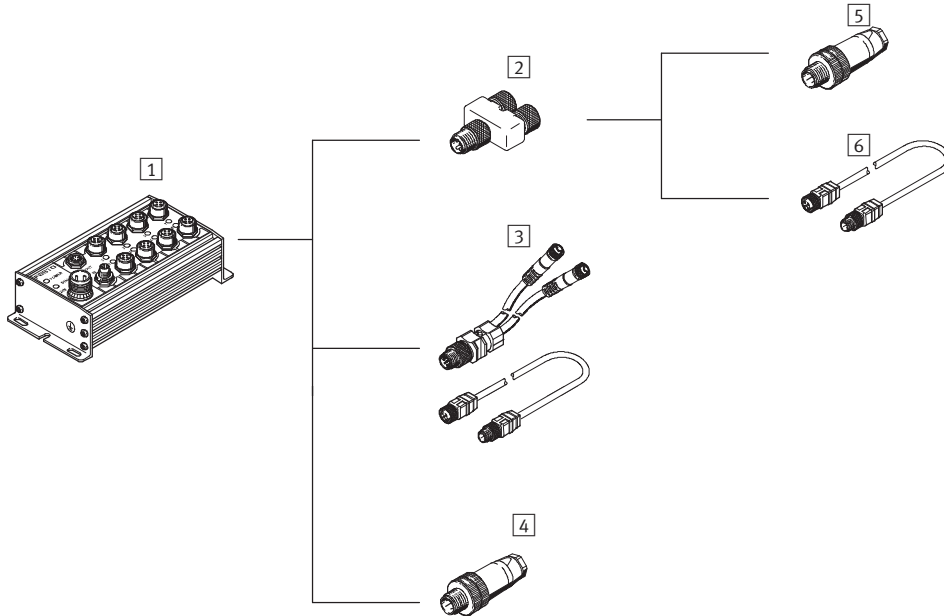

Note
Festo delivers pre-assembled M8/M12 connecting cables (NEBU modular system) on customer request:

- application tailored
- perfectly fitting
- installation saving

1	Input modules
Type	
CP-E16N-M12x2	

2		Plug connector/connecting cable
Type	Connection technology	
2 T-adaptor		
NEDU-M12D5-M12T4M	2x socket M12, 4-pin	
3 Connecting cable		
KM12-DUO-M8-...	2x socket M8, 3-pin	
KM12-M12-...	Socket M12, 4-pin	
4 Plug connector		
SEA-GS-7	Screw terminal	
SEA-4GS-7-2,5	Screw terminal	
SEA-GS-11-DUO	Screw terminal	

5			Plug connector/connecting cable
Connection technology	Type	Connection technology	
5 Plug connector			
Plug M12, 4-pin	SEA-GS-7	Screw terminal	
Plug M12, 4-pin	SEA-4GS-7-2,5	Screw terminal	
6 Connecting cable			
Plug M12, 4-pin	KM12-M12-...	Socket M12, 4-pin	

CPI installation system

Selection aid

FESTO

Accessory selection aid

Connection for inputs M12, 5-pin

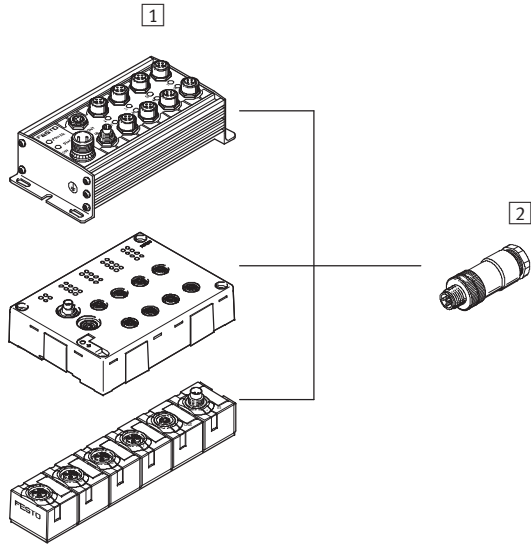

1	Input modules
Type	
	CP-E16-M12x2-5POL
	CP-E16N-M12-EL
	CP-E08-M12-CL

2	Plug connector	Connection technology
Type	SEA-M12-5GS-PG7	Screw terminal
	SEA-5GS-11-DUO	Screw terminal

Connection for inputs, tension-spring socket

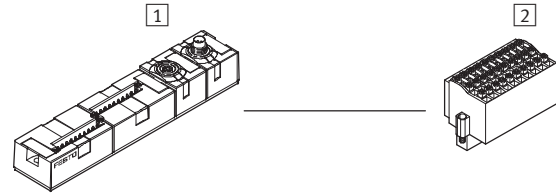

1	Input modules
Type	
	CP-E16-KL-CL

2	Plug connector	Connection technology
Type	PS1-SAC31-30POL+L	Screw-in tension-spring socket
	ED	

CPI installation system

Selection aid

FESTO

Accessory selection aid

Connection for outputs M12, 4-pin

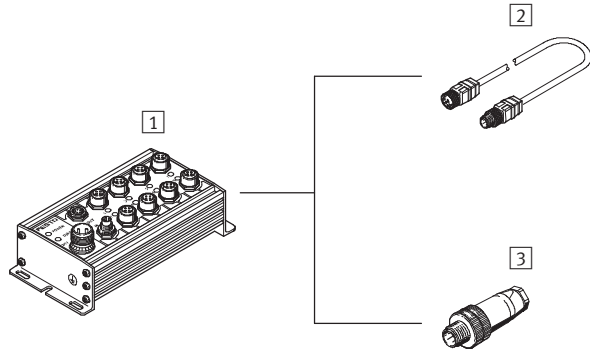

Connection for outputs M12, 5-pin

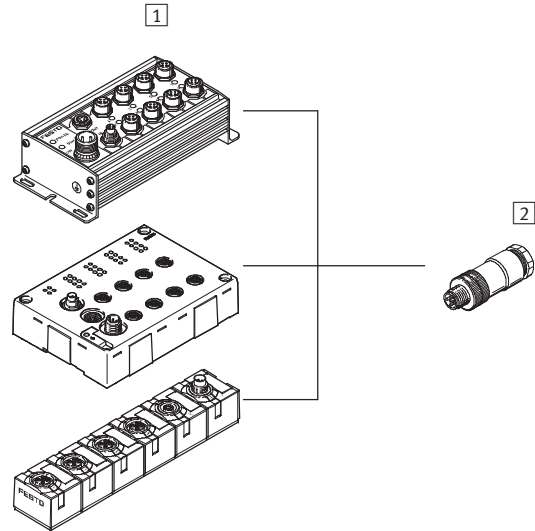

1 Output modules
Type
CP-A08N-M12

Plug connector/connecting cable	
Type	Connection technology
2 Connecting cable	
KM12-M12-...	Socket M12, 4-pin
3 Plug connector	
SEA-GS-7	Screw terminal
SEA-4GS-7-2,5	Screw terminal

1 Output modules
Type
CP-A08-M12-5POL
CP-A08-M12-EL-Z
CP-A04-M12-CL

2 Plug connector	
Type	Connection technology
SEA-M12-5GS-PG7	Screw terminal
SEA-5GS-11-DUO	Screw terminal

CPI installation system

Technical data – Fieldbus node CP-FB05-E

FESTO

FESTO

MOELLER 

ABB

This fieldbus node handles communication between the decentralised CP system and a higher-order master. The fieldbus node is a slave station on the fieldbus and represents the I/O data and diagnostic information of the connected CP modules on the network.

For the electrical peripherals, this module provides the separate electrical system supply for

- the electronics modules and sensor supply, and
- the load current of the valves.

The FB5 fieldbus node supports three different company-specific fieldbus protocols, based on a floating RS485 connection. The required protocol is selected by means of switch settings.

- Festo fieldbus
- ABB CS31
- Moeller SUCONET K



Application

Bus connection

The bus connection on the FB5 is established by means of a 9-pin Sub-D plug. In the case of operation on the fieldbus, the incoming control signals from the node via the fieldbus are permanently forwarded to the connected

CP modules. The CP modules ensure that the programmed output signals are present or switch the relevant valves.

 Note

Alternatively the bus connection can be established via a 2x M12 adapter plug (B-coded).

Implementation

The FB5 supports the digital input and output modules and the solenoid coils. It can service a total of 64 digital

outputs, of which max. 4x 16 can include solenoid coils, and 64 digital inputs.

 Note

Please observe the general guidelines on I/O addressing when assigning the outputs.

CPI installation system

Technical data – Fieldbus node CP-FB05-E

FESTO

General technical data		
Type	CP-FB05-E	
Baud rates	Festo fieldbus	Set using HW switch
	[kbps]	<ul style="list-style-type: none"> • 31.25 • 62.50 • 187.50 • 375
	ABB CS31	187.50
Addressing range	Moeller SUCONET K	Baud rate set automatically
	[kbps]	<ul style="list-style-type: none"> • 187.50 • 375
Type of communication	Festo fieldbus	Cyclic polling
	ABB CS31	I16, O16 or I/O16
	Moeller SUCONET K	Up to 32 I/O: SIS-K-06/07 Up to 64 I/O: SIS-K-10/10
Max. no. of solenoid coils		64
Max. no. of outputs incl. solenoid coils		64
Max. no. of inputs		64
LED diagnostic indicators	Power	Power supply indicator for internal electronics
	Power V	Power supply indicator for valves
	0...3	CP string LED
	Bus	Bus error status
Device-specific diagnostics transmitted to the controller		<ul style="list-style-type: none"> • Short circuit/overload of outputs • Undervoltage of valves • Undervoltage of outputs • Undervoltage of sensor supply
Operating voltage	Nominal value	[V DC] 24 polarity-safe
	Permissible range	[V DC] 20.4 ... 26.4
	Power failure buffering	[ms] 20
Current consumption pin 1	Fieldbus node	[mA] 250
	CP modules	[mA] 560 (internal electronics) + total current consumption of inputs
Current limiting	Electronics of fieldbus node and CP connection	[A] Max. 1.25, short circuit proof
Load voltage pin 2	Solenoid valves	Total of all valves switched simultaneously, see technical data on CP valves ➔ Internet: type 10 and Internet: type 12 Compact Performance valve terminals CPV and CPA
Current limiting	Supply for solenoid valves	[A] Max. 2.5, fused
Approval		CE
Protection class to EN 60529		IP65
Temperature range	Operation	[°C] -5 ... +50
	Storage	[°C] -20 ... +70
Materials	Housing	Die-cast aluminium
Dimensions (LxWxD)		[mm] 196.4 x 88 x 61.5
Weight		[g] 925

CPI installation system

Technical data – Fieldbus node CP-FB05-E

Certifications	
This product is certified for operation in the EX range as per EU-ATEX guideline	
ATEX category gas	II 3G
Ex-ignition protection type gas	Ex na II T5 X
ATEX category dust	II 3D
EX-ignition protection type dust	Ex tD A22 IP65 T80° C X
ATEX ambient temperature	[°C] $-5 \leq T_a \leq +50$
Certification	c UL us recognized (OL)
CE mark (see declaration of conformity)	In accordance with EU explosion protection directive (ATEX)

Connection and display components

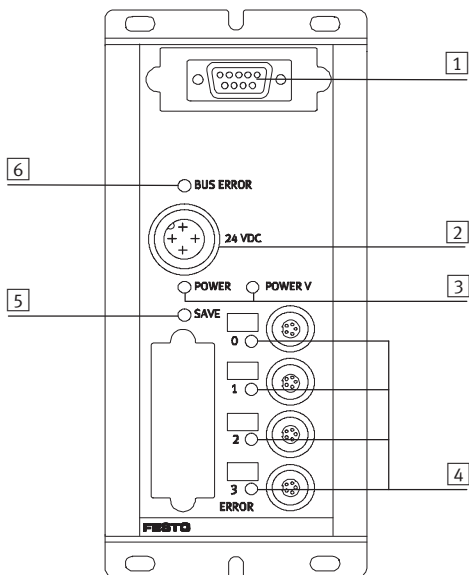







- 1 Plug for fieldbus cable
- 2 Operating voltage connection for CP and valves
- 3 Operating voltage LEDs
- 4 String LEDs
- 5 Save key
- 6 Bus-specific LED

Pin allocation for fieldbus interface (plug view)								
Plug view	Pin	Signal	Festo Sub-D plug (IP65)	Manufacturer-specific signal designation			Designation	
				Festo fieldbus interface	ABB CS31	Moeller SUCONET K		
						Sub-D, 9-pin	DIN (round), 5-pin	
	1	n.c.						Not connected
	2	n.c.						Not connected
	3	RxD/TxD-P	B	S+	Bus1	3 (T _A /R _A)	4 (T _A /R _A)	Received/transmitted data P
	4	CNTR-P						Repeater control signal
	5	DGND						Data reference potential
	6	VP						Supply voltage
	7	n.c.						Not connected
	8	RxD/TxD-N	A	S-	Bus2	7 (T _B /R _B)	1 (T _B /R _B)	Received/transmitted data N
	9	n.c.						Not connected
Housing			Cable clip	Screen	Screen	4 (screen)	Housing	

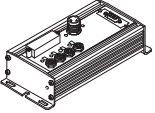
CPI installation system

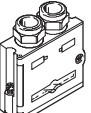
Accessories – Fieldbus node CP-FB05-E

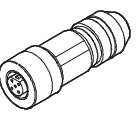
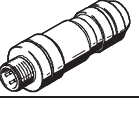
FESTO

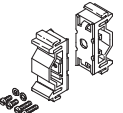
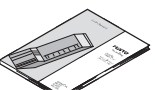
Ordering data			
Designation		Part No.	Type
Fieldbus node			
	Fieldbus node for Festo fieldbus, ABB CS31, Moeller SUCONET K	18238	CP-FB05-E
Power supply			
	Power supply socket, straight M18x1, 4-pin	for 1.5 mm ²	18493 NTSD-GD-9
		for 2.5 mm ²	18526 NTSD-GD-13,5
	Power supply socket, angled M18x1, 4-pin	for 1.5 mm ²	18527 NTSD-WD-9
		for 2.5 mm ²	533119 NTSD-WD-11
Fieldbus connection			
	Fieldbus socket, Sub-D connection	532216	FBS-Sub-9-GS-DP-B
	M12 adapter	533118	FBA-2-M12-5POL-RK
	Socket M12x1, 5-pin, straight, for self-assembly of a connecting cable for FBA-2-M12-5POL-RK	1067905	NECU-M-B12G5-C2-PB
	Plug M12x1, 5-pin, straight, for self-assembly of a connecting cable for FBA-2-M12-5POL-RK	1066354	NECU-M-S-B12G5-C2-PB
Valve terminal connection			
	Connecting cable WS-WD	0,25 m	540327 KVI-CP-3-WS-WD-0,25
		0,5 m	540328 KVI-CP-3-WS-WD-0,5
		2 m	540329 KVI-CP-3-WS-WD-2
		5 m	540330 KVI-CP-3-WS-WD-5
		8 m	540331 KVI-CP-3-WS-WD-8
	Connecting cable GS-GD	2 m	540332 KVI-CP-3-GS-GD-2
		5 m	540333 KVI-CP-3-GS-GD-5
		8 m	540334 KVI-CP-3-GS-GD-8
Mounting			
	Mounting for H-rail	170169	CP-TS-HS35
User documentation			
	User documentation – Bus node CP-FB5-E	German	165105 P.BE-CP-FB5-E-DE
		English	165205 P.BE-CP-FB5-E-EN
		French	165135 P.BE-CP-FB5-E-FR
		Italian	165165 P.BE-CP-FB5-E-IT

CPI installation system

Technical data – Fieldbus node CP-FB06-E

FESTO



This fieldbus node handles communication between the decentralised CP system and a higher-order master. The fieldbus node is a slave station on the fieldbus and represents the I/O data and diagnostic information of the connected CP modules on the network.

For the electrical peripherals, this module provides the separate electrical system supply for

- the electronics modules and sensor supply, and
- the load current of the valves.

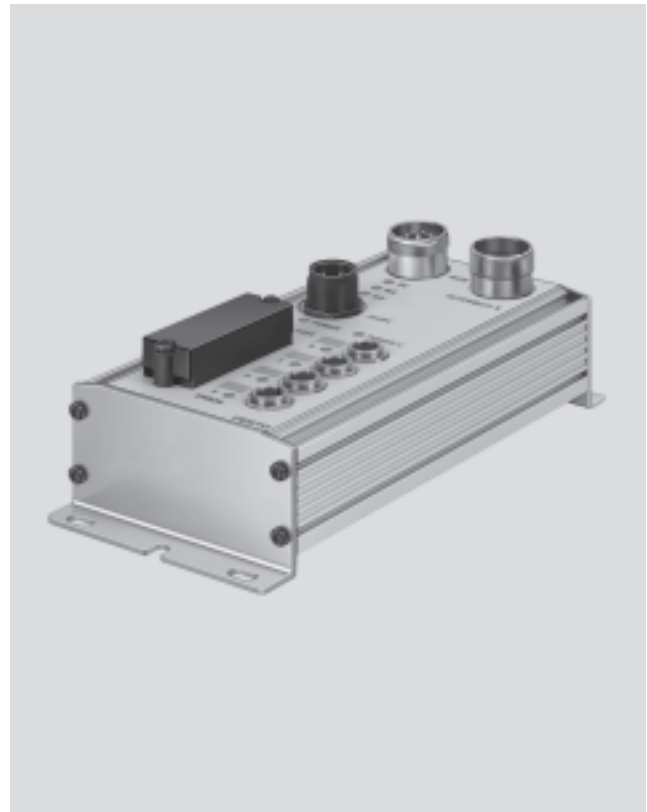

Application

Bus connection

The bus connection is established via two 9-pin M23 connections with a typical Interbus pin allocation. The plug and socket are labelled with Remote IN and Remote OUT in

accordance with the definition for the Interbus remote bus. Both bus cables are always routed to the fieldbus node and looped through in accordance with the ring structure of the Interbus.

The CP fieldbus node receives the data from the higher-order controller and forwards it to the connected CP valve terminals or electrical output modules. The signal status of the

inputs is requested from the input modules and forwarded to the CP fieldbus nodes.

Implementation

The FB6 supports the digital input and output modules and the solenoid coils. It can service a total of 64 digital

outputs, of which max. 64 can include solenoid coils, and 64 digital inputs.



Note

Please observe the general guidelines regarding addressing when assigning outputs.

CPI installation system

Technical data – Fieldbus node CP-FB06-E

FESTO

General technical data			
Type		CP-FB06-E	
Baud rates	[kbps]	500	
ID code		3	
No. of process data bits		16, 32, 48 or 64 depending on expansion	
PCP channel		No	
Configuration support		Icon file for CMD software Station description file with CMD software	
Max. no. of solenoid coils		64	
Max. no. of outputs incl. solenoid coils		64	
Max. no. of inputs		64	
LED diagnostic indicators	Power	Power supply indicator for internal electronics	
	Power V	Power supply indicator for valves	
	0...3	CP string LED	
	RC	Remotebus check	
	BA	Bus active	
	RD	Remotebus disable	
Device-specific diagnostics transmitted to the controller as common message (peripherals errors)		<ul style="list-style-type: none"> • Short circuit/overload of outputs • Undervoltage of valves • Undervoltage of outputs • Undervoltage of sensor supply 	
Additional functions		Test routine for checking the valves and outputs without bus communication	
Operating voltage	Nominal value	[V DC]	24 polarity-safe
	Permissible range	[V DC]	20.4 ... 26.4
	Power failure buffering	[ms]	20
Current consumption pin 1	Fieldbus node	[mA]	250
	CP modules	[mA]	560 (internal electronics) + total current consumption of inputs
Current limiting	Electronics of fieldbus node and CP connection	[A]	Max. 1.25, short circuit proof
Load voltage pin 2	Solenoid valves		Total of all valves switched simultaneously, see technical data on CP valves → Internet: type 10 and Internet: type 12 (Compact Performance valve terminals CPV and CPA)
Current limiting	Supply for solenoid valves	[A]	Max. 2.5, fused
Protection class to EN 60529			IP65
Temperature range	Operation	[°C]	-5 ... +50
	Storage	[°C]	-20 ... +70
Materials	Housing		Die-cast aluminium
Dimensions (LxWxD)		[mm]	196.4 x 88 x 61.5
Weight		[g]	915

Certifications			
This product is certified for operation in the EX range as per EU-ATEX guideline			
ATEX category gas			II 3G
Ex-ignition protection type gas			Ex na II T5 X
ATEX category dust			II 3D
EX-ignition protection type dust			Ex tD A22 IP65 T80° C X
ATEX ambient temperature		[°C]	-5 ≤ Ta ≤ +50
Certification			c UL us recognized (OL)
CE mark (see declaration of conformity)			In accordance with EU explosion protection directive (ATEX)

CPI installation system

Technical data – Fieldbus node CP-FB06-E

Connection and display components

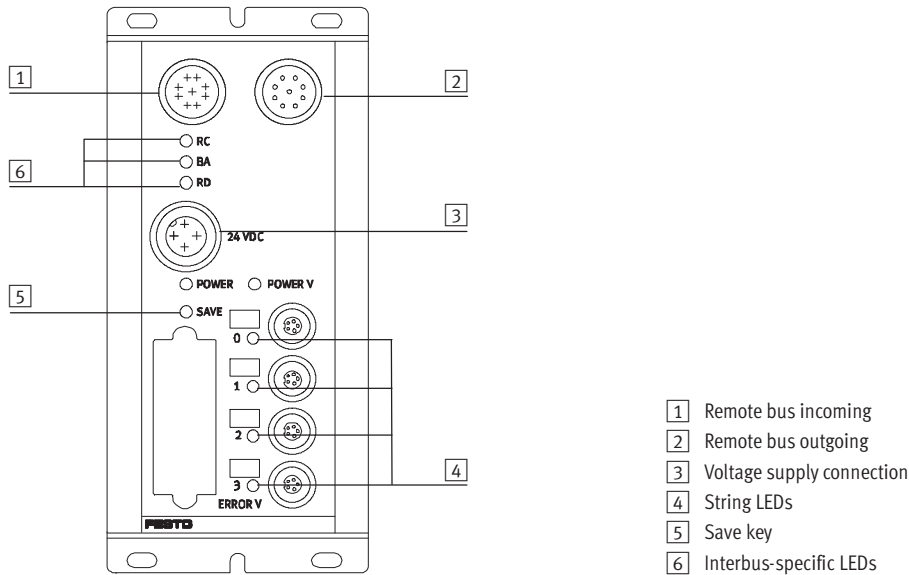

Pin allocation for the INTERBUS interface, non-floating installation remote bus







Pin allocation	Pin No. ¹⁾	Signal	Designation
Incoming			
Plug view 	1	DO	Data out
	2	/DO	Data out inverse
	3	DI	Data in
	4	/DI	Data in inverse
	5	Load	Reference conductor
	6	FE	Functional earthing for installation remote bus
	7	+24 V	Installation remote bus supply
	8	+0 V	Installation remote bus supply
	Sleeve	Screen	Screening
Outgoing			
Socket view 	1	DO	Data out
	2	/DO	Data out inverse
	3	DI	Data in
	4	/DI	Data in inverse
	5	Load	Reference conductor
	6	FE	Functional earthing for installation remote bus
	7	+24 V	Installation remote bus supply
	8	+0 V	Installation remote bus supply
	9	RBST	Establish bridge to pin 5
Sleeve	Screen	Screening	

1) Pins not listed here must not be connected.

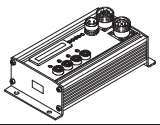
CPI installation system

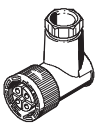
Accessories – Fieldbus node CP-FB06-E

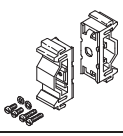
FESTO

Ordering data			
Designation		Part No.	Type
Fieldbus node			
	Fieldbus node INTERBUS	18225	CP-FB06-E
Power supply			
	Power supply socket, straight M18x1, 4-pin	for 1.5 mm ²	18493 NTSD-GD-9
		for 2.5 mm ²	18526 NTSD-GD-13,5
	Power supply socket, angled M18x1, 4-pin	for 1.5 mm ²	18527 NTSD-WD-9
		for 2.5 mm ²	533119 NTSD-WD-11
Valve terminal connection			
	Connecting cable WS-WD	0,25 m	540327 KVI-CP-3-WS-WD-0,25
		0,5 m	540328 KVI-CP-3-WS-WD-0,5
		2 m	540329 KVI-CP-3-WS-WD-2
		5 m	540330 KVI-CP-3-WS-WD-5
		8 m	540331 KVI-CP-3-WS-WD-8
	Connecting cable GS-GD	2 m	540332 KVI-CP-3-GS-GD-2
		5 m	540333 KVI-CP-3-GS-GD-5
		8 m	540334 KVI-CP-3-GS-GD-8
Mounting			
	Mounting for H-rail	170169	CP-TS-HS35
User documentation			
	User documentation – Bus node CP-FB06-E	German	165106 P.BE-CP-FB6-E-DE
		English	165206 P.BE-CP-FB6-E-EN
		French	165136 P.BE-CP-FB6-E-FR
		Italian	165166 P.BE-CP-FB6-E-IT
		Spanish	165236 P.BE-CP-FB6-E-ES
		Swedish	165266 P.BE-CP-FB6-E-SV

CPI installation system

Technical data – Fieldbus node CP-FB11-E

FESTO



This fieldbus node handles communication between the decentralised CP system and a higher-order master. The fieldbus node is a slave station on the fieldbus and represents the I/O data and diagnostic information of the connected CP modules on the network.

For the electrical peripherals, this module provides the separate electrical system supply for

- the electronics modules and sensor supply, and
- the load current of the valves.

The FB11 fieldbus node supports the CAN-based fieldbus protocol DeviceNet.

- DeviceNet



Application

Bus connection

The DeviceNet connection is established via a 5-pin M12 plug with pins that corresponds to the specific mini connector. A DeviceNet installation with a higher degree of protection is

typically installed using main and branch lines that are connected via T-pieces. Various manufacturers such as Turck, Lumberg and Rockwell offer finished

cables and terminating resistors. The terminating resistors are attached to the two outermost T-pieces. This installation technique keeps the

bus closed while a bus station is being removed. Provides detailed diagnostic information about status bits for the master controller.

Implementation

The FB11 supports the digital input and output modules. It can service a total of 64 digital

inputs and 64 digital outputs, of which max. 64 can include solenoid coils.

 Note

Please observe the general guidelines on I/O addressing when assigning the outputs.

CPI installation system

Technical data – Fieldbus node CP-FB11-E

FESTO

General technical data			
Type	CP-FB11-E		
Baud rates	[kbps]	Set using HW switch	
		<ul style="list-style-type: none"> • 125 • 250 • 500 	
Addressing range		Set using 2 rotary switches 0 ... 63	
Product type		Communication converter (12 dec.)	
Product code		2282 hex./35050 dec.	
Type of communication		Polling/Cos/Bit Strobe	
Configuration support		EDS file and graphics symbol	
Max. no. of solenoid coils		64	
Max. no. of outputs and solenoid coils		64	
Max. no. of inputs		64	
LED diagnostic indicators	Bus/Power	Operating voltage of bus	
	Module status	Operating status	
	I/O Error	Internal error	
Device-specific diagnosis via DeviceNet		<ul style="list-style-type: none"> • Short circuit/overload of outputs • Undervoltage of valves • Undervoltage of outputs • Undervoltage of sensor supply • Interrupt point on CP string 	
Operating voltage	Nominal value	[V DC]	24 polarity-safe
	Permissible range	[V DC]	20.4 ... 26.4
	Power failure buffering	[ms]	20
Current consumption pin 1	Fieldbus node	[mA]	250
	CP module	[mA]	560 (internal electronics) + total current consumption of inputs, internal
Current limiting	Electronics of fieldbus node and CP connection	[A]	Max. 1.25, short circuit proof
Current consumption pin 2	Solenoid valves		Total of all valves switched simultaneously, see technical data on CP valves → Internet: type 10 and Internet: type 12 (Compact Performance valve terminals CPV and CPA)
Protection class to EN 60529			IP65
Temperature range	Operation	[°C]	-5 ... +50
	Storage/transport	[°C]	-20 ... +70
Materials	Housing		Die-cast aluminium
Dimensions (HxWxD)		[mm]	196.4 x 88 x 61.5
Grid dimension		[mm]	72
Weight		[g]	950

CPI installation system

Technical data – Fieldbus node CP-FB11-E

Certifications	
This product is certified for operation in the EX range as per EU-ATEX guideline	
ATEX category gas	II 3G
Ex-ignition protection type gas	Ex na II T5 X
ATEX category dust	II 3D
EX-ignition protection type dust	Ex tD A22 IP65 T80° C X
ATEX ambient temperature	[°C] $-5 \leq T_a \leq +50$
Certification	c UL us recognized (OL)
CE mark (see declaration of conformity)	In accordance with EU explosion protection directive (ATEX)

Connection and display components

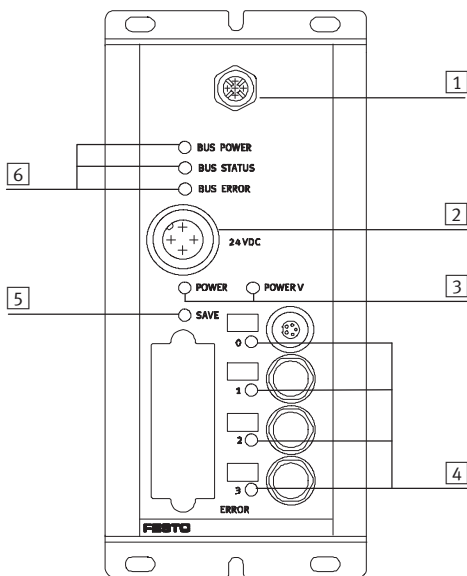







- 1 Plug for fieldbus cable
- 2 Operating voltage connection for CP and valves
- 3 Operating voltage LEDs
- 4 String LEDs
- 5 Save key
- 6 Bus status LEDs

Pin allocation for fieldbus interface			
Pin allocation	Pin No.	Signal	
	1	Screen	1 Plug
	2	+24 V bus	
	3	GND Bus	
	4	Data+	
	5	Data-	
	2		Housing of the fieldbus connection module PE
	3		Internal screening connection in the valve terminal

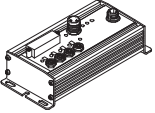
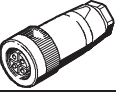
CPI installation system

Accessories – Fieldbus node CP-FB11-E

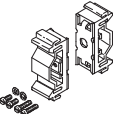
FESTO

Ordering data			
Designation		Part No.	Type
Fieldbus node			
	Fieldbus node DeviceNet	18227	CP-FB11-E
Power supply			
	Power supply socket, straight M18x1, 4-pin	for 1.5 mm ²	18493 NTSD-GD-9
		for 2.5 mm ²	18526 NTSD-GD-13,5
	Power supply socket, angled M18x1, 4-pin	for 1.5 mm ²	18527 NTSD-WD-9
		for 2.5 mm ²	533119 NTSD-WD-11
Fieldbus connection			
	Bus connection, straight, PG9, 5-pin	18324	FBSD-GD-9-5POL
Valve terminal connection			
	Connecting cable WS-WD	0,25 m	540327 KVI-CP-3-WS-WD-0,25
		0,5 m	540328 KVI-CP-3-WS-WD-0,5
		2 m	540329 KVI-CP-3-WS-WD-2
		5 m	540330 KVI-CP-3-WS-WD-5
		8 m	540331 KVI-CP-3-WS-WD-8
	Connecting cable GS-GD	2 m	540332 KVI-CP-3-GS-GD-2
		5 m	540333 KVI-CP-3-GS-GD-5
		8 m	540334 KVI-CP-3-GS-GD-8
Mounting			
	Mounting, for H-rail	170169	CP-TS-HS35
User documentation			
	User documentation – Bus node CP-FB11-E	German	165111 P.BE-CP-FB11-E-DE
		English	165211 P.BE-CP-FB11-E-EN
		French	165141 P.BE-CP-FB11-E-FR
		Italian	165171 P.BE-CP-FB11-E-IT
		Spanish	165241 P.BE-CP-FB11-E-ES
		Swedish	165271 P.BE-CP-FB11-E-SV

CPI installation system

Technical data – Fieldbus node CP-FB13-E

FESTO



This fieldbus node handles communication between the decentralised CP system and a higher-order master via Profibus DP. The fieldbus node is a slave station on the fieldbus and represents the I/O data and diagnostic information of the connected CP modules on the network.

For the electrical peripherals, this module provides the separate electrical system supply for

- the electronics modules and sensor supply, and
- the load current of the valves.

The status of the voltage supplies and the bus communication is indicated via the LEDs Power, Power Valves, String Error and Bus Error.

- Profibus-DP



Application

Bus connection

The bus connection is established via a 9-pin Sub-D socket with a typical Profibus allocation (to EN 50 170). The bus connector plug (with protection class IP65 from Festo or IP20

from other manufacturers) facilitates the connection of an incoming and an outgoing bus cable. An active bus terminal can be connected using the integrated DIL switch. The Sub-D

interface is designed for the control of network components via a fibre optic cable connection and provides detailed diagnostic information for master detection.



Note

Alternatively the bus connection can be established via a 2x M12 adapter plug (B-coded).

Implementation

The FB13 supports digital input and output modules and solenoid coils. 64 digital outputs in total, of which max. 64 solenoid coils. Max. 64 digital inputs for recording sensor signals.



Note

When assigning the electrical modules, please observe the configuration guidelines for valve terminals in relation to address allocation and the number of occupied module positions.

CPI installation system

Technical data – Fieldbus node CP-FB13-E

FESTO

General technical data			
Type		CP-FB13-E	
Baud rates			Automatic detection 0.0096 ... 12
		[MBaud]	
Addressing range			Set using 2 DIL switches 1 ... 125
Product family			4: Valves
Ident. number			0xFB13
Type of communication			Cyclic communication
Configuration support			GSD file and bitmaps
Max. no. of solenoid coils			64
Max. no. of outputs and solenoid coils			64
Max. no. of inputs			64
LED diagnostic indicators	Power		Operating voltage of electronics
	Power V		Operating voltage of valves and outputs
	Bus Error		Communication error
	0...3		CP string
Device-specific diagnostics via Profibus-DP			<ul style="list-style-type: none"> • Short circuit/overload of outputs • Undervoltage of valves • Undervoltage of outputs • Undervoltage of sensor supply • Interrupt points on CP string
Additional functions			<ul style="list-style-type: none"> • Test routine for checking the valves and outputs without bus communication
Operating voltage	Nominal value	[V DC]	24 polarity-safe
	Permissible range	[V DC]	20.4 ... 26.4
	Power failure buffering	[ms]	20
Current consumption pin 1	Fieldbus node	[mA]	250
	CP module	[mA]	560 (internal electronics) + total current consumption of inputs, internal
Current limiting	Electronics of fieldbus node and CP connection	[A]	Max. 1.25, short circuit proof
Current consumption pin 2	Solenoid valves		Total of all valves switched simultaneously, see technical data on CP valves → Internet: type 10 and Internet: type 12 (Compact Performance valve terminals CPV and CPA)
Current limiting	Supply for solenoid valves	[A]	Max. 2.5, fused
Protection class to EN 60529			IP65
Temperature range	Operation	[°C]	-5 ... +50
	Storage/transport	[°C]	-20 ... +70
Materials	Housing		Die-cast aluminium
Dimensions (LxWxD)		[mm]	196.4 x 88 x 61.5
Grid dimension		[mm]	72
Weight		[g]	925

Certifications	
This product is certified for operation in the EX range as per EU-ATEX guideline	
ATEX category gas	II 3G
Ex-ignition protection type gas	Ex na II T5 X
ATEX category dust	II 3D
EX-ignition protection type dust	Ex tD A22 IP65 T80° C X
ATEX ambient temperature	[°C] -5 ≤ Ta ≤ +50
Certification	c UL us recognized (OL)
CE mark (see declaration of conformity)	In accordance with EU explosion protection directive (ATEX)

CPI installation system

Technical data – Fieldbus node CP-FB13-E

Connection and display components

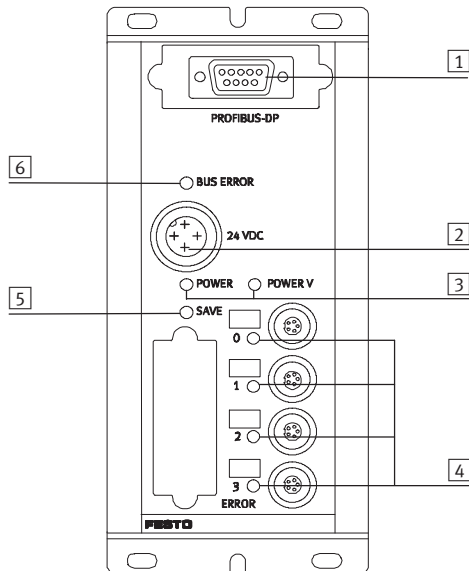

- 1 Plug for fieldbus cable
- 2 Operating voltage connection for CP and valves
- 3 Operating voltage LEDs
- 4 String LEDs
- 5 Save key
- 6 Bus-specific LED

Pin allocation for Profibus DP interface







Pin allocation	Pin	Signal	Designation
Plug, Sub-D			
	1	n.c.	Not connected
	2	n.c.	Not connected
	3	RxD/TxD-P	Received/transmitted data P
	4	CNTR-P ¹⁾	Repeater control signal
	5	DGND	Data reference potential (M5V)
	6	VP	Supply voltage (P5V)
	7	n.c.	Not connected
	8	RxD/TxD-N	Received/transmitted data N
	9	n.c.	Not connected
	Housing	Screen	Connection to housing
Bus connection M12 adapter plug (B-coded)			
Incoming			
	1	n.c.	Not connected
	2	RxD/TxD-N	Received/transmitted data N
	3	n.c.	Not connected
	4	RxD/TxD-P	Received/transmitted data P
	5 and M12	Screen	Connection to functional earth
Outgoing			
	1	VP	Supply voltage (P5V)
	2	RxD/TxD-N	Received/transmitted data N
	3	DGND	Data reference potential (M5V)
	4	RxD/TxD-P	Received/transmitted data P
	5 and M12	Screen	Connection to functional earth

1) The repeater control signal CNTR-P is realised as a TTL signal.

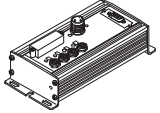
CPI installation system

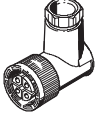
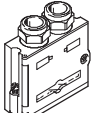
Accessories – Fieldbus node CP-FB13-E

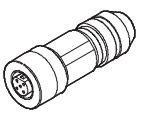
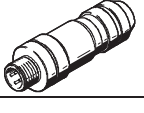
FESTO

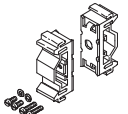
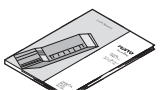
Ordering data			
Designation		Part No.	Type
Fieldbus node			
	Fieldbus node for PROFIBUS-DP	174337	CP-FB13-E
Power supply			
	Power supply socket, straight M18x1, 4-pin	for 1.5 mm ²	18493 NTSD-GD-9
		for 2.5 mm ²	18526 NTSD-GD-13,5
	Power supply socket, angled M18x1, 4-pin	for 1.5 mm ²	18527 NTSD-WD-9
		for 2.5 mm ²	533119 NTSD-WD-11
Fieldbus connection			
	Plug Sub-D, for Profibus DP	532216	FBS-SUB-9-GS-DP-B
	Bus connection 2x M12 adapter plug (B-coded) for Profibus DP	533118	FBA-2-M12-5POL-RK
	Socket M12x1, 5-pin, straight, for self-assembly of a connecting cable for FBA-2-M12-5POL-RK	1067905	NECU-M-B12G5-C2-PB
	Plug M12x1, 5-pin, straight, for self-assembly of a connecting cable for FBA-2-M12-5POL-RK	1066354	NECU-M-S-B12G5-C2-PB
Valve terminal connection			
	Connecting cable WS-WD	0,25 m	540327 KVI-CP-3-WS-WD-0,25
		0,5 m	540328 KVI-CP-3-WS-WD-0,5
		2 m	540329 KVI-CP-3-WS-WD-2
		5 m	540330 KVI-CP-3-WS-WD-5
		8 m	540331 KVI-CP-3-WS-WD-8
	Connecting cable GS-GD	2 m	540332 KVI-CP-3-GS-GD-2
		5 m	540333 KVI-CP-3-GS-GD-5
		8 m	540334 KVI-CP-3-GS-GD-8
Mounting			
	Mounting for H-rail	170169	CP-TS-HS35
User documentation			
	User documentation – Bus node CP-FB13-E	German	165113 P.BE-CP-FB13-E-DE
		English	165213 P.BE-CP-FB13-E-EN
		French	165143 P.BE-CP-FB13-E-FR
		Italian	165173 P.BE-CP-FB13-E-IT
		Swedish	165273 P.BE-CP-FB13-E-SV
		Spanish	165243 P.BE-CP-FB13-E-ES

CPI installation system

Technical data – Input modules CP-E16

Function

Digital input modules facilitate the connection of proximity sensors or other 24 V DC sensors (inductive, capacitive, etc.).

M12 plugs with double allocation are separated using a DUO plug or DUO cable.

Application

- Input modules for 24 V DC sensor signals
- M8 and M12 plugs, single allocation connection technology with 16 connections, double allocation connection technology with 8 connections
- M12 plug, 5-pin
- The input statuses are indicated for each input signal on an assigned LED
- 24 V DC supply provided for all connected sensors
- Diagnostic LED for short circuit/undervoltage of sensor supply
- Diagnostic LED for short circuit/interruption of external sensor supply with CP-E-16-M8-Z

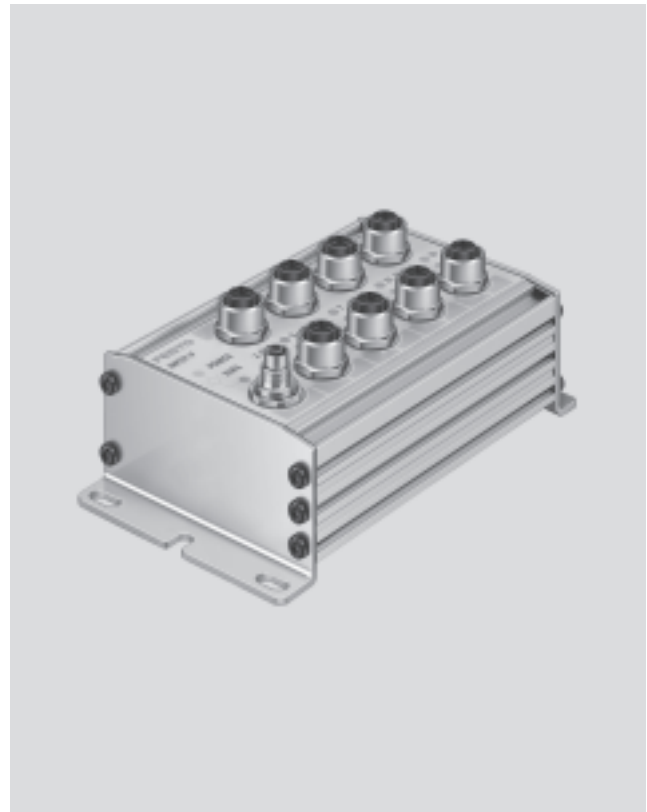

General technical data					
Type		CP-E16-M8 positive switching	CP-E16N-M8 negative switching	CP-E16-M12x2-5POL positive switching	
No. of inputs		16			
Allocation of inputs		Single allocation		Double allocation	
Sensor connection type		16x M8, 3-pin		8x M12, 5-pin	
Power supply 24 V DC		Coming from bus node			
Intrinsic current consumption of electronics	[mA]	40	90		
Input current at 24 V DC (from sensor)	[mA]	Typically 8		Typically 6	
Fuse protection for sensors and electronic module		Internal electronic short circuit protection			
Max. current consumption of sensor supply, residual current	[A]	Max. 0.5			
Supply voltage of sensors	[V]	24 DC ±25%			
Protection against polarity reversal		For logic and sensor voltage			
Galvanic isolation		None			
Switching level	Signal 0	[V]	≤5	≥-11	≤6
	Signal 1	[V]	≥11	≤-5	≥8.6
Input delay		[ms]	Typically 5		Typically 3
Switching logic			PNP	NPN	PNP
Input characteristic curve		To IEC 11 31-2			
Connection to bus node		Via pre-assembled cables			
Protection class to EN 60529		IP65 (when fully plugged in or fitted with protective cover)			
Temperature range	Operation	[°C]	-5 ... +50		
	Storage	[°C]	-20 ... +70		
Material		Die-cast aluminium			
Dimensions		[mm]	148.9 x 66 x 47.9		140.9 x 78 x 55.2
Weight		[g]	400		500

CPI installation system

Technical data – Input modules CP-E16

FESTO

General technical data				
Type	CP-E16N-M12x2 negative switching		CP-E16-M8-Z positive and negative switching	
No. of inputs	16			
Allocation of inputs	Double allocation		Single allocation	
Sensor connection type	8x M12, 4-pin		16x M8, 3-pin	
Power supply 24 V DC	Coming from bus node		Coming from bus node, connection for additional sensor supply	
Intrinsic current consumption of electronics	[mA]	90	40	
Input current at 24 V DC (from sensor)	[mA]	Typically 8		
Fuse protection for sensors and electronic module	Internal electronic short circuit protection		Electronic short circuit protection per group	
Max. current consumption of sensor supply, residual current	[A]	Max. 0.5	Max. 1 per 8-fold input group	
Supply voltage of sensors	[V]	24 DC \pm 25%		
Protection against polarity reversal	For logic and sensor voltage			
Galvanic isolation	None			
Switching level			PNP	NPN
	Signal 0	[V]	\geq 11	\leq 6
	Signal 1	[V]	\leq 5	\geq 8.6
Input delay	[ms]	Typically 5	Typically 3	
Switching logic	NPN		PNP/NPN	
Input characteristic curve	To IEC 1131-2			
Connection to bus node	Via pre-assembled cables			
Protection class to EN 60529	IP65 (when fully plugged in or fitted with protective cover)			
Temperature range	Operation	[°C]	-5 ... +50	
	Storage	[°C]	-20 ... +70	
Material	Die-cast aluminium			
Material note	Conforms to RoHS			
Dimensions	[mm]	140.9 x 78 x 55.2	216.9 x 66 x 50.6	
Weight	[g]	500	420	

Certifications	
This product is certified for operation in the EX range as per EU-ATEX guideline	
ATEX category gas	II 3G
Ex-ignition protection type gas	Ex na II T5 X
ATEX category dust	II 3D
EX-ignition protection type dust	Ex tD A22 IP65 T80° C X
ATEX ambient temperature	[°C] -5 \leq Ta \leq +50
Certification	c UL us recognized (OL)
CE mark ¹⁾ (see declaration of conformity)	To EU-Ex-RL (ATEX)
	To EU-EMV-RL

1) Certification not valid for: CP-E16N-M8 and CP-E16N-M12

CPI installation system

Technical data – Input modules CP-E16

Connection and display components

CP-E16-M12x2-5POL and CP-E16N-M12x2

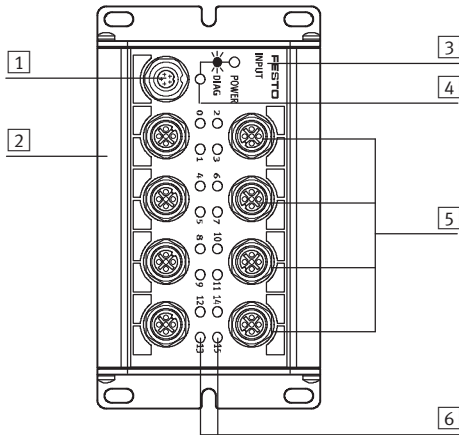

- 1 CP connection
- 2 Slot for inscription labels (ISB 6x10)
- 3 Identification of input type:
-INPUT-P for PNP inputs
-INPUT-N for NPN inputs
- 4 Status LED (green)
- 5 Sensor connections
- 6 Green LED for status display (one LED per input)

Pin allocation for sensor connections CP-E16-M12x2-5Pol

Pin allocation	Pin	Signal	Description	Pin	Signal
	1	24 V	Operating voltage 24 V	1	24 V
	2	Ix+1*	Sensor signal	2	Ix+3*
	3	0 V	Operating voltage 0 V	3	0 V
	4	Ix*	Sensor signal	4	Ix+2*
	5	Ground	Earth terminal	5	Ground

Pin allocation for sensor connections CP-E16...-M12x2

Pin allocation	Pin	Signal	Description	Pin	Signal
	1	24 V	Operating voltage 24 V	1	24 V
	2	Ix+1*	Sensor signal	2	Ix+3*
	3	0 V	Operating voltage 0 V	3	0 V
	4	Ix*	Sensor signal	4	Ix+2*

* Ix = Input x

CPI installation system

Technical data – Input modules CP-E16

Connection and display components

CP-E16-M8-Z

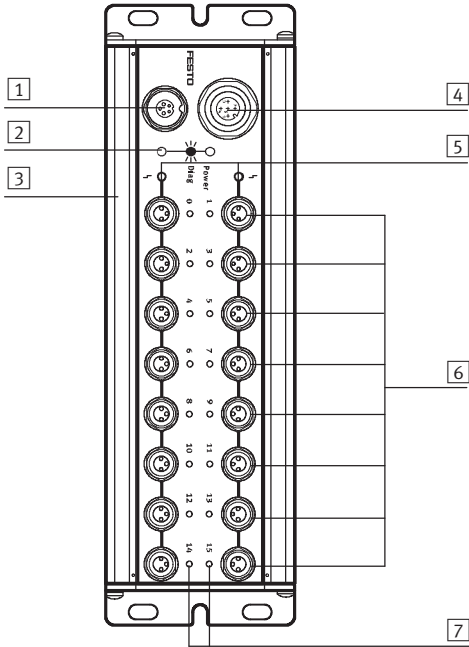

- 1 CP connection
- 2 Status LED (green)
- 3 Slot for inscription labels (ISB 6x10)
- 4 Connection for sensor supply
- 5 Red LED for short circuit display or sensor voltage failure (one LED per input group)
- 6 Sensor connections
- 7 Green LED for status display (one LED per input)

Pin allocation for external sensor supply CP-E16-M8-Z

Pin allocation	Pin	Signal	Description
	1	24 V DC ±25%	Operating voltage
	2	PNP/NPN	Coding with negative/positive switching: – PNP operation (pin 2 and 3 bridged) – NPN operation (pin 2 and 1 bridged)
	3	0 V	Operating voltage 0 V
	4	n.c.	Not connected
	5	Ground	Earth terminal

Note

External sensor supply for CP-E16-M8-Z:
Specified for PNP or NPN operation (type CP-E16-M8-Z).
The input module provides PNP or NPN inputs. The setting for PNP or NPN operation is made by installing a bridge in the socket of the sensor supply connection.

Pin allocation for sensor connections CP-E16...-M8 and CP-E16-M8-Z

Pin allocation	Pin	Signal	Description	Pin	Signal
	1	24 V	Operating voltage 24 V	1	24 V
	3	0 V	Operating voltage 0 V	3	0 V
	4	Ix*	Sensor signal	4	Ix+1*

* Ix = Input x

CPI installation system

Technical data – Input modules CP-E16

Connection and display components

CP-E16-M8 and CP-E16N-M8

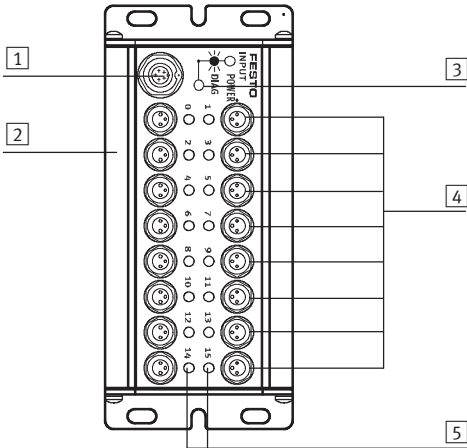

- 1 CP connection
- 2 Slot for inscription labels (ISB 6x10)
- 3 Status LED (green)
- 4 Sensor connections
- 5 Green LED for status display (one LED per input)

Pin allocation for sensor connections CP-E16...-M8 and CP-E16-M8-Z







Pin allocation	Pin	Signal	Description	Pin	Signal
	1	24 V	Operating voltage 24 V	1	24 V
	3	0 V	Operating voltage 0 V	3	0 V
	4	Ix*	Sensor signal	4	Ix+1*

* Ix = Input x

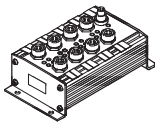
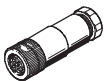
CPI installation system

Accessories – Input modules CP-E16

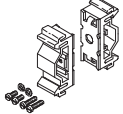
FESTO

Ordering data					
Designation			Part No.	Type	
Input modules					
	positive switching		18205	CP-E16-M8	
	negative switching		18243	CP-E16N-M8	
	positive switching		175561	CP-E16-M12x2-5POL	
	negative switching		18244	CP-E16N-M12x2	
	positive and negative switching		189670	CP-E16-M8-Z	
Power supply					
	Power supply socket, straight, M12x1, 5-pin		18324	FBSD-GD-9-5POL	
Sensor plugs					
	Plug, straight socket, M12	5-pin, PG7	175487	SEA-M12-5GS-PG7	
		4-pin, PG7	18666	SEA-GS-7	
		4-pin, 2.5 mm ² O.D.	192008	SEA-4GS-7-2,5	
	Plug, straight, M8	3-pin, solderable	18696	SEA-GS-M8	
3-pin, screw-in		192009	SEA-3GS-M8-S		
	Plug for 2 sensor cables, M12, PG11	4-pin	18779	SEA-GS-11-DUO	
		5-pin	192010	SEA-5GS-11-DUO	
Sensor cables					
	Connecting cable, M12, 4-pin, straight plug-straight socket	2.5 m	18684	KM12-M12-GSGD-2,5	
		5.0 m	18686	KM12-M12-GSGD-5	
	Connecting cable, M12, 4-pin, straight plug-angled socket	1.0 m	185499	KM12 M12-GSWD-1-4	
		Connecting cable, M8, straight plug-straight socket		0.5 m	175488
			1.0 m	175489	KM8-M8-GSGD-1
			2.5 m	165610	KM8-M8-GSGD-2,5
			5.0 m	165611	KM8-M8-GSGD-5
	Mounting				
	Mounting for H-rail		170169	CP-TS-HS35	
User documentation					
	User documentation for input/output modules	German	165125	P.BE.-CPEA-DE	
		English	165225	P.BE.-CPEA-EN	
		French	165127	P.BE.-CPEA-FR	
		Italian	165157	P.BE.-CPEA-IT	
		Spanish	165227	P.BE.-CPEA-ES	
		Swedish	165257	P.BE.-CPEA-SV	

CPI installation system

Technical data – Input modules CP-E...-EL

Function

Digital input modules facilitate the connection of proximity sensors or other 24 V DC sensors (inductive, capacitive, etc.).

Plugs with double allocation are separated using a DUO plug or DUO cable.

Application

- Input modules for 24 V DC sensor signals
- M8 and M12 connection technology
- Display of the input statuses for each input signal via an assigned LED
- Operating voltage supply 24 V DC for all connected sensors
- Diagnostic LED for short circuit/ overload of sensor supply
- Circumferential labelling with large, hinged inscription label
- Earthing plate and H-rail mounting already integrated

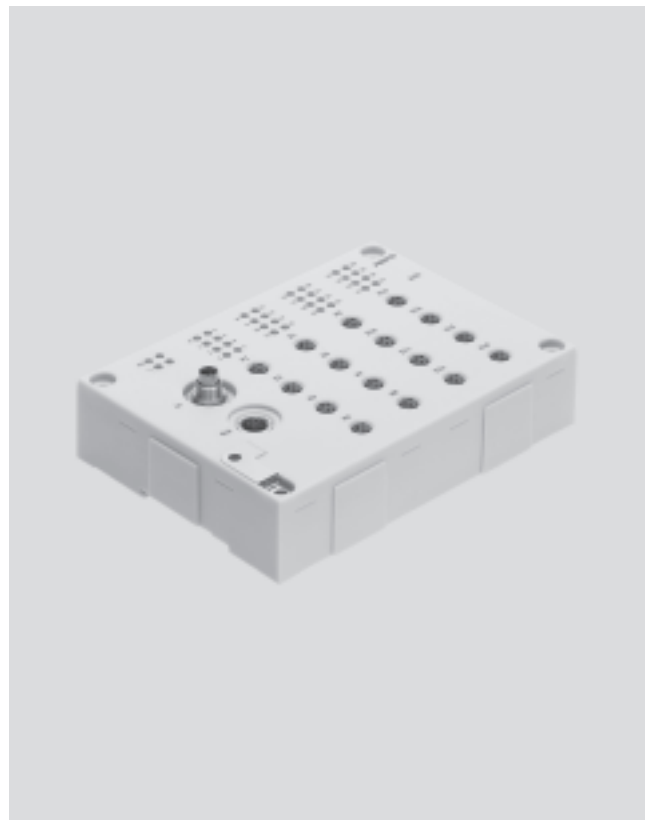

General technical data			
Type	CP-E16-M12-EL positive switching	CP-E16-M8-EL positive switching	CP-E32-M8-EL positive switching
No. of inputs	16		32
Allocation of inputs	Double allocation	Single allocation	Double allocation
Sensor connection type	8x M12, 5-pin	16x M8, 3-pin	16x M8, 4-pin
Power supply 24 V DC	Via CP connection		
Intrinsic current consumption at operating voltage [mA]	Typically 75 mA		
Fuse (short circuit)	Internal electronic fuse protection for each group		Internal electronic fuse
Max. residual current per module [A]	0.7		1.4
Nominal operating voltage for sensors	24		
Operating voltage range for sensors [V]	18 ... 30 DC		
Galvanic isolation	None		
Switching level	Signal 0	[V]	≤ 6
	Signal 1	[V]	≥ 8.6
Debounce time at inputs [ms]	3 ms (0.5 ms, 10 ms, 20 ms, parameterisable)		
Signal extension	0.5 ms (15 ms, 50 ms, 100 ms, parameterisable)		
Switching logic	PNP		
Input characteristic curve	To IEC 11 31-2		
Connection to bus node	Via pre-assembled cables		
Diagnostics	CP communication		
	Short circuit/overload		
	Undervoltage		
LEDs	2 Module diagnostics		2 Module diagnostics 32 Channel status
	4 Group diagnostics		
	16 Channel status		

CPI installation system

Technical data – Input modules CP-E...-EL

FESTO

General technical data				
Type		CP-E16-M12-EL positive switching	CP-E16-M8-EL positive switching	CP-E32-M8-EL positive switching
Dimensions (LxWxH)	[mm]	143 x 104 x 30		
Weight	[g]	260		

Operating conditions				
Type		CP-E16-M12-EL	CP-E16-M8-EL	CP-E32-M8-EL
Protection class to EN 60529		IP65 (when fully plugged in or fitted with protective cover)		
Ambient temperature	Operation	[°C]	–5 ... +50	
	Storage	[°C]	–20 ... +70	
Corrosion resistance class CRC ¹⁾		1		
Certification		cULus listed (OL)		
Certification C-Tick		C-Tick Declaration of Conformity CT 19823		
CE mark (see declaration of conformity)		In accordance with EU EMC directive		

- 1) Corrosion resistance class 1 to Festo standard 940 070
Components requiring low corrosion resistance. Transport and storage protection. Parts that do not have primarily decorative surface requirements, e.g. in internal areas that are not visible or behind covers.

CPI installation system

Technical data – Input modules CP-E...-EL

Connection and display components

CP-E16-M12-EL

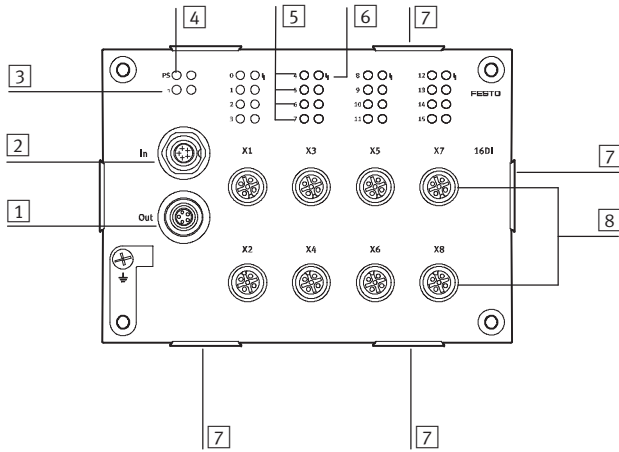

- 1 CP connection, outgoing
- 2 CP connection, incoming
- 3 Status LED (module) for short circuit/overload of sensor supply (red)
- 4 Status LED for CP communication (green)
- 5 Status LEDs for inputs (status display, green)
- 6 Status LED (group) for short circuit/overload of sensor supply (red)
- 7 Fixture for inscription label holder ASCF-H-E2
- 8 Sensor connections (2 inputs per socket)

Pin allocation for sensor connections CP-E16-M12-EL

Pin allocation	Pin	Signal	Description
	1	24 V	Operating voltage 24 V
	2	Ix+1*	Sensor signal
	3	0 V	Operating voltage 0 V
	4	Ix*	Sensor signal
	5	Ground	Earth terminal

* Ix = Input x

CPI installation system

Technical data – Input modules CP-E...-EL

Connection and display components

CP-E16-M8-EL

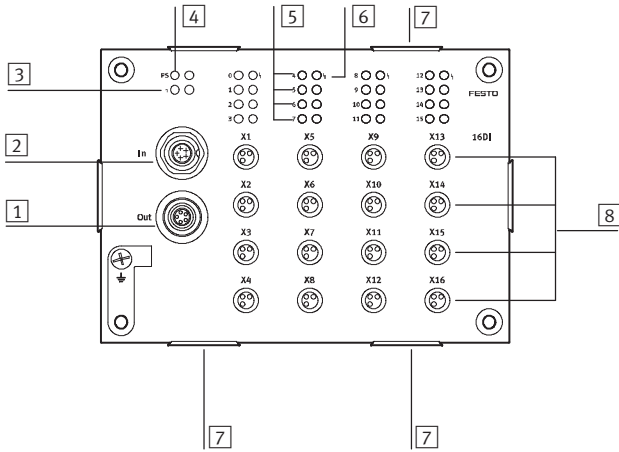

- 1 CP connection, outgoing
- 2 CP connection, incoming
- 3 Status LED (module) for short circuit/overload of sensor supply (red)
- 4 Status LED for CP communication (green)
- 5 Status LEDs for inputs (status display, green)
- 6 Status LED (group) for short circuit/overload of sensor supply (red)
- 7 Fixture for inscription label holder ASCF-H-E2
- 8 Sensor connections (1 input per socket)

Pin allocation for sensor connections CP-E16-M8-EL

Pin allocation	Pin	Signal	Description
	1	24 V	Operating voltage 24 V
	3	0 V	Operating voltage 0 V
	4	Ix*	Sensor signal

* Ix = Input x

CPI installation system

Technical data – Input modules CP-E...-EL

Connection and display components

CP-E32-M8-EL

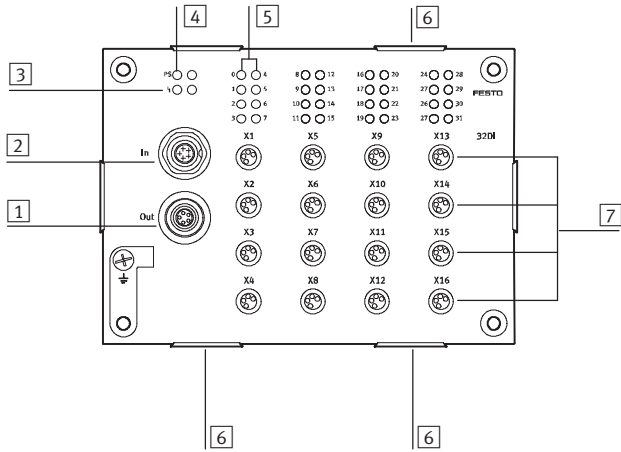

- 1 CP connection, outgoing
- 2 CP connection, incoming
- 3 Status LED (module) for short circuit/overload of sensor supply (red)
- 4 Status LED for CP communication (green)
- 5 Status LEDs for inputs (status display, green)
- 6 Fixture for inscription label holder ASCF-H-E2
- 7 Sensor connections (2 inputs per socket)

Pin allocation for sensor connections CP-E32-M8-EL







Pin allocation	Pin	Signal	Description
	1	24 V	Operating voltage 24 V
	2	Ix+1*	Sensor signal
	3	0 V	Operating voltage 0 V
	4	Ix*	Sensor signal

* Ix = Input x

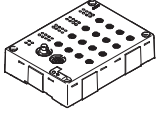
CPI installation system

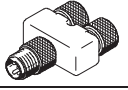
Accessories – Input modules CP-E...-EL

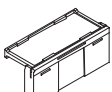
FESTO

Ordering data				
Designation			Part No.	Type
Input modules				
	positive switching		546923	CP-E16-M12-EL
	positive switching		546922	CP-E16-M8-EL
	positive switching		546921	CP-E32-M8-EL
Plug connectors				
	Straight plug, M12	5-pin, PG7	175487	SEA-M12-5GS-PG7
		4-pin, PG7	18666	SEA-GS-7
		4-pin, 2.5 mm ² O.D.	192008	SEA-4GS-7-2,5
	Straight plug, M8	3-pin, solderable	18696	SEA-GS-M8
		3-pin, screw-in	192009	SEA-3GS-M8-S
	Plug for 2 cables, M12, PG11	4-pin	18779	SEA-GS-11-DUO
		5-pin	192010	SEA-5GS-11-DUO
	Push-in T-connector	2x socket M8, 3-pin 1x plug M8, 4-pin	544391	NEDU-M8D3-M8T4
		Push-in T-connector	2x socket M12, 5-pin 1x plug M12, 4-pin	541596
Connecting cables				
	DUO cable, 1x straight plug M12	2x straight socket M8	18685	KM12-DUO-M8-GDGD
		1x straight socket M8 and 1x angled socket M8	18688	KM12-DUO-M8-GDWD
		2x angled socket M8	18687	KM12-DUO-M8-WDWD
	Connecting cable, M12, 4-pin, straight plug-straight socket	2.5 m	539052	NEBU-M12G4-K-2.5-M12G4 ¹⁾
		5.0 m	539052	NEBU-M12G4-K-5-M12G4 ¹⁾
	Connecting cable, M8, 3-pin, straight plug-straight socket	0.5 m	539052	NEBU-M8G3-K-0.5-M8G3 ¹⁾
		1 m	539052	NEBU-M8G3-K-1-M8G3 ¹⁾
		2.5 m	539052	NEBU-M8G3-K-2.5-M8G3 ¹⁾
		5 m	539052	NEBU-M8G3-K-5-M8G3 ¹⁾
Inscription label holders				
	Inscription label holders for EL modules, bag of 10		547473	ASCF-H-E2
User documentation				
	User documentation for input/output modules	German	539299	P.BE.-CPEA-CL-DE
		English	539300	P.BE.-CPEA-CL-EN
		French	539302	P.BE.-CPEA-CL-FR
		Italian	539303	P.BE.-CPEA-CL-IT
		Spanish	539301	P.BE.-CPEA-CL-ES
		Swedish	539304	P.BE.-CPEA-CL-SV

1) Modular product, further information → Internet: nebu

CPI installation system

Technical data – Input modules CP-E...-CL

Function

Digital input modules facilitate the connection of proximity sensors or other 24 V DC sensors (inductive, capacitive, etc.).

Plugs with double allocation are separated using a DUO plug or DUO cable.

Application

- Input modules for 24 V DC sensor signals
- M8 and M12 plug connection technology
- M12 input module, inputs with double allocation. M8 inputs with single allocation
- M12 plug, 5-pin
- The input statuses are indicated for each input signal on an assigned LED
- 24 V DC supply provided for all connected sensors
- Diagnostic LED for short circuit/undervoltage of sensor supply
- Modules support the CPI functionality (only in combination with the CPX CP interface)



General technical data			
Type	CP-E08-M12-CL positive switching	CP-E08-M8-CL positive switching	CP-E16-KL-CL positive switching
No. of inputs	8		16
Allocation of inputs	Double allocation	Single allocation	
Sensor connection type	4x M12, 5-pin	8x M8, 3-pin	Spring-loaded terminals or screw terminals
Power supply 24 V DC	From the bus node, basic unit, CP interface, etc.		
Intrinsic current consumption of electronics [mA]	Typically 35 (inputs not connected)		
Input current at 24 V DC (from sensor) [mA]	Typically 6		
Fuse protection for sensors and electronic module	Internal electronic short circuit protection		
Max. current consumption of sensor supply, residual current [A]	Max. 0.8		
Nominal operating voltage for sensors	24		
Operating voltage range for sensors [V DC]	18 ... 30		
Protection against polarity reversal	For logic and sensor supply		
Galvanic isolation	None		
Switching level	Signal 0	[V]	≤5
	Signal 1	[V]	≥-11
Input delay [ms]	Typically 3		
Switching logic	PNP		
Input characteristic curve	To IEC 1131-2		
Connection to bus node	Via pre-assembled cables		
Diagnostics	Undervoltage		
	Short circuit/overload of sensor supply		

CPI installation system

Technical data – Input modules CP-E...-CL

FESTO

General technical data			
Type	CP-E08-M12-CL positive switching	CP-E08-M8-CL positive switching	CP-E16-KL-CL positive switching
Material	Polybutylene terephthalate		
Material note	Conforms to RoHS		
Dimensions (WxLxH)	[mm]	151 x 30 x 25	
Weight	[g]	165	190
			145

Operating conditions			
Type	CP-E08-M12-CL	CP-E08-M8-CL	CP-E16-KL-CL
Protection class to EN 60529	IP65/IP67 (when fully plugged in or fitted with protective cap)		IP20
Ambient temperature	Operation	[°C]	-5 ... +50
	Storage	[°C]	-20 ... +70
Corrosion resistance class CRC ¹⁾	1		

¹⁾ Corrosion resistance class 1 to Festo standard 940 070
Components requiring low corrosion resistance. Transport and storage protection. Parts that do not have primarily decorative surface requirements, e.g. in internal areas that are not visible or behind covers.

Certifications			
Type	CP-E08-M12-CL	CP-E08-M8-CL	CP-E16-KL-CL
ATEX category gas	II 3G		–
Ex-ignition protection type gas	Ex na II T5 X		–
ATEX category dust	II 3D		–
EX-ignition protection type dust	Ex tD A22 IP65 T80° C X		–
ATEX ambient temperature	[°C]	-5 ≤ Ta ≤ +50	–
Certification	c UL us recognized (OL)		
CE mark (see declaration of conformity)	In accordance with EU explosion protection directive (ATEX)		

 - Note

If device combinations are operated in potentially explosive areas, the lowest common zone, the temperature class as well as the ambient temperature of the individual devices determine the possible use of the complete module.

CPI installation system

Technical data – Input modules CP-E...-CL

Connection and display components

CP-E08-M12-CL

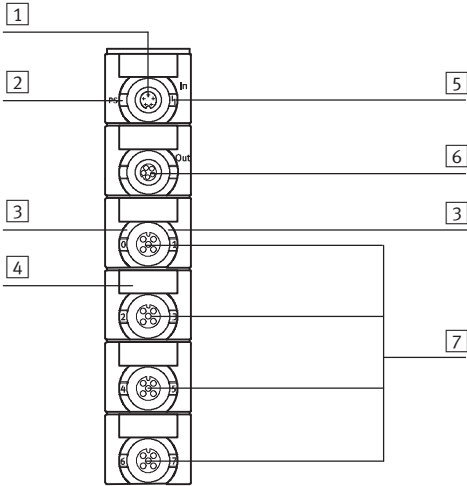

- 1 CP connection, incoming
- 2 Status LED (green)
- 3 Green LED for status display (one LED per input)
- 4 Holder for inscription label (IBS 8x20)
- 5 Red LED for short circuit/overload indication
- 6 CP connection, outgoing
- 7 Sensor connections

Pin allocation for sensor connections CP-E08-M12-CL

Pin allocation	Pin	Signal	Description
	1	24 V	Operating voltage 24 V
	2	I _{x+1} *	Sensor signal
	3	0 V	Operating voltage 0 V
	4	I _x *	Sensor signal
	5	Ground	Earth terminal

* I_x = Input x

CPI installation system

Technical data – Input modules CP-E...-CL

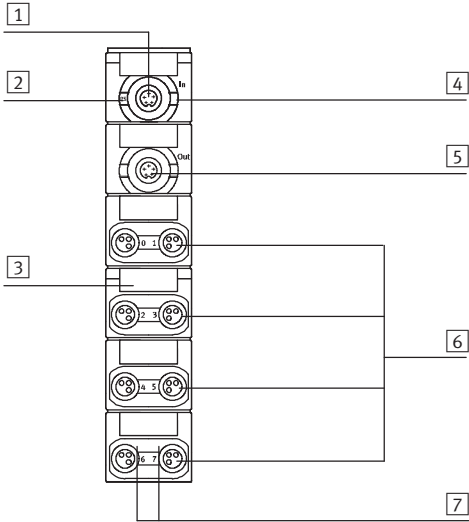

Connection and display components

CP-E08-M8-CL



- 1 CP connection, incoming
- 2 Status LED (green)
- 3 Holder for inscription label (IBS 8x20)
- 4 Red LED for short circuit/overload indication
- 5 CP connection, outgoing
- 6 Sensor connections
- 7 Green LED for status display (one LED per input)

Pin allocation for sensor connections CP-E08-M8-CL

Pin allocation	Pin	Signal	Description	Pin	Signal
	1	24 V	Operating voltage 24 V	1	24 V
	3	0 V	Operating voltage 0 V	3	0 V
	4	Ix*	Sensor signal	4	Ix+1*

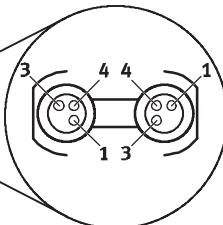

* Ix = Input x

CPI installation system

Technical data – Input modules CP-E...-CL

Connection and display components

CP-E16-KL-CL

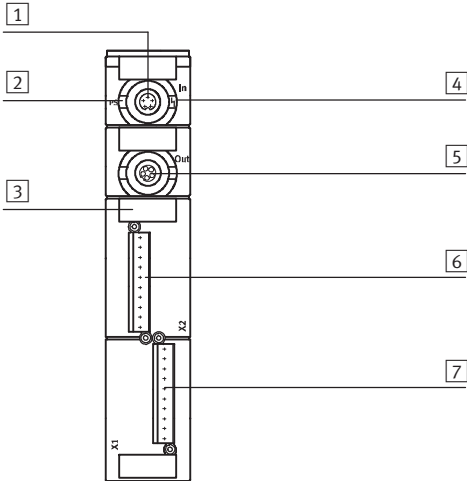

- 1 CP connection, incoming
- 2 Status LED (green)
- 3 Holder for inscription label (IBS 8x20)
- 4 Red LED for short circuit/overload indication
- 5 CP connection, outgoing
- 6 Sensor connections, plug X2
- 7 Sensor connections, plug X1

Pin allocation for sensor supply CP-E16-KL-CL

Pin allocation	Pin	Signal	Description	Pin	Signal	
	Plug X1			Plug X2		Note 8 sensors can be connected to each of the connections X1 and X2. When using the three-row plug PS1-SAC30 or PS1-SAC31-30POL+LED, it is possible to use the second and third contact bank for the sensor power supply via a bridge.
	+	24 V DC	Operating voltage	+	24 V DC	
	0	I 0	Connections for sensors	0	I 8	
	1	I 1		1	I 9	
	2	I 2		2	I 10	
	3	I 3		3	I 11	
	4	I 4		4	I 12	
	5	I 5		5	I 13	
	6	I 6		6	I 14	
	7	I 7		7	I 15	
-	0 V DC		-	0 V DC		







Plug connection for power supply for sensors (PS1-SAC31-30POL+LED)

	Connection row 0		Connection row 1		Connection row 2	
	-	0 V DC	Operating voltage	-	n.c.	-
7	I x+7	Connections for sensors	7	24 V DC	7	0 V DC
6	I x+6		6			
5	I x+5		5			
4	I x+4		4			
3	I x+3		3			
2	I x+2		2			
1	I x+1		1			
0	I x		0			
+	24 V DC	Operating voltage	+	Jumper	+	n.c.

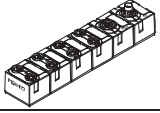
CPI installation system

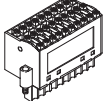
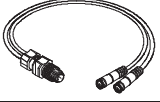
Accessories – Input modules CP-E...-CL

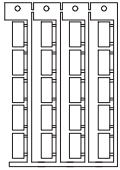
FESTO

Ordering data				
Designation			Part No.	Type
Input modules				
	positive switching		538787	CP-E08-M12-CL
	positive switching		538788	CP-E08-M8-CL
	positive switching		538789	CP-E16-KL-CL
Sensor plugs				
	Plug, straight socket, M12	5-pin, PG7	175487	SEA-M12-5GS-PG7
		4-pin, PG7	18666	SEA-GS-7
		4-pin, 2.5 mm ² O.D.	192008	SEA-4GS-7-2,5
	Straight plug, M8	3-pin, solderable	18696	SEA-GS-M8
		3-pin, screw-in	192009	SEA-3GS-M8-S
	Plug for 2 sensor cables, M12, PG11	4-pin	18779	SEA-GS-11-DUO
		5-pin	192010	SEA-5GS-11-DUO
Connection sets for sensors				
	Plug, screw-in tension-spring socket with LED	3-row, 30-pin	197162	PS1-SAC31-30POL+LED
Cables				
	DUO cable	2x straight socket	18685	KM12-DUO-M8-GDGD
		2x straight/angled socket	18688	KM12-DUO-M8-GDWD
		2x angled socket	18687	KM12-DUO-M8-WDWD
	Connecting cable, M12, 4-pin, straight plug-straight socket	2.5 m	18684	KM12-M12-GSGD-2,5
		5.0 m	18686	KM12-M12-GSGD-5
Inscription labels				
	Inscription labels 8x20 mm in frames (20 pieces)		539388	IBS-8x20
User documentation				
	User documentation for input/output modules	German	539299	P.BE.-CPEA-CL-DE
		English	539300	P.BE.-CPEA-CL-EN
		French	539302	P.BE.-CPEA-CL-FR
		Italian	539303	P.BE.-CPEA-CL-IT
		Spanish	539301	P.BE.-CPEA-CL-ES
		Swedish	539304	P.BE.-CPEA-CL-SV

CPI installation system

Technical data – Output modules CP-A08

Function

The electrical outputs activate actuators such as individual valves, lamps, signal equipment and many more.

 Note
Optimum actuation of valves with M12 central plug.

Application

- Output module with 8 outputs 24 V DC
- M12 connection technology, with 4- or 5-pin sockets
- LED display of the switching status per channel
- Short circuit and overload detection
- Malfunction display by means of green LED



General technical data		
Type	CP-A08-M12-5POL positive switching	CP-A08N-M12 negative switching
No. of outputs	8	
Allocation of outputs	Single allocation	
Output connection type	8x M12, 5-pin	8x M12, 4-pin
Load voltage connection	M18, 4-pin	
Bus connection	2 plugs M9, 5-pin, via prefabricated cables	
Max. output current per channel	[A]	0.5
Operating voltage	[V DC]	24 ±25%
Load voltage connection	[V DC]	24 ±25%, protected against incorrect polarity
Fuse protection for power output	[A]	Electronic fuse per output 0.5
Intrinsic current consumption, electronics	[mA]	Max. 90
Overload/short circuit protection	Per channel	
Switching logic	PNP to IEC 1131-2	NPN to IEC 1131-2
Protection class to EN 60529	IP65 (when fully plugged-in or fitted with protective cover)	
Temperature range	Operation	[°C] -5 ... +50
	Storage	[°C] -20 ... +70
Material	Die-cast aluminium	
Dimensions (L x W x D)	[mm]	172.9 x 78 x 57.1
Weight	[g]	500

CPI installation system

Technical data – Output modules CP-A08

FESTO

Certifications	
This product is certified for operation in the EX range as per EU-ATEX guideline	
ATEX category gas	II 3G
Ex-ignition protection type gas	Ex na II T5 X
ATEX category dust	II 3D
EX-ignition protection type dust	Ex tD A22 IP65 T80° C X
ATEX ambient temperature	[°C] $-5 \leq T_a \leq +50$
Certification	c UL us recognized (OL)
CE mark (see declaration of conformity)	In accordance with EU explosion protection directive (ATEX)

Connection and display components

CP-A08-M12...

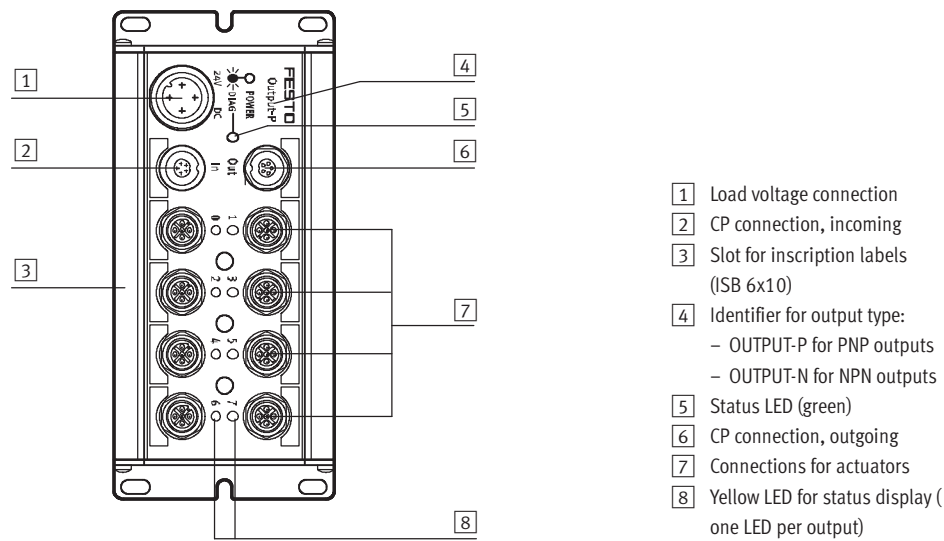

Pin allocation for load voltage connection CP-A08-M12...			
Connection allocation	Pin	Signal	Designation
	1	n.c.	Not connected
	2	24 V DC $\pm 25\%$	Operating voltage
	3	0 V	Operating voltage 0 V
	4	FE (earth)	Protective earth

CPI installation system

Technical data – Output modules CP-A08





Pin allocation for outputs						
Terminal allocation	Pin	Signal	Designation	Pin	Signal	
CP-A08-M12-5POL (PNP outputs)						
	1	n.c.	Not connected	1	n.c.	<p>Note</p> <p>Two outputs can be connected to output sockets 0, 2, 4 and 6 of the CP output module by means of internal connection between pin 2 of the even numbered output and pin 4 of the opposite odd numbered output.</p>
	2	Ox+1	Connected with pin 4 of plug 2/ not connected	2	n.c.	
	3	0 V	Reference potential	3	0 V	
	4	Ox	Output/connected with pin 2 of plug 1	4	Ox+1	
	5	Load	Earth terminal	5	Load	
CP-A08-M12 (NPN outputs)						
	1	24 V DC	Operating voltage	1	24 V DC	<p>Note</p> <p>The consuming devices/load must be supplied with a 24 V operating voltage via pin 1.</p>
	2	FE (earth)	Earth terminal	2	FE (earth)	
	3	n.c.	Not connected	3	n.c.	
	4	Ox	Output	4	Ox+1	

* Ox = Output x

CPI installation system

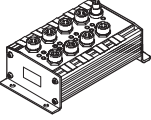
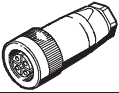
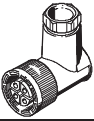
Accessories – Output modules CP-A08

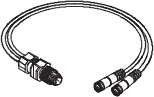
FESTO

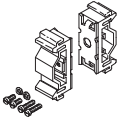
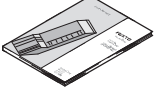
Ordering data				
Designation			Part No.	Type
Output modules				
	positive switching		175640	CP-A08-M125POL
	negative switching		18234	CP-A08N-M12
Power supply				
	Power supply socket, straight, M18x1, 4-pin	for 1.5 mm ²	18493	NTSD-GD-9
		for 2.5 mm ²	18526	NTSD-GD-13,5
	Power supply socket, angled, M18x1, 4-pin	for 1.5 mm ²	18527	NTSD-WD-9
		for 2.5 mm ²	533119	NTSD-WD-11
Sensor plugs				
	Plug, straight socket, M12	5-pin, PG7	175487	SEA-M12-5GS-PG7
		4-pin, PG7	18666	SEA-GS-7
		4-pin, 2.5 mm ² OD	192008	SEA-4GS-7-2,5
	Plug for 2 sensor cables, M12, PG11	4-pin	18779	SEA-GS-11-DUO
		5-pin	192010	SEA-5GS-11-DUO
Cables				
	DUO cable	2x straight socket	18685	KM12-DUO-M8-GDGD
		2x straight/angled socket	18688	KM12-DUO-M8-GDWD
		2x angled socket	18687	KM12-DUO-M8-WDWD
	Connecting cable, M12, 4-pin, straight plug-straight socket	2.5 m	18684	KM12-M12-GSGD-2,5
		5.0 m	18686	KM12-M12-GSGD-5
Mounting				
	Mounting for H-rail		170169	CP-TS-HS35
User documentation				
	User documentation for input/output modules	German	165125	P.BE.-CPEA-DE
		English	165225	P.BE.-CPEA-EN
		French	165127	P.BE.-CPEA-FR
		Italian	165157	P.BE.-CPEA-IT
		Spanish	165227	P.BE.-CPEA-ES
		Swedish	165257	P.BE.-CPEA-SV

CPI installation system

Technical data – Output modules CP-A08-EL

Function

The electrical outputs actuate actuators such as individual valves, lamps, signal equipment and many more.

Note
The output module is ideal for actuation of valves with M12 central plug.

Application

- Output module with 8 outputs 24 V DC
- M12, 5-pin connection technology
- Display of the switching status per channel via LED
- Short circuit and overload detection
- Malfunction display by means of red LED
- Module supports the CPI functionality (only in combination with the CPX CP interface)
- Circumferential labelling with large, hinged inscription label
- Earthing plate and H-rail mounting already integrated

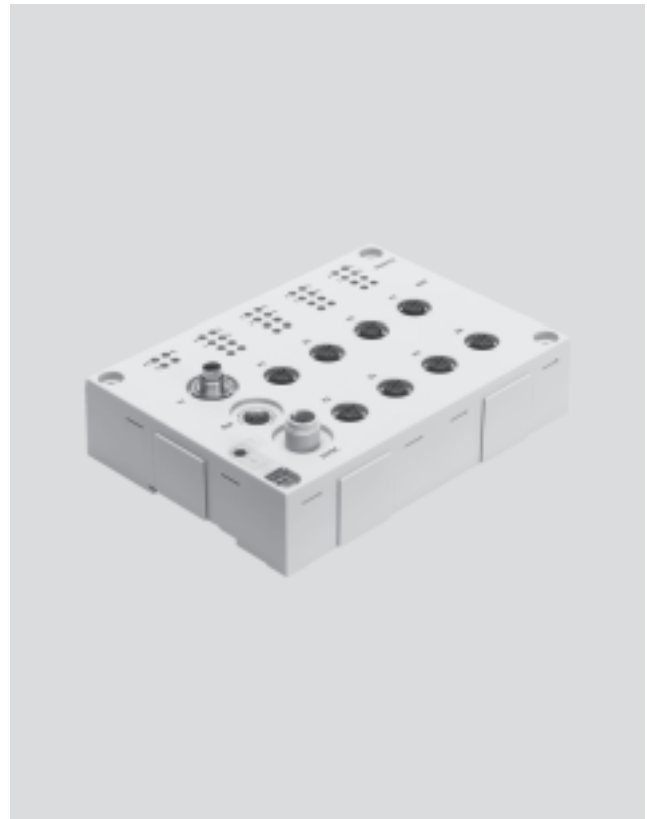

General technical data		
Type	CP-A08-M12-EL-Z positive switching	
No. of outputs	8	
Allocation of outputs	Socket 1, 3, 5 and 7 with double allocation, socket 2, 4, 6 and 8 with single allocation	
Sensor connection type	8x M12, 5-pin	
Power supply 24 V DC	M12, 5-pin	
Intrinsic current consumption at operating voltage	[mA]	Typically 35
Max. residual current per module	[A]	4
Max. output current per channel	[A]	Max. 0.5, max. 2 outputs can be connected in parallel
Nominal operating voltage	[V DC]	24
Operating voltage range	[V DC]	18 ... 30
Fuse (short circuit)	Internal electronic fuse protection for each channel	
Switching logic	PNP	
Output characteristic curve	To ICE 11 31-2	
Galvanic isolation	None	
Connection to bus node	Via pre-assembled cables	
Diagnostics	CP communication	
	Short circuit/overload per channel	
	Undervoltage	
Dimensions (LxWxH)	[mm]	143 x 104 x 30
Weight	[g]	260

CPI installation system

Technical data – Output modules CP-A08-EL



Operating conditions			CP-A08-M12-EL-Z
Type			CP-A08-M12-EL-Z
Protection class to EN 60529			IP65 (when fully plugged in or fitted with protective cover)
Ambient temperature	Operation	[°C]	-5 ... +50
	Storage	[°C]	-20 ... +70
Corrosion resistance class CRC ¹⁾			1
CE mark (see declaration of conformity)			In accordance with EU EMC directive
Certification			cULus listed (OL)
Certification C-Tick			C-Tick Declaration of Conformity CT 19823

1) Corrosion resistance class 1 to Festo standard 940 070
Components requiring low corrosion resistance. Transport and storage protection. Parts that do not have primarily decorative surface requirements, e.g. in internal areas that are not visible or behind covers.

Connection and display components

CP-A08-M12-EL-Z

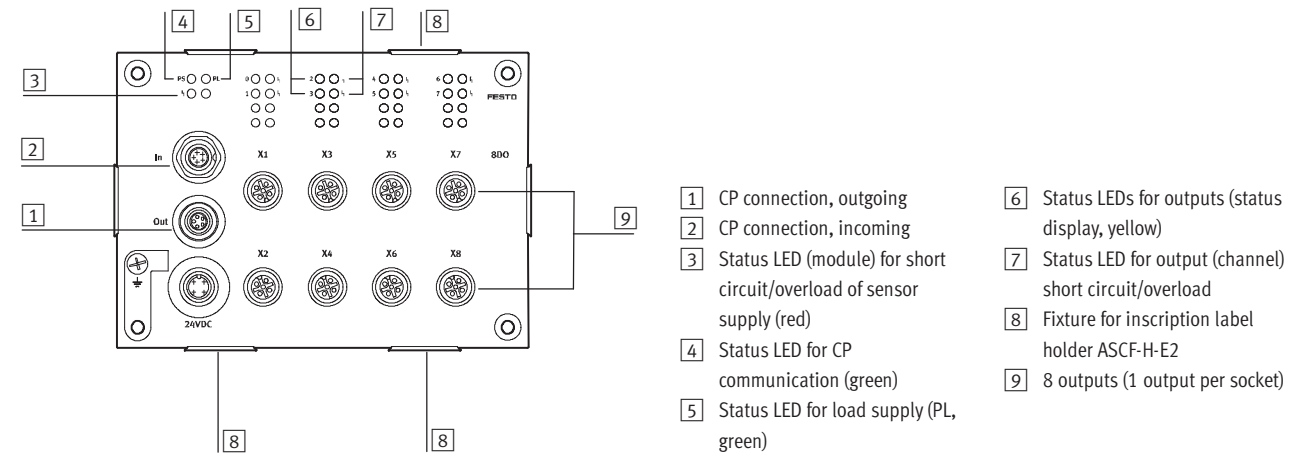

Pin allocation for load voltage connection CP-A08-M12-EL-Z			
Pin allocation	Pin	Signal	Description
	1	n.c.	Not connected
	2	24 V DC ±25%	Operating voltage
	3	0 V	Operating voltage 0 V
	4	FE	Protective earth

CPI installation system

Technical data – Output modules CP-A08-EL

Pin allocation for outputs				
Pin allocation	Output 1, 3, 5 and 7		Description	
	Pin	Signal		
CP-A08-M12-EL-Z (odd number of PNP outputs)				
	1	n.c.	Not connected	<p>Note</p> <p>Two outputs can be connected to output sockets 1, 3, 5 and 7 of the CP output module by means of internal connection between pin 2 of the odd numbered output and pin 4 of the underlying even numbered output.</p>
	2	Ox+1	Connected with pin 4 of output 2	
	3	0 V	Reference potential	
	4	Ox	Output	
	5	FE	Earth terminal	

* Ox = Output x







Pin allocation for outputs				
Pin allocation	Output 2, 4, 6 and 8		Description	
	Pin	Signal		
CP-A08-M12-EL-Z (even number of PNP outputs)				
	1	n.c.	Not connected	
	2	n.c.	Not connected	
	3	0 V	Reference potential	
	4	Ox+1	Connected with pin 2 of output 1	
	5	FE	Earth terminal	

* Ox = Output x

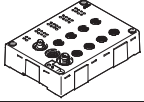
CPI installation system

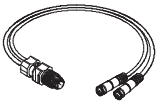
Accessories – Output modules CP-A08-EL

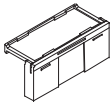
FESTO

Ordering data				
Designation			Part No.	Type
Output modules				
	positive switching		546924	CP-A08-M12-EL-Z
Plug connectors				
	Straight plug, M12	5-pin, PG7	175487	SEA-M12-5GS-PG7
		4-pin, PG7	18666	SEA-GS-7
		4-pin, 2.5 mm ² O.D.	192008	SEA-4GS-7-2,5
	Plug for 2 cables, M12, PG11	4-pin	18779	SEA-GS-11-DUO
		5-pin	192010	SEA-5GS-11-DUO
Connecting cables				
	DUO cable, 1x straight plug M12	2x straight socket M8	18685	KM12-DUO-M8-GDGD
		1x straight socket M8 and 1x angled socket M8	18688	KM12-DUO-M8-GDWD
		2x angled socket M8	18687	KM12-DUO-M8-WDWD
	Connecting cable, M12, 4-pin, straight plug-straight socket	2.5 m	539052	NEBU-M12G4-K-2.5-M12G4 ¹⁾
		5.0 m	539052	NEBU-M12G4-K-5-M12G4 ¹⁾
Inscription label holders				
	Inscription label holders for EL modules, bag of 10		547473	ASCF-H-E2
User documentation				
	User documentation for input/output modules	German	539299	P.BE.-CPEA-CL-DE
		English	539300	P.BE.-CPEA-CL-EN
		French	539302	P.BE.-CPEA-CL-FR
		Italian	539303	P.BE.-CPEA-CL-IT
		Spanish	539301	P.BE.-CPEA-CL-ES
		Swedish	539304	P.BE.-CPEA-CL-SV

1) Modular product, further information → Internet: nebu

CPI installation system

Technical data – Output modules CP-A04

Function

The electrical outputs actuate actuators such as individual valves, lamps, signal equipment and many more.

 Note
Optimum actuation for valves with M12 central plug.

Application

- Output module with 4 outputs 24 V DC
- M12 connection technology, with 5-pin sockets
- LED display of the switching status per channel
- Short circuit and overload detection
- Malfunction display by means of red LED
- Module supports the CPI functionality (only in combination with the CPX CP interface)



General technical data		CP-A04-M12-CL positive switching
Type		CP-A04-M12-CL positive switching
No. of outputs		4
Allocation of outputs		Socket 1 and 3 with double allocation, socket 2 and 4 with single allocation
Sensor connection type		4x M12, 5-pin
Power supply 24 V DC		From the bus node, basic unit, CP interface, etc.
Intrinsic current consumption of electronics	[mA]	Typically 35
Max. output current per channel	[A]	Max. 0.5, max. 2 outputs can be connected in parallel
Operating voltage	[V DC]	24 ±25%
Fuse protection for power output		Internal electronic short-circuit protection per output
Switching logic		PNP
Output characteristic curve		To ICE 1131-2
Galvanic isolation		None
Connection to bus node		Via pre-assembled cables
Diagnostics		Undervoltage Short circuit at actuator output (per channel)
Material		Polybutylene terephthalate
Dimensions (LxWxD)	[mm]	151 x 30 x 25
Weight	[g]	165

CPI installation system

Technical data – Output modules CP-A04

FESTO

Operating conditions		
Protection class to EN 60529	IP65/IP67 (when fully plugged in or fitted with protective cap)	
Ambient temperature	Operation	[°C] –5 ... +50
	Storage	[°C] –20 ... +70
Corrosion resistance class CRC ¹⁾	1	

1) Corrosion resistance class 1 to Festo standard 940 070
Components requiring low corrosion resistance. Transport and storage protection. Parts that do not have primarily decorative surface requirements, e.g. in internal areas that are not visible or behind covers.

Certifications	
This product is certified for operation in the EX range as per EU-ATEX guideline	
ATEX category gas	II 3G
Ex-ignition protection type gas	Ex na II T5 X
ATEX category dust	II 3D
EX-ignition protection type dust	Ex tD A22 IP65 T80° C X
ATEX ambient temperature	[°C] –5 ≤ Ta ≤ +50
Certification	c UL us recognized (OL)

 - Note

If device combinations are operated in potentially explosive areas, the lowest common zone, the temperature class as well as the ambient temperature of the individual devices determine the possible use of the complete module.

CPI installation system

Technical data – Output modules CP-A04

Connection and display components

CP-A04-M12-CL

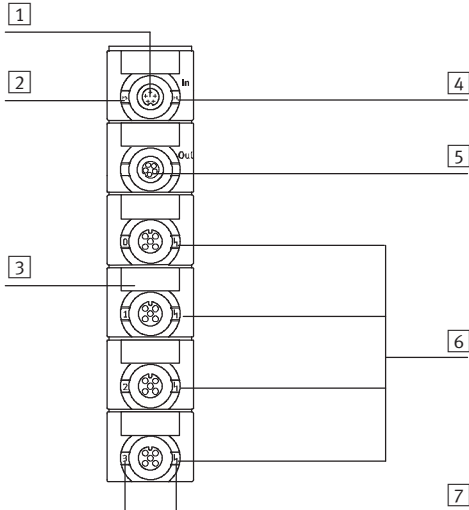

- 1 CP connection, incoming
- 2 Status LED (green)
- 3 Holder for inscription label (IBS 8x20)
- 4 Red LED for short circuit/overload indication
- 5 CP connection, outgoing
- 6 Output
- 7 Green LED for status display (one LED per output)

Pin allocation for outputs





Pin allocation	Output 1 and 3		Description	Output 2 and 4		
	Pin	Signal		Pin	Signal	
CP-A08-M12-5POL (PNP outputs)						
	1	n.c.	Not connected	1	n.c.	<p>Note</p> <p>Two outputs can be connected to output sockets 1 and 3 of the CP output module by means of internal connection between pin 2 of the odd numbered output and pin 4 of the underlying even numbered output.</p>
	2	Ox+1	Connected with pin 4 of plug 2/ not connected	2	n.c.	
	3	0 V	Reference potential	3	0 V	
	4	Ox	Output/connected with pin 2 of plug 1	4	Ox+1	
	5	FE	Earth terminal	5	FE	

* Ox = Output x

CPI installation system

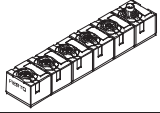
Accessories – Output modules CP-A04

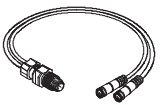
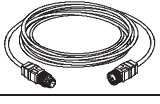
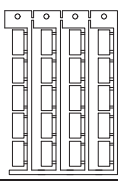
FESTO

Ordering data				
Designation			Part No.	Type
Output modul				
	Positive switching		538790	CP-A04_M12_CL
Sensor plugs				
	Plug, straight socket, M12	5-pin, PG7	175487	SEA-M12-5GS-PG7
		4-pin, PG7	18666	SEA-GS-7
		4-pin, 2.5 mm ² O.D.	192008	SEA-4GS-7-2,5
	Plug for 2 sensor cables, M12, PG11	4-pin	18779	SEA-GS-11-DUO
		5-pin	192010	SEA-5GS-11-DUO
Cables				
	DUO cable	2x straight socket	18685	KM12-DUO-M8-GDGD
		2x straight/angled socket	18688	KM12-DUO-M8-GDWD
		2x angled socket	18687	KM12-DUO-M8-WDWD
	Connecting cable, M12, 4-pin, straight plug-straight socket	2.5 m	18684	KM12-M12-GSGD-2,5
		5.0 m	18686	KM12-M12-GSGD-5
Inscription labels				
	Inscription labels 8x20 mm in frames (20 pieces)		539388	IBS-8x20
User documentation				
	User documentation for input/output modules	German	539299	P.BE.-CPEA-CL-DE
		English	539300	P.BE.-CPEA-CL-EN
		French	539302	P.BE.-CPEA-CL-FR
		Italian	539303	P.BE.-CPEA-CL-IT
		Spanish	539301	P.BE.-CPEA-CL-ES
		Swedish	539304	P.BE.-CPEA-CL-SV

CPI installation system

Technical data – MPA valve terminals

-  - Flow rate
MPA1: Up to 360 l/min
MPA2: Up to 700 l/min

-  - Valve width
MPA1: 10 mm
MPA2: 21 mm

-  - Voltage
24 V DC

CPI interface for communication between an MPA valve terminal and a CPI master. It activates an MPA valve terminal with up to 32 solenoid coils on max. 32 valve positions.

-  - Note

With more than 16 MPA2 solenoid coils an additional electrical supply is absolutely necessary (after 4 electronic modules).

Note that without an additional electrical supply maximum 24 solenoid

coils may be switched. If more than 24 MPA1 or 12 MPA2 solenoid coils are to be switched simultaneously, an additional supply must be inserted after the third electronic module.



General technical data			MPA-CPI-VI
Type			MPA-CPI-VI
CP interface, incoming			Plug M9, 5-pin
CP interface, outgoing			Socket M9, 5-pin
Max. no. of solenoid coils			32
LED display (product-specific)	PS		Common message regarding power supply
	PL		Power supply for valves
	Symbol		Module fault
Nominal operating voltage	[V DC]		24
Operating voltage range	[V DC]		24 ± 2.5%
Power failure bridging	Logic side only	[ms]	10
Current consumption at nominal operating voltage	Load	[mA]	Dependent on valve type and number of valves
	Electronics	[mA]	Approx. 50 (plus current consumption of electronic modules)
Residual ripple	[Vss]		4
Materials			Die-cast aluminium, polyamide
Dimensions			→ Internet: type 32
Weight	[g]		200
Technical data on valves			→ Internet: type 32

CPI installation system

Technical data – MPA valve terminals

FESTO

Operating conditions			
Protection class to EN 60529		IP65 (when fully plugged in or fitted with protective cover)	
Ambient temperature	Operation	[°C]	-5 ... +50

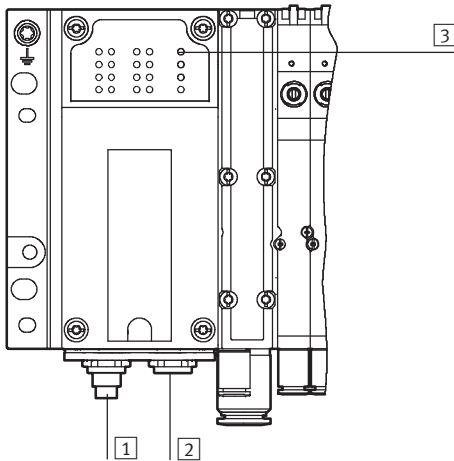

Certifications			
ATEX category gas		II 3G	
Ex-ignition protection type gas		Ex nA II T5 X	
ATEX category dust		II 3D	
EX-ignition protection type dust		Ex tD A22 IP54 T90°C X	
ATEX ambient temperature		[°C]	-5 ≤ Ta ≤ +50

Connection and display components



- 1 CP connection, incoming
- 2 CP connection, outgoing
- 3 Status LEDs
CP system supply (green)
Load supply (green)
Module fault (red)

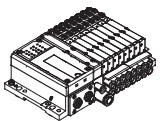

Ordering data – Accessories

Designation		Part No.	Type
MPA valve terminal			
	With CPI interface	546280	MPA-CPI-VI
Valve terminal connection			
	Connecting cable WS-WD	0.25 m	540327 KVI-CP-3-WS-WD-0,25
		0.5 m	540328 KVI-CP-3-WS-WD-0,5
		2 m	540329 KVI-CP-3-WS-WD-2
		5 m	540330 KVI-CP-3-WS-WD-5
		8 m	540331 KVI-CP-3-WS-WD-8
	Connecting cable GS-GD	2 m	540332 KVI-CP-3-GS-GD-2
		5 m	540333 KVI-CP-3-GS-GD-5
		8 m	540334 KVI-CP-3-GS-GD-8

CPI installation system

Technical data – CPV-SC valve terminals

FESTO

-  - Flow rate
170 l/min
-  - Valve width
10 mm
-  - Voltage
24 V DC

CPI interface for communication between a CPV-SC valve terminal and a CPI master. It activates a CPV-SC valve terminal with up to 16 solenoid coils.



General technical data		
Type		CPVSC1-AE16-CPI
CP interface, incoming		Plug M9, 5-pin
CP interface, outgoing		Socket M9, 5-pin
Max. no. of solenoid coils		16
LED display (product-specific)		Status LED for CP communication Status LEDs for valves
Nominal operating voltage	[V DC]	24
Operating voltage range	[V DC]	20.4 ... 26.4
Power failure bridging	Logic side only	[ms] 10
Current consumption at nominal operating voltage	Load	[mA] Dependent on valve type and number of valves
	Electronics	[mA] Max. 100
Materials		Polymer
Dimensions		➔ Internet: type 80
Weight	[g]	150
Technical data on valves		➔ Internet: type 80

CPI installation system

Technical data – CPV-SC valve terminals



Operating conditions			
Protection class to EN 60529		IP40 (when fully plugged in or fitted with protective cover)	
Ambient temperature	Operation	[°C]	-5 ... +50
	Storage	[°C]	-20 ... +40
Corrosion resistance class CRC ¹⁾		1	
CE mark (see declaration of conformity)		In accordance with EU EMC directive	
Certification		c UL us Recognized (OL)	

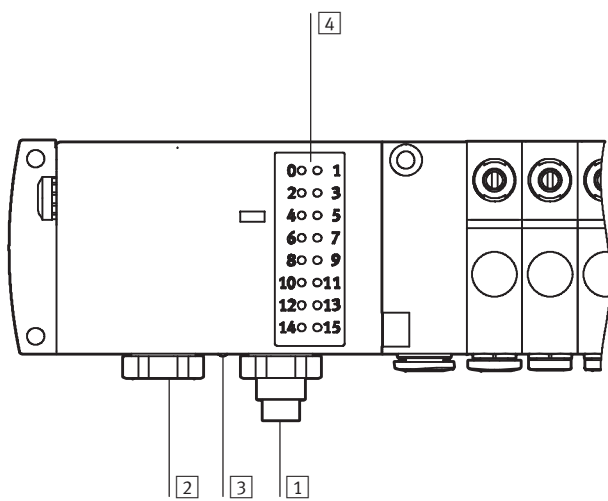

¹⁾ Corrosion resistance class 1 to Festo standard 940 070
Components requiring low corrosion resistance. Transport and storage protection. Parts that do not have primarily decorative surface requirements, e.g. in internal areas that are not visible or behind covers.

Connection and display components

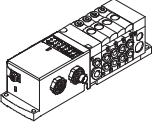

- 1 CP connection, incoming
- 2 CP connection, outgoing
- 3 Status LED for CP communication
- 4 Status LEDs for valves

Ordering data – Accessories

Designation	Part No.	Type
CPV-SC valve terminals		
 with CPI interface	541975	CPVSC1-AE16-CPI
Valve terminal connection		
 Connecting cable WS-WD	0.25 m	540327 KVI-CP-3-WS-WD-0,25
	0.5 m	540328 KVI-CP-3-WS-WD-0,5
	2 m	540329 KVI-CP-3-WS-WD-2
	5 m	540330 KVI-CP-3-WS-WD-5
	8 m	540331 KVI-CP-3-WS-WD-8
 Connecting cable GS-GD	2 m	540332 KVI-CP-3-GS-GD-2
	5 m	540333 KVI-CP-3-GS-GD-5
	8 m	540334 KVI-CP-3-GS-GD-8

CPI installation system

Technical data

Dimensions – Fieldbus node/control block

Download CAD data → www.festo.com

CPX-FB... /CPX-FEC and CPX-CP-4-FB

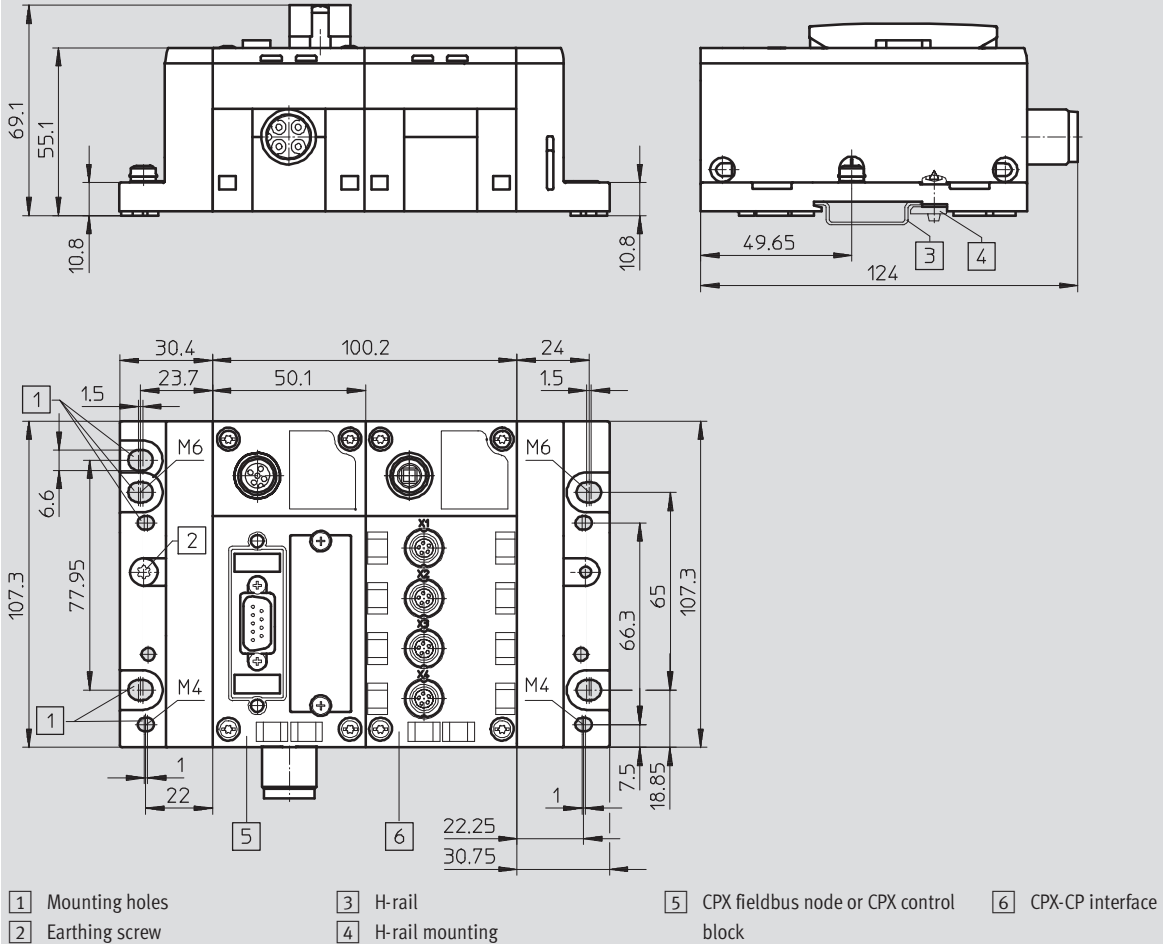

CPI installation system

Technical data

FESTO

Dimensions

Download CAD data → www.festo.com

Fieldbus node

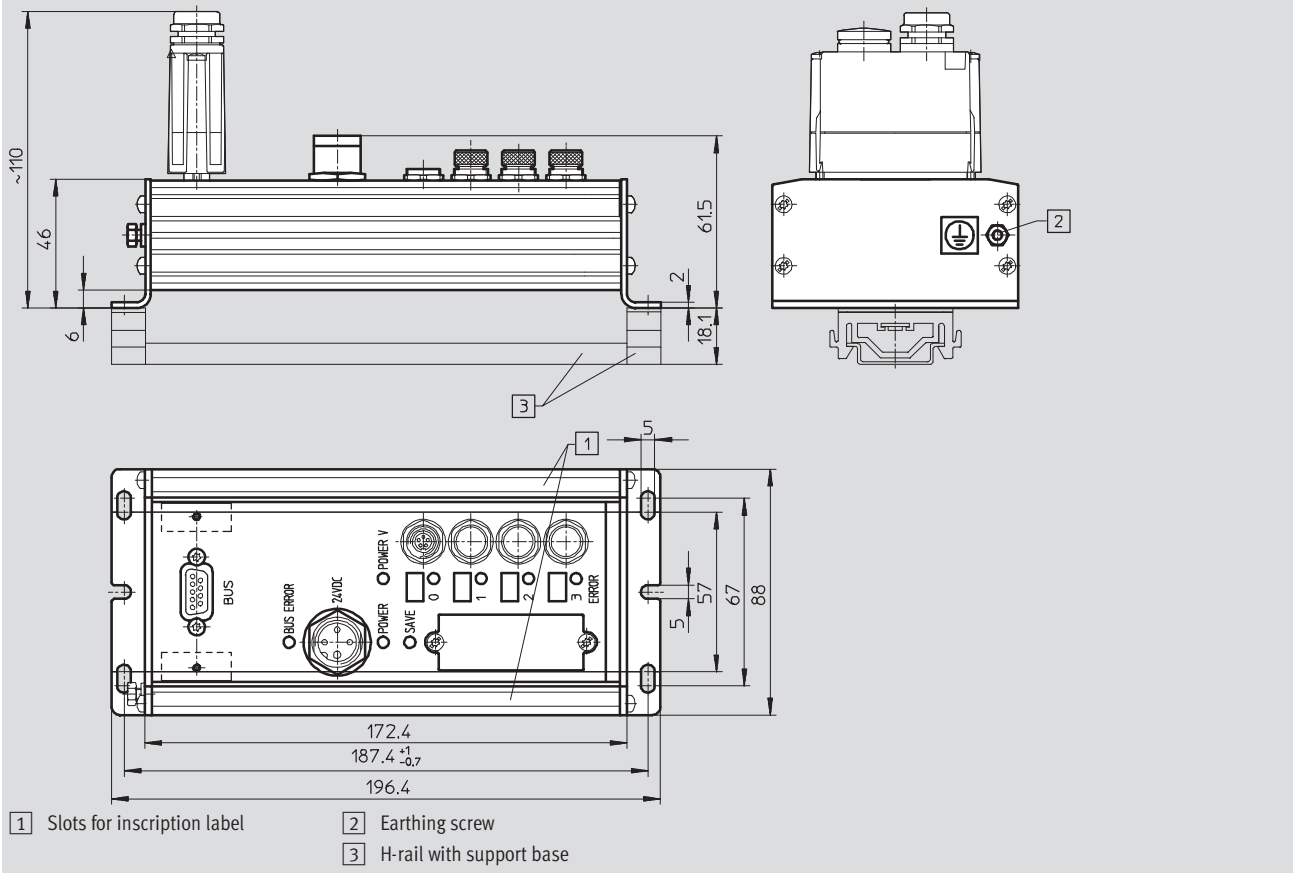

-  - Note

The dimensions are valid for the fieldbus node types:

- CP-FB05-E
- CP-FB06-E
- CP-FB11-E
- CP-FB13-E

Different height ~110 (incl. fieldbus plug) for

- CP-FB06-E with M23
- CP-FB11-E with M12
- CP-FB13-E with 2x M12

CPI installation system

Technical data

Dimensions – Sturdy input modules

Download CAD data → www.festo.com

CP-E16-M8

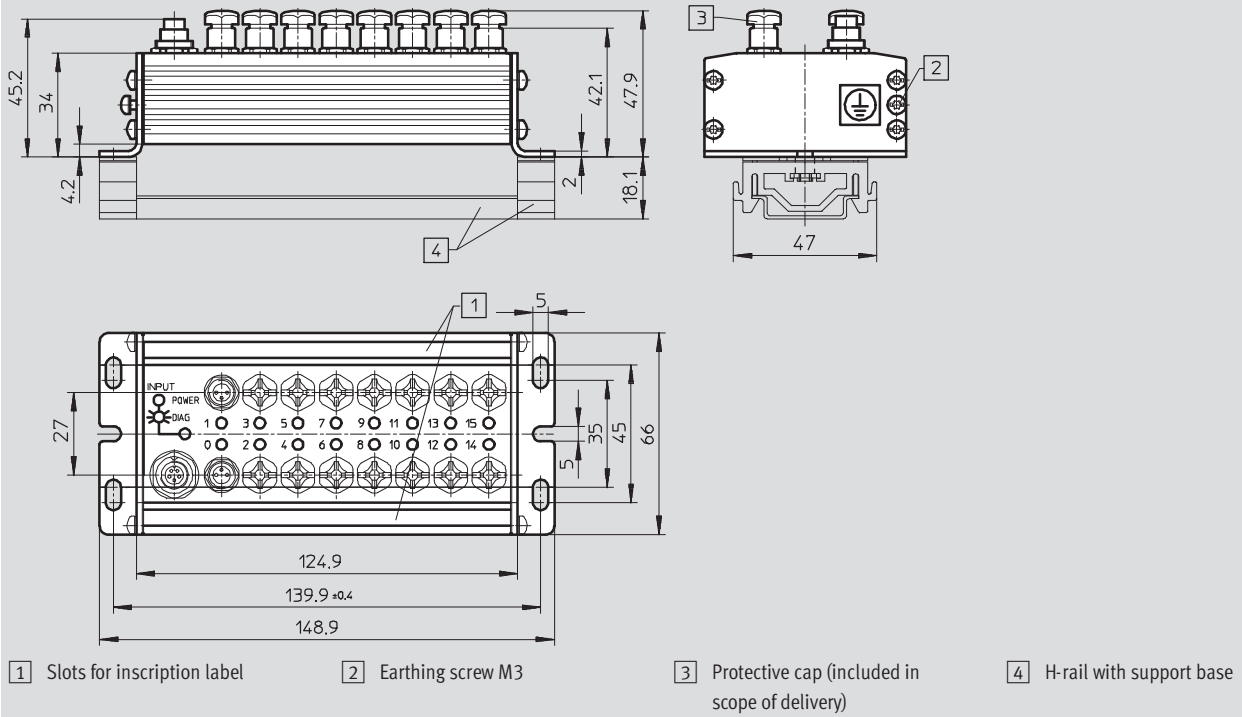

CP-E16-M8-Z

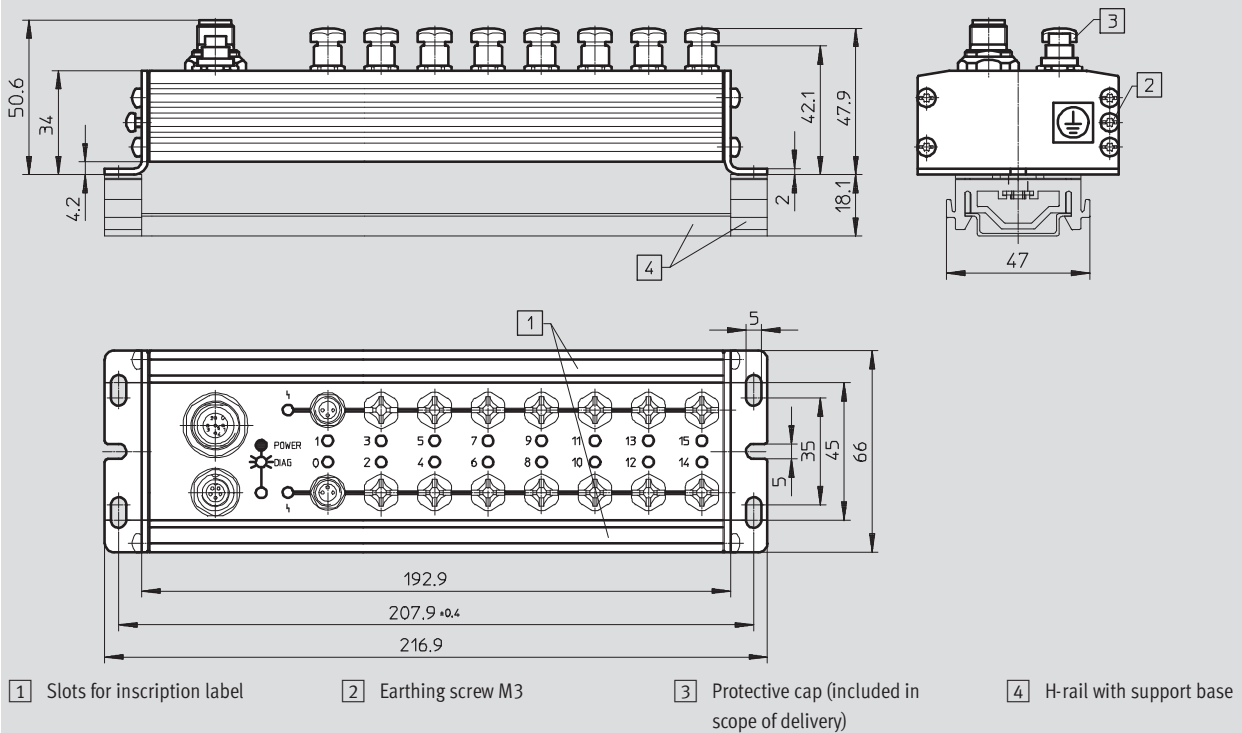

CPI installation system

Technical data

FESTO

Dimensions – Sturdy input modules

Download CAD data → www.festo.com

CP-E16-M12x2-5POL/CP-E16N-M12x2

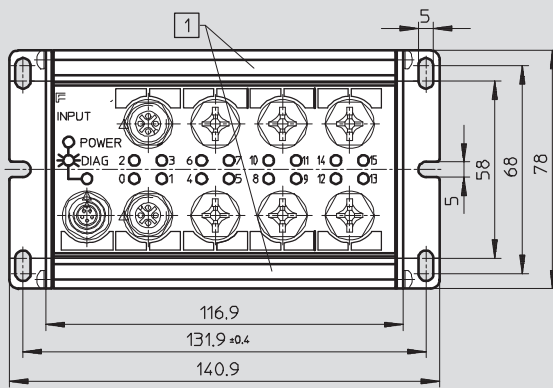
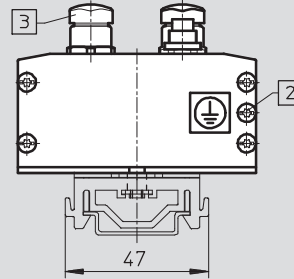
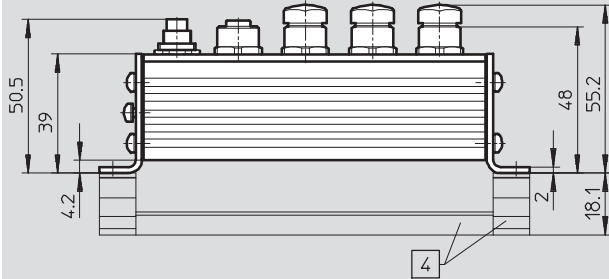

1 Slots for inscription label

2 Earthing screw M3

3 Protective cap (included in scope of delivery)

4 H-rail with support base

CPI installation system

Technical data

FESTO

Dimensions – Economical input modules

Download CAD data → www.festo.com

CP-E16-M8-EL

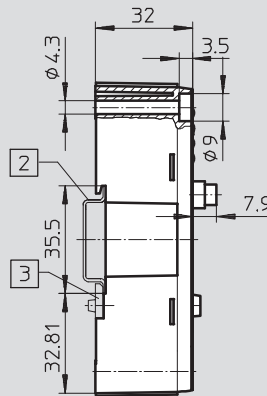
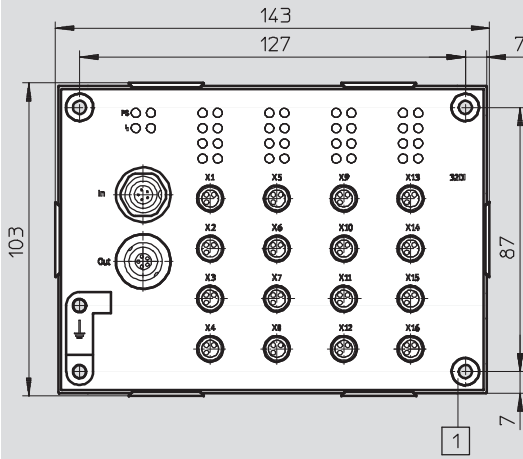

- 1 Through-hole for surface mounting
- 2 H-rail
- 3 Mounting kit for H-rail (included in the scope of delivery)

CP-E16-M12-EL

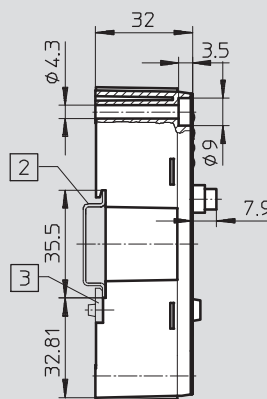
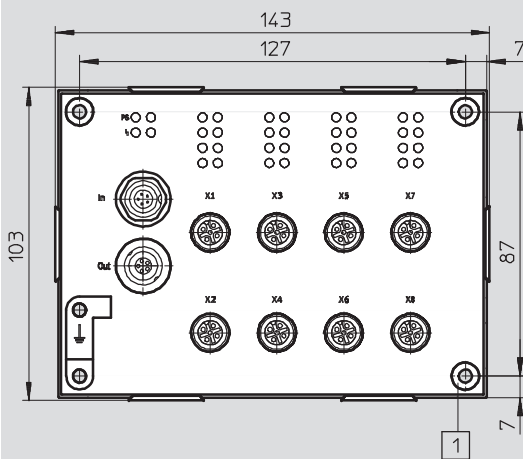

- 1 Through-hole for surface mounting
- 2 H-rail
- 3 Mounting kit for H-rail (included in the scope of delivery)

CP-E32-M8-EL

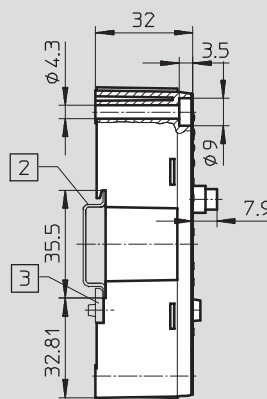
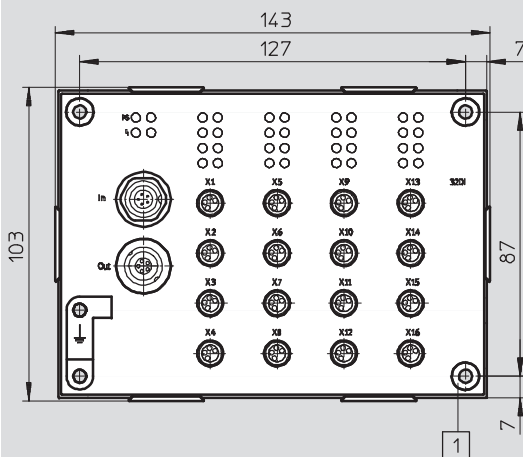

- 1 Through-hole for surface mounting
- 2 H-rail
- 3 Mounting kit for H-rail (included in the scope of delivery)

CPI installation system

Technical data

FESTO

Dimensions – Sturdy output modules

Download CAD data → www.festo.com

CP-A08-M12-5/CP-A08N-M12

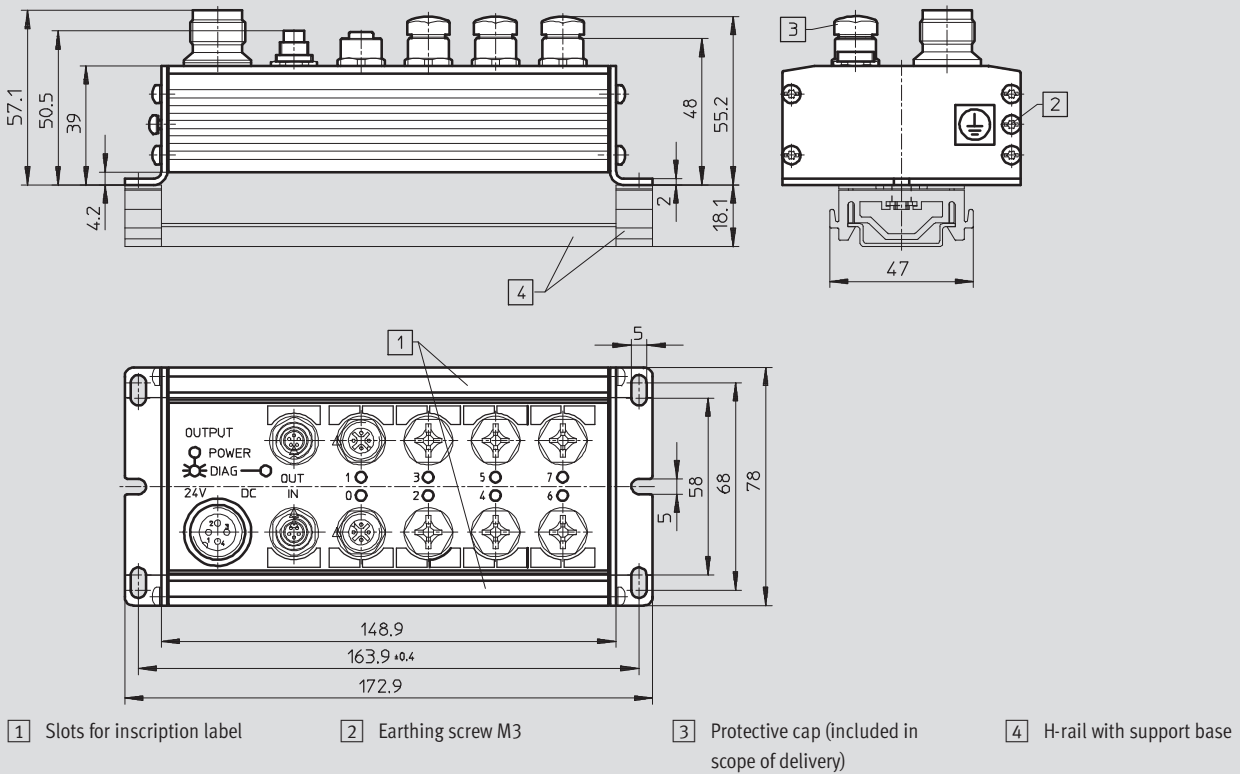

Dimensions – Economical output module

Download CAD data → www.festo.com

CP-A08-M12-EL-Z

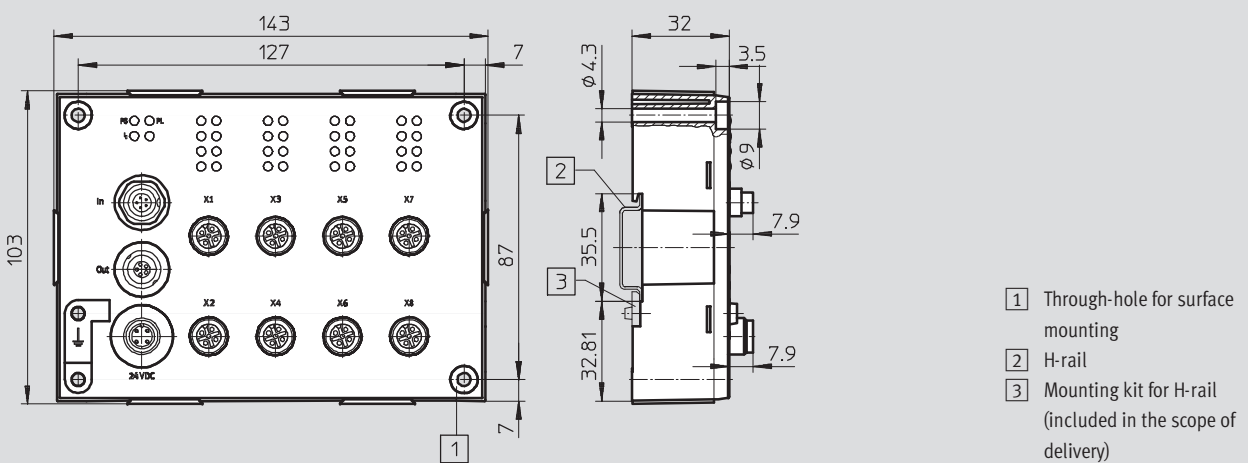

CPI installation system

Technical data

Dimensions – Compact CP modules

Download CAD data → www.festo.com

CP-E08-M12-CL/CP-A04-M12-CL

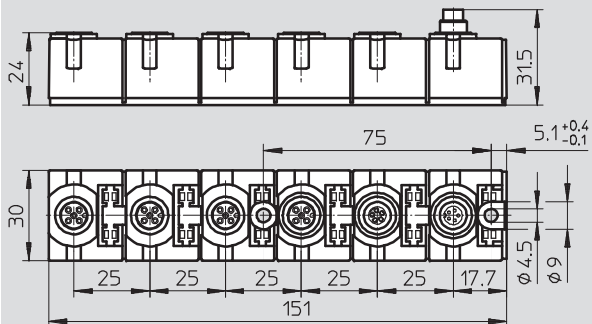

CP-E08-M8-CL

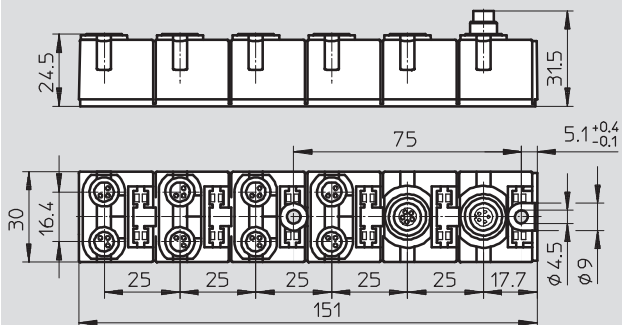

CP-E16-KL-CL

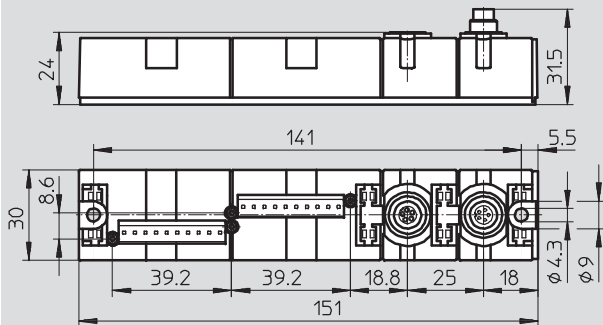

CPI installation system

Order processing information

Configuration guidelines

The CPI system supports a certain number of modules per CP string depending on the type of the CP master and the CP modules connected. CP masters and CP modules can be split into two different groups:

- With CPI functionality
- Without CPI functionality

CP modules with CPI functionality

CP modules with CPI functionality offer the following features:

- Incoming and outgoing CP interface
- Any arrangement of the modules within a CP string
- Max. 4 modules per CP string
- Max. 32 inputs and outputs can be connected to each string depending on the version

CP modules without CPI functionality

Sturdy CP modules offer the following features:

- CP valve terminals and CP output modules have an incoming and outgoing CP interface
- CP input modules only have an incoming CP interface and therefore can only be positioned at the end of a CP string
- All CP modules with CPI functionality can also be connected to CP masters without extended functionality

Information on using CP modules with and without CPI functionality

A mixture of CP modules with and without CPI functionality is possible. The following must be noted in this regard:

- Only one input module without CPI functionality is possible per CP string (at the end of a CP string)
- Only one CP valve terminal or output module without CPI functionality is possible per CP string (any point in the CP string)
- Free positions in the CP string can be filled by CP modules with CPI functionality (max. 4 modules)

 **Note**

The cable length for any given string may not exceed 10 m.

Connecting cables are available in lengths of 0.25 m, 0.5 m, 2 m, 5 m and 8 m

→ 91

The maximum number of inputs and outputs that can be connected is 32 each (sum of all CP modules on a CP string), regardless of the type of CP module (with or without CPI functionality).

Order processing

There is one way of placing an order for the electrical CPI installation system:

- Digitally using the valve terminal configurator

Please note that the CP strings must be allocated in ascending numerical order, i.e. starting with string 1, followed by string 2, etc. without omitting any numbers.

To correctly allocate a CP string, proceed as follows:

- First select a connecting cable of appropriate length.
- Then select an input/output module.
- Continue in this way until the string is fully allocated (max. 4 strings for CP modules with extended functionality).







The valve terminals are configured separately:

- CPV valve terminal CPV10/14/18-VI-FB-....
→ Internet: type 10
- MPA valve terminals MPA-CPI-VI
→ Internet: type 32
- CPV-SC valve terminals CPVSC1-AE16-CPI
→ Internet: type 80
- CPA valve terminals CPA10/14-IFB-CP-....
→ Internet: type 12

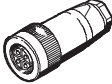
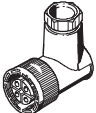
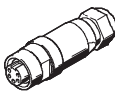
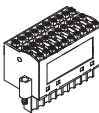
CPI installation system

Accessories

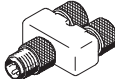





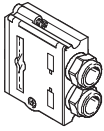

FESTO

Ordering data				
Designation			Part No.	Type
Plug connectors – Power supply				
	Power supply socket, straight, M18x1, 4-pin	for 1.5 mm ²	18493	NTSD-GD-9
		for 2.5 mm ²	18526	NTSD-GD-13,5
	Power supply socket, angled, M18x1, 4-pin	for 1.5 mm ²	18527	NTSD-WD-9
		for 2.5 mm ²	533119	NTSD-WD-11
	Power supply socket for CPX system supply	7/8" connection, 5-pin	543107	NECU-G78G5-C2
		7/8" connection, 4-pin	543108	NECU-G78G4-C2
Connection sets for power supply and sensors				
	Plug, screw-in tension-spring socket	3-row, 30-pin	197161	PS1 SAC30
	Plug, screw-in tension-spring socket with LED	3-row, 30-pin	197162	PS1-SAC31-30POL+LED
Sensor plugs				
	Plug M12, straight socket	5-pin, PG7	175487	SEA-M12-5GS-PG7
		4-pin, PG7	18666	SEA-GS-7
		4-pin, 2.5 mm ² O.D.	192008	SEA-4GS-7-2,5
	Plug M8, straight	3-pin, solderable	18696	SEA-GS-M8
		3-pin, screw-in	192009	SEA-3GS-M8-S
	Plug M12 for 2 sensor cables, PG11	4-pin	18779	SEA-GS-11-DUO
		5-pin	192010	SEA-5GS-11-DUO
	Push-in T-connector	2x socket M8, 3-pin 1x plug M8, 4-pin	544391	NEDU-M8D3-M8T4
	Push-in T-connector	2x socket M12, 5-pin 1x plug M12, 4-pin	541596	NEDU-M12D5-M12T4

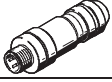
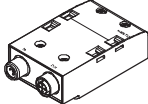
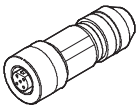
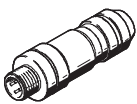
CPI installation system

Accessories

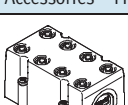

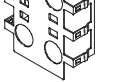

FESTO

Ordering data				
Designation			Part No.	Type
Plug connectors – Fieldbus connection				
	Sub-D plug for INTERBUS	Incoming	532218	FBS-SUB-9-BU-IB-B
		Outgoing	532217	FBS-SUB-9-GS-IB-B
	Sub-D plug for DeviceNet/CANopen		532219	FBS-SUB-9-BU-2x5POL-B
	Sub-D plug for Profibus DP		532216	FBS-SUB-9-GS-DP-B
	Sub-D plug for CC-Link		532220	FBS-SUB-9-GS-2x4POL-B
Sub-D plug		534497	FBS-SUB-9-GS-1x9POL-B	
	Bus connection M12, 5-pin, adapter (B-coded) for Profibus DP		533118	FBA-2-M12-5POL-RK
	Bus connection Micro Style 2xM12, 5-pin, for DeviceNet/CANopen		525632	FBA-2-M12-5POL
	Socket M12, 5-pin, for Micro Style connection		18324	FBSD-GD-9-5POL
	Plug M12, 5-pin, for Micro Style connection		175380	FBS-M12-5GS-PG9
	Bus connection M12x1, 4-pin (D-coded) for Ethernet		543109	NECU-M-S-D12G4-C2-ET
	Connection block M12 adapter (B-coded) for Profibus DP		541519	CPX-AB-2-M12-RK-DP
	Connection block M12 adapter (B-coded) for INTERBUS		534505	CPX-AB-2-M12-RK-IB
	Socket M12x1, 5-pin, straight, for self-assembly of a connecting cable for FBA-2-M12-5POL-RK and CPX-AB-2-M12-RK-DP		1067905	NECU-M-B12G5-C2-PB
	Plug M12x1, 5-pin, straight, for self-assembly of a connecting cable for FBA-2-M12-5POL-RK and CPX-AB-2-M12-RK-DP		1066354	NECU-M-S-B12G5-C2-PB
	Bus connection Open Style for 5-pin terminal strip for DeviceNet/CANopen		525634	FBA-1-SL-5POL
	Bus connection 5-pin terminal strip for DeviceNet/CANopen		525635	FBSD-KL-2x5POL
	Bus connection screw terminal for CC-Link		197962	FBA-1-KL-5POL
	RJ45/plug		534494	FBS-RJ45-8-GS
Accessories – Fieldbus connection				
	Cover for CPX-AB-8-KL-4POL (IP65/67) – 8 cable through-feeds M9 – 1 cable through-feed for multi-pin plug		538219	AK-8KL
	Screening plate for M12 connections		526184	CPX-AB-S-4-M12
	Earthing element for right-hand/left-hand end plates (5 pieces)		538892	CPX-EPFE-EV

CPI installation system

Accessories

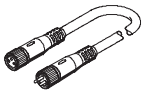
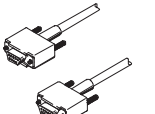
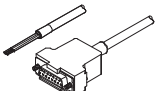
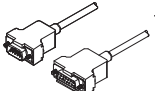
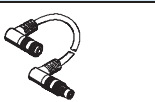





FESTO

Ordering data				
Designation			Part No.	Type
Connecting cables				
	DUO cable M12-2xM8, 4-pin/2x3-pin	2x straight socket	18685	KM12-DUO-M8-GDGD
		2x straight/angled socket	18688	KM12-DUO-M8-GDWD
		2x angled socket	18687	KM12-DUO-M8-WDWD
	Connecting cable M8-M8, straight plug-straight socket	0.5 m	175488	KM8-M8-GSGD-0,5
		1.0 m	175489	KM8-M8-GSGD-1
		2.5 m	165610	KM8-M8-GSGD-2,5
		5.0 m	165611	KM8-M8-GSGD-5
	Extension cable M12-M12, 5-pin, straight plug-straight socket	1.5 m	529044	KV-M12-M12-1,5
		3.5 m	530901	KV-M12-M12-3,5
Connecting cable M12-M12, 4-pin, straight plug-straight socket	2.5 m	18684	KM12-M12-GSGD-2,5	
	5.0 m	18686	KM12-M12-GSGD-5	
	Connecting cable M12-M12, 4-pin, straight plug-angled socket	1.0 m	185499	KM12-M12-GSWD-1-4
	Modular system for connecting cables		–	NEBU... → Internet: nebu
	Programming cable		151915	KDI-PPA-3-BU9
	Connecting cable FED, pre-assembled at one end		539642	FEC-KBG7
	Connecting cable FED, pre-assembled at both ends		539643	FEC-KBG8
Connecting cable – CP modules				
	Connecting cable WS-WD, angled plug-angled socket	0.25 m	540327	KVI-CP-3-WS-WD-0,25
		0.5 m	540328	KVI-CP-3-WS-WD-0,5
		2 m	540329	KVI-CP-3-WS-WD-2
		5 m	540330	KVI-CP-3-WS-WD-5
		8 m	540331	KVI-CP-3-WS-WD-8
	Connecting cable GS-GD, straight plug-straight socket	2 m	540332	KVI-CP-3-GS-GD-2
		5 m	540333	KVI-CP-3-GS-GD-5
		8 m	540334	KVI-CP-3-GS-GD-8
	Connector plug for CP cable (control cabinet implementation)		543252	KVI-CP-3-SSD

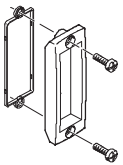
CPI installation system

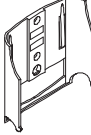
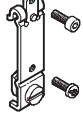
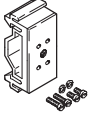
Accessories

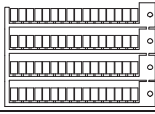
FESTO

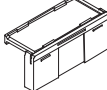
Ordering data			
Designation		Part No.	Type
Protective caps			
	Inspection cover, transparent	533334	AK-SUB-9/15-B
	Cover for RJ45 connection	534496	AK-Rj45
	Protective cap for sealing unused sockets (10 pieces)	for M8 connections	177672 ISK-M8
		M9	356684 FLANSCHDOSE SER.712
		for M12 connections	165592 ISK-M12
Mounting attachments			
	Retainer CPX-MMI	534705	CPX-MMI-1-H
	Mounting for H-rail, CPX-MMI	536689	CPX-MMI-1-NRH
	Mounting for H-rail, CP modules	170169	CP-TS-HS35
	Mounting for H-rail	18649	IBGH-03-4,0
Inscription labels			
	Inscription labels 6x10 mm in frames (64 pieces)	18576	IBS-6x10
	Inscription labels 8x20 mm in frames (20 pieces) for compact modules (CP-...-CL)	539388	IBS-8x20
	Inscription label holders for EL modules, bag of 10	547473	ASCF-H-E2

CPI installation system

Accessories

FESTO

Ordering data – Documentation				
Designation	Part No.	Type		
	User documentation for bus node CPX-FB6	German	526433	P.BE-CPX-FB6-DE
		English	526434	P.BE-CPX-FB6-EN
		Spanish	526435	P.BE-CPX-FB6-ES
		French	526436	P.BE-CPX-FB6-FR
		Italian	526437	P.BE-CPX-FB6-IT
		Swedish	526438	P.BE-CPX-FB6-SV
	User documentation for bus node CPX-FB11	German	526421	P.BE-CPX-FB11-DE
		English	526422	P.BE-CPX-FB11-EN
		Spanish	526423	P.BE-CPX-FB11-ES
		French	526424	P.BE-CPX-FB11-FR
		Italian	526425	P.BE-CPX-FB11-IT
		Swedish	526426	P.BE-CPX-FB11-SV
	User documentation for bus node CPX-FB13	German	526427	P.BE-CPX-FB13-DE
		English	526428	P.BE-CPX-FB13-EN
		Spanish	526429	P.BE-CPX-FB13-ES
		French	526430	P.BE-CPX-FB13-FR
		Italian	526431	P.BE-CPX-FB13-IT
		Swedish	526432	P.BE-CPX-FB13-SV
	User documentation for bus node CPX-FB14	German	526409	P.BE-CPX-FB14-DE
		English	526410	P.BE-CPX-FB14-EN
		Spanish	526411	P.BE-CPX-FB14-ES
		French	526412	P.BE-CPX-FB14-FR
		Italian	526413	P.BE-CPX-FB14-IT
		Swedish	526414	P.BE-CPX-FB14-SV
	User documentation for bus node CPX-FB23	German	526403	P.BE-CPX-FB23-DE
		English	526404	P.BE-CPX-FB23-EN
	User documentation for bus node CPX-FB32	German	693134	P.BE-CPX-FB32-DE
	English	693135	P.BE-CPX-FB32-EN	
	Spanish	693136	P.BE-CPX-FB32-ES	
	French	693137	P.BE-CPX-FB32-FR	
	Italian	693138	P.BE-CPX-FB32-IT	
	Swedish	693139	P.BE-CPX-FB32-SV	
User documentation for bus node CPX-FB33	German	548759	P.BE-CPX-PNIO-DE	
	English	548760	P.BE-CPX-PNIO-EN	
	Spanish	548761	P.BE-CPX-PNIO-ES	
	French	548762	P.BE-CPX-PNIO-FR	
	Italian	548763	P.BE-CPX-PNIO-IT	
	Swedish	548764	P.BE-CPX-PNIO-SV	
User documentation for control block CPX-FEC	German	538474	P.BE-CPX-FEC-DE	
	English	538475	P.BE-CPX-FEC-EN	
	Spanish	538476	P.BE-CPX-FEC-ES	
	French	538477	P.BE-CPX-FEC-FR	
	Italian	538478	P.BE-CPX-FEC-IT	
	Swedish	538479	P.BE-CPX-FEC-SV	

CPI installation system

Accessories

FESTO

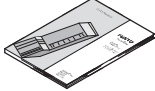
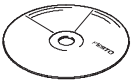
Ordering data – Documentation				
Designation			Part No.	Type
	User documentation for CPX CP interface	German	539293	P.BE-CPX-CP-DE
		English	539294	P.BE-CPX-CP-EN
		Spanish	539295	P.BE-CPX-CP-ES
		French	539296	P.BE-CPX-CP-FR
		Italian	539297	P.BE-CPX-CP-IT
		Swedish	539298	P.BE-CPX-CP-SV
	User manual for operator unit CPX-MMI-1	German	534824	P.BE-CPX-MMI-1-DE
		English	534825	P.BE-CPX-MMI-1-EN
		French	534827	P.BE-CPX-MMI-1-FR
		Italian	534828	P.BE-CPX-MMI-1-IT
		Swedish	534829	P.BE-CPX-MMI-1-SV
		Spanish	534826	P.BE-CPX-MMI-1-ES
	User documentation for sturdy input/output modules	German	165125	P.BE.-CPEA-DE
		English	165225	P.BE.-CPEA-EN
		French	165127	P.BE.-CPEA-FR
		Italian	165157	P.BE.-CPEA-IT
		Spanish	165227	P.BE.-CPEA-ES
		Swedish	165257	P.BE.-CPEA-SV
	User documentation for compact input/output modules	German	539299	P.BE.-CPEA-CL-DE
		English	539300	P.BE.-CPEA-CL-EN
		French	539302	P.BE.-CPEA-CL-FR
		Italian	539303	P.BE.-CPEA-CL-IT
		Spanish	539301	P.BE.-CPEA-CL-ES
		Swedish	539304	P.BE.-CPEA-CL-SV
	System description	German	165126	P.BE-CPSYS-DE
		English	165226	P.BE-CPSYS-EN
		French	165128	P.BE-CPSYS-FR
		Italian	165158	P.BE-CPSYS-IT
Spanish		165228	P.BE-CPSYS-ES	
Swedish		165258	P.BE-CPSYS-SV	
Software				
	Programming software	German	537927	FST4.1DE
		English	537928	FST4.1GB