

**Checkbox Compact, CHB-C-N**



# Checkbox Compact, CHB-C-N

Key features

FESTO

## The new Checkbox Compact

Camera-based sorting, inspecting and counting of assembly components

The Checkbox Compact CHB-C-N is an intelligent system with adaptive workpiece flow control and optical workpiece identification. It sorts small parts according to type, position orientation, quality as well as quantity (with quantity preselection).

It is particularly suitable for trouble-free feeding of small parts to automatic assembly and production machines, especially in cases with high volumes of workpieces and a large number of workpiece types.

The Checkbox Compact enables reliable rejection of faulty parts, prevents assembly of incorrect types and reduces setup times to a minimum.

## Compact versatility

Camera technology and control of parts flow integrated into field-tested unit

The CHB-C-N consists of a sturdy aluminium housing with all the necessary components.

- User interface (buttons, LEDs, display)
- Connectors for the electrical connection of actuators, buffer zone sensors, diagnostics PC, power supply, encoder and master PLC
- Line scan technology (light, fibre-optic cable, line-scan camera)

The workpieces are scanned in the optical channel between the two prisms on the underside of the device. The optics are designed to be open on the underside, allowing the CHB-C-N to be installed above various types of customer transport equipment (e.g. a conveyor belt).

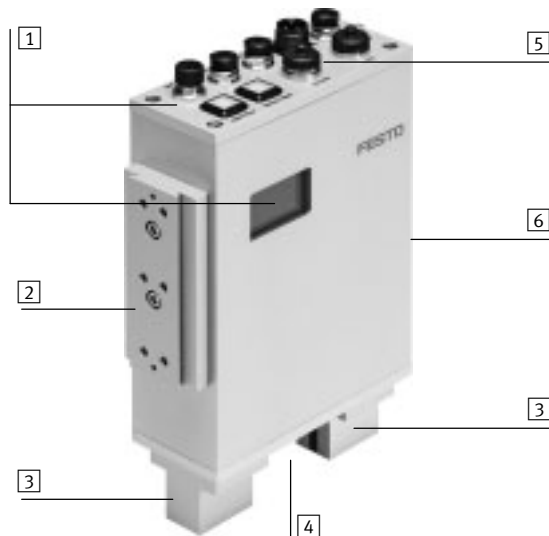

The Checkbox Compact CHB-C-N provides 24 V DC high-power signals at its outputs, which can be used to directly actuate quick-switching pneumatic valves, for example the MHE2-MS1H-, without using external interface assemblies or controllers, in order to reliably filter faulty or incorrectly oriented parts out of the parts flow using an air jet. Other types of actuators such as pneumatic or electrical ejectors, deflectors or turning stations can also be controlled.

By integrating additional sensors (inductive, capacitive, optical, colour sensors) additional quality characteristics can be checked, or vision sensors or vision systems can be connected to integrate further complex workpiece inspections into the sorting process. The function range is completed by inputs for encoders for belt speed monitoring and buffer zone sensors and an output for controlling the conveying device.

### 1 User interface front panel:

- Keys
  - LEDs
- Housing side:
- Display

### 2 Mounting component

- Mounting profile matches connecting kit HMSV-12 (accessories)
  - 6 threaded holes M5, screw-in depth 12 mm
  - Holes for dowel pins 3 mm (ISO 2338, 3m6)
- Mounting profile can also be mounted on the opposite side

### 3 Prisms

### 4 Optical channel

### 5 Electrical connections

- Power supply
- Ethernet interface
- Actuators
- Buffer sensor/small parts conveyor
- Higher-order PLC
- Encoder

### 6 Mounting thread for

- Mounting profile with dovetail guide
  - Direct mounting with thread M5, max. screw-in depth 6 mm, drill holes for dowel pins 3 mm (ISO 2338, 3m6)
- Identical mounting pattern on the opposite side

# Checkbox Compact, CHB-C-N

Key features

## Operational principle

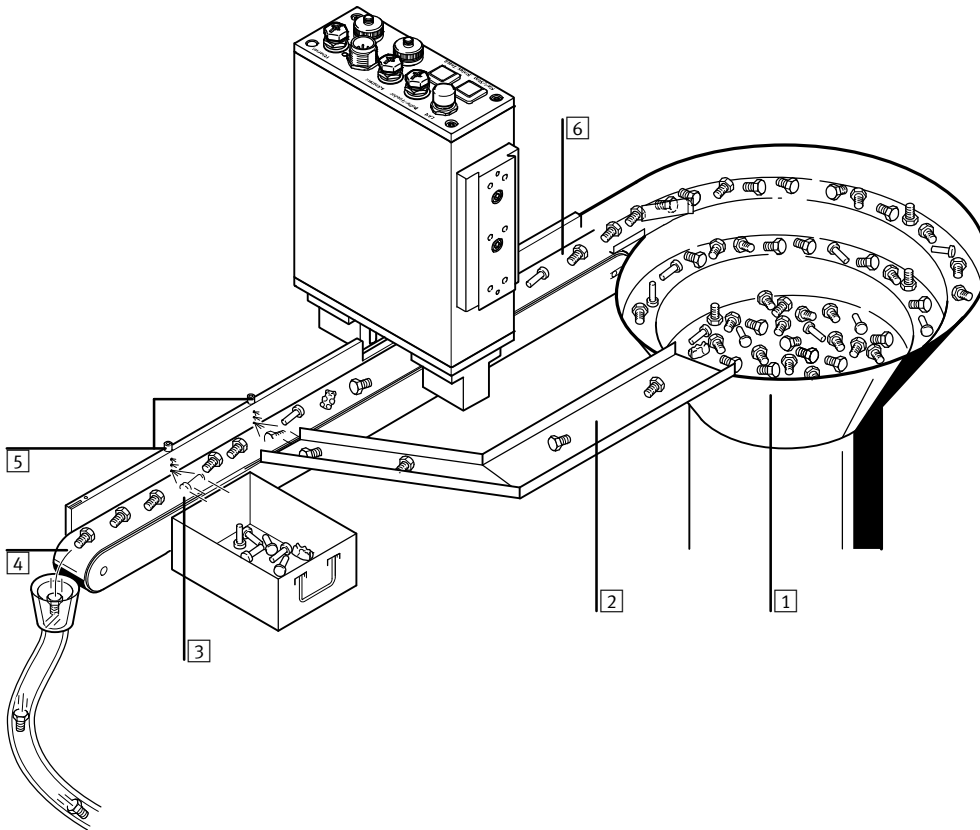

### Integration of the Checkbox in a transportation device: Example with conveyor belt and two actuators

1	Small parts conveyor e.g.: vibratory bowl feeder, centrifuge feeder, step feeder
2	Return of incorrectly orientated parts to the small parts conveyor
3	Ejecting bad parts (faulty parts, wrong part type)
4	Onward transfer of good parts to a buffer zone or the next machine
5	Actuators e.g.: blow-off valves, pushers or turning stations
6	Transportation device e.g. conveyor belt

The parts to be checked are passed through the optical channel of the Checkbox by a transportation device.

The Checkbox sorts the parts on the basis of the contour data into:

- Good part, correctly oriented: the checked part is conveyed to the end of the transportation device and passed to the next station
- Good part, incorrectly oriented: the checked part is filtered out, e.g. at the first actuator position, and returned to the conveying system or rotated to the correct orientation at a turning a rollover station. Filtering out can be carried out by a pulse of air, for example
- Bad part or incorrect type: the checked part is filtered out, e.g. at the second actuator position

The part contour is scanned using the transmitted-light method as it passes through the “optical channel”.

Compared to detection using an area scan camera, image detection with the scanning method used by the Checkbox (line-scan system) has significant advantages. For example, any combination of parts can be detected and processed without the need to maintain minimum distances, and considerably longer objects (up to > 1000 mm) can also be detected and processed

# Checkbox Compact, CHB-C-N

Key features

FESTO

## Which parts are suitable?

In principle, all workpieces that can be transported in a stable position and the quality and position orientation of which can be detected in a camera image using contour features.

Colour or material properties can also be included in the inspection by using additional sensors.

## Selection from the variety of parts from A to Z:

- Axes
- Applicators
- Batteries
- Fittings
- Mounting components
- Drills
- Pins
- Brushes
- Clips
- Dental drills
- Sealing rings
- Swivel parts
- Dowel pins
- Inserts
- Bicycle parts
- Fixtures
- Springs
- Spring washers
- Bottle tops
- Filter elements
- Threaded pins
- Threaded sleeves
- Glass ampoules
- Glass vials
- Buckles
- Wooden dowel
- Sleeves
- Hygiene products
- Hydraulic elements
- Installation parts
- Cannulae
- Ceramic seals
- Chain links
- Buttons
- Cosmetic items
- Ballpoint pen parts
- Plastic vials
- Haberdashery items
- Bearings
- Fibre-optic cables
- Lipstick casings
- Insulating terminals
- Motor parts
- Nuts
- Needles
- Nails
- Nail magazines
- Rivets
- Camshaft components
- O-rings
- Plastic housings
- Piercing parts
- Wheel bolts
- Zipper components
- Switch contacts
- Windscreen wiper parts
- Screws
- Writing utensils
- Sensor housing
- Fuses
- Game pieces
- Spikes
- Syringes and their parts
- Spray heads
- Stamping parts
- Plug connectors
- Pins
- Pen tops
- Tablets
- Washers
- Valve springs
- Valve guides and seat rings
- Shafts
- Corrugated tubes
- Toothbrush components
- Ignition parts

## What parts rates and speeds can be achieved?

Depending on the length of the parts, parts rates of over 1500 per minute can be achieved, with transportation speeds for the parts of more than 60 metres per minute.

## In which sectors is the Checkbox CHB-C-N used?

- Automotive
- Clothing
- Dental technology
- Electrical engineering and electronics
- Precision mechanics
- Electroplating
- Woodworking industry
- Cosmetics
- Metal working
- Furniture industry
- Pharmaceutical industry
- Optical industry
- Polymers
- Toys and games
- Grinding technology
- Tools
- Packaging technology

# Checkbox Compact, CHB-C-N

Key features

## What does the camera see?

Inspection part  
Insulating terminal insert



Camera image  
Insulating terminal insert

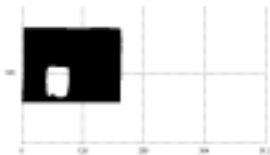

Inspection part  
Valve spring



Camera image  
Valve spring

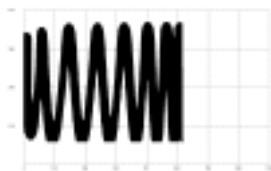

Inspection part  
Glass ampoule



Camera image  
Glass ampoule



Inspection part  
Glow plug



Camera image  
Glow plug



Inspection part  
Check valve



Camera image  
Check valve



Inspection part  
Refill tip



Camera image  
Refill tip



# Checkbox Compact, CHB-C-N

Peripherals overview

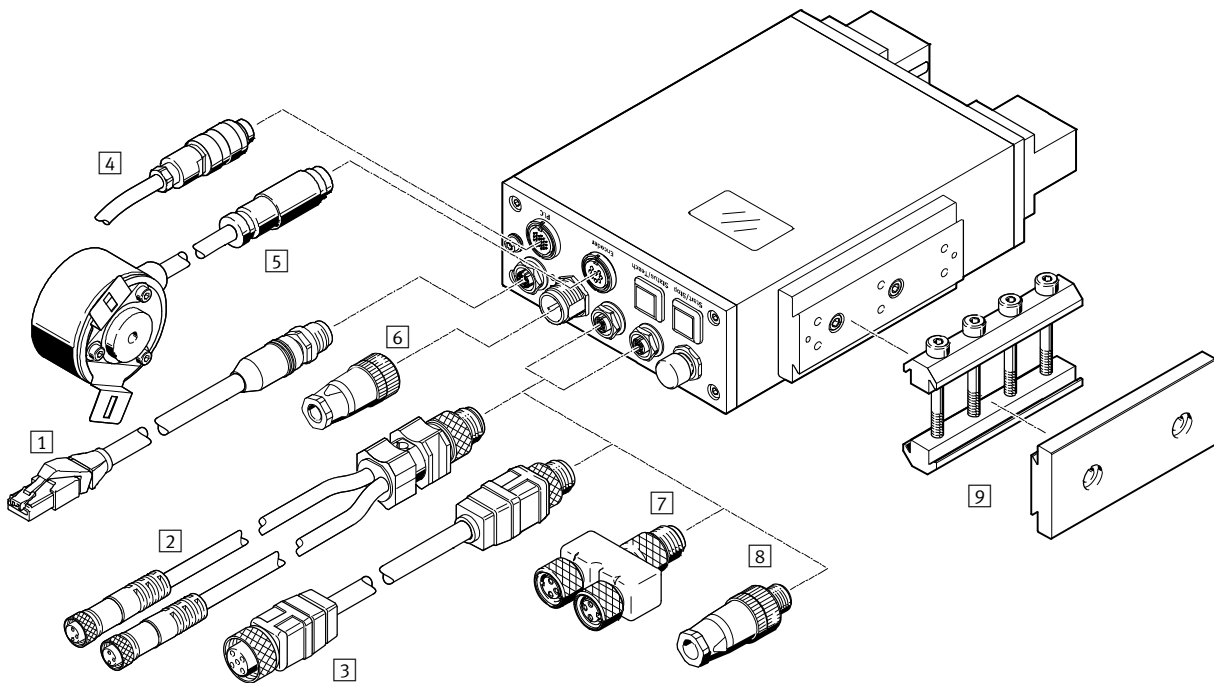

Mounting components and accessories		→ Page/Internet
1	Connecting cable NEBC-D12G4-ES-...	13
2	Duo cable NEDY-...	13
3	Connecting cable NEBU-...	13
4	Connecting cable NEBS-...	13
5	Encoder TU-30/80-EC-L/R	12
6	Plug socket NTSD-GD	12
7	T-plug connector NEDY-M12G4	12
8	Plug connector NECU-S-M12G4	12
9	Adapter kit HMSV-12	12
-	Software	11

# Checkbox Compact, CHB-C-N

Technical data

FESTO

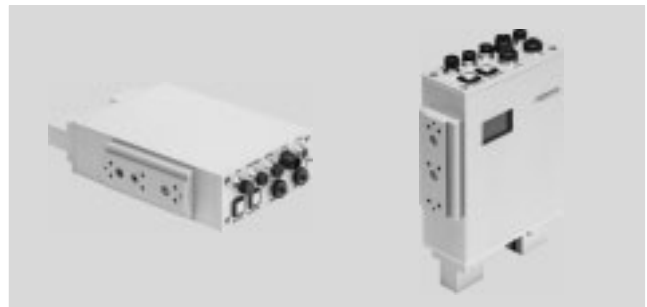

## General technical data

Type of mounting		Via dovetail slot
		Via female thread
		Via accessories
Dimensions W x L x H	[mm]	60 x 164 x 256.9
Dimensions of optical channel W x H	[mm]	59.2 x 40
Product weight	[g]	2325

## Electronics

Sensor resolution		2048 pixels/line
Pixel size	[mm]	0.014
Sensor type		CMOS line scan
Max. line frequency, sensor	[Hz]	8500
Max. no. of inspection programs		256
Max. no. of types per inspection program		1
Max. no. of different orientations per memorised type		8
Counting function		Yes
Counting range		1 ... 9999999
Quantity preselection		Using CheckOpti software
Min. part length	[mm]	1
Max. part length		Depends on belt speed and resolution required
Min. part diameter	[mm]	0.5
Max. part diameter	[mm]	25
Nominal DC operating voltage	[V]	24
Permissible voltage fluctuations	[%]	-15 ... +20
Current consumption with load-free outputs	[mA]	400
Internal fuse protection		4 A fuse
Max. starting current per output channel	[A]	1.3
Electronic limitation of outputs	[mA]	700

## Power supply interface

Connection type		Plug
Connection technology		M 18x1
Number of pins, wires		4
Max. residual current	[A]	3.0

# Checkbox Compact, CHB-C-N

Technical data

Actuator interface	
Connection type	Socket
Connection technology	M12x1, A-coded to EN 61076-2-101
Number of pins, wires	5
Max. residual current [A]	1.9

Buffer/feeder interface	
Connection type	Socket
Connection technology	M12x1, A-coded to EN 61076-2-101
Number of pins/wires	5
Max. residual current [A]	1.9

PLC interface	
Connection type	Socket
Connection technology	M16x0.75
Number of pins, wires	24
Max. residual current [A]	0.9
Outputs	<ul style="list-style-type: none"> <li>Good part and correctly oriented</li> <li>Good part but incorrectly oriented</li> <li>Faulty part</li> <li>Conveyor control</li> <li>Transport system controller/ready for operation</li> <li>Status signal "Warning"</li> <li>Error output</li> <li>Nominal number reached</li> <li>PLC power supply</li> </ul>
Inputs	<ul style="list-style-type: none"> <li>Buffer sensor 1</li> <li>Buffer sensor 2/Inspection program bit 2</li> <li>External error</li> <li>Start new counting cycle</li> <li>External start/stop</li> <li>Ext. sensor/inspection program bit 3</li> <li>Key lock</li> <li>Check program bit 0</li> <li>Check program bit 1</li> </ul>
Input characteristic curve	To IEC 61131-2, type 1

Ethernet interface	
Connection type	Socket
Connection technology	M12x1, D-coded to EN 61076-2-101
Number of pins, wires	4
Protocol	TCP/IP
Transmission rate [Mbit/s]	10/100
Function	<ul style="list-style-type: none"> <li>Diagnostics</li> <li>Programming</li> </ul>



# Checkbox Compact, CHB-C-N

Technical data

Encoder interface	
Connection type	Socket
Connection technology	M16x0.75
Number of pins, wires	8
Protocol	RS485

Fieldbus interface	
Note	Not connected
Protocol	CAN, not supported

Immissions/emissions		
Ambient temperature	[°C]	-5 ... +45
Storage temperature	[°C]	-20 ... +70
Degree of protection		IP64
Certification		RCM mark
CE marking (see declaration of conformity)		To EU EMC Directive
Ambient conditions		Screened from extreme external light sources
		Cleanest possible ambient air
		Dry
Photobiological safety		Risk group 1 (low risk) to DIN EN 62471:2009-03
Vibration resistance		Transport application test with severity level 2 to FN 942017-4 and EN 60068-2-6
Shock resistance		Shock test with severity level 2 to FN 942017-5 and EN 60068-2-27
Protection against direct and indirect contact		PELV
Corrosion resistance class CRC <sup>1)</sup>		2

1) Corrosion resistance class CRC 2 to Festo standard 940070  
Moderate corrosion stress. Internal applications in which condensation may occur. External visible parts with primarily decorative surface requirements which are in direct contact with a normal industrial environment.

Materials	
Housing	Wrought aluminium alloy
End cap	Wrought aluminium alloy
Note on materials	RoHS-compliant

# Checkbox Compact, CHB-C-N

Technical data



## Dimensions

Download CAD data → [www.festo.com](http://www.festo.com)

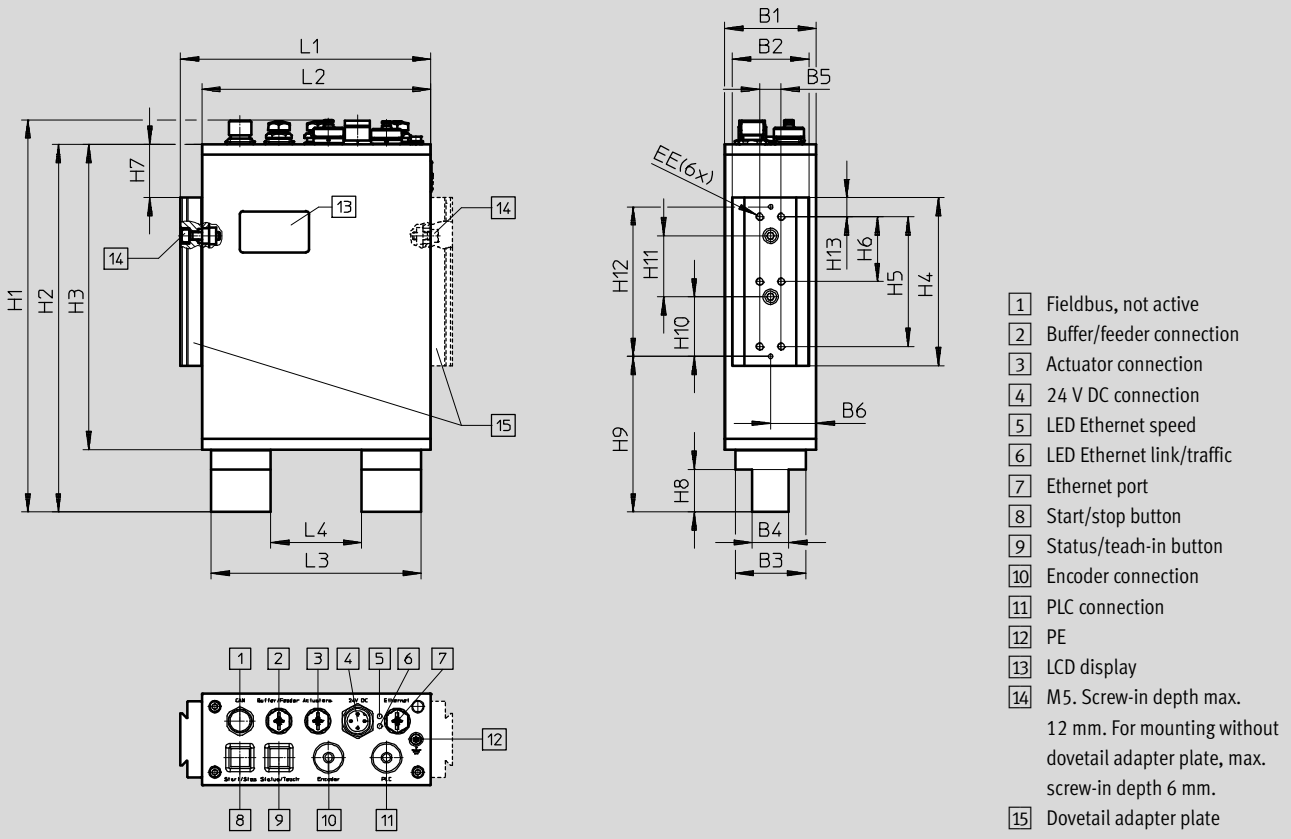

Type	L1	L2	L3	L4	H1	H2	H3	H4	H5	H6	H7	H8
CHB-C-N	164	150	137.4	59.4	256.9	241	200	110	85	42.5	35	28

Type	H9	H10	H11	H12	H13	EE	B1	B2	B3	B4	B5	B6
CHB-C-N	102	39	40	98	12.5	M5	60	50	46	24	14	30

## Ordering data

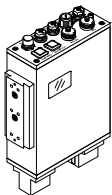
Description	Part No.	Type
 Checkbox CHB-C-N	<b>3501040</b>	<b>CHB-C-N</b>

# Checkbox Compact, CHB-C-N

Features and accessories

## Software to meet individual requirements

### CheckKon

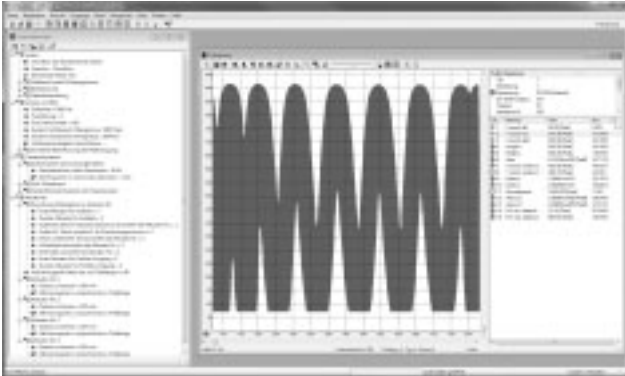

### Performance characteristics

This software allows you to display, record and adjust the processes within the Checkbox CHB-C-N, from evaluation of the camera images through to the I/O parameters.

This includes:

- System configuration with display and modification of parameters and operating modes
- System diagnostics and error analysis
- Display and recording of inspection part images and inspection results
- Filing and documentation of system settings
- Inspection program management
- Statistical evaluation of inspection results

### CheckOpti

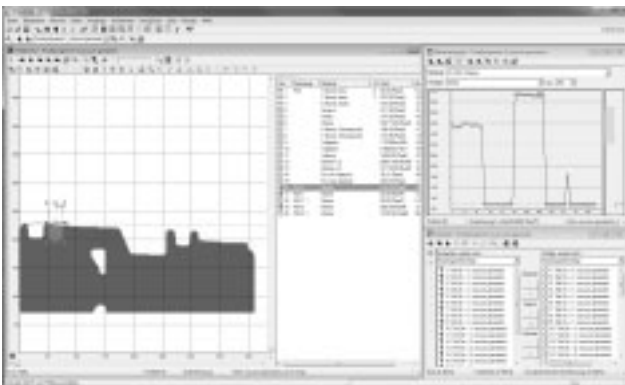

### Software program

“CheckOpti” is used if the standard learning process of the Checkbox CHB-C-N reaches its limits due to the differences in contours being too small, i.e. if the orientation and quality detection for an inspection part is not reliably guaranteed.

If necessary, additional, effective inspection characteristics can be defined so that the system is optimised for the particular application.

CheckOpti is also used for:

- Setting the default values for the counter function
- Filing and documentation of the inspection programs

Further product information → [www.festo.com](http://www.festo.com)

Engineering software	Technical data → Internet: <a href="http://www.festo.com/sp">www.festo.com/sp</a>
Description	Language
Software CheckKon	German, English
Software CheckOpti	German, English





Operating instructions		
	Part No.	Type
German	8046181	GDCA-CHB-C-N-DE
English	8046182	GDCA-CHB-C-N-EN

# Checkbox Compact, CHB-C-N

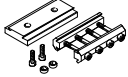
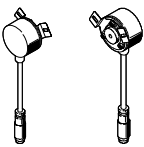
Accessories

**FESTO**



Ordering data – Accessories				
	Description	Part No.	Type	
Adapter kit <span style="float: right;">Technical data → Internet: hmsv-12</span>				
	With screw-on adapter plate	<b>177658</b>	<b>HMSV-12</b>	
Encoder				
	Encoder, cable length 2 m	<b>540140</b>	<b>TU-30/80-EC-L/R</b>	

Ordering data				
	Description	Connection cross section [mm <sup>2</sup> ]	Part No.	Type
Plug socket <span style="float: right;">Technical data → Internet: ntsd</span>				
	Straight socket, 4-pin, screw terminal	1.5	<b>18493</b>	<b>NTSD-GD-9</b>
		2.5	<b>18526</b>	<b>NTSD-GD-13,5</b>
Plug connectors <span style="float: right;">Technical data → Internet: sea, necu</span>				
	Straight plug, M12x1, 4-pin, type A, screw terminal	0.14 ... 0.5	<b>192008</b>	<b>SEA-4-GS-7-2,5</b>
		0.75	<b>18666</b>	<b>SEA-GS-7</b>
		0.75	<b>18779</b>	<b>SEA-GS-11-DUO</b>
	Straight plug, M12x1, 4-pin, type A, screw terminal	0.14 ... 0.5	<b>570955</b>	<b>NECU-S-M12G4-P1-Q6-IS</b>
	Straight plug, M12x1, 4-pin, type A, screw terminal for intrinsically safe circuits	0.75	<b>570953</b>	<b>NECU-S-M12G4-P1-IS</b>
	Straight plug, M12x1, 4-pin, type A, screw terminal for intrinsically safe circuits	0.75	<b>570956</b>	<b>NECU-S-M12G4-D-IS</b>
Distributor without cable <span style="float: right;">Technical data → Internet: nedy</span>				
	Straight plug M12x1 to 2x socket M12x1 5-pin	-	<b>8005310</b>	<b>NEDY-L2R1-V1-M12G5-N-M12G4</b>
	Straight plug M12x1 to 2x socket M8x1 3-pin		<b>8005311</b>	<b>NEDY-L2R1-V1-M8G3-N-M12G4</b>

# Checkbox Compact, CHB-C-N

Accessories

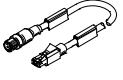
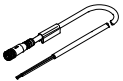
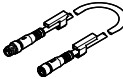
**FESTO**

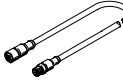
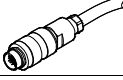
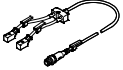
Ordering data					
	Electrical connection 1	Electrical connection 2	Cable length [m]	Part No.	Type
Connecting cable NEBC <span style="float: right;">Technical data → Internet: nebc</span>					
	M12x1, 4-pin plug, straight, D-coded	Straight plug, RJ45, 4-pin	1	<b>8040451</b>	<b>NEBC-D12G4-ES-1-S-R3G4-ET</b>
			3	<b>8040452</b>	<b>NEBC-D12G4-ES-3-S-R3G4-ET</b>
			5	<b>8040453</b>	<b>NEBC-D12G4-ES-5-S-R3G4-ET</b>
			10	<b>8040454</b>	<b>NEBC-D12G4-ES-10-S-R3G4-ET</b>
Connecting cable NEBU <span style="float: right;">Technical data → Internet: nebu</span>					
	Modular system for connecting cables		0.1 ... 30	<b>539052</b>	<b>NEBU-</b> → Internet: nebu
	Socket, 5-pin, M12 – straight plug, 4-pin, M12		0.5	<b>8000208</b>	<b>NEBU-M12G5-K-0,5-M12G4</b>
	Socket, 5-pin, M12 – angled plug, 5-pin, M12		2	<b>8003618</b>	<b>NEBU-M12G5-K-2-M12W5</b>
	Socket, 5-pin, M12 – straight plug, 5-pin, M12 Suitable for chain link trunking		5	<b>574321</b>	<b>NEBU-M12G5-E-5-Q8N-M12G5</b>
Connecting cable, NEBV <span style="float: right;">Technical data → Internet: nebv</span>					
	Straight socket, 8-pin – straight plug, 4-pin		2	<b>553575</b>	<b>NEBV-M12G8-K-2-M12G4</b>
			5	<b>553576</b>	<b>NEBV-M12G8-K-5-M12G4</b>
Connecting cable, NEBS <span style="float: right;">Technical data → Internet: nebs</span>					
	M16x0,75, straight plug, cable, open end		5	<b>8048653</b>	<b>NEBS-SM16G24-K-5-N-LE24</b>
			10	<b>8048654</b>	<b>NEBS-SM16G24-K-10-N-LE24</b>
Distributor 2 to 1 <span style="float: right;">Technical data → Internet: nedy</span>					
	Modular system for distributor 2 to 1		0.3 ... 30	<b>8032867</b>	<b>NEDY-...</b> → Internet: nedy

# Checkbox Compact, CHB-C-N

Application examples

FESTO

## Application examples

### Position and quality inspection of electrodes

The Checkbox CHB-C-N inspects the electrodes and controls the entire feed process, e.g. a subsequent turning station for rotating incorrectly oriented good parts and a blow-off nozzle for filtering out bad parts.

The following features are checked:

- Orientation
- Diameter
- Length
- Shape

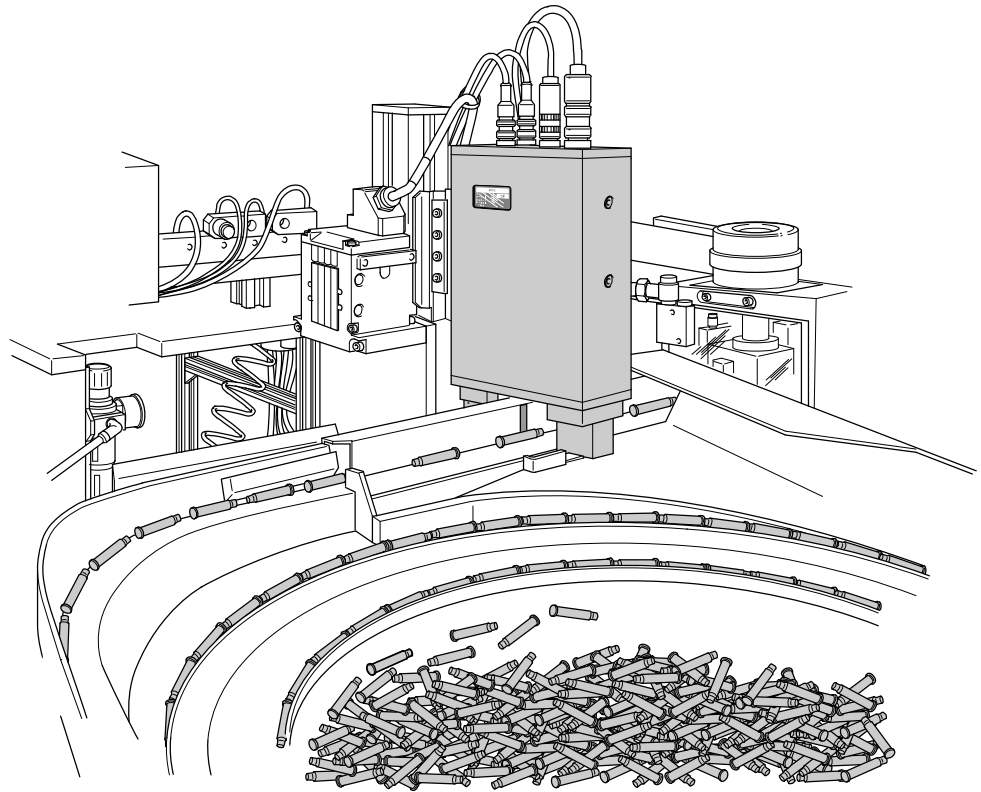

### Position and quality inspection of fibre-optic cables

The Checkbox CHB-C-N inspects the transparent display components, controls the parts flow and removes incorrectly oriented or faulty parts reliably with the use of blow-off nozzles.

The following features are checked:

- Orientation
- Shape
- Diameter
- Trapped air

