

Short-stroke cylinders ADNE-LAS, with linear motor



Short-stroke cylinders ADNE-LAS, with linear motor

Key features



At a glance		
Properties		Range of applications
<ul style="list-style-type: none"> • Electric short-stroke cylinder with integrated linear motor, specifically designed for dynamic movements between two end positions • A cycle of advancing and retracing motion over 15 mm can be achieved in 64 ms (movement frequency of up to 13.6 Hz) 	<ul style="list-style-type: none"> • Festo plug & work: connect, switch on, teach-in end positions and then the system is ready to use. There is no need to set servo parameters • Mechanical interfaces are largely compatible with the pneumatic compact cylinder ADN 	<ul style="list-style-type: none"> • Electronic end-position cushioning, i.e. constant force across the entire stroke with the force only reduced at the end positions as end-position cushioning • No external magnetic fields
		<ul style="list-style-type: none"> • Dynamic movement with secondary accuracy requirements: <ul style="list-style-type: none"> – Switching deflectors – Rejecting good/bad parts from an ongoing production process – Blocking movements – Checking switches – Applying labels

Everything from a single source

Short-stroke cylinder ADNE-LAS

→ 3



End-position controller CMFL

→ Internet: cmfl

- Short-stroke cylinder ADNE-LAS
- End-position controller CMFL
- Motor cable NEBM
- Power supply cable KPWR
- Pilot line KES

The short-stroke cylinder ADNE-LAS and the end-position controller CMFL form one unit. Only one cable is required between the short-stroke cylinder and end-position controller.

Movement pattern

Four movement patterns can be selected via inputs.

- | | |
|--|--|
| 1. Advancing | |
| 2. Retracting | |
| 3. Advancing and then retracting again | |
| 4. Retracting and then advancing again | |

Short-stroke cylinders ADNE-LAS, with linear motor

Type codes

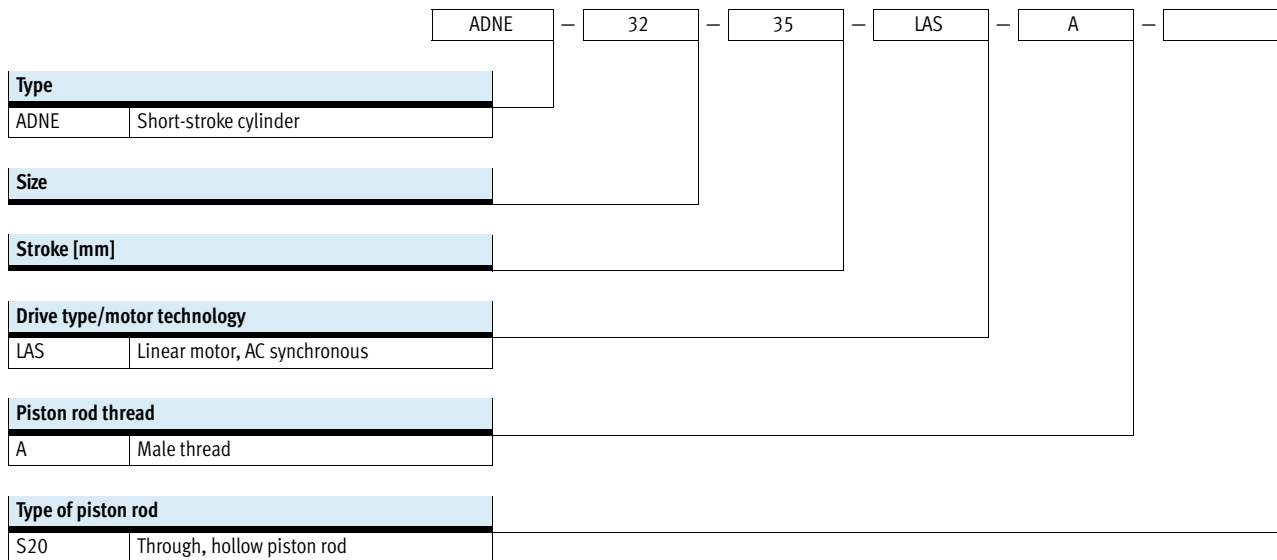

Short-stroke cylinders ADNE-LAS, with linear motor

Peripherals overview

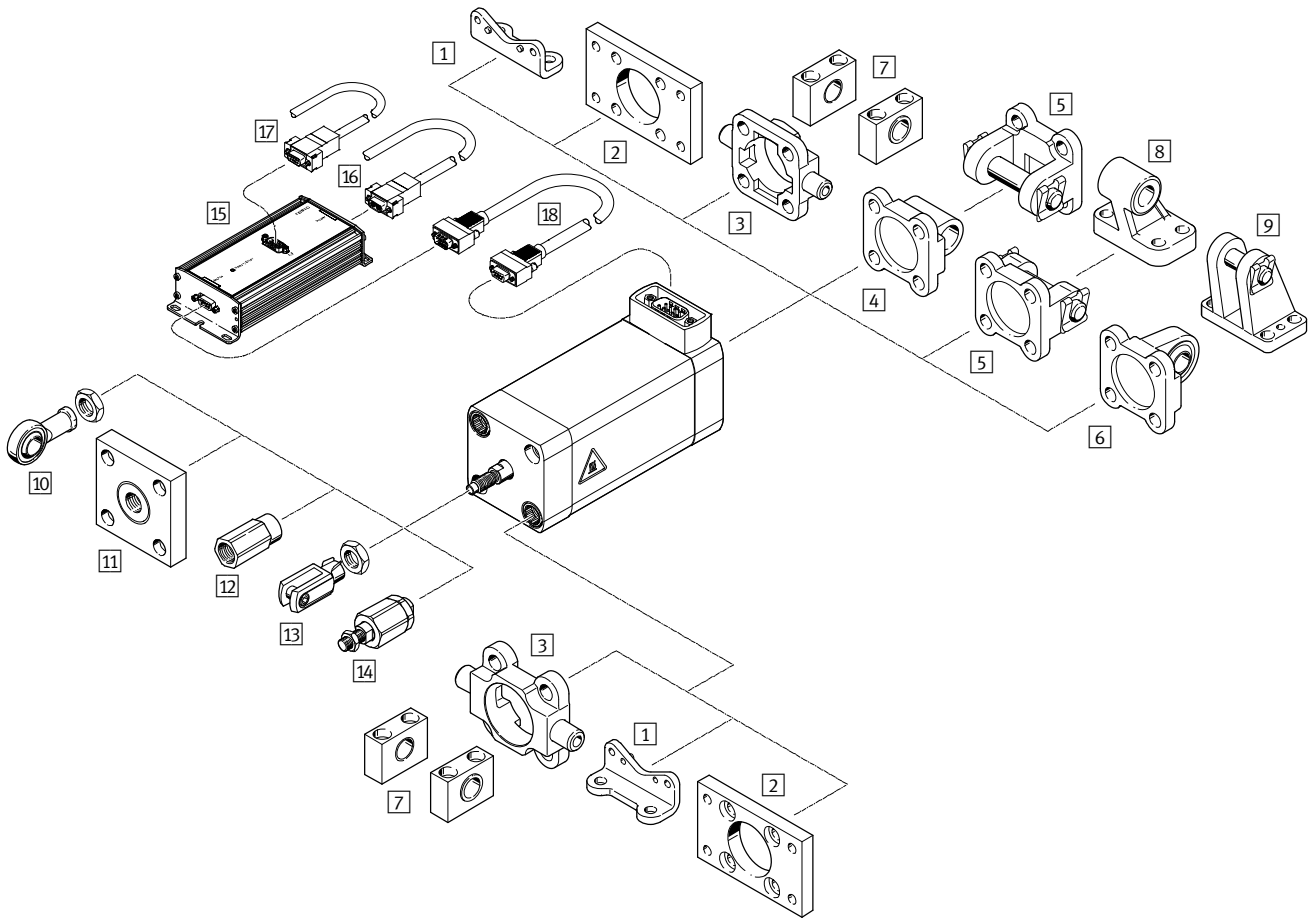

Short-stroke cylinders ADNE-LAS, with linear motor

Peripherals overview

Mounting attachments and accessories					
	Brief description	Variant		→ Page/Internet	
		Basic version	S20		
1	Foot mounting HNA	For bearing or end caps	■	■	15
2	Flange mounting FNC	For bearing or end caps	■	■	15
3	Trunnion flange ZNCF	For bearing or end caps	■	■	17
4	Swivel flange SNCL	For end caps	■	–	16
5	Swivel flange SNCB	For end caps	■	–	16
6	Swivel flange SNCS	For end caps, with spherical bearing	■	–	17
7	Trunnion support LNZG	In combination with trunnion flange ZNCF	■	■	18
8	Clevis foot LNG	In combination with swivel flange SNCB	■	–	18
9	Clevis foot LBG	In combination with swivel flange SNCS	■	–	18
10	Rod eye SGS	With spherical bearing	■	■	18
11	Coupling piece KSZ	Compensates radial misalignments up to ±1 mm	■	■	18
12	Adapter AD	Specially for through, hollow piston rods, for example for connecting vacuum generators	■	■	18
13	Rod clevis SG	–	■	■	18
14	Self-aligning rod coupler FK	Compensates radial and angular misalignments	■	■	18
15	End-position controller CMFL	For parameterising and positioning the short-stroke cylinder	■	■	cmfl
16	Power supply cable KPWR	For connecting the load and logic supply	■	■	cmfl
17	Pilot line KES	For I/O interface to any controller	■	■	cmfl
18	Motor cable NEBM	For connecting the motor and end-position controller	■	■	cmfl

Short-stroke cylinders ADNE-LAS, with linear motor

Technical data

Function

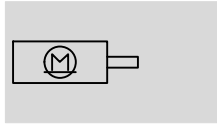

Size
32, 40

Stroke length
15 ... 45 mm

Note

All values are based on a standard temperature of 23 °C. Dynamic response and accuracy are dependent on the mounting (rigidity) and the derivation of the thermal energy (heat concentration).



General technical data					
Size		32		40	
Stroke	[mm]	15	35	20	45
Design		Electric linear direct drive			
		Electric cylinder with piston rod			
Based on standard		ISO 21287			
Type of mounting		Via female thread			
		Via accessories			
Mounting position		Horizontal			
Minimum stroke	[mm]	7.5	17.5	10	22.5
Max. effective load	[g]	500			
Max. speed	[m/s]	1.9	1.8	1.5	1.6
Repetition accuracy	[mm]	±0.1			

Mechanical data						
Size		32		40		
Stroke	[mm]	15	35	20	45	
Deflection of piston rod ¹⁾	Retracted	[mm]	0.14	0.14	0.15	0.15
	Advanced	[mm]	0.25	0.35	0.25	0.50
At operating voltage of 48 V						
Continuous feed force ²⁾	[N]	10.5	5.9	14.2	11	
Peak feed force	[N]	26	15	51	30	
Holding force in the end positions	[N]	3	2	6	4.5	
At operating voltage of 24 V						
Continuous feed force ²⁾	[N]	10.5	5.9	14.2	11	
Peak feed force	[N]	13	8	28	16	
Holding force in the end positions	[N]	3	2	6	4.5	

1) In new condition

2) Measured at a motor temperature of 70 °C

Note

Due to the maximum effective load of 500 g, the lateral force F_q of max. 5 N must not be exceeded.

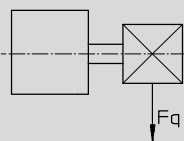

No torques are permissible on the piston rod.

Short-stroke cylinders ADNE-LAS, with linear motor

Technical data

Electrical data	
Motor type	Linear AC synchronous motor
End-position detection	Internal, non-contacting
Magnetic radiation	None

Operating and environmental conditions	
Ambient temperature	[°C] 0 ... +40
Motor temperature during teach-in procedure	[°C] +15 ... +50
Max. motor temperature	[°C] 70 (shuts down at 75 °C/in the event of a malfunction over 100 °C)
Standard temperature ¹⁾	[°C] 23
Temperature monitoring	Shuts down if motor overheats
Storage temperature	[°C] -20 ... +60
Protection class (mechanical system)	IP40
Protection class (electrical connection)	IP65
Relative air humidity (non-condensing)	[%] 95
CE marking (see declaration of conformity)	To EU EMC Directive
Certification	C-Tick
Corrosion resistance class CRC ²⁾	2

1) Unless otherwise stated, all values are based on standard temperature.

2) Corrosion resistance class CRC 2 to Festo standard FN 940070

Moderate corrosion stress. Indoor applications in which condensation may occur. External visible parts with primarily decorative requirements for the surface and which are in direct contact with the ambient atmosphere typical for industrial applications.

Weight [g]					
Size		32		40	
Stroke	[mm]	15	35	20	45
Product weight		710	940	1260	1710
	S20	725	960	1290	1750
Moving load		105	130	275	350
	S20	120	150	305	390

Short-stroke cylinders ADNE-LAS, with linear motor

Technical data



Materials

Sectional view

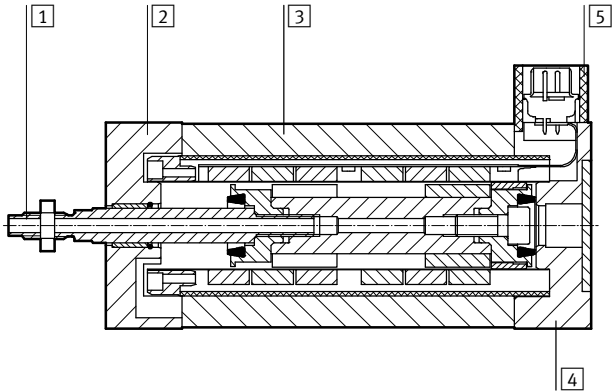

Short-stroke cylinder	
1	Piston rod High-alloy stainless steel
2	Bearing cap Anodised wrought aluminium alloy
3	Housing Anodised wrought aluminium alloy
4	Connector cap Anodised wrought aluminium alloy
5	Cover Anodised wrought aluminium alloy
-	Plain bearing Polyacetal
-	Screws, nuts Steel
Note on materials Contains PWIS (paint-wetting impairment substances) RoHS-compliant	

Internal cushioning

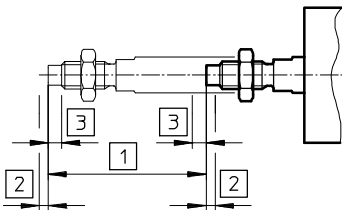

1 Working stroke:

The recommended, available operating range

2 Cushioning length:

The distance from the end positions of the working stroke to the mechanical end position

3 Rebound:

How far the drive rebounds depends on the load, the dynamics of the movement and the temperature of the cylinder

Size		32	40
Stroke	[mm]	15	20
Working stroke	[mm]	15	20
Minimum stroke	[mm]	7.5	10
Cushioning length	[mm]	0.7	0.8
Rebound at 48 V ¹⁾	[mm]	0.8	0.5
Rebound at 24 V ¹⁾	[mm]	0.3	0.5

1) Repeat the teach-in procedure if the rebound is too strong.

Short-stroke cylinders ADNE-LAS, with linear motor

Technical data

Max. frequency f as a function of effective load m and voltage U , briefly

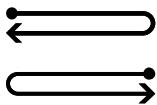

Size	32		40			
Stroke	[mm]	15	35	20	45	
At operating voltage of 48 V						
Frequency	Effective load = 0 g	[Hz]	13.6	7.1	11.6	5.1
	Effective load = 250 g	[Hz]	7.2	5.8	8.9	4.9
	Effective load = 500 g	[Hz]	4.7	4.5	7	4.1
At operating voltage of 24 V						
Frequency	Effective load = 0 g	[Hz]	11.1	5.5	8.8	4.2
	Effective load = 250 g	[Hz]	9.1	4.7	7.2	3.9
	Effective load = 500 g	[Hz]	6	3.2	5.4	3

Note
Applies to a motor temperature up to max. 74 °C.

Frequency f as a function of effective load m and voltage U , during continuous operation

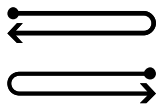

At $U = 48\text{ V}$
ADNE-32-15/35

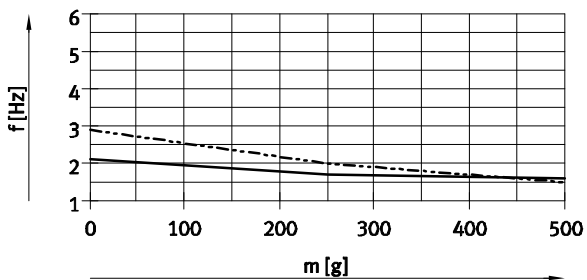

— ADNE-32-15
- - - ADNE-32-35

At $U = 24\text{ V}$
ADNE-32-15/35

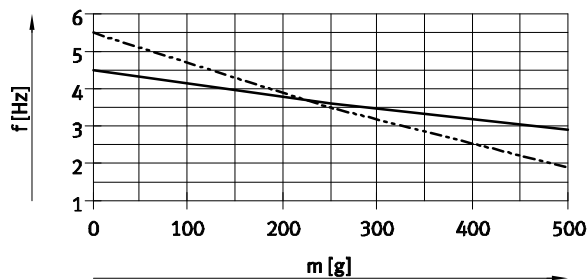

— ADNE-32-15
- - - ADNE-32-35

ADNE-40-20/45

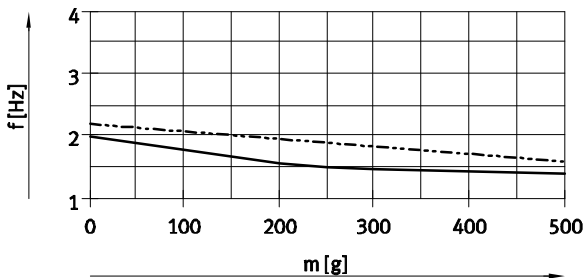

— ADNE-40-20
- - - ADNE-40-45

ADNE-40-20/45

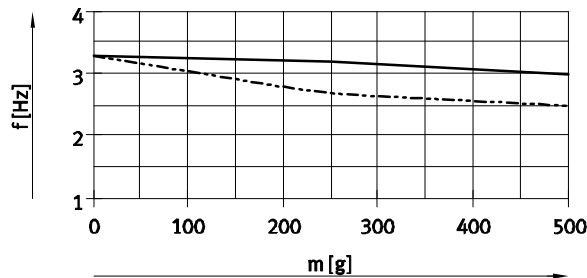

— ADNE-40-20
- - - ADNE-40-45

Short-stroke cylinders ADNE-LAS, with linear motor

Technical data

FESTO

Min. positioning time t as a function of voltage U , at an effective load of 0 g

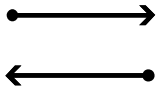

Size	32		40		
Stroke	[mm]	15	35	20	45
At operating voltage of 48 V					
Positioning time	[ms]	30	48	36	75
At operating voltage of 24 V					
Positioning time	[ms]	30	62	44	100

Positioning time t as a function of effective load m and voltage U

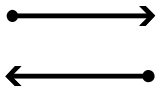

At $U = 48\text{ V}$
ADNE-32-15/35

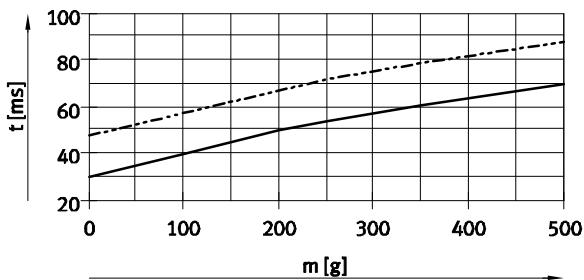

— ADNE-32-15
- - - ADNE-32-35

At $U = 24\text{ V}$
ADNE-32-15/35

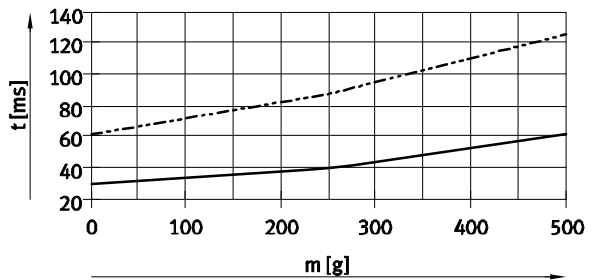

— ADNE-32-15
- - - ADNE-32-35

ADNE-40-20/45

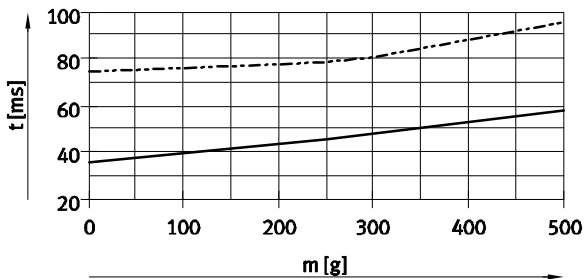

— ADNE-40-20
- - - ADNE-40-45

ADNE-40-20/45

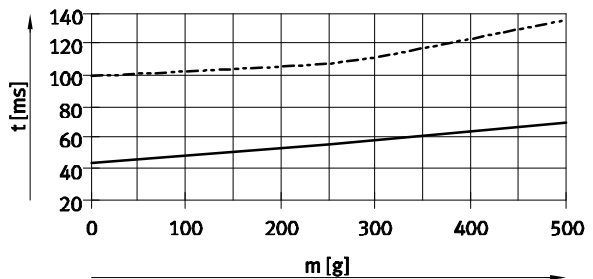

— ADNE-40-20
- - - ADNE-40-45

Short-stroke cylinders ADNE-LAS, with linear motor

Technical data

Min. positioning time t as a function of voltage U , at an effective load of 0 g

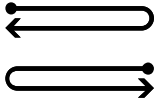

Size	32		40		
Stroke	[mm]	15	35	20	45
At operating voltage of 48 V					
Positioning time	[ms]	64	102	77	160
At operating voltage of 24 V					
Positioning time	[ms]	64	132	94	213

Positioning time t as a function of effective load m and voltage U

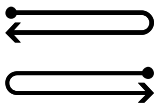

At $U = 48\text{ V}$
ADNE-32-15/35

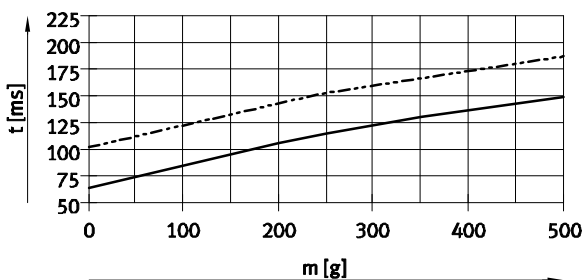

— ADNE-32-15
- - - ADNE-32-35

At $U = 24\text{ V}$
ADNE-32-15/35

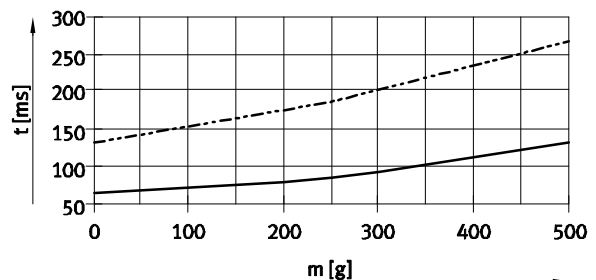

— ADNE-32-15
- - - ADNE-32-35

ADNE-40-20/45

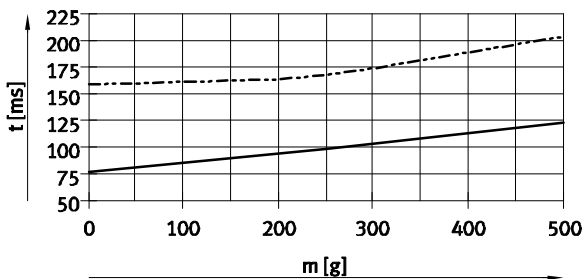

— ADNE-40-20
- - - ADNE-40-45

ADNE-40-20/45

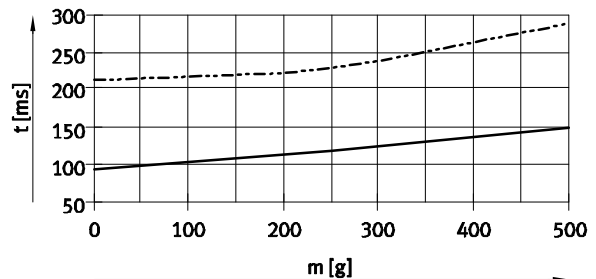

— ADNE-40-20
- - - ADNE-40-45

Short-stroke cylinders ADNE-LAS, with linear motor

Technical data

Dimensions – Basic version

Download CAD data → www.festo.com

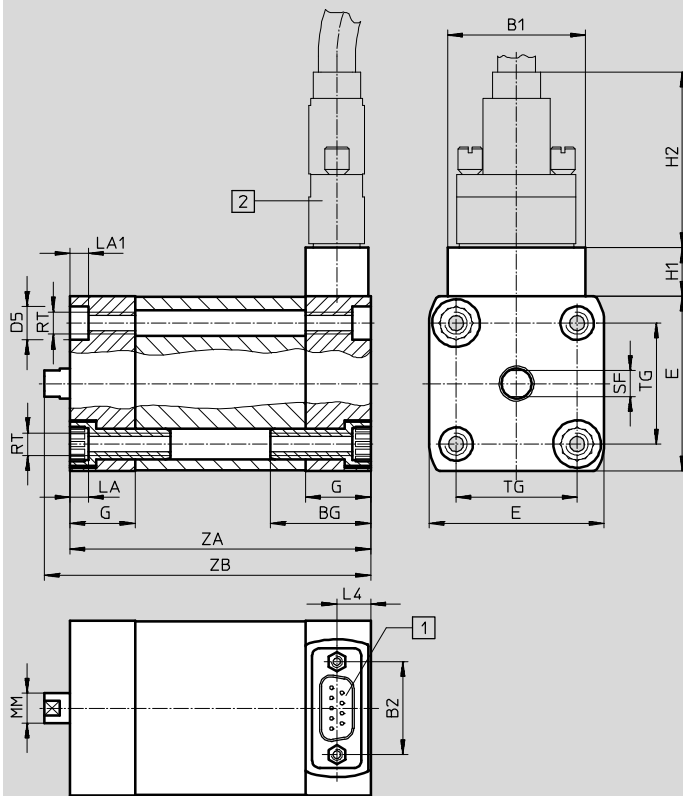

- 1 Electrical connection
- 2 Motor cable not included in the scope of delivery

Size	Stroke [mm]	B1	B2	BG	D5 ∅ F9	E +0.3	G	H1	H2	LA +0.4
32	15	37	25	26	9	47	17.5	13	50	4.6
	35					54.5				
40	20									
	45									

Size	Stroke [mm]	LA1	L4	MM ∅ h9	RT	SF h13	TG ±0.2	ZA +0.4/-0.2	ZB +0.75/-0.35
32	15	5	9.1	8	M6	7	32.5	110.8	117.65
	35			10		9		150.8	157.65
40	20							136.5	143.4
	45						38	186.5	193.4

Short-stroke cylinders ADNE-LAS, with linear motor

Technical data

Dimensions – Variants

Download CAD data → www.festo.com

A – Male thread

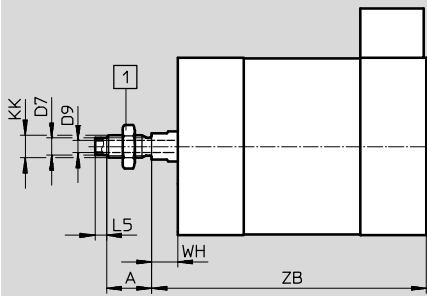

1 Hex nut DIN 439-B included in the scope of delivery

Size	Stroke [mm]	A -0.5	D7 ∅	D9 ∅	KK	L5	WH +0.75 -0.55	ZB +0.75 -0.35
32	15	12	4.5	3.2	M6	3	6.85	117.65
	35							157.65
40	20	16	6	3.8	M8	2	6.9	143.4
	45							193.4

S20 – Through, hollow piston rod

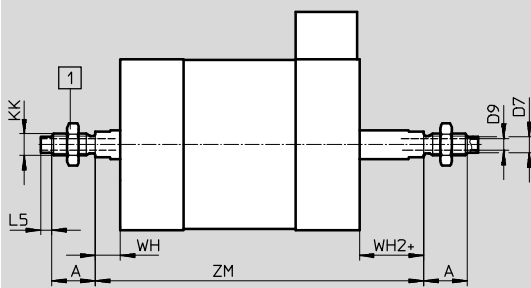

1 Hex nut DIN 439-B included in the scope of delivery
+ = plus stroke length

Size	Stroke [mm]	A -0.5	D7 ∅	D9 ∅	KK	L5	WH +0.75 -0.55	WH2 +0.55 -0.75	ZM +0.6 -0.4
32	15	12	4.5	3.2	M6	3	6.85	6.85	140
	35								200
40	20	16	6	3.8	M8	2	6.9	6.9	170.8
	45								245.8

Short-stroke cylinders ADNE-LAS, with linear motor



Ordering data – Modular products

Ordering table					
Size	32	40	Condi- tions	Code	Enter code
M Module No.	566415	566416			
Function	Electric short-stroke cylinder, based on ISO 21287			ADNE	ADNE
Size	32	40		-...	
Stroke [mm]	15, 35	20, 45		-...	
Drive type	Linear motor			-L	-L
Motor technology	AC synchronous			AS	AS
Piston rod thread	Male thread			-A	A
O Type of piston rod	Through, hollow piston rod			-S20	

Transfer order code

	ADNE	-		-		-	L		AS	-	A	-	
--	-------------	---	--	---	--	---	----------	--	-----------	---	----------	---	--

Short-stroke cylinders ADNE-LAS, with linear motor

Accessories

Foot mounting HNA

Material:

- HNA: Galvanised steel
- HNA-...-R3: Steel with protective coating
- Free of copper and PTFE
- RoHS-compliant

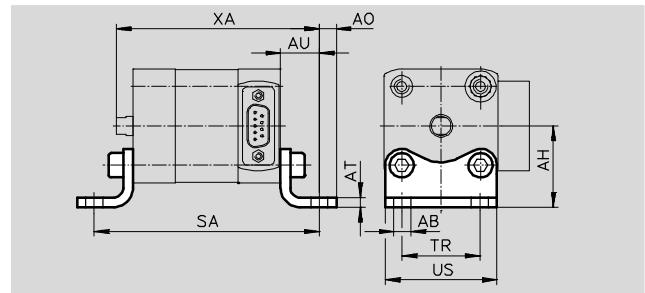

Dimensions and ordering data										
For size	Stroke	AB ∅	AH	A0	AT	AU	SA	TR	US	XA
	[mm]	H14	JS14		±0.5	±0.2		±0.2	-0.5	
32	15	7	33.5	7	4	16	142.8	32	46	133.65
	35						182.8			173.65
40	20	10	38	9	4	18	172.5	36	54	161.4
	45						222.5			211.4

For size	Basic version				High corrosion protection			
	CRC ¹⁾	Weight [g]	Part No.	Type	CRC ¹⁾	Weight [g]	Part No.	Type
32	1	123	537241	HNA-32	3	123	537256	HNA-32-R3
40	1	157	537242	HNA-40	3	157	537257	HNA-40-R3

Flange mounting FNC

Material:

- Galvanised steel
- Free of copper and PTFE
- RoHS-compliant

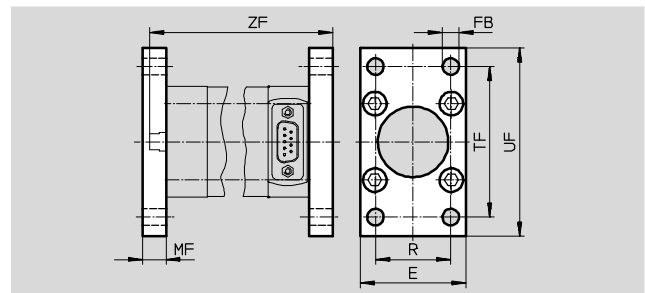

Dimensions and ordering data								
For size	Stroke	E	FB ∅	MF	R	TF	UF	ZF
	[mm]						±1	
32	15	45	7	10	32	64	80	127.65
	35							167.65
40	20	54	9	10	36	72	90	153.4
	45							203.4

For size	Basic version				High corrosion protection			
	CRC ¹⁾	Weight [g]	Part No.	Type	CRC ¹⁾	Weight [g]	Part No.	Type
32	1	221	174376	FNC-32	4	220	161846	CRFNG-32
40	1	291	174377	FNC-40	4	291	161847	CRFNG-40

1) Corrosion resistance class CRC 1 to Festo standard FN 940070
 Low corrosion stress. For dry indoor applications or transport and storage protection. Also applies to parts behind covers, in the non-visible interior area, and parts which are covered in the application (e.g. drive trunnions).
 Corrosion resistance class CRC 3 to Festo standard FN 940070
 High corrosion stress. Outdoor exposure under moderate corrosive conditions. External visible parts with primarily functional requirements for the surface and which are in direct contact with a normal industrial environment.

Corrosion resistance class CRC 4 to Festo standard FN 940070
 Particularly high corrosion stress. Outdoor exposure under extreme corrosive conditions. Parts exposed to aggressive media, for instance in the chemical or food industries. These applications may need to be supported by special tests (→ also FN 940082) using appropriate media.

Short-stroke cylinders ADNE-LAS, with linear motor



Accessories

Swivel flange SNCL

Material:
 SNCL: Die-cast aluminium
 Free of copper and PTFE
 RoHS-compliant

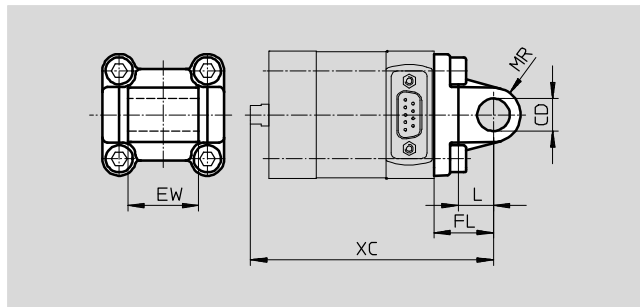

Dimensions and ordering data							
For size	Stroke	CD	EW	FL	L	MR	XC
	[mm]	∅ H9	h12	±0.2			
32	15	10	26	22	13	10	139.65
	35						179.65
40	20	12	28	25	16	12	168.4
	45						218.4

For size	Basic version		Weight [g]	Part No.	Type
	CRC ¹⁾				
32	2		71	174404	SNCL-32
40	2		95	174405	SNCL-40

Swivel flange SNCB/SNCB-...-R3

Material:
 SNCB: Die-cast aluminium
 SNCB-...-R3: Die-cast aluminium with protective coating, high corrosion protection
 Free of copper and PTFE
 RoHS-compliant

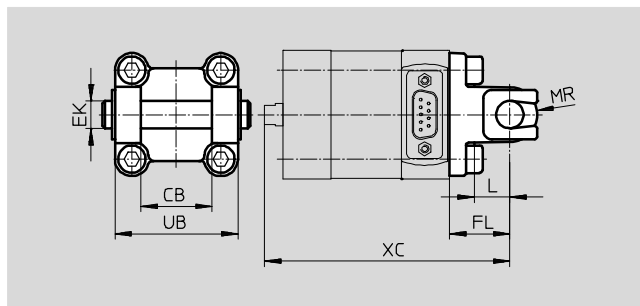

Dimensions and ordering data							
For size	Stroke	CB	EK	FL	L	MR	XC
	[mm]	H14	∅ e8	±0.2			
32	15	26	10	22	13	8.5	139.65
	35						179.65
40	20	28	12	25	16	12	168.4
	45						218.4

For size	Basic version			High corrosion protection				
	CRC ¹⁾	Weight [g]	Part No.	Type	CRC ¹⁾	Weight [g]	Part No.	Type
32	2	103	174390	SNCB-32	3	100	176944	SNCB-32-R3
40	2	155	174391	SNCB-40	3	151	176945	SNCB-40-R3

1) Corrosion resistance class CRC 2 to Festo standard FN 940070
 Moderate corrosion stress. Indoor applications in which condensation may occur. External visible parts with primarily decorative requirements for the surface and which are in direct contact with the ambient atmosphere typical for industrial applications.
 Corrosion resistance class CRC 3 to Festo standard FN 940070
 High corrosion stress. Outdoor exposure under moderate corrosive conditions. External visible parts with primarily functional requirements for the surface and which are in direct contact with a normal industrial environment.

Short-stroke cylinders ADNE-LAS, with linear motor

Accessories

Swivel flange SNCS

Material:
 SNCL: Die-cast aluminium
 Free of copper and PTFE
 RoHS-compliant

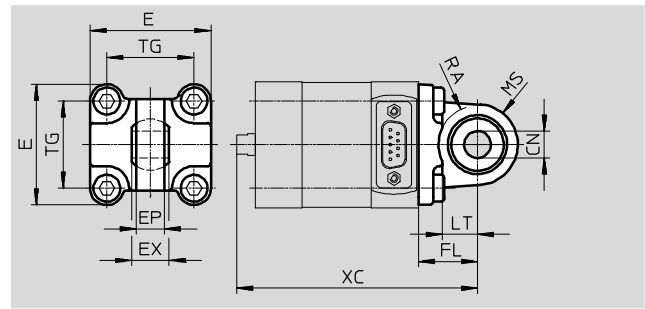

Dimensions and ordering data											
For size	Stroke	CN Ø	E	EP ±0.2	EX	FL ±0.2	LT	MS +1	RA	TG	XC
	[mm]										
32	15	10 ^{+0.013}	45 ^{+0.2/-0.5}	10.5	14	22	13	15 ^{+0.5}	14.5	32.5	139.65
	35										179.65
40	20	12 ^{+0.015}	54 ^{-0.5}	12	16	25	16	17 ^{+0.5}	17.5	38	168.4
	45										218.4

For size	Basic version		Weight [g]	Part No.	Type
	CRC ¹⁾				
32	2		86	174397	SNCS-32
40	2		122	174398	SNCS-40

Trunnion flange ZNCF/CRZNG

Material:
 ZNCF: Stainless steel casting
 CRZNG: Electropolished stainless steel casting
 Free of copper and PTFE
 RoHS-compliant

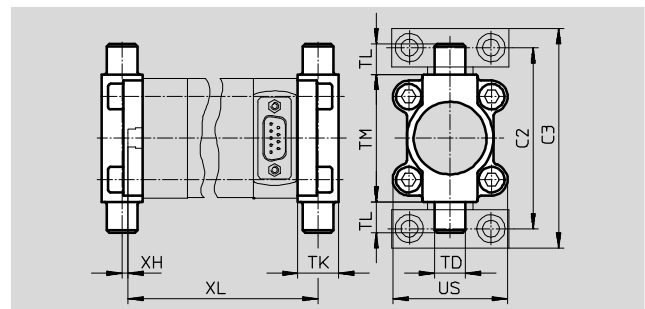

Dimensions and ordering data										
For size	Stroke	C2	C3	TD Ø e9	TK	TL	TM	US	XH	XL
	[mm]									
32	15	71	86	12	16	12	50	45	1.15	125.65
	35									165.65
40	20	87	105	16	20	16	63	54	3.1	153.4
	45									203.4







For size	Basic version			High corrosion protection		
	CRC ¹⁾	Weight [g]	Part No. Type	CRC ¹⁾	Weight [g]	Part No. Type
32	2	150	174411 ZNCF-32	4	150	161852 CRZNG-32
40	2	285	174412 ZNCF-40	4	285	161853 CRZNG-40





1) Corrosion resistance class CRC 2 to Festo standard FN 940070
 Moderate corrosion stress. Indoor applications in which condensation may occur. External visible parts with primarily decorative requirements for the surface and which are in direct contact with the ambient atmosphere typical for industrial applications.
 Corrosion resistance class CRC 4 to Festo standard FN 940070
 Particularly high corrosion stress. Outdoor exposure under extreme corrosive conditions. Parts exposed to aggressive media, for instance in the chemical or food industries. These applications may need to be supported by special tests (→ also FN 940082) using appropriate media.

Short-stroke cylinders ADNE-LAS, with linear motor

FESTO

Accessories

Ordering data			
Designation	For size	Part No.	Type
Trunnion support LNZG			
	32	32959	LNZG-32
	40	32960	LNZG-40/50
Trunnion support CRLNZG, corrosion-resistant			
	32	161874	CRLNZG-32
	40	161875	CRLNZG-40/50
Clevis foot LNG			
	32	33890	LNG-32
	40	33891	LNG-40
Clevis foot CRLNG, corrosion-resistant			
	32	161840	CRLNG-32
	40	161841	CRLNG-40
Clevis foot LBG			
	32	31761	LBG-32
	40	31762	LBG-40
Rod eye SGS			
	32	9254	SGS-M6
	40	9255	SGS-M8
Rod eye CRS GS, corrosion-resistant			
	32	195580	CRSGS-M6
	40	195581	CRSGS-M8

Ordering data			
Designation	For size	Part No.	Type
Coupling piece KSZ			
	32	36123	KSZ-M6
	40	36124	KSZ-M8
Adapter AD			
	32	157328	AD-M6-M5
		157329	AD-M6-1/8
		157330	AD-M6-1/4
	40	157331	AD-M8-1/8
		157332	AD-M8-1/4
Rod clevis SG			
	32	3110	SG-M6
	40	3111	SG-M8
Rod clevis CRSG, corrosion-resistant			
	32	13567	CRSG-M6
	40	13568	CRSG-M8
Self-aligning rod coupler FK			
	32	2061	FK-M6
	40	2062	FK-M8