

Filter silencers LFU







Filter silencers LFU

Technical data

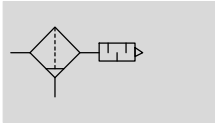
FESTO

Function



-  Flow rate
4,000 ... 12,500 l/min
-  Temperature range
-10 ... +100 °C
-  Operating pressure
0 ... 16 bar



The filter silencer cleans all exhaust air from pneumatic control systems. The exhaust air is discharged into the atmosphere via a fine filter cartridge (degree of filtration: >99.99%).

At the same time, exhaust noise is greatly reduced. Condensate is collected in the lower plastic bowl and can be discharged via the condensate drain.

- Removes up to 99.99% of oil and other contaminants from exhaust air
- The silencer reduces exhaust noise regardless of frequency

General technical data				
Size	G $\frac{1}{4}$	G $\frac{3}{8}$	G $\frac{1}{2}$	G1
Pneumatic connection	G $\frac{1}{4}$	G $\frac{3}{8}$	G $\frac{1}{2}$	G1
Mounting position	Vertical $\pm 5^\circ$			
Grade of filtration [µm]	1			
Condensate drain	Manual rotary			
Flow rate with respect to atmosphere ¹⁾ [l/min]	$\geq 4,000$	$\geq 4,700$	$\leq 6,000$	$\leq 12,500$
Noise reduction ¹⁾	Reduction by 40 dB(A)		>40 dB(A)	

1) At 6 bar.

-  Note: This product conforms to ISO 1179-1 and to ISO 228-1

Operating and environmental conditions				
Size	G $\frac{1}{4}$	G $\frac{3}{8}$	G $\frac{1}{2}$	G1
Operating pressure [bar]	0 ... 16			
Operating medium	Compressed air in accordance with ISO 8573-1:2010 [7:4:4]			
Note on operating/pilot medium	Operation with lubricated medium possible (in which case lubricated operation will always be required)			
Ambient temperature [°C]	-10 ... +60		0 ... +100	
Corrosion resistance class CRC ¹⁾	2		1	

1) Corrosion resistance class CRC 1 to Festo standard FN 940070

Low corrosion stress. For dry indoor applications or transport and storage protection. Also applies to parts behind covers, in the non-visible interior area, and parts which are covered in the application (e.g. drive trunnions).

Corrosion resistance class CRC 2 to Festo standard FN 940070

Moderate corrosion stress. Indoor applications in which condensation may occur. External visible parts with primarily decorative requirements for the surface and which are in direct contact with the ambient atmosphere typical for industrial applications.

Weight [g]				
Size	G $\frac{1}{4}$	G $\frac{3}{8}$	G $\frac{1}{2}$	G1
Filter silencer	190	190	570	1,010

Filter silencers LFU

Technical data

Materials

Sectional view

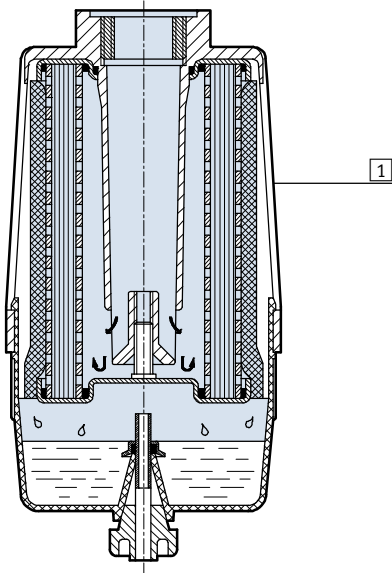

Filter silencer	
1	Housing
Note on materials	
PP	
RoHS-compliant	
Free of copper and PTFE	

Dimensions and ordering data

Download CAD data → www.festo.com

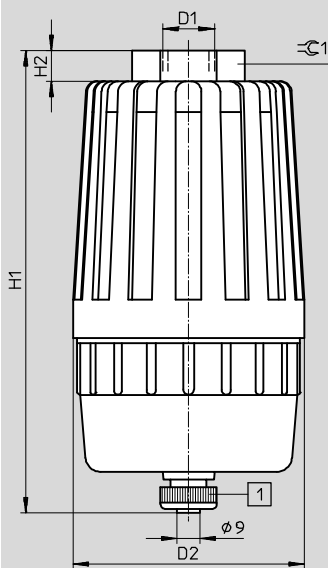

1 Manual rotary condensate drain

Connection	D1	D2	H1	H2	≈C1	Part No.	Type
G $\frac{1}{4}$	G $\frac{1}{4}$	77	131	7	26	539132	LFU- $\frac{1}{4}$
G $\frac{3}{8}$	G $\frac{3}{8}$	77	131	7	26	539133	LFU- $\frac{3}{8}$
G $\frac{1}{2}$	G $\frac{1}{2}$	90	180	12	36	10494	LFU- $\frac{1}{2}$
G1	G1	110	252	15	50	10495	LFU-1

- || - Note: This product conforms to ISO 1179-1 and to ISO 228-1

Filter silencers LFU

Accessories

FESTO

Filter cartridge LFPU

Note on material:

RoHS-compliant

Free of copper and PTFE

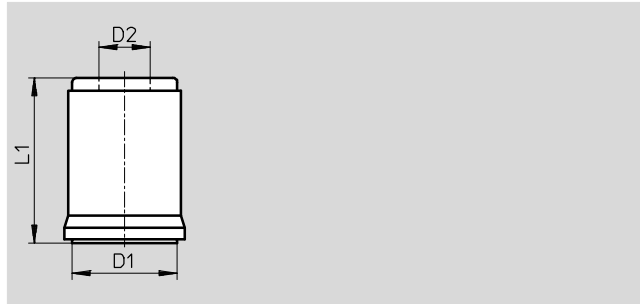

Dimensions and ordering data					
For connection	D1	D2	L1	Part No.	Type
	Ø	Ø			
G $\frac{1}{4}$, G $\frac{3}{8}$	60	28	69	539134	LFPU-$\frac{1}{4}$-$\frac{3}{8}$
G $\frac{1}{2}$	70	34.8	110	10496	LFPU-$\frac{1}{2}$
G1	82	42.8	180	10497	LFPU-1

Festo - Your Partner in Automation



1 Festo Inc.
5300 Explorer Drive
Mississauga, ON L4W 5G4
Canada

Festo Customer Interaction Center
Tel: 1 877 463 3786
Fax: 1 877 393 3786
Email: customer.service.ca@festo.com



2 Festo Pneumatic
Av. Ceylán 3,
Col. Tequesquináhuac
54020 Tlalneantla,
Estado de México

Multinational Contact Center
01 800 337 8669
ventas.mexico@festo.com



3 Festo Corporation
1377 Motor Parkway
Suite 310
Islandia, NY 11749

Festo Customer Interaction Center
1 800 993 3786
1 800 963 3786
customer.service.us@festo.com



4 Regional Service Center
7777 Columbia Road
Mason, OH 45040

Connect with us



www.festo.com/socialmedia



www.festo.com

Subject to change