

Universal valve CPE

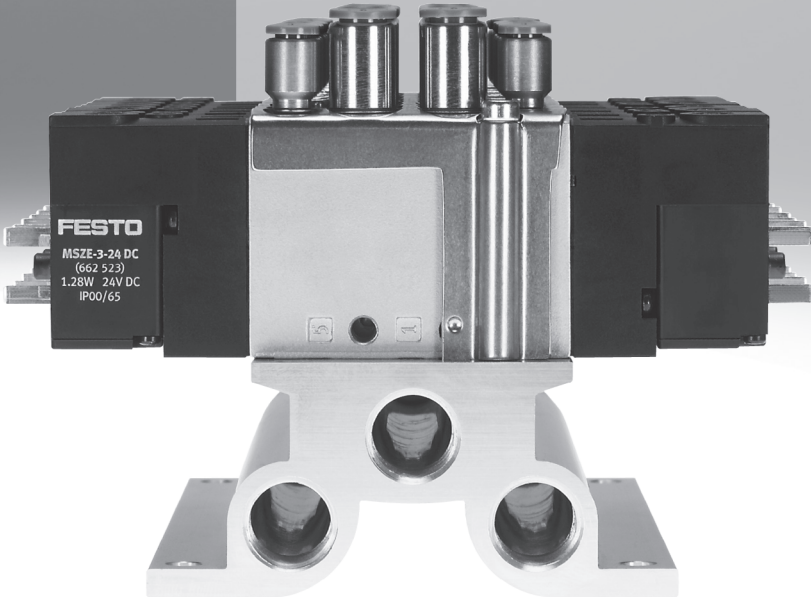

Solenoid valves CPE, Compact Performance

Key features

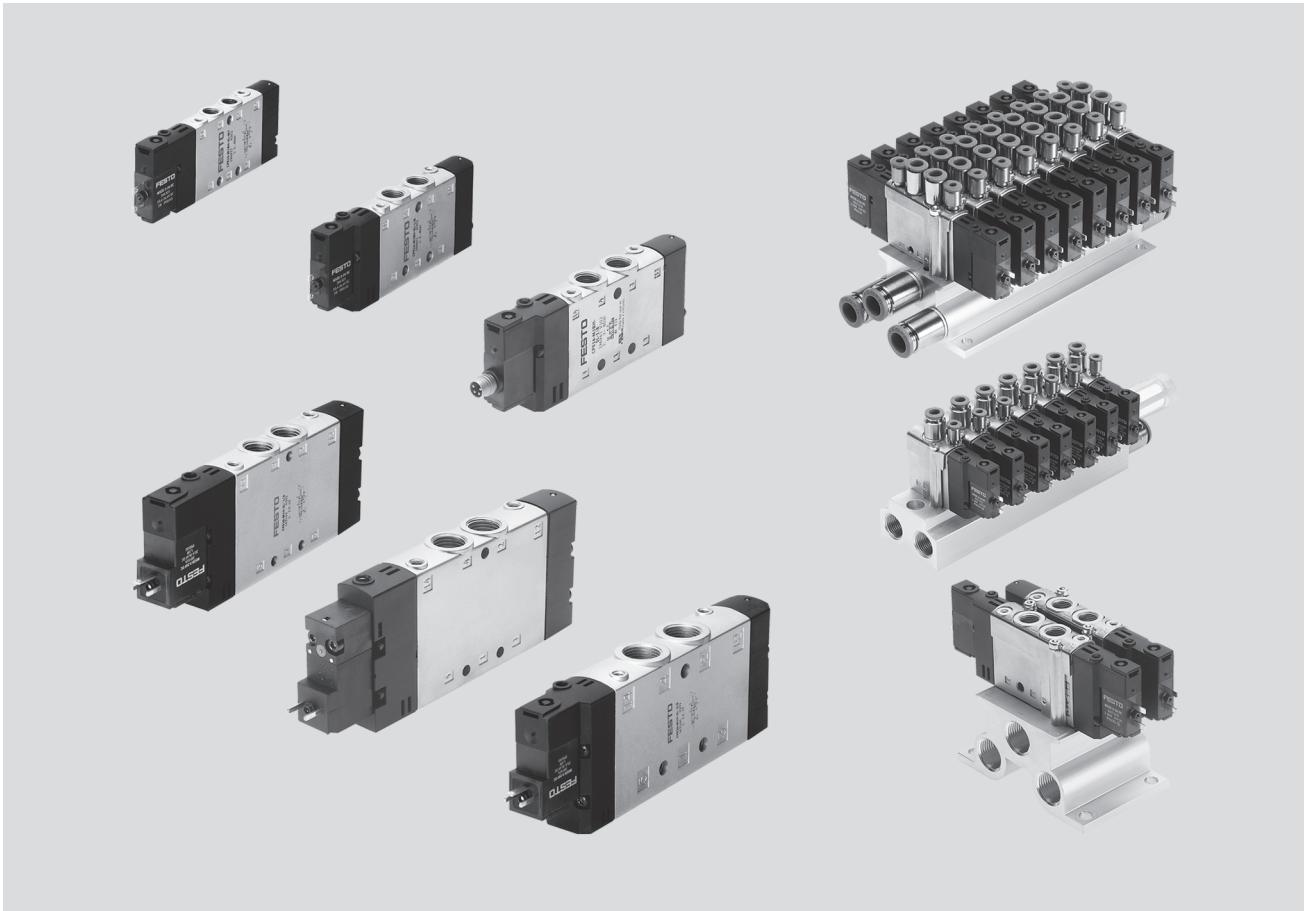

Variants

Functions (selection)

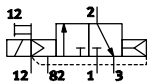

3/2-way valve with external pilot air supply, normally closed

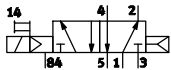

5/2-way single solenoid valve with internal pilot air supply

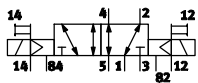

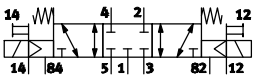

5/2-way double solenoid valve with external pilot air supply



5/3-way valve with external pilot air supply, normally closed

Parameters

-  Width
10 mm
14 mm
18 mm
24 mm
-  Flow rate
180 ... 3200 l/min

-  Note

The 5/3-way solenoid valve remains in the previous switching position if both solenoid coils are energised simultaneously.
If neither solenoid coil is energised, the spring force moves the valve to its mid-position.

Advantages

Performance-optimised sizes:
The solenoid valves CPE, Compact Performance are distinguished by their minimal width and low power consumption at high flow rates.

They can be mounted directly on site:

- On the cylinder
- On moving system components
- Flexible installation through individual mounting

Short tubing lengths requiring minimal air volume:

- Short switching times
 - Short response times
- Optimised installations:
- Shorter machine cycles
 - Larger quantities
 - Lower power consumption

Convenient manual override.

CPE10, CPE14 and CPE18:
Simple manifold structure consisting of fixed-grid manifold blocks made from stable aluminium with 2 to 10 valve positions or modular manifold blocks made from durable plastic.

The connecting cables NEBV for sizes CPE10 and CPE14 feature integrated current reduction.
All CPE valves therefore have a duty cycle of 100%.

Solenoid valves CPE, Compact Performance

Key features

Solenoid valves with plug pins

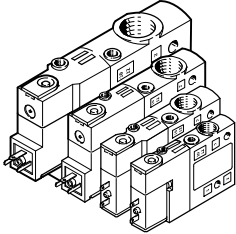

- Width 10 mm, 14 mm, 18 mm and 24 mm
- 3/2-, 5/2- and 5/3-way valves
- Internal or external pilot air supply available
- 24 V DC for all widths
- 110 or 220 V AC for widths 18 and 24
- Manual override, non-detenting and detenting via tool
- Width 10 mm available with M5 insert
- All widths available with QS fittings in 2 sizes

Solenoid valves with round plug

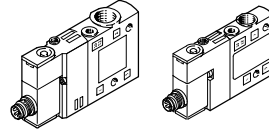

- Width 10 mm and 14 mm
- 3/2-, 5/2- and 5/3-way valves
- Internal or external pilot air supply available
- 24 V DC
- Manual override, non-detenting and detenting via tool
- Round plug, M8x1, 4-pin

CPE18 basic valve with interface to ISO 15218

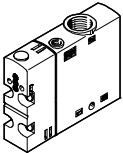

- Width 18 mm
- 3/2-, 5/2- and 5/3-way valves
- Internal or external pilot air supply available

Pilot valve with interface to ISO 15218

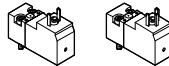

- For 12, 24 V DC and 24 V AC without PE conductor
- For 110 and 220 V AC with PE conductor
- 3/2-way valve
- Manual override, non-detenting

Adapter VAVE



Fits plug pins with connection pattern ZC for CPE10/CPE14

Combination of basic valve CPE18 with pilot valve

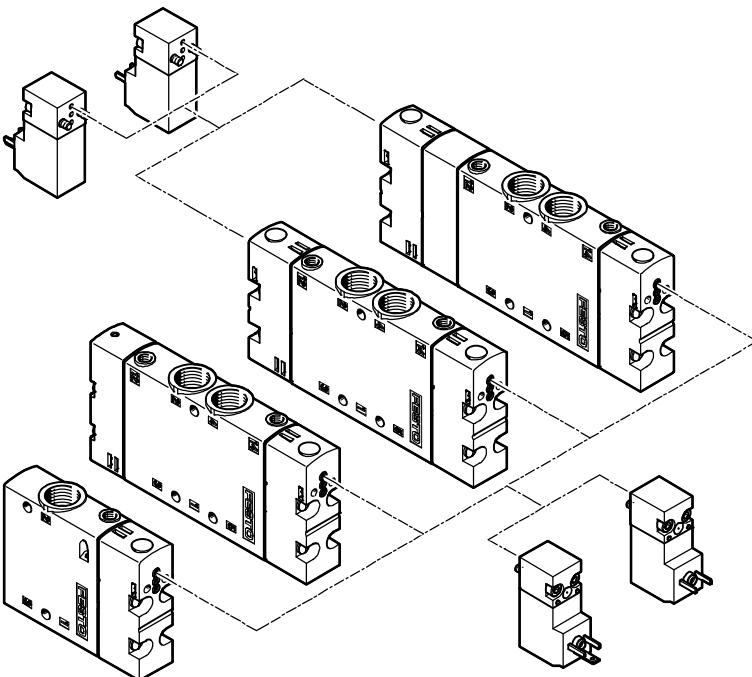

Solenoid valves CPE, Compact Performance

Key features

FESTO

Manifold block for fixed-grid manifold

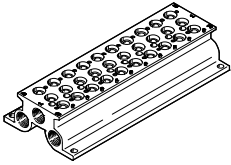

- For valve widths 10, 14 and 18 mm
- For 5/2- and 5/3-way valves
- 2 to 10 valve positions

Manifold block for fixed-grid manifold

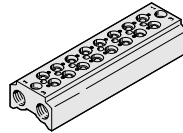

- For valve widths 10, 14 and 18 mm
- For 3/2-way valves
- 2 to 10 valve positions

Retainer set



- Retainer for 5/2- or 5/3-way valve

Retainer set

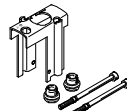

- Retainer for 3/2-way valve

Blanking plate for unused valve position



- Vacant position cover for 5/2- or 5/3-way valve

Blanking plate for unused valve position



- Vacant position cover for 3/2-way valve

Manifold block with air supply

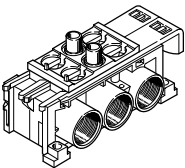

- 2 valve positions
- For CPE10, CPE14 or CPE18
- For 5/2- and 5/3-way valves
- Ducts 1, 3 and 5 can have closed or open ends
- Ducts closed when the manifold is full or when pressure zones are being used

Manifold block for expansion

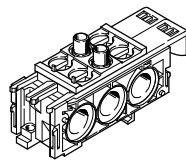

- 2 valve positions
- For CPE10, CPE14 or CPE18
- For 5/2- and 5/3-way valves
- Ducts 1, 3 and 5 can have closed or open ends

Manifold block with air supply

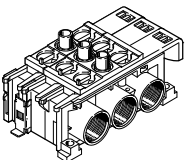

- 3 valve positions
- For CPE10, CPE14 or CPE18
- For 5/2- and 5/3-way valves
- Ducts 1, 3 and 5 can have closed or open ends
- Ducts closed when the manifold is full or when pressure zones are being used

End plate for additional air supply

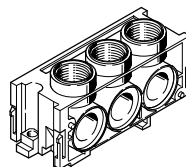

- For CPE10, CPE14 or CPE18
- Required for manifolds with more than 6 valves or separate pressure zones
- Ports 1, 3 and 5 at rear and on top

Blanking plate for unused valve position

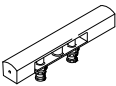

- Versions
- Vacant position cover for 5/2- or 5/3-way valve

Modular manifold with blanking plate

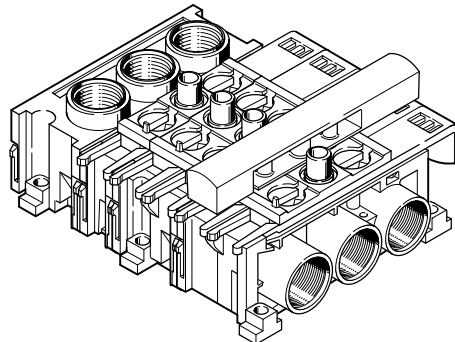

Solenoid valves CPE, Compact Performance

Key features

FESTO

Mounting on fixed-grid manifold block for CPE10, CPE14 and CPE18

- Simple structure comprising compact valve manifolds with in-line valves
- Mounting with stable retainer and special moulded seal guarantee leak-free assembly
- 2 to 10 valve positions
- Aluminium mounting rail provides high stability
- High flow rates with air supply on both sides for duct 1
- High exhaust capacity with output on both sides for ducts 3 and 5
- Different pressure and exhaust zones can be created using separators, which are clamped at the separation points in ducts 1, 3 and 5

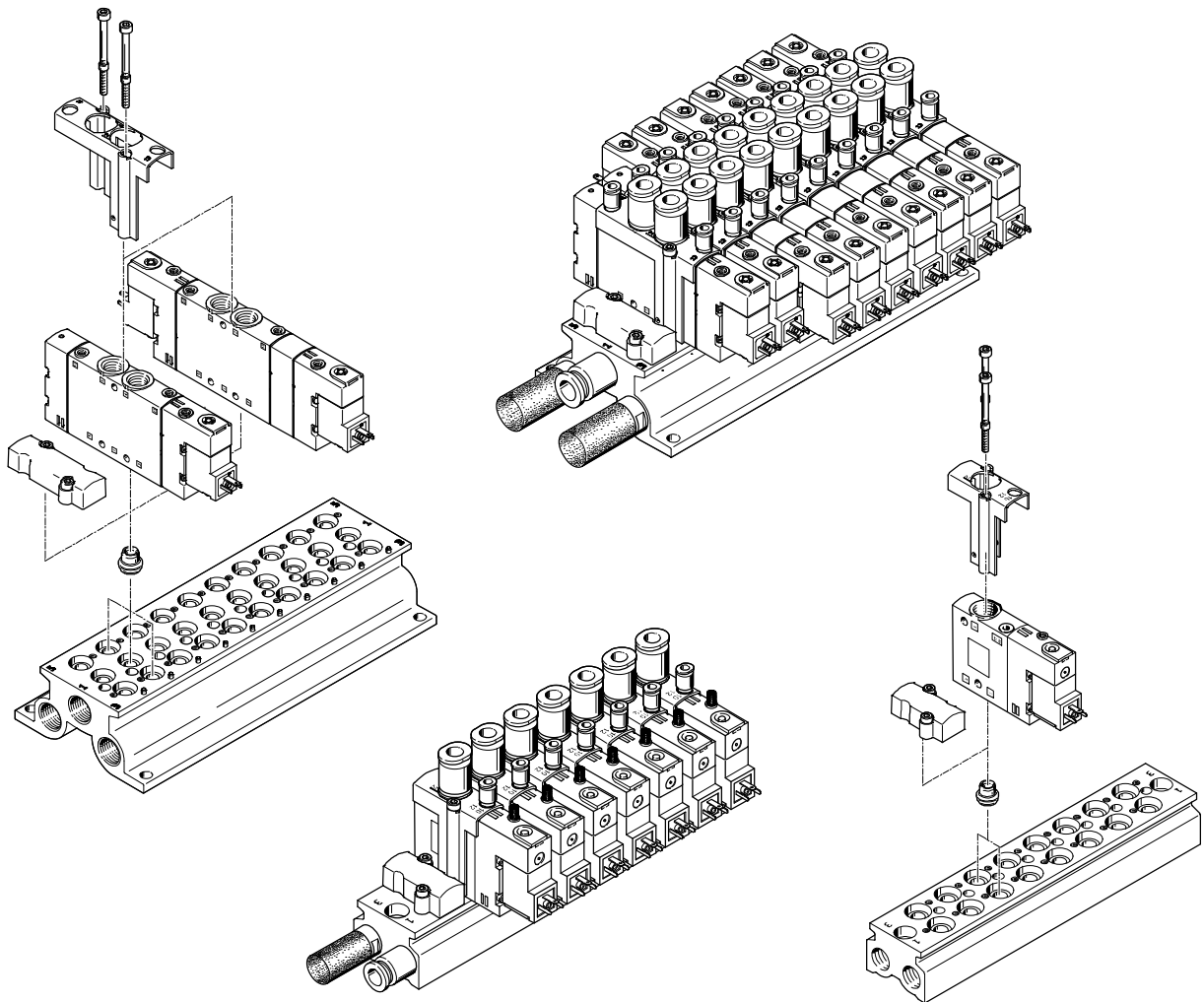

Solenoid valves CPE, Compact Performance

Key features

FESTO

Mounting on fixed-grid manifold block for CPE10, CPE14 and CPE18

- Construction of a valve manifold with modular manifold blocks made from high impact, glass fibre reinforced polyamide
- Different pressure zones can be created using basic and expansion blocks with closed supply and exhaust ducts
- Air supply and exhaust can be connected on both sides using an additional end block
- Air supply and exhaust can be connected to the end block, at the rear and at the top
- No screws required for mounting thanks to slides and clips

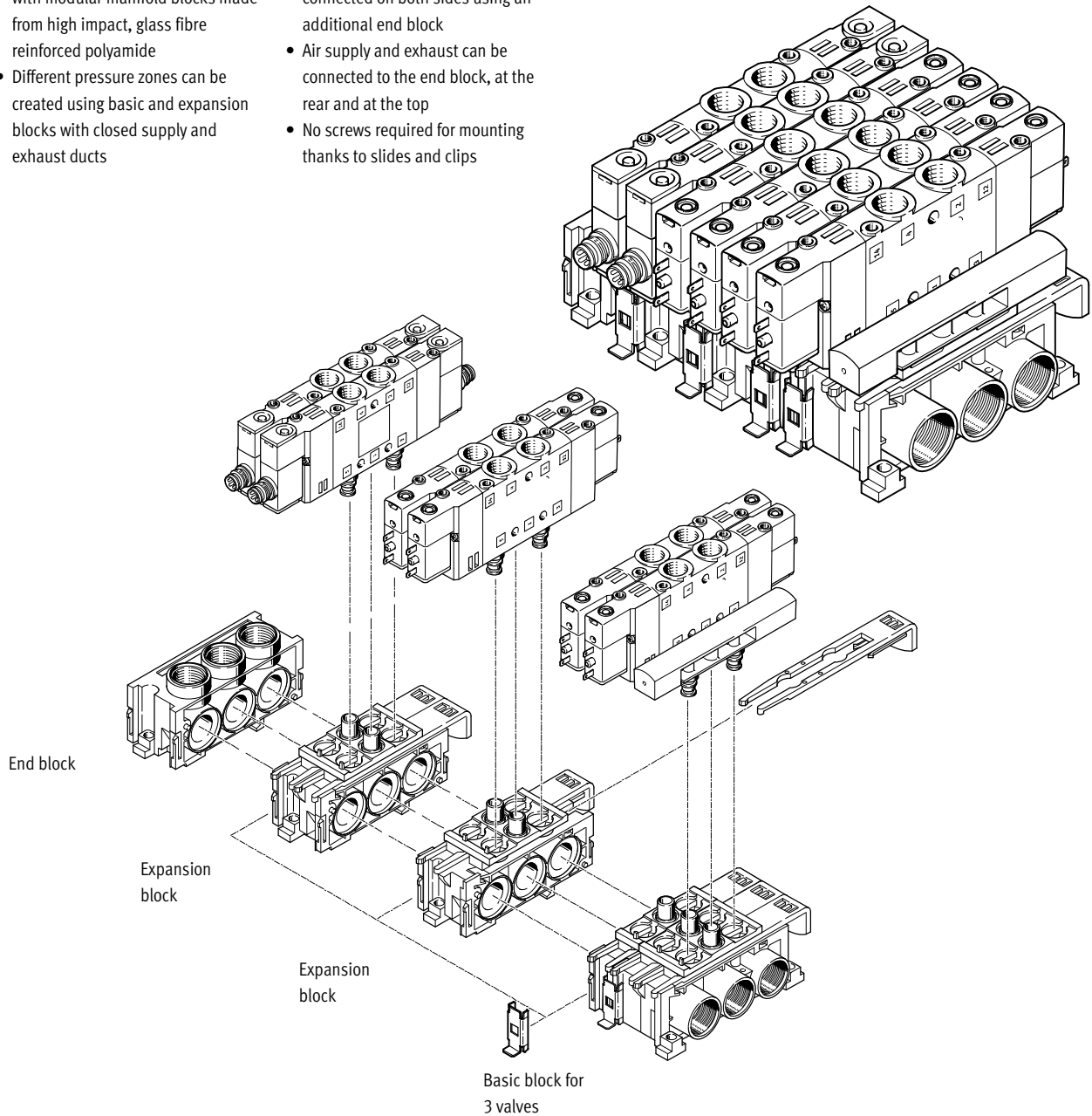

Solenoid valves CPE, Compact Performance

Product range overview – Widths 10 mm and 14 mm

Width	Circuit symbol	Type	Electrical connection		Operating voltage [V DC]	Working port						→ Page/ Internet
			Connection pattern ZC	M8x1		M5	M7	G1/8	QS4	QS6	QS8	
10 mm	3/2-way single solenoid valve, normally closed											
		CPE10-M1BH-3GL...	■	–	24	■	■	–	■	■	–	25
		CPE10-M1CH-3GL...	–	■	24	–	■	–	–	–	–	
	3/2-way single solenoid valve, normally open											
		CPE10-M1BH-3OL...	■	–	24	■	■	–	■	■	–	25
		CPE10-M1CH-3OL...	–	■	24	–	■	–	–	–	–	
	5/2-way single solenoid valve											
		CPE10-M1BH-5L...	■	–	24	■	■	–	■	■	–	25
		CPE10-M1CH-5L...	–	■	24	–	■	–	–	–	–	
	5/2-way double solenoid valve											
		CPE10-M1BH-5J...	■	–	24	■	■	–	■	■	–	25
		CPE10-M1CH-5J...	–	■	24	–	■	–	–	–	–	
	5/3-way solenoid valve, normally closed, mid-position valve											
		CPE10-M1BH-5/3G...	■	–	24	■	■	–	■	■	–	26
	CPE10-M1CH-5/3G...	–	■	24	–	■	–	–	–	–		
5/3-way solenoid valve, normally open, mid-position valve												
	CPE10-M1BH-5/3B...	■	–	24	■	■	–	■	■	–	26	
	CPE10-M1CH-5/3B...	–	■	24	–	■	–	–	–	–		
5/3-way solenoid valve, normally exhausted, mid-position valve												
	CPE10-M1BH-5/3E...	■	–	24	■	■	–	■	■	–	26	
	CPE10-M1CH-5/3E...	–	■	24	–	■	–	–	–	–		
14 mm	3/2-way single solenoid valve, normally closed											
		CPE14-M1BH-3GL...	■	–	24	–	–	■	–	■	■	42
		CPE14-M1CH-3GL...	–	■	24	–	–	■	–	–	–	
	3/2-way single solenoid valve, normally open											
		CPE14-M1BH-3OL...	■	–	24	–	–	■	–	■	■	42
		CPE14-M1CH-3OL...	–	■	24	–	–	■	–	–	–	
	5/2-way single solenoid valve											
		CPE14-M1BH-5L...	■	–	24	–	–	■	–	■	■	42
		CPE14-M1CH-5L...	–	■	24	–	–	■	–	–	–	
	5/2-way double solenoid valve											
		CPE14-M1BH-5J...	■	–	24	–	–	■	–	■	■	42
		CPE14-M1CH-5J...	–	■	24	–	–	■	–	–	–	
	5/3-way solenoid valve, normally closed, mid-position valve											
		CPE14-M1BH-5/3G...	■	–	24	–	–	■	–	■	■	43
	CPE14-M1CH-5/3G...	–	■	24	–	–	■	–	–	–		
5/3-way solenoid valve, normally open, mid-position valve												
	CPE14-M1BH-5/3B...	■	–	24	–	–	■	–	■	■	43	
	CPE14-M1CH-5/3B...	–	■	24	–	–	■	–	–	–		
5/3-way solenoid valve, normally exhausted, mid-position valve												
	CPE14-M1BH-5/3E...	■	–	24	–	–	■	–	■	■	43	
	CPE14-M1CH-5/3E...	–	■	24	–	–	■	–	–	–		

Solenoid valves CPE, Compact Performance

Product range overview – Width 18 mm

Width	Circuit symbol	Type	Operating voltage		Working port			→ Page/ Internet	
			[V DC]	[V AC]	G1/4	QS8	QS10		
18 mm		3/2-way single solenoid valve, normally closed						57	
		CPE18-M1H-3GL...	24	–	■	■	■		
		CPE18-M2H-3GL...	–	110	■	■	■		
		CPE18-M3H-3GL...	–	220	■	■	■		
			CPE18-P1-3GL...1/4	12 ¹⁾	110 ¹⁾	■	–	–	64
				24 ¹⁾	230 ¹⁾	■	–	–	
		3/2-way single solenoid valve, normally open						57	
		CPE18-M1H-3OL...	24	–	■	■	■		
		CPE18-M2H-3OL...	–	110	■	■	■		
		CPE18-M3H-3OL...	–	220	■	■	■		
			CPE18-P1-3OL...1/4	12 ¹⁾	110 ¹⁾	■	–	–	64
				24 ¹⁾	230 ¹⁾	■	–	–	
		5/2-way single solenoid valve						58	
		CPE18-M1H-5L...	24	–	■	■	■		
		CPE18-M2H-5L...	–	110	■	■	■		
		CPE18-M3H-5L...	–	220	■	■	■		
			CPE18-P1-5L...1/4	12 ¹⁾	110 ¹⁾	■	–	–	64
				24 ¹⁾	230 ¹⁾	■	–	–	
		5/2-way double solenoid valve						58	
		CPE18-M1H-5J...	24	–	■	■	■		
		CPE18-M2H-5J...	–	110	■	■	■		
		CPE18-M3H-5J...	–	220	■	■	■		
			CPE18-P1-5J...1/4	12 ¹⁾	110 ¹⁾	■	–	–	64
				24 ¹⁾	230 ¹⁾	■	–	–	
		5/3-way solenoid valve, normally closed, mid-position valve						59	
		CPE18-M1H-5/3G...	24	–	■	■	■		
		CPE18-M2H-5/3G...	–	110	■	■	■		
		CPE18-M3H-5/3G...	–	220	■	■	■		
			CPE18-P1-5/3G...1/4	12 ¹⁾	110 ¹⁾	■	–	–	64
				24 ¹⁾	230 ¹⁾	■	–	–	
		5/3-way solenoid valve, normally open, mid-position valve						59	
		CPE18-M1H-5/3B...	24	–	■	■	■		
		CPE18-M2H-5/3B...	–	110	■	■	■		
		CPE18-M3H-5/3B...	–	220	■	■	■		
			CPE18-P1-5/3B...1/4	12 ¹⁾	110 ¹⁾	■	–	–	64
				24 ¹⁾	230 ¹⁾	■	–	–	
		5/3-way solenoid valve, normally exhausted, mid-position valve						59	
		CPE18-M1H-5/3E...	24	–	■	■	■		
		CPE18-M2H-5/3E...	–	110	■	■	■		
		CPE18-M3H-5/3E...	–	220	■	■	■		
			CPE18-P1-5/3E...1/4	12 ¹⁾	110 ¹⁾	■	–	–	64
				24 ¹⁾	230 ¹⁾	■	–	–	

1) Operating voltage dependent on pilot valve to be ordered separately

Solenoid valves CPE, Compact Performance

Product range overview – Width 24 mm

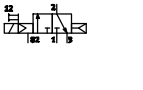
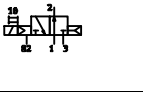
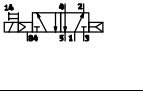
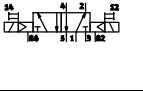
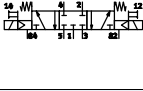
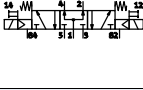
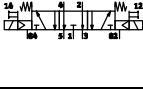
Width	Circuit symbol	Type	Operating voltage		Working port			→ Page/ Internet
			[V DC]	[V AC]	G3/8	QS10	QS12	
24 mm	3/2-way single solenoid valve, normally closed							
		CPE24-M1H-3GL...	24	-	■	■	■	78
		CPE24-M2H-3GL...	-	110	■	■	■	
		CPE24-M3H-3GL...	-	220	■	■	■	
	3/2-way single solenoid valve, normally open							
		CPE24-M1H-3OL...	24	-	■	■	■	78
		CPE24-M2H-3OL...	-	110	■	■	■	
		CPE24-M3H-3OL...	-	220	■	■	■	
	5/2-way single solenoid valve							
		CPE24-M1H-5L...	24	-	■	■	■	79
		CPE24-M2H-5L...	-	110	■	■	■	
		CPE24-M3H-5L...	-	220	■	■	■	
	5/2-way double solenoid valve							
		CPE24-M1H-5J...	24	-	■	■	■	79
		CPE24-M2H-5J...	-	110	■	■	■	
		CPE24-M3H-5J...	-	220	■	■	■	
	5/3-way solenoid valve, normally closed, mid-position valve							
		CPE24-M1H-5/3G...	24	-	■	■	■	80
		CPE24-M2H-5/3G...	-	110	■	■	■	
		CPE24-M3H-5/3G...	-	220	■	■	■	
	5/3-way solenoid valve, normally open, mid-position valve							
		CPE24-M1H-5/3B...	24	-	■	■	■	80
		CPE24-M2H-5/3B...	-	110	■	■	■	
		CPE24-M3H-5/3B...	-	220	■	■	■	
5/3-way solenoid valve, normally exhausted, mid-position valve								
	CPE24-M1H-5/3E...	24	-	■	■	■	80	
	CPE24-M2H-5/3E...	-	110	■	■	■		
	CPE24-M3H-5/3E...	-	220	■	■	■		

Solenoid valves CPE, Compact Performance

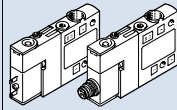
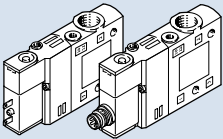
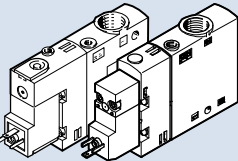
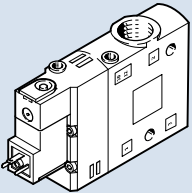
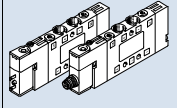
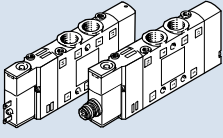
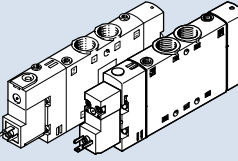
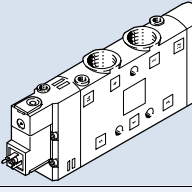

Product range overview – Functions

3/2-way valves					
Type		CPE10	CPE14	CPE18	CPE24
Width		10 mm	14 mm	18 mm	24 mm
Standard nominal flow rate [l/min]					
Thread	M5	190	-	-	-
	M7	400	-	-	-
	G1/8	-	900	-	-
	G1/4	-	-	1300	-
	G3/8	-	-	-	2500
Push-in connector	QS-4	190	-	-	-
	QS-6	300	510	-	-
	QS-8	-	810	850	-
	QS-10	-	-	1000	1250
	QS-12	-	-	-	1650
5/2-way valves, single solenoid					
					
Type		CPE10	CPE14	CPE18	CPE24
Width		10 mm	14 mm	18 mm	24 mm
Standard nominal flow rate [l/min]					
Thread	M5	180	-	-	-
	M7	350	-	-	-
	G1/8	-	800	-	-
	G1/4	-	-	1300	-
	G3/8	-	-	-	2900
Push-in connector	QS-4	180	-	-	-
	QS-6	320	400	-	-
	QS-8	-	680	850	-
	QS-10	-	-	1000	1250
	QS-12	-	-	-	1650
Operating voltage					
12 V DC		-	-	■	-
24 V DC/AC		■/-	■/-	■/■	■/-
110 V AC		-	-	■	■
230 V AC		-	-	■	■
Technical data → page		19	34	51	72

Solenoid valves CPE, Compact Performance

Product range overview – Functions

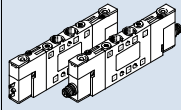
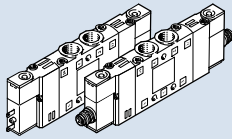
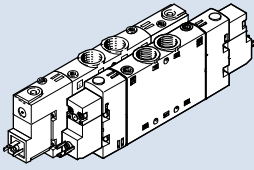
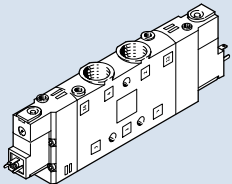
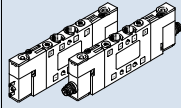
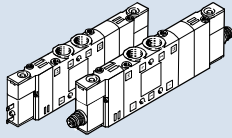
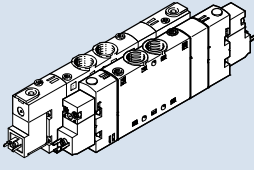
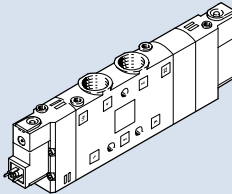
5/2-way valves, double solenoid					
					
Type	CPE10	CPE14	CPE18	CPE24	
Width	10 mm	14 mm	18 mm	24 mm	
Standard nominal flow rate [l/min]					
Thread	M5	180	-	-	
	M7	350	-	-	
	G1/8	-	800	-	
	G1/4	-	-	1300	
	G3/8	-	-	-	3200
Push-in connector	QS-4	180	-	-	
	QS-6	320	400	-	
	QS-8	-	680	850	-
	QS-10	-	-	1000	1250
	QS-12	-	-	-	1650
5/3-way valves					
					
Type	CPE10	CPE14	CPE18	CPE24	
Width	10 mm	14 mm	18 mm	24 mm	
Standard nominal flow rate [l/min]					
Thread	M5	180	-	-	
	M7	250 ... 350	-	-	
	G1/8	-	700 ... 750	-	
	G1/4	-	-	1200 ... 1450	
	G3/8	-	-	-	2600 ... 3000
Push-in connector	QS-4	180	-	-	
	QS-6	250 ... 300	370 ... 410	-	
	QS-8	-	570 ... 720	780 ... 850	-
	QS-10	-	-	1000 ... 1050	1250
	QS-12	-	-	-	1600 ... 1650
Operating voltage					
12 V DC	-	-	■	-	
24 V DC/AC	■/-	■/-	■/■	■/-	
110 V AC	-	-	■	■	
230 V AC	-	-	■	■	
Technical data → page	19	34	51	72	

Solenoid valves CPE, Compact Performance

Peripherals overview

FESTO

Individual valve – CPE10 and CPE14

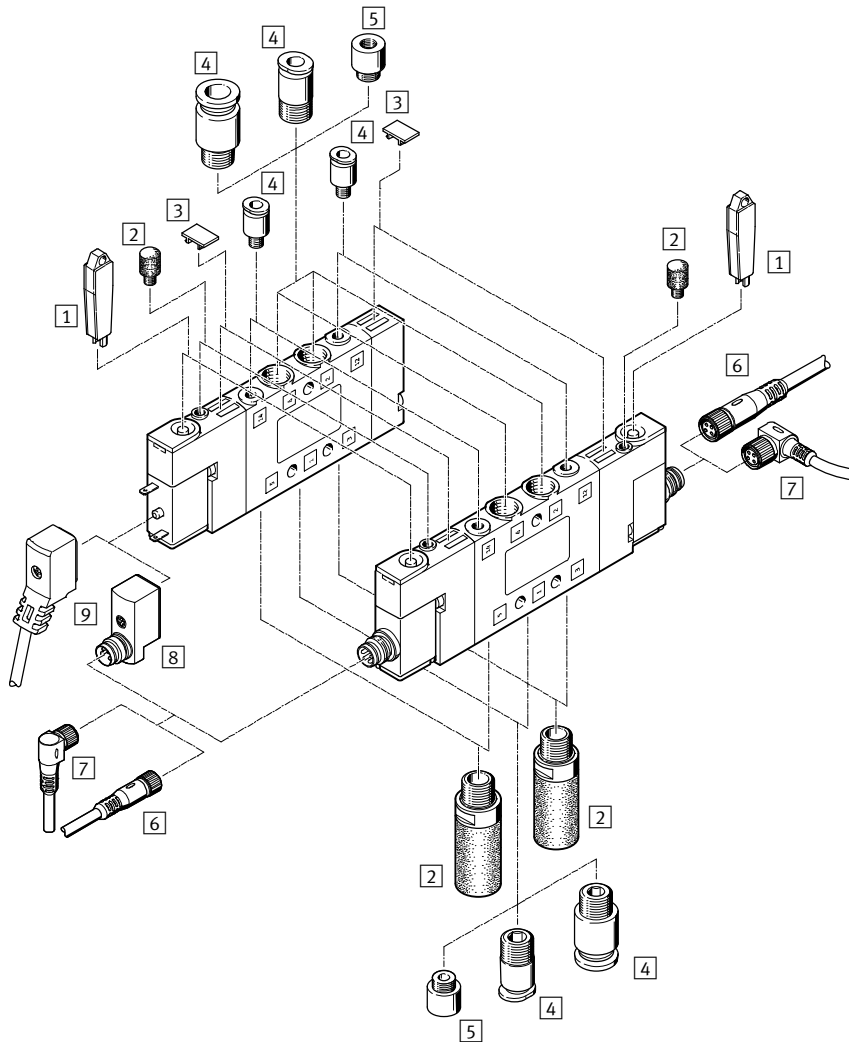

Accessories – Individual valve

	Type	Description	CPE10	CPE14	→ Page/Internet
1	Manual override tool	AHB...	■	■	83
2	Silencer	U... or UC...	■	■	83
3	Inscription label	IBS-6x10	■	■	83
4	Push-in fittings	QS...	■	■	qs
5	M7 to M5 reducer	–	■	–	–
6	Connecting cable	NEBU-M8G...	■	■	82
7	Connecting cable	NEBU-M8W...	■	■	82
8	Adapter	VAVE-C8...	■	■	82
9	Connecting cable	NEBV-Z4...	■	■	82
–	2 to 1 distributor	NEDY...	■	■	82

Solenoid valves CPE, Compact Performance

Peripherals overview

Individual valve – CPE18 and CPE24

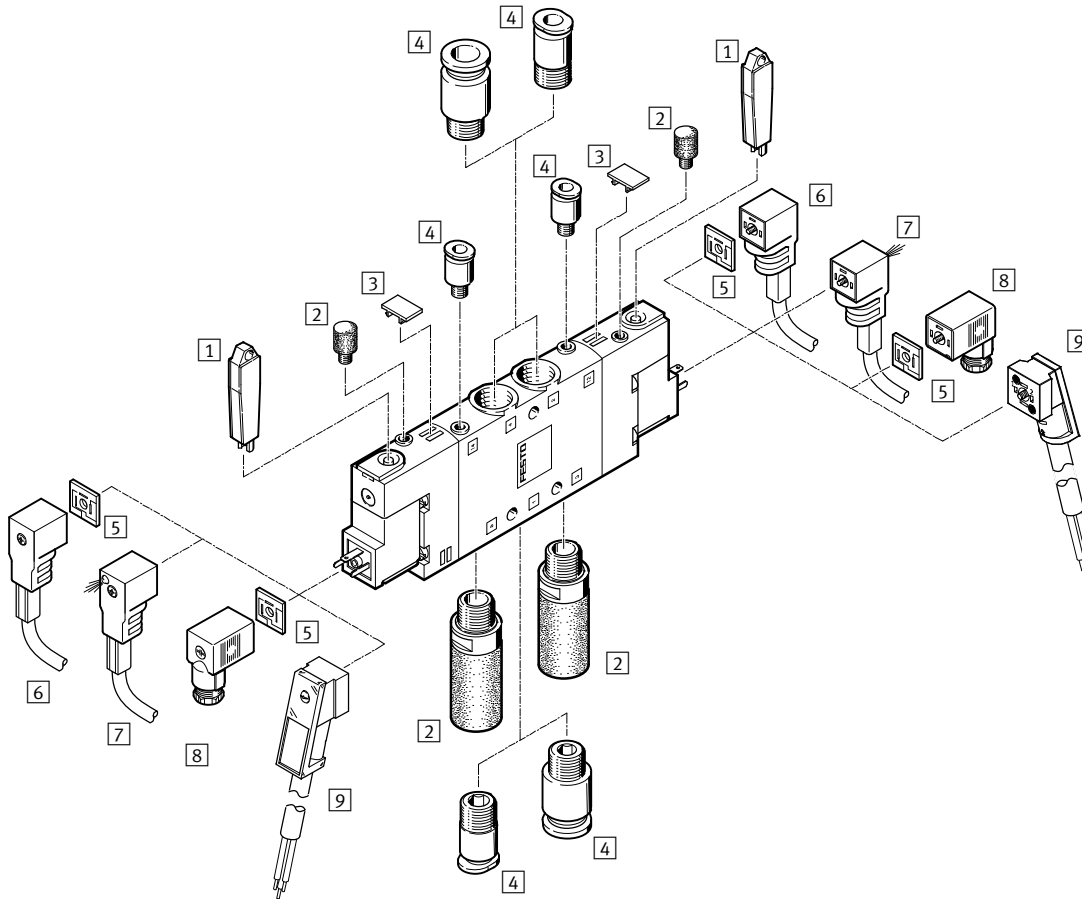

Accessories – Individual valve					
	Type	Description	CPE18	CPE24	→ Page/Internet
1	Manual override tool	AHB...	■	■	83
2	Silencer	U... or UC...	■	■	83
3	Inscription label	IBS-6x10	■	■	83
4	Push-in fittings	QS...	■	■	qs
5	Illuminating seal	MEB...LD	■	■	83
6	Plug socket with cable	KMEB-1...	■	■	83
7	Plug socket with cable	KMEB-1...	■	■	83
8	Plug socket	MSSD-EB...	■	■	83
9	Plug socket with cable	KMEB-2...	■	■	83

Solenoid valves CPE, Compact Performance

System overview

FESTO

Fixed-grid manifold assembly

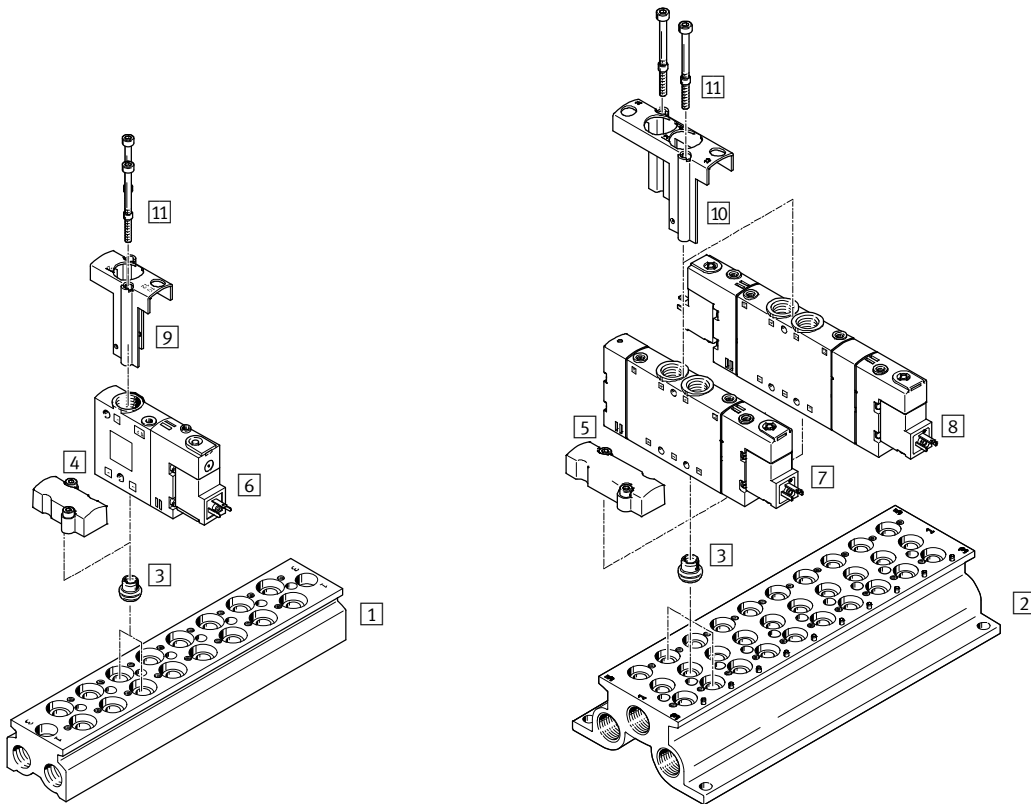

Example of manifold assembly – CPE18

	Type	Description	→ Page/Internet		
			CPE10	CPE14	CPE18
1	Manifold block	CPE18-3/2-PRS... For 3/2-way valves	30	47	68
2	Manifold block	CPE18-PRS... For 5/2- and 5/3-way valves	28	45	66
3	Seal	CPV18-VI-P.1/4-150 –	28	45	68
4	Cover plate	CPE18-RP3 For fitting on unused 3/2-way valve positions	30	47	68
5	Cover plate	CPE18-RP For fitting on unused 5/2- and 5/3-way valve positions	28	45	66
6	3/2-way valve	CPE18... –	25	42	57
7	5/2-way valve	CPE18... –	25	42	58
8	5/3-way valve	CPE18... –	26	43	59
9	Retainer	CPE18-H3-50 Retainer for 3/2-way valve	30	47	68
10	Retainer	CPE18-H5-50 Retainer for 5/2- and 5/3-way valve	28	45	66
11	Screw	M4X65-8.8-VS-100 –	28	45	68

Solenoid valves CPE, Compact Performance

Peripherals overview

FESTO

Accessories – Fixed-grid manifold assembly CPE10 and CPE14

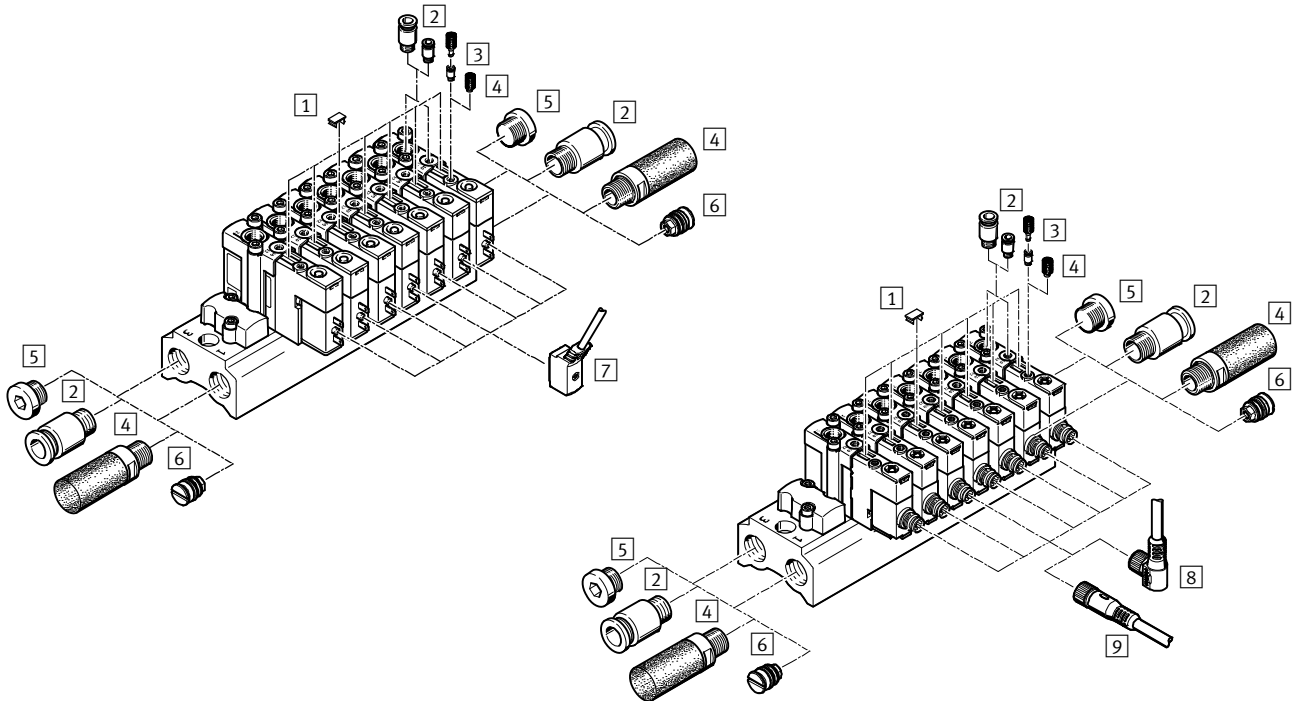

Accessories		Type	Description	CPE10	CPE14	→ Page/Internet
1	Inscription label	IBS-6x10	–	■	■	83
2	Push-in fittings	QS...	For tubing	■	■	qs
3	M7 to M5 reducer	–	Included in the scope of delivery	■	–	–
4	Silencer	U... or UC...	For port 3, 5, 82 or 84	■	■	83
5	Blanking plug	B...	–	■	■	83
6	Separator	VABD..., PRSV...	For fitting on the manifold block	■	■	83
7	Connecting cable	NEBV-Z4...	Connection pattern ZC holding current reduction, protective circuit, signal status display	■	■	82
8	Connecting cable	NEBU-M8W...	Socket M8x1, angled	■	■	82
9	Connecting cable	NEBU-M8G...	Socket M8x1, straight	■	■	82
–	2 to 1 distributor	NEDY...	2x socket connection pattern ZC on 1x plug, M8x1 or M12x1	■	■	82

Solenoid valves CPE, Compact Performance

Peripherals overview

FESTO

Accessories – Fixed-grid manifold assembly CPE18

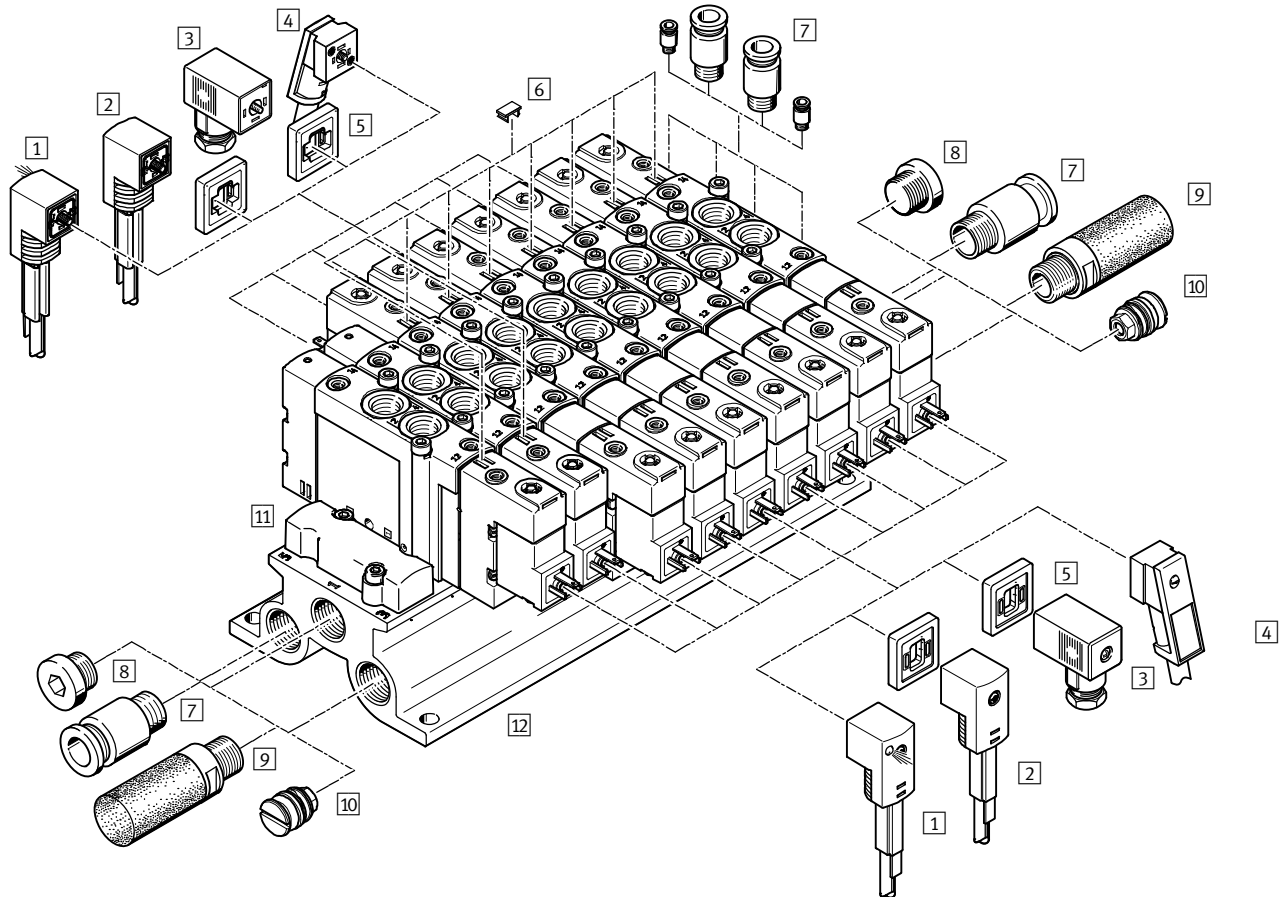

Accessories – Mounting on manifold block

	Type	Description	→ Page/Internet
1	KMEB-1...	Cable sheath PVC, 24 V DC, with signal status display	83
2	KMEB-1...	Cable sheath PVC, to 240 V, without signal status display	83
3	MSSD-EB...	Without signal status display	83
4	KMEB-2...	Cable sheath PUR	83
5	MEB-LD...	For 12 ... 24 V DC and 0 ... 230 V AC	83
6	IBS-6x10	–	83
7	QS...	For tubing	qs
8	B...	–	83
9	U... or UC...	For mounting in exhaust ports	83
10	VABD..., PRSV...	For fitting on the manifold block	83
11	CPE18-RP	For fitting on unused valve 5/2- and 5/3-way positions	66
	CPE18-RP3	For fitting on unused 5/2- and 5/3-way valve positions	68
12	CPE18-PRS...	For 5/2- and 5/3-way valves	66
	CPE18-3/2-PRS...	For 3/2-way valves	68

Solenoid valves CPE, Compact Performance

System overview

FESTO

Manifold assembly with modular manifold blocks

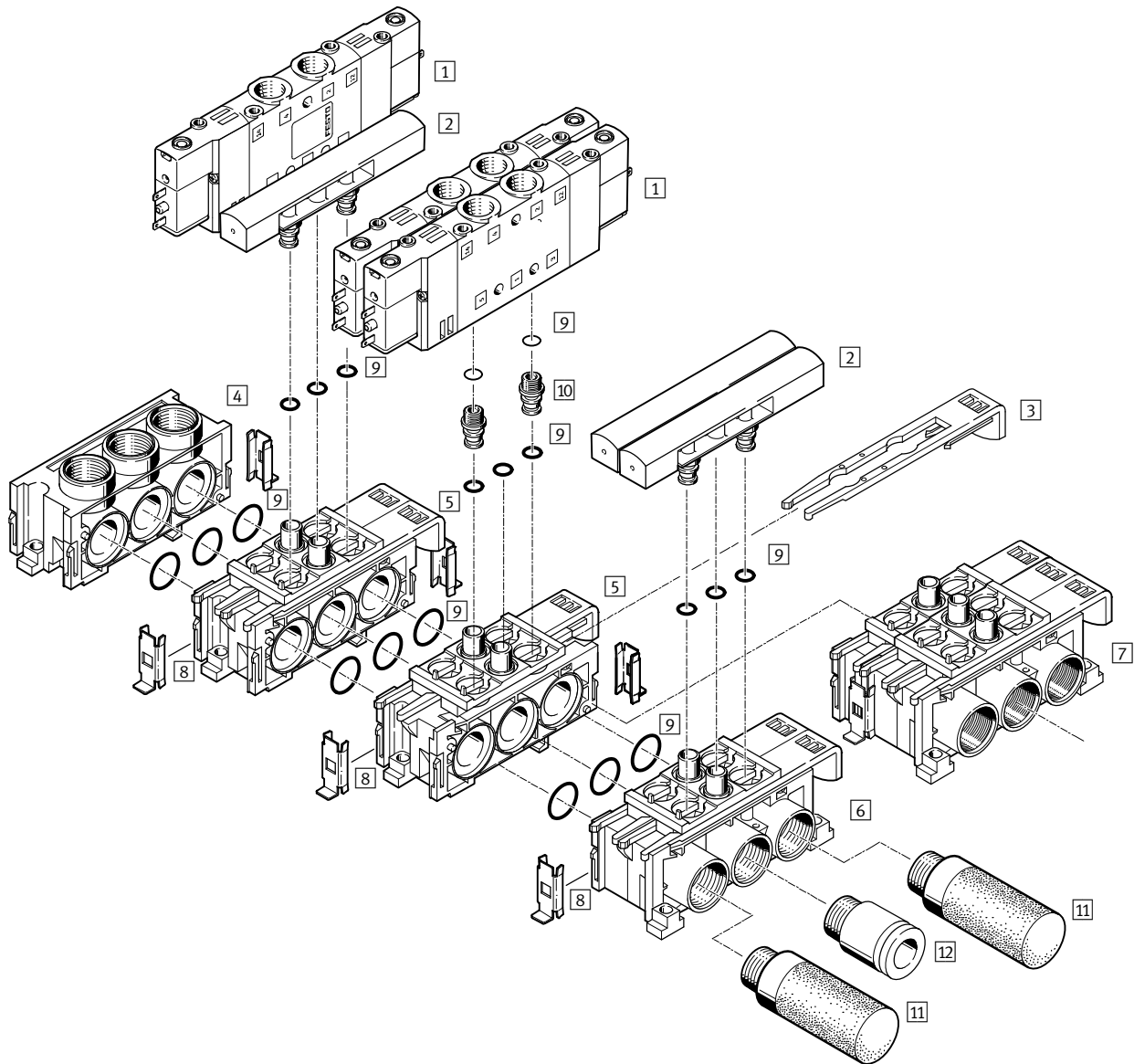

Accessories – Manifold assembly

	Type	Description	→ Page/Internet
1	Solenoid valve	CPE...	–
2	Cover plate	CPE...-RP	For sealing vacant positions
3	Slide	–	For mounting the valve
4	End plate	CPE...-PRS-EP	–
5	Expansion block	CPE...-PRSE-2	For 2 valves
6	Manifold block	CPE...-PRSG-2	For 2 valves
7	Manifold block	CPE...-PRSG-3	For 3 valves
8	Connecting piece	–	For connecting the blocks
9	Seal	–	Included in the scope of delivery
10	Fitting	–	Included in the scope of delivery
11	Silencer	U or UC	–
12	Push-in fitting	QS...	For tubing

Solenoid valves CPE, Compact Performance

Order codes

CPE		-	M	-				-			
Type											
CPE	Solenoid valve, Compact Performance										
Width											
10	10 mm										
14	14 mm										
18	18 mm										
24	24 mm										
Operating voltage											
Electrical connection: plug pins, connection pattern ZC											
M1BH	24 V DC for CPE10 and CPE14										
M1H	24 V DC for CPE18 and CPE24										
M2H	110 V AC for CPE18 and CPE24										
M3H	230 V AC for CPE18 and CPE24										
Electrical connection: plug M8x1											
M1CH	24 V DC for CPE10 and CPE14										
Valve function											
3	3/2-way										
5L	5/2-way, single solenoid, pneumatic reset										
5J	5/2-way, double solenoid										
5/3	5/3-way										
Normal position											
GL	Closed, pneumatic reset for 3/2										
OL	Open, pneumatic reset										
B	Open										
E	Exhausted										
G	Closed										
Pilot air supply											
-	Internal										
S	External										
Pneumatic connection											
Female thread											
M5	M5 for CPE10, not with round plug										
M7	M7 for CPE10										
1/8	G1/8 for CPE14										
1/4	G1/4 for CPE18										
3/8	G3/8 for CPE24										
Plug connector for standard O.D. tubing, not with round plug CPE10 and CPE14											
QS-4	Tubing O.D. 4 mm for CPE10										
QS-6	Tubing O.D. 6 mm for CPE10 and CPE14										
QS-8	Tubing O.D. 8 mm for CPE14 and CPE18										
QS-10	Tubing O.D. 10 mm for CPE18 and CPE24										
QS-12	Tubing O.D. 12 mm for CPE24										
Generation											
B	B series for CPE10 5/3-way valve										

Solenoid valves CPE10

Technical data

Function
 3/2G, 3/2O
 5/2-way, single solenoid,
 5/2-way, double solenoid valve
 5/3G, 5/3B, 5/3E

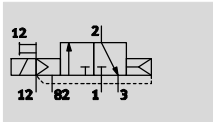

e.g. 3/2-way valve with external pilot air supply, normally closed

- - Width 10 mm
- - Flow rate
180 ... 400 l/min
- - Voltage
24 V DC

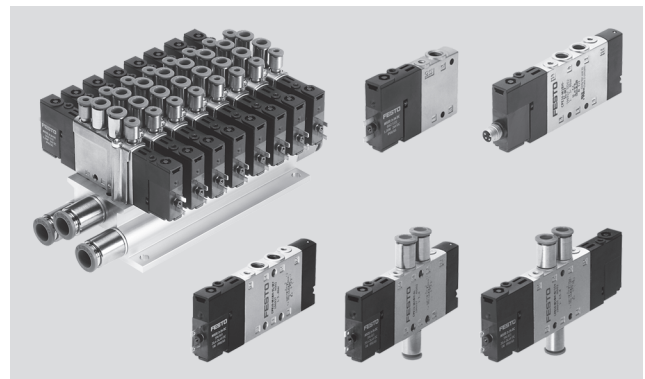

General technical data		3/2		5/2		5/3		
Valve function		G ¹⁾	O ²⁾	-	-	G ¹⁾	B ²⁾	E ³⁾
Stable position		Monostable			Bistable		Monostable	
Reset method: pneumatic spring		Yes			-		No	
Reset method: mechanical spring		No			-		Yes	
Design		Piston spool						
Sealing principle		Soft						
Lap		Overlap						
Type of actuation		Electrical						
Type of control		Pilot						
Pilot air supply		Internal or external						
Flow direction		-		Reversible with external pilot air supply				
Exhaust air function		-		With flow control				
Manual override		Non-detenting, detenting via accessory						
Type of mounting		Via through-holes						
Mounting position		Any						
Pneumatic connection	1, 2, 4	Threaded connection: M5, M7; QS connection: Ø 4 or Ø 6 mm						
	3, 5	Threaded connection: M7						
	12, 14	Threaded connection: M3; QS connection: Ø 3 mm						
	82, 84	Threaded connection: M3						
Nominal width	[mm]	4						
Standard nominal flow rate	M5	[l/min]	190		180			
	M7	[l/min]	400		350		300	250
	QS4	[l/min]	190		180			
	QS6	[l/min]	300		350		320	300
Switching time	On/off	[ms]	14/14		16/20		-	
	Changeover	[ms]	-		8		-	
Duty cycle	[%]	100						
Width	[mm]	10						
Corrosion resistance class CRC ⁴⁾		2						

1) G = normally closed

2) O, B = normally open

3) E = normally exhausted

4) Corrosion resistance class CRC 2 to Festo standard FN 940070

Moderate corrosion stress. Indoor applications in which condensation may occur. External visible parts with primarily decorative requirements for the surface and which are in direct contact with the ambient atmosphere typical for industrial applications.

Solenoid valves CPE10

Technical data

Operating and environmental conditions				
Valve function		3/2	5/2-way, single solenoid	5/2-way, double solenoid
Operating medium	Compressed air to ISO 8573-1:2010 [7:4:4]			
Pilot medium	Compressed air to ISO 8573-1:2010 [7:4:4]			
Note on operating/pilot medium	Lubricated operation possible (in which case lubricated operation will always be required)			
Operating pressure	Internal pilot air supply	[bar]	2.5 ... 8	3 ... 8
	External pilot air supply	[bar]	-0.9 ... +10	
Pilot pressure	[bar]	2.5 ... 8	3 ... 8	
Ambient temperature	[°C]	-5 ... +50		
Temperature of medium	[°C]	-5 ... +50		
Certification for solenoid valves	c UL us - Recognized (OL) (not with M1CH-...)			
Maritime classification ¹⁾	See certificate			

1) Additional information www.festo.com/sp → Certificates.

Electrical data			
Operating voltage	M1BH, M1CH	[V DC]	24 +10/-15%
Power consumption	M1BH, M1CH	[W]	1.28
Degree of protection with plug socket	IP65 to IEC 60529 M1CH: IP65/IP67 to IEC 60529		
Max. tightening torque of plug socket M8x1	M1CH	[Nm]	0.4

Materials

Sectional view

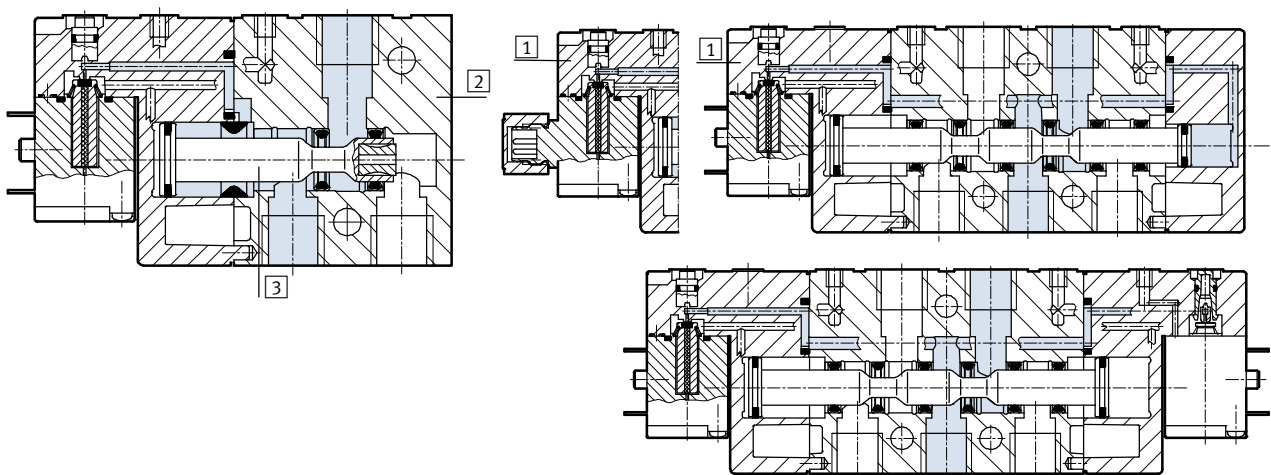

1	Cap	PA
2	Housing	Die-cast aluminium
3	Piston spool	Steel
-	Seals	NBR
	Note on materials	RoHS compliant

Solenoid valves CPE10

Technical data

Dimensions – 3/2-way valve

Download CAD data → www.festo.com

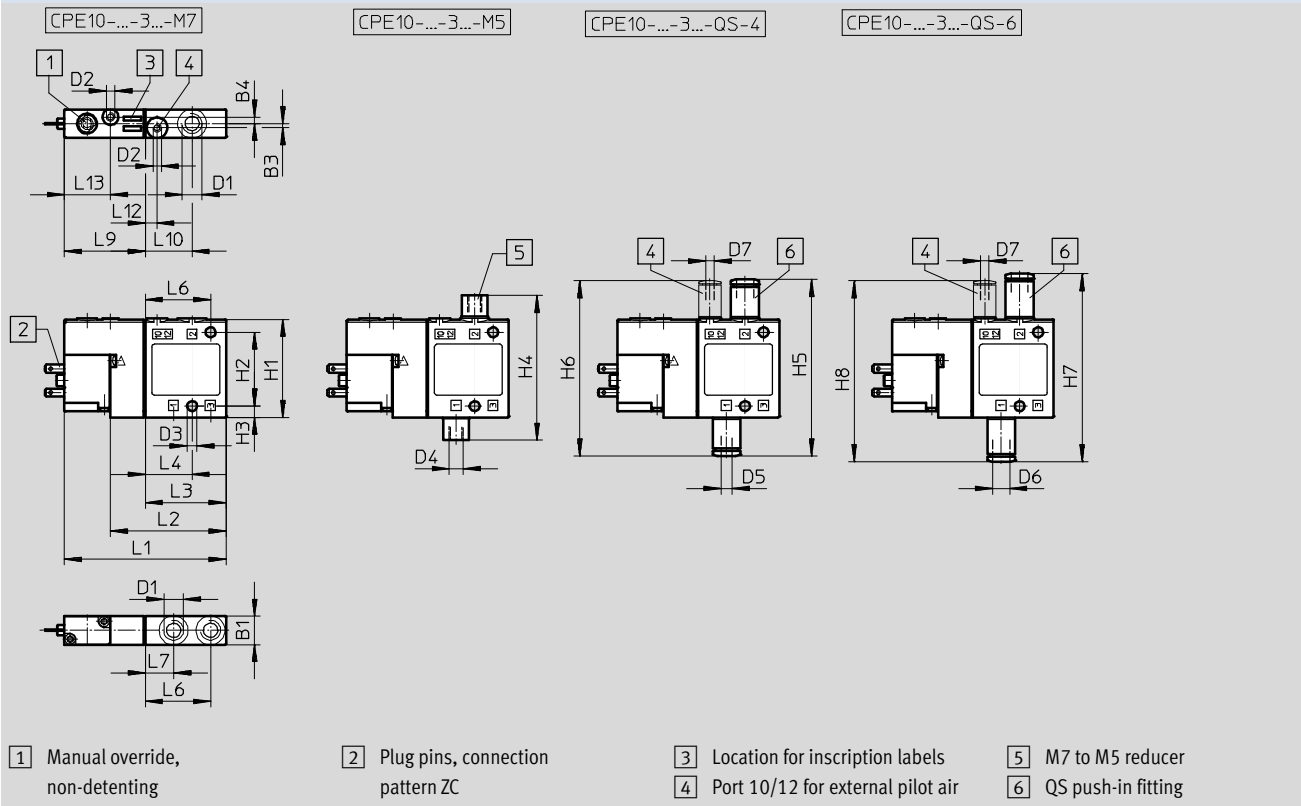

Type	B1	B3	B4	D1	D2	D3 ∅	D4	D5 ∅	D6 ∅	D7 ∅	H1	H2	H3	H4	H5	H6	H7	H8
CPE10-M1BH-3...	10	1.5	2.3	M7	M3	3.5	M5	4	6	3	35	26	4	51	62.2	61.7	66.2	63.7

Type	L1	L2	L3	L4	L6	L7	L9	L10	L12	L13
CPE10-M1BH-3...	57	40.8	28.5	16.5	23	10	28.5	16.5	4.2	16.3

Solenoid valves CPE10

Technical data

FESTO

Dimensions – 5/2-way single solenoid valve

Download CAD data → www.festo.com

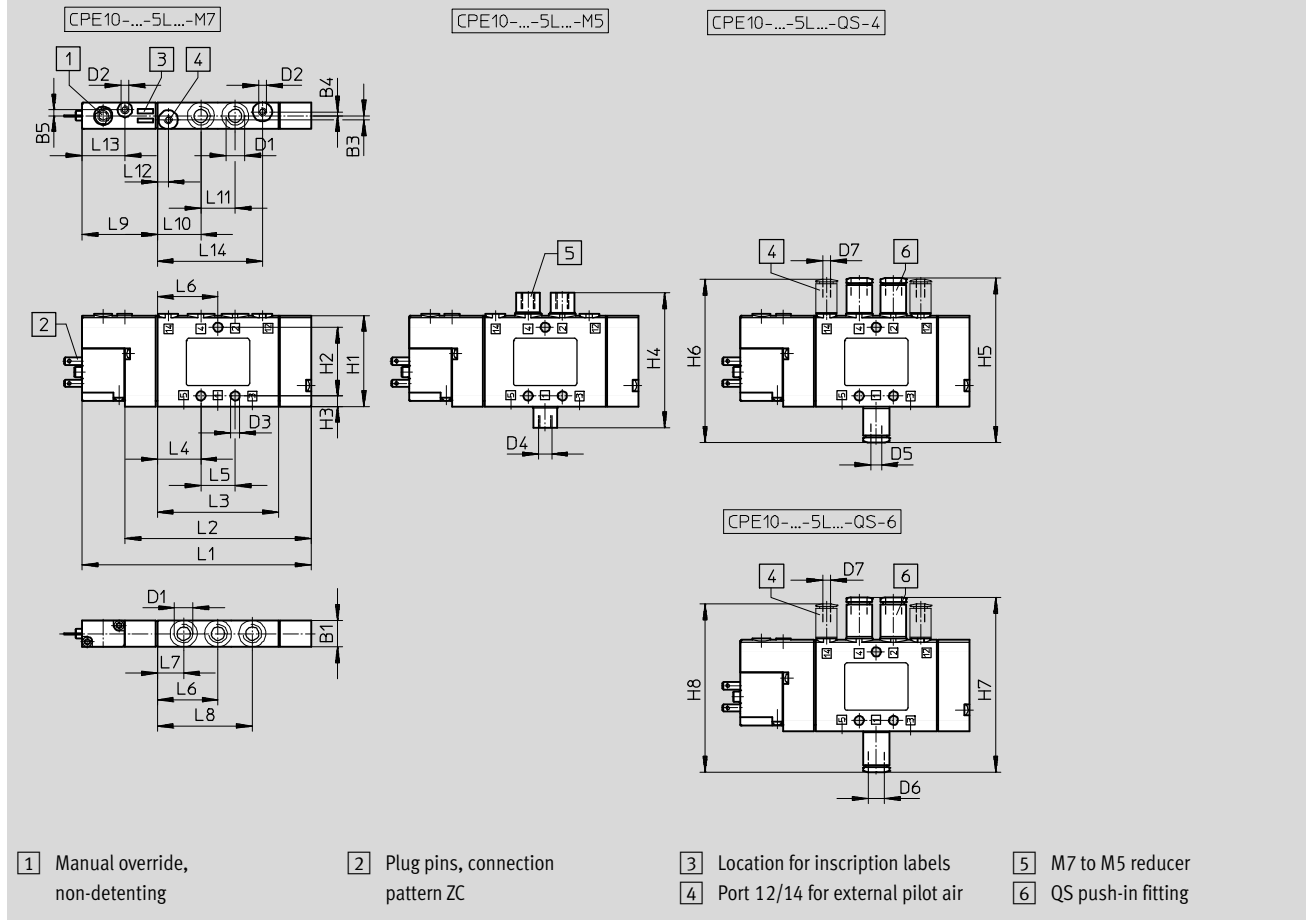

Type	B1	B3	B4	B5	D1	D2	D3	D4	D5	D6	D7	H1	H2	H3	H4	H5	H6	H7	H8
CPE10-M1BH-5L...	10	1.5	1.5	2.3	M7	M3	3.5	M5	4	6	3	35	26	4	51	62.2	61.7	66.2	63.7

Type	L1	L2	L3	L4	L5	L6	L7	L8	L9	L10	L11	L12	L13	L14
CPE10-M1BH-5L...	86.8	70.6	46	16.5	13	23	10	36	28.5	16.5	13	4.2	16.3	39.8

Solenoid valves CPE10

Technical data

Dimensions – 5/2-way double solenoid valve and 5/3-way valve

Download CAD data → www.festo.com

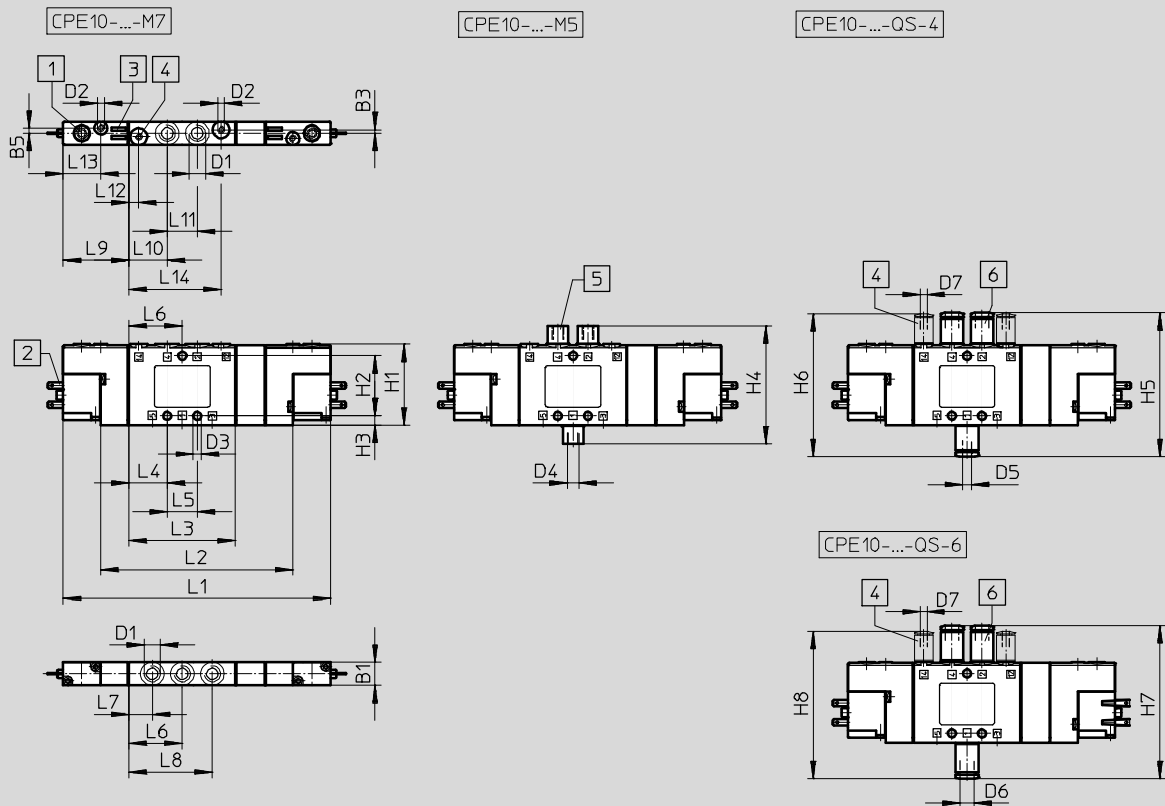

- 1 Manual override, non-detenting
- 2 Plug pins, connection pattern ZC
- 3 Location for inscription labels
- 4 Port 12/14 for external pilot air
- 5 M7 to M5 reducer
- 6 QS push-in fitting

Type	B1	B3	B5	D1	D2	D3 ∅	D4	D5 ∅	D6 ∅	D7 ∅	H1	H2	H3	H4	H5	H6	H7	H8
CPE-10-...-5]	10	1.5	2.3	M7	M3	3.5	M5	4	6	3	35	26	4	51	62.2	61.7	66.2	63.7
CPE-10-...-5/3																		

Type	L1	L2	L3	L4	L5	L6	L7	L8	L9	L10	L11	L12	L13	L14
CPE-10-...-5]	103	70.6	46	16.5	13	23	10	36	28.5	16.5	13	4.2	16.3	39.8
CPE-10-...-5/3	115.6	83.2												

Solenoid valves CPE10

Technical data

FESTO

Dimensions – Solenoid valves with round plug M8x1

Download CAD data → www.festo.com

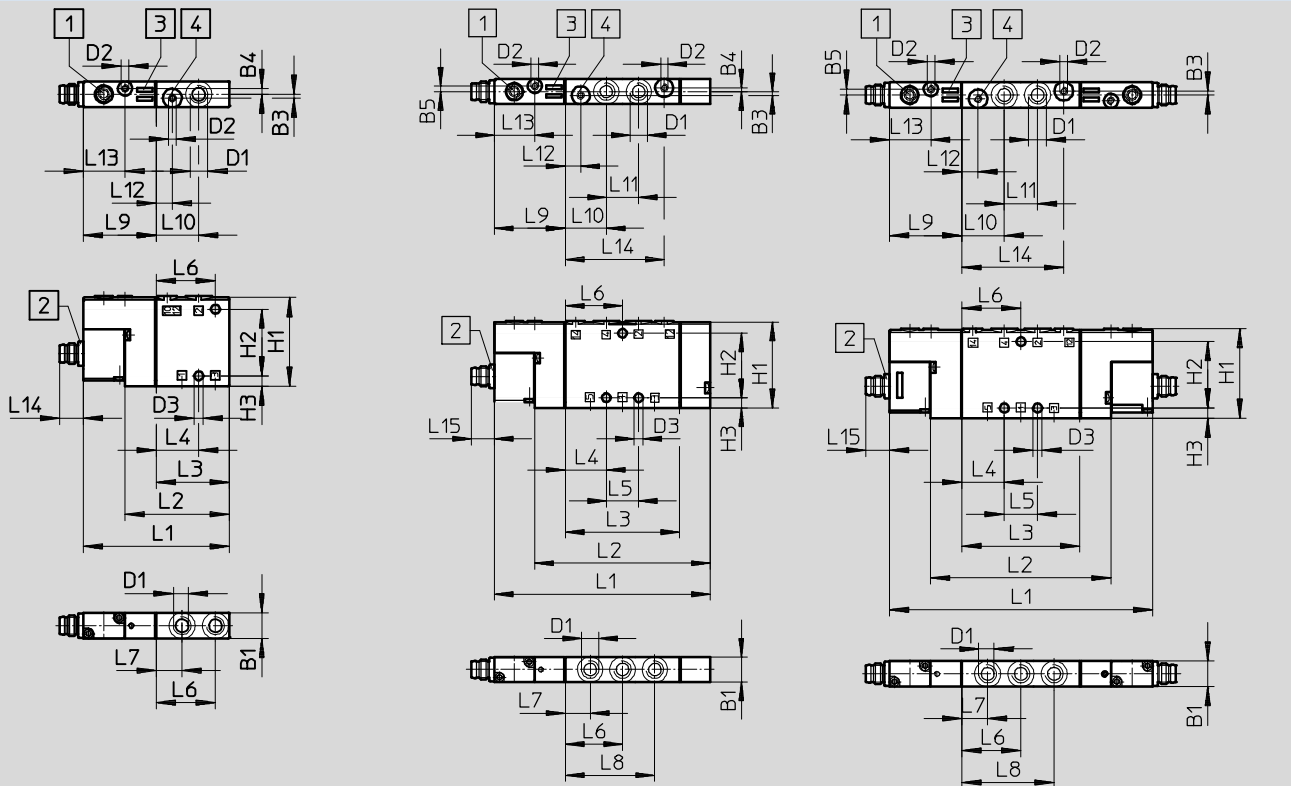

1 Manual override, non-detenting

2 Plug M8x1

3 Location for inscription labels

4 Port 12/14 for external pilot air

Type	B1	B3	B4	B5	D1	D2	D3 ∅	H1	H2	H3
CPE-10-M1CH-3...	10	1.5	2.3	-	M7	M3	3.5	35	26	4
CPE-10-M1CH-5L...			1.5	2.3						
CPE-10-M1CH-5J...			-							

Type	L1	L2	L3	L4	L5	L6	L7	L8	L9	L10	L11	L12	L13	L14	L15
CPE-10-M1CH-3...	57	40.8	28.5	16.5	-	23	10	-	28.5	16.5	-	6.2	16.3	9.2	-
CPE-10-M1CH-5L...	86.8	70.6	46		13			36			13			39.82	9.2
CPE-10-M1CH-5J...	103														

Solenoid valves CPE10

Ordering data

Ordering data						
Circuit symbol	Pilot air supply	Electrical connection	Operating voltage	Pneumatic connection	Weight [g]	Part No. Type
3/2-way valve, normally closed						
	Internal	Plug pins, connection pattern ZC	24 V DC	M5	–	196845 CPE10-M1BH-3GL-M5
				M7	40	196915 CPE10-M1BH-3GL-M7
		QS-4		–	196846 CPE10-M1BH-3GL-QS-4	
		QS-6		–	196847 CPE10-M1BH-3GL-QS-6	
		Plug connector M8x1		M7	40	550233 CPE10-M1CH-3GL-M7
3/2-way valve, normally open						
	Internal	Plug pins, connection pattern ZC	24 V DC	M5	–	196851 CPE10-M1BH-3OL-M5
				M7	40	196917 CPE10-M1BH-3OL-M7
		QS-4		–	196852 CPE10-M1BH-3OL-QS-4	
		QS-6		–	196853 CPE10-M1BH-3OL-QS-6	
		Plug connector M8x1		M7	40	550235 CPE10-M1CH-3OL-M7
3/2-way valve, normally closed						
	External	Plug pins, connection pattern ZC	24 V DC	M5	–	196848 CPE10-M1BH-3GLS-M5
				M7	40	196916 CPE10-M1BH-3GLS-M7
		QS-4		–	196849 CPE10-M1BH-3GLS-QS-4	
		QS-6		–	196850 CPE10-M1BH-3GLS-QS-6	
		Plug connector M8x1		M7	40	550234 CPE10-M1CH-3GLS-M7
3/2-way valve, normally open						
	External	Plug pins, connection pattern ZC	24 V DC	M5	–	196854 CPE10-M1BH-3OLS-M5
				M7	40	196918 CPE10-M1BH-3OLS-M7
		QS-4		–	196855 CPE10-M1BH-3OLS-QS-4	
		QS-6		–	196856 CPE10-M1BH-3OLS-QS-6	
		Plug connector M8x1		M7	40	550236 CPE10-M1CH-3OLS-M7
5/2 way valve, single solenoid						
	Internal	Plug pins, connection pattern ZC	24 V DC	M5	–	196881 CPE10-M1BH-5L-M5
				M7	56	196927 CPE10-M1BH-5L-M7
		QS-4		–	196882 CPE10-M1BH-5L-QS-4	
		QS-6		–	196883 CPE10-M1BH-5L-QS-6	
		Plug connector M8x1		M7	56	550223 CPE10-M1CH-5L-M7
5/2-way valve, double solenoid						
	Internal	Plug pins, connection pattern ZC	24 V DC	M5	–	196875 CPE10-M1BH-5J-M5
				M7	68	196925 CPE10-M1BH-5J-M7
		QS-4		–	196876 CPE10-M1BH-5J-QS-4	
		QS-6		–	196877 CPE10-M1BH-5J-QS-6	
		Plug connector M8x1		M7	68	550225 CPE10-M1CH-5J-M7
5/2 way valve, single solenoid						
	External	Plug pins, connection pattern ZC	24 V DC	M5	–	196884 CPE10-M1BH-5LS-M5
				M7	56	196928 CPE10-M1BH-5LS-M7
		QS-4		–	196885 CPE10-M1BH-5LS-QS-4	
		QS-6		–	196886 CPE10-M1BH-5LS-QS-6	
		Plug connector M8x1		M7	56	550224 CPE10-M1CH-5LS-M7

Solenoid valves CPE10

FESTO

Ordering data

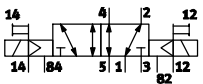
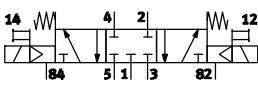
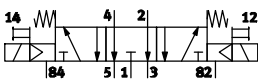
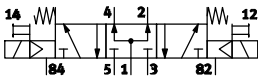
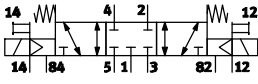
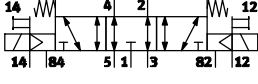
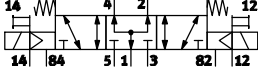
Ordering data							
Circuit symbol	Pilot air supply	Electrical connection	Operating voltage	Pneumatic connection	Weight [g]	Part No.	Type
5/2-way valve, double solenoid							
	External	Plug pins, connection pattern ZC	24 V DC	M5	–	196878	CPE10-M1BH-5JS-M5
				M7	68	196926	CPE10-M1BH-5JS-M7
				QS-4	–	196879	CPE10-M1BH-5JS-QS-4
				QS-6	–	196880	CPE10-M1BH-5JS-QS-6
		Plug connector M8x1	M7	68	550226	CPE10-M1CH-5JS-M7	
5/3-way mid-position valve, normally closed							
	Internal	Plug pins, connection pattern ZC	24 V DC	M5	–	533159	CPE10-M1BH-5/3G-M5-B
				M7	68	533141	CPE10-M1BH-5/3G-M7-B
				QS-4	–	533147	CPE10-M1BH-5/3G-QS-4-B
				QS-6	–	533153	CPE10-M1BH-5/3G-QS-6-B
		Plug connector M8x1	M7	68	550227	CPE10-M1CH-5/3G-M7	
5/3-way mid-position valve, normally exhausted							
	Internal	Plug pins, connection pattern ZC	24 V DC	M5	–	533161	CPE10-M1BH-5/3E-M5-B
				M7	68	533143	CPE10-M1BH-5/3E-M7-B
				QS-4	–	533149	CPE10-M1BH-5/3E-QS-4-B
				QS-6	–	533155	CPE10-M1BH-5/3E-QS-6-B
		Plug connector M8x1	M7	68	550229	CPE10-M1CH-5/3E-M7	
5/3-way mid-position valve, normally open							
	Internal	Plug pins, connection pattern ZC	24 V DC	M5	–	533163	CPE10-M1BH-5/3B-M5-B
				M7	68	533145	CPE10-M1BH-5/3B-M7-B
				QS-4	–	533151	CPE10-M1BH-5/3B-QS-4-B
				QS-6	–	533157	CPE10-M1BH-5/3B-QS-6-B
		Plug connector M8x1	M7	68	550231	CPE10-M1CH-5/3B-M7	
5/3-way mid-position valve, normally closed							
	External	Plug pins, connection pattern ZC	24 V DC	M5	–	533160	CPE10-M1BH-5/3GS-M5-B
				M7	68	533142	CPE10-M1BH-5/3GS-M7-B
				QS-4	–	533148	CPE10-M1BH-5/3GS-QS-4-B
				QS-6	–	533154	CPE10-M1BH-5/3GS-QS-6-B
		Plug connector M8x1	M7	68	550228	CPE10-M1CH-5/3GS-M7	
5/3-way mid-position valve, normally exhausted							
	External	Plug pins, connection pattern ZC	24 V DC	M5	–	533162	CPE10-M1BH-5/3ES-M5-B
				M7	68	533144	CPE10-M1BH-5/3ES-M7-B
				QS-4	–	533150	CPE10-M1BH-5/3ES-QS-4-B
				QS-6	–	533156	CPE10-M1BH-5/3ES-QS-6-B
		Plug connector M8x1	M7	68	550230	CPE10-M1CH-5/3ES-M7	
5/3-way mid-position valve, normally open							
	External	Plug pins, connection pattern ZC	24 V DC	M5	–	533164	CPE10-M1BH-5/3BS-M5-B
				M7	68	533146	CPE10-M1BH-5/3BS-M7-B
				QS-4	–	533152	CPE10-M1BH-5/3BS-QS-4-B
				QS-6	–	533158	CPE10-M1BH-5/3BS-QS-6-B
		Plug connector M8x1	M7	68	550232	CPE10-M1CH-5/3BS-M7	

Manifold blocks CPE10

Technical data – Manifold block



Manifold block CPE...-PRS

Materials:

Wrought aluminium alloy

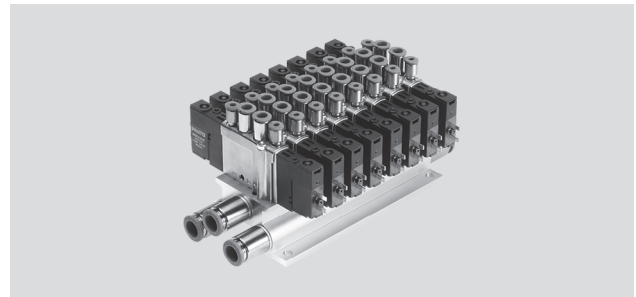

Dimensions – Fixed-grid manifold 5/2 and 5/3

Download CAD data → www.festo.com

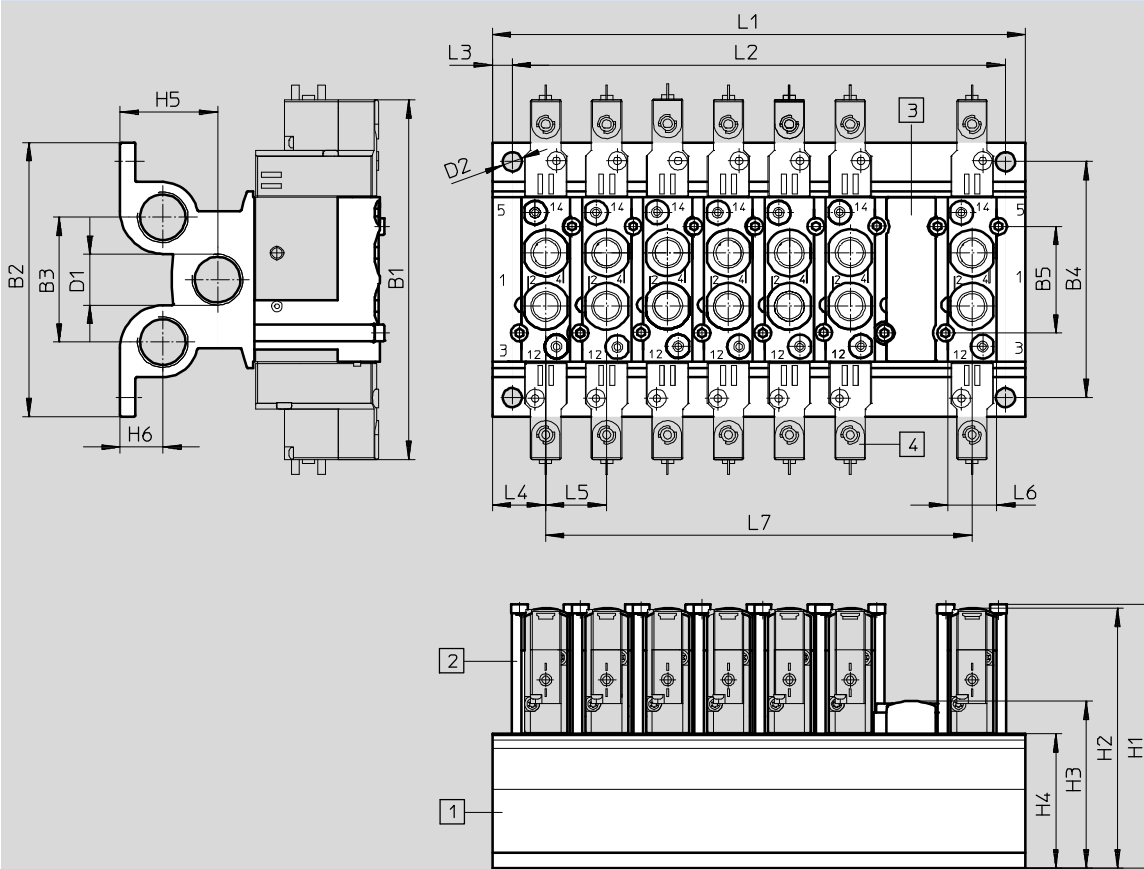

- 1 Manifold block
- 2 Retainer
- 3 Cover plate
- 4 Valves

Type	B1	B2	B3	B4	B5	D1	D2	H1	H2	H3	H4	H5	H6
CPE10-PRS...	103	79	35	67.5	26	G1/4	5.3	72	69.5	44.8	34	23.5	11

Type	L1	L2	L3	L4	L5	L6	L7
CPE10-PRS...	28 + (n-1) x 16	L1 - 11 ± 0.1	5.5	14	16	13.4	(n-1) x 16

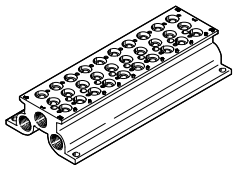

Manifold blocks CPE10

Ordering data – Fixed-grid manifold block

Ordering data						
	Valve positions	CRC ¹⁾	Max. tightening torque [Nm]	Weight [g]	Part No.	Type
Manifold block for 5/2- and 5/3-way valves						
	2	2	1.2	131	543821	CPE10-PRS-1/4-2
	3			179	543822	CPE10-PRS-1/4-3
	4			227	543823	CPE10-PRS-1/4-4
	5			275	543824	CPE10-PRS-1/4-5
	6			323	543825	CPE10-PRS-1/4-6
	7			371	543826	CPE10-PRS-1/4-7
	8			419	543827	CPE10-PRS-1/4-8
	9			467	543828	CPE10-PRS-1/4-9
	10			515	543829	CPE10-PRS-1/4-10

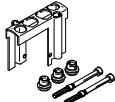
1) Corrosion resistance class CRC 2 to Festo standard FN 940070
 Moderate corrosion stress. Indoor applications in which condensation may occur. External visible parts with primarily decorative requirements for the surface and which are in direct contact with the ambient atmosphere typical for industrial applications.

Ordering data			
	Material	Part No.	Type
Blanking plate for unused valve position			
	PA	544479	CPE10-RP
Retainer set			
	Retainer: High-alloy stainless steel Screws: Galvanised steel Seals: NBR	544394	CPE10-H5-SET

Ordering data			
	Material	Part No.	Type
Retainer			
	Retainer: High-alloy stainless steel (packaging unit 50 pieces)	547045	CPE10-H5-50
Screws			
	Galvanised steel (packaging unit 100 pieces)	547048	M3X40-8.8-VS-100
Seals			
	NBR (packaging unit 150 pieces)	547051	CPV10-VI-P.M7-150

Manifold blocks CPE10

Technical data – Fixed-grid manifold block



Manifold block

For CPE10 3/2

Materials:

Wrought aluminium alloy

RoHS compliant

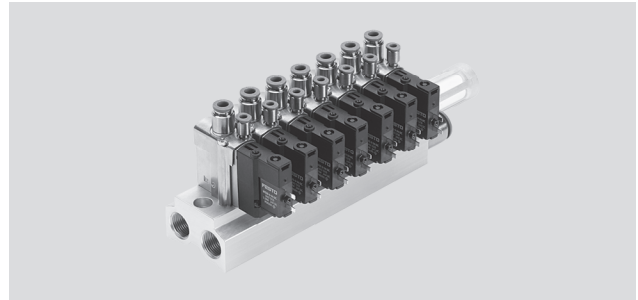

Dimensions – Fixed-grid manifold 3/2

Download CAD data → www.festo.com

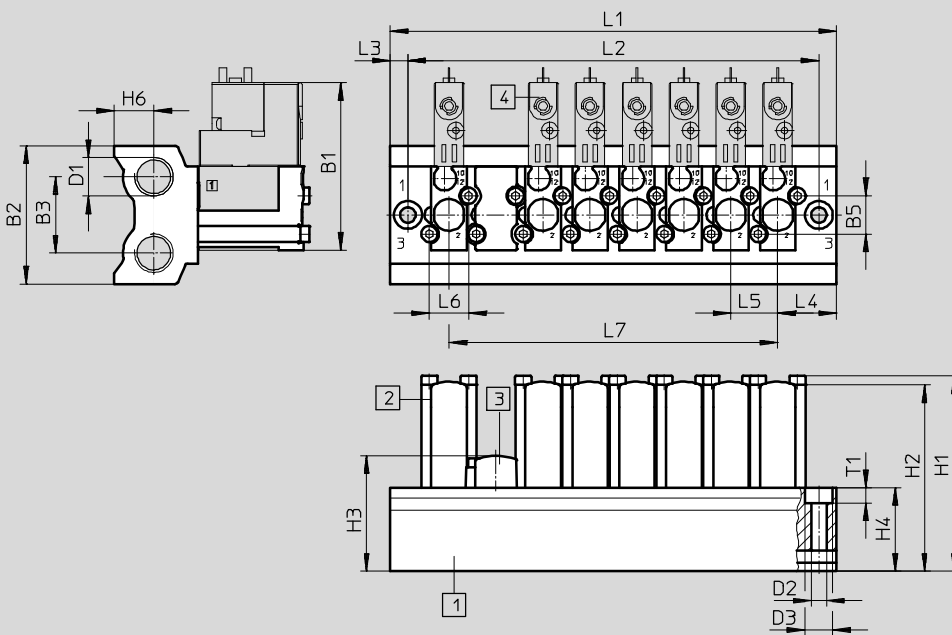

1 Manifold block 2 Retainer 3 Cover plate 4 Valves

Type	B1	B2	B3	B5	D1	D2	D3	H1	H2	H3	H4	H6
CPE10-3/2-PRS...	57	47	26	13	G1/4	5.3	9.5	66.5	63.5	39.3	28.5	13.5

Type	L1	L2	L3	L4	L5	L6	L7	T1
CPE10-3/2-PRS...	$40 + (n-1) \times 16$	$28 + (n-1) \times 16$	6	20	16	13.4	$(n-1) \times 16$	5.3

Manifold blocks CPE10

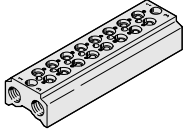

Ordering data – Fixed-grid manifold block

Ordering data						
	Valve positions	CRC ¹⁾	Max. tightening torque for valve mounting [Nm]	Weight [g]	Part No.	Type
Manifold block for 3/2-way valves						
	2	2	1.2	128	550550	CPE10-3/2-PRS-1/4-2
	3			164	550551	CPE10-3/2-PRS-1/4-3
	4			201	550552	CPE10-3/2-PRS-1/4-4
	5			237	550553	CPE10-3/2-PRS-1/4-5
	6			274	550554	CPE10-3/2-PRS-1/4-6
	7			310	550555	CPE10-3/2-PRS-1/4-7
	8			347	550556	CPE10-3/2-PRS-1/4-8
	9			383	550557	CPE10-3/2-PRS-1/4-9
	10			420	550558	CPE10-3/2-PRS-1/4-10

1) Corrosion resistance class CRC 2 to Festo standard FN 940070

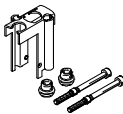
Moderate corrosion stress. Indoor applications in which condensation may occur. External visible parts with primarily decorative requirements for the surface and which are in direct contact with the ambient atmosphere typical for industrial applications.

Ordering data			
	Material	Part No.	Type
Cover plate			
	PA RoHS compliant	550580	CPE10-RP3
Retainer set			
	Retainer: High-alloy stainless steel Screws: Galvanised steel Seals: NBR RoHS compliant	550577	CPE10-H3-SET

Ordering data			
	Material	Part No.	Type
Retainer			
	Retainer: High-alloy stainless steel (packaging unit 50 pieces)	551490	CPE10-H3-50
Screws			
	Galvanised steel (packaging unit 100 pieces)	547048	M3X40-8.8-VS-100
Seals			
	NBR (packaging unit 150 pieces)	547051	CPV10-VI-P.M7-150

Manifold blocks CPE10

Technical data – Modular manifold

Modular manifold block
For CPE18 5/2 and 5/3

Materials:
PA, reinforced

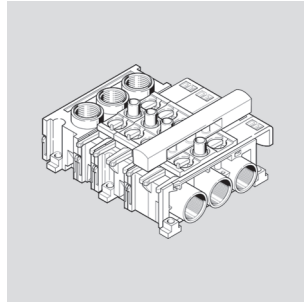

Dimensions – Modular manifold block

Download CAD data → www.festo.com

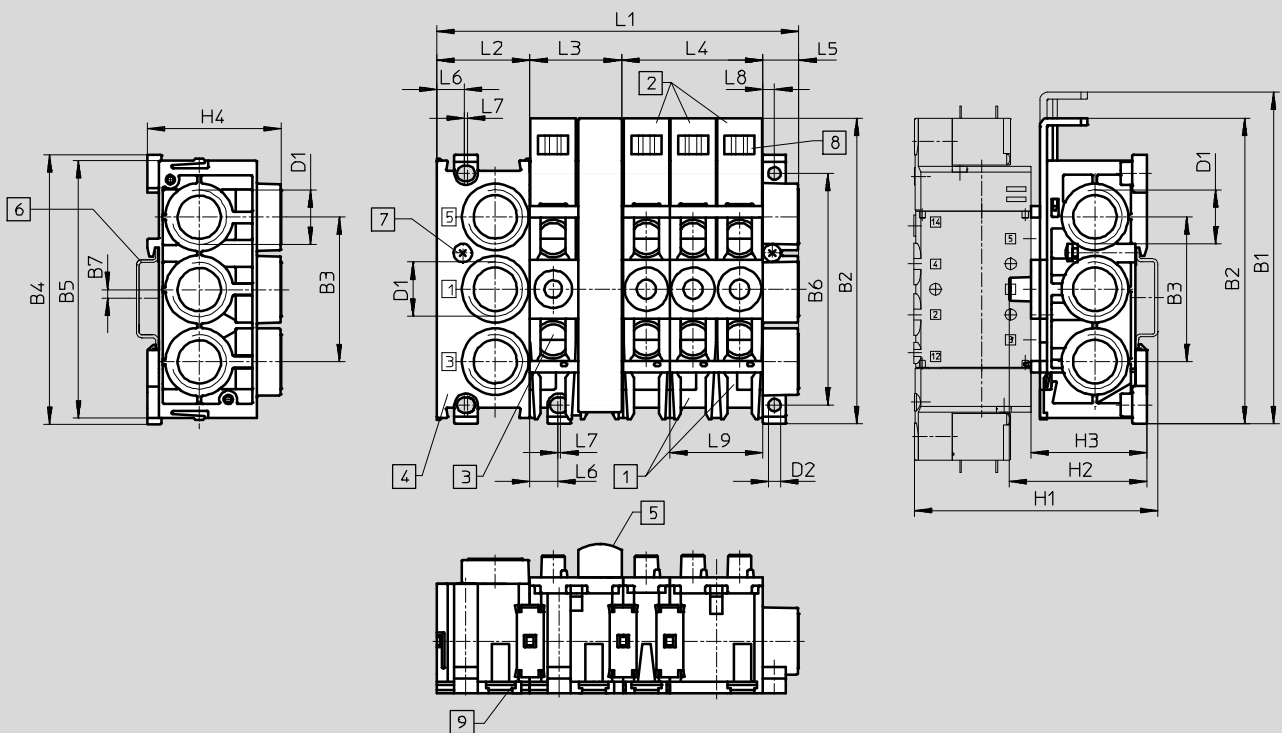

- | | | | |
|--|---|------------------------------------|---|
| 1) Manifold block
CPE...-PRSG...-2 for 2 valves | 3) Expansion block
CPE...-PRSE...-2 for 2 valves | 6) H-rail to EN 50002 for mounting | 8) Location for inscription labels
type IBS 6 x 10 |
| 2) Manifold block
CPE...-PRSG...-3 for 3 valves | 4) End block CPE...-PRS-EP | 7) Clamping screw for H-rail | 9) Connector |
| 5) Blanking plate CPE...-PRSB | | | |

Size	B1	B2	B3	B4	B5	B6	B7	D1	D2	H1	H2	H3	H4
CPE10	93.5	87	37	73	71	60	7	G1/4	3.3	~72	~40	~34	37

Size	L1 ¹⁾	L2	L3	L4	L5	L6	L7	L8	L9
CPE10	24+(nx12)+11.4	24	24	36	11.4	9.6	-	3.2	24

1) n = number of valve positions

Manifold blocks CPE10

Technical data – Modular manifold

FESTO

Possible combinations			
Number of valve positions	One pressure zone	Two pressure zones	
		Variant 1	Variant 2
2	1x CPE...-PRSG-2	–	–
3	1x CPE...-PRSG-3	–	–
4	1x CPE...-PRSGO-2 1x CPE...-PRSE-2	1x CPE...-PRSG-2 1x CPE...-PRSEO-2 1x CPE...-PRS-EP	–
5	1x CPE...-PRSGO-3 1x CPE...-PRSE-2	1x CPE...-PRSG-3 1x CPE...-PRSEO-2 1x CPE...-PRS-EP	–
6	1x CPE...-PRSGO-2 1x CPE...-PRSE-2 1x CPE...-PRSE-2	1x CPE...-PRSG-2 2x CPE...-PRSEO-2 1x CPE...-PRS-EP	1x CPE...-PRSGO-2 1x CPE...-PRSE-2 1x CPE...-PRSEO-2 1x CPE...-PRS-EP
7	1x CPE...-PRSGO-3 2x CPE...-PRSE-2 1x CPE...-PRS-EP	1x CPE...-PRSG-3 2x CPE...-PRSEO-2 1x CPE...-PRS-EP	1x CPE...-PRSGO-3 1x CPE...-PRSE-2 1x CPE...-PRSEO-2 1x CPE...-PRS-EP
8	1x CPE...-PRSGO-2 3x CPE...-PRSE-2 1x CPE...-PRS-EP	1x CPE...-PRSG-2 3x CPE...-PRSEO-2 1x CPE...-PRS-EP	1x CPE...-PRSGO-2 1x CPE...-PRSE-2 2x CPE...-PRSEO-2 1x CPE...-PRS-EP
9	1x CPE...-PRSGO-3 3x CPE...-PRSE-2 1x CPE...-PRS-EP	1x CPE...-PRSG-3 3x CPE...-PRSEO-2 1x CPE...-PRS-EP	1x CPE...-PRSGO-3 1x CPE...-PRSE-2 2x CPE...-PRSEO-2 1x CPE...-PRS-EP
10	1x CPE...-PRSGO-2 4x CPE...-PRSE-2 1x CPE...-PRS-EP	1x CPE...-PRSG-2 4x CPE...-PRSEO-2 1x CPE...-PRS-EP	1x CPE...-PRSGO-2 1x CPE...-PRSE-2 3x CPE...-PRSEO-2 1x CPE...-PRS-EP
11	1x CPE...-PRSGO-3 4x CPE...-PRSE-2 1x CPE...-PRS-EP	1x CPE...-PRSG-3 4x CPE...-PRSEO-2 1x CPE...-PRS-EP	1x CPE...-PRSGO-3 1x CPE...-PRSE-2 3x CPE...-PRSEO-2 1x CPE...-PRS-EP
12	1x CPE...-PRSGO-2 5x CPE...-PRSE-2 1x CPE...-PRS-EP	1x CPE...-PRSG-2 5x CPE...-PRSEO-2 1x CPE...-PRS-EP	1x CPE...-PRSGO-2 1x CPE...-PRSE-2 4x CPE...-PRSEO-2 1x CPE...-PRS-EP

 Note

A maximum of 6 valve positions are possible per air supply.
Use valve manifold blocks only in combination with 5/2- and 5/3-way valves.

Manifold blocks CPE10

Ordering data – Modular manifold

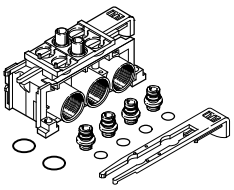
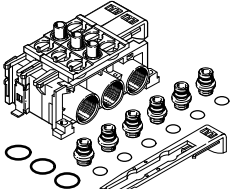
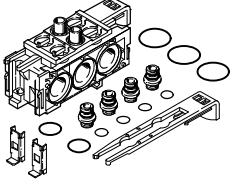
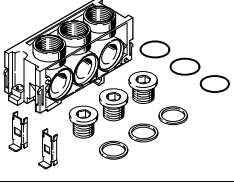
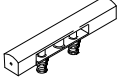
Ordering data					
	Port 1, 3, 5	PRS ducts	Weight [g]	Part No.	Type
Manifold block PRSG for 2 valves					
	G1/4	Closed	50	164960	CPE10-PRSG-2
	G1/4	Open	50	187827	CPE10-PRSGO-2
Manifold block PRSG for 3 valves					
	G1/4	Closed	70	187823	CPE10-PRSG-3
	G1/4	Open	70	187819	CPE10-PRSGO-3
Manifold block PRSE for 2 valves					
	-	Closed	40	164962	CPE10-PRSE-2
	-	Open	40	187828	CPE10-PRSEO-2
End plate for manifold					
	G1/4	-	70	164964	CPE10-PRS-EP
Blanking plate for unused valve position					
	-	-	10	164963	CPE10-PRSB



Solenoid valves CPE14

Technical data

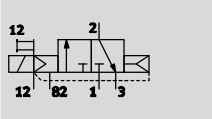
Function
 3/2G, 3/2O,
 5/2-way, single solenoid,
 5/2-way, double solenoid valve
 5/3G, 5/3B, 5/3E



e.g. 3/2-way valve with external pilot air supply, normally closed

-  - Width 14 mm
-  - Flow rate
370 ... 900 l/min
-  - Voltage
24 V DC

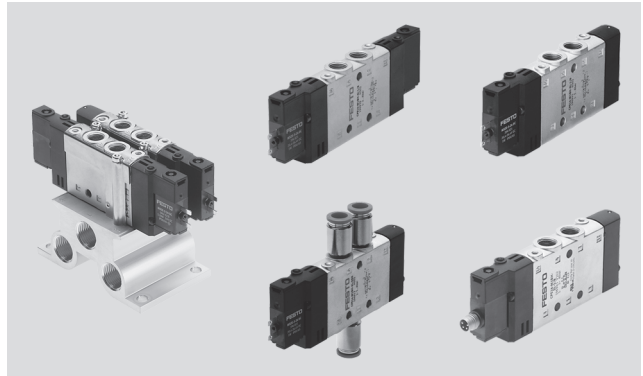

General technical data		3/2		5/2		5/3		
Valve function		G ¹⁾	O ²⁾	-		G ¹⁾	B ²⁾	E ³⁾
Stable position		Monostable			Bistable		Monostable	
Reset method: pneumatic spring		Yes			-		No	
Reset method: mechanical spring		No			-		Yes	
Design		Piston spool						
Sealing principle		Soft						
Lap		Overlap						
Type of actuation		Electrical						
Type of control		Pilot						
Pilot air supply		Internal or external						
Flow direction		-		Reversible with external pilot air supply				
Exhaust air function		-		With flow control				
Manual override		Non-detenting, detenting via accessory						
Type of mounting		Via through-holes						
Mounting position		Any						
Pneumatic connection	1, 2, 4	Threaded connection: G1/8 QS connection: Ø 6 or Ø 8 mm						
	3, 5	Threaded connection: G1/8						
	12, 14	Threaded connection: M3; QS connection: Ø 3 mm						
	82, 84	Threaded connection: M3						
Nominal width	[mm]	6						
Standard nominal flow rate	G1/8 [l/min]	900		800		750		700
Standard nominal flow rate	QS6 [l/min]	510		400		410		370
Standard nominal flow rate	QS8 [l/min]	810		680		720		650 570
Switching time on/off	[ms]	16/27		24/32		-		20/42
Changeover time	[ms]	-		-		12		-
Duty cycle	[%]	100						
Width	[mm]	14						
Corrosion resistance class CRC ⁴⁾		2						

1) G = normally closed

2) O, B = normally open

3) E = normally exhausted

4) Corrosion resistance class CRC 2 to Festo standard FN 940070

Moderate corrosion stress. Indoor applications in which condensation may occur. External visible parts with primarily decorative requirements for the surface and which are in direct contact with the ambient atmosphere typical for industrial applications.

Solenoid valves CPE14

Technical data

Operating and environmental conditions						
Valve function		3/2	5/2-way, single solenoid	5/2-way, double solenoid	5/3	
Operating medium		Compressed air to ISO 8573-1:2010 [7:4:4]				
Pilot medium		Compressed air to ISO 8573-1:2010 [7:4:4]				
Note on operating/pilot medium		Lubricated operation possible (in which case lubricated operation will always be required)				
Operating pressure	Internal pilot air supply	[bar]	2.5 ... 8	3 ... 8	2 ... 8	3 ... 8
	External pilot air supply	[bar]	-0.9 ... +10			
Pilot pressure		[bar]	2.5 ... 8	3 ... 8	2 ... 8	3 ... 8
Ambient temperature		[°C]	-5 ... +50			
Temperature of medium		[°C]	-5 ... +50			
Certification for solenoid valves		c UL us - Recognized (OL) (not with M1CH-...)				
Maritime classification ¹⁾		See certificate				

1) Additional information www.festo.com/sp → Certificates.

Electrical data			
Operating voltage	M1BH, M1CH	[V DC]	24 +10/-15%
Power consumption	M1BH, M1CH	[W]	1.28
Degree of protection with plug socket		IP65 to IEC 60529 M1CH: IP65/IP67 to IEC 60529	
Max. tightening torque of plug socket M8x1	M1CH	[Nm]	0.4

Materials

Sectional view

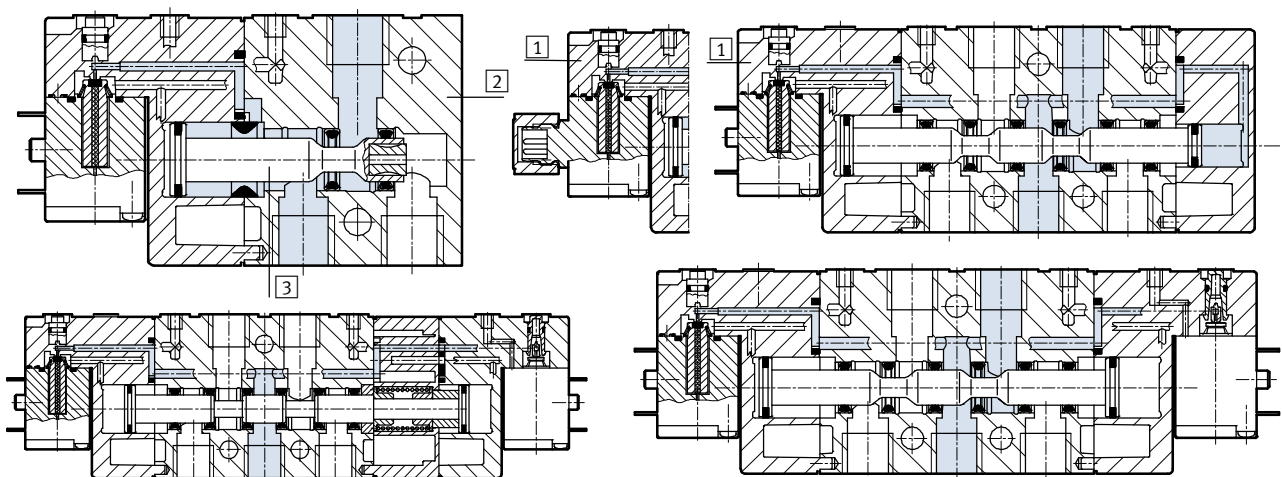

1	Cap	PA
2	Housing	Die-cast aluminium
3	Piston spool	Steel
-	Seals	NBR
Note on materials		RoHS compliant

Solenoid valves CPE14

Technical data

FESTO

Dimensions – 3/2-way valve

Download CAD data → www.festo.com

CPE14-...-1/8

CPE14-...-QS-6

CPE14-...-QS-8

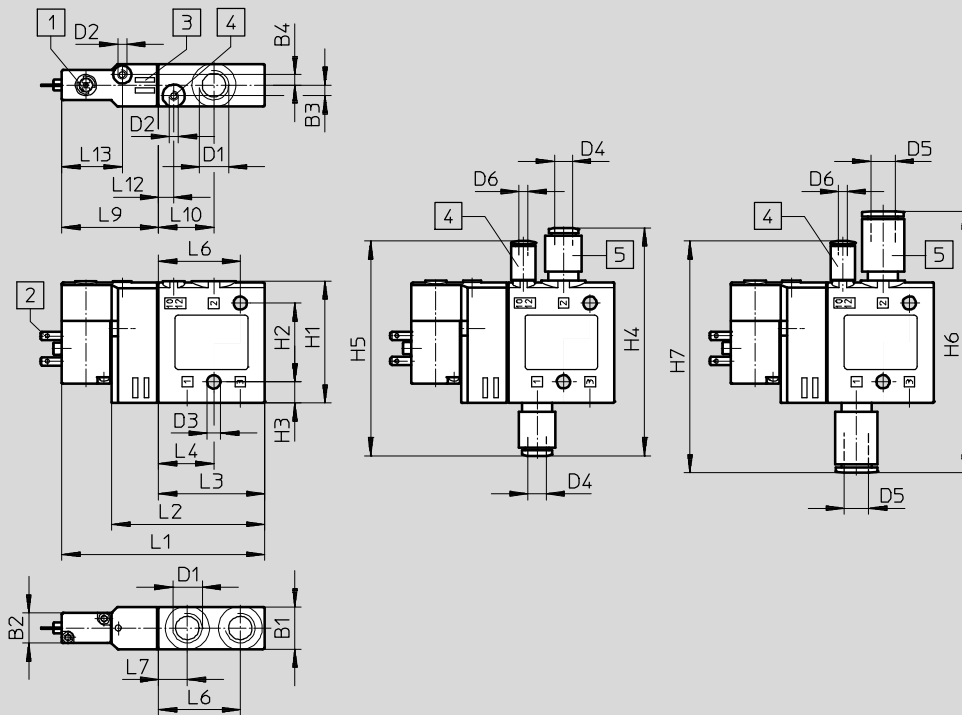

- 1 Manual override
- 2 Plug pins, connection pattern ZC
- 3 Location for inscription labels
- 4 Port 10/12 for external pilot air supply
- 5 QS push-in fitting

Type	B1	B2	B3	B4	D1	D2	D3	D4	D5	D6	H1	H2	H3	H4	H5	H6	H7
CPE14-M1BH-3...	14	10	3.5	3.5	G1/8	M3	4.4	6	8	3	40.3	26	7	75.3	70.9	86.3	76.4

Type	L1	L2	L3	L4	L6	L7	L9	L10	L12	L13
CPE14-M1BH-3...	67	50.5	35	18.3	27	9.5	32	18	5	20

Solenoid valves CPE14

Technical data

Dimensions – 5/2-way single solenoid valve

Download CAD data → www.festo.com

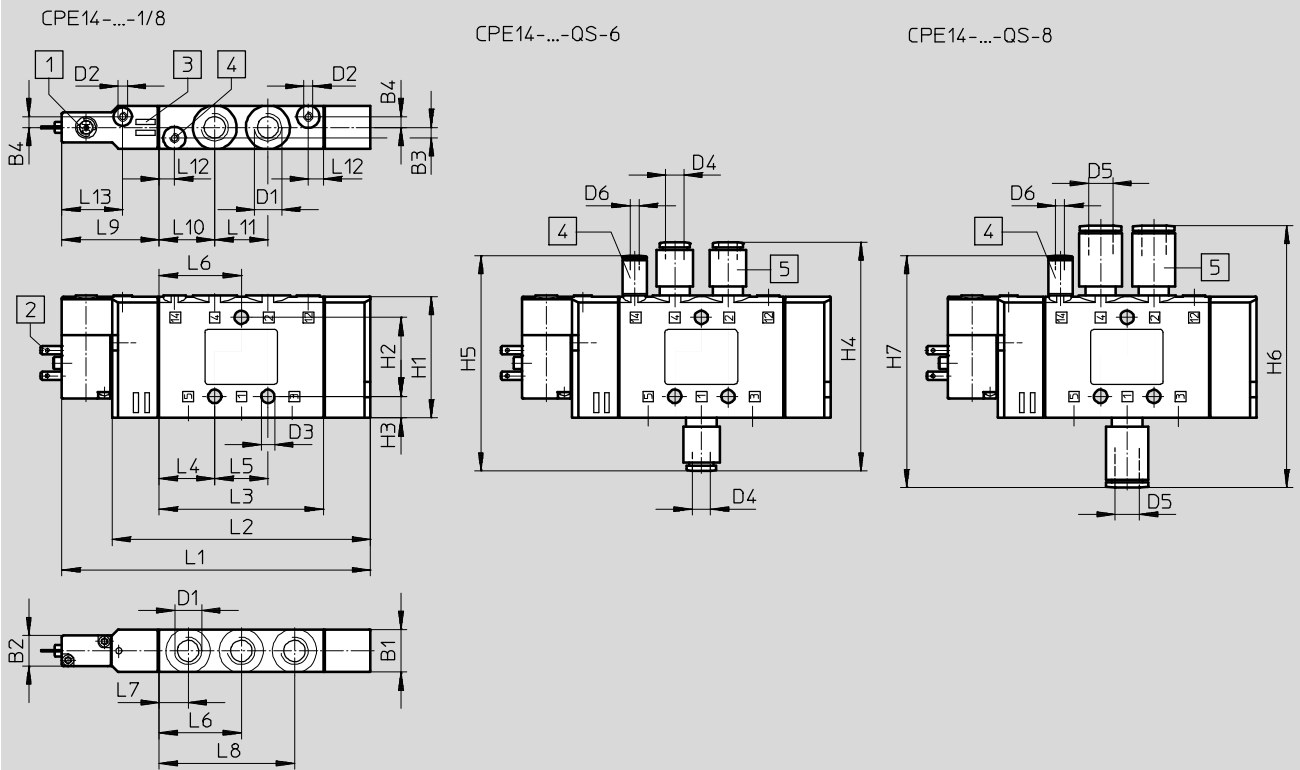

- 1 Manual override
- 2 Plug pins, connection pattern ZC
- 3 Location for inscription labels
- 4 Port 12/14 for external pilot air supply
- 5 QS push-in fitting

Type	B1	B2	B3	B4	D1	D2	D3	D4	D5	D6	H1	H2	H3	H4	H5	H6	H7
CPE14-M1BH-5L...	14	10	3.5	3.5	G1/8	M3	4.4	6	8	3	403	26	7	75.3	70.9	86.3	76.4

Type	L1	L2	L3	L4	L5	L6	L7	L8	L9	L10	L11	L12	L13
CPE14-M1BH-5L...	101.5	85	54	18.3	17.5	27	9.5	44.5	32	18.3	17.5	5	20

Solenoid valves CPE14

Technical data

FESTO

Dimensions – 5/2-way double solenoid valve

Download CAD data → www.festo.com

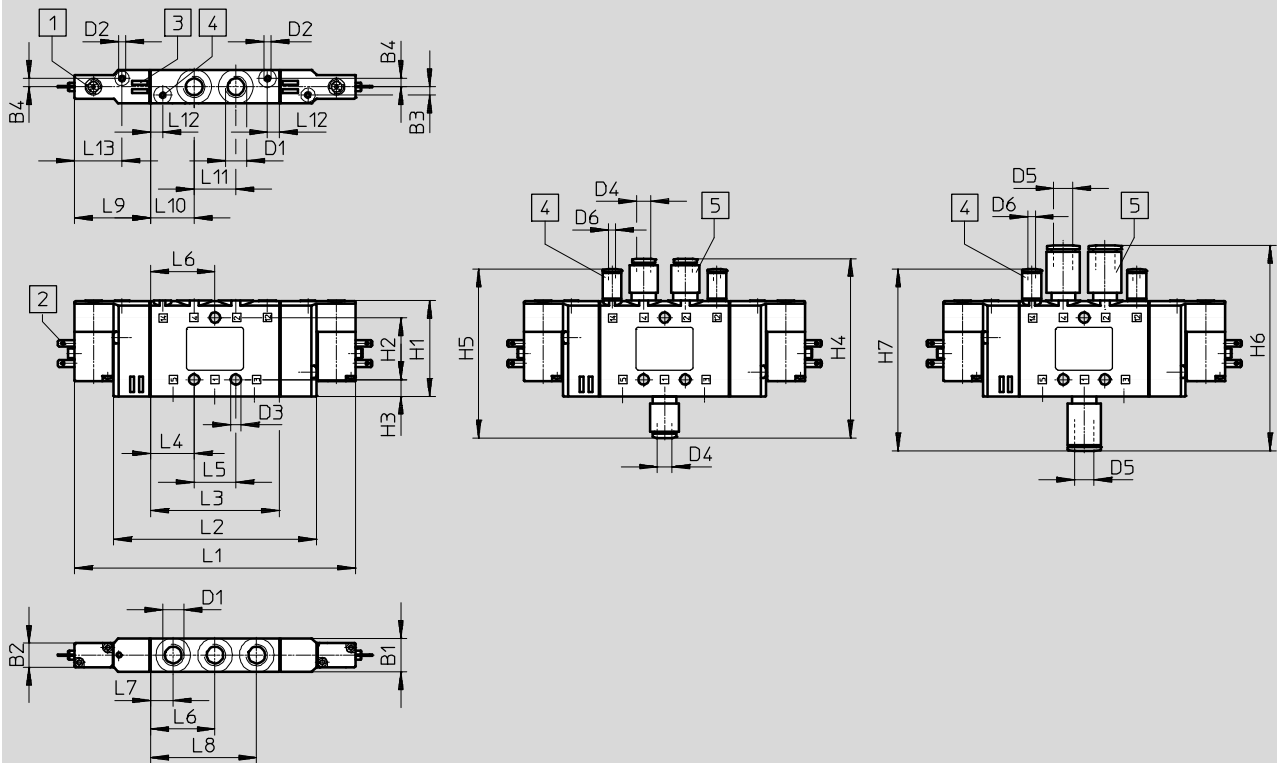

- 1 Manual override, non-detenting
- 2 Plug pins, connection pattern ZC
- 3 Location for inscription labels
- 4 Port 12/14 for external pilot air supply
- 5 QS push-in fitting

Type	B1	B2	B3	B4	D1	D2	D3	D4	D5	D6	H1	H2	H3	H4	H5	H6	H7
CPE14-...-5J-1/8	14	10	3.5	3.5	G1/8	M3	4.4	6	8	3	40.3	26	7	75.3	70.9	86.3	76.4

Type	L1	L2	L3	L4	L5	L6	L7	L8	L9	L10	L11	L12	L13
CPE14-...-5J-1/8	118	85	54	18.3	17.5	27	9.5	44.5	32	18.3	17.5	5	20

Solenoid valves CPE14

Technical data

Dimensions – 5/3-way valve

Download CAD data → www.festo.com

CPE14-...-1/8

CPE14-...-QS-6

CPE14-...-QS-8

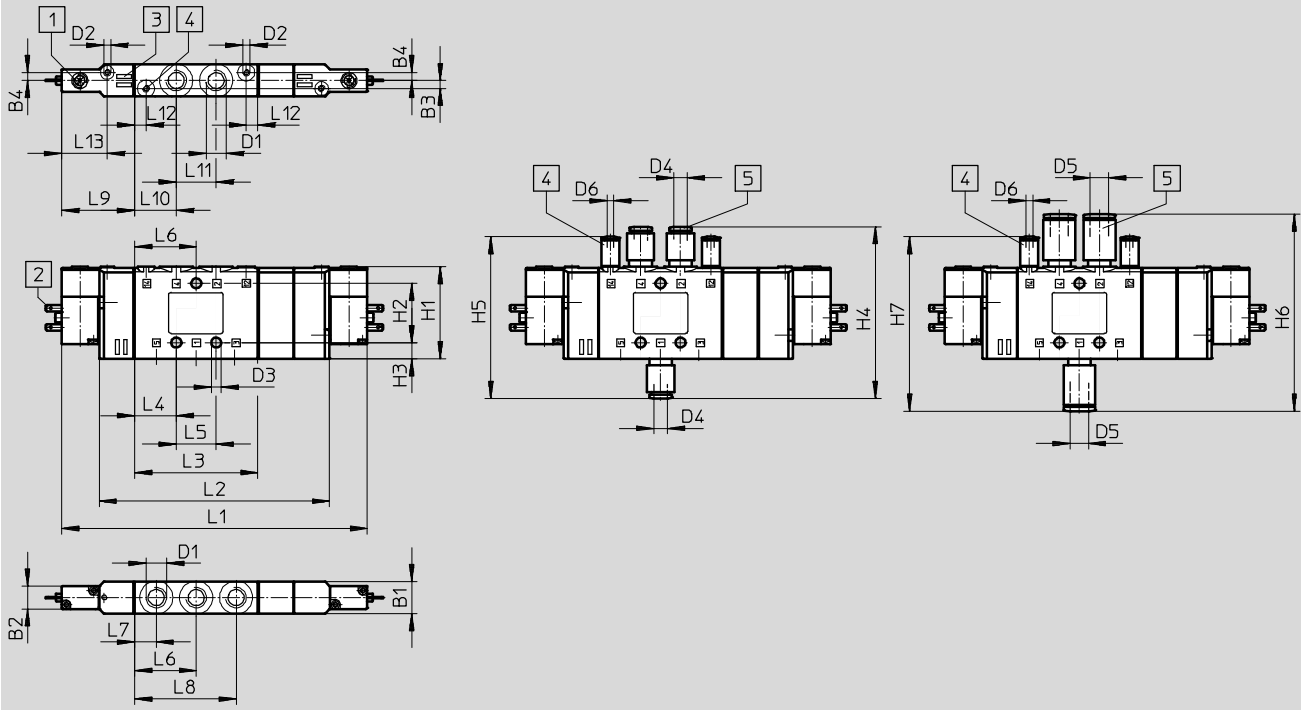

- 1 Manual override
- 2 Plug pins, connection pattern ZC
- 3 Location for inscription labels
- 4 Port 12/14 for external pilot air supply
- 5 QS push-in fitting

Type	B1	B2	B3	B4	D1	D2	D3	D4	D5	D6	H1	H2	H3	H4	H5	H6	H7
CPE14-M1BH...-5J	14	10	3.5	3.5	G1/8	M3	4.4	6	8	3	403	26	7	75.3	70.9	86.3	76.4
CPE14-M1BH...-5/3																	

Type	L1	L2	L3	L4	L5	L6	L7	L8	L9	L10	L11	L12	L13
CPE14-M1BH...-5J	118	85	46	18.3	17.5	27	9.5	44.5	32	18.3	17.5	5	20
CPE14-M1BH...-5/3	134	101											

Solenoid valves CPE14

Technical data

FESTO

Dimensions – Solenoid valves with round plug M8x1

Download CAD data → www.festo.com

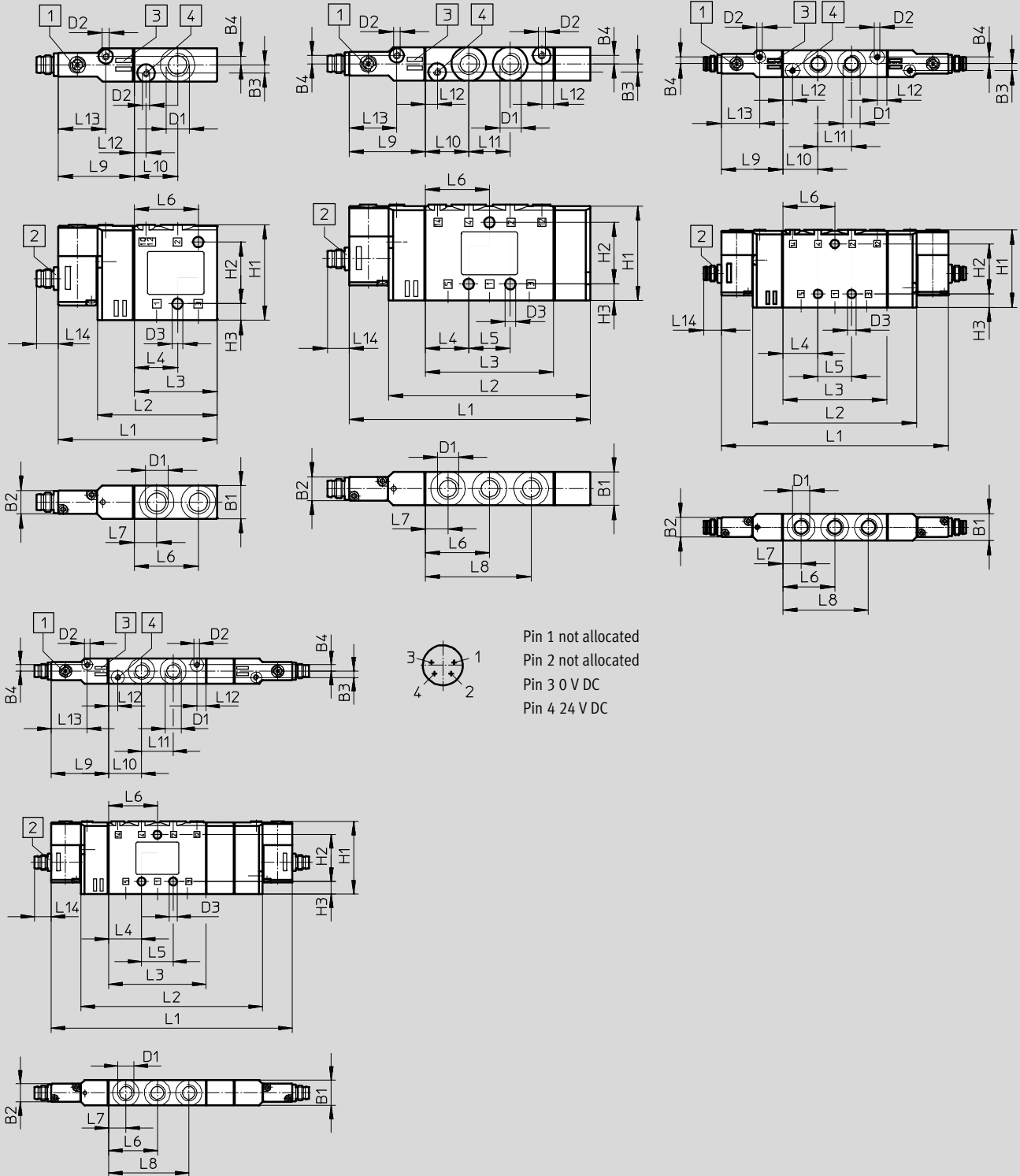

1 Manual override

2 Plug M8x1

3 Location for inscription labels

4 Port 12/14 for external pilot air supply

Solenoid valves CPE14

Technical data

Type	B1	B2	B3	B4	D1	D2	D3 ∅	H1	H2	H3
CPE14-M1CH-3...	14	10	3.5	3.5	G1/8	M3	4.4	40.3	26	7
CPE14-M1CH-5L...								40.4		
CPE14-M1CH-5J...								40.3		
CPE14-M1BH-5J								40.3		
CPE14-M1BH-5/3										

Type	L1	L2	L3	L4	L5	L6	L7	L8	L9	L10	L11	L12	L13	L14
CPE14-M1CH-3...	67	50.5	35	18.3	-	27	9.5	-	32	18.3	-	5	20	9.2
CPE14-M1CH-5L...	101.5	85	54		17.5			44.5			17.5			
CPE14-M1CH-5J...	118			17.5										
CPE14-M1BH-5J...	134			101										
CPE14-M1BH-5/3...														

Solenoid valves CPE14

Ordering data

Ordering data							
Circuit symbol	Pilot air supply	Electrical connection	Operating voltage	Pneumatic connection	Weight [g]	Part No.	Type
3/2-way valve, normally closed							
	Internal	Plug pins, connection pattern ZC	24 V DC	G1/8	60	196929	CPE14-M1BH-3GL-1/8
				QS-6	–	196887	CPE14-M1BH-3GL-QS-6
		QS-8		–	196888	CPE14-M1BH-3GL-QS-8	
		Plug connector M8x1		G1/8	60	550247	CPE14-M1CH-3GL-1/8
3/2-way valve, normally open							
	Internal	Plug pins, connection pattern ZC	24 V DC	G1/8	60	196931	CPE14-M1BH-3OL-1/8
				QS-6	–	196891	CPE14-M1BH-3OL-QS-6
		QS-8		–	196892	CPE14-M1BH-3OL-QS-8	
		Plug connector M8x1		G1/8	60	550249	CPE14-M1CH-3OL-1/8
3/2-way valve, normally closed							
	External	Plug pins, connection pattern ZC	24 V DC	G1/8	60	196930	CPE14-M1BH-3GLS-1/8
				QS-6	–	196889	CPE14-M1BH-3GLS-QS-6
		QS-8		–	196890	CPE14-M1BH-3GLS-QS-8	
		Plug connector M8x1		G1/8	60	550248	CPE14-M1CH-3GLS-1/8
3/2-way valve, normally open							
	External	Plug pins, connection pattern ZC	24 V DC	G1/8	60	196932	CPE14-M1BH-3OLS-1/8
				QS-6	–	196893	CPE14-M1BH-3OLS-QS-6
		QS-8		–	196894	CPE14-M1BH-3OLS-QS-8	
		Plug connector M8x1		G1/8	60	550250	CPE14-M1CH-3OLS-1/8
5/2 way valve, single solenoid							
	Internal	Plug pins, connection pattern ZC	24 V DC	G1/8	95	196941	CPE14-M1BH-5L-1/8
				QS-6	–	196911	CPE14-M1BH-5L-QS-6
		QS-8		–	196912	CPE14-M1BH-5L-QS-8	
		Plug connector M8x1		G1/8	95	550237	CPE14-M1CH-5L-1/8
5/2-way valve, double solenoid							
	Internal	Plug pins, connection pattern ZC	24 V DC	G1/8	115	196939	CPE14-M1BH-5J-1/8
				QS-6	–	196907	CPE14-M1BH-5J-QS-6
		QS-8		–	196908	CPE14-M1BH-5J-QS-8	
		Plug connector M8x1		G1/8	115	550239	CPE14-M1CH-5J-1/8
5/2 way valve, single solenoid							
	External	Plug pins, connection pattern ZC	24 V DC	G1/8	95	196942	CPE14-M1BH-5LS-1/8
				QS-6	–	196913	CPE14-M1BH-5LS-QS-6
		QS-8		–	196914	CPE14-M1BH-5LS-QS-8	
		Plug connector M8x1		G1/8	95	550238	CPE14-M1CH-5LS-1/8
5/2-way valve, double solenoid							
	External	Plug pins, connection pattern ZC	24 V DC	G1/8	115	196940	CPE14-M1BH-5JS-1/8
				QS-6	–	196909	CPE14-M1BH-5JS-QS-6
		QS-8		–	196910	CPE14-M1BH-5JS-QS-8	
		Plug connector M8x1		G1/8	115	550240	CPE14-M1CH-5JS-1/8

Solenoid valves CPE14

Ordering data

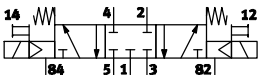
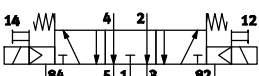
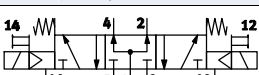
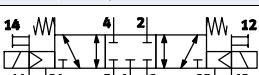
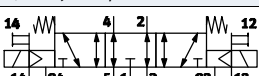
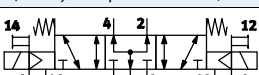
Ordering data							
Circuit symbol	Pilot air supply	Electrical connection	Operating voltage	Pneumatic connection	Weight [g]	Part No.	Type
5/3-way mid-position valve, normally closed							
	Internal	Plug pins, connection pattern ZC	24 V DC	G1/8	120	196937	CPE14-M1BH-5/3G-1/8
		Plug connector M8x1		QS-6	-	196903	CPE14-M1BH-5/3G-QS-6
				QS-8	-	196904	CPE14-M1BH-5/3G-QS-8
				G1/8	120	550241	CPE14-M1CH-5/3G-1/8
5/3-way mid-position valve, normally exhausted							
	Internal	Plug pins, connection pattern ZC	24 V DC	G1/8	120	196935	CPE14-M1BH-5/3E-1/8
		Plug connector M8x1		QS-6	-	196899	CPE14-M1BH-5/3E-QS-6
				QS-8	-	196900	CPE14-M1BH-5/3E-QS-8
				G1/8	120	550243	CPE14-M1CH-5/3E-1/8
5/3-way mid-position valve, normally open							
	Internal	Plug pins, connection pattern ZC	24 V DC	G1/8	120	196933	CPE14-M1BH-5/3B-1/8
		Plug connector M8x1		QS-6	-	196895	CPE14-M1BH-5/3B-QS-6
				QS-8	-	196896	CPE14-M1BH-5/3B-QS-8
				G1/8	120	550245	CPE14-M1CH-5/3B-1/8
5/3-way mid-position valve, normally closed							
	External	Plug pins, connection pattern ZC	24 V DC	G1/8	120	196938	CPE14-M1BH-5/3GS-1/8
		Plug connector M8x1		QS-6	-	196905	CPE14-M1BH-5/3GS-QS-6
				QS-8	-	196906	CPE14-M1BH-5/3GS-QS-8
				G1/8	120	550242	CPE14-M1CH-5/3GS-1/8
5/3-way mid-position valve, normally exhausted							
	External	Plug pins, connection pattern ZC	24 V DC	G1/8	120	196936	CPE14-M1BH-5/3ES-1/8
		Plug connector M8x1		QS-6	-	196901	CPE14-M1BH-5/3ES-QS-6
				QS-8	-	196902	CPE14-M1BH-5/3ES-QS-8
				G1/8	120	550244	CPE14-M1CH-5/3ES-1/8
5/3-way mid-position valve, normally open							
	External	Plug pins, connection pattern ZC	24 V DC	G1/8	120	196934	CPE14-M1BH-5/3BS-1/8
		Plug connector M8x1		QS-6	-	196897	CPE14-M1BH-5/3BS-QS-6
				QS-8	-	196898	CPE14-M1BH-5/3BS-QS-8
				G1/8	120	550246	CPE14-M1CH-5/3BS-1/8

Manifold blocks CPE14

Technical data – Manifold block



Manifold block CPE...-PRS

Materials:
Wrought aluminium alloy
RoHS compliant

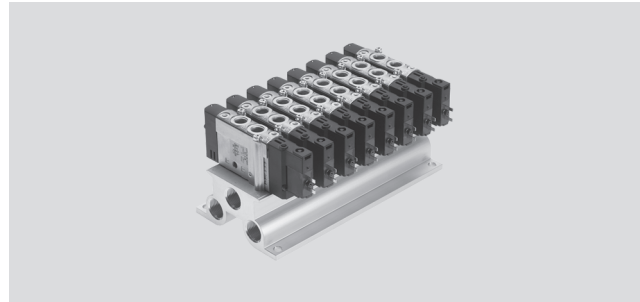

Dimensions – Fixed-grid manifold 5/2 and 5/3

Download CAD data → www.festo.com

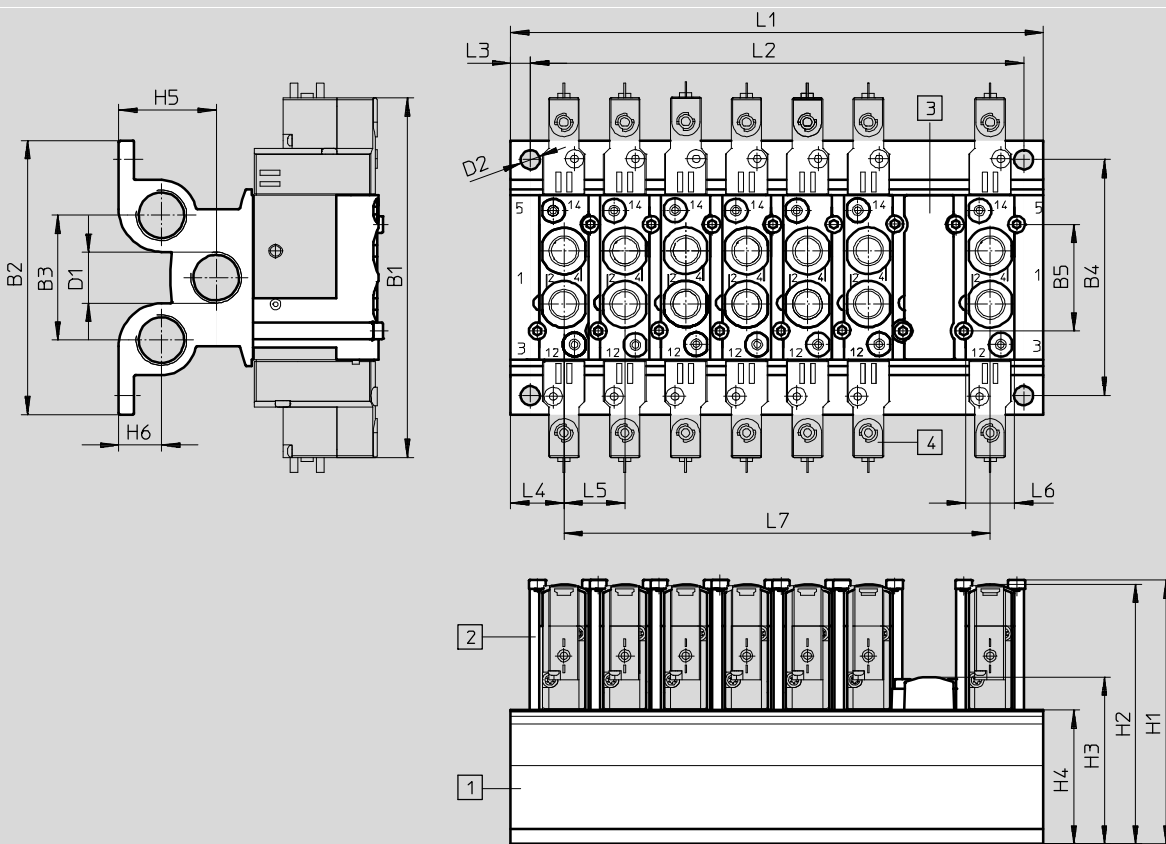

- 1 Manifold block
Grid dimension 16 mm
- 2 Retainer
- 3 Cover plate
- 4 Valves

Type	B1	B2	B3	B4	B5	D1	D2	H1	H2	H3	H4	H5	H6
CPE14-PRS...	118	90	41	77.5	35	G3/8	6.3	86.7	84.8	54.8	44	32	14

Type	L1	L2	L3	L4	L5	L6	L7
CPE14-PRS...	$35 + (n-1) \times 20$	$L1 - 13 \pm 0.1$	6.5	17.5	20	17.4	$(n-1) \times 20$

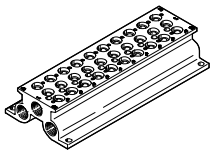

Manifold blocks CPE14

Ordering data – Fixed-grid manifold block

Ordering data						
	Valve positions	CRC ¹⁾	Max. tightening torque [Nm]	Weight [g]	Part No.	Type
Manifold block for 5/2- and 5/3-way valves						
	2	2	1.2	239	543830	CPE14-PRS-3/8-2
	3			326	543831	CPE14-PRS-3/8-3
	4			412	543832	CPE14-PRS-3/8-4
	5			498	543833	CPE14-PRS-3/8-5
	6			584	543834	CPE14-PRS-3/8-6
	7			671	543835	CPE14-PRS-3/8-7
	8			757	543836	CPE14-PRS-3/8-8
	9			843	543837	CPE14-PRS-3/8-9
	10			930	543838	CPE14-PRS-3/8-10

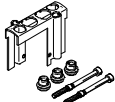
1) Corrosion resistance class CRC 2 to Festo standard FN 940070
 Moderate corrosion stress. Indoor applications in which condensation may occur. External visible parts with primarily decorative requirements for the surface and which are in direct contact with the ambient atmosphere typical for industrial applications.

Ordering data			
	Material	Part No.	Type
Blanking plate for unused valve position			
	PA	544480	CPE14-RP
Retainer set			
	Retainer: High-alloy stainless steel Screws: Galvanised steel Seals: NBR	544395	CPE14-H5-SET

Ordering data			
	Material	Part No.	Type
Retainer			
	Retainer: High-alloy stainless steel (packaging unit 50 pieces)	547046	CPE14-H5-50
Screws			
	Galvanised steel (packaging unit 100 pieces)	547049	M3X45-8.8-VS-100
Seals			
	NBR (packaging unit 150 pieces)	547052	CPV14-VI-P.1/8-150

Manifold blocks CPE14

Technical data – Fixed-grid manifold block



Manifold block

For CPE14 3/2

Materials:

Wrought aluminium alloy

RoHS compliant

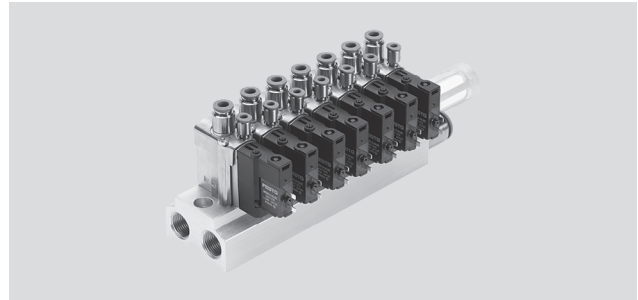

Dimensions – Fixed-grid manifold 3/2

Download CAD data → www.festo.com

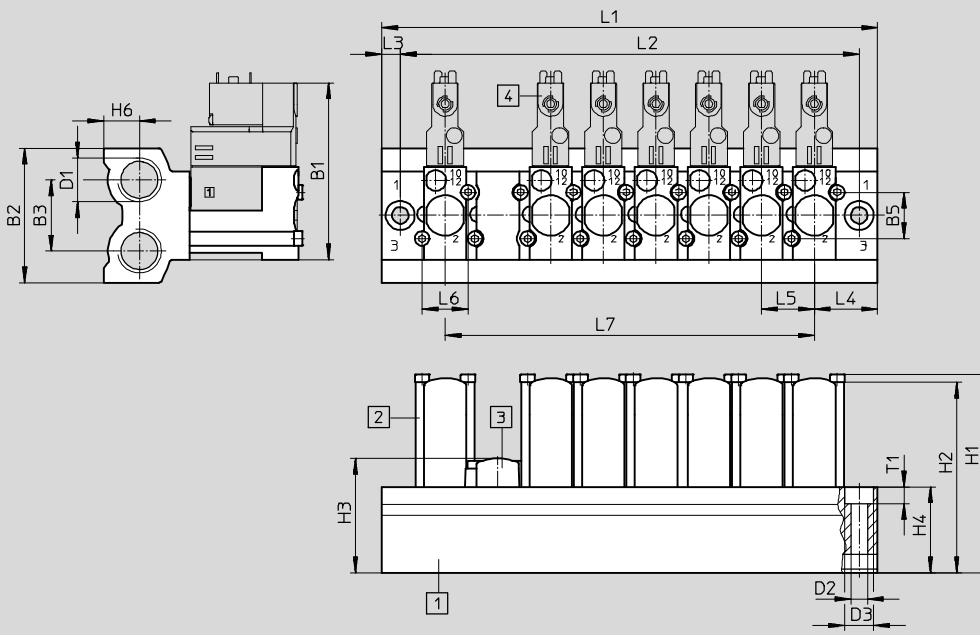

- 1 Manifold block
– Grid dimension 20 mm
- 2 Retainer
- 3 Cover plate
- 4 Valves

Type	B1	B2	B3	B5	D1	D2	D3	H1	H2	H3	H4	H6
CPE14-3/2-PRS...	67	51	27	17.5	G3/8	6.3	11	75.2	72.2	43.3	32.5	13.5

Type	L1	L2	L3	L4	L5	L6	L7	T1
CPE14-3/2-PRS...	$48 + (n-1) \times 20$	$34 + (n-1) \times 20$	7	24	20	17.4	$(n-1) \times 20$	6.3

Manifold blocks CPE14

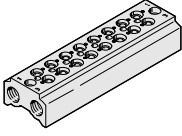

Ordering data – Fixed-grid manifold block

Ordering data						
	Valve positions	CRC ¹⁾	Max. tightening torque for valve mounting [Nm]	Weight [g]	Part No.	Type
Manifold block for 3/2-way valves						
	2	2	1.2	176	550559	CPE14-3/2-PRS-3/8-2
	3			228	550560	CPE14-3/2-PRS-3/8-3
	4			280	550561	CPE14-3/2-PRS-3/8-4
	5			332	550562	CPE14-3/2-PRS-3/8-5
	6			384	550563	CPE14-3/2-PRS-3/8-6
	7			436	550564	CPE14-3/2-PRS-3/8-7
	8			488	550565	CPE14-3/2-PRS-3/8-8
	9			540	550566	CPE14-3/2-PRS-3/8-9
	10			592	550567	CPE14-3/2-PRS-3/8-10

1) Corrosion resistance class CRC 2 to Festo standard FN 940070

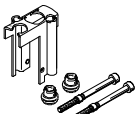
Moderate corrosion stress. Indoor applications in which condensation may occur. External visible parts with primarily decorative requirements for the surface and which are in direct contact with the ambient atmosphere typical for industrial applications.

Ordering data			
	Material	Part No.	Type
Cover plate			
	PA	550581	CPE14-RP3
Retainer set			
	Retainer: High-alloy stainless steel Screws: Galvanised steel Seals: NBR	550578	CPE14-H3-SET

Ordering data			
	Material	Part No.	Type
Retainer			
	Retainer: High-alloy stainless steel (packaging unit 50 pieces)	551491	CPE14-H3-50
Screws			
	Galvanised steel (packaging unit 100 pieces)	547049	M3X45-8.8-VS-100
Seals			
	NBR (packaging unit 150 pieces)	547052	CPV14-VI-P.1/8-150

Manifold blocks CPE14

Technical data – Modular manifold



Modular manifold block
For CPE14 5/2 and 5/3

Materials:
PA, reinforced

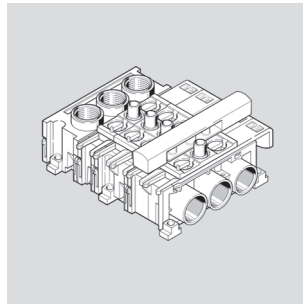

Dimensions – Modular manifold block

Download CAD data → www.festo.com

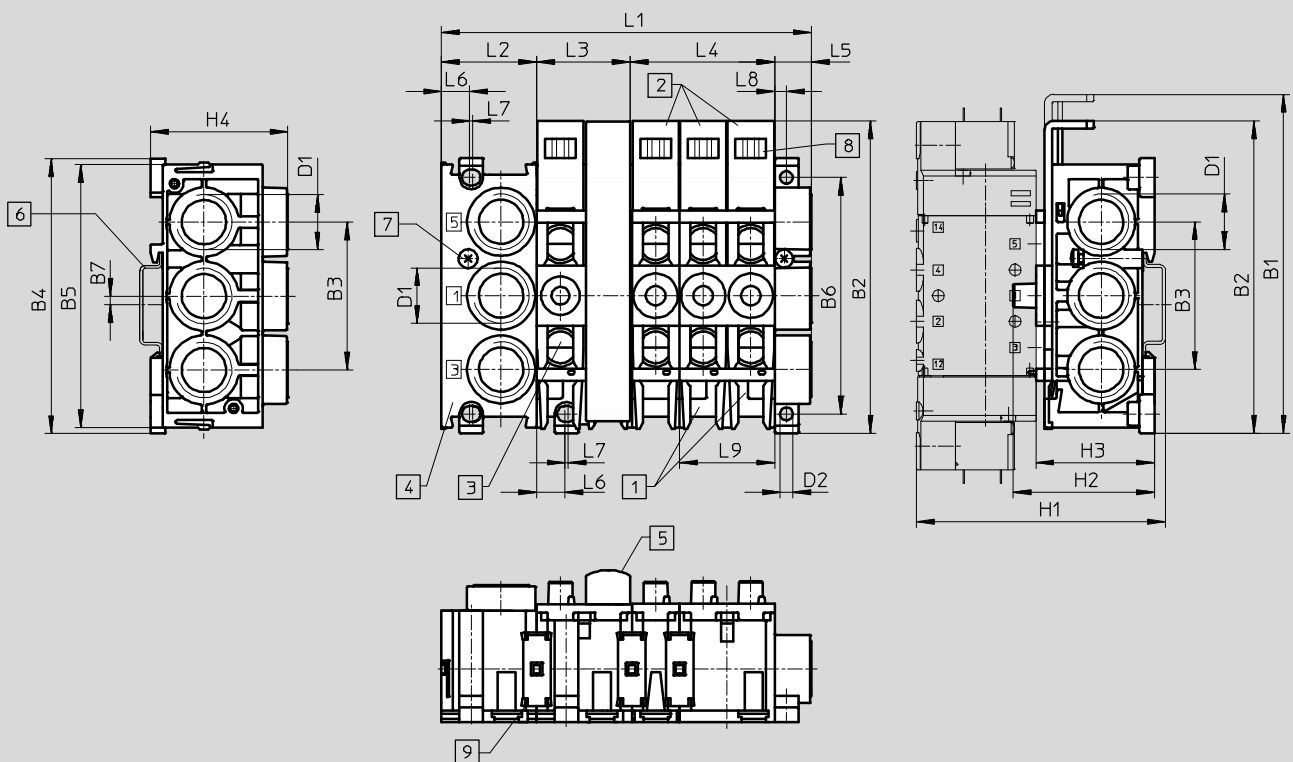

- | | | | |
|--|---|-------------------------------------|---|
| 1) Manifold block
CPE...-PRSG...-2 for 2 valves | 3) Expansion block
CPE...-PRSE...-2 for 2 valves | 6) H-rail to EN 50 002 for mounting | 8) Location for inscription labels
type IBS 6 x 10 |
| 2) Manifold block
CPE...-PRSG...-3 for 3 valves | 4) End block CPE...-PRS-EP | 7) Clamping screw for H-rail | 9) Connector |
| | 5) Blanking plate CPE...-PRSB | | |

Size	B1	B2	B3	B4	B5	B6	B7	D1	D2	H1	H2	H3	H4
CPE14	114.6	105.6	50	93	89	80	3	G3/8	4.3	~84	~48	~40	46.4

Size	L1 ¹⁾	L2	L3	L4	L5	L6	L7	L8	L9
CPE14	32+(nx16)+12.4	32	32	48	12.4	10.1	-	4	32

1) n = number of valve positions

Manifold blocks CPE14

Technical data – Modular manifold

Possible combinations			
Number of valve positions	One pressure zone	Two pressure zones	
		Variant 1	Variant 2
2	1x CPE...-PRSG-2	–	–
3	1x CPE...-PRSG-3	–	–
4	1x CPE...-PRSGO-2 1x CPE...-PRSE-2	1x CPE...-PRSG-2 1x CPE...-PRSEO-2 1x CPE...-PRS-EP	–
5	1x CPE...-PRSGO-3 1x CPE...-PRSE-2	1x CPE...-PRSG-3 1x CPE...-PRSEO-2 1x CPE...-PRS-EP	–
6	1x CPE...-PRSGO-2 1x CPE...-PRSEO-2 1x CPE...-PRSE-2	1x CPE...-PRSG-2 2x CPE...-PRSEO-2 1x CPE...-PRS-EP	1x CPE...-PRSGO-2 1x CPE...-PRSE-2 1x CPE...-PRSEO-2 1x CPE...-PRS-EP
7	1x CPE...-PRSGO-3 2x CPE...-PRSEO-2 1x CPE...-PRS-EP	1x CPE...-PRSG-3 2x CPE...-PRSEO-2 1x CPE...-PRS-EP	1x CPE...-PRSGO-3 1x CPE...-PRSE-2 1x CPE...-PRSEO-2 1x CPE...-PRS-EP
8	1x CPE...-PRSGO-2 3x CPE...-PRSEO-2 1x CPE...-PRS-EP	1x CPE...-PRSG-2 3x CPE...-PRSEO-2 1x CPE...-PRS-EP	1x CPE...-PRSGO-2 1x CPE...-PRSE-2 2x CPE...-PRSEO-2 1x CPE...-PRS-EP
9	1x CPE...-PRSGO-3 3x CPE...-PRSEO-2 1x CPE...-PRS-EP	1x CPE...-PRSG-3 3x CPE...-PRSEO-2 1x CPE...-PRS-EP	1x CPE...-PRSGO-3 1x CPE...-PRSE-2 2x CPE...-PRSEO-2 1x CPE...-PRS-EP
10	1x CPE...-PRSGO-2 4x CPE...-PRSEO-2 1x CPE...-PRS-EP	1x CPE...-PRSG-2 4x CPE...-PRSEO-2 1x CPE...-PRS-EP	1x CPE...-PRSGO-2 1x CPE...-PRSE-2 3x CPE...-PRSEO-2 1x CPE...-PRS-EP
11	1x CPE...-PRSGO-3 4x CPE...-PRSEO-2 1x CPE...-PRS-EP	1x CPE...-PRSG-3 4x CPE...-PRSEO-2 1x CPE...-PRS-EP	1x CPE...-PRSGO-3 1x CPE...-PRSE-2 3x CPE...-PRSEO-2 1x CPE...-PRS-EP
12	1x CPE...-PRSGO-2 5x CPE...-PRSEO-2 1x CPE...-PRS-EP	1x CPE...-PRSG-2 5x CPE...-PRSEO-2 1x CPE...-PRS-EP	1x CPE...-PRSGO-2 1x CPE...-PRSE-2 4x CPE...-PRSEO-2 1x CPE...-PRS-EP

 Note

A maximum of 6 valve positions are possible per air supply.
Use valve manifold blocks only in combination with 5/2- and 5/3-way valves.

Manifold blocks CPE14

Ordering data – Modular manifold

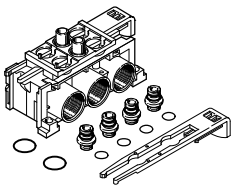
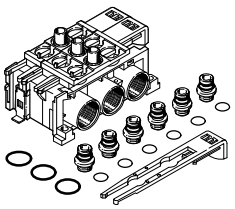
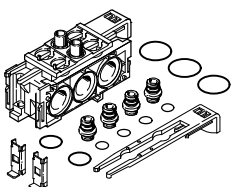
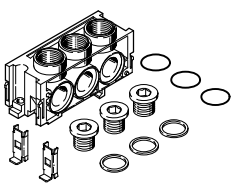
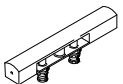
Ordering data					
	Port 1, 3, 5	PRS ducts	Weight [g]	Part No.	Type
Manifold block PRSG for 2 valves					
	G3/8	Closed	95	164965	CPE14-PRSG-2
	G3/8	Open	95	187829	CPE14-PRSGO-2
Manifold block PRSG for 3 valves					
	G3/8	Closed	130	187824	CPE14-PRSG-3
	G3/8	Open	130	187820	CPE14-PRSGO-3
Manifold block PRSE for 2 valves					
	-	Closed	85	164967	CPE14-PRSE-2
	-	Open	85	187830	CPE14-PRSEO-2
End plate for manifold					
	G3/8	-	80	164969	CPE14-PRS-EP
Blanking plate for unused valve position					
	-	-	15	164968	CPE14-PRSB

Solenoid valves CPE18

Technical data

Functions:

3/2G, 3/2O



5/2-way, single solenoid,

5/2-way, double solenoid valve

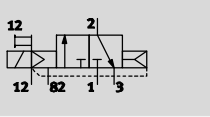
5/3G, 5/3B, 5/3E



3/2G with external pilot air supply, normally closed

-  - Width 18 mm
-  - Flow rate
850 ... 1500 l/min
-  - Voltage
24 V DC, 110, 230 V AC
Basic valves
12, 24 V DC, 24, 110,
230 V AC

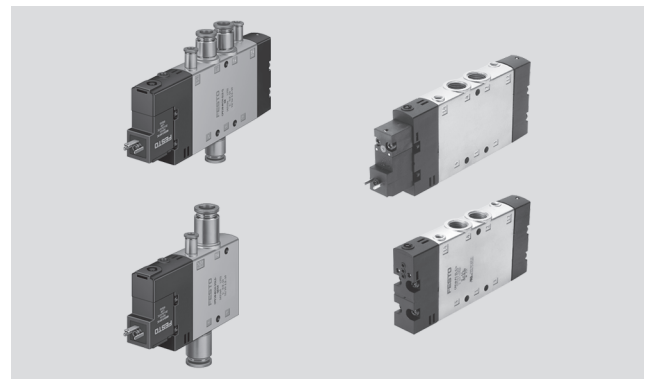

General technical data								
Valve function		3/2		5/2		5/3		
Normal position		G ¹⁾	O ²⁾	-	-	G ¹⁾	B ²⁾ E ³⁾	
Stable position		Monostable			Bistable		Monostable	
Reset method: pneumatic spring		Yes			-		No	
Reset method: mechanical spring		No			-		Yes	
Design		Piston spool						
Sealing principle		Soft						
Lap		Overlap						
Type of actuation		Electrical						
Type of control		Piloted						
Pilot interface		To ISO 15218 or none in the case of integrated pilot valve						
Pilot air supply		Internal or external						
Flow direction		-		Reversible with external pilot air supply				
Exhaust air function		-		With flow control				
Manual override		Non-detenting, detenting via accessory						
Type of mounting		Via through-holes						
Mounting position		Any						
Pneumatic connection	1, 2, 4	Threaded connection: G1/4 QS connection: Ø 8 or Ø 10 mm						
	3, 5	Threaded connection: G1/4						
	12, 14	Threaded connection: M5; QS connection: Ø 4 mm						
	82, 84	Threaded connection: M5						
Nominal width	[mm]	8						
Standard nominal flow rate	G ¹⁾	[l/min]	1300	1300	1450	1200	1300	
	QS8	[l/min]	850				780	
	QS10	[l/min]	1000				1050 1000	
Switching time	On/off	[ms]	28/18, 36/30 ⁵⁾		26/20, 32/30 ⁵⁾	-	20/38, 20/34 ⁵⁾	
	Changeover	[ms]	-		13, 15 ⁵⁾		-	
Duty cycle	[%]	100						
Width	[mm]	18						
Conforms to standard		ISO 15218 in the case of interface with pilot valve						
Corrosion resistance class CRC ⁴⁾		2						

1) G = normally closed

2) O, B = normally open

3) E = normally exhausted

4) Corrosion resistance class CRC 2 to Festo standard FN 940070

Moderate corrosion stress. Indoor applications in which condensation may occur. External visible parts with primarily decorative requirements for the surface and which are in direct contact with the ambient atmosphere typical for industrial applications.

5) Switching time for basic valve

Solenoid valves CPE18

Technical data

Operating and environmental conditions					
Valve function		3/2	5/2-way, single solenoid	5/2-way, double solenoid	5/3
Operating medium	Compressed air to ISO 8573-1:2010 [7:4:4]				
Pilot medium	Compressed air to ISO 8573-1:2010 [7:4:4]				
Note on operating/pilot medium	Lubricated operation possible (in which case lubricated operation will always be required)				
Operating pressure	Internal pilot air supply	[bar]	2.5 ... 10	2 ... 10	2.5 ... 10
	External pilot air supply	[bar]	-0.9 ... +10		
Pilot pressure		[bar]	2.5 ... 10	2 ... 10	2.5 ... 10
Ambient temperature		[°C]	-5 ... +50		
Temperature of medium		[°C]	-5 ... +50		
Certification for solenoid valves	c UL us - Recognized (OL) (not with CPE18-P1-...)				
Maritime classification ¹⁾	See certificate				

1) Additional information www.festo.com/sp → Certificates.

Electrical data				
Operating voltage	M1H	[V DC]	24 +10/-15%	
	M2H	[V AC]	110 ±10% at 50 ... 60 Hz	
	M3H	[V AC]	230 ±10% at 50 ... 60 Hz	
Power consumption	M1H	[W]	1.5	
	M2H, M3H	[VA]	Pull: 3, hold: 2.4	
Degree of protection with plug socket	IP65 to IEC 60529			

Materials

Sectional view

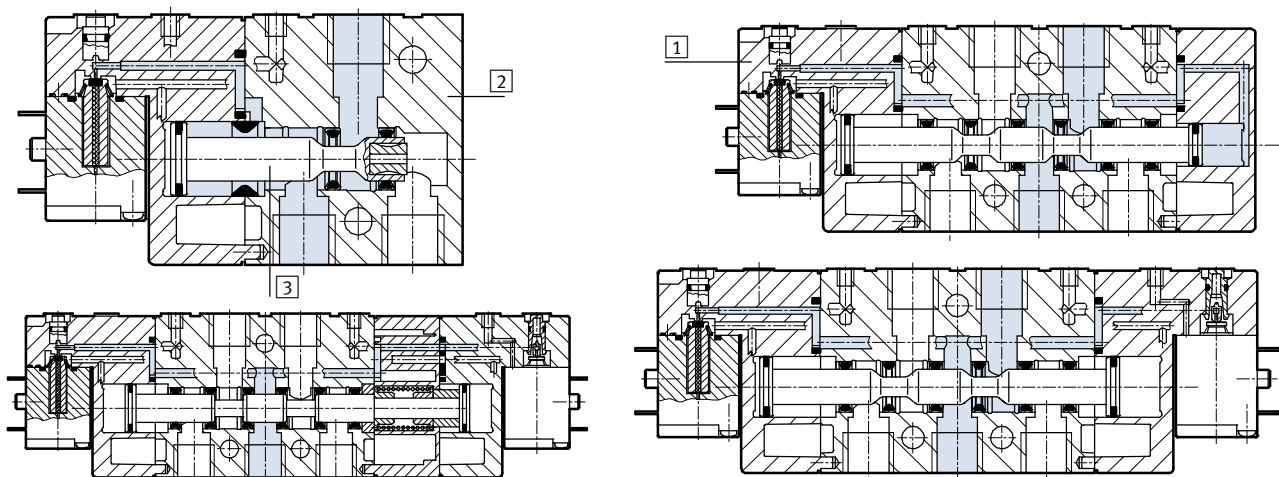

1	Cap	PA
2	Housing	Die-cast aluminium
3	Piston spool	Steel
-	Seals	NBR
	Note on materials	RoHS compliant

Solenoid valves CPE18

Technical data

Dimensions – 3/2-way valve

Download CAD data → www.festo.com

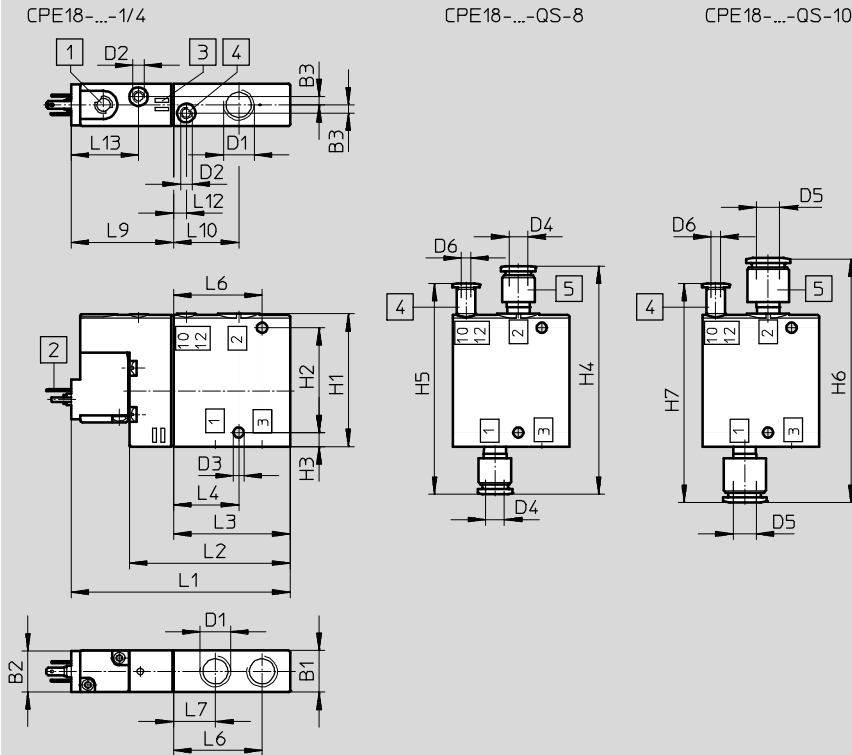

- 1 Manual override
- 2 Plug connector type C to EN 175301-803
- 3 Location for inscription labels
- 4 Port 10/12 for external pilot air supply
- 5 QS push-in fitting

Type	B1	B2	B3	D1	D2	D3 ∅	D4 ∅	D5 ∅	D6 ∅	H1	H2	H3	H4	H5	H6	H7
CPE18-M1H-3...	18	17.5	3.5	G1/4	M5	4.4	8	10	4	57	45	6	98	90.5	105	94

Type	L1	L2	L3	L4	L6	L7	L9	L10	L12	L13
CPE18-M1H-3...	94	69	50	28	38	18	44	28	5.5	29

Solenoid valves CPE18

Technical data

Dimensions – 5/2-way single solenoid valve

Download CAD data → www.festo.com

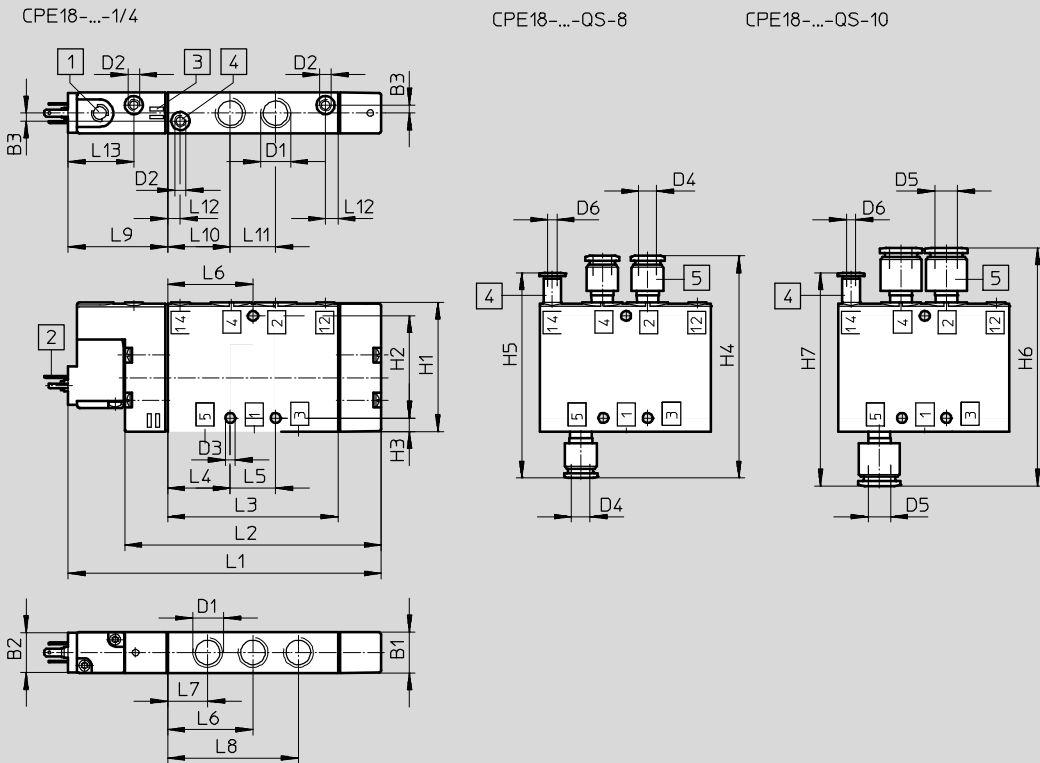

- 1 Manual override
- 2 Plug connector type C to EN 175301-803
- 3 Location for inscription labels
- 4 Port 12/14 for external pilot air supply
- 5 QS push-in fitting

Type	B1	B2	B3	D1	D2	D3 ∅	D4 ∅	D5 ∅	D6 ∅	H1	H2	H3	H4	H5	H6	H7
CPE18-M1H-5...	18	17.5	3.5	G1/4	M5	4.4	8	10	4	57	45	6	98	90.5	105	94

Type	L1	L2	L3	L4	L5	L6	L7	L8	L9	L10	L11	L12	L13
CPE18-M1H-5...	138	113	75	27.5	20	37.5	17.5	57.5	44	27.5	20	5.5	29

Solenoid valves CPE18

Technical data

Dimensions – 5/2-way double solenoid valve

Download CAD data → www.festo.com

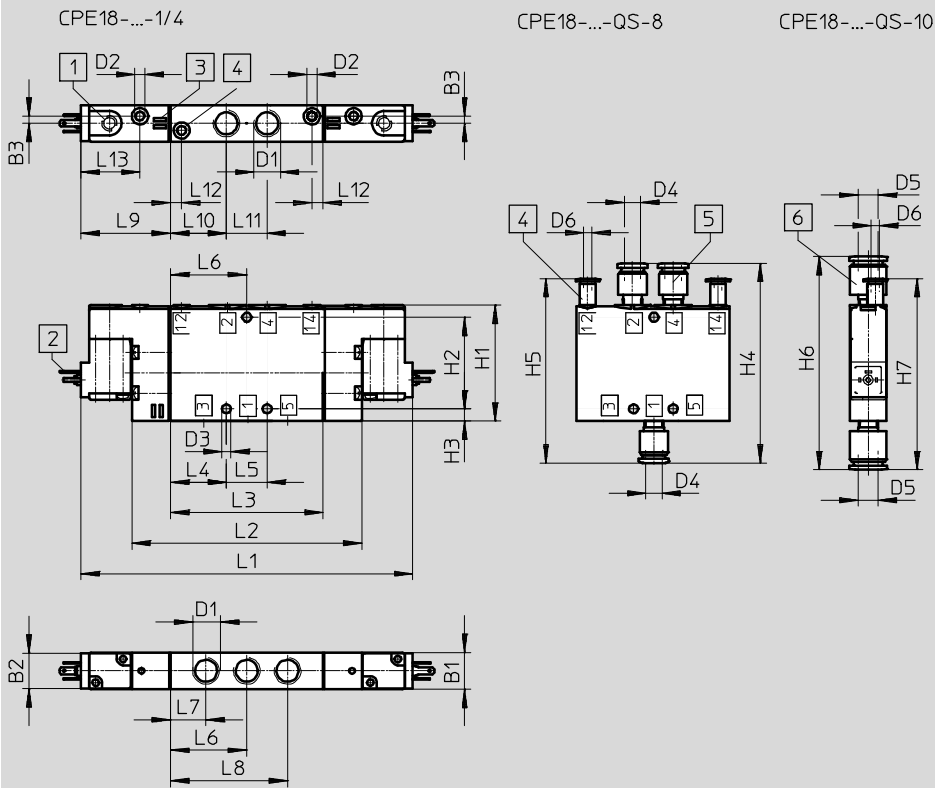

- 1 Manual override
- 2 Plug connector type C to EN 175301-803
- 3 Location for inscription labels
- 4 Port 12/14 for external pilot air supply
- 5/6 QS push-in fitting

Type	B1	B2	B3	D1	D2	D3	D4	D5	D6	H1	H2	H3	H4	H5	H6	H7
CPE18-...-5J-1/4	18	17.5	3.5	G1/4	M5	4.4	8	10	4	57	45	6	98	90.5	105	94

Type	L1	L2	L3	L4	L5	L6	L7	L8	L9	L10	L11	L12	L13
CPE18-...-5J-1/4	163	113	75	27.5	20	37.5	17.5	57.5	44	27.5	20	5.5	29

Solenoid valves CPE18

Technical data



Dimensions – 5/3-way valve

Download CAD data → www.festo.com

CPE18-...-1/4

CPE18-...-QS-8

CPE18-...-QS-10

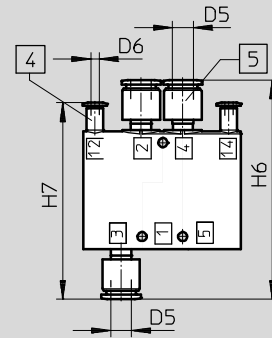
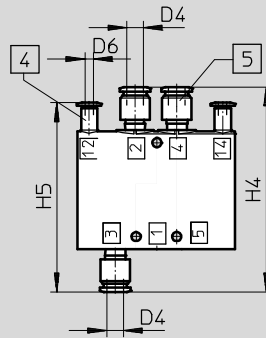
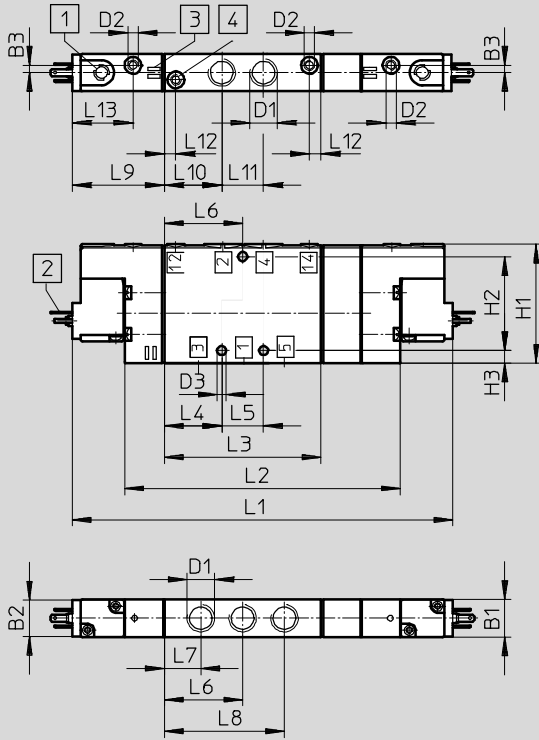

- 1 Manual override
- 2 Plug connector type C to EN 175301-803
- 3 Location for inscription labels
- 4 Port 12/14 for external pilot air supply
- 5 QS push-in fitting

Type	B1	B2	B3	D1	D2	D3 ∅	D4 ∅	D5 ∅	D6 ∅	H1	H2	H3	H4	H5	H6	H7
CPE18-M1H...-5L	18	17.5	3.5	G1/4	M5	4.4	8	10	4	57	45	6	98	90.5	105	94
CPE18-M1H...-5/3																

Type	L1	L2	L3	L4	L5	L6	L7	L8	L9	L10	L11	L12	L13
CPE18-M1H...-5J	163	113	75	27.5	20	37.5	17.5	57.5	44	27.5	20	5.5	29
CPE18-M1H...-5/3	182	132											

Solenoid valves CPE18

Ordering data

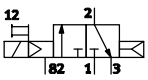
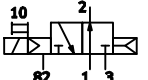
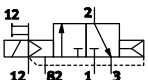
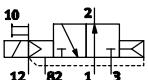
Ordering data – 3/2-way valve						
Circuit symbol	Pilot air supply	Voltage	Pneumatic connection	Weight [g]	Part No.	Type
Normally closed						
	Internal	24 V DC	G1/4	150	163141	CPE18-M1H-3GL-1/4
			QS-8	–	163149	CPE18-M1H-3GL-QS-8
			QS-10	–	163157	CPE18-M1H-3GL-QS-10
		110 V AC	G1/4	150	163761	CPE18-M2H-3GL-1/4
			QS-8	–	163769	CPE18-M2H-3GL-QS-8
			QS-10	–	163777	CPE18-M2H-3GL-QS-10
		230 V AC	G1/4	150	163785	CPE18-M3H-3GL-1/4
			QS-8	–	163793	CPE18-M3H-3GL-QS-8
			QS-10	–	163801	CPE18-M3H-3GL-QS-10
Normally open						
	Internal	24 V DC	G1/4	150	163140	CPE18-M1H-3OL-1/4
			QS-8	–	163148	CPE18-M1H-3OL-QS-8
			QS-10	–	163156	CPE18-M1H-3OL-QS-10
		110 V AC	G1/4	150	163760	CPE18-M2H-3OL-1/4
			QS-8	–	163768	CPE18-M2H-3OL-QS-8
			QS-10	–	163776	CPE18-M2H-3OL-QS-10
		230 V AC	G1/4	150	163784	CPE18-M3H-3OL-1/4
			QS-8	–	163792	CPE18-M3H-3OL-QS-8
			QS-10	–	163800	CPE18-M3H-3OL-QS-10
Normally closed						
	External	24 V DC	G1/4	150	163145	CPE18-M1H-3GLS-1/4
			QS-8	–	163153	CPE18-M1H-3GLS-QS-8
			QS-10	–	163161	CPE18-M1H-3GLS-QS-10
		110 V AC	G1/4	150	163765	CPE18-M2H-3GLS-1/4
			QS-8	–	163773	CPE18-M2H-3GLS-QS-8
			QS-10	–	163781	CPE18-M2H-3GLS-QS-10
		230 V AC	G1/4	150	163789	CPE18-M3H-3GLS-1/4
			QS-8	–	163797	CPE18-M3H-3GLS-QS-8
			QS-10	–	163805	CPE18-M3H-3GLS-QS-10
Normally open						
	External	24 V DC	G1/4	150	163144	CPE18-M1H-3OLS-1/4
			QS-8	–	163152	CPE18-M1H-3OLS-QS-8
			QS-10	–	163160	CPE18-M1H-3OLS-QS-10
		110 V AC	G1/4	150	163764	CPE18-M2H-3OLS-1/4
			QS-8	–	163772	CPE18-M2H-3OLS-QS-8
			QS-10	–	163780	CPE18-M2H-3OLS-QS-10
		230 V AC	G1/4	150	163788	CPE18-M3H-3OLS-1/4
			QS-8	–	163796	CPE18-M3H-3OLS-QS-8
			QS-10	–	163804	CPE18-M3H-3OLS-QS-10

Solenoid valves CPE18

Ordering data

Ordering data – 5/2-way valve							
Circuit symbol	Pilot air supply	Voltage	Pneumatic connection	Weight [g]	Part No.	Type	
5/2 way valve, single solenoid							
	Internal	24 V DC	G1/4	220	163142	CPE18-M1H-5L-1/4	
			QS-8	–	163150	CPE18-M1H-5L-QS-8	
			QS-10	–	163158	CPE18-M1H-5L-QS-10	
		110 V AC	220	G1/4	220	163762	CPE18-M2H-5L-1/4
				QS-8	–	163770	CPE18-M2H-5L-QS-8
				QS-10	–	163778	CPE18-M2H-5L-QS-10
		230 V AC	220	G1/4	220	163786	CPE18-M3H-5L-1/4
				QS-8	–	163794	CPE18-M3H-5L-QS-8
				QS-10	–	163802	CPE18-M3H-5L-QS-10
5/2-way valve, double solenoid							
	Internal	24 V DC	G1/4	270	163143	CPE18-M1H-5J-1/4	
			QS-8	–	163151	CPE18-M1H-5J-QS-8	
			QS-10	–	163159	CPE18-M1H-5J-QS-10	
		110 V AC	270	G1/4	270	163763	CPE18-M2H-5J-1/4
				QS-8	–	163771	CPE18-M2H-5J-QS-8
				QS-10	–	163779	CPE18-M2H-5J-QS-10
		230 V AC	270	G1/4	270	163787	CPE18-M3H-5J-1/4
				QS-8	–	163795	CPE18-M3H-5J-QS-8
				QS-10	–	163803	CPE18-M3H-5J-QS-10
5/2 way valve, single solenoid							
	External	24 V DC	G1/4	220	163146	CPE18-M1H-5LS-1/4	
			QS-8	–	163154	CPE18-M1H-5LS-QS-8	
			QS-10	–	163162	CPE18-M1H-5LS-QS-10	
		110 V AC	220	G1/4	220	163766	CPE18-M2H-5LS-1/4
				QS-8	–	163774	CPE18-M2H-5LS-QS-8
				QS-10	–	163782	CPE18-M2H-5LS-QS-10
		230 V AC	220	G1/4	220	163790	CPE18-M3H-5LS-1/4
				QS-8	–	163798	CPE18-M3H-5LS-QS-8
				QS-10	–	163806	CPE18-M3H-5LS-QS-10
5/2-way valve, double solenoid							
	External	24 V DC	G1/4	270	163147	CPE18-M1H-5JS-1/4	
			QS-8	–	163155	CPE18-M1H-5JS-QS-8	
			QS-10	–	163163	CPE18-M1H-5JS-QS-10	
		110 V AC	270	G1/4	270	163767	CPE18-M2H-5JS-1/4
				QS-8	–	163775	CPE18-M2H-5JS-QS-8
				QS-10	–	163783	CPE18-M2H-5JS-QS-10
		230 V AC	270	G1/4	270	163791	CPE18-M3H-5JS-1/4
				QS-8	–	163799	CPE18-M3H-5JS-QS-8
				QS-10	–	163807	CPE18-M3H-5JS-QS-10

Solenoid valves CPE18

Ordering data

Ordering data – 5/3-way valve						
Circuit symbol	Pilot air supply	Voltage	Pneumatic connection	Weight [g]	Part No.	Type
5/3-way mid-position valve, normally closed						
	Internal	24 V DC	G1/4	280	170247	CPE18-M1H-5/3G-1/4
			QS-8	–	170253	CPE18-M1H-5/3G-QS-8
			QS-10	–	170259	CPE18-M1H-5/3G-QS-10
		110 V AC	G1/4	280	170283	CPE18-M2H-5/3G-1/4
			QS-8	–	170289	CPE18-M2H-5/3G-QS-8
			QS-10	–	170295	CPE18-M2H-5/3G-QS-10
		230 V AC	G1/4	280	170319	CPE18-M3H-5/3G-1/4
			QS-8	–	170325	CPE18-M3H-5/3G-QS-8
			QS-10	–	170331	CPE18-M3H-5/3G-QS-10
5/3-way mid-position valve, normally exhausted						
	Internal	24 V DC	G1/4	280	170249	CPE18-M1H-5/3E-1/4
			QS-8	–	170255	CPE18-M1H-5/3E-QS-8
			QS-10	–	170261	CPE18-M1H-5/3E-QS-10
		110 V AC	G1/4	280	170285	CPE18-M2H-5/3E-1/4
			QS-8	–	170291	CPE18-M2H-5/3E-QS-8
			QS-10	–	170297	CPE18-M2H-5/3E-QS-10
		230 V AC	G1/4	280	170321	CPE18-M3H-5/3E-1/4
			QS-8	–	170327	CPE18-M3H-5/3E-QS-8
			QS-10	–	170333	CPE18-M3H-5/3E-QS-10
5/3-way mid-position valve, normally open						
	Internal	24 V DC	G1/4	280	170251	CPE18-M1H-5/3B-1/4
			QS-8	–	170257	CPE18-M1H-5/3B-QS-8
			QS-10	–	170263	CPE18-M1H-5/3B-QS10
		110 V AC	G1/4	280	170287	CPE18-M2H-5/3B-1/4
			QS-8	–	170293	CPE18-M2H-5/3B-QS-8
			QS-10	–	170299	CPE18-M2H-5/3B-QS-10
		230 V AC	G1/4	280	170323	CPE18-M3H-5/3B-1/4
			QS-8	–	170329	CPE18-M3H-5/3B-QS-8
			QS-10	–	170335	CPE18-M3H-5/3B-QS-10

Solenoid valves CPE18

Ordering data

Ordering data – 5/3-way valve						
Circuit symbol	Pilot air supply	Voltage	Pneumatic connection	Weight [g]	Part No.	Type
5/3-way mid-position valve, normally closed						
	External	24 V DC	G1/4	280	170248	CPE18-M1H-5/3GS-1/4
			QS-8	–	170254	CPE18-M1H-5/3GS-QS-8
			QS-10	–	170260	CPE18-M1H-5/3GS-QS-10
		110 V AC	G1/4	280	170284	CPE18-M2H-5/3GS-1/4
			QS-8	–	170290	CPE18-M2H-5/3GS-QS-8
			QS-10	–	170296	CPE18-M2H-5/3GS-QS10
		230 V AC	G1/4	280	170320	CPE18-M3H-5/3GS-1/4
			QS-8	–	170326	CPE18-M3H-5/3GS-QS-8
			QS-10	–	170332	CPE18-M3H-5/3GS-QS10
5/3-way mid-position valve, normally exhausted						
	External	24 V DC	G1/4	280	170250	CPE18-M1H-5/3ES-1/4
			QS-8	–	170256	CPE18-M1H-5/3ES-QS-8
			QS-10	–	170262	CPE18-M1H-5/3ES-QS-10
		110 V AC	G1/4	280	170286	CPE18-M2H-5/3ES-1/4
			QS-8	–	170292	CPE18-M2H-5/3ES-QS-8
			QS-10	–	170298	CPE18-M2H-5/3ES-QS10
		230 V AC	G1/4	280	170322	CPE18-M3H-5/3ES-1/4
			QS-8	–	170328	CPE18-M3H-5/3ES-QS-8
			QS-10	–	170334	CPE18-M3H-5/3ES-QS10
5/3-way mid-position valve, normally open						
	External	24 V DC	G1/4	280	170252	CPE18-M1H-5/3BS-1/4
			QS-8	–	170258	CPE18-M1H-5/3BS-QS-8
			QS-10	–	170264	CPE18-M1H-5/3BS-QS-10
		110 V AC	G1/4	280	170288	CPE18-M2H-5/3BS-1/4
			QS-8	–	170294	CPE18-M2H-5/3BS-QS-8
			QS-10	–	170300	CPE18-M2H-5/3BS-QS-10
		230 V AC	G1/4	280	170324	CPE18-M3H-5/3BS-1/4
			QS-8	–	170330	CPE18-M3H-5/3BS-QS-8
			QS-10	–	170336	CPE18-M3H-5/3BS-QS-10

Basic valves CPE18

Technical data – Directional control valves without pilot valve

Materials

Sectional view

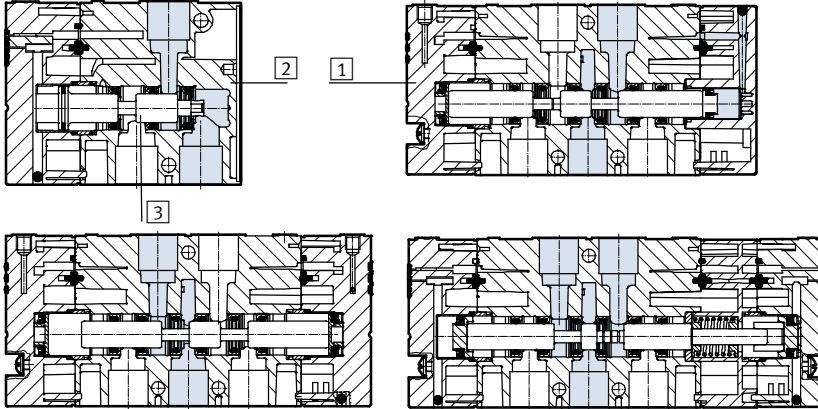

1	Cap	PA
2	Housing	Die-cast aluminium
3	Piston spool	Steel
-	Seals	NBR
Note on materials		RoHS compliant

Dimensions – 3/2-way valve

Download CAD data → www.festo.com

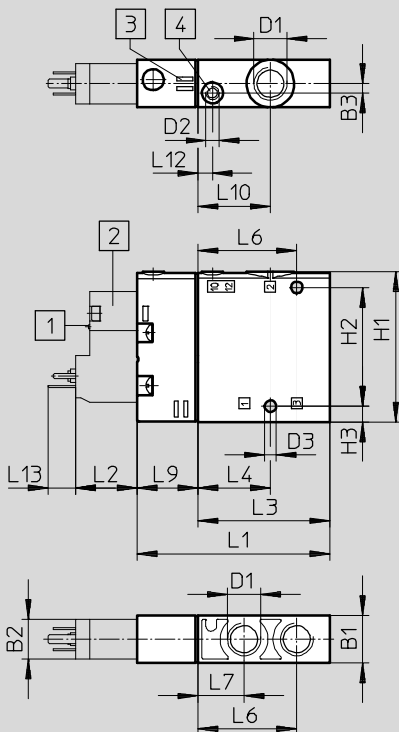

- 1 Manual override
- 2 Pilot valve, type C
- 3 Location for inscription label
- 4 Port 10/12 for external pilot air

Type	B1	B2	B3	D1	D2	D3 ∅	H1	H2	H3	L1	L2	L3	L4	L6	L7	L9	L10	L12	L13
CPE18-P1-3	18	15.2	3.5	G1/4	M5	4.4	57	45	6	73	23.3	50	27.5	37.5	17.5	23	27.5	5.5	10.5

Basic valves CPE18

Technical data – Directional control valves without pilot valve

Dimensions – 5/2-way valve

Download CAD data → www.festo.com

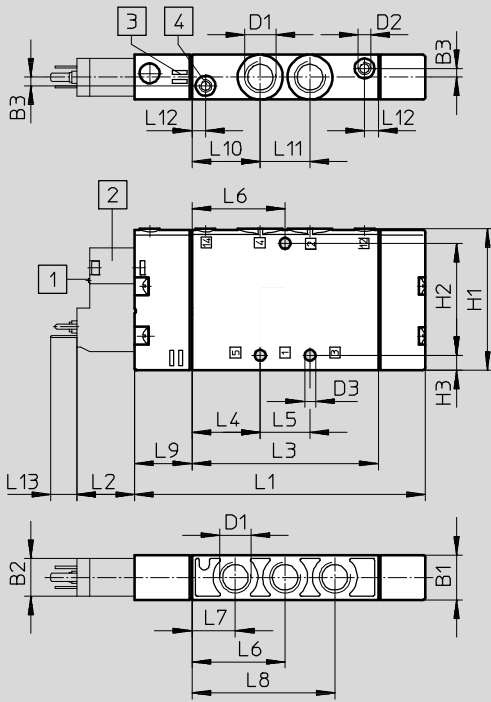

- 1 Manual override
- 2 Pilot valve, plug connector type C to EN 175301-803
- 3 Location for inscription label
- 4 Port 12/14 for external pilot air supply

Type	B1	B2	B3	D1	D2	D3 Ø	H1	H2	H3	L1	L2	L3	L4	L5	L6	L7	L8	L9	L10	L11	L12	L13
CPE18-P1-5L	18	15.2	3.5	G1/4	M5	4.4	57	45	6	117	23.3	75	27.5	20	37.5	17.5	57.5	23	27.5	20	5.5	10.5

Dimensions – 5/2-way double solenoid valve

Download CAD data → www.festo.com

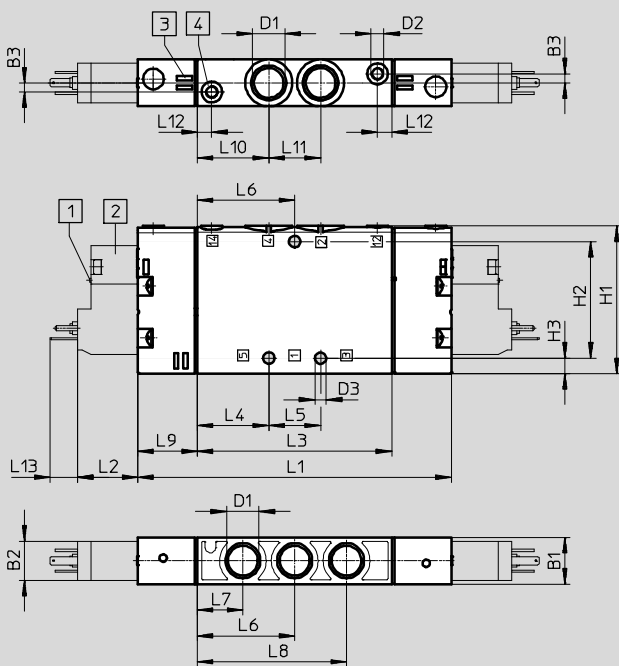

- 1 Manual override
- 2 Pilot valve, plug connector type C to EN 175301-803
- 3 Location for inscription label
- 4 Port 12/14 for external pilot air supply

Type	B1	B2	B3	D1	D2	D3 Ø	H1	H2	H3	L1	L2	L3	L4	L5	L6	L7	L8	L9	L10	L11	L12	L13
CPE18-P1-5J	18	15.2	3.5	G1/4	M5	4.4	57	45	6	121	23.3	75	27.5	20	37.5	17.5	57.5	23	27.5	20	5.5	10.5

Basic valves CPE18

Technical data – Directional control valves without pilot valve

Dimensions – 5/3-way valve

Download CAD data → www.festo.com

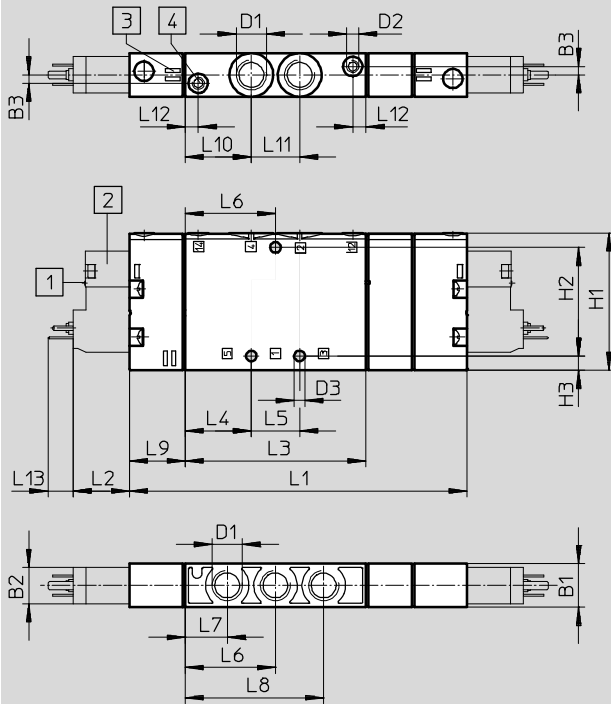

- 1 Manual override
- 2 Pilot valve, plug connector type C to EN 175301-803
- 3 Location for inscription label
- 4 Port 12/14 for external pilot air supply

Type	B1	B2	B3	D1	D2	D3 Ø	H1	H2	H3	L1	L2	L3	L4	L5	L6	L7	L8	L9	L10	L11	L12	L13
CPE18-P1-5J	18	15.2	3.5	G1/4	M5	4.4	57	45	6	121	23.3	75	27.5	20	37.5	17.5	57.5	23	27.5	20	5.5	10.5
CPE18-P1-5/3										140												

Basic valves CPE18

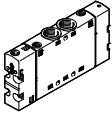

Ordering data

Ordering data – 3/2-way valve without pilot valve					
Design	Normal position	Pilot air supply	Weight [g]	Part No.	Type
	Closed	Internal	110	550163	CPE18-P1-3GL-1/4
	Open			550165	CPE18-P1-3OL-1/4
	Closed	External		550164	CPE18-P1-3GLS-1/4
	Open			550166	CPE18-P1-3OLS-1/4

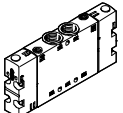
Ordering data – 5/2-way single solenoid valve without pilot valve					
Design		Pilot air supply	Weight [g]	Part No.	Type
	–	Internal	180	550153	CPE18-P1-5L-1/4
		External		550154	CPE18-P1-5LS-1/4

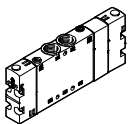
Ordering data – 5/2-way double solenoid valve without pilot valve					
Design		Pilot air supply	Weight [g]	Part No.	Type
	–	Internal	190	550155	CPE18-P1-5J-1/4
		External		550156	CPE18-P1-5JS-1/4

Ordering data – 5/3-way mid-position valve without pilot valve					
Design	Normal position	Pilot air supply	Weight [g]	Part No.	Type
	Closed	Internal	200	550157	CPE18-P1-5/3G-1/4
	Open			550159	CPE18-P1-5/3E-1/4
	Exhausted			550161	CPE18-P1-5/3B-1/4
	Closed	External		550158	CPE18-P1-5/3GS-1/4
	Open			550160	CPE18-P1-5/3ES-1/4
	Exhausted			550162	CPE18-P1-5/3BS-1/4

Ordering data – Pilot valve to ISO 15218								
Design	Plug, square design	PE conductor	Power		Voltage		Part No.	Type
			[W]	[VA]	[V DC]	[V AC]		
	Type C to EN 175301-803	No	1.8	–	24	–	546256	VSCS-B-M32-MH-WA-1C1
					12	–	546257	VSCS-B-M32-MH-WA-5C1
	Type C to EN 175301-803	Yes	–	2.1	–	230	546260	VSCS-B-M32-MH-WA-3AC1
		Yes	–	2.1	–	110	546259	VSCS-B-M32-MH-WA-2AC1
	Type C to EN 175301-803	No	–	2.3	–	24	546258	VSCS-B-M32-MH-WA-1AC1

Manifold blocks CPE18

Technical data – Fixed-grid manifold block



Manifold block

For CPE18 5/2 and 5/3

Materials:

Wrought aluminium alloy

RoHS compliant

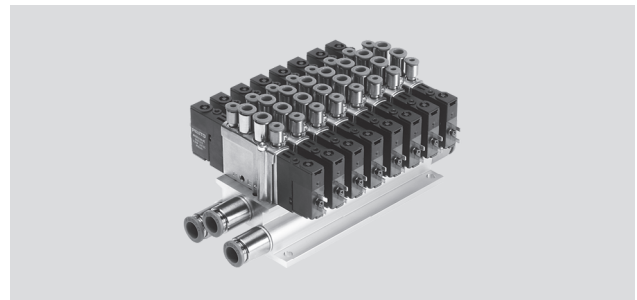

Dimensions – Fixed-grid manifold 5/2 and 5/3

Download CAD data → www.festo.com

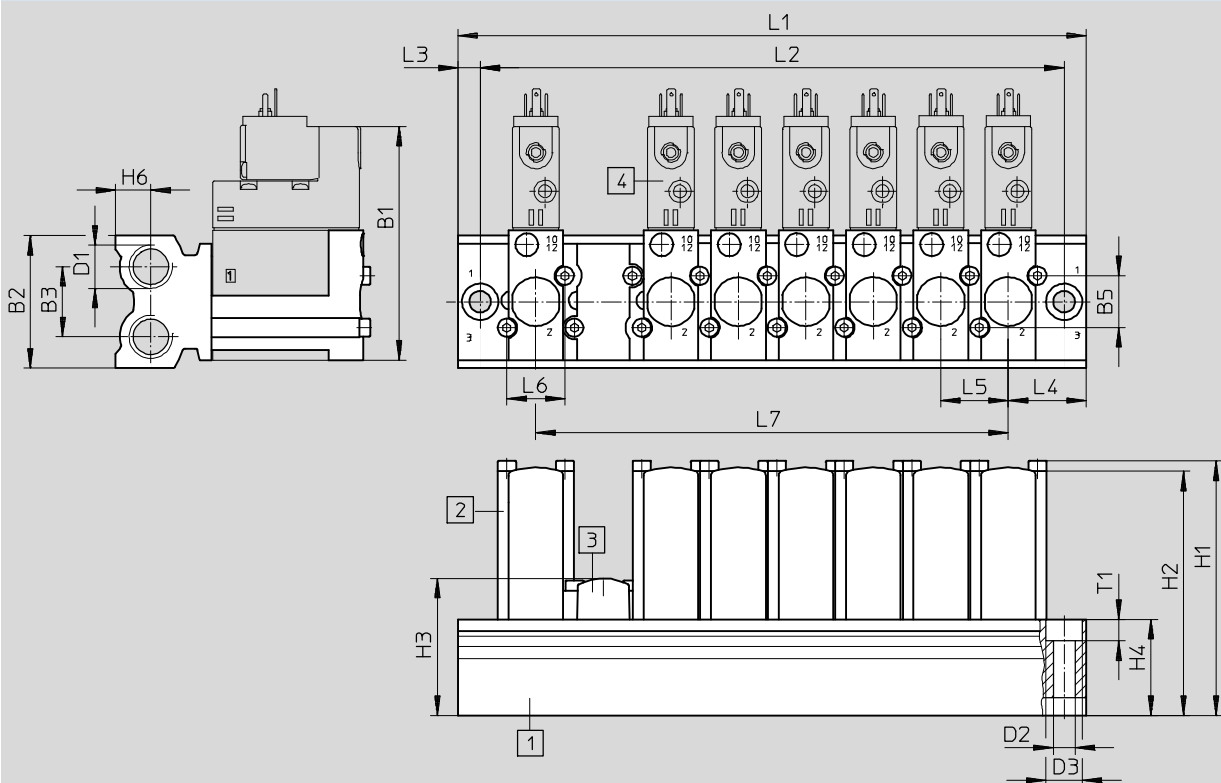

- 1 Manifold block
Grid dimension 26 mm
- 2 Retainer
- 3 Cover plate
- 4 Valves

Type	B1	B2	B3	B4	B5	D1	D2	H1	H2	H3	H4	H5	H6
CPE18-PRS...	155	102	46	86.5	40	G3/8	8.3	105	101.45	59.8	44	30.5	14

Type	L1	L2	L3	L4	L5	L6	L7
CPE18-PRS...	$45 + (n-1) \times 26$	$L1 - 17 \pm 0.1$	8.5	22.5	26	22.4	$(n-1) \times 26$



Manifold blocks CPE18

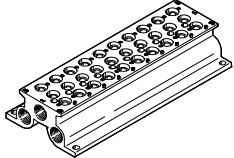

Ordering data – Fixed-grid manifold block

Ordering data						
	Valve positions	CRC ¹⁾	Max. tightening torque for valve mounting [Nm]	Weight [g]	Part No.	Type
Manifold block for 5/2- and 5/3-way valves						
	2	2	2	353	543839	CPE18-PRS-3/8-2
	3			482	543840	CPE18-PRS-3/8-3
	4			611	543841	CPE18-PRS-3/8-4
	5			740	543842	CPE18-PRS-3/8-5
	6			870	543843	CPE18-PRS-3/8-6
	7			999	543844	CPE18-PRS-3/8-7
	8			1128	543845	CPE18-PRS-3/8-8
	9			1257	543846	CPE18-PRS-3/8-9
	10			1386	543847	CPE18-PRS-3/8-10

1) Corrosion resistance class CRC 2 to Festo standard FN 940070

Moderate corrosion stress. Indoor applications in which condensation may occur. External visible parts with primarily decorative requirements for the surface and which are in direct contact with the ambient atmosphere typical for industrial applications.

Ordering data			
	Material	Part No.	Type
Blanking plate for unused valve position			
	PA	544481	CPE18-RP
Retainer set			
	Retainer: High-alloy stainless steel Screws: Galvanised steel Seals: NBR	544396	CPE18-H5-SET

Ordering data			
	Material	Part No.	Type
Retainer			
	Retainer: High-alloy stainless steel (packaging unit 50 pieces)	547047	CPE18-H5-50
Screws			
	Galvanised steel (packaging unit 100 pieces)	547050	M4X65-8.8-VS-100
Seals			
	NBR (packaging unit 150 pieces)	547053	CPV18-VI-P.1/4-150

Manifold blocks CPE18

Technical data – Fixed-grid manifold block



Manifold block

For CPE18 3/2

Materials:

Wrought aluminium alloy

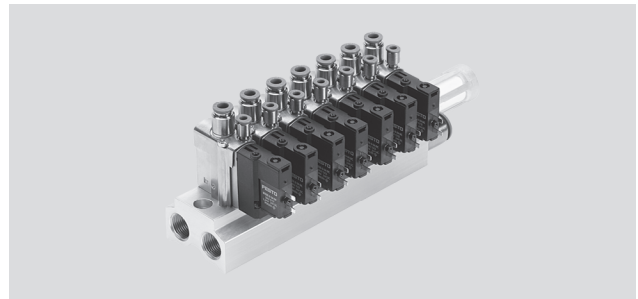

Dimensions – Fixed-grid manifold 3/2

Download CAD data → www.festo.com

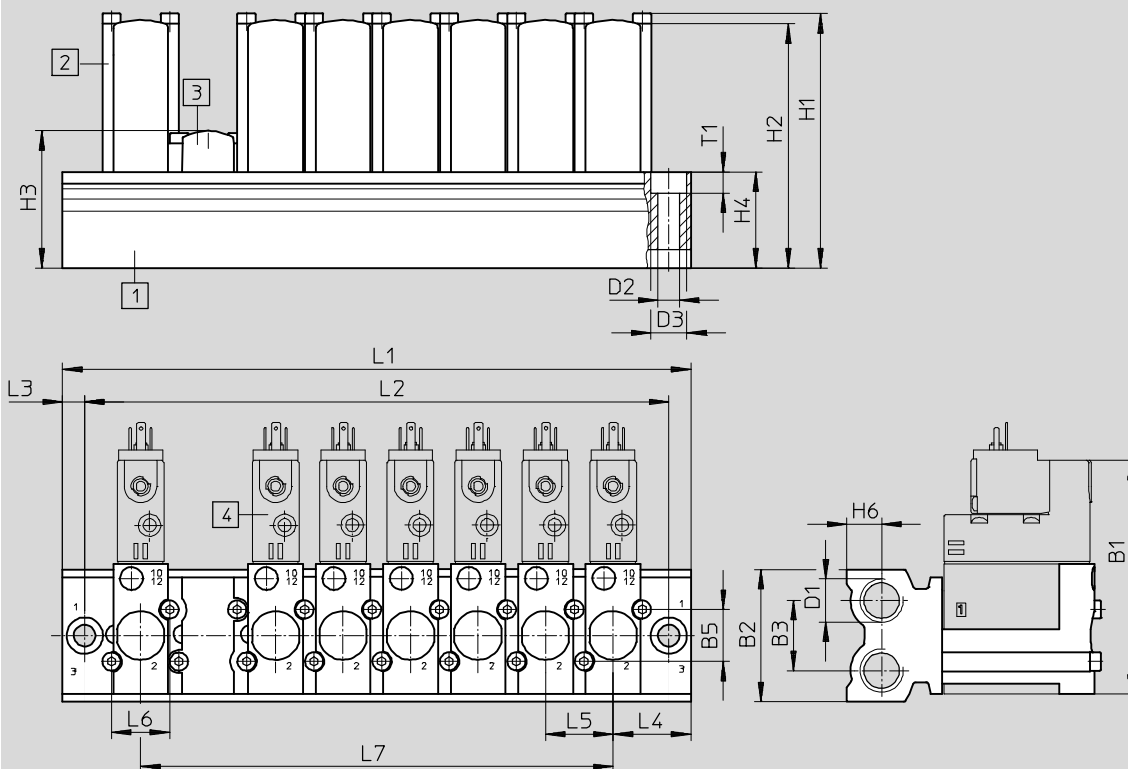

- 1 Manifold block
Grid dimension 26 mm
- 2 Retainer
- 3 Cover plate
- 4 Valves

Type	B1	B2	B3	B5	D1	D2	H1	H2	H3	H4	H6
CPE18-3/2-PRS...	90	51	27	200	G3/8	8.3	98	94	52.8	37	13.5

Type	L1	L2	L3	L4	L5	L6	L7	T1
CPE18-3/2-PRS...	$60 + (n-1) \times 26$	$43 + (n-1) \times 26$	8.5	24	26	22.4	$(n-1) \times 26$	8.3

Manifold blocks CPE18

Ordering data – Fixed-grid manifold block

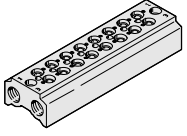

FESTO

Ordering data						
	Valve positions	CRC ¹⁾	Max. tightening torque for valve mounting [Nm]	Weight [g]	Part No.	Type
Manifold block for 3/2-way valves						
	2	2	2	266	550568	CPE18-3/2-PRS-3/8-2
	3			346	550569	CPE18-3/2-PRS-3/8-3
	4			426	550570	CPE18-3/2-PRS-3/8-4
	5			507	550571	CPE18-3/2-PRS-3/8-5
	6			587	550572	CPE18-3/2-PRS-3/8-6
	7			667	550573	CPE18-3/2-PRS-3/8-7
	8			748	550574	CPE18-3/2-PRS-3/8-8
	9			828	550575	CPE18-3/2-PRS-3/8-9
	10			908	550576	CPE18-3/2-PRS-3/8-10

1) Corrosion resistance class CRC 2 to Festo standard FN 940070

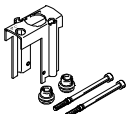
Moderate corrosion stress. Indoor applications in which condensation may occur. External visible parts with primarily decorative requirements for the surface and which are in direct contact with the ambient atmosphere typical for industrial applications.

Ordering data			
	Material	Part No.	Type
Cover plate			
	PA	550582	CPE18-RP3
Retainer set			
	Retainer: High-alloy stainless steel Screws: Galvanised steel Seals: NBR	550579	CPE18-H3-SET

Ordering data			
	Material	Part No.	Type
Retainer			
	Retainer: High-alloy stainless steel (packaging unit 50 pieces)	551492	CPE18-H3-50
Screws			
	Galvanised steel (packaging unit 100 pieces)	547050	M4X65-8.8-VS-100
Seals			
	NBR (packaging unit 150 pieces)	547053	CPV18-VI-P.¼-150

Manifold blocks CPE18

Technical data – Modular manifold

Modular manifold block
For CPE18 5/2 and 5/3

Materials:
PA, reinforced

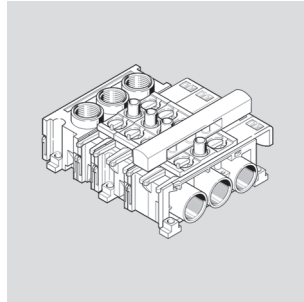

Dimensions – Modular manifold block

Download CAD data → www.festo.com

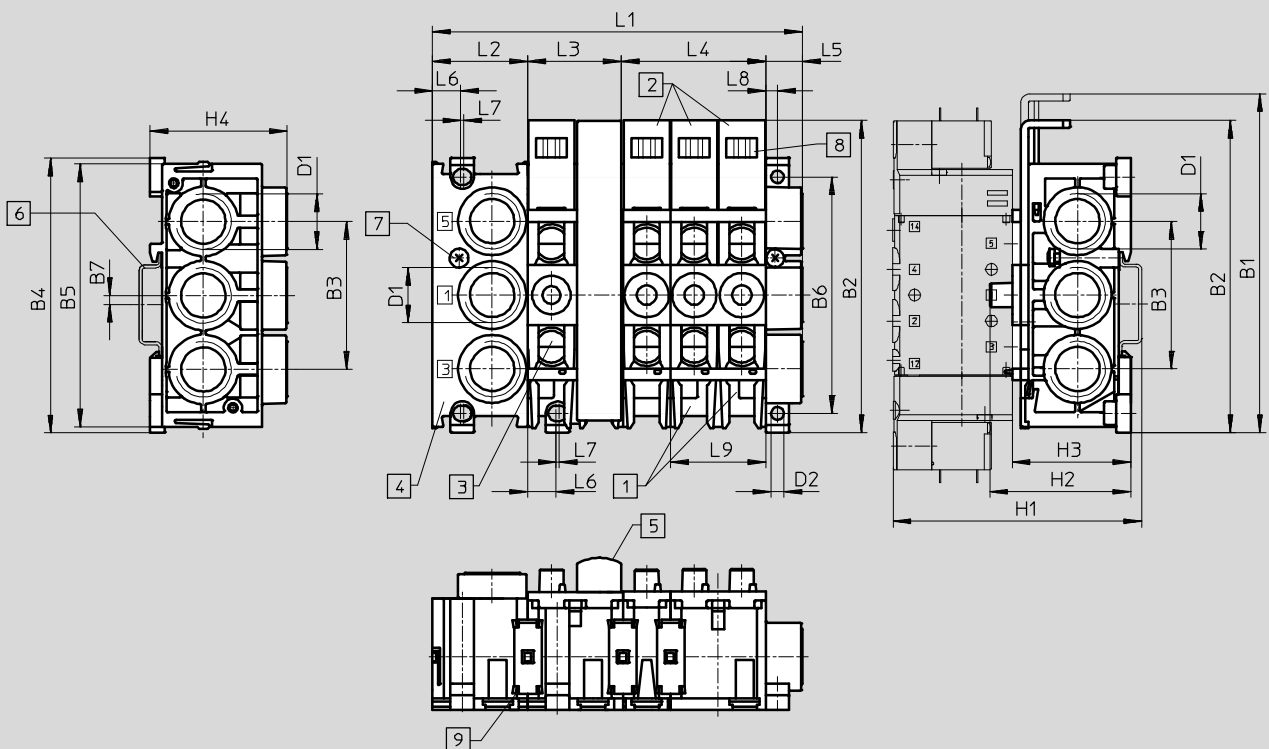

- | | | | |
|--|---|------------------------------------|---|
| 1) Manifold block
CPE...-PRSG...-2 for 2 valves | 3) Expansion block
CPE...-PRSE...-2 for 2 valves | 6) H-rail to EN 50002 for mounting | 8) Location for inscription labels
type IBS 6 x 10 |
| 2) Manifold block
CPE...-PRSG...-3 for 3 valves | 4) End block CPE...-PRS-EP | 7) Clamping screw for H-rail | 9) Connector |
| 5) Blanking plate CPE...-PRSB | | | |

Size	B1	B2	B3	B4	B5	B6	B7	D1	D2 ∅	H1	H2	H3	H4
CPE18	151.6	136.5	59	113	-	100	2.75	G1/2	5.3	~106	~58	~46	51,4

Size	L1 ¹⁾	L2	L3	L4	L5	L6	L7	L8	L9
CPE18	40+(nx20)+16.4	40	40	60	16.4	12.6	1	5.2	40

1) n = number of valve positions

Manifold blocks CPE18

Technical data – Modular manifold



Possible combinations			
Number of valve positions	One pressure zone	Two pressure zones	
		Variant 1	Variant 2
2	1x CPE...-PRSG-2	–	–
3	1x CPE...-PRSG-3	–	–
4	1x CPE...-PRSGO-2 1x CPE...-PRSE-2	1x CPE...-PRSG-2 1x CPE...-PRSEO-2 1x CPE...-PRS-EP	–
5	1x CPE...-PRSGO-3 1x CPE...-PRSE-2	1x CPE...-PRSG-3 1x CPE...-PRSEO-2 1x CPE...-PRS-EP	–
6	1x CPE...-PRSGO-2 1x CPE...-PRSEO-2 1x CPE...-PRSE-2	1x CPE...-PRSG-2 2x CPE...-PRSEO-2 1x CPE...-PRS-EP	1x CPE...-PRSGO-2 1x CPE...-PRSE-2 1x CPE...-PRSEO-2 1x CPE...-PRS-EP
7	1x CPE...-PRSGO-3 2x CPE...-PRSEO-2 1x CPE...-PRS-EP	1x CPE...-PRSG-3 2x CPE...-PRSEO-2 1x CPE...-PRS-EP	1x CPE...-PRSGO-3 1x CPE...-PRSE-2 1x CPE...-PRSEO-2 1x CPE...-PRS-EP
8	1x CPE...-PRSGO-2 3x CPE...-PRSEO-2 1x CPE...-PRS-EP	1x CPE...-PRSG-2 3x CPE...-PRSEO-2 1x CPE...-PRS-EP	1x CPE...-PRSGO-2 1x CPE...-PRSE-2 2x CPE...-PRSEO-2 1x CPE...-PRS-EP
9	1x CPE...-PRSGO-3 3x CPE...-PRSEO-2 1x CPE...-PRS-EP	1x CPE...-PRSG-3 3x CPE...-PRSEO-2 1x CPE...-PRS-EP	1x CPE...-PRSGO-3 1x CPE...-PRSE-2 2x CPE...-PRSEO-2 1x CPE...-PRS-EP
10	1x CPE...-PRSGO-2 4x CPE...-PRSEO-2 1x CPE...-PRS-EP	1x CPE...-PRSG-2 4x CPE...-PRSEO-2 1x CPE...-PRS-EP	1x CPE...-PRSGO-2 1x CPE...-PRSE-2 3x CPE...-PRSEO-2 1x CPE...-PRS-EP
11	1x CPE...-PRSGO-3 4x CPE...-PRSEO-2 1x CPE...-PRS-EP	1x CPE...-PRSG-3 4x CPE...-PRSEO-2 1x CPE...-PRS-EP	1x CPE...-PRSGO-3 1x CPE...-PRSE-2 3x CPE...-PRSEO-2 1x CPE...-PRS-EP
12	1x CPE...-PRSGO-2 5x CPE...-PRSEO-2 1x CPE...-PRS-EP	1x CPE...-PRSG-2 5x CPE...-PRSEO-2 1x CPE...-PRS-EP	1x CPE...-PRSGO-2 1x CPE...-PRSE-2 4x CPE...-PRSEO-2 1x CPE...-PRS-EP

 Note
 A maximum of 6 valve positions are possible per air supply.
 Use valve manifold blocks only in combination with 5/2- and 5/3-way valves.

Manifold blocks CPE18

Ordering data – Modular manifold

FESTO

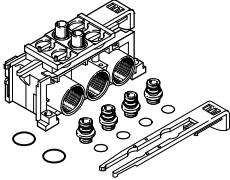
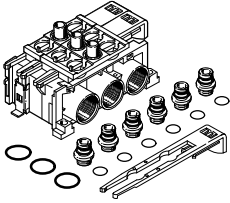
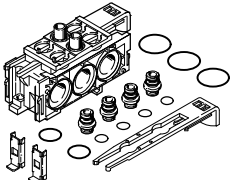
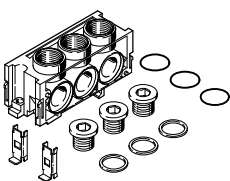
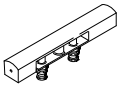
Ordering data					
	Port 1, 3, 5	PRS ducts	Weight [g]	Part No.	Type
Manifold block PRSG for 2 valves					
	G1/2	Closed	170	164970	CPE18-PRSG-2
	G1/2	Open	170	187831	CPE18-PRSGO-2
Manifold block PRSG for 3 valves					
	G1/2	Closed	225	187825	CPE18-PRSG-3
	G1/2	Open	225	187821	CPE18-PRSGO-3
Manifold block PRSE for 2 valves					
	-	Closed	145	164972	CPE18-PRSE-2
	-	Open	145	187832	CPE18-PRSEO-2
End plate for manifold					
	G1/2	-	125	164973	CPE18-PRS-EP
Blanking plate for unused valve position					
	-	-	28	164974	CPE18-PRSB

Solenoid valves CPE24

Technical data

FESTO

Functions:

3/2G, 3/2O



5/2-way, single solenoid,

5/2-way valve, double solenoid

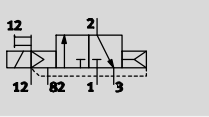
5/3G, 5/3B, 5/3E



3/2G with external pilot air supply, normally closed

-  - Width 24 mm
-  - Flow rate
1250 ... 3200 l/min
-  - Voltage
24 V DC, 110, 230 V AC
Basic valve
12, 24 V DC, 24, 110,
230 V AC

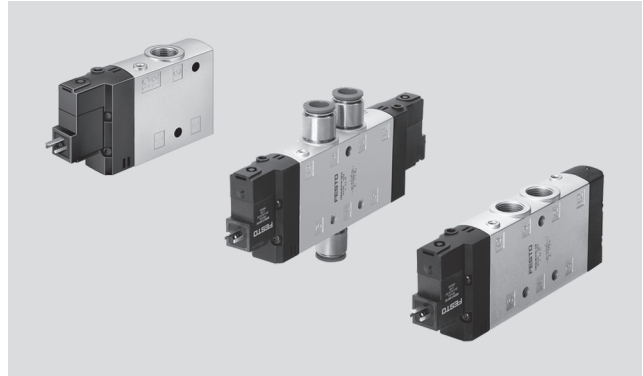

General technical data							
Valve function	3/2		5/2		5/3		
Normal position	G ¹⁾	O ²⁾	-		G ¹⁾	B ²⁾	E ³⁾
Stable position	Monostable			Bistable		Monostable	
Reset method: pneumatic spring	Yes			-		No	
Reset method: mechanical spring	No			-		Yes	
Design	Piston spool						
Sealing principle	Soft						
Lap	Overlap						
Type of actuation	Electrical						
Type of control	Pilot						
Pilot air supply	Internal or external						
Flow direction	-		Reversible with external pilot air supply				
Exhaust function			With flow control				
Manual override	Non-detenting, detenting via accessory						
Type of mounting	Via through-holes						
Mounting position	Any						
Pneumatic connection	1, 2, 4	Threaded connection: G3/8; QS connection: Ø 10 or Ø 12 mm					
	3, 5	Threaded connection: G3/8					
	12, 14	Threaded connection: M5; QS connection: Ø 6 mm					
	82, 84	Threaded connection: M5					
Nominal width	[mm]	11					
Standard nominal flow rate	G3/8	[l/min]	2500	3200	3000	2600	2650
	QS10	[l/min]	1250				
	QS12	[l/min]	1650				
Switching time	On/off	[ms]	50/33	40/50	-	25/55	
	Changeover	[ms]	-		25	-	
Duty cycle	[%]	100					
Width	[mm]	24					
Corrosion resistance class CRC ⁴⁾	2						

1) G = normally closed

2) O, B = normally open

3) E = normally exhausted

4) Corrosion resistance class CRC 2 to Festo standard FN 940070

Moderate corrosion stress. Indoor applications in which condensation may occur. External visible parts with primarily decorative requirements for the surface and which are in direct contact with the ambient atmosphere typical for industrial applications.

Solenoid valves CPE24

Technical data

Operating and environmental conditions					
Valve function		3/2	5/2-way, single solenoid	5/2-way, double solenoid	5/3
Operating medium	Compressed air to ISO 8573-1:2010 [7:4:4]				
Pilot medium	Compressed air to ISO 8573-1:2010 [7:4:4]				
Note on operating/pilot medium	Lubricated operation possible (in which case lubricated operation will always be required)				
Operating pressure	Internal pilot air supply	[bar]	2.5 ... 10	2 ... 10	2.5 ... 10
	External pilot air supply	[bar]	-0.9 ... +10		
Pilot pressure		[bar]	2.5 ... 10	2 ... 10	2.5 ... 10
Ambient temperature		[°C]	-5 ... +50		
Temperature of medium		[°C]	-5 ... +50		
Approval certificate	c UL us - Recognized (OL)				
Maritime classification ¹⁾	See certificate				

1) Additional information www.festo.com/sp → Certificates.

Electrical data			
Operating voltage	M1H	[V DC]	24 +10/-15%
	M2H	[V AC]	110 ±10% at 50 ... 60 Hz
	M3H	[V AC]	230 ±10% at 50 ... 60 Hz
Power consumption	M1H	[W]	1.5
	M2H, M3H	[VA]	Pull: 3, hold: 2.4
Degree of protection with plug socket	IP65 to IEC 60529		

Materials

Sectional view

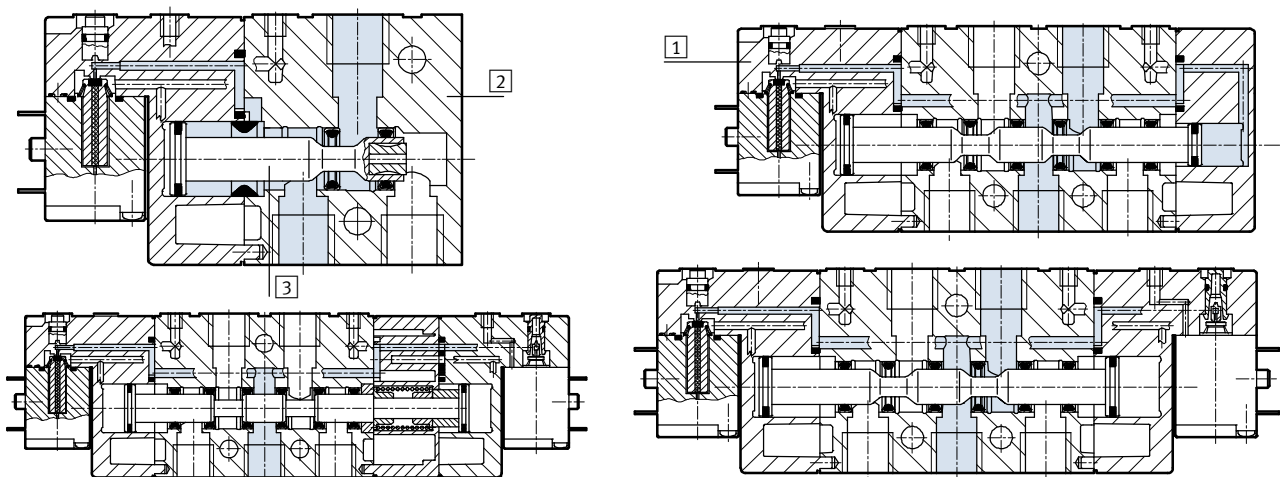

1	Cap	PA
2	Housing	Die-cast aluminium
3	Piston spool	Steel
-	Seals	NBR
Note on materials		RoHS compliant

Solenoid valves CPE24

Technical data

Dimensions – 3/2-way valve

Download CAD data → www.festo.com

CPE24-...-3/8

CPE24-...-QS-10

CPE24-...-QS-12

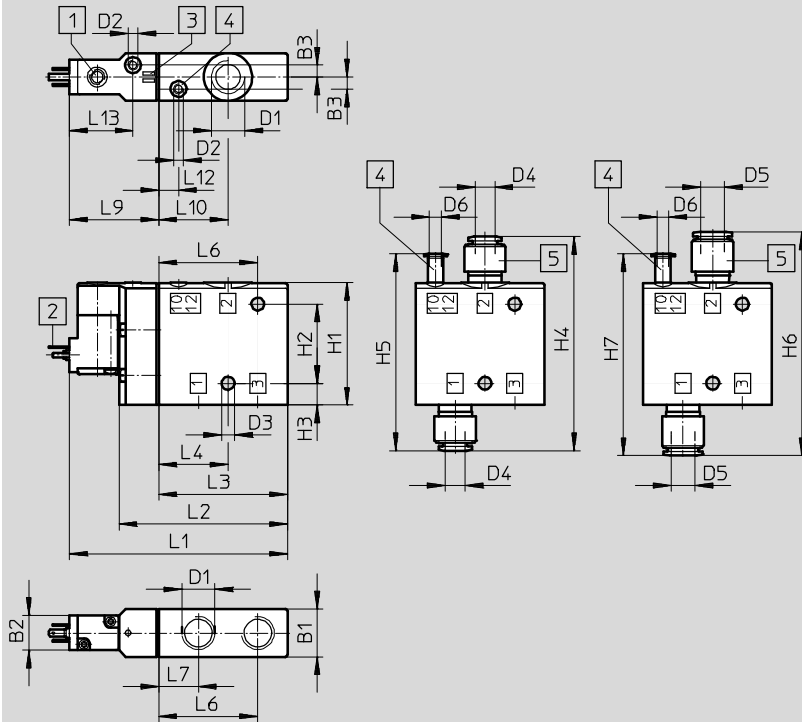

- 1 Manual override
- 2 Plug connector type C to EN 175301-803
- 3 Space for inscription labels
- 4 Port 10/12 for external pilot air supply
- 5 QS push-in fitting

Type	B1 ±0.1	B2 -0.5	B3	D1	D2	D3 ∅	D4 ∅	D5 ∅	D6 ∅	H1 ±0.25	H2	H3 ±0.1	H4	H5	H6	H7
CPE24-M1H-3...	24	17.5	6	G3/8	M5	6.5	10	12	6	62	40	11	108	99.5	113	102

Type	L1	L2	L3 ±0.2	L4 ±0.12	L6 ±0.15	L7 ±0.12	L9	L10	L12 ±0.12	L13
CPE124-M1H-3...	110	85	65	35	50	20	45	35	10	32

Solenoid valves CPE24

Technical data

Dimensions – 5/2-way single solenoid valve

Download CAD data → www.festo.com

CPE24-...-3/8

CPE24-...-QS-10

CPE24-...-QS-12

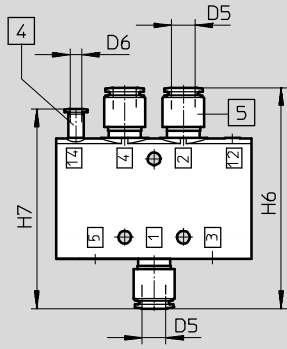
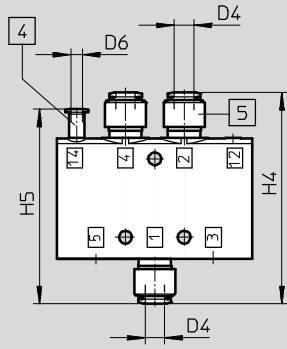
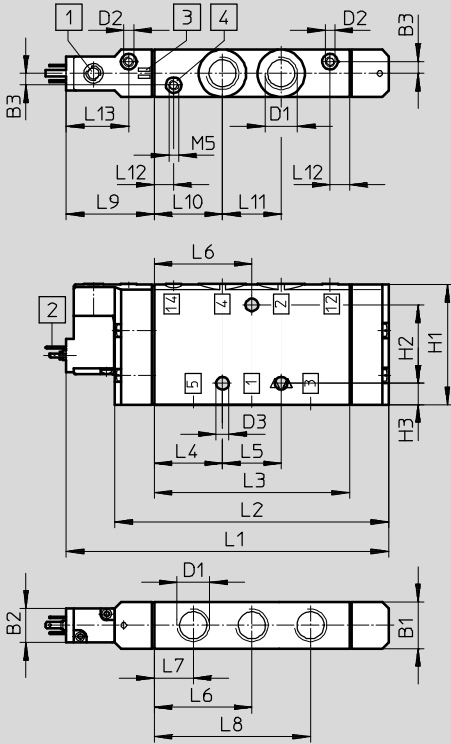

- 1 Manual override
- 2 Plug connector type C to EN 175301-803
- 3 Space for inscription labels
- 4 Port 12/14 for external pilot air
- 5 QS push-in fitting supply

Type	B1	B2	B3	D1	D2	D3 ∅	D4 ∅	D5 ∅	D6 ∅	H1	H2	H3	H4	H5	H6	H7
CPE24-M1H-5L...	24	17.5	6	G3/8	M5	6.5	10	12	6	62	40	11	108	99.5	113	102

Type	L1	L2	L3	L4	L5	L6	L7	L8	L9	L10	L11	L12	L13
CPE24-M1H-5L...	165	140	100	35	30	50	20	80	45	35	30	10	32

Solenoid valves CPE24

Technical data

FESTO

Dimensions – 5/2-way double solenoid valve

Download CAD data → www.festo.com

Threaded connection

Push-in connector

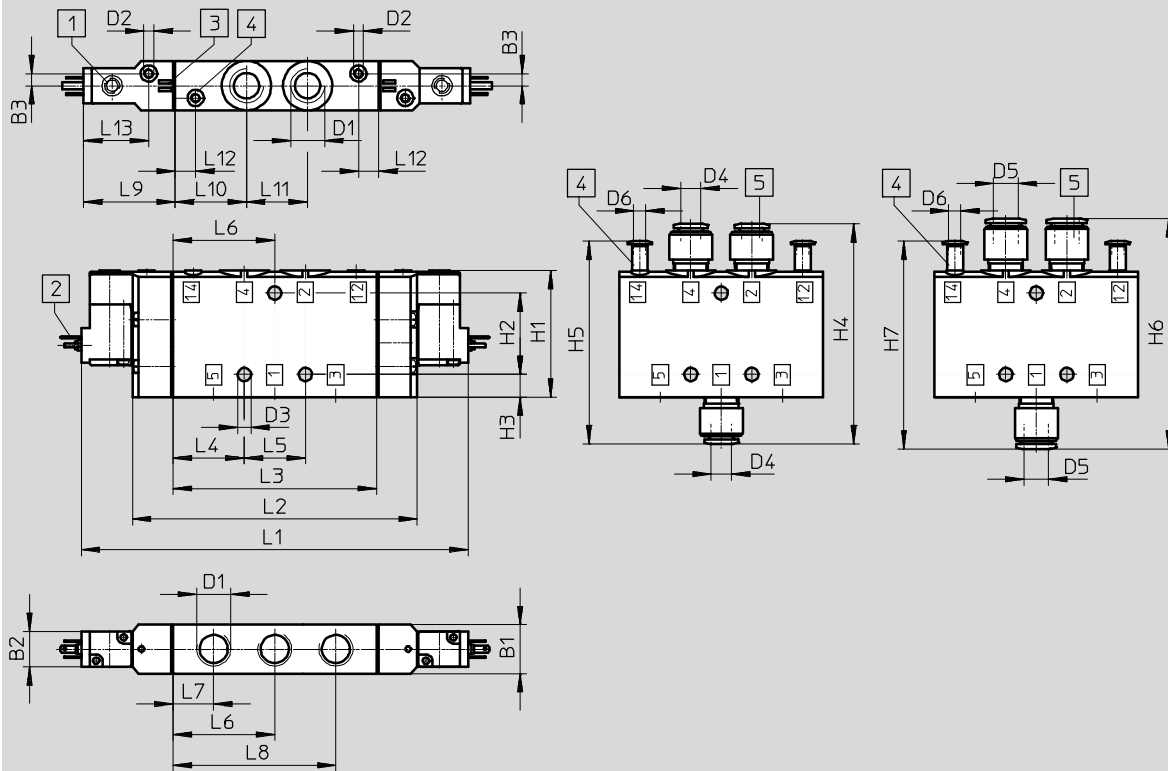

- 1 Manual override
- 2 Plug connector type C to EN 175301-803
- 3 Space for inscription labels
- 4 Port 12/14 for external pilot air supply
- 5 QS push-in fitting

Type	B1	B2	B3	D1	D2	D3 ∅	D4 ∅	D5 ∅	D6 ∅	H1	H2	H3	H4	H5	H6	H7
CPE24-...-5J-3/8	24	17.5	6	G3/8	M5	6.5	10	12	6	62	40	11	108	99.5	113	102

Type	L1	L2	L3	L4	L5	L6	L7	L8	L9	L10	L11	L12	L13
CPE24-...-5J-3/8	190	140	100	35	30	50	20	80	45	35	30	10	32

Solenoid valves CPE24

Technical data

Dimensions – 5/3-way valve

Download CAD data → www.festo.com

CPE24-...-3/8

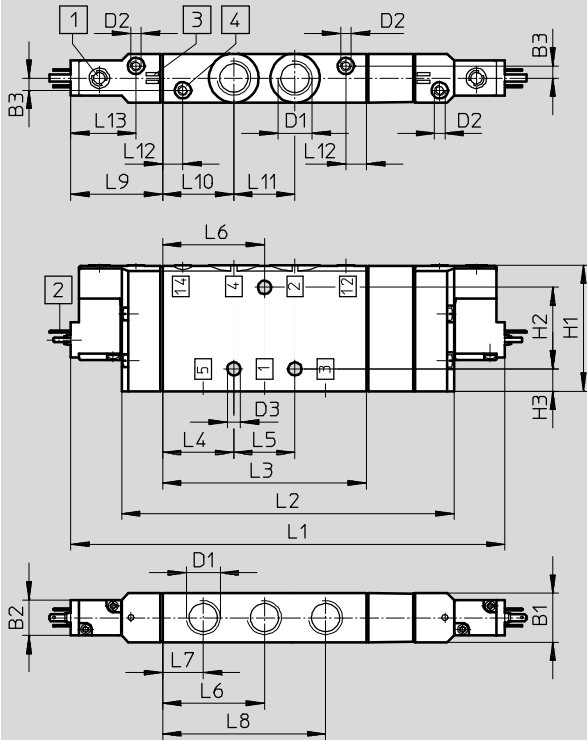

CPE24-...-QS-10

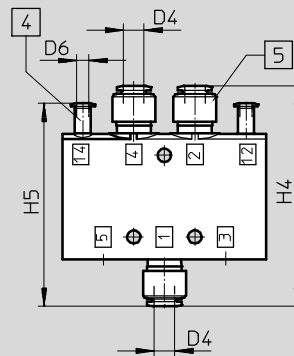

CPE24-...-QS-12

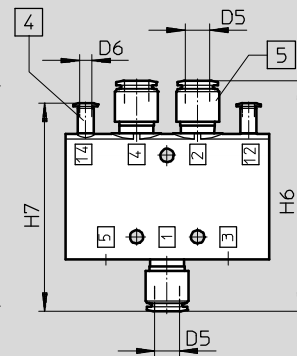

- 1 Manual override
- 2 Plug connector type C to EN 175301-803
- 3 Space for inscription labels
- 4 Port 12/14 for external pilot air supply
- 5 QS push-in fitting

Type	B1 ±0.1	B2 -0.5	B3	D1	D2	D3 ∅	D4 ∅	D5 ∅	D6 ∅	H1 ±0.25	H2	H3 ±0.1	H4	H5	H6	H7
CPE24-M1H...-5	24	17.5	6	G3/8	M5	6.5	10	12	6	62	40	11	108	99.5	113	102
CPE24-M1H...-5/3																

Type	L1	L2	L3 ±0.2	L4 ±0.2	L5	L6	L7 ±0.12	L8 ±0.2	L9	L10 ±0.12	L11	L12 ±0.12	L13
CPE24-M1H...-5]	190	140	100	35	30	50	20	80	45	35	30	10	32
CPE24-M1H...-5/3	213	163											

Solenoid valves CPE24

FESTO

Ordering data – 3/2-way valve

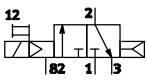
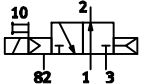
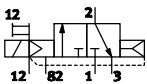
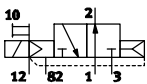
Ordering data						
Circuit symbol	Pilot air supply	Voltage	Pneumatic connection	Weight [g]	Part No.	Type
Normally closed						
	Internal	24 V DC	G3/8	220	163165	CPE24-M1H-3GL-3/8
			QS-10	-	163173	CPE24-M1H-3GL-QS-10
			QS-12	-	163181	CPE24-M1H-3GL-QS-12
		110 V AC	G3/8	220	163809	CPE24-M2H-3GL-3/8
			QS-10	-	163817	CPE24-M2H-3GL-QS-10
			QS-12	-	163825	CPE24-M2H-3GL-QS-12
		230 V AC	G3/8	220	163833	CPE24-M3H-3GL-3/8
			QS-10	-	163841	CPE24-M3H-3GL-QS-10
			QS-12	-	163849	CPE24-M3H-3GL-QS-12
Normally open						
	Internal	24 V DC	G3/8	220	163164	CPE24-M1H-3OL-3/8
			QS-10	-	163172	CPE24-M1H-3OL-QS-10
			QS-12	-	163180	CPE24-M1H-3OL-QS-12
		110 V AC	G3/8	220	163808	CPE24-M2H-3OL-3/8
			QS-10	-	163816	CPE24-M2H-3OL-QS-10
			QS-12	-	163824	CPE24-M2H-3OL-QS-12
		230 V AC	G3/8	220	163832	CPE24-M3H-3OL-3/8
			QS-10	-	163840	CPE24-M3H-3OL-QS-10
			QS-12	-	163848	CPE24-M3H-3OL-QS-12
Normally closed						
	External	24 V DC	G3/8	220	163169	CPE24-M1H-3GLS-3/8
			QS-10	-	163177	CPE24-M1H-3GLS-QS-10
			QS-12	-	163185	CPE24-M1H-3GLS-QS-12
		110 V AC	G3/8	220	163813	CPE24-M2H-3GLS-3/8
			QS-10	-	163821	CPE24-M2H-3GLS-QS-10
			QS-12	-	163829	CPE24-M2H-3GLS-QS-12
		230 V AC	G3/8	220	163837	CPE24-M3H-3GLS-3/8
			QS-10	-	163845	CPE24-M3H-3GLS-QS-10
			QS-12	-	163853	CPE24-M3H-3GLS-QS-12
Normally open						
	External	24 V DC	G3/8	220	163168	CPE24-M1H-3OLS-3/8
			QS-10	-	163176	CPE24-M1H-3OLS-QS-10
			QS-12	-	163184	CPE24-M1H-3OLS-QS-12
		110 V AC	G3/8	220	163812	CPE24-M2H-3OLS-3/8
			QS-10	-	163820	CPE24-M2H-3OLS-QS-10
			QS-12	-	163828	CPE24-M2H-3OLS-QS-12
		230 V AC	G3/8	220	163836	CPE24-M3H-3OLS-3/8
			QS-10	-	163844	CPE24-M3H-3OLS-QS-10
			QS-12	-	163852	CPE24-M3H-3OLS-QS-12

Solenoid valves CPE24

Ordering data – 5/2-way valve

Ordering data								
Circuit symbol	Pilot air supply	Voltage	Pneumatic connection	Weight [g]	Part No.	Type		
5/2 way valve, single solenoid								
	Internal	24 V DC	G3/8	360	163166	CPE24-M1H-5L-3/8		
			QS-10	–	163174	CPE24-M1H-5L-QS-10		
			QS-12	–	163182	CPE24-M1H-5L-QS-12		
		110 V AC	Internal	24 V DC	G3/8	360	163810	CPE24-M2H-5L-3/8
					QS-10	–	163818	CPE24-M2H-5L-QS-10
					QS-12	–	163826	CPE24-M2H-5L-QS-12
		230 V AC	Internal	24 V DC	G3/8	360	163834	CPE24-M3H-5L-3/8
					QS-10	–	163842	CPE24-M3H-5L-QS-10
					QS-12	–	163850	CPE24-M3H-5L-QS-12
5/2-way valve, double solenoid								
	Internal	24 V DC	G3/8	390	163167	CPE24-M1H-5J-3/8		
			QS-10	–	163175	CPE24-M1H-5J-QS-10		
			QS-12	–	163183	CPE24-M1H-5J-QS-12		
		110 V AC	Internal	24 V DC	G3/8	390	163811	CPE24-M2H-5J-3/8
					QS-10	–	163819	CPE24-M2H-5J-QS-10
					QS-12	–	163827	CPE24-M2H-5J-QS-12
		230 V AC	Internal	24 V DC	G3/8	390	163835	CPE24-M3H-5J-3/8
					QS-10	–	163843	CPE24-M3H-5J-QS-10
					QS-12	–	163851	CPE24-M3H-5J-QS-12
5/2 way valve, single solenoid								
	External	24 V DC	G3/8	360	163170	CPE24-M1H-5LS-3/8		
			QS-10	–	163178	CPE24-M1H-5LS-QS-10		
			QS-12	–	163186	CPE24-M1H-5LS-QS-12		
		110 V AC	External	24 V DC	G3/8	360	163814	CPE24-M2H-5LS-3/8
					QS-10	–	163822	CPE24-M2H-5LS-QS-10
					QS-12	–	163830	CPE24-M2H-5LS-QS-12
		230 V AC	External	24 V DC	G3/8	360	163838	CPE24-M3H-5LS-3/8
					QS-10	–	163846	CPE24-M3H-5LS-QS-10
					QS-12	–	163854	CPE24-M3H-5LS-QS-12
5/2-way valve, double solenoid								
	External	24 V DC	G3/8	390	163171	CPE24-M1H-5JS-3/8		
			QS-10	–	163179	CPE24-M1H-5JS-QS-10		
			QS-12	–	163187	CPE24-M1H-5JS-QS-12		
		110 V AC	External	24 V DC	G3/8	390	163815	CPE24-M2H-5JS-3/8
					QS-10	–	163823	CPE24-M2H-5JS-QS-10
					QS-12	–	163831	CPE24-M2H-5JS-QS-12
		230 V AC	External	24 V DC	G3/8	390	163839	CPE24-M3H-5JS-3/8
					QS-10	–	163847	CPE24-M3H-5JS-QS-10
					QS-12	–	163855	CPE24-M3H-5JS-QS-12

Solenoid valves CPE24

Ordering data – 5/3-way valve

Ordering data						
Circuit symbol	Pilot air supply	Voltage	Pneumatic connection	Weight [g]	Part No.	Type
5/3-way mid-position valve, normally closed						
	Internal	24 V DC	G3/8	430	170265	CPE24-M1H-5/3G-3/8
			QS-10	–	170271	CPE24-M1H-5/3G-QS-10
			QS-12	–	170277	CPE24-M1H-5/3G-QS-12
		110 V AC	G3/8	430	170301	CPE24-M2H-5/3G-3/8
			QS-10	–	170307	CPE24-M2H-5/3G-QS-10
			QS-12	–	170313	CPE24-M2H-5/3G-QS-12
		230 V AC	G3/8	430	170337	CPE24-M3H-5/3G-3/8
			QS-10	–	170343	CPE24-M3H-5/3G-QS-10
			QS-12	–	170349	CPE24-M3H-5/3G-QS-12
5/3-way mid-position valve, normally exhausted						
	Internal	24 V DC	G3/8	430	170267	CPE24-M1H-5/3E-3/8
			QS-10	–	170273	CPE24-M1H-5/3E-QS-10
			QS-12	–	170279	CPE24-M1H-5/3E-QS-12
		110 V AC	G3/8	430	170303	CPE24-M2H-5/3E-3/8
			QS-10	–	170309	CPE24-M2H-5/3E-QS-10
			QS-12	–	170315	CPE24-M2H-5/3E-QS-12
		230 V AC	G3/8	430	170339	CPE24-M3H-5/3E-3/8
			QS-10	–	170345	CPE24-M3H-5/3E-QS-10
			QS-12	–	170351	CPE24-M3H-5/3E-QS-12
5/3-way mid-position valve, normally open						
	Internal	24 V DC	G3/8	430	170269	CPE24-M1H-5/3B-3/8
			QS-10	–	170275	CPE24-M1H-5/3B-QS-10
			QS-12	–	170281	CPE24-M1H-5/3B-QS-12
		110 V AC	G3/8	430	170305	CPE24-M2H-5/3B-3/8
			QS-10	–	170311	CPE24-M2H-5/3B-QS-10
			QS-12	–	170317	CPE24-M2H-5/3B-QS-12
		230 V AC	G3/8	430	170341	CPE24-M3H-5/3B-3/8
			QS-10	–	170347	CPE24-M3H-5/3B-QS-10
			QS-12	–	170353	CPE24-M3H-5/3B-QS-12

Solenoid valves CPE24



Ordering data – 5/3-way valves

Ordering data – 5/3-way valve						
Circuit symbol	Pilot air supply	Voltage	Pneumatic connection	Weight [g]	Part No.	Type
5/3-way mid-position valve, normally closed						
	External	24 V DC	G3/8	430	170266	CPE24-M1H-5/3GS-3/8
			QS-10	–	170272	CPE24-M1H-5/3GS-QS-10
			QS-12	–	170278	CPE24-M1H-5/3GS-QS-12
		110 V AC	G3/8	430	170302	CPE24-M2H-5/3GS-3/8
			QS-10	–	170308	CPE24-M2H-5/3GS-QS-10
			QS-12	–	170314	CPE24-M2H-5/3GS-QS-12
		230 V AC	G3/8	430	170338	CPE24-M3H-5/3GS-3/8
			QS-10	–	170344	CPE24-M3H-5/3GS-QS-10
			QS-12	–	170350	CPE24-M3H-5/3GS-QS-12
5/3-way mid-position valve, normally exhausted						
	External	24 V DC	G3/8	430	170268	CPE24-M1H-5/3ES-3/8
			QS-10	–	170274	CPE24-M1H-5/3ES-QS-10
			QS-12	–	170280	CPE24-M1H-5/3ES-QS-12
		110 V AC	G3/8	430	170304	CPE24-M2H-5/3ES-3/8
			QS-10	–	170310	CPE24-M2H-5/3ES-QS-10
			QS-12	–	170316	CPE24-M2H-5/3ES-QS-12
		230 V AC	G3/8	430	170340	CPE24-M3H-5/3ES-3/8
			QS-10	–	170346	CPE24-M3H-5/3ES-QS-10
			QS-12	–	170352	CPE24-M3H-5/3ES-QS-12
5/3-way mid-position valve, normally open						
	External	24 V DC	G3/8	430	170270	CPE24-M1H-5/3BS-3/8
			QS-10	–	170276	CPE24-M1H-5/3BS-QS-10
			QS-12	–	170282	CPE24-M1H-5/3BS-QS-12
		110 V AC	G3/8	430	170306	CPE24-M2H-5/3BS-3/8
			QS-10	–	170312	CPE24-M2H-5/3BS-QS-10
			QS-12	–	170318	CPE24-M2H-5/3BS-QS-12
		230 V AC	G3/8	430	170342	CPE24-M3H-5/3BS-3/8
			QS-10	–	170348	CPE24-M3H-5/3BS-QS-10
			QS-12	–	170354	CPE24-M3H-5/3BS-QS-12

Solenoid valves CPE, Compact Performance

Accessories

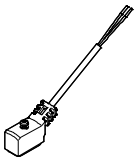
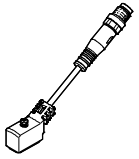
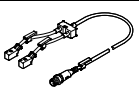

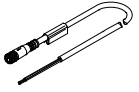
FESTO



Ordering data – Accessories for CPE10 and CPE14					Part No.	Type
Connecting cable, socket, connection pattern ZC					Technical data → Internet: nebv	
	Open cable end 2-wire	PUR cable, degree of protection IP65	Holding current reduction, protective circuit, signal status display with LED	Length: 2.5 m	8047679	NEBV-Z4WA2L-R-E-2.5-N-LE2-S1
				Length: 5 m	8047680	NEBV-Z4WA2L-R-E-5-N-LE2-S1
				Length: 10 m	8047678	NEBV-Z4WA2L-R-E-10-N-LE2-S1
	PVC cable, degree of protection IP50	Without signal status display	Length: 0.5 m	193690	KMYZ-4-24-0,5-B	
			Length: 2.5 m	193691	KMYZ-4-24-2,5-B	
	Plug M8x1, 3-pin	PUR cable, degree of protection IP65	Holding current reduction, protective circuit, signal status display with LED	Length: 0.5 m	8047683	NEBV-Z4WA2L-R-E-0.5-N-M8G3-S1
				Length: 2.5 m	8047684	NEBV-Z4WA2L-R-E-2.5-N-M8G3-S1
2 to 1 distributor					Technical data → Internet: neby	
	2x plug socket, connection pattern ZC	Holding current reduction, protective circuit, signal status display with LED	1x plug connector, straight, M8x1	Length: 2.8 m	8035789	NEDY-L2R1-V1-Z4W2Z-U-Q3L-M8G4-2.5R
				Length: 5.3 m	8035790	NEDY-L2R1-V1-Z4W2Z-U-Q3L-M8G4-5R
			1x plug connector, straight, M12x1	Length: 2.8 m	8035787	NEDY-L2R1-V1-Z4W2Z-U-Q3L-M12G4-2.5R
				Length: 5.3 m	8035788	NEDY-L2R1-V1-Z4W2Z-U-Q3L-M12G4-5R
	Modular system for any 2 to 1 distributor			Length 0.3 ... 30 m	8032867	NEDY-... → Internet: neby
Adapter						
	Plug socket, connection pattern ZC	Signal status display with LED	Plug M8, 3 pin	571686	VAVE-C8-1R8	
			Plug M8, 4-pin	573194	VAVE-C8-1R1	
Connecting cable, socket M8x1					Technical data → Internet: nebu	
	Socket M8x1, 3-pin	Straight	Open cable end 3-wire	Length: 2.5 m	541333	NEBU-M8G3-K-2.5-LE3
				Length: 5 m	541334	NEBU-M8G3-K-5-LE3
		Plug M8x1, 3-pin	Open cable end 3-wire	Length: 2.5 m	541348	NEBU-M8G3-K-2.5-M8G3
				Length: 5 m	541349	NEBU-M8G3-K-5-M8G3
				Length: 10 m	569844	NEBU-M8G3-K-10-M8G3
	Angled	Open cable end 3-wire	Length: 2.5 m	541338	NEBU-M8W3-K-2.5-LE3	
			Length: 5 m	541341	NEBU-M8W3-K-5-LE3	
	Socket M8x1, 4-pin	Straight	Open cable end 4-wire	Length: 2.5 m	541342	NEBU-M8G4-K-2.5-LE4
				Length: 5 m	541343	NEBU-M8G4-K-5-LE4
		Angled	Open cable end 4-wire	Length: 5 m	541345	NEBU-M8W4-K-5-LE4
Length: 2.5 m				541344	NEBU-M8W4-K-2.5-LE4	
Length: 2.5 m				539052	NEBU-... → Internet: nebu	
Modular system for all types of connecting cable			Length 0.1 ... 30 m	539052	NEBU-... → Internet: nebu	

Solenoid valves CPE, Compact Performance

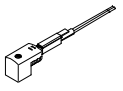
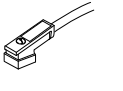
Accessories

FESTO

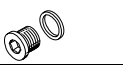
Ordering data – Accessories for CPE18 and CPE24						Part No.	Type
Plug socket with cable, socket type C to EN 175301-803						Technical data → Internet: kmeb	
	Cable sheath PVC	Signal status display with LED	24 V DC	Length: 2.5 m	151688	KMEB-1-24-2,5-LED	
			24 V DC	Length: 5 m	151689	KMEB-1-24-5-LED	
			24 V DC	Length: 10 m	193457	KMEB-1-24-10-LED	
	Cable sheath PUR	Signal status display with LED	Up to 240 V	Length: 2.5 m	151690	KMEB-1-230-2,5	
			Up to 240 V	Length: 5 m	151691	KMEB-1-230-5	
			Up to 240 V	Length: 5 m	174844	KMEB-2-24-2,5-LED	
	Cable sheath PUR	Signal status display with LED	24 V DC	Length: 2.5 m	174845	KMEB-2-24-5-LED	
			24 V DC	Length: 5 m	174846	KMEB-2-230-2,5	
			Up to 240 V	Length: 5 m	174847	KMEB-2-230-5	
Plug socket						Technical data → Internet: mssd	
	Socket 3-pin, type C to EN 175301-803	Screw terminal	Up to 240 V		151687	MSSD-EB	
			Up to 240 V		539712	MSSD-EB-M12	
		Insulation displacement connector	Up to 240 V		192745	MSSD-EB-S-M14	
Illuminating seal						Technical data → Internet: meb-ld	
	Type C to EN 175301-803		12 ... 24 V DC		151717	MEB-LD-12-24DC	
			230 V AC		151718	MEB-LD-230AC	

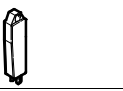
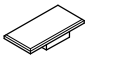
Ordering data – General accessories						Part No.	Type	PU ¹⁾
Blanking plug						Technical data → Internet: b		
	For manifold block CPE10		G1/4 thread		3569	B-1/4	10	
	For manifold block CPE14, CPE18		G3/8 thread		3570	B-3/8	10	
Separator for pressure zones						Technical data → Internet: vabd		
	For manifold block CPE14, CPE18				160997	PRSV-1/8	1	
Silencer						Technical data → Internet: uc		
	Thread		M3		1231120	AMTE-M-LH-M3	20	
			M5		165003	UC-M5	1	
			M7		161418	UC-M7	1	
			G1/8		161419	UC-1/8	1	
			G1/4		165004	UC-1/4	1	
Manual override						Technical data → Internet: ahh		
	For CPE10 and CPE14 with plug connection pattern ZC				157600	AHB-MZB	1	
	For CPE18 and CPE24 with plug type C				157601	AHB-MEB	1	
Inscription labels						Technical data → Internet: ibs		
	Inscription label, 6x10mm				18576	IBS-6x10	64	

1) Packaging unit.

Festo - Your Partner in Automation



1 Festo Inc.
5300 Explorer Drive
Mississauga, ON L4W 5G4
Canada

Festo Customer Interaction Center
Tel: 1 877 463 3786
Fax: 1 877 393 3786
Email: customer.service.ca@festo.com



2 Festo Pneumatic
Av. Ceylán 3,
Col. Tequesquináhuac
54020 Tlalneptla,
Estado de México

Multinational Contact Center
01 800 337 8669
ventas.mexico@festo.com



3 Festo Corporation
1377 Motor Parkway
Suite 310
Islandia, NY 11749

Festo Customer Interaction Center
1 800 993 3786
1 800 963 3786
customer.service.us@festo.com



4 Regional Service Center
7777 Columbia Road
Mason, OH 45040

Connect with us



www.festo.com/socialmedia



www.festo.com

Subject to change