

## Compact cylinders ADVULQ/AEVULQ/AEVULQZ – Inch Series

FESTO



- Piston Ø 1/2" to 4"
- Stroke lengths up to 16"
- Non-rotating square rod
- Double-acting or single-acting versions
- Compact design – less space required
- Numerous options
- Repairable

Product range overview											
Function	Version	Piston Ø [in]	Stroke [in]	Force [lbf]	Variants						
					A	P	A	S2	S6	S20	S26
Non-rotating with square piston rod											
Double-acting	ADVULQ	1/2, 5/8, 3/4, 1, 1-1/4, 1-5/8, 2, 2-1/2, 3, 4	See table below	15.3 ... 1,060	■	■	■	■	■	■	■
Single-acting	AEVULQ, pushing	5/8, 3/4, 1, 1-1/4, 1-5/8, 2, 2-1/2, 3, 4		25 ... 1,016	■	■	■	■	■	-	-
	AEVULQZ, pulling	5/8, 3/4, 1, 1-1/4, 1-5/8, 2, 2-1/2, 3, 4		25 ... 1,016	■	■	■	-	■	-	-

Variants							
A	Male thread	A	Magnet for position sensing	S6	Heat-resistant seals up to 302 °F	S26	Through piston rod, with heat-resistant seals up to 302 °F
P	Flexible cushioning rings at both ends	S2	Through piston rod	S20	Through, hollow piston rod		

Type	Piston Ø [in]	Standard strokes [in]	Variable strokes [in]
ADVULQ Piston rod at one end	1/2, 5/8	1/4, 1/2, 3/4, 1, 1-1/4, 1-1/2	0.04 ... 8
	3/4, 1	1/4, 1/2, 3/4, 1, 1-1/4, 1-1/2, 2	0.04 ... 8
	1-1/4, 1-5/8	1/4, 1/2, 3/4, 1, 1-1/4, 1-1/2, 2, 2-1/2, 3	0.04 ... 12
	2, 2-1/2	1/2, 3/4, 1, 1-1/4, 1-1/2, 2, 2-1/2, 3	0.04 ... 12
	3, 4	1/2, 3/4, 1, 1-1/4, 1-1/2, 2, 2-1/2, 3	0.04 ... 16
AEVULQ Piston rod at one end, pushing	5/8, 3/4, 1, 1-1/4, 1-5/8	1/4, 1/2, 3/4, 1	0.04 ... 1
	2, 2-1/2, 3, 4	1/2, 3/4, 1	0.04 ... 1
AEVULQZ Piston rod at one end, pulling	5/8, 3/4, 1, 1-1/4, 1-5/8	1/4, 1/2, 3/4, 1	0.04 ... 1
	2, 2-1/2, 3, 4	1/2, 3/4, 1	0.04 ... 1

- 1 - Type discontinued  
Available up until 2011

FESTO

## Compact cylinders ADVULQ – Inch Series

Technical data – Double-acting, non-rotating with square piston rod

Double-acting



Diameter

1/2 ... 4 inch

Stroke length

0.04 ... 16 inch

- Through piston rod (S2)
- Through, hollow piston rod (S20)
- Heat resistant seals (S6)
- Through piston rod, heat resistant seals (S26)



General technical data											
Piston Ø		1/2	5/8	3/4	1	1-1/4	1-5/8	2	2-1/2	3	4
Pneumatic connection		10-32 UNF					1/8" NPT				1/4" NPT
End of piston rod	Female thread	4-48 UNF 2B	8-36 UNF-2B	10-32 UNF-2B		1/4-28 UNF-2B		5/16-24 UNF-2B		3/8-24 UNF-2B	1/2-20 UNF-2B
	Male thread	10-32 UNF-2A	5/16-24 UNF-2A	3/8-24 UNF-2A			1/2-20 UNF-2A		5/8-18 UNF-2A	3/4-16 UNF-2A	
Operating medium		Filtered compressed air, lubricated or unlubricated									
Constructional design		Piston									
		Piston rod									
Cushioning		Flexible cushioning rings at both ends									
Magnet for position sensing <sup>1)</sup>		Standard									

1) Position sensing via magnetic proximity sensor (ordered separately, see accessories).

Operating pressure [psi]											
Piston Ø		1/2	5/8	3/4	1	1-1/4	1-5/8	2	2-1/2	3	4
Piston rod at one end		19.1 ... 147		14.7 ... 147		11.8 ... 147			8.8 ... 147		
Through piston rod S2/S20		22.1 ... 147	19.1 ... 147	17.6 ... 147		14.7 ... 147			11.8 ... 147		

Ambient conditions		
Variant	Basic version	S6
Ambient temperature <sup>1)</sup> [°F]	-4 ... +176	0 ... +302
Corrosion resistance class CRC <sup>2)</sup>	2	2

1) Note operating range of proximity sensors.

2) Corrosion resistance class 2 according to Festo standard 940 070

Components with moderate corrosion resistance for use in normal industrial environments subjected to contact with coolants or lubricating agents.

## Compact cylinders ADVULQ – Inch Series

Technical data – Double-acting, non-rotating with square piston rod

Forces [lbf] and impact energy [ft-lbf]										
Piston $\varnothing$	1/2	5/8	3/4	1	1-1/4	1-5/8	2	2-1/2	3	4
Theoretical force at 90psi, extending	15.3	27.2	42.3	66.4	108.7	169.7	265	420.8	678.6	1060.2
S2/S20	15.3	27.2	42.3	66.4	108.7	169.7	265	420.8	678.6	1060.2
Theoretical force at 90 psi, retracting	15.3	27.2	42.3	66.4	108.7	169.7	265	420.8	678.6	1060.2
S2/S20	15.3	27.2	42.3	66.4	108.7	169.7	265	420.8	678.6	1060.2
Max. impact energy at end positions	0.07	0.07	0.10	0.07	0.30	0.38	0.47	0.52	0.55	0.74
S20	0.01	0.01	0.01	0.01	0.03	0.04	0.04	0.05	0.06	0.07

Technical data – Square piston rod										
Piston $\varnothing$	1/2	5/8	3/4	1	1-1/4	1-5/8	2	2-1/2	3	4
Max. torque at the piston rod <sup>1)</sup> [ft-lbf]	0.07	0.15	0.33	0.33	0.59	0.59	0.81	0.81	1.11	2.2
Max. torsional backlash of piston rod [°]	±1.0	±0.9	±0.8	±0.8	±0.6	±0.6	±0.5	±0.5	±0.4	±0.4
Piston rod distortion [°/2 inch]	0.40	0.30	0.25	0.25	0.20	0.20	0.15	0.15	0.15	0.09

1) The max. torque must not be exceeded even when fitting attachments.

### Max. lateral force $F_q$ as a function of the projection $x$

Piston rod at one end

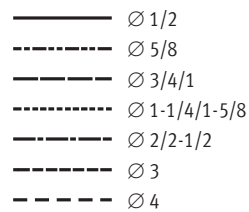
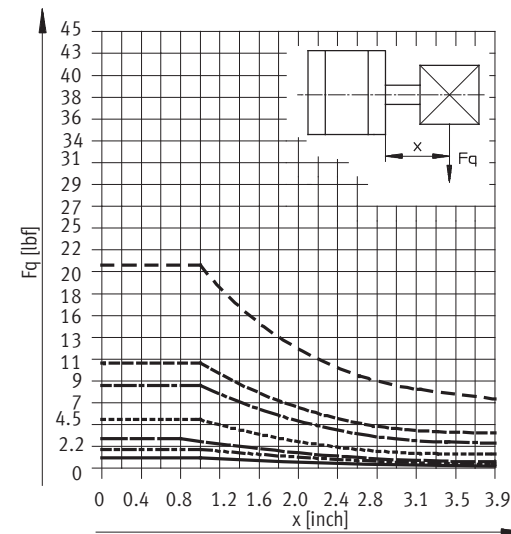

Through piston rod

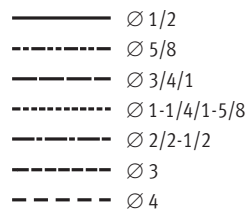
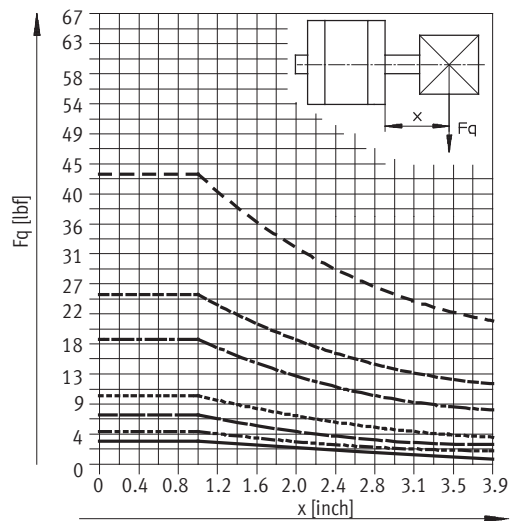

**Type discontinued**  
**Available up until 2011**

## Compact cylinders ADVULQ – Inch Series

Technical data – Double-acting, non-rotating with square piston rod

**FESTO**

### Max. lateral force $F_q$ as a function of the projection $x$

Q – square piston rod

$\varnothing 1/2''$

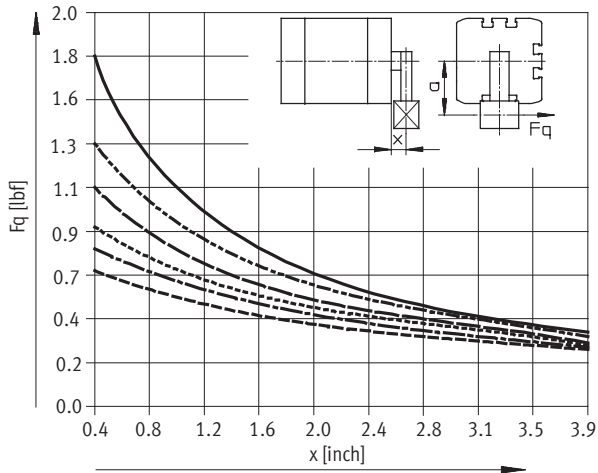

- a = 0.2 inch
- - - a = 0.4 inch
- · - a = 0.6 inch
- · · - a = 0.8 inch
- · · · a = 1.0 inch
- · · · · a = 1.2 inch

$\varnothing 5/8''$

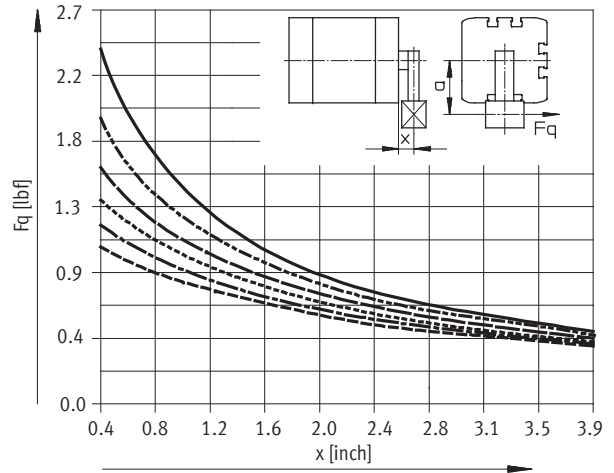

- a = 0.2 inch
- - - a = 0.4 inch
- · - a = 0.6 inch
- · · - a = 0.8 inch
- · · · a = 1.0 inch
- · · · · a = 1.2 inch

$\varnothing 3'' / 4'' / 1''$

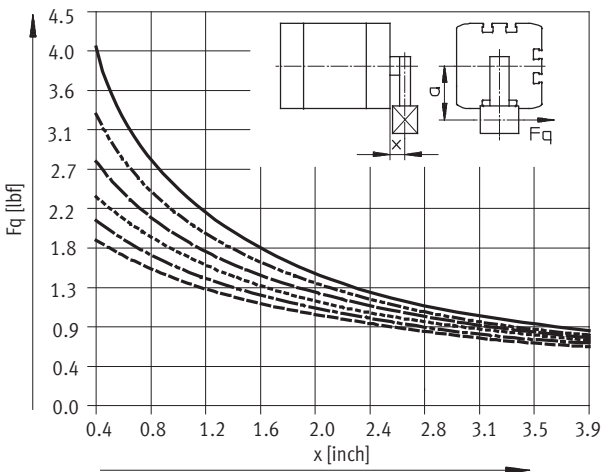

- a = 0.2 inch
- - - a = 0.4 inch
- · - a = 0.6 inch
- · · - a = 0.8 inch
- · · · a = 1.0 inch
- · · · · a = 1.2 inch

$\varnothing 1-1/4'' / 1-5/8''$

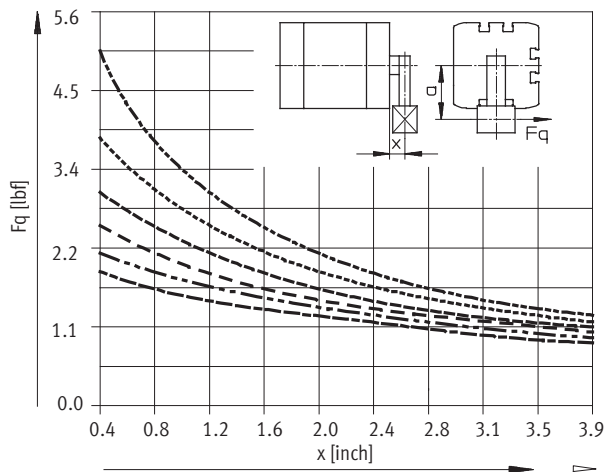

- a = 0.4 inch
- - - a = 0.8 inch
- · - a = 1.2 inch
- · · - a = 1.6 inch
- · · · a = 2.0 inch
- · · · · a = 2.4 inch

## Compact cylinders ADVULQ – Inch Series

Technical data – Double-acting, non-rotating with square piston rod

### Max. lateral force $F_q$ as a function of the projection $x$

$\varnothing 2'' / 2-1/2''$

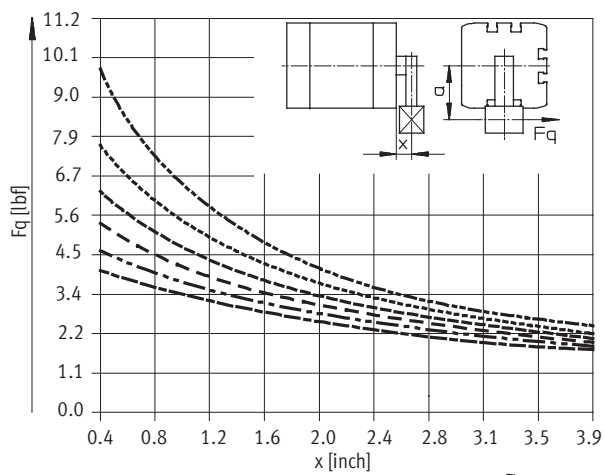

- a = 0.4 inch
- - - - - a = 0.8 inch
- a = 1.2 inch
- - - - - a = 1.6 inch
- a = 2.0 inch
- - - - - a = 2.4 inch

$\varnothing 3/4''$

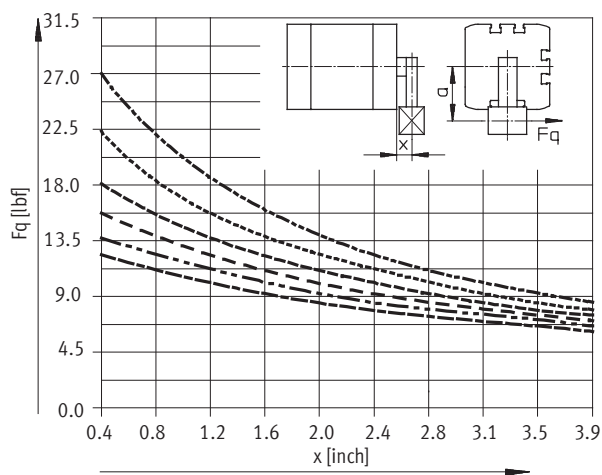

- a = 0.4 inch
- - - - - a = 0.8 inch
- a = 1.2 inch
- - - - - a = 1.6 inch
- a = 2.0 inch
- - - - - a = 2.4 inch

Mass [lb]										
Piston $\varnothing$	1/2	5/8	3/4	1	1-1/4	1-5/8	2	2-1/2	3	4
Product mass with 0 inch stroke	0.19	0.19	0.33	0.40	0.66	0.96	1.24	2.34	3.91	6.17
Additional mass per 1 inch stroke	0.08	0.08	0.13	0.16	0.23	0.33	0.41	0.60	0.94	0.99
Moving load with 0 inch stroke ( $m_{\text{piston}}$ )	0.02	0.03	0.04	0.06	0.11	0.14	0.25	0.29	0.68	1.36
Additional load per 1 inch stroke ( $m_{\text{piston}}$ )	0.01	0.03	0.03	0.03	0.05	0.05	0.09	0.09	0.14	0.21

- 1 - Type discontinued  
Available up until 2011

## Compact cylinders ADVULQ – Inch Series

FESTO

Technical data – Double-acting, non-rotating with square piston rod

### Materials

Sectional view

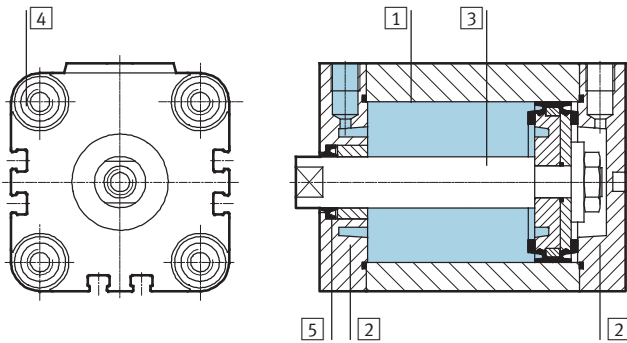

Variants	Basic version	S6
1 Cylinder barrel	Wrought aluminum alloy	Wrought aluminum alloy
2 End cap	Wrought aluminum alloy	Wrought aluminum alloy
3 Piston rod	∅ 1/2 ... 1-1/4	High-alloy stainless steel
	∅ 1-5/8 ... 4	High-alloy steel
4 Flange screws	∅ 1/2 ... 5/8	High-alloy stainless steel
	∅ 3/4 ... 4	Tempered steel
5 Dynamic seals	Polyurethane	Fluorocarbon rubber

### Dimensions – Basic cylinder

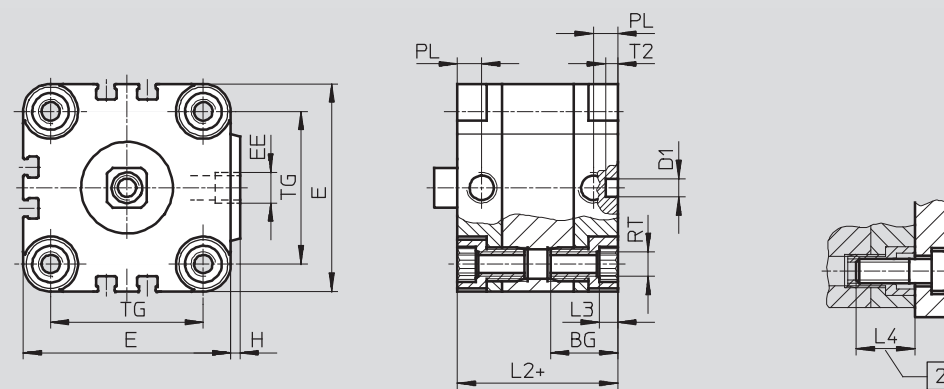

#### Note

To attach cylinder ∅ 1/2 and 5/8 in from above, use only 2 screws diagonally or non-magnetic screws.

+ = plus stroke length

2 Minimum screw-in depth

∅ [in]	BG	D1 ∅	E	EE	H	L2	L3	L4	PL	RT	T2	TG
1/2	0.73	0.2	1.1	10-32 UNF	0.04	1.5	0.1	0.6	0.3	M4	0.2	0.7
5/8	0.73	0.2	1.1	10-32 UNF	0.04	1.5	0.1	0.6	0.3	M4	0.2	0.7
3/4	0.73	0.2	1.4	10-32 UNF	0.06	1.5	0.2	0.7	0.3	M5	0.2	0.9
1	0.73	0.2	1.6	10-32 UNF	0.06	1.6	0.2	0.7	0.3	M5	0.2	1.0
1-1/4	0.85	0.2	2.0	1/8" NPT	0.08	1.8	0.2	0.8	0.3	M6	0.2	1.3
1-5/8	0.85	0.2	2.4	1/8" NPT	0.10	1.8	0.2	0.8	0.3	M6	0.2	1.7
2	0.87	0.2	2.7	1/8" NPT	0.12	1.8	0.2	0.8	0.3	M8	0.2	2.0
2-1/2	0.96	0.3	3.4	1/8" NPT	0.16	2.0	0.3	1.0	0.3	M10	0.2	2.4
3	1.08	0.3	4.2	1/8" NPT	0.16	2.2	0.3	1.0	0.3	M10	0.2	3.2
4	1.28	0.3	5.0	1/4" NPT	0.20	2.6	0.3	1.0	0.4	M10	0.2	4.1

Dimensions are in inches, unless otherwise noted.

## Compact cylinders ADVULQ – Inch Series

Technical data – Double-acting, non-rotating with square piston rod

### Dimensions – Variants

Basic version

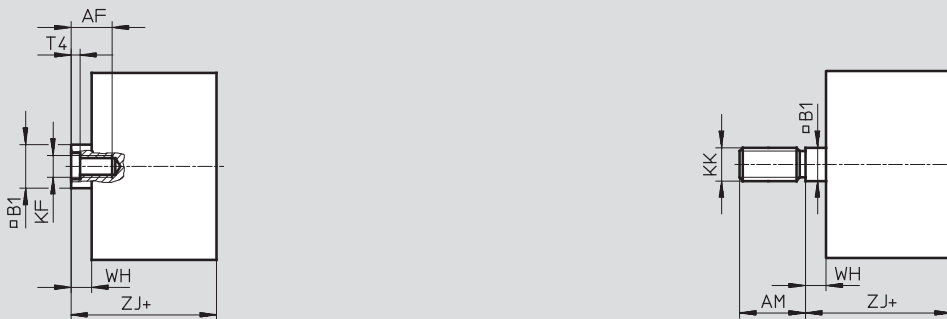

### S2 – Through piston rod



### S20 – Through, hollow piston rod

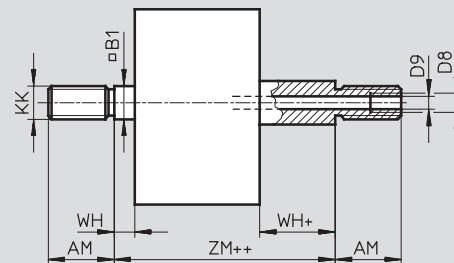

+ = plus stroke length  
++ = plus 2x stroke length

∅ [in]	AF	AM	B1 □	D8	D9 ∅	KF	KK	T4	WH	ZJ	ZM
1/2	0.3	0.6	0.2	-	0.09	4-48 UNF-2B	10-32 UNF-2A	0.06	0.2	1.67	1.9
5/8	0.4	0.8	0.3	-	0.13	8-36 UNF-2B	5/16-24 UNF-2A	0.06	0.2	1.67	1.9
3/4 <sup>2)</sup>	0.5	0.9	0.4	-	0.15	10-32 UNF-2B	3/8-24 UNF-2A	0.08	0.2	1.67	1.9
1 <sup>2)</sup>	0.5	0.9	0.4	-	0.15	10-32 UNF-2B	3/8-24 UNF-2A	0.08	0.2	1.77	2.0
1-1/4 <sup>2)</sup>	0.6	0.9	0.4	-	0.18	1/4-28 UNF-2B	3/8-24 UNF-2A	0.10	0.2	1.99	2.2
1-5/8 <sup>2)</sup>	0.6	0.9	0.4	-	0.18	1/4-28 UNF-2B	3/8-24 UNF-2A	0.10	0.3	2.05	2.3
2 <sup>2)</sup>	0.6	0.9	0.5	-	0.24	5/16-24 UNF-2B	1/2-20 UNF-2A	0.13	0.3	2.09	2.4
2-1/2 <sup>2)</sup>	0.6	0.9	0.5	-	0.24	5/16-24 UNF-2B	1/2-20 UNF-2A	0.13	0.3	2.26	2.6
3 <sup>2)</sup>	0.8	1.3	0.6	G1/8	0.31	3/8-24 UNF-2B	5/8-18 UNF-2A	0.19	0.3	2.52	2.8
4 <sup>2)</sup>	0.9	1.6	0.8	G1/4	0.46	1/2-20 UNF-2B	3/4-16 UNF-2A	0.24	0.4	3.01	3.4

1) With a stroke < 0.2 inch, the maximum screw-in depth is reduced by 0.2 inch.

2) Nut for piston rod thread included in scope of delivery.

Dimensions are in inches, unless otherwise noted.

2011/05 – Subject to change – ADVUL/AEVUL

 Type discontinued  
Available up until 2011

## Compact cylinders ADVULQ – Inch Series

FESTO

Ordering Data

M Mandatory data					O Options	
Function	Piston Ø	Stroke	Cushioning	Magnet for position sensing	Type of piston rod	Temperature Resistant
ADVULQ	1/2 5/8 3/4 1 1 1/4 1 5/8 2 2 1/2 3 4	0.04 ... 16	P	A	S2 S20	S6 S26
ADVULQ	1	6	P	A	S26	

Ordering table														
Size	1/2	5/8	3/4	1	1 1/4	1 5/8	2	2 1/2	3	4	Conditions	Code	Enter code	
M Function	Double-acting, non-rotating with square piston rod											ADVULQ	ADVULQ	
Piston Ø [in]	1/2	5/8	3/4	1	1 1/4	1 5/8	2	2 1/2	3	4		-...		
Stroke [in]	0.04 ... 8				0.04 ... 13				0.04 ... 16				-...	
Cushioning	Flexible cushioning rings at both ends											-P	-P	
Magnet for position sensing	For use with magnetic proximity sensor											-A	-A	
O Type of piston rod	Through piston rod											-S2		
	Through, hollow piston rod											[1]	-S20	
Temperature resistant	Heat-resistant seals up to max. 302 °F											-S6		
	Through piston rod, heat resistant up to max. 302 °F											[2]	-S26	

[1] Not in combination with S6

[2] S2 in combination with S6 equals S26

Transfer order code

ADVULQ - [ ] - [ ] - P - A - [ ]



- 1 - Type discontinued  
Available up until 2011

FESTO

## Compact cylinders AEVULQ/AEVULQZ – Inch Series

Technical data – Single-acting, non-rotating with square piston rod

Pushing - AEVULQ

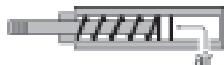

Pulling - AEVULQZ



Diameter

5/8 ... 4 inch

Stroke length

0.04 ... 1 inch

- Through piston rod (S2)
- Heat resistant seals (S6)



General technical data										
Piston Ø		5/8	3/4	1	1-1/4	1-5/8	2	2-1/2	3	4
Pneumatic connection		10-32 UNF				1/8" NPT				1/4" NPT
End of piston rod	Female thread	8-36 UNF-2B	10-32 UNF-2B	1/4-28 UNF-2B	5/16-24 UNF-2B	3/8-24 UNF-2B	1/2-20 UNF-2B			
	Male thread	5/16-24 UNF-2A	3/8-24 UNF-2A	1/2-20 UNF-2A	5/8-18 UNF-2A	3/4-16 UNF-2A				
Operating medium		Filtered compressed air, lubricated or unlubricated								
Constructional design		Piston								
		Piston rod								
Cushioning		Flexible cushioning rings at both ends								
Magnet for position sensing <sup>1)</sup>		Standard								

1) Position sensing via magnetic proximity sensor (ordered separately, see accessories).

Operating pressure [bar]										
Piston Ø		5/8	3/4	1	1-1/4	1-5/8	2	2-1/2	3	4
Pushing variant AEVULQ										
Piston rod at one end		19 ... 147	15 ... 147	12 ... 147			9 ... 147			
Through piston rod S2		22 ... 147	21 ... 147	18 ... 147			15 ... 147			
Pulling variant AEVULQZ										
Piston rod at one end		19 ... 147	15 ... 147	12 ... 147						

Ambient conditions			
Variant		Basic version	S6
Ambient temperature <sup>1)</sup>	[°F]	-4 ... +176	32 ... +302
Corrosion resistance class CRC <sup>2)</sup>		2	2

1) Note operating range of proximity sensors.

2) Corrosion resistance class 2 according to Festo standard 940 070

Components with moderate corrosion resistance for use in normal industrial environments subjected to contact with coolants or lubricating agents.

- 1 - Type discontinued  
Available up until 2011

## Compact cylinders AEVULQ/AEVULQZ – Inch Series

FESTO

Technical data – Single-acting, non-rotating with square piston rod

Forces [lbf]									
Piston $\varnothing$	5/8	3/4	1	1-1/4	1-5/8	2	2-1/2	3	4
Pushing variant AEVULQ									
Theoretical force at 90 psi, extending	25	40.3	60.8	102.6	163	252.2	404.8	653	1016.1
S2	25	40.3	60.8	102.6	163	252.2	404.8	653	1016.1
Pulling variant AEVULQZ									
Theoretical force at 90 psi, extending	1.35	3.15	3.2	9.5	24.5	0.68	1.35	8.55	41.6

Technical data – Square piston rod									
Piston $\varnothing$	5/8	3/4	1	1-1/4	1-5/8	3	2-1/2	3	4
Max. torque at the piston rod <sup>1)</sup>	[ft-lbf] 0.22	0.50	0.50	0.89	0.89	1.22	1.22	1.66	3.32
Max. torsional backlash of piston rod	[°] $\pm 0.9$	$\pm 0.8$	$\pm 0.8$	$\pm 0.6$	$\pm 0.6$	$\pm 0.5$	$\pm 0.5$	$\pm 0.4$	$\pm 0.4$
Piston rod distortion	[°/2 inch] 0.30	0.25	0.25	0.20	0.20	0.15	0.15	0.15	0.09

1) The max. torque must not be exceeded even when fitting attachments.

### Spring return force F as a function of the stroke l

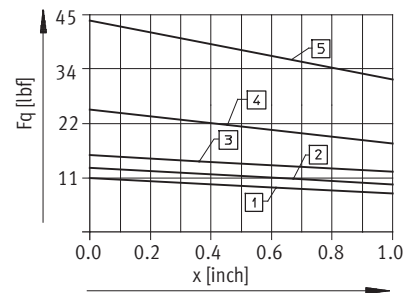
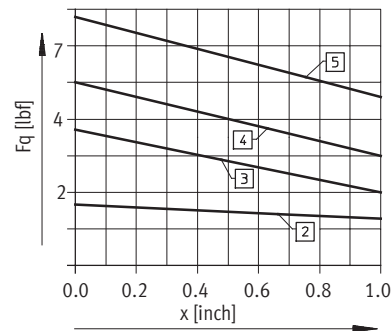

- 2 AEVULQ/AEVULQZ-5/8
- 3 AEVULQ/AEVULQZ-3/4
- 4 AEVULQ/AEVULQZ-1
- 5 AEVULQ/AEVULQZ-1-1/4

- 1 AEVULQ/AEVULQZ-1-5/8
- 2 AEVULQ/AEVULQZ-2
- 3 AEVULQ/AEVULQZ-2-1/2
- 4 AEVULQ/AEVULQZ-3
- 5 AEVULQ/AEVULQZ-4

Mass [lb]									
Piston $\varnothing$	5/8	3/4	1	1-1/4	1-5/8	2	2-1/2	3	4
Product mass with 0 inch stroke	0.19	0.33	0.40	0.66	0.96	1.24	2.34	3.91	6.17
Additional mass per 1 inch stroke	0.08	0.13	0.16	0.23	0.33	0.41	0.60	0.94	0.99
Moving load with 0 inch stroke ( $m_{\text{piston}}$ )	0.03	0.04	0.06	0.11	0.14	0.25	0.29	0.68	1.36
Additional load per 1 inch stroke ( $m_{\text{piston}}$ )	0.03	0.03	0.03	0.05	0.05	0.09	0.09	0.14	0.21

## Compact cylinders AEVULQ/AEVULQZ – Inch Series

Technical data – Single-acting, non-rotating with square piston rod

### Materials

Sectional view

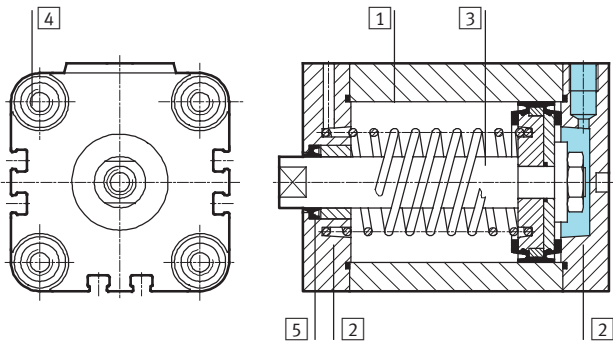

Variants	Basic version	S6
1 Cylinder barrel	Wrought aluminum alloy	Wrought aluminum alloy
2 End cap	Wrought aluminum alloy	Wrought aluminum alloy
3 Piston rod	$\varnothing 5/8 \dots 1-1/4$ High-alloy stainless steel	High-alloy stainless steel
	$\varnothing 1-5/8 \dots 4$ High-alloy steel	High-alloy steel
4 Flange screws	$\varnothing 5/8$ High-alloy stainless steel	High-alloy stainless steel
	$\varnothing 3/4 \dots 4$ Tempered steel	Tempered steel
5 Dynamic seals	Polyurethane	Fluorocarbon rubber

### Dimensions – Basic cylinder

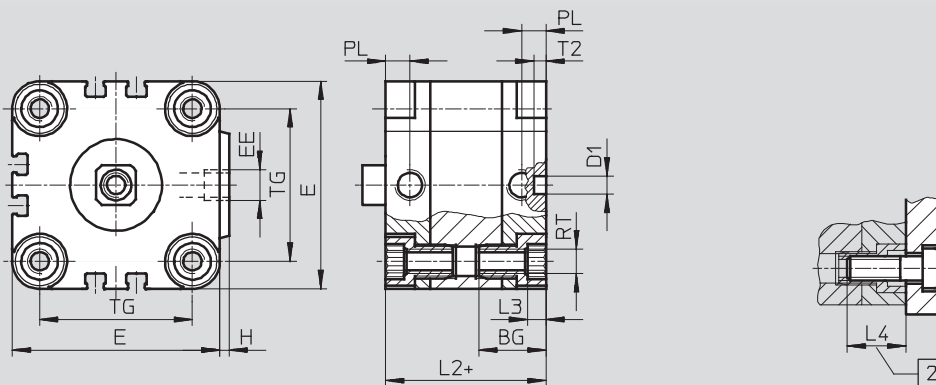

#### Note

To attach cylinder  $\varnothing 5/8$  inch from above, use only 2 screws diagonally or non-magnetic screws.

+ = plus stroke length

2 Minimum screw-in depth

$\varnothing$ [in]	BG	D1 $\varnothing$	E	EE	H	L2	L3	L4	PL	RT	T2	TG
5/8	0.7	0.2	1.1	10-32 UNF	0.04	1.5	0.1	0.6	0.3	M4	0.2	0.7
3/4	0.7	0.2	1.4	10-32 UNF	0.06	1.5	0.2	0.7	0.3	M5	0.2	0.9
1	0.7	0.2	1.6	10-32 UNF	0.06	1.6	0.2	0.7	0.3	M5	0.2	1.0
1-1/4	0.8	0.2	2.0	1/8" NPT	0.08	1.8	0.2	0.8	0.3	M6	0.2	1.3
1-5/8	0.8	0.2	2.4	1/8" NPT	0.10	1.8	0.2	0.8	0.3	M6	0.2	1.7
2	0.9	0.2	2.7	1/8" NPT	0.12	1.8	0.2	0.8	0.3	M8	0.2	2.0
2-1/2	1.0	0.3	3.4	1/8" NPT	0.16	2.0	0.3	1.0	0.3	M10	0.2	2.4
3	1.1	0.3	4.2	1/8" NPT	0.16	2.2	0.3	1.0	0.3	M10	0.2	3.2
4	1.3	0.3	5.0	1/4" NPT	0.20	2.6	0.3	1.0	0.4	M10	0.2	4.1

Dimensions are in inches, unless otherwise noted.

-  - Type discontinued  
Available up until 2011

## Compact cylinders AEVULQ/AEVULQZ – Inch Series

FESTO

Technical data – Single-acting, non-rotating with square piston rod

### Dimensions – Pushing variants, AEVULQ

Basic version

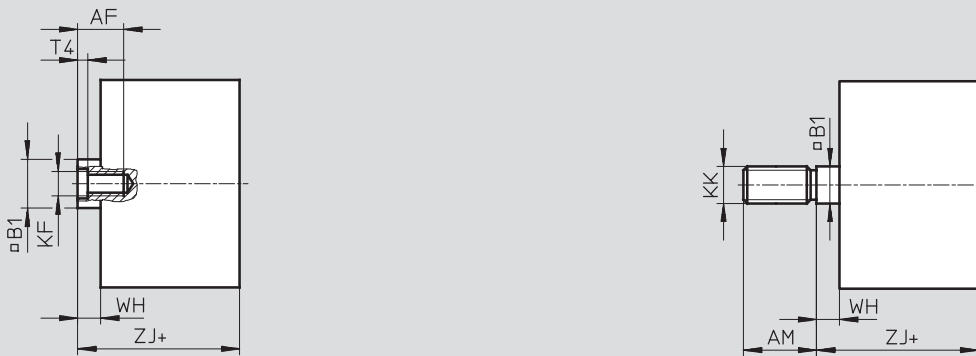

### S2 – Through piston rod

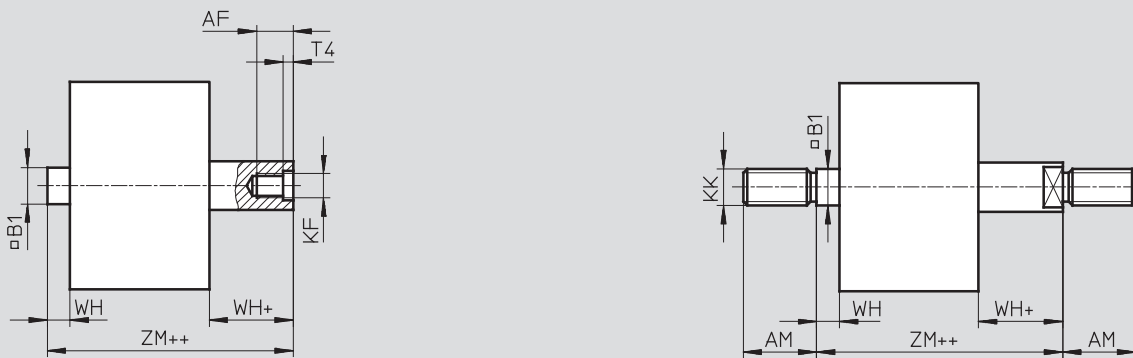

∅ [in]	AF	AM	B1 □	KF	KK	T4	WH	ZJ	ZM
5/8	0.4	0.8	0.3	8-36 UNF-2B	5/16-24 UNF-2A	0.06	0.2	1.7	1.9
3/4 <sup>2)</sup>	0.5	0.9	0.4	10-32 UNF-2B	3/8-24 UNF-2A	0.08	0.2	1.7	1.9
1 <sup>2)</sup>	0.5	0.9	0.4	10-32 UNF-2B	3/8-24 UNF-2A	0.08	0.2	1.8	2.0
1-1/4 <sup>2)</sup>	0.6	0.9	0.4	1/4-28 UNF-2B	3/8-24 UNF-2A	0.10	0.2	2.0	2.2
1-5/8 <sup>2)</sup>	0.6	0.9	0.4	1/4-28 UNF-2B	3/8-24 UNF-2A	0.10	0.2	2.0	2.3
2 <sup>2)</sup>	0.6	0.9	0.5	5/16-24 UNF-2B	1/2-20 UNF-2A	0.13	0.2	2.1	2.4
2-1/2 <sup>2)</sup>	0.6	0.9	0.5	5/16-24 UNF-2B	1/2-20 UNF-2A	0.13	0.3	2.3	2.6
3 <sup>2)</sup>	0.8 <sup>1)</sup>	1.3	0.6	3/8-24 UNF-2B	5/8-18 UNF-2A	0.19	0.3	2.5	2.8
4 <sup>2)</sup>	0.9 <sup>1)</sup>	1.6	0.8	1/2-20 UNF-2B	3/4-16 UNF-2A	0.24	0.4	3.0	3.4

- 1) With a stroke < 0.2 inch, the maximum screw-in depth is reduced by 0.2 inch.  
2) Nut for piston rod thread included in scope of delivery.

Dimensions are in inches, unless otherwise noted.

## Compact cylinders AEVULQ/AEVULQZ – Inch Series

FESTO

Technical data – Single-acting, non-rotating with square piston rod

### Dimensions – Pulling variants, AEVULQZ

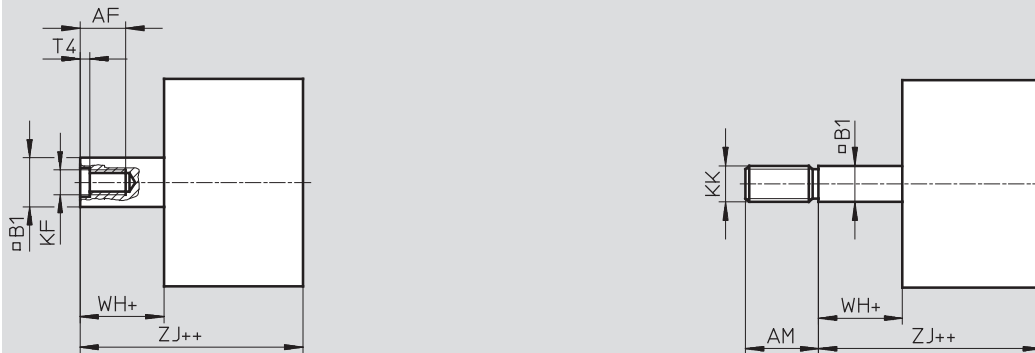

+ = plus stroke length  
++ = plus 2x stroke length

∅ [in]	AF	AM	B1 □	KF	KK	T4	WH	ZJ
5/8	0.4	0.8	0.3	8-36 UNF-2B	5/16-24 UNF-2A	0.06	0.2	1.7
3/4 <sup>1)</sup>	0.5	0.9	0.4	10-32 UNF-2B	3/8-24 UNF-2A	0.08	0.2	1.7
1 <sup>1)</sup>	0.5	0.9	0.4	10-32 UNF-2B	3/8-24 UNF-2A	0.08	0.2	1.8
1-1/4 <sup>1)</sup>	0.6	0.9	0.4	1/4-28 UNF-2B	3/8-24 UNF-2A	0.10	0.2	2.0
1-5/8 <sup>1)</sup>	0.6	0.9	0.4	1/4-28 UNF-2B	3/8-24 UNF-2A	0.10	0.3	2.0
2 <sup>1)</sup>	0.6	0.9	0.5	5/16-24 UNF-2B	1/2-20 UNF-2A	0.13	0.3	2.1
2-1/2 <sup>1)</sup>	0.6	0.9	0.5	5/16-24 UNF-2B	1/2-20 UNF-2A	0.13	0.3	2.3
3 <sup>1)</sup>	0.8	1.3	0.6	3/8-24 UNF-2B	5/8-18 UNF-2A	0.19	0.3	2.5
4 <sup>1)</sup>	0.9	1.6	0.8	1/2-20 UNF-2B	3/4-16 UNF-2A	0.24	0.4	3.0

1) Nut for piston rod thread included in scope of delivery.

Dimensions are in inches, unless otherwise noted.

# Compact cylinders AEVULQ/AEVULQZ – Inch Series



Odering Data

M Mandatory data					O Options	
Function	Piston Ø	Stroke	Cushioning	Magnet for position sensing	Type of piston rod	Temperature Resistant
AEVULQ AEVULQZ	5/8 3/4 1 1 1/4 1 5/8 2 2 1/2 3 4	0.04 ... 1	P	A	S2	S6
AEVULQ	- 1	- 1	- P	- A	- S6	

Ordering table													
Size	5/8	3/4	1	1 1/4	1 5/8	2	2 1/2	3	4	Conditions	Code	Enter code	
M Function	Single-acting, non-rotating with square piston rod, pushing										-	AEVULQ	
	Single-acting, non-rotating with square piston rod, pulling										-	AEVULQZ	
Piston Ø [in]	5/8	3/4	1	1 1/4	1 5/8	2	2 1/2	3	4	-	-		
Stroke [in]	0.04 ... 1										-	-	
Cushioning	Flexible cushioning rings at both ends										-	-P	-P
Magnet for position sensing	For use with magnetic proximity sensor										-	-A	-A
O Type of piston rod	Through piston rod										-	-S2	
Temperature resistant	Heat-resistant seals up to max. 302 °F										1	-S6	

1 Not in combination with S2

Transfer order code

	-		-		-	P	-	A	-	
--	---	--	---	--	---	---	---	---	---	--

- 2 - Type discontinued  
Available up until 2011

## Compact cylinders ADVULQ/AEVULQ/AEVULQZ – Inch Series

FESTO

Accessories overview

Piston  $\varnothing$  1/2 ... 4 inch

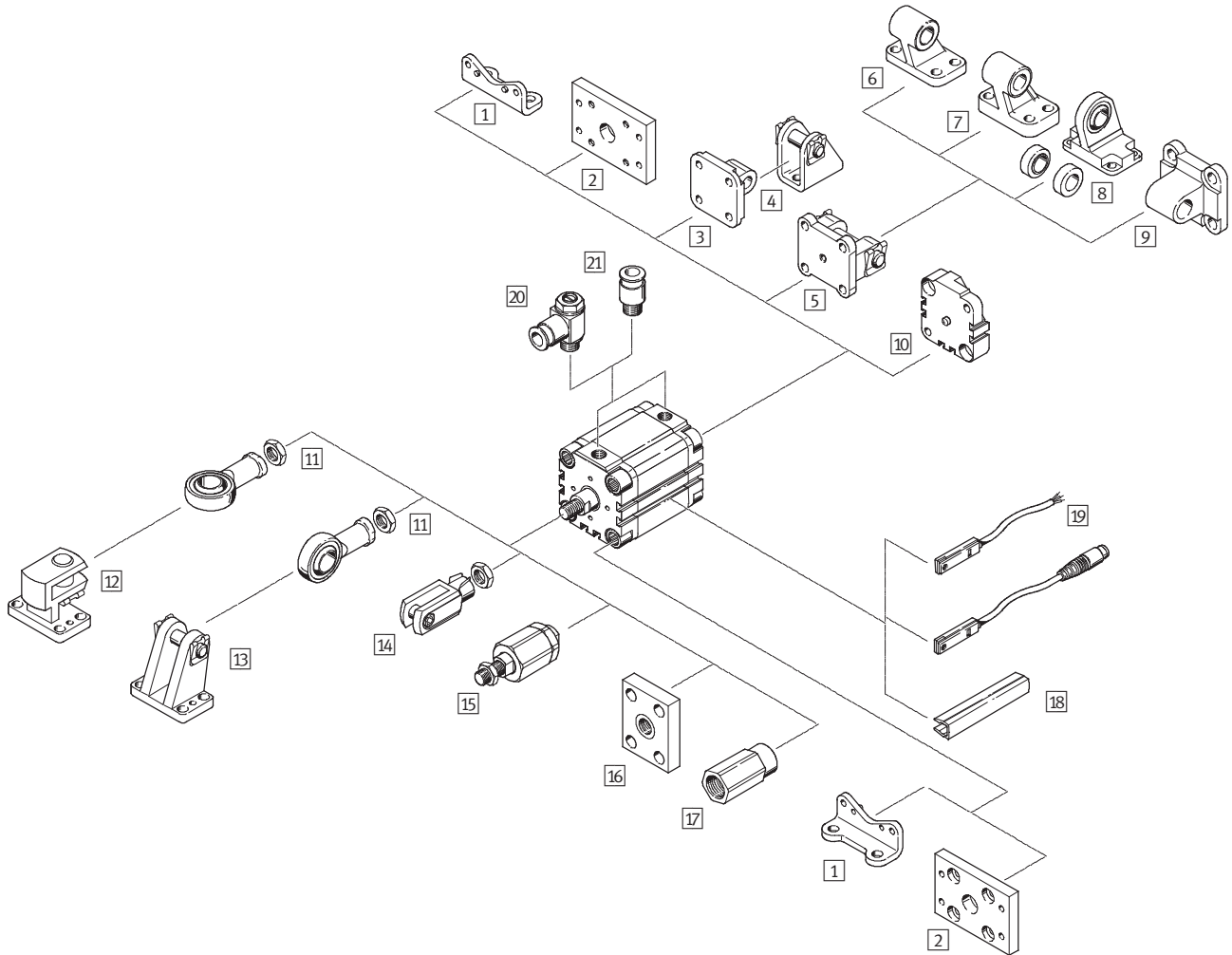

 Type discontinued  
Available up until 2011

## Compact cylinders ADVULQ/AEVULQ/AEVULQZ – Inch Series

FESTO

Accessories overview

Mounting attachments and accessories				
	Description	ADVULQ AEVULQ AEVULQZ		
		Basic	S2/S20	
1	Foot mounting HUA	For bearing and end cap	■	■
2	Flange mounting FUA	For bearing or end cap	■	■
3	Swivel flange SUA for $\varnothing 1/2 \dots 1$	For end cap	■	-
4	Clevis foot LBN	-	■	-
5	Swivel flange SUA for $\varnothing 1-1/4 \dots 4$	For end cap	■	-
6	Clevis foot LN	-	■	-
7	Clevis foot LNG	-	■	-
8	Clevis foot LSN	With spherical bearing	■	-
9	Swivel flange SNCL	-	■	-
10	Adapter kit DPVU	For connecting two cylinders with identical piston $\varnothing$ to form a multi-position cylinder	■	-
11	Rod eye SGS	With spherical bearing	-	-
12	Clevis foot, lateral LQG	-	-	-
13	Clevis foot LBG	-	-	-
14	Rod clevis SG	Permits a swivelling movement of the cylinder in one plane	■	■
15	Self-aligning rod coupler FK	For compensating radial and angular deviations	-	-
16	Coupling piece KSZ	For cylinders with non-rotating piston rod for compensating radial deviations	■	■
17	Adapter AD	For vacuum generator	-	■ S20
18	Slot cover ABP-5-S	For protecting the sensor cable and keeping dirt out of the sensor slots	■	■
19	Proximity sensor SME/SMT-8	Can be integrated in the cylinder profile barrel	■	■
20	One-way flow control valve GRLA/GRLZ	For speed regulation	■	■
21	Push-in fitting QS	For connecting compressed air tubing with standard O.D.	■	■



- 2 - Type discontinued  
Available up until 2011

## Compact cylinders ADVULQ/AEVULQ/AEVULQZ – Inch Series

FESTO

Accessories

Foot mounting HUA  
for piston  $\varnothing$  1/2 ... 4 inch

Material: Galvanized steel

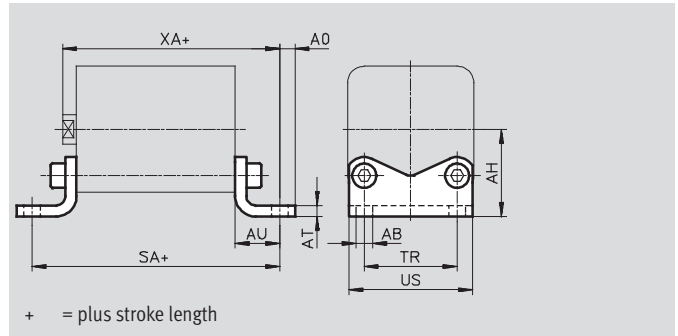

Dimensions and Ordering Data													
For $\varnothing$	AB $\varnothing$	AH	AO	AT	AU	SA	TR	US	XA	Weight [oz]	Basic version		
											CRC <sup>1)</sup>	Part No.	Type
1/2, 5/8	0.22	0.9	0.2	0.1	0.5	2.5	0.7	1.1	2.2	1.38	2	157309	HUA-12/16
3/4	0.26	1.1	0.2	0.2	0.6	2.8	0.9	1.3	2.3	2.75	2	157310	HUA-20
1	0.26	1.1	0.2	0.2	0.6	2.8	1.0	1.5	2.4	3.17	2	157311	HUA-25
1-1/4	0.26	1.3	0.3	0.2	0.7	3.2	1.3	1.9	2.7	5.47	2	157312	HUA-32
1-5/8	0.35	1.6	0.3	0.2	0.8	3.4	1.7	2.3	2.8	7.09	2	157313	HUA-40
2	0.35	1.9	0.3	0.2	0.9	3.7	2.0	2.6	3.0	11.08	2	157314	HUA-50
2-1/2	0.43	2.2	0.5	0.2	1.1	4.1	2.4	3.3	3.3	19.40	2	157315	HUA-63
3	0.43	2.7	0.5	0.3	1.2	4.6	3.2	4.1	3.7	29.10	2	157316	HUA-80
4	0.53	3.2	0.5	0.3	1.3	5.2	4.1	5.0	4.3	37.04	2	157317	HUA-100

1) Corrosion resistance class 2 according to Festo standard 940 070  
Components with moderate corrosion resistance for use in normal industrial environments subjected to contact with coolants or lubricating agents.

Dimensions are in inches, unless otherwise noted.

- I - Type discontinued  
Available up until 2011

## Compact cylinders ADVULQ/AEVULQ/AEVULQZ – Inch Series

FESTO

Accessories

Flange mounting FUA  
for piston  $\varnothing 1/2 \dots 4$  inch

Material: Clear anodized aluminum

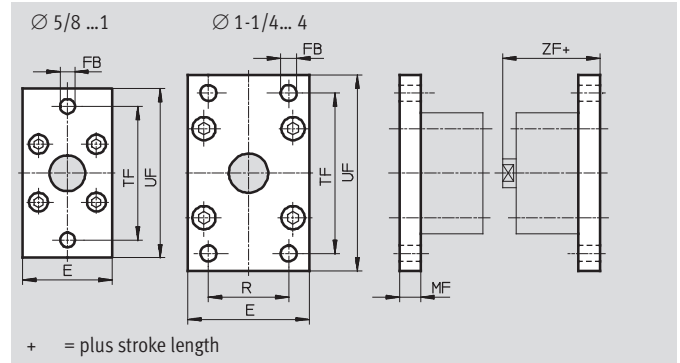

Dimensions and ordering data											
For $\varnothing$	E	FB $\varnothing$	MF	R	TF	UF	ZF	CRC <sup>2)</sup>	Weight [oz]	Part No.	Type
1/2, 5/8	1.1	0.2	0.4	–	1.7	2.2	2.1	2	1.69	157299	FUA-12/16
3/4	1.4	0.3	0.4	–	2.2	2.8	2.1	2	2.54	157300	FUA-20
1	1.6	0.3	0.4	–	2.4	3.0	2.2	2	3.07	157301	FUA-25
1-1/4	2.0	0.3	0.4	1.3	2.6	3.1	2.4	2	4.13	157302	FUA-32
1-5/8	2.4	0.4	0.4	1.4	3.2	4.0	2.4	2	6.35	157303	FUA-40
2	2.7	0.4	0.5	1.8	3.5	4.3	2.6	2	9.38	157304	FUA-50
2-1/2	3.4	0.4	0.6	2.0	4.3	5.1	2.9	2	19.40	157305	FUA-63
3	4.2	0.5	0.6	2.5	5.3	6.3	3.0	2	26.28	157306	FUA-80
4	5.0	0.6	0.6	3.0	6.4	7.5	3.6	2	36.51	157307	FUA-100

1) Free of copper, PTFE and silicone

2) Corrosion resistance class 2 according to Festo standard 940 070

Components with moderate corrosion resistance for use in normal industrial environments subjected to contact with coolants or lubricating agents.

Dimensions are in inches, unless otherwise noted.

## Compact cylinders ADVULQ/AEVULQ/AEVULQZ – Inch Series

FESTO

Accessories

### Swivel flange SUA for piston $\varnothing$ 1/2 ... 1 inch

Material:  
SUA: Anodized aluminum

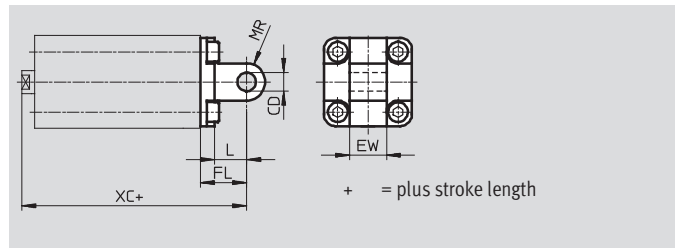

### for piston $\varnothing$ 1-1/4 ... 4 inch

Material:  
SUA: Anodized aluminum

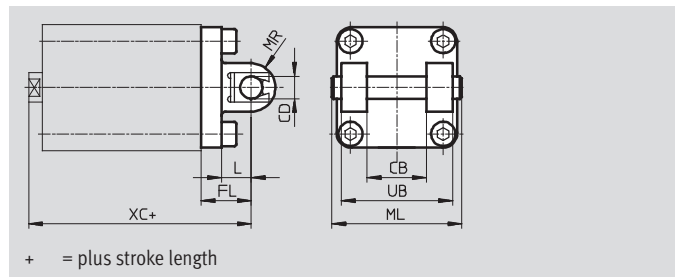

Dimensions and Ordering Data												
For $\varnothing$	CB	CD $\varnothing$	EW	FL	L	ML	MR	UB	XC	Weight [oz]	Basic version	
											Part No.	Type
1/2, 5/8	–	0.2	0.5	0.6	0.4	–	0.2	–	2.3	1.5	157319	SUA-12/16
3/4	–	0.3	0.6	0.8	0.6	–	0.3	–	2.5	2.8	157320	SUA-20
1	–	0.3	0.6	0.8	0.6	–	0.3	–	2.6	3.0	157321	SUA-25
1-1/4	1.0	0.4	–	0.9	0.5	2.1	0.4	1.8	2.9	7.3	157322	SUA-32
1-5/8	1.1	0.5	–	1.0	0.6	2.4	0.5	2.0	3.0	11.3	157323	SUA-40
2	1.3	0.5	–	1.1	0.6	2.8	0.5	2.4	3.1	15.4	157324	SUA-50
2-1/2	1.6	0.6	–	1.3	0.8	3.2	0.6	2.8	3.5	26.8	157325	SUA-63
3	2.0	0.6	–	1.4	0.9	4.0	0.6	3.5	3.9	42.0	157326	SUA-80
4	2.4	0.8	–	1.6	1.0	5.0	0.8	4.3	4.6	67.0	157327	SUA-100

**Note**  
Do not exceed the maximum overall stroke length listed when combining cylinders and swivel flanges.

For $\varnothing$	Max. stroke length [in]
1/2	2
5/8	2
3/4	2
1	2
1-1/4	4

For $\varnothing$	Max. stroke length [in]
1-5/8	4
2	4
2-1/2	4
3	6
4	6

Dimensions are in inches, unless otherwise noted.

- 1 - Type discontinued  
Available up until 2011

## Compact cylinders ADVULQ/AEVULQ/AEVULQZ – Inch Series

FESTO

Accessories

### Adapter kit DPVU for piston $\varnothing$ 1/2 ... 4 inch

Material:  
Aluminum  
Free of copper, PTFE and silicone

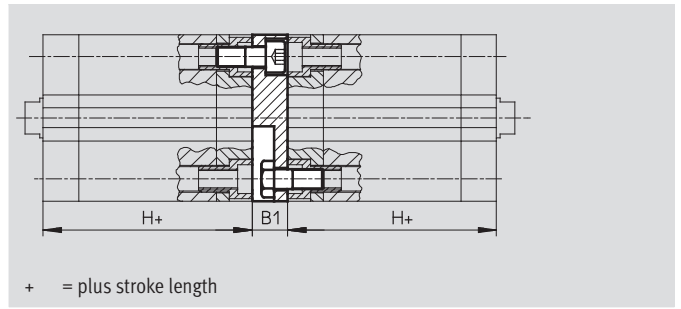

Dimensions and ordering data							
For $\varnothing$	B1	H	Max. overall stroke length [in]	CRC <sup>1)</sup>	Weight [oz]	Part No.	Type
1/2, 5/8	0.5	1.5	15.7	2	0.78	161194	DPVU-12/16
3/4	0.5	1.5	15.7	2	1.27	161195	DPVU-20
1	0.5	1.6	15.7	2	1.55	161196	DPVU-25
1-1/4	0.6	1.8	23.6	2	3.17	161197	DPVU-32
1-5/8	0.6	1.8	23.6	2	4.83	161198	DPVU-40
2	0.6	1.8	23.6	2	6.24	161199	DPVU-50
2-1/2	0.6	2.0	23.6	2	10.86	161200	DPVU-63
3	0.6	2.2	31.5	2	17.46	161201	DPVU-80
4	0.8	2.6	31.5	2	30.30	161202	DPVU-100

**Note**  
Do not exceed the maximum overall stroke length listed when combining cylinders and the adapter kit.

1) Corrosion resistance class 2 according to Festo standard 940 070  
Components with moderate corrosion resistance for use in normal industrial environments subjected to contact with coolants or lubricating agents.

### Connecting two cylinders with identical piston $\varnothing$ as a 3 or 4-position cylinder

A 3 or 4-position cylinder consists of two separate cylinders whose piston rods advance in opposing directions.

Depending upon actuation and stroke pattern, this type of cylinder can assume up to four positions. In each case the

cylinder is driven precisely against a stop. If one end of the piston rod is fixed, the cylinder barrel executes the

movement. The cylinder must be connected with flexible line connections.

#### Implementing 3 positions

Two cylinders with identical stroke length must be connected to accomplish this.

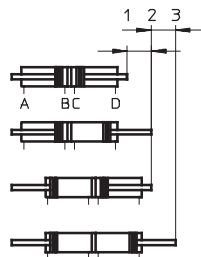

#### Implementing 4 positions

Two cylinders with different stroke lengths must be connected to accomplish this.

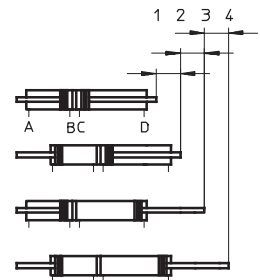



Dimensions are in inches, unless otherwise noted.

## Compact cylinders ADVULQ/AEVULQ/AEVULQZ – Inch Series

Accessories

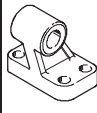
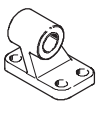
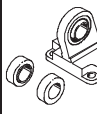
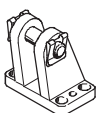
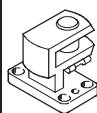
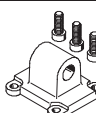
**FESTO**

Ordering Data – Mounting Attachments				Technical data → <a href="http://www.festo.com/catalog/ctype">www.festo.com/catalog/ctype</a> or <order code>			
Designation	For Ø [in]	Part No.	Type	Designation	For Ø [in]	Part No.	Type
<b>Clevis foot LBN</b>				<b>Clevis foot LNG</b>			
	1/2	6058	LBN-12/16		1-1/4	33890	LNG-32
	5/8	6058	LBN-12/16		5/8	33891	LNG-40
	3/4	6059	LBN-20/25		2	33892	LNG-50
	1	6059	LBN-20/25		2-1/2	33893	LNG-63
<b>Clevis foot LN</b>				<b>Clevis foot LSN</b>			
	1-1/4	5147	LN-32		1-1/4	5561	LSN-32
	1-5/8	5148	LN-40		1-5/3	5562	LSN-40
	2	5149	LN-50		2	5563	LSN-50
	2-1/2	5150	LN-63		2-1/2	5564	LSN-63
	3	5151	LN-80		3	5565	LSN-80
<b>Clevis foot LBG</b>				<b>Clevis foot, lateral LQG</b>			
	3/4, 1, 1-1/4, 1-5/8	31761	LBG-32		3/4, 1, 1-1/4, 1-5/8	31768	LQG-32
	2, 2-1/2	31762	LBG-40		2, 2-1/2	31769	LQG-40
	3	31763	LBG-50		3	31770	LQG-50
		31764	LBG-63			4	31771
	4	31765	LBG-80		4		31772
31766		LBG-100	31773	LQG-100			
<b>Swivel flange SNCL</b>							
	1-1/4	174404	SNCL-32				
	1-5/8	174405	SNCL-40				
	2	174406	SNCL-50				
	2-1/2	174407	SNCL-63				
	3	174408	SNCL-80				
4	174409	SNCL-100					

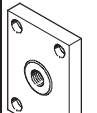
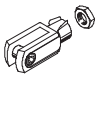
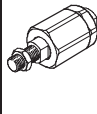

Ordering Data – Piston Rod Attachments				Technical data → <a href="http://www.festo.com/catalog/ctype">www.festo.com/catalog/ctype</a> or <order code>			
Designation	For Ø [in]	Part No.	Type	Designation	For Ø [in]	Part No.	Type
<b>Rod eye SGS</b>				<b>Coupling piece KSZ</b>			
	1/2, 5/8	532694	SGS-10-32		1/2, 5/8, 3/4	-	
	3/4	532695	SGS-5/16-24		1, 1-1/4	36129	KSZ-3/8-24-UNF
	1, 1-1/4	532696	SGS-3/8-24		1-5/8	36130	KSZ-1/2-20-UNF
	1-5/8	532697	SGS-1/2-20		2, 2-1/2	36131	KSZ-5/8-18-UNF
	2, 2-1/2	532698	SGS-5/8-18		3, 4	36132	KSZ-3/4-16-UNF
	3, 4	532699	SGS-3/4-16				
<b>Rod clevis SG</b>				<b>Self-aligning rod coupler FK</b>			
	1/2, 5/8	546552	SG-UNF10-32-B		1/2, 5/8	532703	FK-10-32
	3/4	546574	SG-UNF5/16-24-B		3/4	532704	FK-5/16-24
	1, 1-1/4	546540	SG-UNF3/8-24-B		1, 1-1/4	532705	FK-3/8-24
	1-5/8	546545	SG-UNF1/2-20-B		1-5/8	532706	FK-1/2-20
	2, 2-1/2	546575	SG-UNF5/8-18-B		2, 2-1/2	532707	FK-5/8-18
	3, 4	546576	SG-UNF3/4-16-B		3, 4	532708	FK-3/4-16

 Type discontinued  
Available up until 2011

## Compact cylinders ADVULQ/AEVULQ/AEVULQZ – Inch Series

**FESTO**

Accessories



Ordering Data – One-way Flow Control Valves			Technical data → <a href="http://www.festo.com/catalog/ctype">www.festo.com/catalog/ctype</a> or «order code»	
Connection	Thread		Part No.	Type
	10-32 UNF	For tubing OD		
<b>For exhaust air</b>				
	10-32 UNF	5/32	165008	GRLA-10-32-UNF-QS-5/32-U
		1/4	192753	GRLA-10-32-UNF-QS-1/4-U
	1/8" NPT	5/32	165009	GRLA-1/8-NPT-QS-5/32-U
		3/16	190941	GRLA-1/8-NPT-QS-3/16-U
		1/4	165010	GRLA-1/8-NPT-QS-1/4-U
		5/16	165013	GRLA-1/8-NPT-QS-5/16-U
	1/4" NPT	3/16	190944	GRLA-1/4-NPT-QS-3/16-U
		1/4	165011	GRLA-1/4-NPT-QS-1/4-U
		5/16	165014	GRLA-1/4-NPT-QS-5/16-U
		3/8	190947	GRLA-1/4-NPT-QS-3/8-U
<b>For supply air</b>				
	10-32-UNF	–	151576	GRLZ-10-UNF-B
		3/16	151579	GRLZ-10-UNF-RS-B
		1/4	151577	GRLZ-10-UNF-3/16-B
		1/4	151578	GRLZ-10-UNF-1/4-B
	1/8" NPT	–	151561	GRLZ-1/8-NPT-B
		–	151564	GRLZ-1/8-NPT-RS-B
		1/4	151562	GRLZ-1/8-NPT-1/4-B
		3/8	151563	GRLZ-1/8-NPT-3/8-B



Ordering Data – Push-in Fittings QB, NPT Thread					Technical Data → <a href="http://www.festo.com/catalog/QB">www.festo.com/catalog/QB</a>		
For tubing O.D. [in]	10/32 UNF		1/8NPT		1/4NPT		
	Part No.	Type	Part No.	Type	Part No.	Type	
<b>With external hex</b>							
	1/8	533266	QB-10-32-UNF-1/8-U	533270	QB-1/8-1/8-U	–	
	5/32	533267	QB-10-32-UNF-5/32-U	533271	QB-1/8-5/32-U	–	
	3/16	533268	QB-10-32-UNF-3/16-U	533272	QB-1/8-3/16-U	533275	QB-1/4-3/16-U
	1/4	533269	QB-10-32-UNF-1/4-U	533273	QB-1/8-1/4-U	533276	QB-1/4-1/4-U
	5/16	–	–	533274	QB-1/8-5/16-U	533277	QB-1/4-5/16-U
	3/8	–	–	–	–	533278	QB-1/4-3/8-U
	1/2	–	–	–	–	–	–

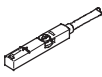

## Compact cylinders ADVULQ/AEVULQ/AEVULQZ – Inch Series

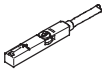
Accessories

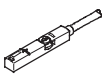
**FESTO**

Ordering Data – Proximity Switches for T-slot, Magneto-resistive					Technical data → <a href="http://www.festo.com/catalog/sm">www.festo.com/catalog/sm</a>	
	Type of mounting	Switch output	Electrical connection	Cable length [m]	Part No.	Type
<b>N/O contact</b>						
	Insertable in the slot from above, flush with cylinder profile	PNP	Cable, 3-wire	2.5	543867	SMT-8M-PS-24V-K-2,5-OE
			Plug M8x1, 3-pin	0.3	543866	SMT-8M-PS-24V-K-0,3-M8D
			Plug M12x1, 3-pin	0.3	543869	SMT-8M-PS-24V-K-0,3-M12
		NPN	Cable, 3-wire	2.5	543870	SMT-8M-NS-24V-K-2,5-OE
Plug M8x1, 3-pin	0.3		543871	SMT-8M-NS-24V-K-0,3-M8D		
	Insertable in the slot lengthwise, flush with the cylinder profile	PNP	Cable, 3-wire	2.5	175436	SMT-8-PS-K-LED-24-B
			Plug M8x1, 3-pin	0.3	175484	SMT-8-PS-S-LED-24-B
<b>N/C contact</b>						
	Insertable in the slot from above, flush with cylinder profile	PNP	Cable, 3-wire	7.5	543873	SMT-8M-PO-24V-K7,5-OE

Ordering Data – Proximity Switches for T-slot, Magnetic Reed					Technical data → <a href="http://www.festo.com/catalog/sm">www.festo.com/catalog/sm</a>	
	Type of mounting	Switch output	Electrical connection	Cable length [m]	Part No.	Type
<b>N/O contact</b>						
	Insertable in the slot from above, flush with cylinder profile	Contacting	Cable, 3-wire	2.5	543862	SME-8M-DS-24V-K-2,5-OE
				5.0	543863	SME-8M-DS-24V-K-5,0-OE
			Cable, 3-wire	2.5	543872	SME-8M-ZS-24V-K-2,5-OE
			Plug M8x1, 3-pin	0.3	543861	SME-8M-DS-24V-K-0,3-M8D
	Insertable in the slot lengthwise, flush with the cylinder profile	Contacting	Cable, 3-wire	2.5	150855	SME-8-K-LED-24
			Plug M8x1, 3-pin	0.3	150857	SME-8-S-LED-24
<b>N/C contact</b>						
	Insertable in the slot lengthwise, flush with the cylinder profile	Contacting	Cable, 3-wire	7.5	160251	SME-8-O-K-LED-24

Ordering Data – Connecting Cables				Technical data → <a href="http://www.festo.com/catalog/nebu">www.festo.com/catalog/nebu</a>	
	Electrical connection, left	Electrical connection, right	Cable length [m]	Part No.	Type
	Straight socket, M8x1, 3-pin	Cable, open end, 3-wire	2.5	541333	NEBU-M8G3-K-2.5-LE3
			5.0	541334	NEBU-M8G3-K-5-LE3
	Straight socket, M12x1, 5-pin	Cable, open end, 3-wire	2.5	541363	NEBU-M12G5-K-2.5-LE3
			5.0	541364	NEBU-M12G5-K-5-LE3
	Angled socket, M8x1, 3-pin	Cable, open end, 3-wire	2.5	541338	NEBU-M8W3-K-2.5-LE3
			5.0	541341	NEBU-M8W3-K-5-LE3
	Angled socket, M12x1, 5-pin	Cable, open end, 3-wire	2.5	541367	NEBU-M12W5-K-2.5-LE3
			5.0	541370	NEBU-M12W5-K-5-LE3

Ordering Data – Slot Cover for T-slot			Part No.	Type
	Assembly	Length [ft]		
	Insertable from above	2x 1.6	151680	ABP-5-S

# Product Range and Company Overview

## A Complete Suite of Automation Services

Our experienced engineers provide complete support at every stage of your development process, including: conceptualization, analysis, engineering, design, assembly, documentation, validation, and production.



**Custom Automation Components**  
Complete custom engineered solutions



**Custom Control Cabinets**  
Comprehensive engineering support and on-site services



**Complete Systems**  
Shipment, stocking and storage services

## The Broadest Range of Automation Components

With a comprehensive line of more than 30,000 automation components, Festo is capable of solving the most complex automation requirements.



**Electromechanical**  
Electromechanical actuators, motors, controllers & drives



**Pneumatics**  
Pneumatic linear and rotary actuators, valves, and air supply



**PLCs and I/O Devices**  
PLC's, operator interfaces, sensors and I/O devices

## Supporting Advanced Automation... As No One Else Can!

Festo is a leading global manufacturer of pneumatic and electromechanical systems, components and controls for industrial automation, with more than 12,000 employees in 56 national headquarters serving more than 180 countries. For more than 80 years, Festo has continuously elevated the state of manufacturing with innovations and optimized motion control solutions that deliver higher performing, more profitable automated manufacturing and processing equipment. Our dedication to the advancement of automation extends beyond technology to the education and development of current and future automation and robotics designers with simulation tools, teaching programs, and on-site services.

## Quality Assurance, ISO 9001 and ISO 14001 Certifications

Festo Corporation is committed to supply all Festo products and services that will meet or exceed our customers' requirements in product quality, delivery, customer service and satisfaction.

To meet this commitment, we strive to ensure a consistent, integrated, and systematic approach to management that will meet or exceed the requirements of the ISO 9001 standard for Quality Management and the ISO 14001 standard for Environmental Management.



© Copyright 2008, Festo Corporation. While every effort is made to ensure that all dimensions and specifications are correct, Festo cannot guarantee that publications are completely free of any error, in particular typing or printing errors. Accordingly, Festo cannot be held responsible for the same. For Liability and Warranty conditions, refer to our "Terms and Conditions of Sale", available from your local Festo office. All rights reserved. No part of this publication may be reproduced, distributed, or transmitted in any form or by any means, electronic, mechanical, photocopying or otherwise, without the prior written permission of Festo. All technical data subject to change according to technical update.



Printed on recycled paper at New Horizon Graphic, Inc., FSC certified as an environmentally friendly printing plant.



# Festo North America

## Festo Regional Contact Center

5300 Explorer Drive  
Mississauga, Ontario L4W 5G4  
Canada

### USA Customers:

For ordering assistance,  
**Call:** 1.800.99.FESTO (1.800.993.3786)  
**Fax:** 1.800.96.FESTO (1.800.963.3786)  
**Email:** customer.service@us.festo.com

For technical support,  
**Call:** 1.866.GO.FESTO (1.866.463.3786)  
**Fax:** 1.800.96.FESTO (1.800.963.3786)  
**Email:** product.support@us.festo.com

### Canadian Customers:

**Call:** 1.877.GO.FESTO (1.877.463.3786)  
**Fax:** 1.877.FX.FESTO (1.877.393.3786)  
**Email:** festo.canada@ca.festo.com

---

## USA Headquarters

Festo Corporation  
395 Moreland Road  
P.O. Box 18023  
Hauppauge, NY 11788, USA  
[www.festo.com/us](http://www.festo.com/us)

---

## USA Sales Offices

### Appleton

North 922 Tower View Drive, Suite N  
Greenville, WI 54942, USA

### Boston

120 Presidential Way, Suite 330  
Woburn, MA 01801, USA

### Chicago

1441 East Business Center Drive  
Mt. Prospect, IL 60056, USA

### Dallas

1825 Lakeway Drive, Suite 600  
Lewisville, TX 75057, USA

### Detroit – Automotive Engineering Center

2601 Cambridge Court, Suite 320  
Auburn Hills, MI 48326, USA

### New York

395 Moreland Road  
Hauppauge, NY 11788, USA

### Silicon Valley

4935 Southfront Road, Suite F  
Livermore, CA 94550, USA

## United States



**USA Headquarters, East:** Festo Corp., 395 Moreland Road, Hauppauge, NY 11788  
Phone: 1.631.435.0800; Fax: 1.631.435.8026;  
Email: [info@festo-usa.com](mailto:info@festo-usa.com) [www.festo.com/us](http://www.festo.com/us)

## Canada



**Headquarters:** Festo Inc., 5300 Explorer Drive, Mississauga, Ontario L4W 5G4  
Phone: 1.905.624.9000; Fax: 1.905.624.9001;  
Email: [festo.canada@ca.festo.com](mailto:festo.canada@ca.festo.com) [www.festo.ca](http://www.festo.ca)

## Mexico



**Headquarters:** Festo Pneumatic, S.A., Av. Ceylán 3, Col. Tequesquihuac,  
54020 Tlalneantla, Edo. de México  
Phone: 011 52 [55] 53 21 66 00; Fax: 011 52 [55] 53 21 66 65;  
Email: [festo.mexico@mx.festo.com](mailto:festo.mexico@mx.festo.com) [www.festo.com/mx](http://www.festo.com/mx)

---

## Central USA

Festo Corporation  
1441 East Business  
Center Drive  
Mt. Prospect, IL 60056, USA  
Phone: 1.847.759.2600  
Fax: 1.847.768.9480



## Western USA

Festo Corporation  
4935 Southfront Road,  
Suite F  
Livermore, CA 94550, USA  
Phone: 1.925.371.1099  
Fax: 1.925.245.1286



---

## Festo Worldwide

Argentina Australia Austria Belarus Belgium Brazil Bulgaria Canada Chile China Colombia Croatia Czech Republic Denmark  
Estonia Finland France Germany Great Britain Greece Hong Kong Hungary India Indonesia Iran Ireland Israel Italy Japan Latvia  
Lithuania Malaysia Mexico Netherlands New Zealand Norway Peru Philippines Poland Romania Russia Serbia Singapore  
Slovakia Slovenia South Africa South Korea Spain Sweden Switzerland Taiwan Thailand Turkey Ukraine United States Venezuela

[www.festo.com](http://www.festo.com)