

Membrane air dryers MS-LDM1, MS series

FESTO



Characteristics

MS series service unit components

Solutions for every application

With its large product range, highly effective components and a wide choice of functions, the MS series from Festo offers a complete concept for compressed air preparation. Suitable for simple standard applications as well as application-specific solutions to the highest quality standards.

Available as individual components, pre-assembled combinations ex-stock,

application-specific combinations or complete turnkey solutions. The five sizes in the MS series achieve maximum flow rates with minimum space requirements.

Freely combinable function modules

Pressure regulators, on/off and soft-start valves with safety function, filters, pressure and flow sensors, dryers, sensors and lubricators. All these allow a suitable solution to be assembled for every task. Their modular structure means that the components are freely combinable. A simple connection system saves time when replacing individual modules without

needing to dismantle the entire combination.

What's more, many of the components are certified to UL and ATEX.

CAD models and configurator

Convenient aids for planning and selecting application-specific individual devices and combinations. The product configurator lets you configure customised solutions quickly and transfer the order data with no hassle.

Engineering tools

Selection tool for choosing the right service unit without oversizing, and with the right air quality class:

→ www.festo.com/engineering/wartungseinheit

Air quality

This program supports configuring an appropriate service unit. Please insert the required air cleanliness either by your application or an ISO-code or by direct selection of air filters.

Selection criteria: Application

Filter combination is proposed based upon your selected application

- standard pneumatics operation of valves and cylinders, e.g. in automotive industry, secondary packaging
- mining and building industry applications without special air cleanliness requirements
- application of pressure operated tools and machines pneumatic hammer, air engine, positioning with proportional valve
- electronic, flatpanel and solar industry, textile and paper production application with residual oil content $\leq 0.5 \text{ mg/m}^3$
- painting, powder coating, air bearing application with residual oil content $\leq 0.1 \text{ mg/m}^3$
- food and beverage industry, optics application with residual oil content $\leq 0.01 \text{ mg/m}^3$ reduction of all vapours and aromas

Selection criteria: ISO-class

Filter combination is proposed based upon the air cleanliness class according to ISO 8573-1:2010

particle : 4 : oil

ISO

Direct filter selection

Independent selection of filter combination

- 40 µm Filter
- 5 µm Filter
- 1 µm Fine Filter
- 0.01 µm Micro Filter *
- Active Carbon Filter



* Downstream from the compressor the water content is assumed to be ISO class 4, better classes can be achieved by applying an absorption dryer (FCO) or a membrane dryer (CM4)

Integrated sensors

Pressure and flow sensors

Safety functions

Soft-start/quick exhaust valves

MS6-SV/MS9-SV

Energy savings

Service units MSE6

Intelligent mix of sizes



- Maximum machine availability through controlled processes
- Reliable air preparation and supply for systems
- Integrated or stand-alone
- Easy to connect with M8/M12 plug



- Fast and reliable exhausting of systems up to Performance Level e, certified to DIN EN ISO 13849-1
- Integrated soft-start function



- Fully automatic monitoring and regulation of compressed air supply
- Automatic shut-off of the compressed air in stand-by mode
- Detection and notification of leakages
- Condition monitoring of relevant process data



- Optimum flow rate with up to 18% smaller size
- Excellent energy efficiency
- Cost-optimised combinations – save up to 30%!

Size differences

Size	MS2	MS4	MS6	MS9	MS12
Grid dimension [mm]	25	40	62	90	124
Connection sizes	M5, QS-6	G1/8, G1/4, G3/8	G1/4, G3/8, G1/2, G3/4	G1/2, G3/4, G1, G1 1/4, G1 1/2	G1, G1 1/4, G1 1/2, G2
Standard nominal flow rate q_{N1} [l/min]	350	1800	6500	20000	22000

1) Using pressure regulator MS-LR as an example

Characteristics

Note

Information

The next few pages provide a brief overview of the complete product range for the MS series service unit components.

You can find detailed information and all of the technical data in the documentation for the corresponding service unit component.

Accessories such as connecting plates or mounting brackets can be ordered either via the configurator or separately.

Structure of a service unit

The order of the individual components within a service unit is relevant for safety and functionality. It is not possible to assemble the service unit components in any order in the flow direction. There are restrictions and rules.





The configurator for the service unit MSB is a reliable and convenient way of arranging individual service unit components and this ensures that the applicable rules are complied with. As a result, you get a completely assembled unit with UL or ATEX certification if you need it.

When arranging a combination of individually configured and ordered service unit components, the points on the right must be adhered to under all circumstances.





- Regulators MS-LFR/LR/LRP/LRE are only permissible in the flow direction with the same or decreasing pressure regulation range
- Filters MS-LFR/LF/LFM/LFX are only permissible in the flow direction with an increasing grade of filtration
- Lubricators MS-LOE are not permitted in the flow direction upstream of a filter MS-LFR/LFM/LF/LFX, water separator MS-LWS or membrane air dryer MS-LDM1

- A micro filter MS-LFM must be installed upstream of an activated carbon filter MS-LFX or membrane air dryer MS-LDM1 in the flow direction
- A flow sensor SFAM cannot be installed directly downstream of a regulator MS-LFR/LR; a branching module MS-FRM must be positioned between them
- A soft-start/quick exhaust valve MS-SV must be the last service unit component in the flow direction







Total product range for MS series service unit components

Type	Description	Size	Pneumatic connection					
			Push-in connector	Female thread			Connecting plate with thread	
				M	G	NPT	G	NPT
Combinations								
Service units MSB-FRC Data sheets → Internet: msb								
	Combinations of filter regulator and lubricator	4	–	–	1/8, 1/4	–	–	–
		6	–	–	1/4, 3/8, 1/2	–	–	–
Service units MSB Data sheets → Internet: msb								
	7 combinations, predefined	4	–	–	1/4	–	–	–
		6	–	–	1/2	–	–	–
	Combinations freely configurable	4	–	–	1/8, 1/4	–	1/8, 1/4, 3/8	1/8, 1/4, 3/8
		6	–	–	1/4, 3/8, 1/2	–	1/4, 3/8, 1/2, 3/4	1/4, 3/8, 1/2, 3/4
		9	–	–	3/4, 1	3/4, 1	1/2, 3/4, 1, 1 1/4, 1 1/2	1/2, 3/4, 1, 1 1/4, 1 1/2
Service units MSE6 Data sheets → Internet: mse6								
	Combinations with fieldbus connection for measuring pressure, flow rate and consumption	6	–	–	–	–	1/2	–







Characteristics

Total product range for MS series service unit components								
Type	Description	Size	Pneumatic connection			Connecting plate with thread		
			Push-in connector	Female thread		G		NPT
			M	G	NPT	G	NPT	
Individual devices								
Filter regulators MS-LFR								Data sheets → Internet: ms-lfr
	Filter and pressure regulator in a single device, filtration grade 5 or 40 µm	2	QS-6	M5	–	–	–	–
		4	–	–	1/8, 1/4	–	1/8, 1/4, 3/8	1/8, 1/4, 3/8
		6	–	–	1/4, 3/8, 1/2	–	1/4, 3/8, 1/2, 3/4	1/4, 3/8, 1/2, 3/4
		9	–	–	3/4, 1	3/4, 1	1/2, 3/4, 1, 1 1/4, 1 1/2	1/2, 3/4, 1, 1 1/4, 1 1/2
		12	–	–	–	–	1, 1 1/4, 1 1/2, 2	–
Filter MS-LF								Data sheets → Internet: ms-lf
	Grade of filtration 5 or 40 µm	4	–	–	1/8, 1/4	–	1/8, 1/4, 3/8	1/8, 1/4, 3/8
		6	–	–	1/4, 3/8, 1/2	–	1/4, 3/8, 1/2, 3/4	1/4, 3/8, 1/2, 3/4
		9	–	–	3/4, 1	3/4, 1	1/2, 3/4, 1, 1 1/4, 1 1/2	1/2, 3/4, 1, 1 1/4, 1 1/2
		12	–	–	–	–	1, 1 1/4, 1 1/2, 2	–
Fine and micro filters MS-LFM								Data sheets → Internet: ms-lfm
	Grade of filtration 0.01 or 1 µm	4	–	–	1/8, 1/4	–	1/8, 1/4, 3/8	1/8, 1/4, 3/8
		6	–	–	1/4, 3/8, 1/2	–	1/4, 3/8, 1/2, 3/4	1/4, 3/8, 1/2, 3/4
		9	–	–	3/4, 1	3/4, 1	1/2, 3/4, 1, 1 1/4, 1 1/2	1/2, 3/4, 1, 1 1/4, 1 1/2
		12	–	–	–	–	1, 1 1/4, 1 1/2, 2	–
Activated carbon filters MS-LFX								Data sheets → Internet: ms-lfx
	For removing liquid and gaseous oil particles	4	–	–	1/8, 1/4	–	1/8, 1/4, 3/8	1/8, 1/4, 3/8
		6	–	–	1/4, 3/8, 1/2	–	1/4, 3/8, 1/2, 3/4	1/4, 3/8, 1/2, 3/4
		9	–	–	3/4, 1	3/4, 1	1/2, 3/4, 1, 1 1/4, 1 1/2	1/2, 3/4, 1, 1 1/4, 1 1/2
		12	–	–	–	–	1, 1 1/4, 1 1/2, 2	–
Water separators MS-LWS								Data sheets → Internet: ms-lws
	Remove condensate from compressed air, maintenance-free	6	–	–	1/4, 3/8, 1/2	–	1/4, 3/8, 1/2, 3/4	1/4, 3/8, 1/2, 3/4
		9	–	–	3/4, 1	3/4, 1	1/2, 3/4, 1, 1 1/4, 1 1/2	1/2, 3/4, 1, 1 1/4, 1 1/2
		12	–	–	–	–	1, 1 1/4, 1 1/2, 2	–





Characteristics

Total product range for MS series service unit components								
Type	Description	Size	Pneumatic connection			Connecting plate with thread		
			Push-in connector	Female thread		G		NPT
			M	G	NPT	G	NPT	
Individual devices								
Pressure regulators MS-LR								Data sheets → Internet: ms-lr
	For setting the required operating pressure, 4 pressure regulation ranges	2	QS-6	M5	–	–	–	–
		4	–	–	1/8, 1/4	–	1/8, 1/4, 3/8	1/8, 1/4, 3/8
		6	–	–	1/4, 3/8, 1/2	–	1/4, 3/8, 1/2, 3/4	1/4, 3/8, 1/2, 3/4
		9	–	–	3/4, 1	3/4, 1	1/2, 3/4, 1, 1 1/4, 1 1/2	1/2, 3/4, 1, 1 1/4, 1 1/2
		12	–	–	–	–	1, 1 1/4, 1 1/2, 2	–
Pressure regulators MS-LRB								Data sheets → Internet: ms-lrb
	For configuring a regulator manifold with independent pressure regulation ranges. Pressure output is to the front or rear.	4	–	–	1/4	–	1/8, 1/4, 3/8	–
		6	–	–	1/2	–	1/4, 3/8, 1/2, 3/4	–
Precision pressure regulators MS-LRP								Data sheets → Internet: ms-lrp
	For precisely setting of the required operating pressure, 4 pressure regulation ranges, pressure hysteresis 0.02 bar	6	–	–	1/4, 3/8, 1/2	–	1/4, 3/8, 1/2, 3/4	1/4, 3/8, 1/2, 3/4
Precision pressure regulators MS-LRPB								Data sheets → Internet: ms-lrpb
	For configuring a regulator manifold with independent pressure regulation ranges. Pressure output is to the front or rear.	6	–	–	1/2	–	1/4, 3/8, 1/2, 3/4	–
Electric pressure regulators MS-LRE								Data sheets → Internet: ms-lre
	Electrically adjustable pressure regulator, 4 pressure regulation ranges	6	–	–	1/4, 3/8, 1/2	–	1/4, 3/8, 1/2, 3/4	1/4, 3/8, 1/2, 3/4
Lubricators MS-LOE								Data sheets → Internet: ms-loe
	Add a precisely adjustable amount of oil to the compressed air. The amount of oil mist is proportional to the compressed air flow rate.	4	–	–	1/8, 1/4	–	1/8, 1/4, 3/8	1/8, 1/4, 3/8
		6	–	–	1/4, 3/8, 1/2	–	1/4, 3/8, 1/2, 3/4	1/4, 3/8, 1/2, 3/4
		9	–	–	3/4, 1	3/4, 1	1/2, 3/4, 1, 1 1/4, 1 1/2	1/2, 3/4, 1, 1 1/4, 1 1/2
		12	–	–	–	–	1, 1 1/4, 1 1/2, 2	–

Characteristics

Total product range for MS series service unit components								
Type	Description	Size	Pneumatic connection			Connecting plate with thread		
			Push-in connector	Female thread		G		NPT
			M	G	NPT	G	NPT	
Individual devices								
On/off valves MS-EM								Data sheets → Internet: ms-em
	Manually operated on/off valve for pressurising and exhausting pneumatic installations.	4	–	–	1/8, 1/4	–	1/8, 1/4, 3/8	1/8, 1/4, 3/8
		6	–	–	1/4, 3/8, 1/2	–	1/4, 3/8, 1/2, 3/4	1/4, 3/8, 1/2, 3/4
		9	–	–	3/4, 1	3/4, 1	1/2, 3/4, 1, 1 1/4, 1 1/2	1/2, 3/4, 1, 1 1/4, 1 1/2
		12	–	–	–	–	1, 1 1/4, 1 1/2, 2	–
On/off valves MS-EE								
On/off valves MS-EE								Data sheets → Internet: ms-ee
	Solenoid-actuated on/off valve for pressurising and exhausting pneumatic installations.	4	–	–	1/8, 1/4	–	1/8, 1/4, 3/8	1/8, 1/4, 3/8
		6	–	–	1/4, 3/8, 1/2	–	1/4, 3/8, 1/2, 3/4	1/4, 3/8, 1/2, 3/4
		9	–	–	3/4, 1	3/4, 1	1/2, 3/4, 1, 1 1/4, 1 1/2	1/2, 3/4, 1, 1 1/4, 1 1/2
		12	–	–	–	–	1, 1 1/4, 1 1/2, 2	–
Soft-start valves MS-DL								
Soft-start valves MS-DL								Data sheets → Internet: ms-dl
	Pneumatically actuated soft-start valve for slowly pressurising and exhausting pneumatic installations.	4	–	–	1/8, 1/4	–	1/8, 1/4, 3/8	1/8, 1/4, 3/8
		6	–	–	1/4, 3/8, 1/2	–	1/4, 3/8, 1/2, 3/4	1/4, 3/8, 1/2, 3/4
		12	–	–	–	–	1, 1 1/4, 1 1/2, 2	–
Soft-start valves MS-DE								
Soft-start valves MS-DE								Data sheets → Internet: ms-de
	Solenoid-actuated soft-start valve for slowly pressurising and exhausting pneumatic installations.	4	–	–	1/8, 1/4	–	1/8, 1/4, 3/8	1/8, 1/4, 3/8
		6	–	–	1/4, 3/8, 1/2	–	1/4, 3/8, 1/2, 3/4	1/4, 3/8, 1/2, 3/4
		12	–	–	–	–	1, 1 1/4, 1 1/2, 2	–
Soft-start/quick exhaust valves MS-SV								
Soft-start/quick exhaust valves MS-SV								Data sheets → Internet: ms-sv
	For building up pressure gradually and reducing pressure quickly and safely in pneumatic piping systems. Up to category 1, PL c.	6	–	–	1/2	–	1/4, 3/8, 1/2, 3/4	1/4, 3/8, 1/2, 3/4
		9	–	–	3/4, 1	3/4, 1	1/2, 3/4, 1, 1 1/4, 1 1/2	1/2, 3/4, 1, 1 1/4, 1 1/2
	Up to category 3, PL d. Up to category 4, PL e in the case of optional extension.	6	–	–	1/2	–	1/4, 3/8, 1/2, 3/4	1/4, 3/8, 1/2, 3/4
	Up to category 4, PL e.	6	–	–	1/2	–	1/4, 3/8, 1/2, 3/4	–

Characteristics

Total product range for MS series service unit components								
Type	Description	Size	Pneumatic connection				Connecting plate with thread	
			Push-in connector	Female thread				
			M	G	NPT	G	NPT	
Individual devices								
Membrane air dryer MS-LDM1							Data sheets → Internet: ms-ldm	
	Wear-free membrane dryer with internal air consumption	4	–	–	1/8, 1/4	–	1/8, 1/4, 3/8	1/8, 1/4, 3/8
		6	–	–	1/4, 3/8, 1/2	–	1/4, 3/8, 1/2, 3/4	1/4, 3/8, 1/2, 3/4
Branching modules MS-FRM								
Branching modules MS-FRM							Data sheets → Internet: ms-frm	
	Compressed air distributors with 4 connections	4	–	–	1/8, 1/4	–	1/8, 1/4, 3/8	–
		6	–	–	1/4, 3/8, 1/2	–	1/4, 3/8, 1/2, 3/4	–
		9	–	–	3/4, 1	3/4, 1	1/2, 3/4, 1, 1 1/4, 1 1/2	1/2, 3/4, 1, 1 1/4, 1 1/2
		12	–	–	–	–	1, 1 1/4, 1 1/2, 2	–
Distributor blocks MS-FRM-FRZ								
Distributor blocks MS-FRM-FRZ							Data sheets → Internet: ms-frm-frz	
	Compressed air distributors with 4 connections and half the grid width	4	–	–	–	–	–	–
		6	–	–	–	–	–	–
Flow sensors SFAM								
Flow sensors SFAM							Data sheets → Internet: sfam	
	For absolute flow rate information and accumulated air consumption measurement	6	–	–	–	–	1/2	1/2
		9	–	–	–	–	1, 1 1/2	1, 1 1/2

Peripherals overview

Membrane air dryer MS4/MS6-LDM1

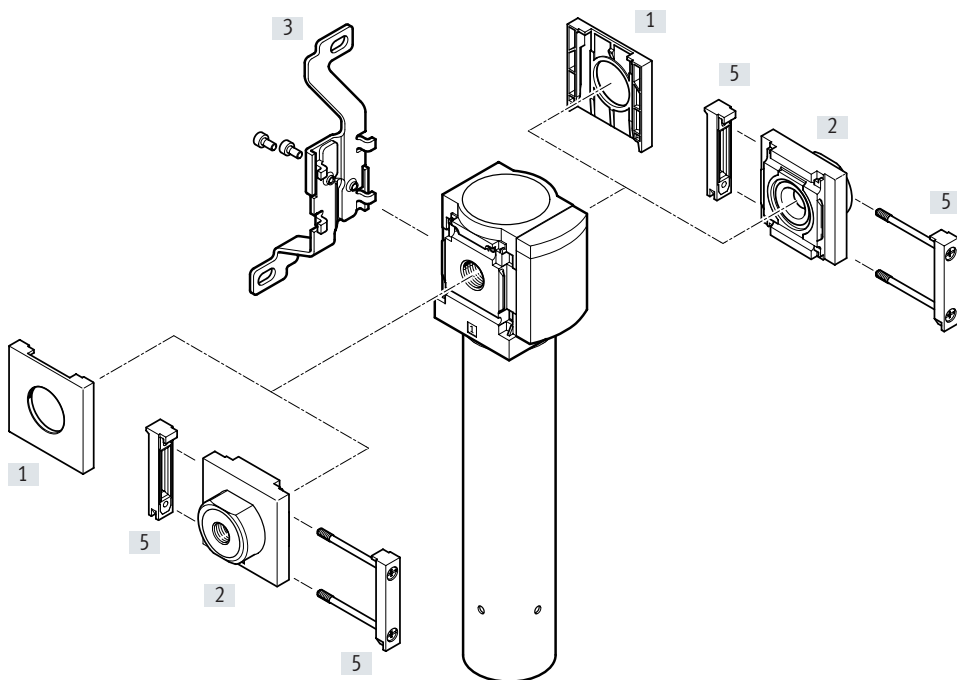

Note

Additional accessories:

- Module connector for combination with size MS4/MS6 or size MS9
→ Internet: amv, rmv, armv
- Adapter for mounting on profiles
→ Internet: ipm-80, ipm-40-80, ipm-80-80

Mounting components and accessories

	Individual device		Combination		→ Page/ Internet
	Without connecting plate	With connecting plate	Without connecting plate	With connecting plate	
[1] Cover cap MS4/6-END	■	–	■	–	ms4-end, ms6-end
[2] Connecting plate-SET MS4/6-AG...	–	■	–	■	ms4-ag, ms6-ag
Connecting plate-SET MS4/6-AQ..	–	■	–	■	ms4-aq, ms6-aq
[3] Mounting bracket MS4/6-WB	■	■	–	–	ms4-wb, ms6-wb
[5] Module connector MS4/6-MV	–	■	■	■	ms4-mv, ms6-mv
– Mounting bracket MS4-WBM	■	■	–	–	ms4-wbm
– Mounting bracket MS4/6-WP/WPB/WPE/WPM	–	■	■	■	ms4-wp, ms6-wp

Type codes

MS4-LDM1

001	Series
MS4	MS series, size 4
002	Function
LDM1	Membrane air dryer
003	Pneumatic connection
1/8	Female thread G1/8
1/4	Female thread G1/4
AGA	Sub-base G1/8
AGB	Sub-base G1/4
AGC	Sub-base G3/8
AQK	Sub-base 1/8 NPT
AQN	Sub-base 1/4 NPT
AQP	Sub-base 3/8 NPT
004	Flow cartridge
P05	50 l/min
P10	100 l/min
005	Purge air
	Unducted
PAC	Ducted

006	Type of mounting
	Without mounting bracket
WP	Mounting bracket basic design
WPM	Mounting bracket for hooking in service unit components
WB	Mounting centrally at rear (wall mounting top and bottom), connecting plates not required
WBM	Mounting centrally at rear (wall mounting top), connecting plates not required

007	EU certification
	None
EX4	II 2GD

008	UL certification
	None
UL1	cULus ordinary location for Canada and USA

009	Flow direction
	Flow direction from left to right
Z	Flow direction from right to left

MS6-LDM1

001	Series
MS6	MS-series, size 6
002	Function
LDM1	Membrane air dryer
003	Pneumatic connection
1/4	Female thread G1/4
3/8	Female thread G3/8
1/2	Female thread G1/2
AGB	Sub-base G1/4
AGC	Sub-base G3/8
AGD	Sub-base G1/2
AGE	Sub-base G3/4
AQN	Sub-base 1/4 NPT
AQP	Sub-base 3/8 NPT
AQR	Sub-base 1/2 NPT
AQS	Sub-base 3/4 NPT
004	Flow cartridge
P20	200 l/min
P30	300 l/min
P40	400 l/min

005	Purge air
	Unducted
PAC	Ducted

006	Type of mounting
	Without mounting bracket
WP	Mounting bracket basic design
WPM	Mounting bracket for hooking in service unit components
WB	Mounting centrally at rear (wall mounting top and bottom), connecting plates not required

007	EU certification
	None
EX4	II 2GD



008	UL certification
	None
UL1	cULus ordinary location for Canada and USA

009	Flow direction
	Flow direction from left to right
Z	Flow direction from right to left

Data sheet

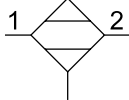
Function



-  - Flow rate
50 ... 400 l/min
-  - Temperature range
+2 ... +50°C
-  - Operating pressure
3 ... 12.5 bar

Pressure dewpoint reduction:
20 K



Typical areas of application:

- Drying, cleaning of precision parts
- Measuring technology
- Rinsing of precision glass scales
- Painting systems
- Paper and packaging machines



Note

Prefiltration of the compressed air using a micro filter MS-LFM-A, grade of filtration 0.01 µm (residual particles < 0.1 µm, residual oil content < 0.1 mg/m³) is vital for correct functioning of the component.

- Optimum final dryer with excellent operational reliability
- Suitable for use as an individual device or for integration into existing service unit combinations
- Flow rate-dependent dewpoint reduction
- Wear-free function requiring no external energy
- The composition of the compressed air remains almost unchanged due to the drying process
- 15% purge air flow rate
- Optional purge ring for ducting the purge air
- Optional device variant EX4 for use in potentially explosive areas in zones 1, 2, 21 and 22

General technical data

Size	MS4	MS6
Pneumatic connection 1, 2		
Female thread	G1/8 or G1/4	G1/4, G3/8 or G1/2
Connecting plate [AG...]	G1/8, G1/4 or G3/8	G1/4, G3/8, G1/2 or G3/4
[AQ...]	1/8 NPT, 1/4 NPT or 3/8 NPT	1/4 NPT, 3/8 NPT, 1/2 NPT or 3/4 NPT
Design	Membrane dryer with internal air consumption	
Type of mounting	Via accessories In-line installation	
Mounting position	Vertical ±5°	
Air quality class at the output	Compressed air to ISO 8573-1:2010 [1:3:2]	

† Note: This product conforms to ISO 1179-1 and ISO 228-1.

Standard flow rate $q_n^{1)}$ [l/min]

Size	MS4			MS6		
	P05	P10	P20	P30	P40	
Input $q_{n In}$	59	118	235	353	471	
Output $q_{n Out}$	50	100	200	300	400	
Purge air $q_{n Purge}$	8.8	17.6	35.3	52.9	70.6	

1) Measured at $p_1 = 6.9 \text{ bar}$, $\theta_{pd In} = 25^\circ\text{C}$, $\theta_{pd Out} = 5^\circ\text{C} \pm 1.5^\circ\text{C}$ ($\theta_{pa Out} = -21.5^\circ\text{C} \pm 1.2^\circ\text{C}$), $\theta_{amb} = 25^\circ\text{C}$

Data sheet

Operating and environmental conditions		
Operating pressure	[bar]	3 ... 12.5 (3 ... 10) ¹⁾
Operating medium		Compressed air to ISO 8573-1:2010 [1:4:2]
Note on operating/ pilot medium		Operation with lubricated medium not possible
Pressure dewpoint reduction	[K]	20
Ambient temperature	[°C]	+2 ... +50
Temperature of medium	[°C]	+2 ... +50
Storage temperature	[°C]	-20 ... +60
Corrosion resistance class CRC ²⁾		2
Suitability for the food industry ³⁾		See supplementary material information
UL certification ³⁾		c UL us - Recognized (OL)

1) Value in brackets applies to MS4/MS6-LDM1 with UL certification.

2) Corrosion resistance class CRC 2 to Festo standard FN 940070

Moderate corrosion stress. Indoor applications in which condensation can occur. External visible parts with primarily decorative surface requirements which are in direct contact with a normal industrial environment.

3) Additional information www.festo.com/sp → Certificates.

ATEX	
EU certification	EX4
ATEX category for gas	II 2G
Type of ignition protection for gas	Ex h IIC T6 Gb X
ATEX category for dust	II 2D
Type of ignition protection for dust	Ex h IIIC T60°C Db X
Explosion-proof ambient temperature	+2°C ≤ Ta ≤ +50°C
CE marking (see declaration of conformity) ¹⁾	To EU Explosion Protection Directive (ATEX)

1) Note operating range of proximity switches.

Weight [g]					
Size	MS4		MS6		
Flow cartridge	P05	P10	P20	P30	P40
Membrane air dryer	420	530	1050	1200	1300

Materials

Sectional view

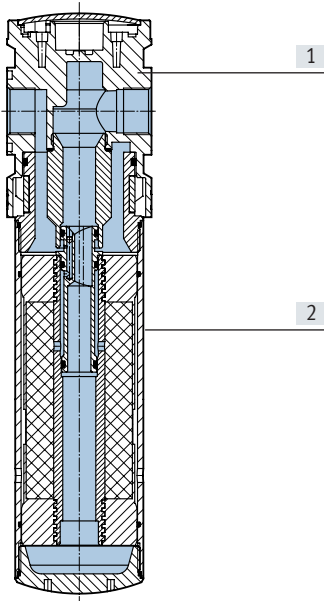

Membrane air dryer		
[1]	Housing	Die-cast aluminium
[2]	Bowl	Wrought aluminium alloy
-	Seals	NBR
Note on materials		RoHS-compliant

Data sheet

Pressure dewpoint t_{pd} (output) as a function of standard flow rate at output q_n ¹⁾

MS4-LDM1-...-P05

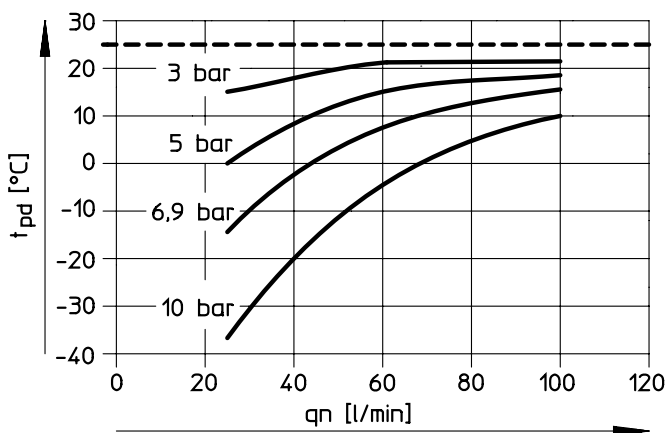

MS4-LDM1-...-P10

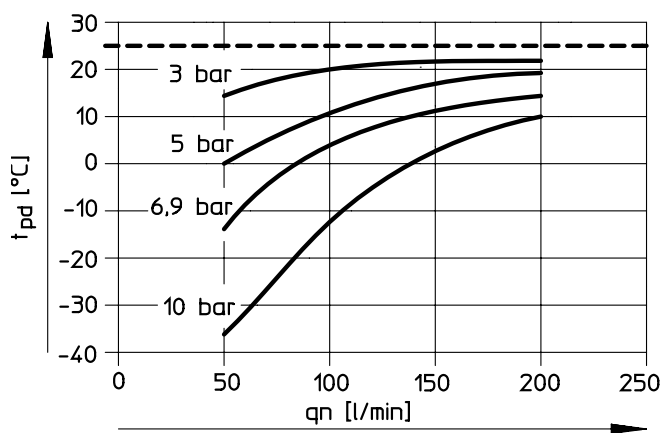

MS6-LDM1-...-P20

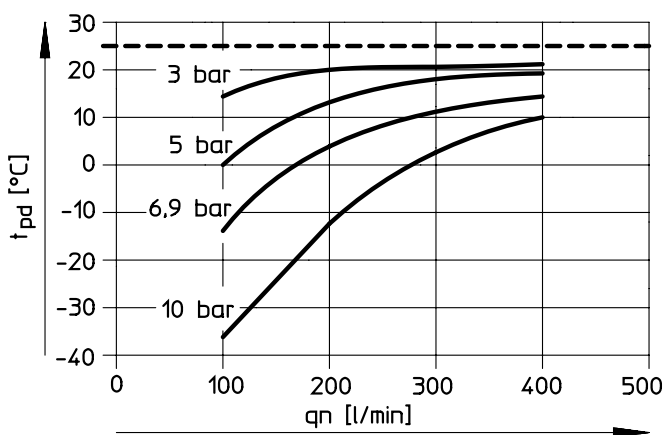

MS6-LDM1-...-P30

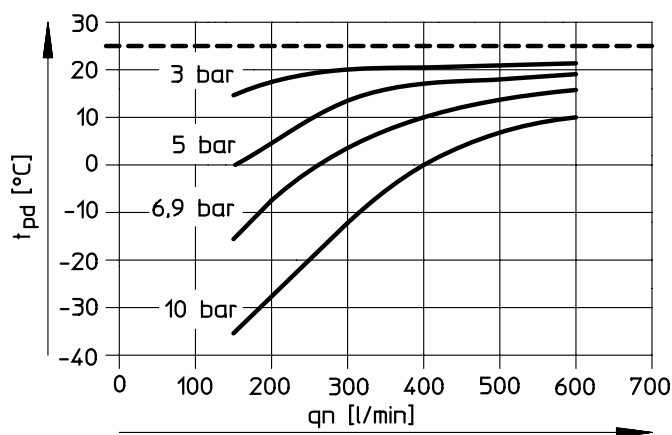

MS6-LDM1-...-P40

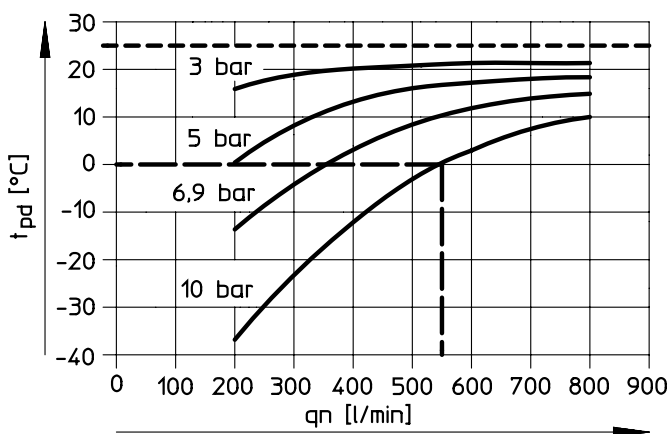

- 1) Measured at pressure dewpoint t_{pd} (input) = 25°C.
- Example using MS6-LDM1-...-P40 at 10 bar operating pressure: at a standard flow rate of $q_n = 550$ l/min the pressure dewpoint reduction is 25 K.

Data sheet

Differential pressure Δp as a function of the standard flow rate at output q_n

MS4-LDM1-...-P05

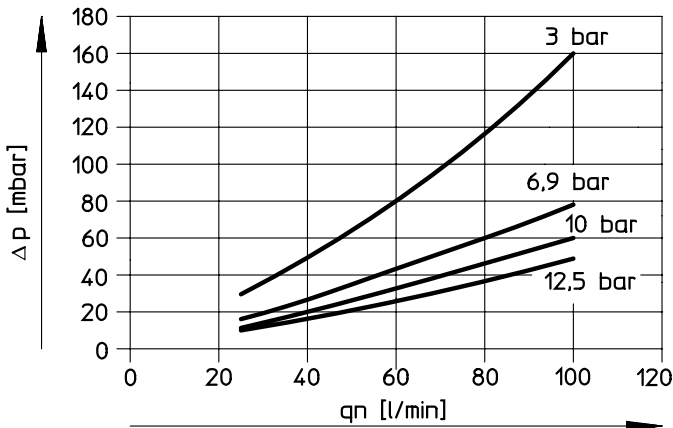

MS4-LDM1-...-P10

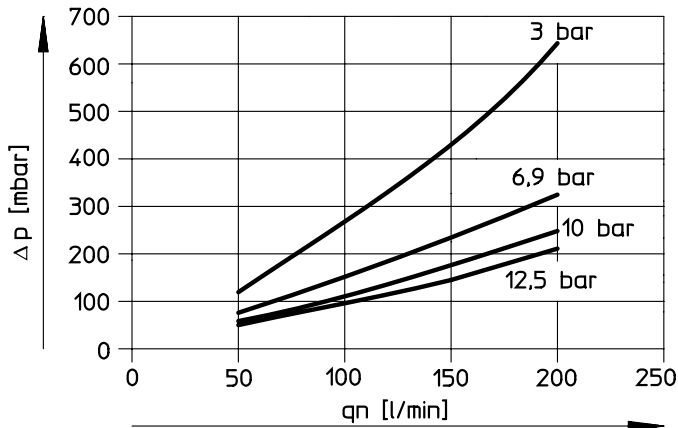

MS6-LDM1-...-P20

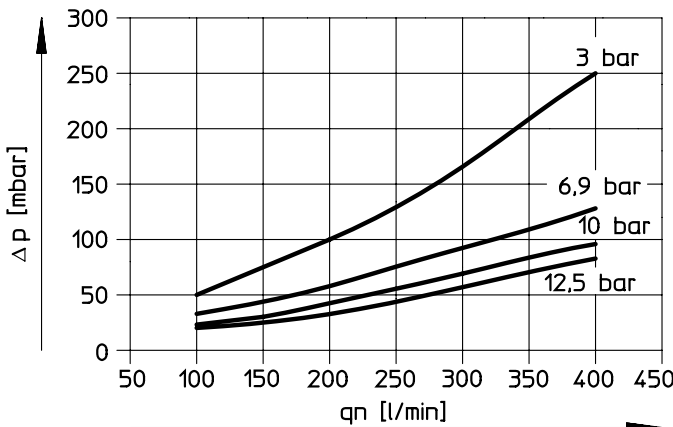

MS6-LDM1-...-P30

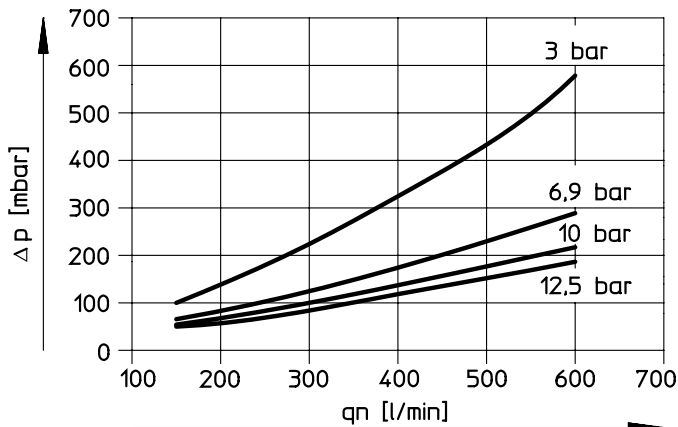

MS6-LDM1-...-P40

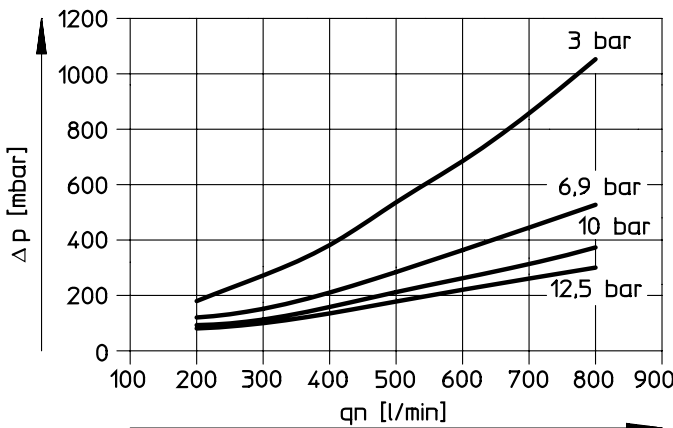

Data sheet

Dimensions

Download CAD data → www.festo.com

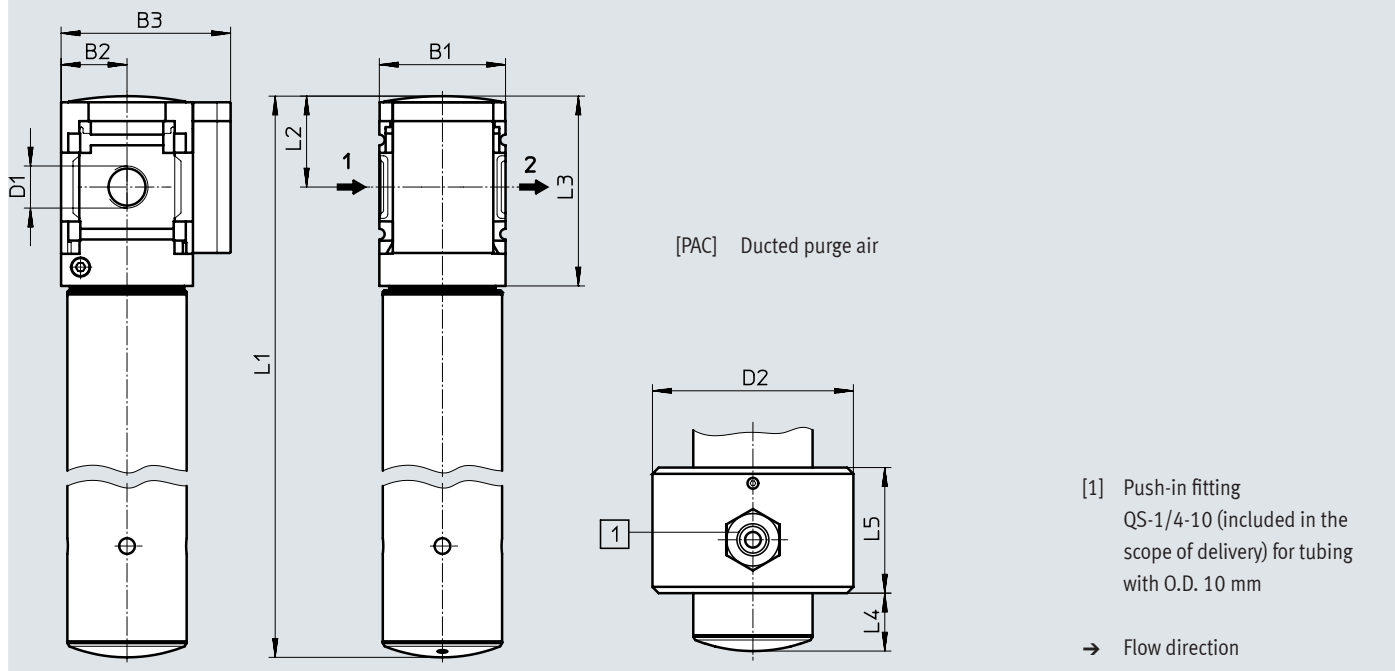

Type	B1	B2	B3	D1	D2	L1	L2	L3	L4	L5
MS4-LDM1-1/8-P05	40	21	54	G1/8	64	245	29	60	18	40
MS4-LDM1-1/8-P10						345				
MS4-LDM1-1/4-P05	40	21	54	G1/4	64	245	29	60	18	40
MS4-LDM1-1/4-P10						345				
MS6-LDM1-1/4-P20	62	31	76	G1/4	80	345	42	87	34	40
MS6-LDM1-1/4-P30						415				
MS6-LDM1-1/4-P40						475				
MS6-LDM1-3/8-P20	62	31	76	G3/8	80	345	42	87	34	40
MS6-LDM1-3/8-P30						415				
MS6-LDM1-3/8-P40						475				
MS6-LDM1-1/2-P20	62	31	76	G1/2	80	345	42	87	34	40
MS6-LDM1-1/2-P30						415				
MS6-LDM1-1/2-P40						475				

† Note: This product conforms to ISO 1179-1 and ISO 228-1.

Ordering data

Size	Flow cartridge	Connection	Part no.	Type
Flow direction from left to right				
MS4	P10	G1/4	543632	MS4-LDM1-1/4-P10
MS6	P20	G1/4	543640	MS6-LDM1-1/4-P20
		G1/2	543644	MS6-LDM1-1/2-P20
	P40	G1/2	543650	MS6-LDM1-1/2-P40
Flow direction from right to left				
MS4	P10	G1/4	543633	MS4-LDM1-1/4-P10-Z

Ordering data – Modular product system

Ordering table				Conditions	Code	Enter code
Grid dimension	[mm]	40	62			
Module no.		543628	543638			
Series		Standard			MS	MS
Size		4	6		...	
Function		Membrane air dryer			-LDM1	-LDM1
Pneumatic connection	Female thread G1/8		–	[1]	-1/8	
	Female thread G1/4		Female thread G1/4	[1]	-1/4	
	–		Female thread G3/8	[1]	-3/8	
	–		Female thread G1/2	[1]	-1/2	
	Connecting plate G1/8		–		-AGA	
	Connecting plate G1/4		Connecting plate G1/4		-AGB	
	Connecting plate G3/8		Connecting plate G3/8		-AGC	
	–		Connecting plate G1/2		-AGD	
	–		Connecting plate G3/4		-AGE	
	Connecting plate 1/8 NPT		–	[1]	-AQK	
	Connecting plate 1/4 NPT		Connecting plate 1/4 NPT	[1]	-AQN	
	Connecting plate 3/8 NPT		Connecting plate 3/8 NPT	[1]	-AQP	
	–		Connecting plate 1/2 NPT	[1]	-AQR	
	–		Connecting plate 3/4 NPT	[1]	-AQS	
Flow cartridge	50 l/min		–		-P05	
	100 l/min		–		-P10	
	–		200 l/min		-P20	
	–		300 l/min		-P30	
	–		400 l/min		-P40	
Purge air	Unducted					
	Ducted purge air			[1]	-PAC	
Type of mounting	Without mounting bracket					
	Mounting bracket standard design			[2]	-WP	
	Mounting bracket for attaching service unit components			[1] [2]	-WPM	
	Mounting bracket centrally at rear (wall mounting top and bottom), connecting plates not required				-WB	
	Mounting bracket centrally at rear (wall mounting top), connecting plates not required		–		-WBM	
EU certification	None					
	II 2GD to EU Explosion Protection Directive (ATEX)				-EX4	
UL certification	None					
	cULus, ordinary location for Canada and USA				-UL1	
Flow direction	Flow direction from left to right					
	Flow direction from right to left				-Z	

[1] 1/8, 1/4, 3/8, 1/2, AQK, AQN, AQP, AQR, AQS, PAC, WPM Not with EU EX4 certification.

[2] WP, WPM Only with connecting plate AGA, AGB, AGC, AGD, AGE, AQK, AQN, AQP, AQR or AQS.

Festo - Your Partner in Automation



1 Festo Inc.
5300 Explorer Drive
Mississauga, ON L4W 5G4
Canada

Festo Customer Interaction Center
Tel: 1 877 463 3786
Fax: 1 877 393 3786
Email: customer.service.ca@festo.com

2 Festo Pneumatic
Av. Ceylán 3,
Col. Tequesquináhuac
54020 Tlalnepantla,
Estado de México

Multinational Contact Center
01 800 337 8669
ventas.mexico@festo.com

3 Festo Corporation
1377 Motor Parkway
Suite 310
Islandia, NY 11749

Festo Customer Interaction Center
1 800 993 3786
1 800 963 3786
customer.service.us@festo.com

4 Regional Service Center
7777 Columbia Road
Mason, OH 45040

Connect with us



www.festo.com/socialmedia



www.festo.com

Subject to change