

Parallel grippers HGPT-B, heavy-duty

FESTO



Key features

Advantages compared with the parallel gripper HGPT

- Space-optimised:
Choice of shorter housing without gripping force retention or longer housing with gripping force retention
- Increased gripping force/
high-force variant:
Gripping force increased by 30% by means of oval piston.
High-force variant also available:
half the stroke, twice the force
- Reduced weight:
Systematic use of lighter and higher performance materials
- 4 sensor slots:
Proximity sensors no longer project past the bottom of the housing. Up to 4 positions can be sensed using the proximity sensors

At a glance

General information

Sturdy and precise kinematics for maximum torque resistance and long service life.

The force generated by the linear motion is translated into the gripper jaw movement via a wedge mechanism with force-guided motion sequence. This also guarantees synchronous movement of the gripper jaws.

The virtually backlash-free plain-bearing guide is realised using ground-in gripper jaws.

Flexible range of applications

- Can be used as a double-acting and single-acting gripper
- Compression spring for supplementing or retaining the gripping forces
- Suitable for external and internal gripping
- Centring either via centring pins or centring sleeves

The technology in detail

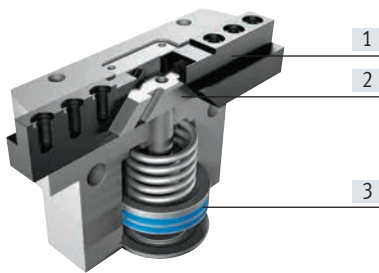

- [1] Gripper jaw
- [2] Wedge with forced guidance
- [3] Piston with magnet

Other connections

For sealing air

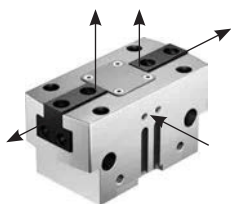

Compressed air flows past the gripper jaws when sealing air (max. 0.5 bar) is connected.

This prevents, for example, dust particles from entering the gripper jaw guide.

For lubrication nipples



The connections can also be used to re-lubricate the guide.

Position sensing/force control

With position transmitter SMAT-8M, SDAT



Analogue position feedback possible

- Analogue output
 - 0 ... 10 V
 - 4 ... 20 mA

With proportional-pressure regulator VPPM



Infinite adjustment of the gripping force possible

- Setpoint input
 - 0 ... 10 V
 - 4 ... 20 mA

With proximity sensor SMT-8G/-10G



Multiple positions can be sensed:

- Open
- Closed
- Workpiece gripped

Key features

Wide range of compressed air supply ports

Directly
from the front

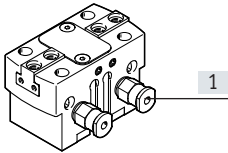

Via adapter plate
from underneath

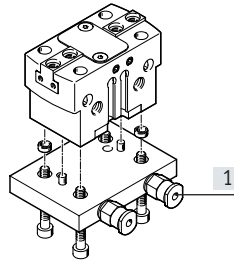

[1] Compressed air supply ports

Mounting options

Direct mounting
from above

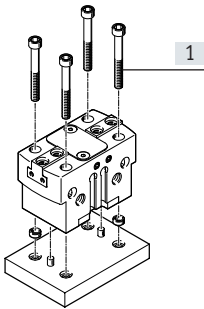

From underneath or from the side

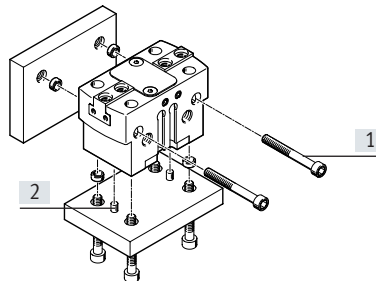

[1] Mounting screws

[2] Centring pins, centring sleeves

Note

These grippers are not suitable or are of limited suitability for the following application examples

Not suitable for:

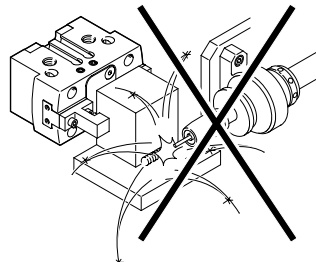

- Welding spatter

Of limited suitability for:

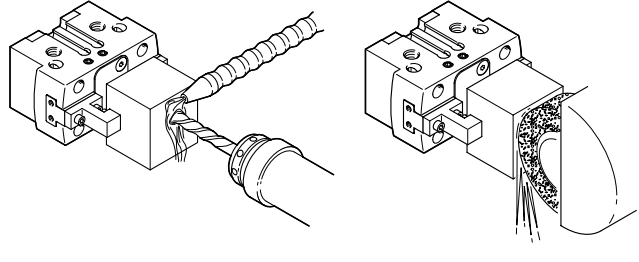

- Machining possible with sealing air
- Aggressive media only possible after consultation with Festo

Peripherals overview

Peripherals overview

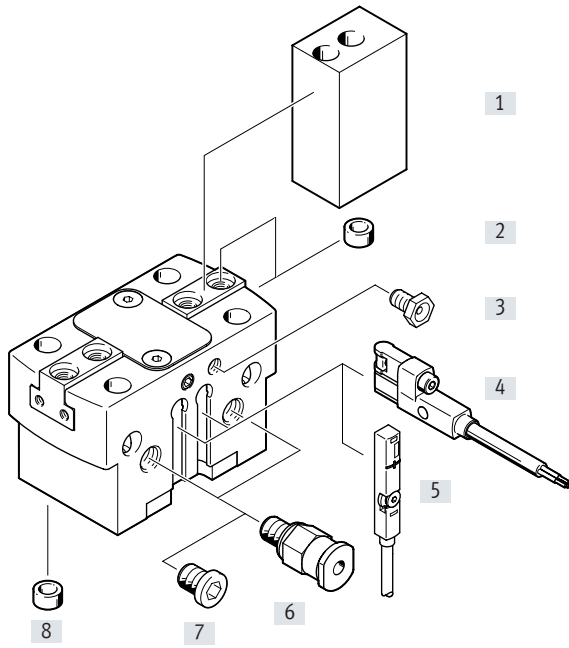

System product for handling and assembly technology

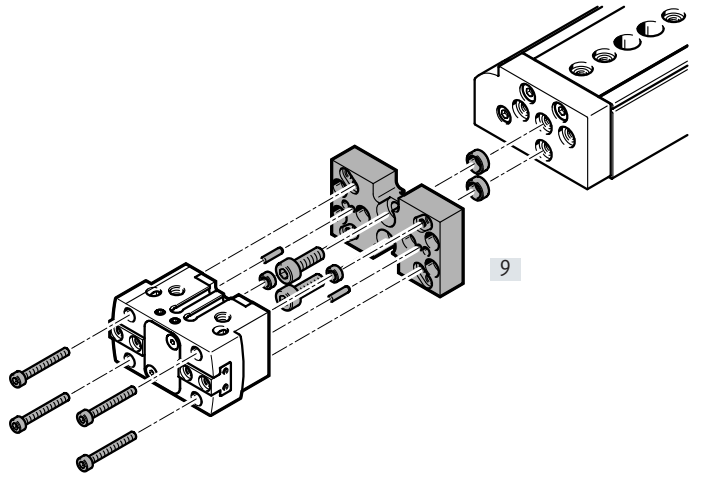

Peripherals overview

Accessories				
	Type	Size	Description	→ Page/Internet
[1]	Gripper jaw blank BUB-HGPT	16 ... 80	Blanks specially matched to the gripper jaws for custom production of gripper fingers	23
[2]	Centring sleeve ZBH	16 ... 80	<ul style="list-style-type: none"> For centring the gripper jaw blanks/gripper fingers on the gripper jaws Centring sleeves are included in the scope of delivery of the gripper 	24
[3]	Lubrication nipple	16 ... 80	Included in the scope of delivery of the gripper	–
[4]	Proximity sensor SMT-8G/-10G	16 ... 80	<ul style="list-style-type: none"> For sensing the piston position Proximity sensor ends flush with the bottom of the housing 	25
[5]	Position transmitter SMAT-8M	40 ... 80	Continuously senses the position of the piston. It has an analogue output with an output signal relative to the piston position.	25
	Position transmitter SDAT	63, 80		
[6]	Push-in fitting QS	16 ... 80	For connecting compressed air tubing with standard O.D.	qs
[7]	Blanking plug B	16 ... 80	For sealing the compressed air supply ports when using the lower compressed air supply ports	24
[8]	Centring sleeve ZBH	16 ... 80	For centring the gripper during mounting	24
[9]	Adapter kit DHAA, HAPG	16 ... 80	Drive/gripper connections	19

Type codes

001	Series	
HGPT	Parallel gripper, sturdy	

002	Size	
16	16	
20	20	
25	25	
35	35	
40	40	
50	50	
63	63	
80	80	

003	Position sensing	
A	For proximity sensor	

004	Generation	
B	Series B	



005	Gripping force	
	Standard	
F	High	

006	Gripping force backup	
	None	
G1	Opening	
G2	N/O contact	

Data sheet

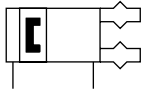
Function
Double-acting
HGPT...



-  Size
16 ... 80 mm
-  Total stroke
6 ... 50 mm

 www.festo.com

Function – Variant
Single-acting or with gripping force retention

Opening: HGPT...-G1



Closing: HGPT...-G2

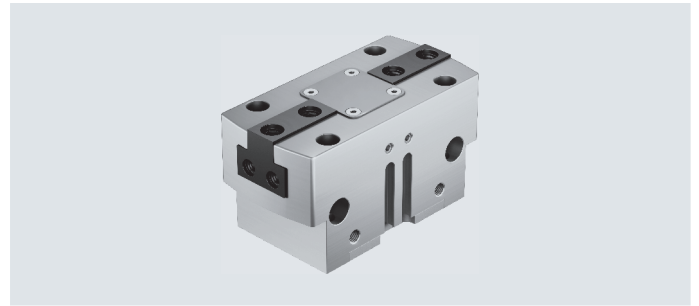

General technical data										
Size	16	20	25	35	40	50	63	80		
Design	Wedge mechanism Force-guided motion sequence									
Mode of operation	Double-acting									
Gripper function	Parallel									
Number of gripper jaws	2									
Max. load per gripper finger ¹⁾	[g]	40	50	110	180	310	640	1260	1830	
Stroke per gripper jaw										
HGPT...-A-B	[mm]	3	4	6	8	10	12	16	25	
HGPT...-A-B-F	[mm]	1.5	2	3	4	5	6	8	12.5	
Pneumatic connection		M5	M5	M5	M5	M5	G1/8	G1/8	G1/4	
Pneumatic connection, sealing air		M3	M3	M5	M5	M5	M5	M5	M5	
Repetition accuracy ²⁾	[mm]	±0.01	±0.02		±0.025					
Max. interchangeability	[mm]	0.2								
Max. operating frequency	[Hz]	3				2				
Rotational symmetry	[mm]	$\lt; \varnothing 0.2$								
Position sensing		Via proximity sensor, position transmitter								
Type of mounting		Via through-hole and dowel pin/centring sleeve Via female thread and dowel pin/centring sleeve								
Mounting position		Optional								

1) Applies to unthrottled operation

2) End-position drift under constant operating conditions with 100 consecutive strokes in the direction of movement of the gripper jaws

Operating and environmental conditions

Min. operating pressure		
HGPT...-A-B	[bar]	3
HGPT...-A-B-G	[bar]	4
Max. operating pressure	[bar]	8
Operating pressure for sealing air	[bar]	0 ... 0.5
Operating medium		Compressed air to ISO 8573-1:2010 [7:4:4]
Note on the operating/pilot medium		Lubricated operation possible (in which case lubricated operation will always be required)
Ambient temperature ¹⁾	[°C]	+5 ... +60
Degree of protection		IP40
Corrosion resistance class CRC ²⁾		2

1) Note operating range of proximity sensors

2) Corrosion resistance class CRC 2 to Festo standard FN 940070

Moderate corrosion stress. Indoor applications in which condensation can occur. External visible parts with primarily decorative surface requirements which are in direct contact with a normal industrial environment.

Data sheet

Weight [g]								
Size	16	20	25	35	40	50	63	80
HGPT...-A-B	85	135	266	490	821	1400	2712	4745
HGPT...-A-B-F	85	135	266	490	821	1400	2712	4745
HGPT...-A-B-G	100	155	353	567	1075	1832	3562	6287

Materials

Sectional view

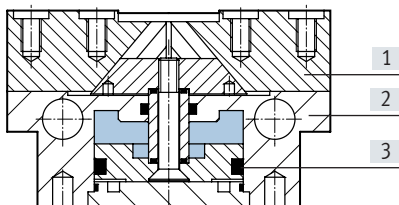

Parallel gripper		
[1]	Gripper jaws	Hardened steel
[2]	Housing	Hard anodised wrought aluminium alloy
[3]	Piston	Hard anodised aluminium
-	Seals	NBR
-	Note on materials	Free of copper and PTFE
		RoHS-compliant

Gripping force [N] at 6 bar

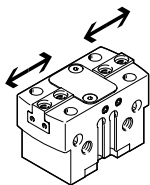

 **Note**
Engineering software
for gripper selection
→ www.festo.com

Size		16	20	25	35	40	50	63	80
Gripping force per gripper jaw									
HGPT...-A-B	Opening	60	82	133	245	355	570	896	1613
	Closing	53	77	124	229	331	535	851	1551
HGPT...-A-B-F	Opening	108	172	238	500	723	1185	1885	3275
	Closing	96	161	221	467	674	1113	1791	3150
Total gripping force									
HGPT...-A-B	Opening	120	162	266	490	710	1140	1792	3226
	Closing	106	154	248	458	662	1070	1702	3102
HGPT...-A-B-F	Opening	216	344	476	1000	1446	2370	3770	6550
	Closing	192	322	442	934	1328	2226	3522	6300

Data sheet

Characteristic load values at the gripper jaws

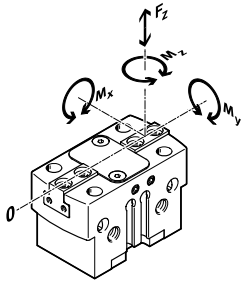

The indicated permissible forces and torques apply to a single gripper jaw. They include the lever arm, additional weight forces created by the workpiece or external gripper fingers and acceleration forces occurring during movement. The zero coordinate line (gripper jaw guide) must be taken into consideration when calculating torques.

Size		16	20	25	35	40	50	63	80
Max. permissible force F_z	[N]	200	700	1200	1800	2500	3200	5000	7000
Max. permissible torque M_x	[Nm]	10	15	50	80	100	120	160	180
Max. permissible torque M_y	[Nm]	12	15	45	60	90	120	180	220
Max. permissible torque M_z	[Nm]	6	8	35	50	75	100	140	170

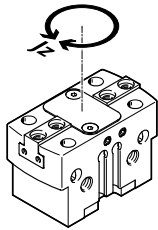
 Mass moments of inertia [$\text{kgm}^2 \times 10^{-4}$]

Mass moment of inertia of the parallel gripper in relation to the central axis, without external gripper fingers, without load.

Size		16	20	25	35	40	50	63	80
HGPT...-A-B		0.141	0.344	0.983	2.807	7.277	19.488	60.903	150.515
HGPT...-A-B-G		0.163	0.445	1.479	3.974	10.990	29.423	93.034	238.336

Gripper jaw backlash

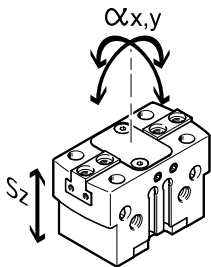

The plain-bearing guide used in the grippers means that there is backlash between the gripper jaws and the housing. The backlash values listed in the table have been calculated based on the traditional accumulative tolerance method.

Size		16	20	25	35	40	50	63	80
Max. gripper jaw backlash S_z	[mm]	0.02							
Max. gripper jaw angular backlash α_x, α_y	[°]	0.1							

Data sheet

Opening and closing times [ms] at 6 bar

Without external gripper fingers

With external gripper fingers

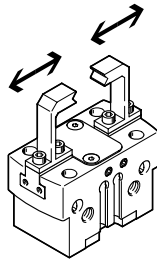
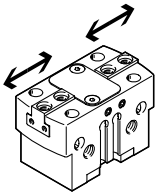

The indicated opening and closing times [ms] were measured at room temperature at an operating pressure of 6 bar with a horizontally mounted gripper without additional gripper fingers. The grippers must be throttled for larger loads [g]. Opening and closing times must then be adjusted accordingly.

Size			16	20	25	35	40	50	63	80
Without external gripper fingers										
Standard	HGPT...-A-B	Opening	9	22	26	36	56	80	150	214
		Closing	11	30	32	67	60	85	156	213
	HGPT...-A-B-G1	Opening	13	13	24	37	67	70	146	182
		Closing	31	25	48	114	135	153	328	353
	HGPT...-A-B-G2	Opening	22	35	40	69	122	151	294	379
		Closing	15	18	28	87	71	77	185	176
High force	HGPT...-A-B-F	Opening	8	28	25	33	60	83	143	212
		Closing	10	31	32	70	64	82	152	211
	HGPT...-A-B-F-G1	Opening	19	13	24	35	71	70	145	180
		Closing	30	25	45	115	143	143	315	340
	HGPT...-A-B-F-G2	Opening	33	38	36	63	120	137	308	362
		Closing	17	14	28	72	72	80	154	178
With external gripper fingers (as a function of the load per gripper finger)										
HGPT...	50 g		10	-	-	-	-	-	-	-
	100 g		15	30	-	-	-	-	-	-
	200 g		21	42	35	-	-	-	-	-
	300 g		-	52	42	42	-	-	-	-
	400 g		-	-	49	49	63	-	-	-
	500 g		-	-	-	55	71	-	-	-
	600 g		-	-	-	-	78	-	-	-
	800 g		-	-	-	-	90	90	-	-
	1000 g		-	-	-	-	-	95	-	-
	1200 g		-	-	-	-	-	100	-	-
	1500 g		-	-	-	-	-	-	164	-
	1800 g		-	-	-	-	-	-	179	-
	2000 g		-	-	-	-	-	-	189	223
	2200 g		-	-	-	-	-	-	-	234
	2400 g		-	-	-	-	-	-	-	244

Data sheet

Gripping force F_H per gripper jaw as a function of operating pressure and lever arm x

The gripping forces as a function of the operating pressure and lever arm can be determined from the following graphs.

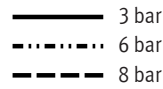
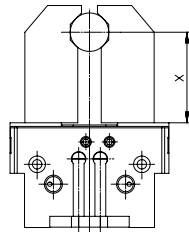

Note
 Engineering software
 for gripper selection
 → www.festo.com

External gripping (closing)

Standard

HGPT-16-A-B

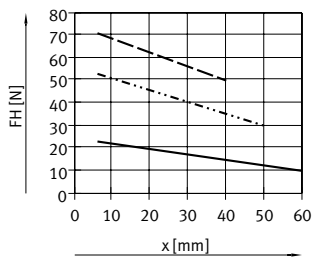

HGPT-20-A-B

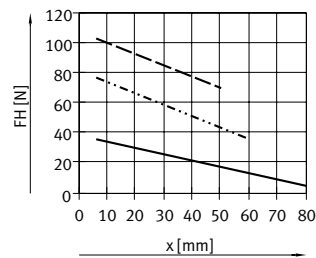

HGPT-25-A-B

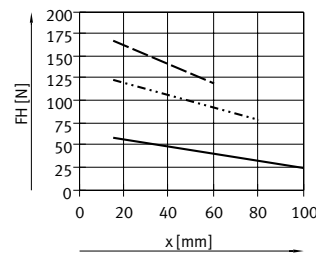

HGPT-35-A-B

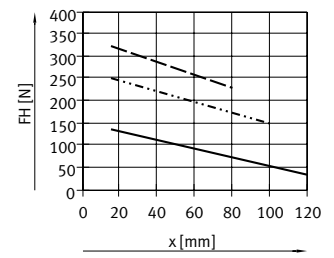

HGPT-40-A-B

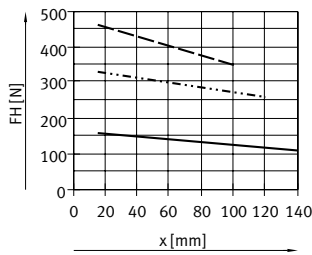

HGPT-50-A-B

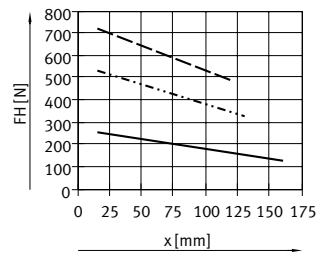

HGPT-63-A-B

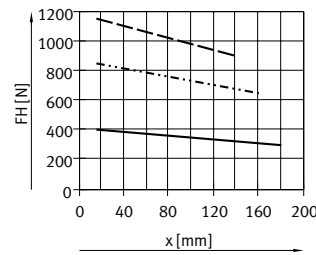

HGPT-80-A-B

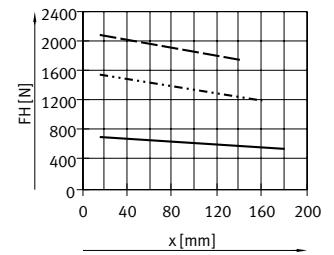

High force

HGPT-16-A-B-F

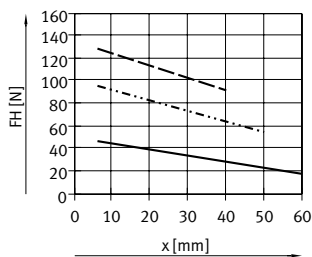

HGPT-20-A-B-F

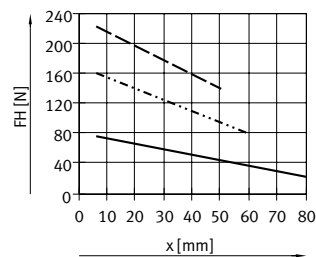

HGPT-25-A-B-F

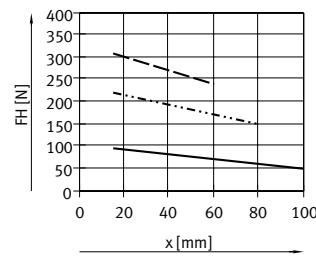

HGPT-35-A-B-F

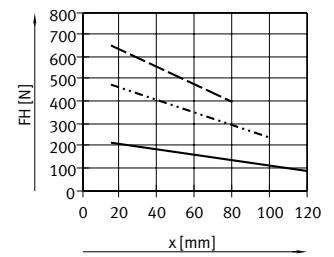

HGPT-40-A-B-F

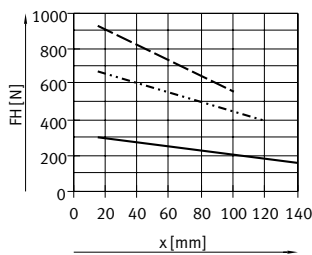

HGPT-50-A-B-F

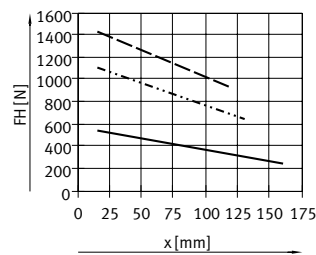

HGPT-63-A-B-F

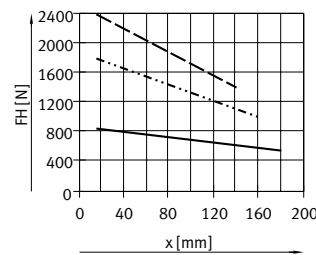

HGPT-80-A-B-F

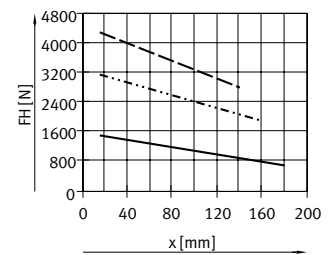

Data sheet

Gripping force F_H per gripper jaw as a function of operating pressure and lever arm x

The gripping forces as a function of the operating pressure and lever arm can be determined from the following graphs.

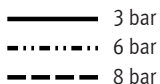
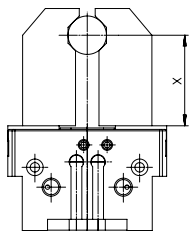

Note
 Engineering software for gripper selection
 → www.festo.com

External gripping (opening)

Standard

HGPT-16-A-B

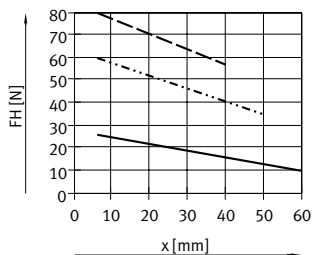

HGPT-20-A-B

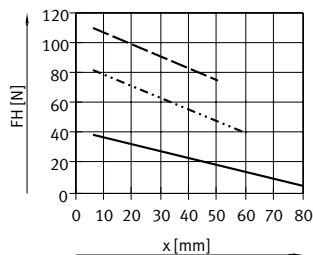

HGPT-25-A-B

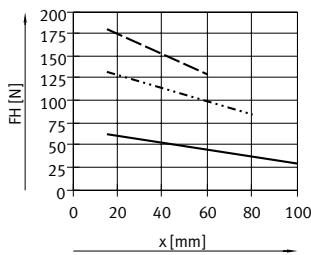

HGPT-35-A-B

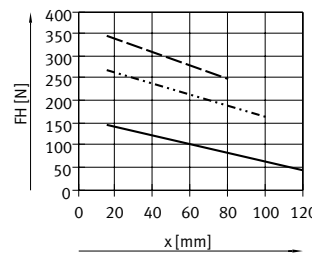

HGPT-40-A-B

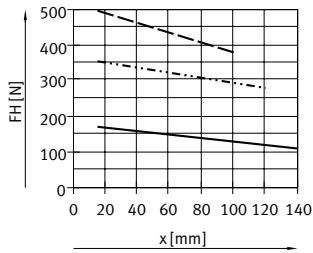

HGPT-50-A-B

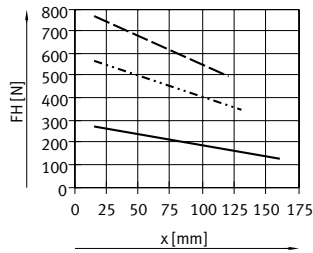

HGPT-63-A-B

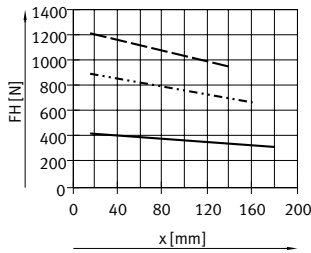

HGPT-80-A-B

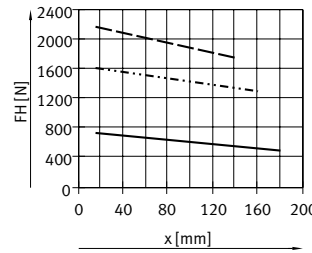

High force

HGPT-16-A-B-F

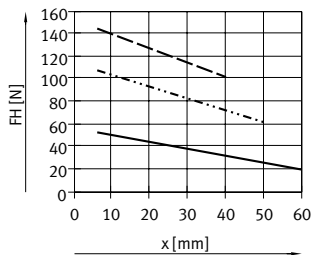

HGPT-20-A-B-F

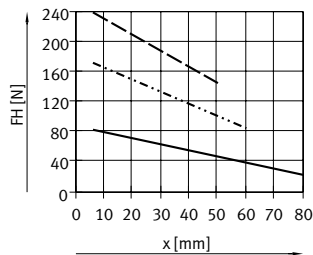

HGPT-25-A-B-F

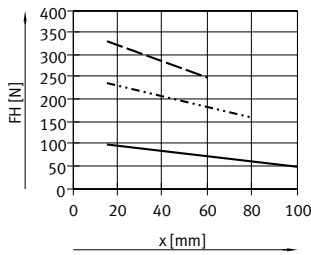

HGPT-35-A-B-F

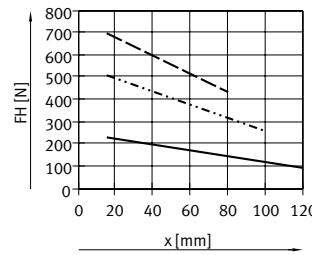

HGPT-40-A-B-F

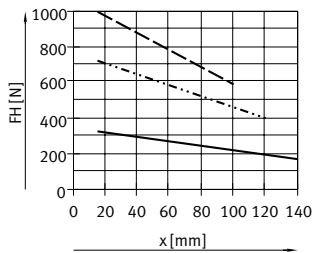

HGPT-50-A-B-F

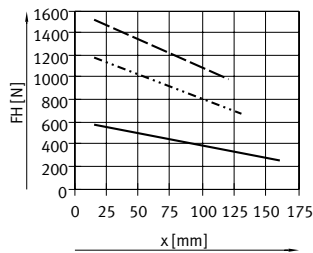

HGPT-63-A-B-F

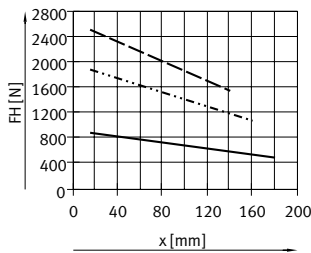

HGPT-80-A-B-F

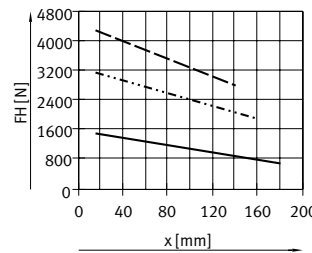

Data sheet

Gripping force F_H per gripper jaw at 6 bar as a function of lever arm x and eccentricity a and b

The following formula must be used to calculate the lever arm x with eccentric gripping:

$$x = \sqrt{a^2 + b^2}$$

The gripping force F_H can be read from the graphs (→ page 11) using the calculated value x .

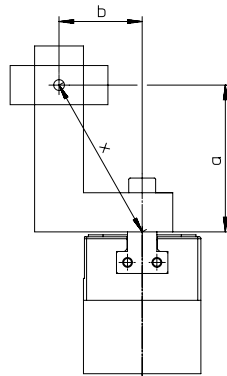

Calculation example

Assuming:

Distance $a = 45$ mm

Distance $b = 40$ mm

To be calculated:

The gripping force at 6 bar
with an HGPT-25,
used as an external gripper

Procedure: calculating the lever arm x

$$x = \sqrt{45^2 + 40^2}$$

$$x = 60$$
 mm

The graph (→ page 11) gives a
value of $F_H = 89$ N for the gripping
force.

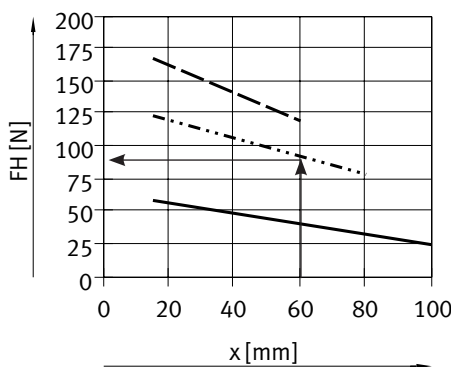

Data sheet

Spring force F_f as a function of size and gripper jaw stroke l

Gripping force retention for HGPT-...-G...

The spring forces F_f as a function of gripper jaw stroke l can be determined from the following graph.

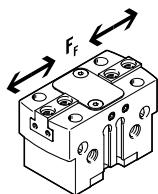

Standard

HGPT-...-A-B-G
Size 16 ... 35

High force

HGPT-...-A-B-F-G
Size 16 ... 35

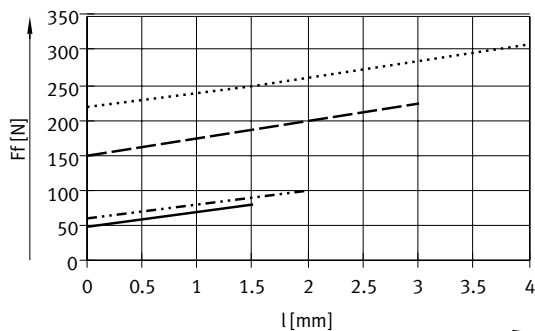
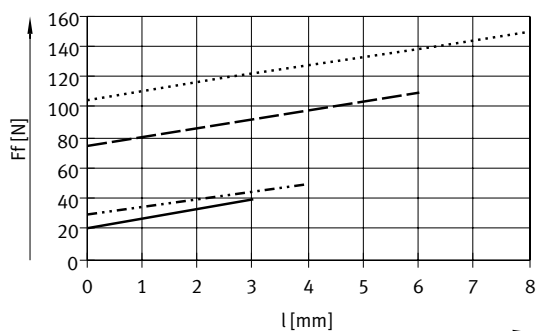

- HGPT-16-A-B-G
- - - HGPT-20-A-B-G
- - - HGPT-25-A-B-G
- HGPT-35-A-B-G

- HGPT-16-A-B-F-G
- - - HGPT-20-A-B-F-G
- - - HGPT-25-A-B-F-G
- HGPT-35-A-B-F-G

Size 40 ... 80

Size 40 ... 80

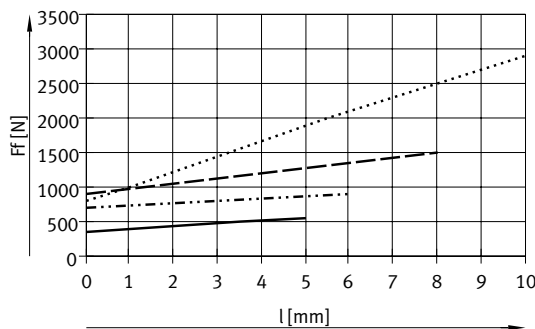
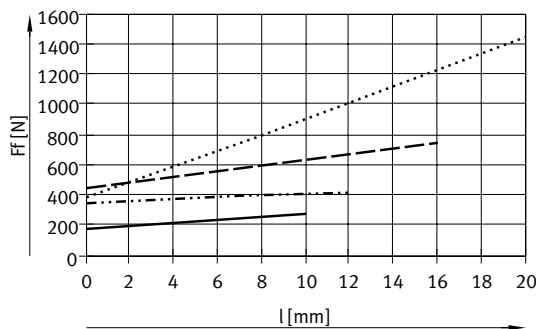

- HGPT-40-A-B-G
- - - HGPT-50-A-B-G
- - - HGPT-63-A-B-G
- HGPT-80-A-B-G

- HGPT-40-A-B-F-G
- - - HGPT-50-A-B-F-G
- - - HGPT-63-A-B-F-G
- HGPT-80-A-B-F-G

Data sheet

Spring force F_F as a function of size, gripper jaw stroke l and lever arm x per gripper finger

The lever arm x must be taken into consideration when determining the actual spring force F_{Total} .

The formulae for calculating the spring force are provided in the table below.

Standard – HGPT...-A-B-G

Gripping force retention	Size	$F_{\text{Total}} =$	Gripping force retention	Size	$F_{\text{Total}} =$
G1	16	$-0.1 * x + 0.7 * F_F$	G2	16	$-0.2 * x + 0.7 * F_F$
	20	$-0.05 * x + 0.9 * F_F$		20	$-0.65 * x + 0.9 * F_F$
	25	$-0.7 * x + 0.7 * F_F$		25	$-0.55 * x + 0.7 * F_F$
	35	$-0.65 * x + 0.7 * F_F$		35	$-0.05 * x + 0.7 * F_F$
	40	$-1.05 * x + 0.8 * F_F$		40	$-1.05 * x + 0.8 * F_F$
	50	$-0.75 * x + 0.8 * F_F$		50	$-1.4 * x + 0.8 * F_F$
	63	$-2 * x + 0.8 * F_F$		63	$-1.2 * x + 0.8 * F_F$
80	$-1.4 * x + 0.6 * F_F$	80	$-0.6 * x + 0.6 * F_F$		

High force – HGPT...-A-B-F-G

Gripping force retention	Size	$F_{\text{Total}} =$	Gripping force retention	Size	$F_{\text{Total}} =$
G1	16	$-0.6 * x + 0.6 * F_F$	G2	16	$-0.4 * x + 0.6 * F_F$
	20	$-0.7 * x + 0.75 * F_F$		20	$-0.95 * x + 0.75 * F_F$
	25	$-0.85 * x + 0.9 * F_F$		25	$-0.5 * x + 0.9 * F_F$
	35	$-0.4 * x + 0.55 * F_F$		35	$-0.4 * x + 0.55 * F_F$
	40	$-1.9 * x + 0.75 * F_F$		40	$-2.3 * x + 0.75 * F_F$
	50	$-2.5 * x + 0.7 * F_F$		50	$-1 * x + 0.7 * F_F$
	63	$-5.5 * x + 0.7 * F_F$		63	$-1 * x + 0.7 * F_F$
80	$-5.65 * x + 0.8 * F_F$	80	$-0.5 * x + 0.8 * F_F$		

Determination of the actual gripping forces F_{Gr} for HGPT...-G1 and HGPT...-G2 as a function of the application

The parallel grippers with integrated spring type HGPT...-G1 (opening gripping force retention) and HGPT...-G2 (closing gripping force retention) can be used as:

- single-acting grippers
 - grippers with supplementary gripping force and
 - grippers with gripping force retention
- depending on requirements.

In order to calculate the available gripping forces F_{Gr} (per gripper jaw), the gripping force F_{H} and spring force F_{Total} must be combined accordingly.

Application

Single-acting	Supplementary gripping force	Gripping force retention
<ul style="list-style-type: none"> • Gripping with spring force: $F_{\text{Gr}} = F_{\text{Total}}$ • Gripping with pressure force: $F_{\text{Gr}} = F_{\text{H}} - F_{\text{Total}}$ 	<ul style="list-style-type: none"> • Gripping with pressure and spring force: $F_{\text{Gr}} = F_{\text{H}} + F_{\text{Total}}$ 	<ul style="list-style-type: none"> • Gripping with spring force: $F_{\text{Gr}} = F_{\text{Total}}$

Data sheet

Dimensions

Download CAD data → www.festo.com

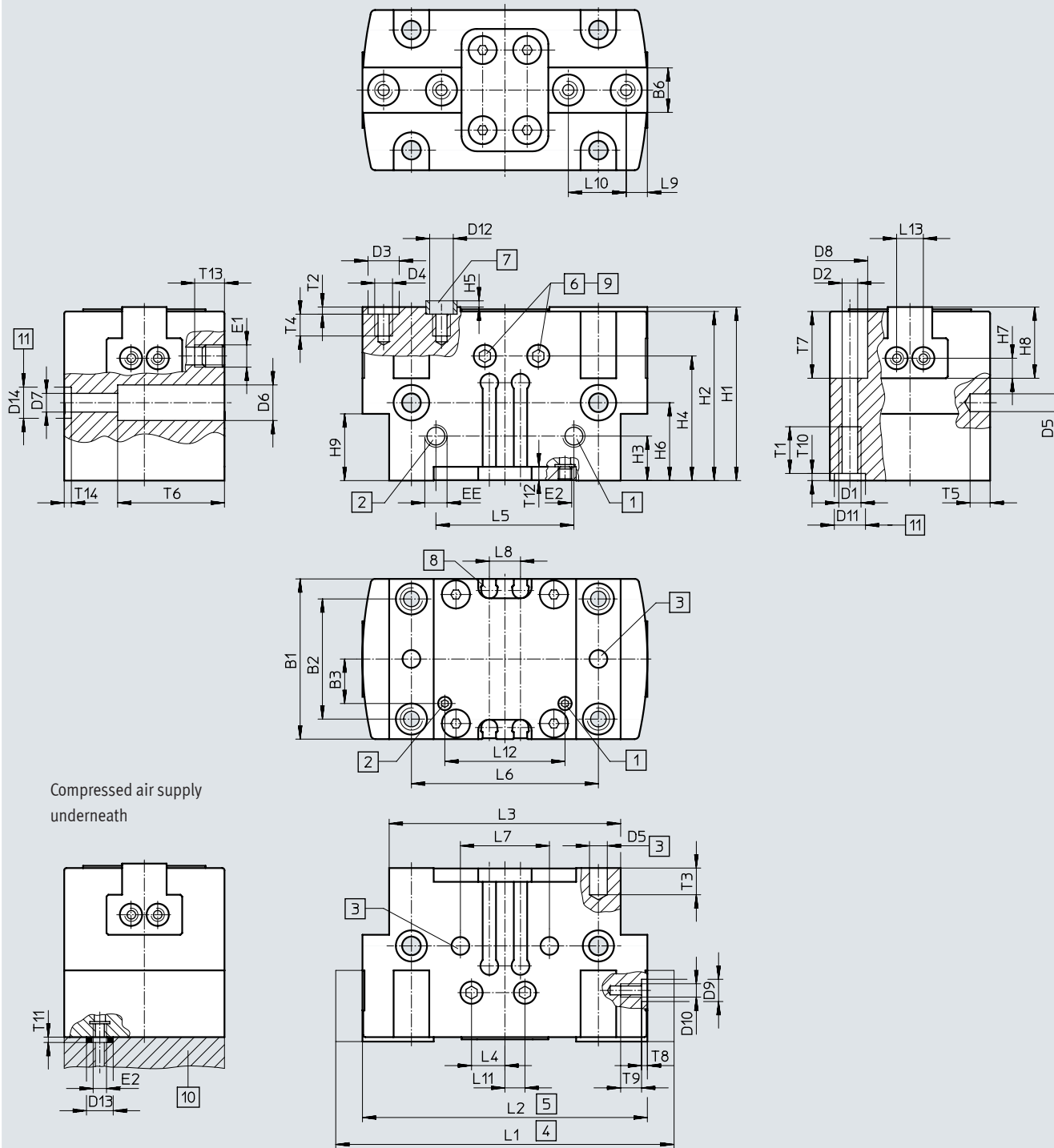

Compressed air supply underneath

- [1] Compressed air supply port, opening, either on the side or underneath (bottom port sealed on delivery)
- [2] Compressed air supply port, closing, either on the side or underneath (bottom port sealed on delivery)
- [3] Drilled hole for dowel pin (not included in the scope of delivery)
- [4] Gripper jaws open
- [5] Gripper jaws closed
- [6] Sealing air connection (sealed on delivery)
- [7] Centring sleeves ZBH (4 included in the scope of delivery)
- [8] Slot for proximity sensor
- [9] Lubrication nipple (sealed on delivery)
- [10] O-ring for parallel gripper
HGPT-16 ... 40: \varnothing 3x1.5
HGPT-50 ... 80: \varnothing 5x1.5
- [11] Drilled hole for centring sleeve ZBH

Data sheet

Size	B1	B2 ¹⁾	B3	B6 -0.05 -0.1	D1	D2 ∅	D3 ∅ H8/h7	D4	D5 ∅ H8	D6 ∅ ±0.1	D7 ∅	D8 ∅ +0.3	D9 ∅ H8	D10	D11 ∅ H8	D12 ∅
[mm]	±0.05		±0.1													
16	24	17	4	6	M3	2.6	5	M3	2	4.6	2.6	4.6	-	M2	5	3.2
20 ²⁾	28	22	8.7	6.5	M4	3.3	5	M3	3	6	3.2	6	5	M3	5	3.2
25	36	27	11	10	M5	4.2	7	M4	4	8	4.2	8	5	M3	7	5.3
35	42	32	13	12	M5	4.2	9	M5	4	9.2	5.3	8	7	M5	7	6.4
40	50	38	17	14	M6	5.1	9	M6	5	11	6.4	9	7	M5	9	6.4
50	60	45	20	15.5	M8	6.8	9	M6	6	13.5	8.4	11	7	M5	12	6.4
63	72	56	24.5	20	M8	6.8	12	M10	6	13.5	8.4	11	7	M5	12	10.3
80	100	70	39.5	22	M10	8.5	15	M12	8	16.5	10.2	13.5	9	M6	12	12.4

Size	D13 ∅	D14 ∅ H8/h7	EE	E1	E2	H1		H2		H3		H4		H5	H6 ¹⁾	
						±0.05	-G ±0.05	±0.05	-G ±0.05	±0.1	-G ±0.1		-G		-0.3	
[mm]																
16	6	-	M5	M3	M3	29	37	28	36	12	12	23.7	31.7	1.2	17.5	25.5
20	6	-	M5	M3	M3	31	38	30	37	10	15	23	30	1.2	14.5	21.5
25	6	7	M5	M5	M3	39	57	38	56	10	20	28	46	1.4	17.5	35.5
35	6	7	M5	M5	M3	49	67	48	66	12	30	36	54	1.9	20	38
40	6	9	M5	M5	M3	55	81	54	80	15	36	41	67	1.9	25	51
50	8	12	G1/8	M5	M5	63	93	62	92	15	30	47	77	1.9	30	60
63	8	12	G1/8	M5	M5	77	117	76	116	18	26	56	96	2.4	28	68
80	8	12	G1/4	M5	M5	91	133	90	132	22	33	65	107	2.9	34	76

Size	H7 ¹⁾	H8 -0.02	H9		L1		L2	L3	L4	L5	L6 ¹⁾	L7 ¹⁾	L8	L9 ¹⁾	L10 ¹⁾	L11
			±0.1	-G ±0.1	±0.5	-F ±0.5										
[mm]																
16	2.25	8.5	15	23	50	47	44	36	5.5	20	29	20	6	3	8	1
20	3	12	15	22	64	60	56	44	2.5	24	35	24	6	3.25	12	2.5
25	4.5	16	15	33	76	70	64	52	3.5	31	42	20	7	4.75	13	3.5
35	5.5	19	20	38	96	88	80	64	5.5	40	52	40	7	5.5	16	5.5
40	5.5	22	24	50	120	110	100	80	5.5	49	66	50	10	6.5	20	5.5
50	7.5	25.5	26	56	149	137	125	100	5.5	63	82	60	10	8	24	5.5
63	9	32	32	72	192	176	160	125	5.5	74	100	76	10	9.5	32	5.5
80	11	39	34	77	230	205	180	154	5.5	82	130	100	10	12	40	5.5

Size	L12	L13 ¹⁾	T1	T2	T3	T4	T5	T6	T7		T8	T9	T10	T11	T12	T13	T14
									+0.2	-G +0.2							
[mm]	±0.1		min.	+0.1	min.	min.	min.								min.	min.	+0.1
16	22	6	5.5	1.3	4	5	4	15	14	22	-	3	1.3	1.2	3	5.5	-
20	22.6	6	6.5	1.3	5	5.5	4	19	11	11	1.3	6	1.3	1.2	3	5.5	-
25	29	6	8.5	1.6	6	6.5	4.5	24	15	15	1.3	6	1.6	1.2	3	6.7	1.6
35	39	13	8.5	2.1	6	8.5	4.5	16	19	19	1.6	9	1.6	1.2	3	6.5	1.6
40	47.4	13	10.5	2.1	6	10.5	6	33	20	20	1.6	9	2.1	1.2	4	6.5	2.1
50	61	13	12.5	2.1	8	10.5	6	43	23	23	1.6	9	2.6	1.2	4	6.5	2.6
63	75	13	12.5	2.6	8	15.5	7	55	35	35	1.6	9	2.6	1.2	5	6.5	2.6
80	82	20	15	3.1	10	20	10	70	44	44	2.1	10	2.6	1.2	5.5	5	2.6

1) Tolerance for centring hole ±0.02 mm

Tolerance for thread ±0.1 mm

2) Dowel pins [3] must be used when mounted from below.

Data sheet

Ordering data						
Size [mm]	Double-acting without compression spring		Single-acting or with gripping force retention		Closing	
	Part no.	Type	Part no.	Type	Part no.	Type
Standard						
16	560192	HGPT-16-A-B	560193	HGPT-16-A-B-G1	560194	HGPT-16-A-B-G2
20	560198	HGPT-20-A-B	560199	HGPT-20-A-B-G1	560200	HGPT-20-A-B-G2
25	560204	HGPT-25-A-B	560205	HGPT-25-A-B-G1	560206	HGPT-25-A-B-G2
35	560210	HGPT-35-A-B	560211	HGPT-35-A-B-G1	560212	HGPT-35-A-B-G2
40	560216	HGPT-40-A-B	560217	HGPT-40-A-B-G1	560218	HGPT-40-A-B-G2
50	560222	HGPT-50-A-B	560223	HGPT-50-A-B-G1	560224	HGPT-50-A-B-G2
63	560228	HGPT-63-A-B	560229	HGPT-63-A-B-G1	560230	HGPT-63-A-B-G2
80	560234	HGPT-80-A-B	560235	HGPT-80-A-B-G1	560236	HGPT-80-A-B-G2
High force						
16	560195	HGPT-16-A-B-F	560196	HGPT-16-A-B-F-G1	560197	HGPT-16-A-B-F-G2
20	560201	HGPT-20-A-B-F	560202	HGPT-20-A-B-F-G1	560203	HGPT-20-A-B-F-G2
25	560207	HGPT-25-A-B-F	560208	HGPT-25-A-B-F-G1	560209	HGPT-25-A-B-F-G2
35	560213	HGPT-35-A-B-F	560214	HGPT-35-A-B-F-G1	560215	HGPT-35-A-B-F-G2
40	560219	HGPT-40-A-B-F	560220	HGPT-40-A-B-F-G1	560221	HGPT-40-A-B-F-G2
50	560225	HGPT-50-A-B-F	560226	HGPT-50-A-B-F-G1	560227	HGPT-50-A-B-F-G2
63	560231	HGPT-63-A-B-F	560232	HGPT-63-A-B-F-G1	560233	HGPT-63-A-B-F-G2
80	560237	HGPT-80-A-B-F	560238	HGPT-80-A-B-F-G1	560239	HGPT-80-A-B-F-G2

Accessories

Adapter kit
DHAA, HAPG



Material:
Wrought aluminium alloy
Free of copper and PTFE
RoHS-compliant

 **Note**

The kit includes the individual mounting interface as well as the necessary mounting material.

Permissible drive/gripper combinations with adapter kit

Download CAD data → www.festo.com

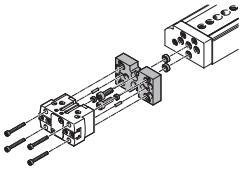
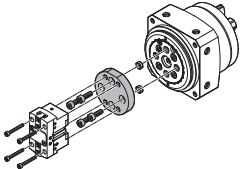
Combination	Drive Size	Gripper Size	Mounting option		Adapter kit		
					CRC ¹⁾	Part no.	Type
DGSL/HGPT-B	DGSL	HGPT-B			DHAA, HAPG		
	8, 10	16, 20	■	■	2	564957	DHAA-G-G6-8-B8-16
	12, 16	16, 20	■	■		564954	DHAA-G-G6-16-B8-16
	12, 16	25	■	■		564952	DHAA-G-G6-16-B8-25
	20, 25	25, 35	■	■		537175	HAPG-79
	20, 25	40	■	■		564951	DHAA-G-G6-20-B8-40
DSM-....-HD/HGPT-B	DSM-....-HD	HGPT-B			DHAA		
	12	16	■	■	2	8079169	DHAA-G-R3-12-B8-16
	12	20	■	■		8079170	DHAA-G-R3-12-B8-20
	16	16	■	■		8079193	DHAA-G-R3-16-B8-16
	16	20	■	■		8079195	DHAA-G-R3-16-B8-20
	25	16	■	■		8079202	DHAA-G-R3-25-B8-16
	25	20	■	■		8079205	DHAA-G-R3-25-B8-20
	25	25	■	■		8079207	DHAA-G-R3-25-B8-25
	32	20	■	■		8079217	DHAA-G-R3-32-B8-20
	32	25	■	■		8079218	DHAA-G-R3-32-B8-25
	32	35	■	■		8079221	DHAA-G-R3-32-B8-35

1) Corrosion resistance class CRC 2 to Festo standard FN 940070

Moderate corrosion stress. Indoor applications in which condensation can occur. External visible parts with primarily decorative surface requirements which are in direct contact with a normal industrial environment.

Accessories



Adapter kit
DHAA

Material:
Wrought aluminium alloy
Free of copper and PTFE
RoHS-compliant

 **Note**
The kit includes the individual mounting interface as well as the necessary mounting material.

Permissible drive/gripper combinations with adapter kit

Download CAD data → www.festo.com

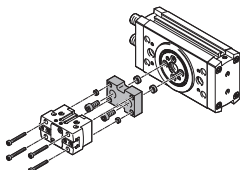
Combination	Drive Size	Gripper Size	Mounting option		Adapter kit			
					CRC ¹⁾	Part no.	Type	
	DRRD/HGPT-B				DHAA			
	12	16	■	■	2	2449927	DHAA-G-Q11-12-B8/B8G-16	
	12	20	■	■		2449921	DHAA-G-Q11-12-B8-20	
	16	16	■	■		2091740	DHAA-G-Q11-16-B8/B8G-16	
	16	20	■	■		2091577	DHAA-G-Q11-16-B8-20	
	16	25	■	■		2090543	DHAA-G-Q11-16-B8-25	
	20	25	■	■		2088114	DHAA-G-Q11-20-B8-25	
	20	35	■	■		2087524	DHAA-G-Q11-20-B8-35	
	25	35	■	■		1731604	DHAA-G-Q11-25-B8-35	
	25	40	■	■		1731735	DHAA-G-Q11-25-B8-40	
	32	40	■	■		2092070	DHAA-G-Q11-32-B8-40	
	35	40	■	■		2114241	DHAA-G-Q11-35-B8-40	
	32	50	■	■		2118750	DHAA-G-Q11-32-B8-50	
	35, 40	50	■	■		2124990	DHAA-G-Q11-3 5/40-B8-50	
	40	63	■	■		2125264	DHAA-G-Q11-40-B8-63	
	50	63	■	■		2424526	DHAA-G-Q11-50-B8-63	
	50	80	■	■		2424527	DHAA-G-Q11-50-B8-80	
		DRRD				DHAA		
			HGPT-B-G			2	2449927	DHAA-G-Q11-12-B8/B8G-16
		12	20	■	■		2800827	DHAA-G-Q11-12-B8G-20
		16	16	■	■		2091740	DHAA-G-Q11-16-B8/B8G-16
		16	20	■	■		2595935	DHAA-G-Q11-16-B8G-20
		16	25	■	■		2596187	DHAA-G-Q11-16-B8G-25
		20	25	■	■		2596248	DHAA-G-Q11-20-B8G-25
		20	35	■	■		2596517	DHAA-G-Q11-20-B8G-35
		25	35	■	■		2597040	DHAA-G-Q11-25-B8G-35
		25	40	■	■		2597322	DHAA-G-Q11-25-B8G-40
		32	40	■	■		2597387	DHAA-G-Q11-32-B8G-40
		35	40	■	■		2597928	DHAA-G-Q11-35-B8G-40
		32	50	■	■		2597428	DHAA-G-Q11-32-B8G-50
		35, 40	50	■	■		2604977	DHAA-G-Q11-3 5/40-B8G-50
		40	63	■	■		2604813	DHAA-G-Q11-40-B8G-63
		50	63	■	■		2604845	DHAA-G-Q11-50-B8G-63
	50	80	■	■	2604887		DHAA-G-Q11-50-B8G-80	

1) Corrosion resistance class CRC 2 to Festo standard FN 940070

Moderate corrosion stress. Indoor applications in which condensation can occur. External visible parts with primarily decorative surface requirements which are in direct contact with a normal industrial environment.



Accessories

Adapter kit
DHAA, HAPG

 Material:
 Wrought aluminium alloy
 Free of copper and PTFE
 RoHS-compliant

 **Note**

The kit includes the individual mounting interface as well as the necessary mounting material.

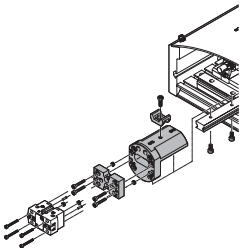
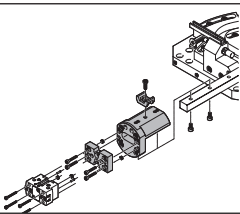
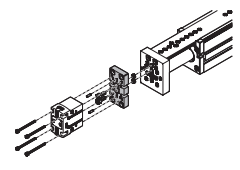
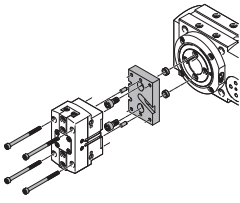
Permissible drive/gripper combinations with adapter kit							Download CAD data → www.festo.com	
Combination	Drive Size	Gripper Size	Mounting option		Adapter kit CRC ¹⁾	Part no.	Type	
								
	HSP	HGPT-B			DHAA, HAPG			
	12	16	■	–	2	564957	DHAA-G-G6-8-B8-16	
						540881	HAPG-70-B	
	16	16, 20	■	–		564957	DHAA-G-G6-8-B8-16	
						540882	HAPG-71-B	
	25	16, 20	■	–		564957	DHAA-G-G6-8-B8-16	
						540883	HAPG-72-B	
	HSW	HGPT-B			DHAA, HAPG			
	12	16	■	–	2	564957	DHAA-G-G6-8-B8-16	
						540882	HAPG-71-B	
	16	16, 20	■	–		564957	DHAA-G-G6-8-B8-16	
						540882	HAPG-71-B	
	EGSL	HGPT-B			DHAA, HAPG			
	45, 55	25	■	■	2	564952	DHAA-G-G6-16-B8-25	
						564951	DHAA-G-G6-20-B8-40	
	75	40	■	■		537175	HAPG-79	
	75	25, 35	■	■				
	ERMB	HGPT-B			DHAA, HAPG			
	20	25	■	■	2	537181	HAPG-SD2-25	
						537173	HAPG-SD2-23	
	20, 25	35	■	■		537184	HAPG-SD2-26	
						564956	DHAA-G-Q5-32-B8-50	
	25, 32	40	■	■				
	32	50	■	■				

1) Corrosion resistance class CRC 2 to Festo standard FN 940070

Moderate corrosion stress. Indoor applications in which condensation can occur. External visible parts with primarily decorative surface requirements which are in direct contact with a normal industrial environment.

Accessories



Adapter kit
DHAA, HAPG

Material:
Wrought aluminium alloy
Free of copper and PTFE
RoHS-compliant

 **Note**
The kit includes the individual mounting interface as well as the necessary mounting material.

Permissible drive/gripper combinations with adapter kit

Download CAD data → www.festo.com

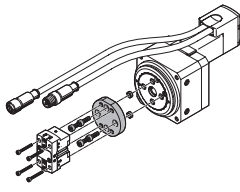
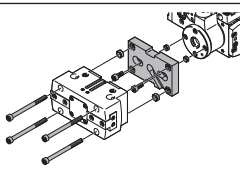
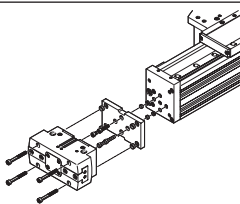
Combination	Drive Size	Gripper Size	Mounting option		Adapter kit		
					CRC ¹⁾	Part no.	Type
ERMO/HGPT-B	ERMO	HGPT-B			DHAA		
	12	16	■	■	2	8079169	DHAA-G-R3-12-B8-16
	12	20	■	■		8079170	DHAA-G-R3-12-B8-20
	16	16	■	■		8079193	DHAA-G-R3-16-B8-16
	16	20	■	■		8079195	DHAA-G-R3-16-B8-20
	25	16	■	■		8079202	DHAA-G-R3-25-B8-16
	25	20	■	■		8079205	DHAA-G-R3-25-B8-20
	25	25	■	■		8079207	DHAA-G-R3-25-B8-25
	32	20	■	■		8079217	DHAA-G-R3-32-B8-20
	32	25	■	■		8079218	DHAA-G-R3-32-B8-25
	32	35	■	■		8079221	DHAA-G-R3-32-B8-35
EHMB/HGPT-B	EHMB	HGPT-B			DHAA, HAPG		
	20	40	■	■	2	537184	HAPG-SD2-26
	20, 25, 32	50	■	■		564956	DHAA-G-Q5-32-B8-50
	25, 32	63	■	■		537188	HAPG-SD2-28
ELCC/HGPT-B	ELCC	HGPT-B			DHAA		
	60	35	■	■	2	5162493	DHAA-G-E21-60-B8-35
	60	40	■	■		5162495	DHAA-G-E21-60-B8-40
	60	50	■	■		5162497	DHAA-G-E21-60-B8-50
	70	40	■	■		2092070	DHAA-G-Q11-32-B8-40
	70, 90	50	■	■		2118750	DHAA-G-Q11-32-B8-50
	70, 90, 110	63	■	■		5162500	DHAA-G-E21-70...110-B8-63
	90, 110	80	■	■		5162502	DHAA-G-E21-70...110-B8-80
	ELCC	HGPT-B-G				2	
	60	35	■	■	5162494		DHAA-G-E21-60-B8G-35
	60	40	■	■	5162496		DHAA-G-E21-60-B8G-40
	60	50	■	■	5162498		DHAA-G-E21-60-B8G-50
	70	40	■	■	2597387		DHAA-G-Q11-32-B8G-40
	70, 90	50	■	■	2597428		DHAA-G-Q11-32-B8G-50
	70, 90, 110	63	■	■	5162501		DHAA-G-E21-70...110-B8G-63
	90, 110	80	■	■	5162503		DHAA-G-E21-70...110-B8G-80

1) Corrosion resistance class CRC 2 to Festo standard FN 940070

Moderate corrosion stress. Indoor applications in which condensation can occur. External visible parts with primarily decorative surface requirements which are in direct contact with a normal industrial environment.

Accessories

Gripper jaw blank BUB-HGPT
(2 included in the scope of delivery)

Material:
Aluminium

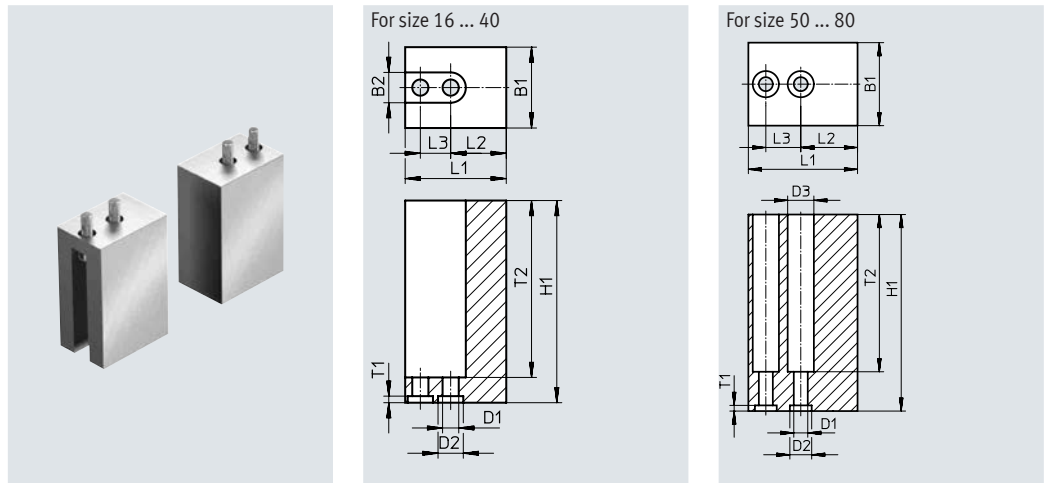



Dimensions and ordering data							
For size	B1	B2	D1	D2	D3	H1	L1
[mm]	±0.05	H13	∅ H13	∅ H8	∅ H13	±0.05	±0.05
16	16	6	3.2	5	–	40	21
20	19	6	3.2	5	–	45	27
25	24	8	4.3	7	–	60	31
35	28	10	5.3	9	–	70	39
40	34	11	6.4	9	–	75	49
50	40	–	6.4	9	11	100	61
63	50	–	10.3	12	17	120	79
80	58	–	12.4	15	20	140	88

For size	L2 ¹⁾	L3 ¹⁾	T1	T2	Weight per blank [g]	Part no.	Type
[mm]			+0.1				
16	10	8	1.3	35	29	560244	BUB-HGPT-16-B
20	11.75	12	1.3	36	53	560245	BUB-HGPT-20-B
25	13.25	13	1.6	51	98	560246	BUB-HGPT-25-B
35	17.5	16	2.1	61	161	560247	BUB-HGPT-35-B
40	22.5	20	2.1	66.5	280	560248	BUB-HGPT-40-B
50	29	24	2.1	91	622	560249	BUB-HGPT-50-B
63	37.5	32	2.6	110	1213	560250	BUB-HGPT-63-B
80	36	40	3.1	125	1738	560251	BUB-HGPT-80-B

1) Tolerance for centring hole ±0.02 mm
Tolerance for thread ±0.1 mm

Accessories

Ordering data						
	For size [mm]	Description	Weight [g]	Part no.	Type	PU ¹⁾
Centring sleeve ZBH			Data sheets → Internet: zbh			
	16, 20	For centring the gripper jaw blanks/gripper fingers on the gripper jaws	1	189652	ZBH-5	10
	25		1	186717	ZBH-7	
	35, 40, 50		1	150927	ZBH-9	
	63		1	189653	ZBH-12	
	80		3	191409	ZBH-15	
	20, 25	For lateral centring of gripper fingers on the gripper jaws	1	189652	ZBH-5	
	35, 40, 50, 63		1	186717	ZBH-7	
	80		1	150927	ZBH-9	
	16, 20	For centring the gripper during mounting	1	189652	ZBH-5	
	25, 35		1	186717	ZBH-7	
	40		1	150927	ZBH-9	
	50, 63, 80		1	189653	ZBH-12	
	Connector sleeve ZBV			Data sheets → Internet: zbv		
	-	For compensating for different centring diameters	1	571033	ZBV-6-5	1
			1	571034	ZBV-8-7	
			1	560253	ZBV-9-8	
			2	571035	ZBV-12-10	
			2	560255	ZBV-14-12	
Blanking plug B			Data sheets → Internet: blanking plug			
	16, 20	For sealing the compressed air supply ports	1	30979	B-M3-S9	10
	25, 35, 40		1	174308	B-M5-B	
	50, 63		5	3568	B-1/8	
	80		15	3569	B-1/4	

1) Packaging unit



Accessories

Proximity sensor for size 16 ... 35

Ordering data – Proximity sensor for C-slot, magneto-resistive							Data sheets → Internet: smt
	Type of mounting	Electrical connection, outlet direction of connection	Switching output	Cable length [m]	Part no.	Type	
N/O contact							
	Insertable in the slot lengthwise	Cable, 3-wire, lateral	PNP	2.5	547862	SMT-10G-PS-24V-E-2.5Q-OE	
		Plug M8x1, 3-pin, lateral		0.3	547863	SMT-10G-PS-24V-E-0.3Q-M8D	
		Cable, 3-wire, lateral	NPN	2.5	8065030	SMT-10G-NS-24V-E-2.5Q-OE	
		Plug M8x1, 3-pin, lateral		0.3	8065029	SMT-10G-NS-24V-E-0.3Q-M8D	

Proximity sensor for size 40 ... 80

Ordering data – Proximity sensor for T-slot, magneto-resistive							Data sheets → Internet: smt
	Type of mounting	Electrical connection, outlet direction of connection	Switching output	Cable length [m]	Part no.	Type	
N/O contact							
	Insertable in the slot lengthwise	Cable, 3-wire, lateral	PNP	2.5	547859	SMT-8G-PS-24V-E-2.5Q-OE	
		Plug M8x1, 3-pin, lateral		0.3	547860	SMT-8G-PS-24V-E-0.3Q-M8D	
		Cable, 3-wire, lateral	NPN	2.5	8065028	SMT-8G-NS-24V-E-2.5Q-OE	
		Plug M8x1, 3-pin, lateral		0.3	8065027	SMT-8G-NS-24V-E-0.3Q-M8D	

Ordering data – Connecting cables					Data sheets → Internet: nebu
	Electrical connection, left	Electrical connection, right	Cable length [m]	Part no.	Type
	Straight socket, M8x1, 3-pin	Cable, open end, 3-wire	2.5	541333	NEBU-M8G3-K-2.5-LE3
			5	541334	NEBU-M8G3-K-5-LE3
	Angled socket, M8x1, 3-pin	Cable, open end, 3-wire	2.5	541338	NEBU-M8W3-K-2.5-LE3
			5	541341	NEBU-M8W3-K-5-LE3

Position transmitter

Function area:

The position transmitter continuously senses the position of the piston. It has an analogue output with an output signal relative to the piston position.

Measuring range:

The entire stroke can be measured with sizes 40 and 50. A stroke of 13 mm (with the high-force variant 6.5 mm) can be measured with sizes 63 and 80.

Two position transmitters are required for sensing longer strokes.

Projection:

The position transmitter projects past the housing at the back with sizes 40 and 50.

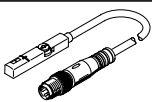
Ordering data – Position transmitter for T-slot							Data sheets → Internet: position transmitter	
	For size	Position measuring range	Analogue output [V]	Type of mounting	Electrical connection	Cable length [m]	Part no.	Type
	40 ... 80	0 ... 40	0 ... 10	Insertable in the slot from above	Plug M8x1, 4-pin, in-line	0.3	553744	SMAT-8M-U-E-0.3-M8D

Accessories

Position transmitter

The position transmitter continuously senses the position of the piston. It has an analogue output with an output signal relative to the piston position.

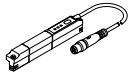

Ordering data – Position transmitter for T-slot

Data sheets → Internet: position transmitter

	For diam.	Position measuring range	Analogue output [mA]	Type of mounting	Electrical connection	Cable length [m]	Part no.	Type
	63, 80	0 ... 50	4 ... 20	Insertable in the slot from above	Plug M8x1, 4-pin, in-line	0.3	1531265	SDAT-MHS-M50-1L-SA-E-0.3-M8

Ordering data – Connecting cables

Data sheets → Internet: nebu

	Electrical connection, left	Electrical connection, right	Cable length [m]	Part no.	Type
	Straight socket, M8x1, 4-pin	Cable, open end, 4-wire	2.5	541342	NEBU-M8G4-K-2.5-LE4
			5	541343	NEBU-M8G4-K-5-LE4
	Angled socket, M8x1, 4-pin	Cable, open end, 4-wire	2.5	541344	NEBU-M8W4-K-2.5-LE4
			5	541345	NEBU-M8W4-K-5-LE4

Festo - Your Partner in Automation



1 Festo Inc.
5300 Explorer Drive
Mississauga, ON L4W 5G4
Canada

Festo Customer Interaction Center
Tel: 1 877 463 3786
Fax: 1 877 393 3786
Email: customer.service.ca@festo.com



2 Festo Pneumatic
Av. Ceylán 3,
Col. Tequesquináhuac
54020 Tlalnepantla,
Estado de México

Multinational Contact Center
01 800 337 8669
ventas.mexico@festo.com



3 Festo Corporation
1377 Motor Parkway
Suite 310
Islandia, NY 11749

Festo Customer Interaction Center
1 800 993 3786
1 800 963 3786
customer.service.us@festo.com



4 Regional Service Center
7777 Columbia Road
Mason, OH 45040

Connect with us



www.festo.com/socialmedia



www.festo.com

Subject to change