

Parallel grippers HGPL, heavy-duty with long stroke

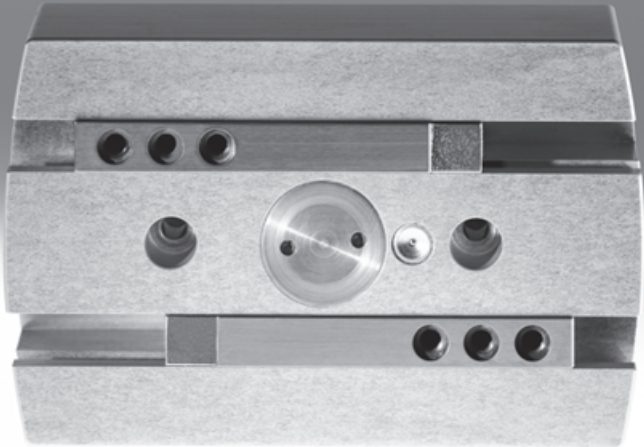

Parallel grippers HGPL, heavy-duty with long stroke

Key features



At a glance

- Space-saving and suitable for high forces
 - Two parallel and opposing pistons move the gripper jaws directly and without loss of force
- Reliable
 - A pinion that synchronises the movement of both gripper jaws ensures controlled, precise and centred gripping
 - The space-saving design of the parallel gripper jaws permits a long guide length for the gripper jaws
- Sturdy
 - The T-slot in combination with a long guide length allows the gripper jaws to withstand high forces and torques
- Flexible range of applications
 - Double-acting gripper suitable for external and internal gripping
 - Versatile mounting options and compressed air connections
 - Opening stroke can be adjusted to optimise time

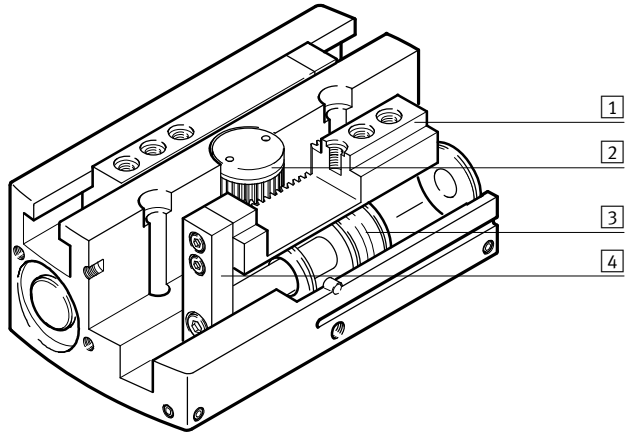

- 1 Gripper jaw
- 2 Synchronising element
- 3 Piston with magnet
- 4 Moment compensator

- - Note
Sizing software for gripper selection
→ www.festo.com

Wide range of supply ports

Direct from the front

Via adapter plate from underneath

Mounting options

Direct mounting from above

from underneath

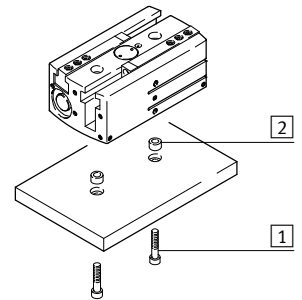
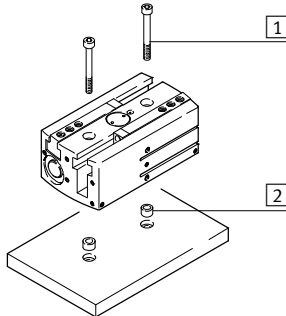
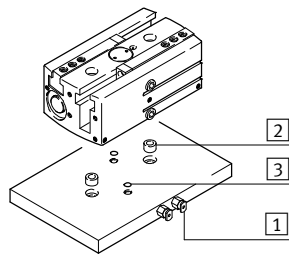
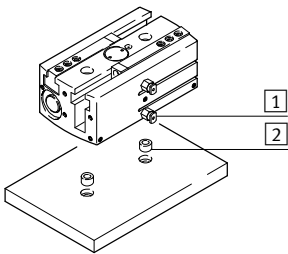

- 1 Supply ports
- 2 Centring sleeves
- 3 O-rings

- 1 Mounting screws
- 2 Centring sleeves

- - Note
These grippers are not suitable for the following or similar application examples:

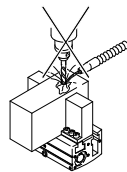

- Aggressive media
- Machining

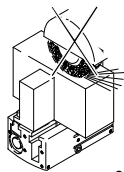

- Grinding dust

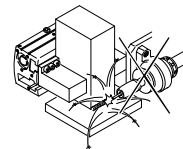

- Welding splashes

Parallel grippers HGPL, heavy-duty with long stroke

Peripherals overview and type codes

Peripherals overview

System product for handling and assembly technology

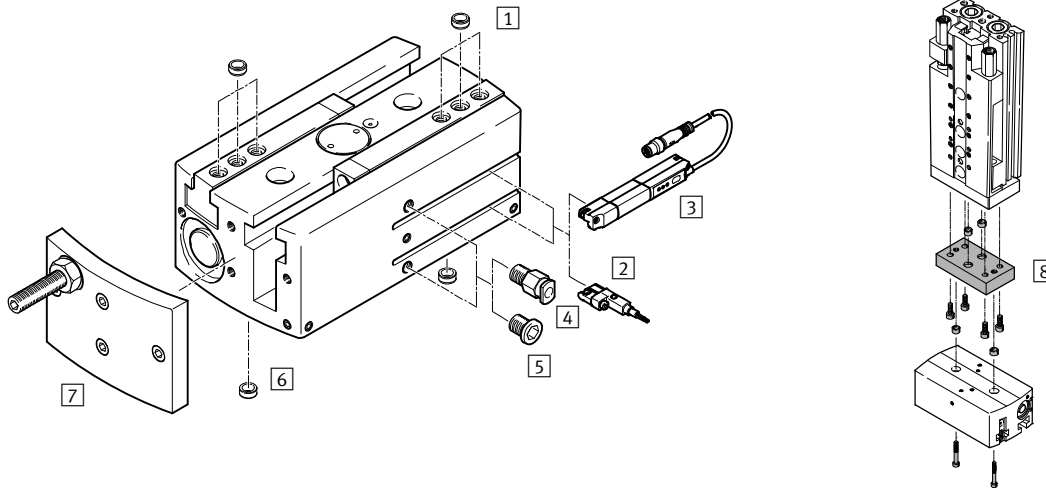

Accessories			
Type	Size	Description	→ Page/Internet
1 Centring sleeve ZBH	14 ... 63	<ul style="list-style-type: none"> For centring gripper jaw blanks/gripper fingers on the gripper jaws 4 included in the scope of delivery 	17
2 Proximity sensor SME/SMT-10	14 ... 40	<ul style="list-style-type: none"> For sensing the piston position 	18
Proximity sensor SME/SMT-8	63	<ul style="list-style-type: none"> For sensing the piston position 	
3 Position transmitter SME/SMT-8	63	<ul style="list-style-type: none"> For sensing the piston position 	18
4 Push-in fitting QS	14 ... 63	For connecting compressed air tubing with standard O.D.	qs
5 Blanking plug B	14 ... 63	For sealing supply ports when using ports at the front	17
6 Centring sleeve ZBH	14 ... 63	<ul style="list-style-type: none"> For centring the gripper during mounting 2 included in the scope of delivery 	17
7 Stroke reducing kit HGPL-HR ...	14 ... 63	For reducing the opening stroke	16
8 Adapter kit DHAA, HMSV, HMVA, HAPG	14 ... 63	Drive/gripper connections	13
- Gripper jaw blank BUB-HGPL	14 ... 63	Blank specially matched to the gripper jaws for custom production of gripper fingers	LEERER MERKER

Type codes

HGPL		-	14	-	40	-	A
Type							
HGPL	Parallel gripper						
Size							
Stroke [mm]							
Position sensing							
A	Via proximity sensor						

Parallel grippers HGPL, heavy-duty with long stroke

FESTO

Technical data

Function
Double-acting
HGPL...-A



www.festo.com
Wearing parts kits
→ page 12

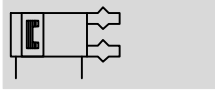

- - Size
14 ... 63 mm
- - Stroke
40 ... 300 mm

General technical data				
Size	14	25	40	63
Design	Synchronised pneumatic pistons Force-guided motion sequence			
Mode of operation	Double-acting T-shape			
Gripper function	Parallel			
Number of gripper jaws	2			
Stroke per gripper jaw [mm]	20, 40, 60, 80	20, 40, 60, 80	20, 40, 60, 80, 100	60, 100, 150
Pneumatic connection	M5			G1/8
Max. load per external gripper finger ¹⁾ [g]	80	250	420	940
Repetition accuracy ²⁾ [mm]	< 0.03			
Max. interchangeability [mm]	< 0.2			
Max. operating frequency [Hz]	< 1			
Rotational symmetry [mm]	< Ø 0.2			
Position sensing	Via proximity sensor -			Position transmitter
Type of mounting	Via through-holes and centring sleeves Via female thread and centring sleeves			
Mounting position	Any			

- 1) Valid for unthrottled operation
- 2) End-position drift under constant conditions of use with 100 consecutive strokes in the direction of movement of the gripper jaws

Operating and environmental conditions	
Operating pressure [bar]	3 ... 8
Operating medium	Compressed air in accordance with ISO 8573-1:2010 [7:4:4]
Note on operating/pilot medium	Operation with lubricated medium possible (in which case lubricated operation will always be required)
Ambient temperature ¹⁾ [°C]	+5 ... +60
Corrosion resistance class CRC ²⁾	2

- 1) Note operating range of proximity sensors
- 2) Corrosion resistance class CRC 2 to Festo standard FN 940070
Moderate corrosion stress. Indoor applications in which condensation may occur. External visible parts with primarily decorative requirements for the surface and which are in direct contact with the ambient atmosphere typical for industrial applications.

Weight [g]					
Size	14	25	40	63	
Stroke per gripper jaw	20 mm	305	1015	2560	-
	40 mm	440	1400	3300	-
	60 mm	595	1780	4165	10460
	80 mm	720	2200	4800	-
	100 mm	-	-	5340	13800
	150 mm	-	-	-	18100

Parallel grippers HGPL, heavy-duty with long stroke

Technical data

Materials

Sectional view

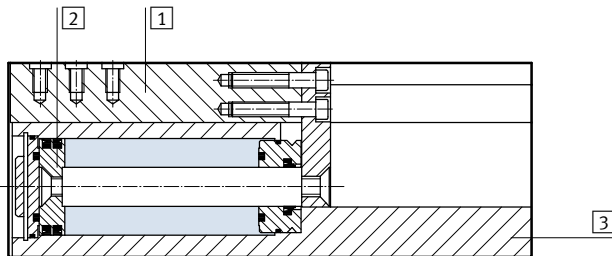

Parallel gripper		
1	Gripper jaw	Steel, nitrided
2	Piston	High-alloy steel
3	Housing	Wrought aluminium alloy, hard-anodised
-	Seals	Nitrile rubber, polyurethane
-	Note on materials	Free of copper and PTFE RoHS-compliant

Measured gripping force [N] at 6 bar (→ also see graphs starting on page 7)

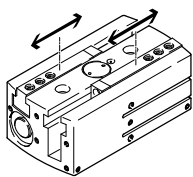

Size	14	25	40	63
Gripping force per gripper jaw				
Opening	63	206	519	1233
Closing	79	256	608	1371
Total gripping force				
Opening	126	412	1038	2466
Closing	158	512	1216	2742

Characteristic load values at the gripper jaws

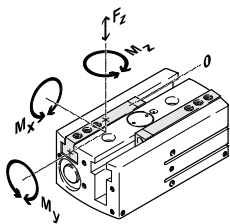

The indicated permissible forces and torques apply to a single gripper jaw. They include the lever arm, additional applied loads due to the workpiece or external gripper fingers and

acceleration forces occurring during movement. The zero coordinate line (guide groove of the gripper jaws) must be taken into consideration for the calculation of torques.

Size	14	25	40	63	
Max. permissible force F_z	[N]	500	1500	2500	9000
Max. permissible torque M_x	[Nm]	35	100	125	300
Max. permissible torque M_y	[Nm]	35	60	80	200
Max. permissible torque M_z	[Nm]	35	70	100	250

Parallel grippers HGPL, heavy-duty with long stroke

Technical data

Mass moment of inertia [kgm²x10⁻⁴]

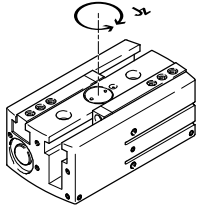

Mass moment of inertia of the parallel gripper in relation to the central axis, without external gripper fingers, without load.

Size		14	25	40	63
Stroke per gripper jaw	20 mm	1.40	11.98	27.60	-
	40 mm	6.69	18.88	66.83	-
	60 mm	11.43	39.95	118.30	470.07
	80 mm	21.93	78.70	198.87	-
	100 mm	-	-	318.25	1018.17
	150 mm	-	-	-	2247.54

Opening and closing times [ms] at 6 bar

Without external gripper fingers

With external gripper fingers

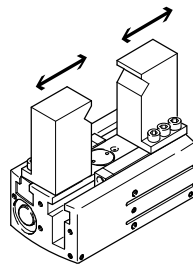
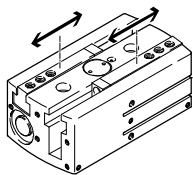

The indicated opening and closing times [ms] were measured at room temperature at an operating pressure of 6 bar with horizontally mounted grippers without additional gripper

fingers. The grippers must be throttled for greater loads [g]. Opening and closing times must then be adjusted accordingly.

Size	mm	14				25				40					63		
		20	40	60	80	20	40	60	80	20	40	60	80	100	60	100	150
Without external gripper fingers																	
Opening times		120	171	270	286	170	225	370	423	190	238	430	414	620	410	650	1020
Closing times		110	163	230	270	150	230	370	418	180	205	430	438	690	330	600	850
Max. permissible opening and closing times with external gripper fingers (as a function of the load per gripper finger)																	
Load of the gripper fingers	100 g	123	108	257	243	-	-	-	-	-	-	-	-	-	-	-	-
	200 g	174	136	364	343	-	-	-	-	-	-	-	-	-	-	-	-
	300 g	213	167	445	420	164	210	405	401	-	-	-	-	-	-	-	-
	400 g	246	192	514	485	190	243	468	463	-	-	-	-	-	-	-	-
	500 g	-	-	-	-	212	272	523	518	196	260	469	478	676	-	-	-
	600 g	-	-	-	-	-	-	-	-	215	284	514	524	741	-	-	-
	700 g	-	-	-	-	-	-	-	-	232	307	555	565	800	-	-	-
	800 g	-	-	-	-	-	-	-	-	248	328	593	604	856	-	-	-
	900 g	-	-	-	-	-	-	-	-	-	-	-	-	-	323	587	832
	1000 g	-	-	-	-	-	-	-	-	-	-	-	-	-	340	619	877
	1100 g	-	-	-	-	-	-	-	-	-	-	-	-	-	357	649	919
	1200 g	-	-	-	-	-	-	-	-	-	-	-	-	-	373	678	960

Parallel grippers HGPL, heavy-duty with long stroke

Technical data

Gripping force F_h per gripper jaw as a function of operating pressure and lever arm x

The gripping forces as a function of operating pressure and lever arm can be determined from the following graphs.

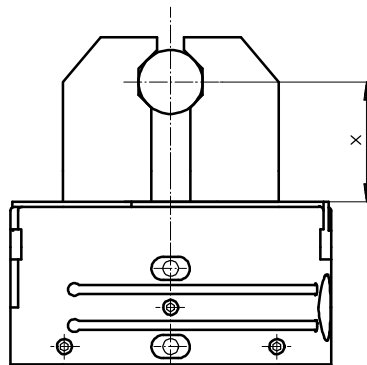

Gripping force F_h per gripper jaw as a function of operating pressure and lever arm x External gripping (closing)

HGPL-14

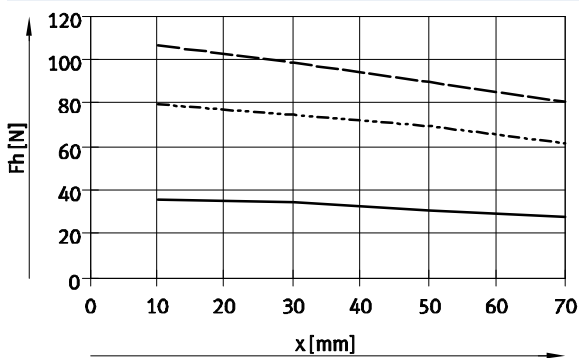

HGPL-25

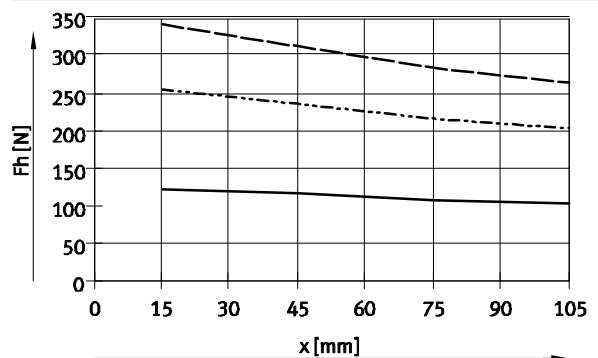

HGPL-40

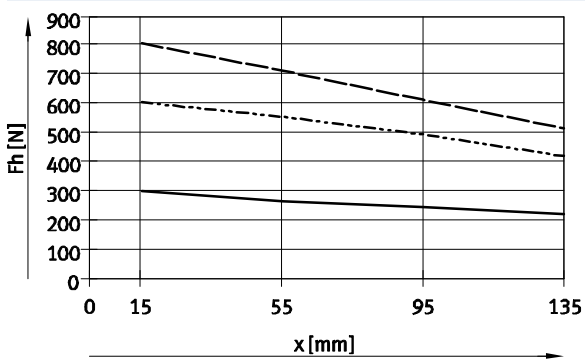

HGPL-63

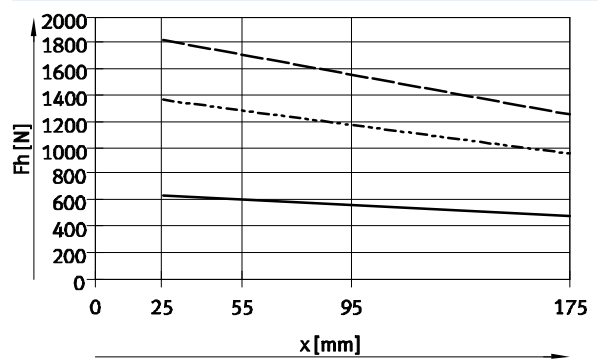

- 3 bar
- - - 6 bar
- · - · 8 bar

Parallel grippers HGPL, heavy-duty with long stroke

Technical data

Gripping force F_h per gripper jaw as a function of operating pressure and lever arm x
Internal gripping (opening)

HGPL-14

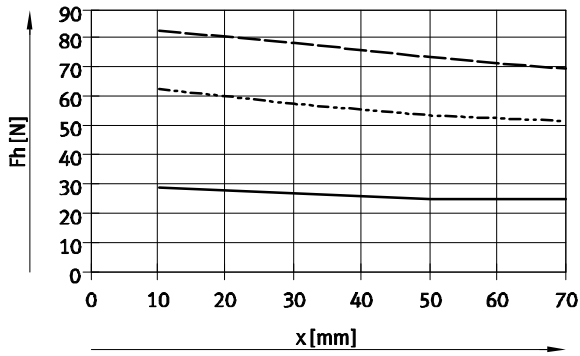

HGPL-25

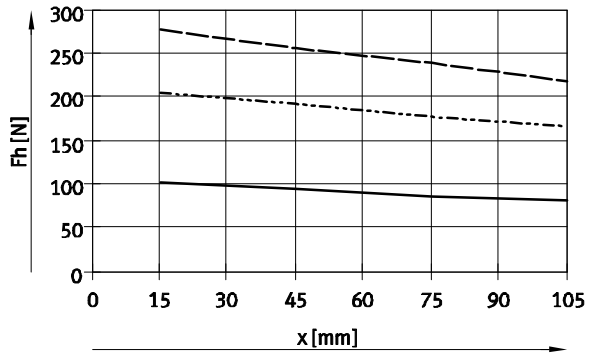

HGPL-40

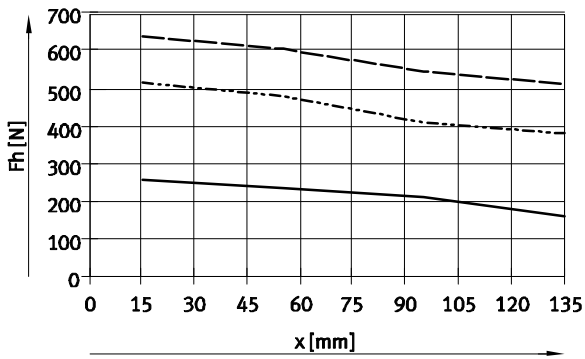

HGPL-63

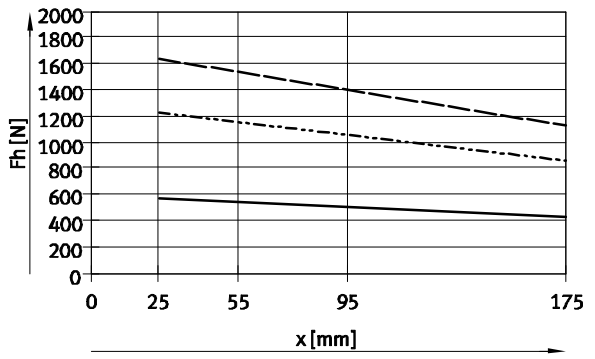

- 3 bar
- - - 6 bar
- · - 8 bar

Parallel grippers HGPL, heavy-duty with long stroke

Technical data

Gripping force F_h per gripper jaw at 6 bar as a function of lever arm x and eccentricity a and b

The following formula must be used to calculate the lever arm x with eccentric gripping:

$$x = \sqrt{a^2 + b^2}$$

The gripping force F_h can be read from the graphs (→ page 7) using the calculated value x .

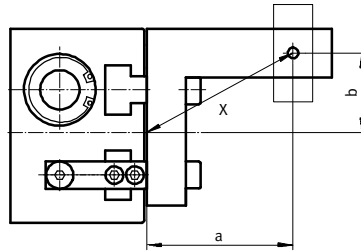

Calculation example

Given:

Distance $a = 45$ mm

Distance $b = 40$ mm

To be calculated:

The gripping force at 6 bar, with an HGPL-25, used as an external gripper

Procedure:

Calculating the lever arm x

$$x = \sqrt{45^2 + 40^2}$$

$$x = 60$$
 mm

The graph (→ page 7) shows a value of $F_h = 225$ N for the gripping force.

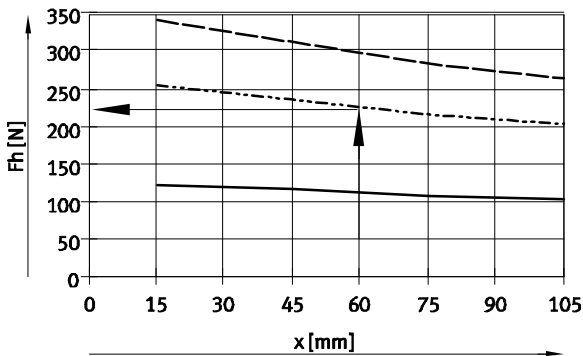

Parallel grippers HGPL, heavy-duty with long stroke

Technical data

FESTO

Dimensions

Download CAD data → www.festo.com

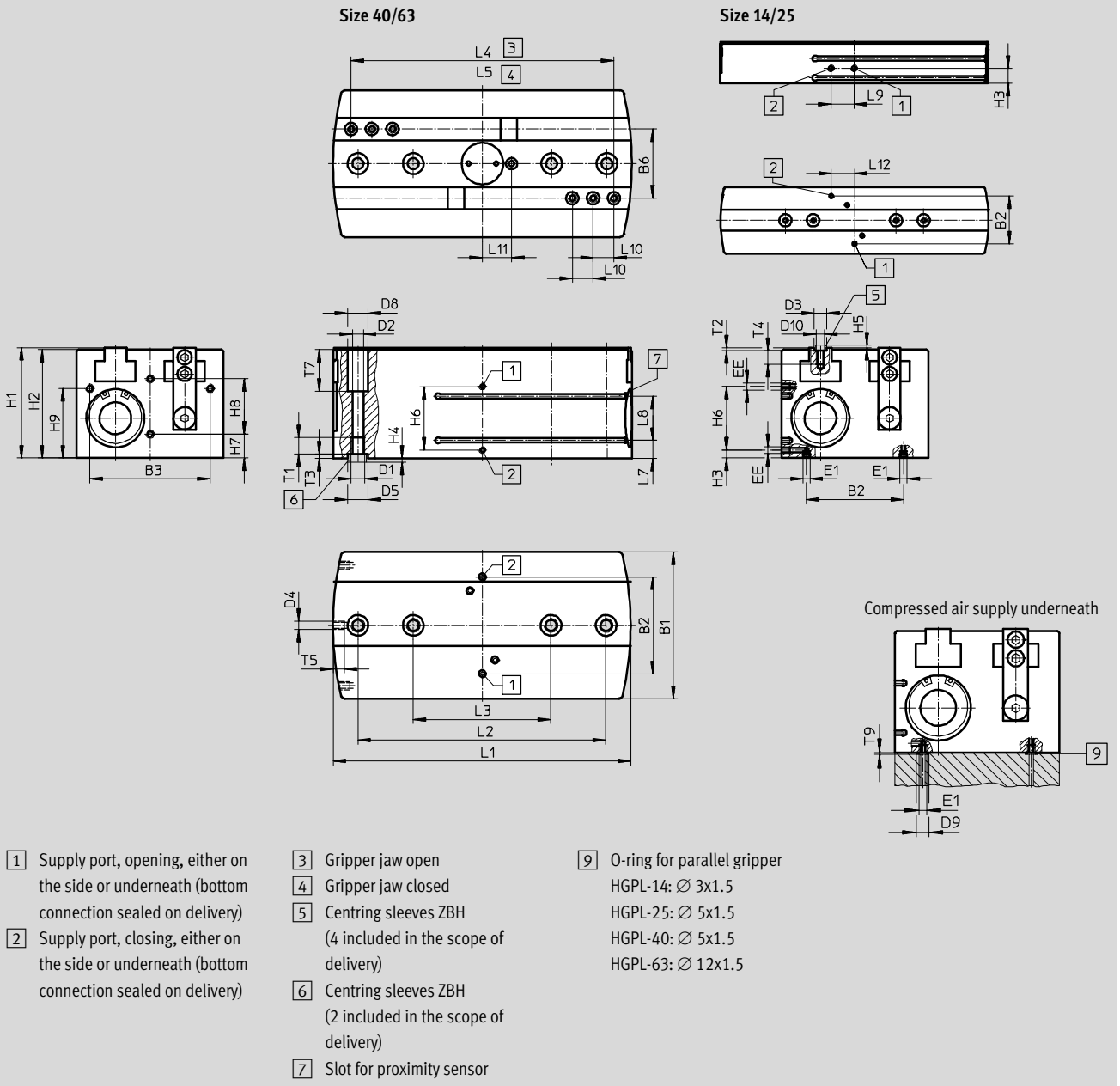

Parallel grippers HGPL, heavy-duty with long stroke

Technical data

Type	B1 ±0.05	B2 ±0.1	B3 ±0.1	B6 ±0.01	D1	D2 ∅ +0.1	D3 ∅ H8/h7	D4	D5 ∅ H8/h7	D8 ∅ H13	D9	D10	EE	E1
HGPL-14	48	34.5	37	22	M5	4.2	5	M3	9	7.4	6	M3	M5	M3
HGPL-25	80	60	65	38	M6	5.1	7	M5	9	10	8	M5	M5	M5
HGPL-40	106	70	87	50	M10	8.5	9	M6	15	15	8	M6	M5	M5
HGPL-63	154	116	130	78	M12	10.4	15	M8	15	16.5	15	M10	G1/8	G1/8

Type	H1	H2 ±0.1	H3 ±0.1	H4 -0.3	H5 -0.3	H6 ±0.1	H7 ±0.1	H8 ±0.1	H9 ±0.1	L1 ±0.1	L2 ±0.02 ¹⁾ ±0.1 ²⁾	L3 ±0.02 ¹⁾ ±0.1 ²⁾	L4 ±0.5
HGPL-14-20	30	29	11	1.9	1.2	-	10	12	18	73.6	-	36	62
113.6										-	60		102
153.6										100		60	142
193.6										-	182		
HGPL-25-20	50	49	18	1.9	1.4	-	18	20	30	86	-	60	64
126										-	60		104
166										100		60	144
206										-	184		
HGPL-40-20	80	78.5	6	2.9	1.9	46	17.5	40	50.5	96	-	66	70
136										-	100		110
176										180		100	150
216										200	100		190
256										-		230	
HGPL-63-60	121.5	120	14	2.9	2.9	60	30	58	74.8	190.8	-	100	160
270.8										200	100		240
370.8										300		340	

Type	L5 ±0.5	L7 ±0.1	L8 ±0.1	L9 ±0.2	L10 ±0.02 ¹⁾ ±0.1 ²⁾	L11 ±0.5	L12 ±0.1	T1 min.	T2 +0.1	T3 +0.1	T4 min.	T5 min.	T7 +0.1	T9
HGPL-14-20	22	4	14	16.8	8	9	16.8	12.5	1.3	2.1	5.5	6.5	10	1
HGPL-14-40														
HGPL-14-60														
HGPL-14-80														
HGPL-25-20	24	11	14	20	10	17.5	20	12.5	1.6	2.1	8.5	7	17	1
HGPL-25-40														
HGPL-25-60														
HGPL-25-80														
HGPL-40-20	30	13	32	-	15	20.5	-	15.5	2.1	3.1	10.5	8	30	1
HGPL-40-40														
HGPL-40-60														
HGPL-40-80														
HGPL-40-100														
HGPL-63-60	40	28.5	30	-	22	29	-	18	3.1	3.1	17.5	8	45	1
HGPL-63-100														
HGPL-63-150														

1) For centring
2) For through-hole

Parallel grippers HGPL, heavy-duty with long stroke

FESTO

Technical data

Ordering data			
Size [mm]	Stroke [mm]	Double-acting without compression spring	
		Part No.	Type
14			
	20	567820	HGPL-14-20-A
	40	535852	HGPL-14-40-A
	60	567821	HGPL-14-60-A
	80	535853	HGPL-14-80-A
25			
	20	567822	HGPL-25-20-A
	40	535854	HGPL-25-40-A
	60	567823	HGPL-25-60-A
	80	535855	HGPL-25-80-A
40			
	20	567824	HGPL-40-20-A
	40	535856	HGPL-40-40-A
	60	567825	HGPL-40-60-A
	80	535857	HGPL-40-80-A
	100	567826	HGPL-40-100-A
63			
	60	567827	HGPL-63-60-A
	100	567828	HGPL-63-100-A
	150	567829	HGPL-63-150-A

Ordering data – Sets of wearing parts			
Size [mm]		Part No.	Type
14		701585	HGPL-14-A
25		701586	HGPL-25-A
40		701587	HGPL-40-A
63		752917	HGPL-63-A



Parallel grippers HGPL, heavy-duty with long stroke

Accessories

Adapter kit
DHAA, HAPG, HMSV, HMVA

Material:
Wrought aluminium alloy
Free of copper and PTFE
RoHS-compliant

 Note
The kit includes the individual mounting interface as well as the necessary mounting material.

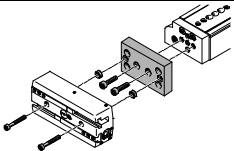
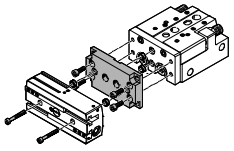
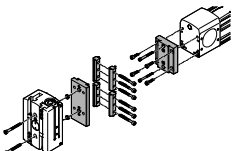
Permissible drive/gripper combinations with adapter kit					Download CAD data → www.festo.com		
Combination	Drive Size	Gripper Size	Mounting option		Adapter kit		
					CRC ¹⁾	Part No.	Type
DGSL/HGPL	DGSL	HGPL			DHAA, HAPG		
	16	14-20	■	■	2	2406159	DHAA-G-G6-16-B6-14
	20, 25	14-20	■	■		2410181	DHAA-G-G6-20-B6-14
	16	14-40, 14-60, 14-80	■	■		538055	HAPG-89
	20, 25	14-40, 14-60, 14-80	■	■		539274	HAPG-90
	25	25	■	■		539274	HAPG-90
SLT/HGPL	SLT	HGPL			DHAA, HAPG		
	16	14-20	■	–	2	2404522	DHAA-G-G3-16-B6-14
	20	14-20	■	–		2406709	DHAA-G-G3-20-B6-14
	25	14-20	■	–		2408600	DHAA-G-G3-25-B6-14
	16	14-40, 14-60, 14-80	■	–		538055	HAPG-89
	20, 25	14-40, 14-60, 14-80	■	–		539274	HAPG-90
	20, 25	25	■	–		539274	HAPG-90
DGP..., DGE-..., DGEA/HGPL	DG...	HGPL			HAPG, HMSV, HMVA		
	40	25	■	■	2	196790	HMVA-DLA40
						177653	HMSV-7
						539887	HAPG-92

1) Corrosion resistance class CRC 2 to Festo standard FN 940070
Moderate corrosion stress. Indoor applications in which condensation may occur. External visible parts with primarily decorative requirements for the surface and which are in direct contact with the ambient atmosphere typical for industrial applications.

Parallel grippers HGPL, heavy-duty with long stroke



Accessories



**Adapter kit
DHAA**

Material:
Wrought aluminium alloy
Free of copper and PTFE
RoHS-compliant

 Note
The kit includes the individual mounting interface as well as the necessary mounting material.

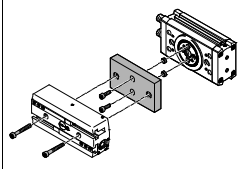
Permissible drive/gripper combinations with adapter kit					Download CAD data → www.festo.com		
Combination	Drive	Gripper		Adapter kit			
	Size	Size	Mounting option		CRC ¹⁾	Part No.	Type
							
DRRD/HGPL	DRRD	HGPL			DHAA		
	16	14-20	■	■	2	2019271	DHAA-G-Q11-16-B6-14-20
	16	14-40	■	■		2019618	DHAA-G-Q11-16-B6-14-40
	16	14-60, 14-80	■	■		2019640	DHAA-G-Q11-16-B6-14-60/80
	20	14-20	■	■		2018509	DHAA-G-Q11-20-B6-14-20
	20	14-40	■	■		2018553	DHAA-G-Q11-20-B6-14-40
	20	14-60, 14-80	■	■		2018986	DHAA-G-Q11-20-B6-14-60/80
	25	14-20	■	■		1813646	DHAA-G-Q11-25-B6-14-20
	25	14-40	■	■		1734087	DHAA-G-Q11-25-B6-14-40
	25	14-60, 14-80	■	■		2018453	DHAA-G-Q11-25-B6-14-60/80
	25	25-20, 25-40	■	■		1794882	DHAA-G-Q11-25-B6-25-20/40
	25	25-60, 25-80	■	■		2020149	DHAA-G-Q11-25-B6-25-60/80
	32	25-20, 25-40	■	■		2021733	DHAA-G-Q11-32-B6-25-20/40
	32	25-60, 25-80	■	■		2022377	DHAA-G-Q11-32-B6-25-60/80
	35	25-20, 25-40	■	■		2022892	DHAA-G-Q11-35-B6-25-20/40
	35	25-60, 25-80	■	■		2023095	DHAA-G-Q11-35-B6-25-60/80
	35, 40	40-20	■	■		2023665	DHAA-G-Q11-35/40-B6-40-20
	35, 40	40-40, 40-60	■	■		2024121	DHAA-G-Q11-35/40-B6-40-40/60
	35, 40	40-80, 40-100	■	■		2024947	DHAA-G-Q11-35/40-B6-40-80/100
	50	40-20	■	■		2387903	DHAA-G-Q11-50-B6-40-20
	50	40-40, 40-60, 40-80, 40-100	■	■		2431288	DHAA-G-Q11-50-B6-40-40/60/80/100
50	63-60, 63-100, 63-150	■	■	2431624	DHAA-G-Q11-50-B6-63-60/100/150		

1) Corrosion resistance class CRC 2 to Festo standard FN 940070
Moderate corrosion stress. Indoor applications in which condensation may occur. External visible parts with primarily decorative requirements for the surface and which are in direct contact with the ambient atmosphere typical for industrial applications.



Parallel grippers HGPL, heavy-duty with long stroke

Accessories

Adapter kit
DHAA, HAPG

Material:
Wrought aluminium alloy
Free of copper and PTFE
RoHS-compliant

 Note
The kit includes the individual mounting interface as well as the necessary mounting material.

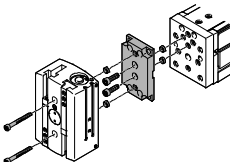
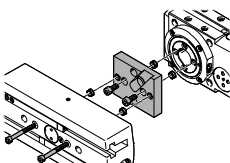
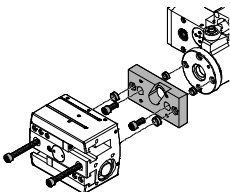
Permissible drive/gripper combinations with adapter kit					Download CAD data → www.festo.com		
Combination	Drive Size	Gripper Size	Mounting option		Adapter kit		
					CRC ¹⁾	Part No.	Type
	EGSL	HGPL			HAPG		
	45, 55	14-20	■	■	2	2406159	DHAA-G-G6-16-B6-14
	75	14-20	■	■		2410181	DHAA-G-G6-20-B6-14
	45, 55	14-40, 14-60, 14-80	■	■	2	538055	HAPG-89
	75	14-40, 14-60, 14-80	■	■		539274	HAPG-90
	75	25	■	■		539274	HAPG-90
	ERMB	HGPL			HAPG		
	20	14-40, 14-60, 14-80	■	■	2	537310	HAPG-SD2-31
	25, 32	25	■	■		537311	HAPG-SD2-29
	EHMB	HGPL			HAPG		
	25	40-20	■	■	2	2436852	DHAA-G-H2-25-B6-40
	20	25	■	■		537311	HAPG-SD2-29
	25	40-40, 40-60, 40-80, 40-100	■	■	2	537312	HAPG-SD2-30

1) Corrosion resistance class CRC 2 to Festo standard FN 940070
Moderate corrosion stress. Indoor applications in which condensation may occur. External visible parts with primarily decorative requirements for the surface and which are in direct contact with the ambient atmosphere typical for industrial applications.

Parallel grippers HGPL, heavy-duty with long stroke

FESTO

Accessories

Stroke reducing kit HGPL-HR

Material:
Aluminium
Free of copper and PTFE

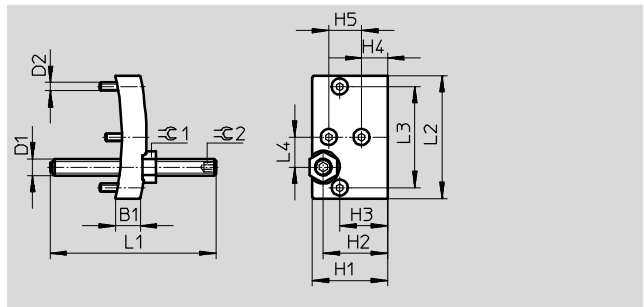

Dimensions and ordering data								
For size	B1	D1	D2	H1	H2	H3	H4	H5
[mm]	±0.1			±0.1	±0.1	±0.1	±0.1	±0.1
14	9	M6	M3	27.5	23.5	17.5	9.5	12
25	12	M8	M5	47.5	37.5	29.5	17.5	20
40	18	M12	M6	77	63	50	17	40
63	19	M14	M8	118.5	94.5	74.5	29.5	58

For size	L1	L2	L3	L4	≈C1	≈C2	Weight	Part No.	Type
[mm]	±1	±0.1	±0.1	±0.1			[g]		
14	61	45	37	11	10	3	45	539092	HGPL-HR-14
25	61	77	65	19	13	4	150	539093	HGPL-HR-25
40	61	103	87	25	19	6	455	539094	HGPL-HR-40
63	81	151	130	39	22	6	1060	567831	HGPL-HR-63

Parallel grippers HGPL, heavy-duty with long stroke

Accessories

Gripper jaw blank BUB-HGPL
(scope of delivery: 2 pieces)

Material:
Aluminium
Free of copper and PTFE

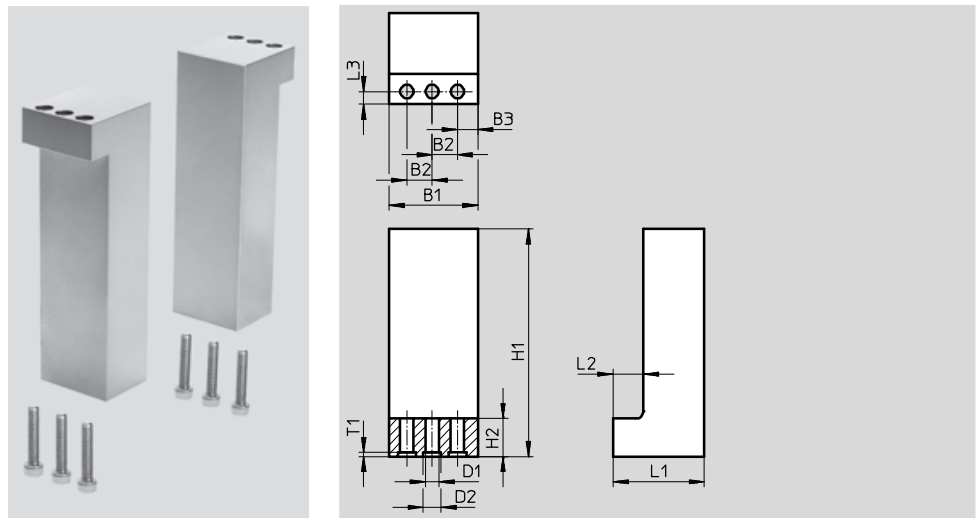

Dimensions and ordering data							
For size	B1	B2	B3	D1 ∅	D2 ∅	H1	H2
[mm]	±0.1	+0.02		+0.1	H8	±0.1	
14	25	8	4	3.2	5	80	11
25	35	10	8	5.3	7	120	15
40	50	15	10	6.4	9	150	18
63	68	22	12	10.5	15	200	20

For size	L1	L2	L3	T1	Weight per blank [g]	Part No.	Type
[mm]	±0.1	+0.1	+0.1	+0.1			
14	20.5	8	3.3	1.3	75	537316	BUB-HGPL-14
25	36	12	5	1.6	295	537317	BUB-HGPL-25
40	49.5	16.5	8	2.1	720	537318	BUB-HGPL-40
63	77	27	12	3.1	1960	567830	BUB-HGPL-63



Ordering data						
	For size [mm]	Weight [g]	Part No.	Type	PU ¹⁾	
Centring sleeve for the gripper jaws ZBH			Technical data → Internet: zbh			
	14	1	189652	ZBH-5	10	
	25	1	186717	ZBH-7		
	40	1	150927	ZBH-9		
	63	3	191409	ZBH-15		
Centring sleeve for the gripper ZBH			Technical data → Internet: zbh			
	14, 25	1	150927	ZBH-9	10	
	40, 63	3	191409	ZBH-15		
Blanking plug B			Technical data → Internet: blanking plug			
	14, 25, 40	2	174308	B-M5-B	10	
	63	5	3568	B-1/8		

1) Packaging unit

Parallel grippers HGPL, heavy-duty with long stroke

Accessories

Proximity sensors for size 14 ... 40						
Ordering data – Proximity sensors for C-slot, magneto-resistive						Technical data → Internet: smt
	Type of mounting	Electrical connection, connection direction	Switching output	Cable length [m]	Part No.	Type
N/O contact						
	Insertable in the slot from above	Cable, 3-wire, in-line	PNP	2.5	551373	SMT-10M-PS-24V-E-2,5-L-OE
		Plug M8x1, 3-pin, in-line		0.3	551375	SMT-10M-PS-24V-E-0,3-L-M8D
		Cable, 3-wire, lateral	NPN	2.5	551374	SMT-10M-PS-24V-E-2,5-Q-OE
		Plug M8x1, 3-pin, lateral		0.3	551376	SMT-10M-PS-24V-E-0,3-Q-M8D

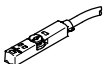
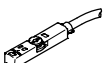

Ordering data – Proximity sensors for C-slot, magnetic reed						
Ordering data – Proximity sensors for C-slot, magnetic reed						Technical data → Internet: sme
	Type of mounting	Electrical connection, connection direction	Switching output	Cable length [m]	Part No.	Type
N/O contact						
	Insertable in the slot from above	Cable, 3-wire, in-line	Contacting	2.5	551365	SME-10M-DS-24V-E-2,5-L-OE
		Plug M8x1, 3-pin, in-line		0.3	551367	SME-10M-DS-24V-E-0,3-L-M8D
		Cable, 3-wire, lateral	NPN	2.5	551366	SME-10M-DS-24V-E-2,5-Q-OE
		Plug M8x1, 3-pin, lateral		0.3	551368	SME-10M-DS-24V-E-0,3-Q-M8D
	Insertable in the slot lengthwise	Cable, 3-wire, in-line	NPN	2.5	173210	SME-10-KL-LED-24
		Plug M8x1, 3-pin, in-line		0.3	173212	SME-10-SL-LED-24

Ordering data – Proximity sensors for C-slot, magneto-resistive						
Ordering data – Proximity sensors for C-slot, magneto-resistive						Technical data → Internet: smt
	Type of mounting	Electrical connection, connection direction	Switching output	Cable length [m]	Part No.	Type
N/O contact						
	Insertable in the slot lengthwise	Cable, 3-wire, lateral	PNP	2.5	547862	SMT-10G-PS-24V-E-2,5Q-OE
		Plug M8x1, 3-pin, lateral		0.3	547863	SMT-10G-PS-24V-E-0,3Q-M8D
		Cable, 3-wire, lateral	NPN	2.5	8065030	SMT-10G-NS-24V-E-2,5Q-OE
		Plug M8x1, 3-pin, lateral		0.3	8065029	SMT-10G-NS-24V-E-0,3Q-M8D

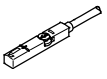
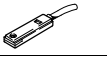

Proximity sensors for size 63						
Ordering data – Proximity sensors for T-slot, magneto-resistive						Technical data → Internet: smt
	Type of mounting	Electrical connection, connection direction	Switching output	Cable length [m]	Part No.	Type
N/O contact						
	Insertable in the slot from above, short design	Cable, 3-wire, in-line	PNP	2.5	574335	SMT-8M-A-PS-24V-E-2,5-OE
		Plug M8x1, 3-pin, in-line		0.3	574334	SMT-8M-A-PS-24V-E-0,3-M8D
		Plug M12x1, 3-pin, in-line		0.3	574337	SMT-8M-A-PS-24V-E-0,3-M12
		Cable, 3-wire, in-line	NPN	2.5	574338	SMT-8M-A-NS-24V-E-2,5-OE
		Plug M8x1, 3-pin, in-line		0.3	574339	SMT-8M-A-NS-24V-E-0,3-M8D
N/C contact						
	Insertable in the slot from above, short design	Cable, 3-wire, in-line	PNP	7.5	574340	SMT-8M-A-PO-24V-E-7,5-OE

Parallel grippers HGPL, heavy-duty with long stroke

Accessories

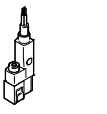
Proximity sensors for size 63						
Ordering data – Proximity sensors for T-slot, magnetic reed						Technical data → Internet: sme
	Type of mounting	Electrical connection, connection direction	Switching output	Cable length [m]	Part No.	Type
N/O contact						
	Insertable in the slot from above	Cable, 3-wire, in-line	Contacting	2.5	543862	SME-8M-DS-24V-K-2,5-OE
		Cable, 2-wire, in-line		5.0	543863	SME-8M-DS-24V-K-5,0-OE
		Plug M8x1, 3-pin, in-line		2.5	543872	SME-8M-ZS-24V-K-2,5-OE
	Insertable in the slot lengthwise	Cable, 3-wire, in-line	Contacting	2.5	150855	SME-8-K-LED-24
		Plug M8x1, 3-pin, in-line		0.3	150857	SME-8-S-LED-24
N/C contact						
	Insertable in the slot lengthwise	Cable, 3-wire, in-line	Contacting	7.5	160251	SME-8-O-K-LED-24

Ordering data – Proximity sensors for T-slot, magneto-resistive						Technical data → Internet: smt
	Type of mounting	Electrical connection, connection direction	Switching output	Cable length [m]	Part No.	Type
N/O contact						
	Insertable in the slot lengthwise	Cable, 3-wire, lateral	PNP	2.5	547859	SMT-8G-PS-24V-E-2,5Q-OE
		Plug M8x1, 3-pin, lateral		0.3	547860	SMT-8G-PS-24V-E-0,3Q-M8D
		Cable, 3-wire, lateral	NPN	2.5	8065028	SMT-8G-NS-24V-E-2,5Q-OE
		Plug M8x1, 3-pin, lateral		0.3	8065027	SMT-8G-NS-24V-E-0,3Q-M8D

Ordering data – Connecting cables					Technical data → Internet: nebu
	Electrical connection, left	Electrical connection, right	Cable length [m]	Part No.	Type
	Straight socket, M8x1, 3-pin	Cable, open end, 3-wire	2.5	541333	NEBU-M8G3-K-2.5-LE3
			5	541334	NEBU-M8G3-K-5-LE3
	Straight socket, M12x1, 5-pin	Cable, open end, 3-wire	2.5	541363	NEBU-M12G5-K-2.5-LE3
			5	541364	NEBU-M12G5-K-5-LE3
	Angled socket, M8x1, 3-pin	Cable, open end, 3-wire	2.5	541338	NEBU-M8W3-K-2.5-LE3
			5	541341	NEBU-M8W3-K-5-LE3
	Angled socket, M12x1, 5-pin	Cable, open end, 3-wire	2.5	541367	NEBU-M12W5-K-2.5-LE3
			5	541370	NEBU-M12W5-K-5-LE3

Position transmitter

The position transmitter continuously senses the position of the piston.

It has an analogue output with an output signal in proportion to the piston position.

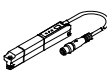
Ordering data – Position transmitters for T-slot							Technical data → Internet: position transmitter		
	For size	Position measuring range	Analogue output		Type of mounting	Electrical connection	Cable length [m]	Part No.	Type
			[V]	[mA]					
	63	0 ... 50	-	4 ... 20	Insertable in slot from above	Plug M8x1, 4-pin, in-line	0.3	1531265	SDAT-MHS-M50-1L-SA-E-Q3-M8
		0 ... 80						1531266	SDAT-MHS-M80-1L-SA-E-Q3-M8
		0 ... 100						1531267	SDAT-MHS-M100-1L-SA-E-Q3-M8
		0 ... 125						1531268	SDAT-MHS-M125-1L-SA-E-Q3-M8
		0 ... 160						1531269	SDAT-MHS-M160-1L-SA-E-Q3-M8

Festo - Your Partner in Automation



1 Festo Inc.
5300 Explorer Drive
Mississauga, ON L4W 5G4
Canada

Festo Customer Interaction Center
Tel: 1 877 463 3786
Fax: 1 877 393 3786
Email: customer.service.ca@festo.com



2 Festo Pneumatic
Av. Ceylán 3,
Col. Tequesquináhuac
54020 Tlalnepantla,
Estado de México

Multinational Contact Center
01 800 337 8669
ventas.mexico@festo.com



3 Festo Corporation
1377 Motor Parkway
Suite 310
Islandia, NY 11749

Festo Customer Interaction Center
1 800 993 3786
1 800 963 3786
customer.service.us@festo.com



4 Regional Service Center
7777 Columbia Road
Mason, OH 45040

Connect with us



www.festo.com/socialmedia



www.festo.com

Subject to change