

轴向安装组件 EAMM-A

FESTO

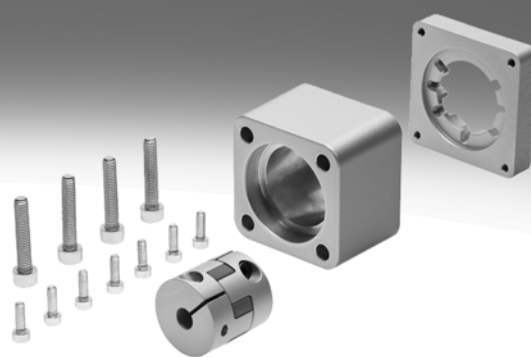

q / w

Festo 核心产品范围
涵盖您自动化应用的 80%

全球: 始终备有库存
一流: Festo 质量水准, 优惠的价格
简单: 简化采购和仓储

q 24 小时内从 Festo 工厂发出
全球 13 个服务中心备有库存
超过 2200 种产品。

w 最多 5 天内发货
全球 4 个服务中心为您提供装配服务
每个产品系列最多有 6×10^{12} 个派生型



轴向安装组件 EAMM-A

型号代码

FESTO

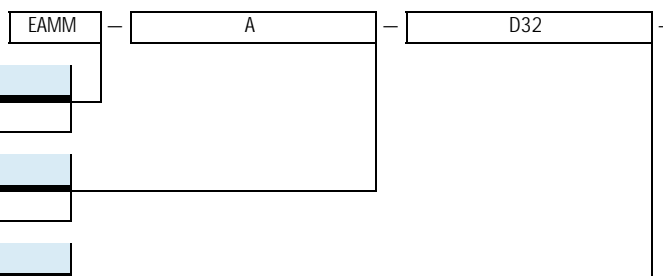

型号

EAMM	组件
------	----

电机布局

A	轴向
---	----

气缸机械接口

D19	EGSL-35
D32	ESBF-32, EGSL-45, ERMB-20, EHMB-20
D32-35A	ERMB-20, EHMB-20
D40	ESBF-40, EGSL-55, ERMB-25, EHMB-25
D50	ESBF-50
D60	ESBF-63, EGSL-75, ERMB-32, EHMB-32
D80	ESBF-80
D100	ESBF-100
E20	DGE-18-...-SP, DMES-18
E32	DGE-25-...-SP, DMES-25
E48	DGE-40-...-SP, DMES-40
E72	DGE-63-...-SP, DMES-63
F28	DGEA-18
F30	DGE-25-...-ZR
F32	DGEA-25
F37	DGE-25-...-ZR-RF
F40	DGE-40-...-ZR, DGEA-40
F47	DGE-40-...-ZR-RF
F62	DGE-63-...-ZR
F80	DGE-63-...-ZR-RF
G13	DGE-8-...-ZR
G16	DGE-12-...-ZR
G19	DGE-18-...-ZR
L27	EGC-50-...-TB
L38	EGC-70-...-TB
L48	EGC-80-...-TB
L62	EGC-120-...-TB
L95	EGC-185-...-TB
M43	EGC-HD-125-...-TB
M48	EGC-HD-160-...-TB
M80	EGC-HD-220-...-TB
N38	ELGA-TB-...-70
N48	ELGA-TB-...-80
N80	ELGA-TB-...-120
L95	ELGA-TB-...-150
P3-28D	EGSK-15
P4-28B	EGSK-20/EGSP-20
P5-28B	EGSK-26/EGSP-26
P6-38A	EGSK-33
P8-38A	EGSK-46, EGSP-33
P10-38A	EGSP-46
R27	ELGG-...-35, ELGR-...-35
R38	ELGG-...-45, ELGR-...-45
R48	ELGG-...-55, ELGR-...-55
S38	EGC-70-...-BS, EGC-HD-125-...-BS, ELGA-BS-...-70
S48	EGC-80-...-BS, EGC-HD-160-...-BS, ELGA-BS-...-80
S62	EGC-120-...-BS, EGC-HD-220-...-BS, ELGA-BS-...-120
S95	EGC-185-...-BS, ELGA-BS-...-150

轴向安装组件 EAMM-A

型号代码

FESTO

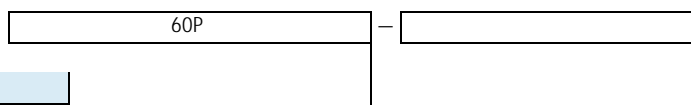

电机接口

40P	伺服电机 EMME-AS-40
60P	伺服电机 EMME-AS-60
80P	伺服电机 EMME-AS-80
40A	伺服电机 EMMS-AS-40
55A	伺服电机 EMMS-AS-55
70A	伺服电机 EMMS-AS-70
100A	伺服电机 EMME-AS-100, EMMS-AS-100
140A	伺服电机 EMMS-AS-140
190A	伺服电机 EMMS-AS-190
28A	步进电机 EMMS-ST-28
42A	步进电机 EMMS-ST-42
57A	步进电机 EMMS-ST-57
87A	步进电机 EMMS-ST-87
32B	电机单元 MTR-DCI-32-...-G7/G14
42B	电机单元 MTR-DCI-42-...-G7
42C	电机单元 MTR-DCI-42-...-G14
52B	电机单元 MTR-DCI-52-...-G7
52C	电机单元 MTR-DCI-52-...-G14
67A	一体式电机 EMCA-EC-67
40G	减速机 EMGA-40, EMGC-40
60G	减速机 EMGA-60-...-SAS/SST
60H	减速机 EMGA-60-...-EAS, EMGC-60
80G	减速机 EMGA-80
120G	减速机 EMGA-120-...-SAS
160G	减速机 EMGA-160-...-SAS

代别

-	第一代/基本型
G2	第二代/优化壳体几何结构

特殊结构

S1	防护等级 IP65
----	-----------

轴向安装组件 EAMM-A

型号代码

FESTO

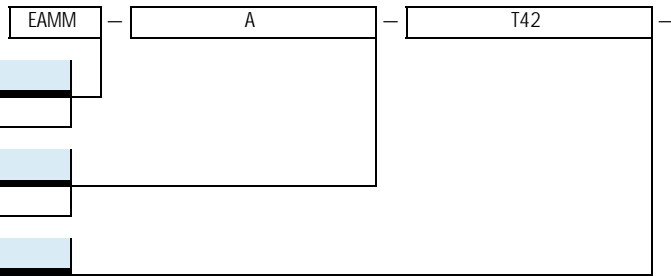

型号

EAMM	组件
------	----

电机布局

A	轴向
---	----

气缸机械接口

V20	EGSC-25
V25	EGSC-32, ELGC-BS-32
V32	EGSC-45, ELGC-BS-45, ELGC-TB-45
T42	EGSC-60, ELGC-BS-60, ELGC-TB-60
T46	ELGC-BS-80, ELGC-TB-80

轴向安装组件 EAMM-A

型号代码

FESTO

57A

电机接口	
40P	伺服电机 EMME-AS-40
60P	伺服电机 EMME-AS-60
80P	伺服电机 EMME-AS-80
100A	伺服电机 EMME-AS-100, EMMS-AS-100
28A	步进电机 EMMS-ST-28
42A	步进电机 EMMS-ST-42
57A	步进电机 EMMS-ST-57
87A	步进电机 EMMS-ST-87

轴向安装组件 EAMM-A

产品范围一览

FESTO

许用电缸/电机组合，用于齿形带式电缸 DGE-ZR

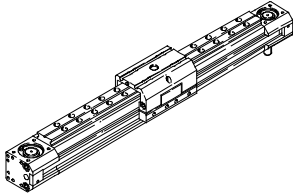

电机/减速机 ¹⁾	轴向安装组件	
型号	订货号	型号
DGE-8-...-ZR		
配伺服电机		
EMMS-AS-40-...	550921	EAMM-A-G13-40A
配步进电机		
EMMS-ST-42-...	550922	EAMM-A-G13-42A
DGE-12-...-ZR		
配伺服电机		
EMMS-AS-40-...	550923	EAMM-A-G16-40A
EMMS-AS-55-...	550925	EAMM-A-G16-55A
配步进电机		
EMMS-ST-42-...	550924	EAMM-A-G16-42A
DGE-18-...-ZR		
配伺服电机		
EMMS-AS-40-...	550926	EAMM-A-G19-40A
EMMS-AS-55-...	550927	EAMM-A-G19-55A
配伺服电机和减速机		
EMME-AS-40-...	1454259	EAMM-A-G19-40G
EMGA-40-P-G...-EAS-40		
EMMS-AS-40-...	1454259	EAMM-A-G19-40G
EMGA-40-P-G...-SAS-40		
配步进电机		
EMMS-ST-57-...	550928	EAMM-A-G19-57A
配步进电机和减速机		
EMMS-ST-42-...	1454259	EAMM-A-G19-40G
EMGA-40-P-G...-SST-42		
配一体式电机		
EMCA-EC-67-...	1454260	EAMM-A-G19-67A
配一体式电机和减速机		
EMCA-EC-67-...	1454259	EAMM-A-G19-40G
EMGC-40-...		

电机/减速机 ¹⁾	轴向安装组件	
型号	订货号	型号
DGE-25-...-ZR		
配伺服电机		
EMMS-AS-55-...	550929	EAMM-A-F30-55A
EMMS-AS-70-...	550932	EAMM-A-F30-70A
配伺服电机和减速机		
EMME-AS-40-...	1454254	EAMM-A-F30-40G
EMGA-40-P-G...-EAS-40		
EMMS-AS-40-...	1454254	EAMM-A-F30-40G
EMGA-40-P-G...-SAS-40		
EMMS-AS-55-...	550931	EAMM-A-F30-60G
EMGA-60-P-G...-SAS-55		
EMME-AS-60-...	1454255	EAMM-A-F30-60H
EMGA-60-P-G...-EAS-60		
EMMS-AS-70-...	550931	EAMM-A-F30-60G
EMGA-60-P-G...-SAS-70		
配步进电机		
EMMS-ST-57-...	550930	EAMM-A-F30-57A
EMMS-ST-87-...	550933	EAMM-A-F30-87A
配步进电机和减速机		
EMMS-ST-42-...	1454254	EAMM-A-F30-40G
EMGA-40-P-G...-SST-42		
EMMS-ST-57-...	550931	EAMM-A-F30-60G
EMGA-60-P-G...-SST-57		
配一体式电机和减速机		
EMCA-EC-67-...	1454254	EAMM-A-F30-40G
EMGC-40-...		
EMCA-EC-67-...	1454255	EAMM-A-F30-60H
EMGC-60-...		

1) 输入扭矩不得超过轴向安装组件的最大可传递扭矩。

轴向安装组件 EAMM-A

产品范围一览

许用电缸/电机组合，用于齿形带式电缸 DGE-ZR

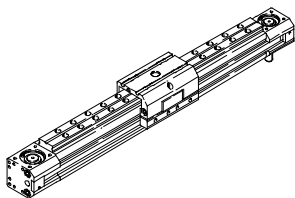

电机/减速机 ¹⁾	轴向安装组件	
型号	订货号	型号
DGE-25-...-ZR-RF		
配伺服电机		
EMMS-AS-55-...	550942	EAMM-A-F37-55A
EMMS-AS-70-...	550945	EAMM-A-F37-70A
配伺服电机和减速机		
EMME-AS-40-...	1454257	EAMM-A-F37-40G
EMGA-40-P-G...-EAS-40		
EMMS-AS-40-...	1454257	EAMM-A-F37-40G
EMGA-40-P-G...-SAS-40		
EMMS-AS-55-...	550944	EAMM-A-F37-60G
EMGA-60-P-G...-SAS-55		
EMME-AS-60-...	1454258	EAMM-A-F37-60H
EMGA-60-P-G...-EAS-60		
EMMS-AS-70-...	550944	EAMM-A-F37-60G
EMGA-60-P-G...-SAS-70		
配步进电机		
EMMS-ST-57-...	550943	EAMM-A-F37-57A
EMMS-ST-87-...	550946	EAMM-A-F37-87A
配步进电机和减速机		
EMMS-ST-42-...	1454257	EAMM-A-F37-40G
EMGA-40-P-G...-SST-42		
EMMS-ST-57-...	550944	EAMM-A-F37-60G
EMGA-60-P-G...-SST-57		
配一体式电机和减速机		
EMCA-EC-67-...	1454257	EAMM-A-F37-40G
EMGC-40-...		
EMCA-EC-67-...	1454258	EAMM-A-F37-60H
EMGC-60-...		

电机/减速机 ¹⁾	轴向安装组件	
型号	订货号	型号
DGE-40-...-ZR		
配伺服电机		
EMMS-AS-70-...	550934	EAMM-A-F40-70A
EMME-AS-100-...	550937	EAMM-A-F40-100A
EMMS-AS-100-...	550937	EAMM-A-F40-100A
配伺服电机和减速机		
EMMS-AS-70-...	550935	EAMM-A-F40-80G
EMGA-80-P-G...-SAS-70		
EMME-AS-80-...	550935	EAMM-A-F40-80G
EMGA-80-P-G...-EAS-80		
EMME-AS-100-...	550935	EAMM-A-F40-80G
EMGA-80-P-G...-SAS-100		
EMMS-AS-100-...	550935	EAMM-A-F40-80G
EMGA-80-P-G...-SAS-100		
配步进电机		
EMMS-ST-87-...	550936	EAMM-A-F40-87A
配步进电机和减速机		
EMMS-ST-87-...	550935	EAMM-A-F40-80G
EMGA-80-P-G...-SST-87		
DGE-40-...-ZR-RF		
配伺服电机		
EMME-AS-100-...	550949	EAMM-A-F47-100A
EMMS-AS-100-...	550949	EAMM-A-F47-100A
EMMS-AS-140-...	550950	EAMM-A-F47-140A
配伺服电机和减速机		
EMMS-AS-70-...	550947	EAMM-A-F47-80G
EMGA-80-P-G...-SAS-70		
EMME-AS-80-...	550947	EAMM-A-F47-80G
EMGA-80-P-G...-EAS-80		
EMME-AS-100-...	550947	EAMM-A-F47-80G
EMGA-80-P-G...-SAS-100		
EMMS-AS-100-...	550947	EAMM-A-F47-80G
EMGA-80-P-G...-SAS-100		
配步进电机		
EMMS-ST-87-...	550948	EAMM-A-F47-87A
配步进电机和减速机		
EMMS-ST-87-...	550947	EAMM-A-F47-80G
EMGA-80-P-G...-SST-87		

1) 输入扭矩不得超过轴向安装组件的最大可传递扭矩。

轴向安装组件 EAMM-A

产品范围一览

FESTO

许用电缸/电机组合，用于齿形带式电缸 DGE-ZR

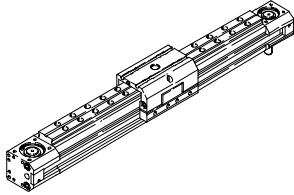

电机/减速机 ¹⁾	轴向安装组件	
型号	订货号	型号
DGE-63-...-ZR		
配伺服电机		
EMME-AS-100-...	550939	EAMM-A-F62-100A
EMMS-AS-100-...	550939	EAMM-A-F62-100A
EMMS-AS-140-...	550941	EAMM-A-F62-140A
配伺服电机和减速机		
EMMS-AS-70-...	550938	EAMM-A-F62-80G
EMGA-80-P-G...-SAS-70		
EMME-AS-80-...	550938	EAMM-A-F62-80G
EMGA-80-P-G...-EAS-80		
EMME-AS-100-...	550938	EAMM-A-F62-80G
EMGA-80-P-G...-SAS-100		
EMMS-AS-100-...	550938	EAMM-A-F62-80G
EMGA-80-P-G...-SAS-100		
EMME-AS-100-...	550940	EAMM-A-F62-120G
EMGA-120-P-G...-SAS-100		
EMMS-AS-100-...	550940	EAMM-A-F62-120G
EMGA-120-P-G...-SAS-100		
EMMS-AS-140-...	550940	EAMM-A-F62-120G
EMGA-120-P-G...-SAS-140		
配步进电机和减速机		
EMMS-ST-87-...	550938	EAMM-A-F62-80G
EMGA-80-P-G...-SST-87		

电机/减速机 ¹⁾	轴向安装组件	
型号	订货号	型号
DGE-63-...-ZR-RF		
配伺服电机		
EMME-AS-100-...	550952	EAMM-A-F80-100A
EMMS-AS-100-...	550952	EAMM-A-F80-100A
EMMS-AS-140-...	550954	EAMM-A-F80-140A
配伺服电机和减速机		
EMMS-AS-70-...	550951	EAMM-A-F80-80G
EMGA-80-P-G...-SAS-70		
EMME-AS-80-...	550951	EAMM-A-F80-80G
EMGA-80-P-G...-EAS-80		
EMME-AS-100-...	550951	EAMM-A-F80-80G
EMGA-80-P-G...-SAS-100		
EMMS-AS-100-...	550951	EAMM-A-F80-80G
EMGA-80-P-G...-SAS-100		
EMME-AS-100-...	550953	EAMM-A-F80-120G
EMGA-120-P-G...-SAS-100		
EMMS-AS-100-...	550953	EAMM-A-F80-120G
EMGA-120-P-G...-SAS-100		
EMMS-AS-140-...	550953	EAMM-A-F80-120G
EMGA-120-P-G...-SAS-140		
EMMS-AS-140-...	550955	EAMM-A-F80-160G
EMGA-160-P-G...-SAS-140		
配步进电机和减速机		
EMMS-ST-87-...	550951	EAMM-A-F80-80G
EMGA-80-P-G...-SST-87		

1) 输入扭矩不得超过轴向安装组件的最大可传递扭矩。

轴向安装组件 EAMM-A

产品范围一览

许用电缸/电机组合，用于丝杆式电缸 DGE-SP

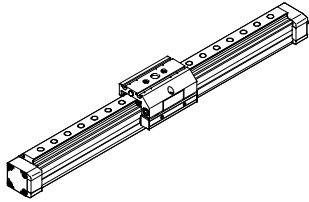

电机/减速机 ¹⁾	轴向安装组件	
型号	订货号	型号
DGE-18		
配伺服电机		
EMMS-AS-40-...	550961	EAMM-A-E20-40A
EMMS-AS-55-...	550963	EAMM-A-E20-55A
配步进电机		
EMMS-ST-42-...	550962	EAMM-A-E20-42A
DGE-25		
配伺服电机		
EMMS-AS-40-...	550964	EAMM-A-E32-40A
EMMS-AS-55-...	550965	EAMM-A-E32-55A
配伺服电机和减速机		
EMME-AS-40-...	1454247	EAMM-A-E32-40G
EMGA-40-P-G...-EAS-40		
EMMS-AS-40-...	1454247	EAMM-A-E32-40G
EMGA-40-P-G...-SAS-40		
配步进电机		
EMMS-ST-57-...	550966	EAMM-A-E32-57A
配步进电机和减速机		
EMMS-ST-42-...	1454247	EAMM-A-E32-40G
EMGA-40-P-G...-SST-42		
配一体式电机		
EMCA-EC-67-...	1454246	EAMM-A-E32-67A
配一体式电机和减速机		
EMCA-EC-67-...	1454247	EAMM-A-E32-40G
EMGC-40-...		

电机/减速机 ¹⁾	轴向安装组件	
型号	订货号	型号
DGE-40		
配伺服电机		
EMMS-AS-55-...	550969	EAMM-A-E48-55A
EMMS-AS-70-...	550971	EAMM-A-E48-44A-70A
EMME-AS-100-...	550973	EAMM-A-E48-100A
EMMS-AS-100-...	550973	EAMM-A-E48-100A
配伺服电机和减速机		
EMME-AS-40-...	550968	EAMM-A-E48-40G
EMGA-40-P-G...-EAS-40		
EMMS-AS-40-...	550968	EAMM-A-E48-40G
EMGA-40-P-G...-SAS-40		
EMME-AS-60-...	1454249	EAMM-A-E48-60H
EMGA-60-P-G...-EAS-60		
配步进电机		
EMMS-ST-57-...	550970	EAMM-A-E48-57A
EMMS-ST-87-...	550972	EAMM-A-E48-87A
配步进电机和减速机		
EMMS-ST-42-...	550968	EAMM-A-E48-40G
EMGA-40-P-G...-SST-42		
配一体式电机和减速机		
EMCA-EC-67-...	550968	EAMM-A-E48-40G
EMGC-40-...		
EMCA-EC-67-...	1454249	EAMM-A-E48-60H
EMGC-60-...		

1) 输入扭矩不得超过轴向安装组件的最大可传递扭矩。

轴向安装组件 EAMM-A

产品范围一览

FESTO

许用电缸/电机组合，用于丝杆式电缸 DGE-SP

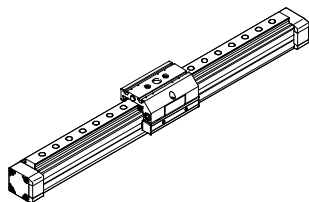

电机/减速机 ¹⁾	轴向安装组件	
型号	订货号	型号
DGE-63		
配伺服电机		
EMMS-AS-70-...	550975	EAMM-A-E72-70A
EMME-AS-100-...	550978	EAMM-A-E72-100A
EMMS-AS-100-...	550978	EAMM-A-E72-100A
配伺服电机和减速机		
EMMS-AS-55-...	550974	EAMM-A-E72-60G
EMGA-60-P-G...-SAS-55		
EMME-AS-60-...	1454250	EAMM-A-E72-60H
EMGA-60-P-G...-EAS-60		
EMMS-AS-70-...	550974	EAMM-A-E72-60G
EMGA-60-P-G...-SAS-70		
EMMS-AS-70-...	550976	EAMM-A-E72-80G
EMGA-80-P-G...-SAS-70		
EMME-AS-80-...	550976	EAMM-A-E72-80G
EMGA-80-P-G...-EAS-80		
EMME-AS-100-...	550976	EAMM-A-E72-80G
EMGA-80-P-G...-SAS-100		
EMMS-AS-100-...	550976	EAMM-A-E72-80G
EMGA-80-P-G...-SAS-100		
配步进电机		
EMMS-ST-87-...	550977	EAMM-A-E72-87A
配步进电机和减速机		
EMMS-ST-57-...	550974	EAMM-A-E72-60G
EMGA-60-P-G...-SST-57		
EMMS-ST-87-...	550976	EAMM-A-E72-80G
EMGA-80-P-G...-SST-87		
配一体式电机和减速机		
EMCA-EC-67-...	1454250	EAMM-A-E72-60H
EMGC-60-...		

1) 输入扭矩不得超过轴向安装组件的最大可传递扭矩。

轴向安装组件 EAMM-A

产品范围一览

许用电缸/电机组合，用于定位轴 DMES

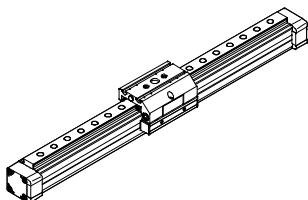

电机/减速机 ¹⁾	轴向安装组件	
型号	订货号	型号
DMES-18		
配伺服电机		
EMMS-AS-40-...	550961	EAMM-A-E20-40A
EMMS-AS-55-...	550963	EAMM-A-E20-55A
配步进电机		
EMMS-ST-42-...	550962	EAMM-A-E20-42A
配电机单元		
MTR-DCI-32S-...	556991	EAMM-A-E20-32B
DMES-25		
配伺服电机		
EMMS-AS-40-...	550964	EAMM-A-E32-40A
EMMS-AS-55-...	550965	EAMM-A-E32-55A
配伺服电机和减速机		
EMME-AS-40-...	1454247	EAMM-A-E32-40G
EMGA-40-P-G...-EAS-40		
EMMS-AS-40-...	1454247	EAMM-A-E32-40G
EMGA-40-P-G...-SAS-40		
配步进电机		
EMMS-ST-57-...	550966	EAMM-A-E32-57A
配步进电机和减速机		
EMMS-ST-42-...	1454247	EAMM-A-E32-40G
EMGA-40-P-G...-SST-42		
配一体式电机		
EMCA-EC-67-...	1454246	EAMM-A-E32-67A
配电机单元		
MTR-DCI-42S-...G7	556992	EAMM-A-E32-42B
MTR-DCI-42S-...G14	556993	EAMM-A-E32-42C
配一体式电机和减速机		
EMCA-EC-67-...	1454247	EAMM-A-E32-40G
EMGC-40-...		
DMES-40		
配伺服电机		
EMMS-AS-70-...	557448	EAMM-A-E48-64A-70A
EMME-AS-100-...	550973	EAMM-A-E48-100A
EMMS-AS-100-...	550973	EAMM-A-E48-100A
配步进电机		
EMMS-ST-57-...	550970	EAMM-A-E48-57A
EMMS-ST-87-...	550972	EAMM-A-E48-87A
配一体式电机		
EMCA-EC-67-...	1454248	EAMM-A-E48-67A
配电机单元		
MTR-DCI-52S-...G7	556994	EAMM-A-E48-52B
MTR-DCI-52S-...G14	556995	EAMM-A-E48-52C
配一体式电机和减速机		
EMCA-EC-67-...	1454249	EAMM-A-E48-60H
EMGC-60-...		

电机/减速机 ¹⁾	轴向安装组件	
型号	订货号	型号
DMES-63		
配伺服电机		
EMMS-AS-70-...	550975	EAMM-A-E72-70A
EMME-AS-100-...	550978	EAMM-A-E72-100A
EMMS-AS-100-...	550978	EAMM-A-E72-100A
配伺服电机和减速机		
EMMS-AS-55-...	550974	EAMM-A-E72-60G
EMGA-60-P-G...-SAS-55		
EMME-AS-60-...	1454250	EAMM-A-E72-60H
EMGA-60-P-G...-EAS-60		
EMMS-AS-70-...	550974	EAMM-A-E72-60G
EMGA-60-P-G...-SAS-70		
EMMS-AS-70-...	550976	EAMM-A-E72-80G
EMGA-80-P-G...-SAS-70		
EMME-AS-80-...	550976	EAMM-A-E72-80G
EMGA-80-P-G...-EAS-80		
EMME-AS-100-...	550976	EAMM-A-E72-80G
EMGA-80-P-G...-SAS-100		
EMMS-AS-100-...	550976	EAMM-A-E72-80G
EMGA-80-P-G...-SAS-100		
配步进电机		
EMMS-ST-87-...	550977	EAMM-A-E72-87A
配步进电机和减速机		
EMMS-ST-57-...	550974	EAMM-A-E72-60G
EMGA-60-P-G...-SST-57		
EMMS-ST-87-...	550976	EAMM-A-E72-80G
EMGA-80-P-G...-SST-87		
配一体式电机和减速机		
EMCA-EC-67-...	1454250	EAMM-A-E72-60H
EMGC-60-...		

1) 输入扭矩不得超过轴向安装组件的最大可传递扭矩。

轴向安装组件 EAMM-A

产品范围一览

FESTO

许用电缸/电机组合，用于有杆电缸 ESBF

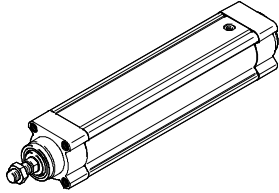

电机/减速机 ¹⁾	轴向安装组件	
型号	订货号	型号
ESBF-32		
配伺服电机		
EMME-AS-40-...	1976465	EAMM-A-D32-40P
	2207372	EAMM-A-D32-40P-S1 ²⁾
EMMS-AS-40-...	543147	EAMM-A-D32-40A
	1322178	EAMM-A-D32-40A-S1 ²⁾
EMMS-AS-55-...	550979	EAMM-A-D32-55A
	1322180	EAMM-A-D32-55A-S1 ²⁾
EMME-AS-60-...	1956054	EAMM-A-D32-60P
	2234020	EAMM-A-D32-60P-S1 ²⁾
配伺服电机和减速机		
EMME-AS-40-...	1454238	EAMM-A-D32-40G
EMGA-40-P-G...-EAS-40	2256396	EAMM-A-D32-40G-S1 ²⁾
EMMS-AS-40-...	1454238	EAMM-A-D32-40G
EMGA-40-P-G...-SAS-40	2256396	EAMM-A-D32-40G-S1 ²⁾
EMMS-AS-55-...	2946758	EAMM-A-D32-60G
EMGA-60-P-G...-SAS-55	2946759	EAMM-A-D32-60G-S1 ²⁾
EMME-AS-60-...	2946760	EAMM-A-D32-60H
EMGA-60-P-G...-EAS-60	2946761	EAMM-A-D32-60H-S1 ²⁾
EMMS-AS-70-...	2946758	EAMM-A-D32-60G
EMGA-60-P-G...-SAS-70	2946759	EAMM-A-D32-60G-S1 ²⁾
配步进电机		
EMMS-ST-42-...	543148	EAMM-A-D32-42A
	1322179	EAMM-A-D32-42A-S1 ²⁾
EMMS-ST-57-...	550980	EAMM-A-D32-57A
	1322181	EAMM-A-D32-57A-S1 ²⁾
配步进电机和减速机		
EMMS-ST-42-...	1454238	EAMM-A-D32-40G
EMGA-40-P-G...-SST-42	2256396	EAMM-A-D32-40G-S1 ²⁾
EMMS-ST-57-...	2946758	EAMM-A-D32-60G
EMGA-60-P-G...-SST-57	2946759	EAMM-A-D32-60G-S1 ²⁾
配一体式电机		
EMCA-EC-67-...	1454239	EAMM-A-D32-67A
	2256397	EAMM-A-D32-67A-S1 ²⁾
配一体式电机和减速机		
EMCA-EC-67-...	1454238	EAMM-A-D32-40G
EMGC-40-...	2256396	EAMM-A-D32-40G-S1 ²⁾
EMCA-EC-67-...	2946760	EAMM-A-D32-60H
EMGC-60-...	2946761	EAMM-A-D32-60H-S1 ²⁾

电机/减速机 ¹⁾	轴向安装组件	
型号	订货号	型号
ESBF-40		
配伺服电机		
EMMS-AS-55-...	543153	EAMM-A-D40-55A
	1322182	EAMM-A-D40-55A-S1 ²⁾
EMME-AS-60-...	1977000	EAMM-A-D40-60P
	2151519	EAMM-A-D40-60P-S1 ²⁾
EMMS-AS-70-...	550981	EAMM-A-D40-70A
	1322185	EAMM-A-D40-70A-S1 ²⁾
配伺服电机和减速机		
EMME-AS-40-...	2256398	EAMM-A-D40-40G-G2
EMGA-40-P-G...-EAS-40	2256399	EAMM-A-D40-40G-S1 ²⁾
EMMS-AS-40-...	2256398	EAMM-A-D40-40G-G2
EMGA-40-P-G...-SAS-40	2256399	EAMM-A-D40-40G-S1 ²⁾
EMMS-AS-55-...	2256400	EAMM-A-D40-60G
EMGA-60-P-G...-SAS-55	2256409	EAMM-A-D40-60G-S1 ²⁾
EMME-AS-60-...	1454242	EAMM-A-D40-60H
EMGA-60-P-G...-EAS-60	2256401	EAMM-A-D40-60H-S1 ²⁾
EMMS-AS-70-...	2256400	EAMM-A-D40-60G
EMGA-60-P-G...-SAS-70	2256409	EAMM-A-D40-60G-S1 ²⁾
配步进电机		
EMMS-ST-57-...	543154	EAMM-A-D40-57A
	1322183	EAMM-A-D40-57A-S1 ²⁾
EMMS-ST-87-...	550982	EAMM-A-D40-87A
	1322186	EAMM-A-D40-87A-S1 ²⁾
配步进电机和减速机		
EMMS-ST-42-...	2256398	EAMM-A-D40-40G-G2
EMGA-40-P-G...-SST-42	2256399	EAMM-A-D40-40G-S1 ²⁾
EMMS-ST-57-...	2256400	EAMM-A-D40-60G
EMGA-60-P-G...-SST-57	2256409	EAMM-A-D40-60G-S1 ²⁾
配一体式电机		
EMCA-EC-67-...	1454243	EAMM-A-D40-67A
	2256695	EAMM-A-D40-67A-S1 ²⁾
配一体式电机和减速机		
EMCA-EC-67-...	2256398	EAMM-A-D40-40G-G2
EMGC-40-...	2256399	EAMM-A-D40-40G-S1 ²⁾
EMCA-EC-67-...	1454242	EAMM-A-D40-60H
EMGC-60-...	2256401	EAMM-A-D40-60H-S1 ²⁾

- 1) 输入扭矩不得超过轴向安装组件的最大可传递扭矩。
2) 防护等级 IP65

Festo 核心产品范围

q 24 小时内从 Festo 工厂发出
w 最多 5 天内发货

轴向安装组件 EAMM-A

产品范围一览

FESTO

许用电缸/电机组合，用于有杆电缸 ESBF

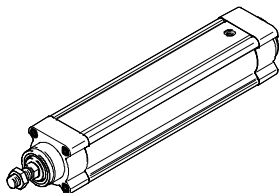

电机/减速机 ¹⁾	轴向安装组件	
型号	订货号	型号
ESBF-50		
配伺服电机		
EMMS-AS-70-...	2733783	EAMM-A-D50-70A
	2734287	EAMM-A-D50-70A-S1 ²⁾
EMME-AS-80-...	√2733785	EAMM-A-D50-80P
	2734289	EAMM-A-D50-80P-S1 ²⁾
EMME-AS-100-...	√2733784	EAMM-A-D50-100A
	2734288	EAMM-A-D50-100A-S1 ²⁾
EMMS-AS-100-...	√2733784	EAMM-A-D50-100A
	2734288	EAMM-A-D50-100A-S1 ²⁾
配伺服电机和减速机		
EMMS-AS-55-...	2733786	EAMM-A-D50-60G
EMGA-60-P-G...-SAS-55	2734290	EAMM-A-D50-60G-S1 ²⁾
EMME-AS-60-...	2733796	EAMM-A-D50-60H
EMGA-60-P-G...-EAS-60	2907418	EAMM-A-D50-60H-S1 ²⁾
EMMS-AS-70-...	2733786	EAMM-A-D50-60G
EMGA-60-P-G...-SAS-70	2734290	EAMM-A-D50-60G-S1 ²⁾
EMMS-AS-70-...	2733787	EAMM-A-D50-80G
EMGA-80-P-G...-SAS-70	2734291	EAMM-A-D50-80G-S1 ²⁾
EMME-AS-80-...	2733787	EAMM-A-D50-80G
EMGA-80-P-G...-EAS-80	2734291	EAMM-A-D50-80G-S1 ²⁾
EMME-AS-100-...	2733787	EAMM-A-D50-80G
EMGA-80-P-G...-SAS-100	2734291	EAMM-A-D50-80G-S1 ²⁾
EMMS-AS-100-...	2733787	EAMM-A-D50-80G
EMGA-80-P-G...-SAS-100	2734291	EAMM-A-D50-80G-S1 ²⁾
配步进电机		
EMMS-ST-87-...	√2733781	EAMM-A-D50-87A
	2734286	EAMM-A-D50-87A-S1 ²⁾
配步进电机和减速机		
EMMS-ST-57-...	2733786	EAMM-A-D50-60G
EMGA-60-P-G...-SST-57	2734290	EAMM-A-D50-60G-S1 ²⁾
EMMS-ST-87-...	2733787	EAMM-A-D50-80G
EMGA-80-P-G...-SST-87	2734291	EAMM-A-D50-80G-S1 ²⁾
配一体式电机和减速机		
EMCA-EC-67-...	2733796	EAMM-A-D50-60H
EMGC-60-...	2907418	EAMM-A-D50-60H-S1 ²⁾

电机/减速机 ¹⁾	轴向安装组件	
型号	订货号	型号
ESBF-63		
配伺服电机		
EMMS-AS-70-...	543161	EAMM-A-D60-70A
	2256699	EAMM-A-D60-70A-S1 ²⁾
EMME-AS-80-...	√1977073	EAMM-A-D60-80P
	2218564	EAMM-A-D60-80P-S1 ²⁾
EMME-AS-100-...	√550983	EAMM-A-D60-100A
	2256700	EAMM-A-D60-100A-S1 ²⁾
EMMS-AS-100-...	√550983	EAMM-A-D60-100A
	2256700	EAMM-A-D60-100A-S1 ²⁾
配伺服电机和减速机		
EMMS-AS-55-...	2256696	EAMM-A-D60-60G-G2
EMGA-60-P-G...-SAS-55	2256698	EAMM-A-D60-60G-S1 ²⁾
EMME-AS-60-...	1454245	EAMM-A-D60-60H
EMGA-60-P-G...-EAS-60	2256697	EAMM-A-D60-60H-S1 ²⁾
EMMS-AS-70-...	2256696	EAMM-A-D60-60G-G2
EMGA-60-P-G...-SAS-70	2256698	EAMM-A-D60-60G-S1 ²⁾
EMMS-AS-70-...	1499402	EAMM-A-D60-80G
EMGA-80-P-G...-SAS-70	2946762	EAMM-A-D60-80G-S1 ²⁾
EMME-AS-80-...	1499402	EAMM-A-D60-80G
EMGA-80-P-G...-EAS-80	2946762	EAMM-A-D60-80G-S1 ²⁾
EMME-AS-100-...	1499402	EAMM-A-D60-80G
EMGA-80-P-G...-SAS-100	2946762	EAMM-A-D60-80G-S1 ²⁾
EMMS-AS-100-...	1499402	EAMM-A-D60-80G
EMGA-80-P-G...-SAS-100	2946762	EAMM-A-D60-80G-S1 ²⁾
配步进电机		
EMMS-ST-87-...	√543162	EAMM-A-D60-87A
	1322188	EAMM-A-D60-87A-S1 ²⁾
配步进电机和减速机		
EMMS-ST-57-...	2256696	EAMM-A-D60-60G-G2
EMGA-60-P-G...-SST-57	2256698	EAMM-A-D60-60G-S1 ²⁾
EMMS-ST-87-...	1499402	EAMM-A-D60-80G
EMGA-80-P-G...-SST-87	2946762	EAMM-A-D60-80G-S1 ²⁾
配一体式电机和减速机		
EMCA-EC-67-...	1454245	EAMM-A-D60-80H
EMGC-60-...	2256697	EAMM-A-D60-80H-S1 ²⁾

1) 输入扭矩不得超过轴向安装组件的最大可传递扭矩。

2) 防护等级 IP65

Festo 核心产品范围

q 24 小时内从 Festo 工厂发出

√ 最多 5 天内发货

轴向安装组件 EAMM-A

产品范围一览

FESTO

许用电缸/电机组合，用于有杆电缸 ESBF

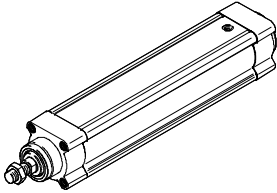

电机/减速机 ¹⁾	轴向安装组件	
型号	订货号	型号
ESBF-80		
配伺服电机		
EMME-AS-100-...	1589665	EAMM-A-D80-100A
	1600673	EAMM-A-D80-100A-S1 ²⁾
EMMS-AS-100-...	1589665	EAMM-A-D80-100A
	1600673	EAMM-A-D80-100A-S1 ²⁾
EMMS-AS-140-...	1588299	EAMM-A-D80-140A
	1600674	EAMM-A-D80-140A-S1 ²⁾
配伺服电机和减速机		
EMMS-AS-70-...	2946763	EAMM-A-D80-80G
EMGA-80-P-G...-SAS-70	2946764	EAMM-A-D80-80G-S1 ²⁾
EMME-AS-80-...	2946763	EAMM-A-D80-80G
EMGA-80-P-G...-EAS-80	2946764	EAMM-A-D80-80G-S1 ²⁾
EMME-AS-100-...	2946763	EAMM-A-D80-80G
EMGA-80-P-G...-SAS-100	2946764	EAMM-A-D80-80G-S1 ²⁾
EMMS-AS-100-...	2946763	EAMM-A-D80-80G
EMGA-80-P-G...-SAS-100	2946764	EAMM-A-D80-80G-S1 ²⁾
配步进电机和减速机		
EMMS-ST-87-...	2946763	EAMM-A-D80-80G
EMGA-80-P-G...-SST-87	2946764	EAMM-A-D80-80G-S1 ²⁾

电机/减速机 ¹⁾	轴向安装组件	
型号	订货号	型号
ESBF-100		
配伺服电机		
EMME-AS-100-...	3356796	EAMM-A-D100-100A
	3356931	EAMM-A-D100-100A-S1 ²⁾
EMMS-AS-100-...	3356796	EAMM-A-D100-100A
	3356931	EAMM-A-D100-100A-S1 ²⁾
EMMS-AS-140-...	1588349	EAMM-A-D100-140A
	1600675	EAMM-A-D100-140A-S1 ²⁾
配伺服电机和减速机		
EMME-AS-100-...	2449341	EAMM-A-D100-120G
EMGA-120-P-G...-SAS-100	2946765	EAMM-A-D100-120G-S1 ²⁾
EMMS-AS-100-...	2449341	EAMM-A-D100-120G
EMGA-120-P-G...-SAS-100	2946765	EAMM-A-D100-120G-S1 ²⁾
EMMS-AS-140-...	2449341	EAMM-A-D100-120G
EMGA-120-P-G...-SAS-140	2946765	EAMM-A-D100-120G-S1 ²⁾

1) 输入扭矩不得超过轴向安装组件的最大可传递扭矩。

2) 防护等级 IP65

-H- 注意

轴向安装组件（型号代码中无 IP65。
"S1"）可装配密封套件 EADS-F， → 页码 76
从而将防护等级从 IP40 提升至

轴向安装组件 EAMM-A

产品范围一览

许用电缸/电机组合，用于齿形带式电缸 EGC-TB

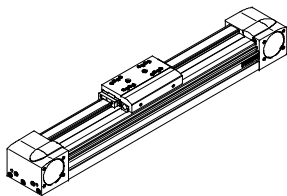

电机/减速机 ¹⁾	轴向安装组件	
型号	订货号	型号
EGC-50		
配伺服电机		
EMMS-AS-55-...	557975	EAMM-A-L27-55A
配伺服电机和减速机		
EMME-AS-40-...	vw557974	EAMM-A-L27-40G
EMGA-40-P-G...-EAS-40		
EMMS-AS-40-...	vw557974	EAMM-A-L27-40G
EMGA-40-P-G...-SAS-40		
配步进电机		
EMMS-ST-57-...	vw560678	EAMM-A-L27-57A
配步进电机和减速机		
EMMS-ST-42-...	vw557974	EAMM-A-L27-40G
EMGA-40-P-G...-SST-42		
配一体式电机		
EMCA-EC-67-...	1454261	EAMM-A-L27-67A
配一体式电机和减速机		
EMCA-EC-67-...	vw557974	EAMM-A-L27-40G
EMGC-40		
EGC-70		
配伺服电机		
EMMS-AS-55-...	3683331	EAMM-A-L38-55A
EMME-AS-60-...	vw2037246	EAMM-A-L38-60P
EMMS-AS-70-...	557979	EAMM-A-L38-70A
配伺服电机和减速机		
EMMS-AS-55-...	vw557978	EAMM-A-L38-60G
EMGA-60-P-G...-SAS-55		
EMME-AS-60-...	1456610	EAMM-A-L38-60H
EMGA-60-P-G...-EAS-60		
EMMS-AS-70-...	vw557978	EAMM-A-L38-60G
EMGA-60-P-G...-SAS-70		
配步进电机		
EMMS-ST-57-...	vw560679	EAMM-A-L38-57A
EMMS-ST-87-...	vw560680	EAMM-A-L38-87A
配步进电机和减速机		
EMMS-ST-57-...	vw557978	EAMM-A-L38-60G
EMGA-60-P-G...-SST-57		
配一体式电机和减速机		
EMCA-EC-67-...	1456610	EAMM-A-L38-60H
EMGC-60-...		

电机/减速机 ¹⁾	轴向安装组件	
型号	订货号	型号
EGC-80		
配伺服电机		
EMMS-AS-70-...	557982	EAMM-A-L48-70A
EMME-AS-80-...	vw2042616	EAMM-A-L48-80P
EMME-AS-100-...	557984	EAMM-A-L48-100A
EMMS-AS-100-...	557984	EAMM-A-L48-100A
配伺服电机和减速机		
EMMS-AS-55-...	vw557983	EAMM-A-L48-60G
EMGA-60-P-G...-SAS-55		
EMME-AS-60-...	1456611	EAMM-A-L48-60H
EMGA-60-P-G...-EAS-60		
EMMS-AS-70-...	vw557983	EAMM-A-L48-60G
EMGA-60-P-G...-SAS-70		
配步进电机		
EMMS-ST-87-...	vw560683	EAMM-A-L48-87A
配步进电机和减速机		
EMMS-ST-57-...	vw557983	EAMM-A-L48-60G
EMGA-60-P-G...-SST-57		
配一体式电机和减速机		
EMCA-EC-67-...	1456611	EAMM-A-L48-60H
EMGC-60-...		

1) 输入扭矩不得超过轴向安装组件的最大可传递扭矩。

Festo 核心产品范围

q 24 小时内从 Festo 工厂发出
vw 最多 5 天内发货

轴向安装组件 EAMM-A

产品范围一览

FESTO

许用电缸/电机组合，用于齿形带式电缸 EGC-TB

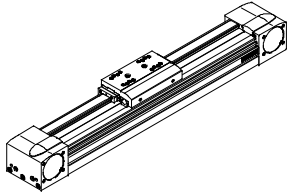

电机/减速机 ¹⁾	轴向安装组件	
型号	订货号	型号
EGC-120		
配伺服电机		
EMME-AS-100-...	W557988	EAMM-A-L62-100A
EMMS-AS-100-...	W557988	EAMM-A-L62-100A
EMMS-AS-140-...	557990	EAMM-A-L62-140A
配伺服电机和减速机		
EMMS-AS-70-...	W557989	EAMM-A-L62-80G
EMGA-80-P-G...-SAS-70		
EMME-AS-80-...	W557989	EAMM-A-L62-80G
EMGA-80-P-G...-EAS-80		
EMME-AS-100-...	W557989	EAMM-A-L62-80G
EMGA-80-P-G...-SAS-100		
EMMS-AS-100-...	W557989	EAMM-A-L62-80G
EMGA-80-P-G...-SAS-100		
配步进电机和减速机		
EMMS-ST-87-...	W557989	EAMM-A-L62-80G
EMGA-80-P-G...-SST-87		

电机/减速机 ¹⁾	轴向安装组件	
型号	订货号	型号
EGC-185		
配伺服电机		
EMMS-AS-140-...	3657226	EAMM-A-L95-140A-G2
EMMS-AS-190-...	3659562	EAMM-A-L95-190A-G2
配伺服电机和减速机		
EMMS-AS-70-...	3660191	EAMM-A-L95-80G-G2
EMGA-80-P-G...-SAS-70		
EMME-AS-80-...	3660191	EAMM-A-L95-80G-G2
EMGA-80-P-G...-EAS-80		
EMME-AS-100-...	3660191	EAMM-A-L95-80G-G2
EMGA-80-P-G...-SAS-100		
EMMS-AS-100-...	3660191	EAMM-A-L95-80G-G2
EMGA-80-P-G...-SAS-100		
EMME-AS-100-...	W3659941	EAMM-A-L95-120G-G2
EMGA-120-P-G...-SAS-100		
EMMS-AS-100-...	W3659941	EAMM-A-L95-120G-G2
EMGA-120-P-G...-SAS-100		
EMMS-AS-140-...	W3659941	EAMM-A-L95-120G-G2
EMGA-120-P-G...-SAS-140		

1) 输入扭矩不得超过轴向安装组件的最大可传递扭矩。

Festo 核心产品范围

q 24 小时内从 Festo 工厂发出

W 最多 5 天内发货

轴向安装组件 EAMM-A

产品范围一览

许用电缸/电机组合，用于丝杆式电缸 EGC-BS

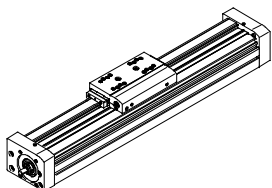

电机/减速机 ¹⁾	轴向安装组件	
型号	订货号	型号
EGC-70		
配伺服电机		
EMME-AS-40-...	vw3637972	EAMM-A-S38-40P-G2
EMMS-AS-40-...	3637971	EAMM-A-S38-40A-G2
EMMS-AS-55-...	3637967	EAMM-A-S38-55A-G2
EMME-AS-60-...	vw3637958	EAMM-A-S38-60P-G2
配伺服电机和减速机		
EMME-AS-40-...	1456647	EAMM-A-S38-40G-G2
EMGA-40-P-G...-EAS-40		
EMMS-AS-40-...	1456647	EAMM-A-S38-40G-G2
EMGA-40-P-G...-SAS-40		
配步进电机		
EMMS-ST-42-...	vw3637965	EAMM-A-S38-42A-G2
EMMS-ST-57-...	vw3637956	EAMM-A-S38-57A-G2
配步进电机和减速机		
EMMS-ST-42-...	1456647	EAMM-A-S38-40G-G2
EMGA-40-P-G...-SST-42		
配一体式电机		
EMCA-EC-67-...	1456638	EAMM-A-S38-67A-G2
配一体式电机和减速机		
EMCA-EC-67-...	1456647	EAMM-A-S38-40G-G2
EMGC-40-...		

电机/减速机 ¹⁾	轴向安装组件	
型号	订货号	型号
EGC-80		
配伺服电机		
EMMS-AS-55-...	3637961	EAMM-A-S48-55A-G2
EMME-AS-60-...	vw3637964	EAMM-A-S48-60P-G2
EMMS-AS-70-...	3637957	EAMM-A-S48-70A-G2
配伺服电机和减速机		
EMME-AS-40-...	1456650	EAMM-A-S48-40G-G2
EMGA-40-P-G...-EAS-40		
EMMS-AS-40-...	1456650	EAMM-A-S48-40G-G2
EMGA-40-P-G...-SAS-40		
EMMS-AS-55-...	2256701	EAMM-A-S48-60G-G2
EMGA-60-P-G...-SAS-55		
EMME-AS-60-...	1456652	EAMM-A-S48-60H-G2
EMGA-60-P-G...-EAS-60		
EMMS-AS-70-...	2256701	EAMM-A-S48-60G-G2
EMGA-60-P-G...-SAS-70		
配步进电机		
EMMS-ST-57-...	vw3637963	EAMM-A-S48-57A-G2
EMMS-ST-87-...	vw3637962	EAMM-A-S48-87A-G2
配步进电机和减速机		
EMMS-ST-42-...	1456650	EAMM-A-S48-40G-G2
EMGA-40-P-G...-SST-42		
EMMS-ST-57-...	2256701	EAMM-A-S48-60G-G2
EMGA-60-P-G...-SST-57		
配一体式电机和减速机		
EMCA-EC-67-...	1456650	EAMM-A-S48-40G-G2
EMGC-40		
EMCA-EC-67-...	1456652	EAMM-A-S48-60H-G2
EMGC-60-...		

1) 输入扭矩不得超过轴向安装组件的最大可传递扭矩。

Festo 核心产品范围

q 24 小时内从 Festo 工厂发出
vw 最多 5 天内发货

轴向安装组件 EAMM-A

产品范围一览

FESTO

许用电缸/电机组合，用于丝杆式电缸 EGC-BS

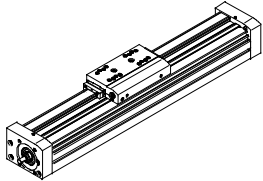

电机/减速机 ¹⁾	轴向安装组件	
型号	订货号	型号
EGC-120		
配伺服电机		
EMMS-AS-70-...	3637959	EAMM-A-S62-70A-G2
EMME-AS-80-...	vw3637970	EAMM-A-S62-80P-G2
EMME-AS-100-...	vw3637960	EAMM-A-S62-100A-G2
EMMS-AS-100-...	vw3637960	EAMM-A-S62-100A-G2
EMMS-AS-140-...	3637969	EAMM-A-S62-140A-G2
配伺服电机和减速机		
EMMS-AS-55-...	2297649	EAMM-A-S62-60G-G2
EMGA-60-P-G...-SAS-55		
EMME-AS-60-...	1456654	EAMM-A-S62-60H-G2
EMGA-60-P-G...-EAS-60		
EMMS-AS-70-...	2297649	EAMM-A-S62-60G-G2
EMGA-60-P-G...-SAS-70		
EMMS-AS-70-...	1972530	EAMM-A-S62-80G-G2
EMGA-80-P-G...-SAS-70		
EMME-AS-80-...	1972530	EAMM-A-S62-80G-G2
EMGA-80-P-G...-EAS-80		
EMME-AS-100-...	1972530	EAMM-A-S62-80G-G2
EMGA-80-P-G...-SAS-100		
EMMS-AS-100-...	1972530	EAMM-A-S62-80G-G2
EMGA-80-P-G...-SAS-100		
配步进电机		
EMMS-ST-87-...	vw3637966	EAMM-A-S62-87A-G2
配步进电机和减速机		
EMMS-ST-57-...	2297649	EAMM-A-S62-60G-G2
EMGA-60-P-G...-SST-57		
EMMS-ST-87-...	1972530	EAMM-A-S62-80G-G2
EMGA-80-P-G...-SST-87		
配一体式电机和减速机		
EMCA-EC-67-...	1456654	EAMM-A-S62-60H-G2
EMGC-60-...		

电机/减速机 ¹⁾	轴向安装组件	
型号	订货号	型号
EGC-185		
配伺服电机		
EMME-AS-100-...	3637955	EAMM-A-S95-100A-G2
EMMS-AS-100-...	3637955	EAMM-A-S95-100A-G2
EMMS-AS-140-...	3637954	EAMM-A-S95-140A-G2

1) 输入扭矩不得超过轴向安装组件的最大可传递扭矩。

Festo 核心产品范围

q 24 小时内从 Festo 工厂发出

vw 最多 5 天内发货

轴向安装组件 EAMM-A

产品范围一览

许用电缸/电机组合，用于齿形带式电缸 ELGA-TB-...

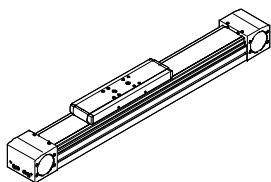

电机/减速机 ¹⁾	轴向安装组件	
型号	订货号	型号
ELGA-TB-...-70		
配伺服电机		
EMMS-AS-70-...	1202331	EAMM-A-N38-70A
配伺服电机和减速机		
EMMS-AS-55-...	vw1202253	EAMM-A-N38-60G
EMGA-60-P-G...-SAS-55		
EMME-AS-60-...	1456616	EAMM-A-N38-60H
EMGA-60-P-G...-EAS-60		
EMMS-AS-70-...	vw1202253	EAMM-A-N38-60G
EMGA-60-P-G...-SAS-70		
配步进电机		
EMMS-ST-87-...	vw3324111	EAMM-A-N38-87A
配步进电机和减速机		
EMMS-ST-57-...	vw1202253	EAMM-A-N38-60G
EMGA-60-P-G...-SST-57		
配一体式电机和减速机		
EMCA-EC-67-...	1456616	EAMM-A-N38-60H
EMGC-60-...		
ELGA-TB-...-80		
配伺服电机		
EMME-AS-100-...	1201894	EAMM-A-N48-100A
EMMS-AS-100-...	1201894	EAMM-A-N48-100A
配伺服电机和减速机		
EMMS-AS-55-...	vw1972527	EAMM-A-N48-60G
EMGA-60-P-G...-SAS-55		
EMME-AS-60-...	1456618	EAMM-A-N48-60H
EMGA-60-P-G...-EAS-60		
EMMS-AS-70-...	vw1972527	EAMM-A-N48-60G
EMGA-60-P-G...-SAS-70		
EMMS-AS-70-...	vw1258793	EAMM-A-N48-80G
EMGA-80-P-G...-SAS-70		
EMME-AS-80-...	vw1258793	EAMM-A-N48-80G
EMGA-80-P-G...-EAS-80		
EMME-AS-100-...	vw1258793	EAMM-A-N48-80G
EMGA-80-P-G...-SAS-100		
EMMS-AS-100-...	vw1258793	EAMM-A-N48-80G
EMGA-80-P-G...-SAS-100		
配步进电机和减速机		
EMMS-ST-57-...	vw1972527	EAMM-A-N48-60G
EMGA-60-P-G...-SST-57		
EMMS-ST-87-...	vw1258793	EAMM-A-N48-80G
EMGA-80-P-G...-SST-87		
配一体式电机和减速机		
EMCA-EC-67-...	1456618	EAMM-A-N48-60H
EMGC-60-...		

电机/减速机 ¹⁾	轴向安装组件	
型号	订货号	型号
ELGA-TB-...-120		
配伺服电机		
EMMS-AS-140-...	1201691	EAMM-A-N80-140A
配伺服电机和减速机		
EMMS-AS-70-...	vw2372096	EAMM-A-N80-80G
EMGA-80-P-G...-SAS-70		
EMME-AS-80-...	vw2372096	EAMM-A-N80-80G
EMGA-80-P-G...-EAS-80		
EMME-AS-100-...	vw2372096	EAMM-A-N80-80G
EMGA-80-P-G...-SAS-100		
EMMS-AS-100-...	vw2372096	EAMM-A-N80-80G
EMGA-80-P-G...-SAS-100		
EMME-AS-100-...	vw1201695	EAMM-A-N80-120G
EMGA-120-P-G...-SAS-100		
EMMS-AS-100-...	vw1201695	EAMM-A-N80-120G
EMGA-120-P-G...-SAS-100		
EMMS-AS-140-...	vw1201695	EAMM-A-N80-120G
EMGA-120-P-G...-SAS-140		
配步进电机和减速机		
EMMS-ST-87-...	vw2372096	EAMM-A-N80-80G
EMGA-80-P-G...-SST-87		
ELGA-TB-...-150		
配伺服电机		
EMMS-AS-140-...	3657226	EAMM-A-L95-140A-G2
EMMS-AS-190-...	3659562	EAMM-A-L95-190A-G2
配伺服电机和减速机		
EMMS-AS-70-...	3660191	EAMM-A-L95-80G-G2
EMGA-80-P-G...-SAS-70		
EMME-AS-80-...	3660191	EAMM-A-L95-80G-G2
EMGA-80-P-G...-EAS-80		
EMME-AS-100-...	3660191	EAMM-A-L95-80G-G2
EMGA-80-P-G...-SAS-100		
EMMS-AS-100-...	3660191	EAMM-A-L95-80G-G2
EMGA-80-P-G...-SAS-100		
EMME-AS-100-...	vw3659941	EAMM-A-L95-120G-G2
EMGA-120-P-G...-SAS-100		
EMMS-AS-100-...	vw3659941	EAMM-A-L95-120G-G2
EMGA-120-P-G...-SAS-100		
EMMS-AS-140-...	vw3659941	EAMM-A-L95-120G-G2
EMGA-120-P-G...-SAS-140		
配步进电机和减速机		
EMMS-ST-87-...	3660191	EAMM-A-L95-80G2
EMGA-80-P-G...-SST-87		

1) 输入扭矩不得超过轴向安装组件的最大可传递扭矩。

Festo 核心产品范围

q 24 小时内从 Festo 工厂发出
vw 最多 5 天内发货

轴向安装组件 EAMM-A

产品范围一览

FESTO

许用电缸/电机组合，用于齿形带式电缸 ELGA-BS...

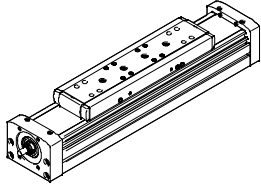

电机/减速机 ¹⁾	轴向安装组件	
型号	订货号	型号
ELGA-BS-...-70		
配伺服电机		
EMME-AS-40-...	vw3637972	EAMM-A-S38-40P-G2
EMMS-AS-40-...	3637971	EAMM-A-S38-40A-G2
EMMS-AS-55-...	3637967	EAMM-A-S38-55A-G2
EMME-AS-60-...	vw3637958	EAMM-A-S38-60P-G2
配伺服电机和减速机		
EMME-AS-40-...	1456647	EAMM-A-S38-40G-G2
EMGA-40-P-G...-EAS-40		
EMMS-AS-40-...	1456647	EAMM-A-S38-40G-G2
EMGA-40-P-G...-SAS-40		
配步进电机		
EMMS-ST-42-...	vw3637965	EAMM-A-S38-42A-G2
EMMS-ST-57-...	vw3637956	EAMM-A-S38-57A-G2
配步进电机和减速机		
EMMS-ST-42-...	1456647	EAMM-A-S38-40G-G2
EMGA-40-P-G...-SST-42		
配一体式电机		
EMCA-EC-67-...	1456638	EAMM-A-S38-67A-G2
配一体式电机和减速机		
EMCA-EC-67-...	1456647	EAMM-A-S38-40G-G2
EMGC-40-...		

电机/减速机 ¹⁾	轴向安装组件	
型号	订货号	型号
ELGA-BS-...-80		
配伺服电机		
EMMS-AS-55-...	3637961	EAMM-A-S48-55A-G2
EMME-AS-60-...	vw3637964	EAMM-A-S48-60P-G2
EMMS-AS-70-...	3637957	EAMM-A-S48-70A-G2
配伺服电机和减速机		
EMME-AS-40-...	1456650	EAMM-A-S48-40G-G2
EMGA-40-P-G...-EAS-40		
EMMS-AS-40-...	1456650	EAMM-A-S48-40G-G2
EMGA-40-P-G...-SAS-40		
EMMS-AS-55-...	2256701	EAMM-A-S48-60G-G2
EMGA-60-P-G...-SAS-55		
EMME-AS-60-...	1456652	EAMM-A-S48-60H-G2
EMGA-60-P-G...-EAS-60		
EMMS-AS-70-...	2256701	EAMM-A-S48-60G-G2
EMGA-60-P-G...-SAS-70		
配步进电机		
EMMS-ST-57-...	vw3637963	EAMM-A-S48-57A-G2
EMMS-ST-87-...	vw3637962	EAMM-A-S48-87A-G2
配步进电机和减速机		
EMMS-ST-42-...	1456650	EAMM-A-S48-40G-G2
EMGA-40-P-G...-SST-42		
EMMS-ST-57-...	2256701	EAMM-A-S48-60G-G2
EMGA-60-P-G...-SST-57		
配一体式电机和减速机		
EMCA-EC-67-...	1456650	EAMM-A-S48-40G-G2
EMGC-40		
EMCA-EC-67-...	1456652	EAMM-A-S48-60H-G2
EMGC-60-...		

1) 输入扭矩不得超过轴向安装组件的最大可传递扭矩。

Festo 核心产品范围

q 24 小时内从 Festo 工厂发出

vw 最多 5 天内发货

轴向安装组件 EAMM-A

产品范围一览

许用电缸/电机组合，用于齿形带式电缸 ELGA-BS-...

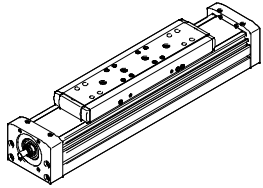

电机/减速机 ¹⁾	轴向安装组件	
型号	订货号	型号
ELGA-BS...-120		
配伺服电机		
EMMS-AS-70-...	3637959	EAMM-A-S62-70A-G2
EMME-AS-80-...	vw3637970	EAMM-A-S62-80P-G2
EMME-AS-100-...	vw3637960	EAMM-A-S62-100A-G2
EMMS-AS-100-...	vw3637960	EAMM-A-S62-100A-G2
EMMS-AS-140-...	3637969	EAMM-A-S62-140A-G2
配伺服电机和减速机		
EMMS-AS-55-...	2297649	EAMM-A-S62-60G-G2
EMGA-60-P-G...-SAS-55		
EMME-AS-60-...	1456654	EAMM-A-S62-60H-G2
EMGA-60-P-G...-EAS-60		
EMMS-AS-70-...	2297649	EAMM-A-S62-60G-G2
EMGA-60-P-G...-SAS-70		
EMMS-AS-70-...	1972530	EAMM-A-S62-80G-G2
EMGA-80-P-G...-SAS-70		
EMME-AS-80-...	1972530	EAMM-A-S62-80G-G2
EMGA-80-P-G...-EAS-80		
EMME-AS-100-...	1972530	EAMM-A-S62-80G-G2
EMGA-80-P-G...-SAS-100		
EMMS-AS-100-...	1972530	EAMM-A-S62-80G-G2
EMGA-80-P-G...-SAS-100		
配步进电机		
EMMS-ST-87-...	vw3637966	EAMM-A-S62-87A-G2
配步进电机和减速机		
EMMS-ST-57-...	2297649	EAMM-A-S62-60G-G2
EMGA-60-P-G...-SST-57		
EMMS-ST-87-...	1972530	EAMM-A-S62-80G-G2
EMGA-80-P-G...-SST-87		
配一体式电机和减速机		
EMCA-EC-67-...	1456654	EAMM-A-S62-60H-G2
EMGC-60-...		

电机/减速机 ¹⁾	轴向安装组件	
型号	订货号	型号
ELGA-BS...-150		
配伺服电机		
EMME-AS-100-...	3637955	EAMM-A-S95-100A-G2
EMMS-AS-100-...	3637955	EAMM-A-S95-100A-G2
EMMS-AS-140-...	3637954	EAMM-A-S95-140A-G2

1) 输入扭矩不得超过轴向安装组件的最大可传递扭矩。

轴向安装组件 EAMM-A

产品范围一览

FESTO

许用电缸/电机组合，用于齿形带式电缸 ELGC-TB-...

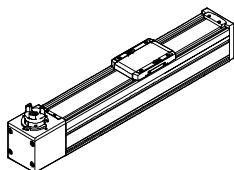

电机 ¹⁾	轴向安装组件	
型号	订货号	型号
ELGC-TB-...-45		
配伺服电机		
EMME-AS-40-...	4595742	EAMM-A-V32-40P
EMME-AS-60-...	4608750	EAMM-A-V32-60P
配步进电机		
EMMS-ST-42-...	4281142	EAMM-A-V32-42A
EMMS-ST-57-...	4597016	EAMM-A-V32-57A
ELGC-TB-...-60		
配伺服电机		
EMME-AS-60-...	4133487	EAMM-A-T42-60P
EMME-AS-80-...	4623788	EAMM-A-T42-80P
配步进电机		
EMMS-ST-57-...	4327034	EAMM-A-T42-57A
EMMS-ST-87-...	4610008	EAMM-A-T42-87A
ELGC-TB-...-80		
配伺服电机		
EMME-AS-60-...	4824833	EAMM-A-T46-60P
EMME-AS-80-...	4624170	EAMM-A-T46-80P
EMME-AS-100-...	4624227	EAMM-A-T46-100A
EMMS-AS-100-...	4624227	EAMM-A-T46-100A
配步进电机		
EMMS-ST-87-...	4048771	EAMM-A-T46-87A

1) 输入扭矩不得超过轴向安装组件的最大可传递扭矩。

轴向安装组件 EAMM-A

产品范围一览

许用电缸/电机组合，用于齿形带式电缸 ELGC-BS-...

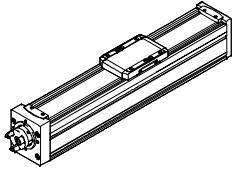

电机 ¹⁾	轴向安装组件	
型号	订货号	型号
ELGC-BS-...-32		
配伺服电机		
EMME-AS-40-...	4491059	EAMM-A-V25-40P
配步进电机		
EMMS-ST-42-...	4582608	EAMM-A-V25-42A
ELGC-BS-...-45		
配伺服电机		
EMME-AS-40-...	4595742	EAMM-A-V32-40P
配步进电机		
EMMS-ST-42-...	4281142	EAMM-A-V32-42A
ELGC-BS-...-60		
配伺服电机		
EMME-AS-60-...	4133487	EAMM-A-T42-60P
配步进电机		
EMMS-ST-57-...	4327034	EAMM-A-T42-57A
ELGC-BS-...-80		
配伺服电机		
EMME-AS-60-...	4824833	EAMM-A-T46-60P
EMME-AS-80-...	4624170	EAMM-A-T46-80P
配步进电机		
EMMS-ST-87-...	4048771	EAMM-A-T46-87A

1) 输入扭矩不得超过轴向安装组件的最大可传递扭矩。

轴向安装组件 EAMM-A

产品范围一览

FESTO

许用电缸/电机组合，用于齿形带式电缸 EGC-HD-TB

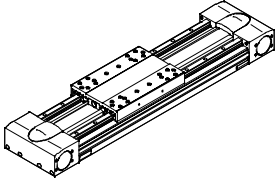

电机/减速机 ¹⁾	轴向安装组件	
型号	订货号	型号
EGC-HD-125		
配伺服电机和减速机		
EMMS-AS-55-...	1190076	EAMM-A-M43-60G
EMGA-60-P-G...-SAS-55		
EMME-AS-60-...	1456612	EAMM-A-M43-60H
EMGA-60-P-G...-EAS-60		
EMMS-AS-70-...	1190076	EAMM-A-M43-60G
EMGA-60-P-G...-SAS-70		
配步进电机和减速机		
EMMS-ST-57-...	1190076	EAMM-A-M43-60G
EMGA-60-P-G...-SST-57		
配一体式电机和减速机		
EMCA-EC-67-...	1456612	EAMM-A-M43-60H
EMGC-60-...		

电机/减速机 ¹⁾	轴向安装组件	
型号	订货号	型号
EGC-HD-160		
配伺服电机和减速机		
EMME-AS-60-...	1456614	EAMM-A-M48-60H
EMGA-60-P-G...-EAS-60		
EMMS-AS-70-...	1190421	EAMM-A-M48-80G
EMGA-80-P-G...-SAS-70		
EMME-AS-80-...	1190421	EAMM-A-M48-80G
EMGA-80-P-G...-EAS-80		
EMME-AS-100-...	1190421	EAMM-A-M48-80G
EMGA-80-P-G...-SAS-100		
EMMS-AS-100-...	1190421	EAMM-A-M48-80G
EMGA-80-P-G...-SAS-100		
配步进电机和减速机		
EMMS-ST-87-...	1190421	EAMM-A-M48-80G
EMGA-80-P-G...-SST-87		
配一体式电机和减速机		
EMCA-EC-67-...	1456614	EAMM-A-M48-60H
EMGC-60-...		
EGC-HD-220		
配伺服电机和减速机		
EMME-AS-100-...	1190774	EAMM-A-M80-120G
EMGA-120-P-G...-SAS-100		
EMMS-AS-100-...	1190774	EAMM-A-M80-120G
EMGA-120-P-G...-SAS-100		
EMMS-AS-140-...	1190774	EAMM-A-M80-120G
EMGA-120-P-G...-SAS-140		

1) 输入扭矩不得超过轴向安装组件的最大可传递扭矩。

轴向安装组件 EAMM-A

产品范围一览

FESTO

许用电缸/电机组合，用于丝杆式电缸 EGC-HD-BS

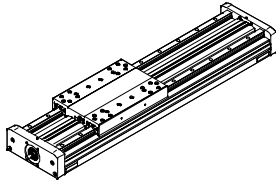

电机/减速机 ¹⁾	轴向安装组件	
型号	订货号	型号
EGC-HD-125		
配伺服电机		
EMME-AS-40-...	√3637972	EAMM-A-S38-40P-G2
EMMS-AS-40-...	3637971	EAMM-A-S38-40A-G2
EMMS-AS-55-...	3637967	EAMM-A-S38-55A-G2
EMME-AS-60-...	√3637958	EAMM-A-S38-60P-G2
配伺服电机和减速机		
EMME-AS-40-...	1456647	EAMM-A-S38-40G-G2
EMGA-40-P-G...-EAS-40		
EMMS-AS-40-...	1456647	EAMM-A-S38-40G-G2
EMGA-40-P-G...-SAS-40		
配步进电机		
EMMS-ST-42-...	√3637965	EAMM-A-S38-42A-G2
EMMS-ST-57-...	√3637956	EAMM-A-S38-57A-G2
配步进电机和减速机		
EMMS-ST-42-...	1456647	EAMM-A-S38-40G-G2
EMGA-40-P-G...-SST-42		
配一体式电机		
EMCA-EC-67-...	1456638	EAMM-A-S38-67A-G2
配一体式电机和减速机		
EMCA-EC-67-...	1456647	EAMM-A-S38-40G-G2
EMGC-40-...		

电机/减速机 ¹⁾	轴向安装组件	
型号	订货号	型号
EGC-HD-160		
配伺服电机		
EMMS-AS-55-...	3637961	EAMM-A-S48-55A-G2
EMME-AS-60-...	√3637964	EAMM-A-S48-60P-G2
EMMS-AS-70-...	3637957	EAMM-A-S48-70A-G2
配伺服电机和减速机		
EMME-AS-40-...	1456650	EAMM-A-S48-40G-G2
EMGA-40-P-G...-EAS-40		
EMMS-AS-40-...	1456650	EAMM-A-S48-40G-G2
EMGA-40-P-G...-SAS-40		
EMMS-AS-55-...	2256701	EAMM-A-S48-60G-G2
EMGA-60-P-G...-SAS-55		
EMME-AS-60-...	1456652	EAMM-A-S48-60H-G2
EMGA-60-P-G...-EAS-60		
EMMS-AS-70-...	2256701	EAMM-A-S48-60G-G2
EMGA-60-P-G...-SAS-70		
配步进电机		
EMMS-ST-57-...	√3637963	EAMM-A-S48-57A-G2
EMMS-ST-87-...	√3637962	EAMM-A-S48-87A-G2
配步进电机和减速机		
EMMS-ST-42-...	1456650	EAMM-A-S48-40G-G2
EMGA-40-P-G...-SST-42		
EMMS-ST-57-...	2256701	EAMM-A-S48-60G-G2
EMGA-60-P-G...-SST-57		
配一体式电机和减速机		
EMCA-EC-67-...	1456650	EAMM-A-S48-40G-G2
EMGC-40-...		
EMCA-EC-67-...	1456652	EAMM-A-S48-60H-G2
EMGC-60-...		

1) 输入扭矩不得超过轴向安装组件的最大可传递扭矩。

Festo 核心产品范围

√ 24 小时内从 Festo 工厂发出
√ 最多 5 天内发货

轴向安装组件 EAMM-A

产品范围一览

FESTO

许用电缸/电机组合，用于丝杆式电缸 EGC-HD-BS

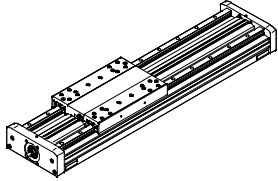

电机/减速机 ¹⁾	轴向安装组件	
型号	订货号	型号
EGC-HD-220		
配伺服电机		
EMMS-AS-70-...	3637959	EAMM-A-S62-70A-G2
EMME-AS-80-...	vw3637970	EAMM-A-S62-80P-G2
EMME-AS-100-...	vw3637960	EAMM-A-S62-100A-G2
EMMS-AS-100-...	vw3637960	EAMM-A-S62-100A-G2
EMMS-AS-140-...	vw3637969	EAMM-A-S62-140A-G2
配伺服电机和减速机		
EMMS-AS-55-...	2297649	EAMM-A-S62-60G-G2
EMGA-60-P-G...-SAS-55		
EMME-AS-60-...	1456654	EAMM-A-S62-60H-G2
EMGA-60-P-G...-EAS-60		
EMMS-AS-70-...	2297649	EAMM-A-S62-60G-G2
EMGA-60-P-G...-SAS-70		
EMMS-AS-70-...	1972530	EAMM-A-S62-80G-G2
EMGA-80-P-G...-SAS-70		
EMME-AS-80-...	1972530	EAMM-A-S62-80G-G2
EMGA-80-P-G...-EAS-80		
EMME-AS-100-...	1972530	EAMM-A-S62-80G-G2
EMGA-80-P-G...-SAS-100		
EMMS-AS-100-...	1972530	EAMM-A-S62-80G-G2
EMGA-80-P-G...-SAS-100		
配步进电机		
EMMS-ST-87-...	vw3637966	EAMM-A-S62-87A-G2
配步进电机和减速机		
EMMS-ST-57-...	2297649	EAMM-A-S62-60G-G2
EMGA-60-P-G...-SST-57		
EMMS-ST-87-...	1972530	EAMM-A-S62-80G-G2
EMGA-80-P-G...-SST-87		
配一体式电机和减速机		
EMCA-EC-67-...	1456654	EAMM-A-S62-60H-G2
EMGC-60-...		
EMCA-EC-67-...	1972530	EAMM-A-S62-80G-G2
EMGC-80-...		

1) 输入扭矩不得超过轴向安装组件的最大可传递扭矩。

Festo 核心产品范围

q 24 小时内从 Festo 工厂发出

vw 最多 5 天内发货

轴向安装组件 EAMM-A

产品范围一览

许用电缸/电机组合，用于小型滑台式电缸 EGSL

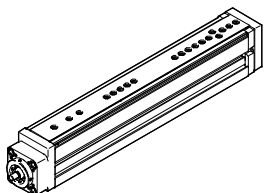

电机/减速机 ¹⁾	轴向安装组件	
型号	订货号	型号
EGSL-35		
配伺服电机		
EMME-AS-40-...	1981953	EAMM-A-D19-40P
EMMS-AS-40-...	1199152	EAMM-A-D19-40A
配步进电机		
EMMS-ST-28-...	1081659	EAMM-A-D19-28A
EMMS-ST-42-...	1087642	EAMM-A-D19-42A
EGSL-45		
配伺服电机		
EMME-AS-40-...	vw1976465	EAMM-A-D32-40P
EMMS-AS-40-...	543147	EAMM-A-D32-40A
EMMS-AS-55-...	550979	EAMM-A-D32-55A
EMME-AS-60-...	vw1956054	EAMM-A-D32-60P
配伺服电机和减速机		
EMME-AS-40-...	1454238	EAMM-A-D32-40G
EMGA-40-P-G...-EAS-40		
EMMS-AS-40-...	1454238	EAMM-A-D32-40G
EMGA-40-P-G...-SAS-40		
EMMS-AS-55-...	2946758	EAMM-A-D32-60G
EMGA-60-P-G...-SAS-55		
EMME-AS-60-...	2946760	EAMM-A-D32-60H
EMGA-60-P-G...-EAS-60		
EMMS-AS-70-...	2946758	EAMM-A-D32-60G
EMGA-60-P-G...-SAS-70		
配步进电机		
EMMS-ST-42-...	vw543148	EAMM-A-D32-42A
EMMS-ST-57-...	vw550980	EAMM-A-D32-57A
配步进电机和减速机		
EMMS-ST-42-...	1454238	EAMM-A-D32-40G
EMGA-40-P-G...-SST-42		
EMMS-ST-57-...	2946758	EAMM-A-D32-60G
EMGA-60-P-G...-SST-57		
配一体式电机		
EMCA-EC-67-...	1454239	EAMM-A-D32-67A
配一体式电机和减速机		
EMCA-EC-67-...	1454238	EAMM-A-D32-40G
EMGC-40-...		
EMCA-EC-67-...	2946760	EAMM-A-D32-60H
EMGC-60-...		

电机/减速机 ¹⁾	轴向安装组件	
型号	订货号	型号
EGSL-55		
配伺服电机		
EMMS-AS-55-...	543153	EAMM-A-D40-55A
EMME-AS-60-...	vw1977000	EAMM-A-D40-60P
EMMS-AS-70-...	550981	EAMM-A-D40-70A
配伺服电机和减速机		
EMME-AS-40-...	vw560282	EAMM-A-D40-40G ²⁾
EMGA-40-P-G...-EAS-40	2256398	EAMM-A-D40-40G-G2
EMMS-AS-40-...	vw560282	EAMM-A-D40-40G ²⁾
EMGA-40-P-G...-SAS-40	2256398	EAMM-A-D40-40G-G2
EMMS-AS-55-...	2256400	EAMM-A-D40-60G
EMGA-60-P-G...-SAS-55		
EMME-AS-60-...	1454242	EAMM-A-D40-60H
EMGA-60-P-G...-EAS-60		
EMMS-AS-70-...	2256400	EAMM-A-D40-60G
EMGA-60-P-G...-SAS-70		
配步进电机		
EMMS-ST-57-...	vw543154	EAMM-A-D40-57A
EMMS-ST-87-...	vw550982	EAMM-A-D40-87A
配步进电机和减速机		
EMMS-ST-42-...	vw560282	EAMM-A-D40-40G ²⁾
EMGA-40-P-G...-SST-42	2256398	EAMM-A-D40-40G-G2
EMMS-ST-57-...	2256400	EAMM-A-D40-60G
EMGA-60-P-G...-SST-57		
配一体式电机		
EMCA-EC-67-...	1454243	EAMM-A-D40-67A
配一体式电机和减速机		
EMCA-EC-67-...	vw560282	EAMM-A-D40-40G ²⁾
EMGC-40-...	2256398	EAMM-A-D40-40G-G2
EMCA-EC-67-...	1454242	EAMM-A-D40-60H
EMGC-60-...		

1) 输入扭矩不得超过轴向安装组件的最大可传递扭矩。

2) 型号停产

Festo 核心产品范围

q 24 小时内从 Festo 工厂发出

vw 最多 5 天内发货

轴向安装组件 EAMM-A

产品范围一览

FESTO

许用电缸/电机组合，用于小型滑台式电缸 EGSL

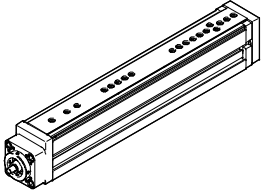

电机/减速机 ¹⁾	轴向安装组件	
型号	订货号	型号
EGSL-75		
配伺服电机		
EMMS-AS-70-...	543161	EAMM-A-D60-70A
EMME-AS-80-...	∨1977073	EAMM-A-D60-80P
EMME-AS-100-...	∨550983	EAMM-A-D60-100A
EMMS-AS-100-...	∨550983	EAMM-A-D60-100A
配伺服电机和减速机		
EMMS-AS-55-...	∨560283	EAMM-A-D60-60G ²⁾
EMGA-60-P-G...-SAS-55	2256696	EAMM-A-D60-60G-G2
EMME-AS-60-...	1454245	EAMM-A-D60-60H
EMGA-60-P-G...-EAS-60		
EMMS-AS-70-...	∨560283	EAMM-A-D60-60G ²⁾
EMGA-60-P-G...-SAS-70	2256696	EAMM-A-D60-60G-G2
EMMS-AS-70-...	1499402	EAMM-A-D60-80G
EMGA-80-P-G...-SAS-70		
EMME-AS-80-...	1499402	EAMM-A-D60-80G
EMGA-80-P-G...-EAS-80		
EMME-AS-100-...	1499402	EAMM-A-D60-80G
EMGA-80-P-G...-SAS-100		
EMMS-AS-100-...	1499402	EAMM-A-D60-80G
EMGA-80-P-G...-SAS-100		
配步进电机		
EMMS-ST-87-...	∨543162	EAMM-A-D60-87A
配步进电机和减速机		
EMMS-ST-57-...	∨560283	EAMM-A-D60-60G ²⁾
EMGA-60-P-G...-SST-57	2256696	EAMM-A-D60-60G-G2
EMMS-ST-87-...	1499402	EAMM-A-D60-80G-G2
EMGA-80-P-G...-SST-87		
配一体式电机和减速机		
EMCA-EC-67-...	1454245	EAMM-A-D60-80H
EMGC-60-...		

1) 输入扭矩不得超过轴向安装组件的最大可传递扭矩。

2) 型号停产

Festo 核心产品范围

∨ 24 小时内从 Festo 工厂发出

∨ 最多 5 天内发货

轴向安装组件 EAMM-A

产品范围一览

许用电缸/电机组合，用于小型滑台式电缸 EGSC

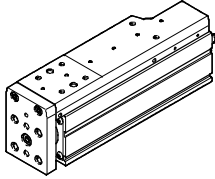

电机 ¹⁾	轴向安装组件	
型号	订货号	型号
EGSC-25		
配步进电机		
EMMS-ST-28-...	4505258	EAMM-A-V20-28A
EGSC-32		
配伺服电机		
EMME-AS-40-...	4491059	EAMM-A-V25-40P
配步进电机		
EMMS-ST-42-...	4582608	EAMM-A-V25-42A
EGSC-45		
配伺服电机		
EMME-AS-40-...	4595742	EAMM-A-V32-40P
配步进电机		
EMMS-ST-42-...	4281142	EAMM-A-V32-42A
EGSC-60		
配伺服电机		
EMME-AS-60-...	4133487	EAMM-A-T42-60P
配步进电机		
EMMS-ST-57-...	4327034	EAMM-A-T42-57A

1) 输入扭矩不得超过轴向安装组件的最大可传递扭矩。

轴向安装组件 EAMM-A

产品范围一览

FESTO

许用电缸/电机组合，用于滑台式电缸 EGSK, EGSP

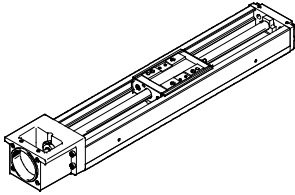

电机/减速机 ¹⁾	轴向安装组件	
型号	订货号	型号
EGSK-15		
配伺服电机		
EMME-AS-40-...	1982886	EAMM-A-P3-28D-40P
配步进电机		
EMMS-ST-28-...	1703478	EAMM-A-P3-28D-28A
EGSK-20/EGSP-20		
配伺服电机		
EMME-AS-40-...	1983071	EAMM-A-P4-28B-40P
EMMS-AS-40-...	562637	EAMM-A-P4-28B-40A
配步进电机		
EMMS-ST-28-...	1731466	EAMM-A-P4-28B-28A
EMMS-ST-42-...	562636	EAMM-A-P4-28B-42A
EGSK-26/EGSP-26		
配伺服电机		
EMME-AS-40-...	1983122	EAMM-A-P5-28B-40P
EMMS-AS-40-...	562641	EAMM-A-P5-28B-40A
配步进电机		
EMMS-ST-28-...	1731474	EAMM-A-P5-28B-28A
EMMS-ST-42-...	562640	EAMM-A-P5-28B-42A
EGSK-33		
配伺服电机		
EMME-AS-40-...	1983450	EAMM-A-P6-38A-40P
EMMS-AS-40-...	562646	EAMM-A-P6-38A-40A
EMMS-AS-55-...	562647	EAMM-A-P6-38A-55A
EMME-AS-60-...	2264375	EAMM-A-P6-38A-60P
配伺服电机和减速机		
EMME-AS-40-...	2297645	EAMM-A-P6-38A-40G
EMGA-40-P-G...-EAS-40		
EMMS-AS-40-...	2297645	EAMM-A-P6-38A-40G
EMGA-40-P-G...-SAS-40		
配步进电机		
EMMS-ST-42-...	562644	EAMM-A-P6-38A-42A
EMMS-ST-57-...	562645	EAMM-A-P6-38A-57A
配步进电机和减速机		
EMMS-ST-42-...	2297645	EAMM-A-P6-38A-40G
EMGA-40-P-G...-SST-42		
配一体式电机		
EMCA-EC-67-...	2297641	EAMM-A-P6-38A-67A
配一体式电机和减速机		
EMCA-EC-67-...	2297645	EAMM-A-P6-38A-40G
EMGC-40-...		

电机/减速机 ¹⁾	轴向安装组件	
型号	订货号	型号
EGSK-46/EGSP-33		
配伺服电机		
EMME-AS-40-...	1986292	EAMM-A-P8-38A-40P
EMMS-AS-40-...	562652	EAMM-A-P8-38A-40A
EMMS-AS-55-...	562653	EAMM-A-P8-38A-55A
EMME-AS-60-...	1987308	EAMM-A-P8-38A-60P
EMMS-AS-70-...	564996	EAMM-A-P8-38A-70A
配伺服电机和减速机		
EMME-AS-40-...	2297646	EAMM-A-P8-38A-40G
EMGA-40-P-G...-EAS-40		
EMMS-AS-40-...	2297646	EAMM-A-P8-38A-40G
EMGA-40-P-G...-SAS-40		
配步进电机		
EMMS-ST-42-...	562650	EAMM-A-P8-38A-42A
EMMS-ST-57-...	562651	EAMM-A-P8-38A-57A
EMMS-ST-87-...	564998	EAMM-A-P8-38A-87A
配步进电机和减速机		
EMMS-ST-42-...	2297646	EAMM-A-P8-38A-40G
EMGA-40-P-G...-SST-42		
配一体式电机		
EMCA-EC-67-...	2297643	EAMM-A-P8-38A-67A
配一体式电机和减速机		
EMCA-EC-67-...	2297646	EAMM-A-P8-38A-40G
EMGC-40-...		
EGSP-46		
配伺服电机		
EMMS-AS-55-...	562659	EAMM-A-P10-38A-55A
EMME-AS-60-...	2036017	EAMM-A-P10-38A-60P
EMMS-AS-70-...	564997	EAMM-A-P10-38A-70A
配伺服电机和减速机		
EMME-AS-40-...	2297648	EAMM-A-P10-38A-40G
EMGA-40-P-G...-EAS-40		
EMMS-AS-40-...	2297648	EAMM-A-P10-38A-40G
EMGA-40-P-G...-SAS-40		
配步进电机		
EMMS-ST-57-...	562658	EAMM-A-P10-38A-57A
EMMS-ST-87-...	564999	EAMM-A-P10-38A-87A
配步进电机和减速机		
EMMS-ST-42-...	2297648	EAMM-A-P10-38A-40G
EMGA-40-P-G...-SST-42		
配一体式电机		
EMCA-EC-67-...	2297644	EAMM-A-P10-38A-67A
配一体式电机和减速机		
EMCA-EC-67-...	2297648	EAMM-A-P10-38A-40G
EMGC-40-...		

1) 输入扭矩不得超过轴向安装组件的最大可传递扭矩。

轴向安装组件 EAMM-A

产品范围一览

许用电缸/电机组合，用于悬臂式电缸 DGEA

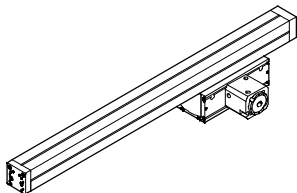

电机/减速机 ¹⁾ 型号	轴向安装组件	
	订货号	型号
DGEA-18		
配伺服电机和减速机		
EMME-AS-40-... EMGA-40-P-G...-EAS-40	1454251	EAMM-A-F28-40G
EMMS-AS-40-... EMGA-40-P-G...-SAS-40	1454251	EAMM-A-F28-40G
EMMS-AS-55-... EMGA-60-P-G...-SAS-55	550957	EAMM-A-F28-60G
EMME-AS-60-... EMGA-60-P-G...-EAS-60	1454252	EAMM-A-F28-60H
EMMS-AS-70-... EMGA-60-P-G...-SAS-70	550957	EAMM-A-F28-60G
配步进电机		
EMMS-ST-57-...	550956	EAMM-A-F28-57A
EMMS-ST-87-...	550958	EAMM-A-F28-87A
配步进电机和减速机		
EMMS-ST-42-... EMGA-40-P-G...-SST-42	1454251	EAMM-A-F28-40G
EMMS-ST-57-... EMGA-60-P-G...-SST-57	550957	EAMM-A-F28-60G
配一体式电机和减速机		
EMCA-EC-67-... EMGC-40-...	1454251	EAMM-A-F28-40G
EMCA-EC-67-... EMGC-60-...	1454252	EAMM-A-F28-60H

电机/减速机 ¹⁾ 型号	轴向安装组件	
	订货号	型号
DGEA-25		
配伺服电机和减速机		
EMMS-AS-55-... EMGA-60-P-G...-SAS-55	550959	EAMM-A-F32-60G
EMME-AS-60-... EMGA-60-P-G...-EAS-60	1454256	EAMM-A-F32-60H
EMMS-AS-70-... EMGA-60-P-G...-SAS-70	550959	EAMM-A-F32-60G
配步进电机		
EMMS-ST-87-...	550960	EAMM-A-F32-87A
配步进电机和减速机		
EMMS-ST-57-... EMGA-60-P-G...-SST-57	550959	EAMM-A-F32-60G
配一体式电机和减速机		
EMCA-EC-67-... EMGC-60-...	1454256	EAMM-A-F32-60H
DGEA-40		
配伺服电机和减速机		
EMMS-AS-70-... EMGA-80-P-G...-SAS-70	550935	EAMM-A-F40-80G
EMME-AS-80-... EMGA-80-P-G...-EAS-80	550935	EAMM-A-F40-80G
EMME-AS-100-... EMGA-80-P-G...-SAS-100	550935	EAMM-A-F40-80G
EMMS-AS-100-... EMGA-80-P-G...-SAS-100	550935	EAMM-A-F40-80G
配步进电机和减速机		
EMMS-ST-87-... EMGA-80-P-G...-SST-87	550935	EAMM-A-F40-80G

1) 输入扭矩不得超过轴向安装组件的最大可传递扭矩。

轴向安装组件 EAMM-A

产品范围一览

FESTO

许用电缸/电机组合，用于齿形带式电缸 ELGG

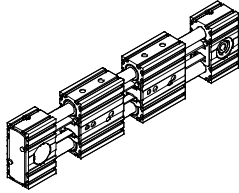

电机/减速机 ¹⁾	轴向安装组件	
型号	订货号	型号
ELGG-35		
配伺服电机		
EMMS-AS-55-...	1133400	EAMM-A-R27-55A
配伺服电机和减速机		
EMME-AS-40-...	1456622	EAMM-A-R27-40G
EMGA-40-P-G...-EAS-40		
EMMS-AS-40-...	1456622	EAMM-A-R27-40G
EMGA-40-P-G...-SAS-40		
配步进电机		
EMMS-ST-57-...	W1133403	EAMM-A-R27-57A
配步进电机和减速机		
EMMS-ST-42-...	1456622	EAMM-A-R27-40G
EMGA-40-P-G...-SST-42		
配一体式电机		
EMCA-EC-67-...	1456619	EAMM-A-R27-67A
配一体式电机和减速机		
EMCA-EC-67-...	1456622	EAMM-A-R27-40G
EMGC-40-...		
ELGG-45		
配伺服电机		
EMMS-AS-60-...	W2224996	EAMM-A-R38-60P
EMMS-AS-70-...	1133401	EAMM-A-R38-70A
配伺服电机和减速机		
EMME-AS-40-...	1456623	EAMM-A-R38-40G
EMGA-40-P-G...-EAS-40		
EMMS-AS-40-...	1456623	EAMM-A-R38-40G
EMGA-40-P-G...-SAS-40		
EMMS-AS-55-...	2310075	EAMM-A-R38-60G
EMGA-60-P-G...-SAS-55		
EMME-AS-60-...	1456630	EAMM-A-R38-60H
EMGA-60-P-G...-EAS-60		
EMMS-AS-70-...	2310075	EAMM-A-R38-60G
EMGA-60-P-G...-SAS-70		

电机/减速机 ¹⁾	轴向安装组件	
型号	订货号	型号
ELGG-45		
配步进电机		
EMMS-ST-57-...	W1578138	EAMM-A-R38-57A
EMMS-ST-87-...	W1133404	EAMM-A-R38-87A
配步进电机和减速机		
EMMS-ST-42-...	1456623	EAMM-A-R38-40G
EMGA-40-P-G...-SST-42		
EMMS-ST-57-...	2310075	EAMM-A-R38-60G
EMGA-60-P-G...-SST-57		
配一体式电机和减速机		
EMCA-EC-67-...	1456623	EAMM-A-R38-40G
EMGC-40-...		
EMCA-EC-67-...	1456630	EAMM-A-R38-60H
EMGC-60-...		
ELGG-55		
配伺服电机		
EMMS-AS-70-...	1578139	EAMM-A-R48-70A
EMME-AS-80-...	W2225090	EAMM-A-R48-80P
EMMS-AS-100-...	W1133402	EAMM-A-R48-100A
配伺服电机和减速机		
EMMS-AS-55-...	2374780	EAMM-A-R48-60G
EMGA-60-P-G...-SAS-55		
EMME-AS-60-...	1456633	EAMM-A-R48-60H
EMGA-60-P-G...-EAS-60		
EMMS-AS-70-...	2374780	EAMM-A-R48-60G
EMGA-60-P-G...-SAS-70		
配步进电机		
EMMS-ST-87-...	W1133405	EAMM-A-R48-87A
配步进电机和减速机		
EMMS-ST-57-...	2374780	EAMM-A-R48-60G
EMGA-60-P-G...-SST-57		
配一体式电机和减速机		
EMCA-EC-67-...	1456633	EAMM-A-R48-60H
EMGC-60-...		

1) 输入扭矩不得超过轴向安装组件的最大可传递扭矩。

Festo 核心产品范围

q 24 小时内从 Festo 工厂发出
W 最多 5 天内发货

轴向安装组件 EAMM-A

产品范围一览

FESTO

许用电缸/电机组合，用于齿形带式电缸 ELGR

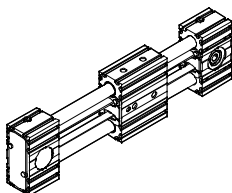

电机/减速机 ¹⁾	轴向安装组件	
型号	订货号	型号
ELGR-35		
配伺服电机		
EMMS-AS-55-...	1133400	EAMM-A-R27-55A
配伺服电机和减速机		
EMME-AS-40-...	1456622	EAMM-A-R27-40G
EMGA-40-P-G...-EAS-40		
EMMS-AS-40-...	1456622	EAMM-A-R27-40G
EMGA-40-P-G...-SAS-40		
配步进电机		
EMMS-ST-57-...	vw1133403	EAMM-A-R27-57A
配步进电机和减速机		
EMMS-ST-42-...	1456622	EAMM-A-R27-40G
EMGA-40-P-G...-SST-42		
配一体式电机		
EMCA-EC-67-...	1456619	EAMM-A-R27-67A
配一体式电机和减速机		
EMCA-EC-67-...	1456622	EAMM-A-R27-40G
EMGC-40-...		
ELGR-45		
配伺服电机		
EMMS-AS-60-...	vw2224996	EAMM-A-R38-60P
EMMS-AS-70-...	1133401	EAMM-A-R38-70A
配伺服电机和减速机		
EMME-AS-40-...	1456623	EAMM-A-R38-40G
EMGA-40-P-G...-EAS-40		
EMMS-AS-40-...	1456623	EAMM-A-R38-40G
EMGA-40-P-G...-SAS-40		
EMMS-AS-55-...	2310075	EAMM-A-R38-60G
EMGA-60-P-G...-SAS-55		
EMME-AS-60-...	1456630	EAMM-A-R38-60H
EMGA-60-P-G...-EAS-60		
EMMS-AS-70-...	2310075	EAMM-A-R38-60G
EMGA-60-P-G...-SAS-70		

电机/减速机 ¹⁾	轴向安装组件	
型号	订货号	型号
ELGR-45		
配步进电机		
EMMS-ST-57-...	vw1578138	EAMM-A-R38-57A
EMMS-ST-87-...	vw1133404	EAMM-A-R38-87A
配步进电机和减速机		
EMMS-ST-42-...	1456623	EAMM-A-R38-40G
EMGA-40-P-G...-SST-42		
EMMS-ST-57-...	2310075	EAMM-A-R38-60G
EMGA-60-P-G...-SST-57		
配一体式电机和减速机		
EMCA-EC-67-...	1456623	EAMM-A-R38-40G
EMGC-40-...		
EMCA-EC-67-...	1456630	EAMM-A-R38-60H
EMGC-60-...		
ELGR-55		
配伺服电机		
EMMS-AS-70-...	1578139	EAMM-A-R48-70A
EMME-AS-80-...	vw2225090	EAMM-A-R48-80P
EMMS-AS-100-...	vw1133402	EAMM-A-R48-100A
配伺服电机和减速机		
EMMS-AS-55-...	2374780	EAMM-A-R48-60G
EMGA-60-P-G...-SAS-55		
EMME-AS-60-...	1456633	EAMM-A-R48-60H
EMGA-60-P-G...-EAS-60		
EMMS-AS-70-...	2374780	EAMM-A-R48-60G
EMGA-60-P-G...-SAS-70		
配步进电机		
EMMS-ST-87-...	vw1133405	EAMM-A-R48-87A
配步进电机和减速机		
EMMS-ST-57-...	2374780	EAMM-A-R48-60G
EMGA-60-P-G...-SST-57		
配一体式电机和减速机		
EMCA-EC-67-...	1456633	EAMM-A-R48-60H
EMGC-60-...		

1) 输入扭矩不得超过轴向安装组件的最大可传递扭矩。

Festo 核心产品范围

q 24 小时内从 Festo 工厂发出
vw 最多 5 天内发货

轴向安装组件 EAMM-A

产品范围一览

FESTO

许用电缸/电机组合，用于旋转电缸 ERMB

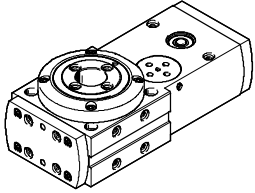

电机/减速机 ¹⁾	轴向安装组件	
型号	订货号	型号
ERMB-20		
配伺服电机		
EMME-AS-40-...	2207441	EAMM-A-D32-35A-40P
EMMS-AS-40-...	560281	EAMM-A-D32-35A-40A
配步进电机		
EMMS-ST-42-...	vw543148	EAMM-A-D32-42A
EMMS-ST-57-...	vw550980	EAMM-A-D32-57A
配一体式电机		
EMCA-EC-67-...	1454239	EAMM-A-D32-67A
配电机单元		
MTR-DCI-32S-...	543149	EAMM-A-D32-32B
配一体式电机和减速机		
EMCA-EC-67-...	1454238	EAMM-A-D32-40G
EMGC-40-...		
EMCA-EC-67-...	2946760	EAMM-A-D32-60H
EMGC-60-...		
ERMB-25		
配伺服电机		
EMMS-AS-55-...	543153	EAMM-A-D40-55A
EMME-AS-60-...	vw1977000	EAMM-A-D40-60P
EMMS-AS-70-...	550981	EAMM-A-D40-70A
配伺服电机和减速机		
EMME-AS-40-...	vw560282	EAMM-A-D40-40G
EMGA-40-P-G...-EAS-40		
EMMS-AS-40-...	vw560282	EAMM-A-D40-40G
EMGA-40-P-G...-SAS-40		
配步进电机		
EMMS-ST-57-...	vw543154	EAMM-A-D40-57A
配步进电机和减速机		
EMMS-ST-42-...	vw560282	EAMM-A-D40-40G
EMGA-40-P-G...-SST-42		
配一体式电机		
EMCA-EC-67-...	1454243	EAMM-A-D40-67A
配电机单元		
MTR-DCI-42S-...-G7	543155	EAMM-A-D40-42B
MTR-DCI-42S-...-G14	543156	EAMM-A-D40-42C
配一体式电机和减速机		
EMCA-EC-67-...	vw560282	EAMM-A-D40-40G ²⁾
EMGC-40-...	2256398	EAMM-A-D40-40G-G2
EMCA-EC-67-...	1454242	EAMM-A-D40-60H
EMGC-60-...		

电机/减速机 ¹⁾	轴向安装组件	
型号	订货号	型号
ERMB-32		
配伺服电机		
EMMS-AS-70-...	543161	EAMM-A-D60-70A
EMME-AS-80-...	vw1977073	EAMM-A-D60-80P
EMME-AS-100-...	vw550983	EAMM-A-D60-100A
EMMS-AS-100-...	vw550983	EAMM-A-D60-100A
配伺服电机和减速机		
EMMS-AS-55-...	vw560283	EAMM-A-D60-60G
EMGA-60-P-G...-SAS-55		
EMMS-AS-70-...	vw560283	EAMM-A-D60-60G
EMGA-60-P-G...-SAS-70		
配步进电机		
EMMS-ST-87-...	vw543162	EAMM-A-D60-87A
配步进电机和减速机		
EMMS-ST-57-...	vw560283	EAMM-A-D60-60G
EMGA-60-P-G...-SST-57		
配电机单元		
MTR-DCI-52S-...-G7	543163	EAMM-A-D60-52B
MTR-DCI-52S-...-G14	543164	EAMM-A-D60-52C
配一体式电机和减速机		
EMCA-EC-67-...	1454245	EAMM-A-D60-60H
EMGC-60-...		

1) 输入扭矩不得超过轴向安装组件的最大可传递扭矩。

2) 型号停产

Festo 核心产品范围

q 24 小时内从 Festo 工厂发出

vw 最多 5 天内发货

轴向安装组件 EAMM-A

产品范围一览

许用电缸/电机组合，用于旋转/升降模块 EHMB

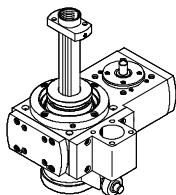

用于旋转运动电机/减速机 ¹⁾		轴向安装组件	
型号	订货号	型号	
EHMB-20			
配伺服电机			
EMME-AS-40-...	2207441	EAMM-A-D32-35A-40P	
EMMS-AS-40-...	560281	EAMM-A-D32-35A-40A	
配步进电机			
EMMS-ST-42-...	vw543148	EAMM-A-D32-42A	
EMMS-ST-57-...	vw550980	EAMM-A-D32-57A	
配一体式电机			
EMCA-EC-67-...	1454239	EAMM-A-D32-67A	
配电机单元			
MTR-DCI-32S-...	543149	EAMM-A-D32-32B	
配一体式电机和减速机			
EMCA-EC-67-...	1454238	EAMM-A-D32-40G	
EMGC-40-...			
EMCA-EC-67-...	2946760	EAMM-A-D32-60H	
EMGC-60-...			
EHMB-25			
配伺服电机			
EMMS-AS-55-...	543153	EAMM-A-D40-55A	
EMME-AS-60-...	vw1977000	EAMM-A-D40-60P	
EMMS-AS-70-...	550981	EAMM-A-D40-70A	
配伺服电机和减速机			
EMME-AS-40-...	vw560282	EAMM-A-D40-40G	
EMGA-40-P-G...-EAS-40			
EMMS-AS-40-...	vw560282	EAMM-A-D40-40G	
EMGA-40-P-G...-SAS-40			
配步进电机			
EMMS-ST-57-...	vw543154	EAMM-A-D40-57A	
配步进电机和减速机			
EMMS-ST-42-...	vw560282	EAMM-A-D40-40G	
EMGA-40-P-G...-SST-42			
配一体式电机			
EMCA-EC-67-...	1454243	EAMM-A-D40-67A	
配电机单元			
MTR-DCI-42S-...-G7	543155	EAMM-A-D40-42B	
MTR-DCI-42S-...-G14	543156	EAMM-A-D40-42C	
配一体式电机和减速机			
EMCA-EC-67-...	vw560282	EAMM-A-D40-40G ²⁾	
EMGC-40-...	2256398	EAMM-A-D40-40G-G2	
EMCA-EC-67-...	1454242	EAMM-A-D40-60H	
EMGC-60-...			

用于旋转运动电机/减速机 ¹⁾		轴向安装组件	
型号	订货号	型号	
EHMB-32			
配伺服电机			
EMMS-AS-70-...	543161	EAMM-A-D60-70A	
EMME-AS-80-...	vw1977073	EAMM-A-D60-80P	
EMME-AS-100-...	vw550983	EAMM-A-D60-100A	
EMMS-AS-100-...	vw550983	EAMM-A-D60-100A	
配伺服电机和减速机			
EMMS-AS-55-...	vw560283	EAMM-A-D60-60G	
EMGA-60-P-G...-SAS-55			
EMMS-AS-70-...	vw560283	EAMM-A-D60-60G	
EMGA-60-P-G...-SAS-70			
配步进电机			
EMMS-ST-87-...	vw543162	EAMM-A-D60-87A	
配步进电机和减速机			
EMMS-ST-57-...	vw560283	EAMM-A-D60-60G	
EMGA-60-P-G...-SST-57			
配电机单元			
MTR-DCI-52S-...-G7	543163	EAMM-A-D60-52B	
MTR-DCI-52S-...-G14	543164	EAMM-A-D60-52C	
配一体式电机和减速机			
EMCA-EC-67-...	1454245	EAMM-A-D60-60H	
EMGC-60-...			

- 1) 输入扭矩不得超过轴向安装组件的最大可传递扭矩。
- 2) 型号停产

Festo 核心产品范围

q 24 小时内从 Festo 工厂发出
vw 最多 5 天内发货

轴向安装组件 EAMM-A

技术参数

FESTO

材料:

联轴器壳体, 联轴器毂, 电机法兰:

铝

螺丝: 镀锌钢



主要技术参数						
型号	适用轴	可传递扭矩 [Nm]	转动惯量 [kgmm ²]	最大转速 [rpm]	重量 [g]	→ 页码
EAMM-A-D19-28A	EGSL	1.1	0.28	10000	80	50
EAMM-A-D19-40A	EGSL	1.1	0.28	10000	110	
EAMM-A-D19-40P	EGSL	1.1	0.28	10000	110	
EAMM-A-D19-42A	EGSL	1.1	0.28	10000	130	
EAMM-A-D32-32B	EHMB, ERMB	1.1	0.28	10000	150	
EAMM-A-D32-40A	EGSL, ESBF	1.1	0.28	10000	130	
EAMM-A-D32-40G	EGSL, ESBF	6.5	5.87	8000	420	
EAMM-A-D32-40P	EGSL, ESBF	1.1	0.28	10000	160	
EAMM-A-D32-35A-40A	EHMB, ERMB	4	5.87	8000	220	
EAMM-A-D32-35A-40P	EHMB, ERMB	4	5.87	8000	160	
EAMM-A-D32-42A	EGSL, EHMB, ERMB, ESBF	1.1	0.28	10000	140	
EAMM-A-D32-55A	EGSL, EHMB, ESBF	4	5.87	8000	260	
EAMM-A-D32-57A	EGSL, EHMB, ERMB, ESBF	4	5.87	8000	270	
EAMM-A-D32-60G	EGSL, ESBF	6.5	5.87	8000	540	
EAMM-A-D32-60H	EGSL, ESBF	6.5	5.87	8000	540	
EAMM-A-D32-60P	EGSL, EHMB, ERMB, ESBF	4	5.87	8000	410	
EAMM-A-D32-67A	EGSL, ESBF	6.5	5.87	8000	410	
EAMM-A-D40-40G	EHMB, ERMB, EGSL	8	5.87	8000	350	
EAMM-A-D40-40G-G2	EGSL, ESBF	8	5.87	8000	450	
EAMM-A-D40-42B	EHMB, ERMB	8	5.87	8000	340	
EAMM-A-D40-42C	EHMB, ERMB	8	5.87	8000	370	
EAMM-A-D40-55A	EGSL, EHMB, ERMB, ESBF	8	5.87	8000	350	
EAMM-A-D40-57A	EGSL, EHMB, ERMB, ESBF	6	5.87	8000	350	
EAMM-A-D40-60G	EGSL, ESBF	12.5	5.87	8000	570	
EAMM-A-D40-60H	EGSL, ESBF	12.5	5.87	8000	570	
EAMM-A-D40-60P	EGSL, EHMB, ERMB, ESBF	8	5.87	8000	430	
EAMM-A-D40-67A	EGSL, ESBF	12.5	5.87	8000	440	
EAMM-A-D40-70A	EGSL, EHMB, ERMB, ESBF	8	5.87	8000	410	
EAMM-A-D40-87A	EGSL, EHMB, ERMB, ESBF	8	5.87	8000	530	
EAMM-A-D50-60G	ESBF	17	34.8	6000	570	
EAMM-A-D50-60H	ESBF	17	34.8	6000	570	
EAMM-A-D50-70A	ESBF	12	34.8	6000	740	
EAMM-A-D50-80G	ESBF	17	34.8	6000	1190	
EAMM-A-D50-80P	ESBF	14	34.8	6000	890	
EAMM-A-D50-87A	ESBF	12	34.8	6000	860	
EAMM-A-D50-100A	ESBF	14	34.8	6000	1140	

轴向安装组件 EAMM-A

技术参数

FESTO

主要技术参数						
型号	适用轴	可传递扭矩 [Nm]	转动惯量 [kgmm ²]	最大转速 [rpm]	重量 [g]	→ 页码
EAMM-A-D60-52B	EHMB, ERMB	14	34.8	6000	930	50
EAMM-A-D60-52C	EHMB, ERMB	14	34.8	6000	1020	
EAMM-A-D60-60G	EHMB, ERMB, EGSL	12	34.8	6000	830	
EAMM-A-D60-60G-G2	EGSL, ESBF	12	34.8	6000	1350	
EAMM-A-D60-60H	EGSL, ESBF	17	34.8	6000	1250	
EAMM-A-D60-70A	EGSL, EHMB, ERMB, ESBF	12	34.8	6000	750	
EAMM-A-D60-80G	EGSL, ESBF	17	34.8	6000	1350	
EAMM-A-D60-80P	EGSL, EHMB, ERMB, ESBF	14	34.8	6000	1040	
EAMM-A-D60-87A	EGSL, EHMB, ERMB, ESBF	12	34.8	6000	890	
EAMM-A-D60-100A	EGSL, EHMB, ERMB, ESBF	14	34.8	6000	1170	
EAMM-A-D80-80G	ESBF	60	128	5500	1990	
EAMM-A-D80-100A	ESBF	60	128	5500	2030	
EAMM-A-D80-140A	ESBF	60	128	5500	2920	
EAMM-A-D100-100A	ESBF	60	128	5500	2450	
EAMM-A-D100-120G	ESBF	143	280	4500	3520	
EAMM-A-D100-140A	ESBF	143	280	4500	3460	
EAMM-A-E20-32B	DMES	1.5	0.23	10000	100	46
EAMM-A-E20-40A	DGE-SP, DMES	1	0.13	12000	80	
EAMM-A-E20-42A	DGE-SP, DMES	1	0.13	12000	100	
EAMM-A-E20-55A	DGE-SP, DMES	1	0.13	12000	140	
EAMM-A-E32-40A	DGE-SP, DMES	7.5	6.1	8000	250	
EAMM-A-E32-40G	DGE-SP, DMES	7.5	6.1	8000	290	
EAMM-A-E32-42B	DMES	6.5	5.87	8000	340	
EAMM-A-E32-42C	DMES	6.5	5.87	8000	380	
EAMM-A-E32-55A	DGE-SP, DMES	7.5	6.1	8000	280	
EAMM-A-E32-57A	DGE-SP, DMES	7.5	6.1	8000	290	
EAMM-A-E32-67A	DMES	7.5	6.1	8000	380	
EAMM-A-E48-40G	DGE-SP	8.8	6.1	8000	550	
EAMM-A-E48-44A-70A	DGE-SP	9.2	6.1	8000	600	
EAMM-A-E48-52B	DMES	17	34.8	6000	1120	
EAMM-A-E48-52C	DMES	17	34.8	6000	1210	
EAMM-A-E48-55A	DGE-SP	8.5	6.1	8000	530	
EAMM-A-E48-57A	DGE-SP	7.5	6.1	8000	540	
EAMM-A-E48-60H	DGE-SP	17	42.3	6500	920	
EAMM-A-E48-64A-70A	DMES	17	42.3	6500	790	
EAMM-A-E48-67A	DGE-SP	17	42.3	6500	900	
EAMM-A-E48-87A	DGE-SP, DMES	17	42.3	6500	1500	
EAMM-A-E48-100A	DGE-SP, DMES	17	42.3	6500	1280	
EAMM-A-E72-60G	DGE-SP, DMES	17	42.3	6500	3190	
EAMM-A-E72-60H	DGE-SP	17	42.3	6500	2590	
EAMM-A-E72-70A	DGE-SP, DMES	17	42.3	6500	2370	
EAMM-A-E72-80G	DGE-SP, DMES	17	42.3	6500	3190	
EAMM-A-E72-87A	DGE-SP, DMES	17	42.3	6500	3040	
EAMM-A-E72-100A	DGE-SP, DMES	17	42.3	6500	3240	
EAMM-A-F28-40G	DGEA	8.2	6.1	8000	280	49
EAMM-A-F28-57A	DGEA	7.5	6.1	8000	280	
EAMM-A-F28-60G	DGEA	8.2	6.1	8000	350	
EAMM-A-F28-60H	DGEA	8.2	6.1	8000	370	
EAMM-A-F28-87A	DGEA	8.2	6.1	8000	450	

轴向安装组件 EAMM-A

技术参数

FESTO

主要技术参数						
型号	适用轴	可传递扭矩 [Nm]	转动惯量 [kgmm ²]	最大转速 [rpm]	重量 [g]	→ 页码
EAMM-A-F30-40G	DGE-ZR	8.2	6.1	8000	280	42
EAMM-A-F30-55A	DGE-ZR	8.2	6.1	8000	270	
EAMM-A-F30-57A	DGE-ZR	7.5	6.1	8000	280	
EAMM-A-F30-60G	DGE-ZR	8.2	6.1	8000	410	
EAMM-A-F30-60H	DGE-ZR	8.2	6.1	8000	370	
EAMM-A-F30-70A	DGE-ZR	8.2	6.1	8000	330	
EAMM-A-F30-87A	DGE-ZR	8.2	6.1	8000	440	
EAMM-A-F32-60G	DGEA	17	42.3	6500	920	49
EAMM-A-F32-60H	DGEA	17	42.3	6500	810	
EAMM-A-F32-87A	DGEA	17	42.3	6500	770	
EAMM-A-F37-40G	DGE-ZR	8.2	6.1	8000	280	42
EAMM-A-F37-55A	DGE-ZR	8.2	6.1	8000	270	
EAMM-A-F37-57A	DGE-ZR	7.5	6.1	8000	270	
EAMM-A-F37-60G	DGE-ZR	8.2	6.1	8000	350	
EAMM-A-F37-60H	DGE-ZR	8.2	6.1	8000	370	
EAMM-A-F37-70A	DGE-ZR	8.2	6.1	8000	330	
EAMM-A-F37-87A	DGE-ZR	8.2	6.1	8000	480	
EAMM-A-F40-70A	DGE-ZR	17	42.3	6500	640	
EAMM-A-F40-80G	DGE-ZR, DGEA	17	42.3	6500	890	
EAMM-A-F40-87A	DGE-ZR	17	42.3	6500	790	
EAMM-A-F40-100A	DGE-ZR	17	42.3	6500	940	
EAMM-A-F47-80G	DGE-ZR	17	42.3	6500	1000	
EAMM-A-F47-87A	DGE-ZR	17	42.3	6500	780	
EAMM-A-F47-100A	DGE-ZR	17	42.3	6500	1010	
EAMM-A-F47-140A	DGE-ZR	17	42.3	6500	1930	
EAMM-A-F62-80G	DGE-ZR	85	417	4500	2760	
EAMM-A-F62-100A	DGE-ZR	85	417	4500	2540	
EAMM-A-F62-120G	DGE-ZR	92	417	4500	2480	
EAMM-A-F62-140A	DGE-ZR	92	417	4500	2780	
EAMM-A-F80-80G	DGE-ZR	85	417	4500	2810	
EAMM-A-F80-100A	DGE-ZR	85	417	4500	2560	
EAMM-A-F80-120G	DGE-ZR	92	417	4500	2730	
EAMM-A-F80-140A	DGE-ZR	92	417	4500	2640	
EAMM-A-F80-160G	DGE-ZR	92	417	4500	5240	
EAMM-A-G13-40A	DGE-ZR	1	0.13	12000	80	
EAMM-A-G13-42A	DGE-ZR	1	0.13	12000	90	
EAMM-A-G16-40A	DGE-ZR	1	0.13	12000	80	
EAMM-A-G16-42A	DGE-ZR	1	0.13	12000	120	
EAMM-A-G16-55A	DGE-ZR	1	0.13	12000	140	
EAMM-A-G19-40A	DGE-ZR	1.5	0.47	8000	160	
EAMM-A-G19-40G	DGE-ZR	1.5	0.47	8000	190	
EAMM-A-G19-55A	DGE-ZR	1.5	0.47	8000	190	
EAMM-A-G19-57A	DGE-ZR	1.5	0.47	8000	200	
EAMM-A-G19-67A	DGE-ZR	1.5	0.47	8000	290	

轴向安装组件 EAMM-A

技术参数

FESTO

主要技术参数						
型号	适用轴	可传递扭矩 [Nm]	转动惯量 [kgmm ²]	最大转速 [rpm]	重量 [g]	→ 页码
EAMM-A-L27-40G	EGC-TB	2	0.445	10000	180	58
EAMM-A-L27-55A	EGC-TB	2	0.445	10000	220	
EAMM-A-L27-57A	EGC-TB	1.6	0.355	10000	180	
EAMM-A-L27-67A	EGC-TB	2	0.445	10000	290	
EAMM-A-L38-55A	EGC-TB	4.4	0.445	8000	210	
EAMM-A-L38-57A	EGC-TB	3.6	3.2	8000	220	
EAMM-A-L38-60G	EGC-TB	4.4	3.2	8000	350	
EAMM-A-L38-60H	EGC-TB	4.4	3.3	8000	340	
EAMM-A-L38-60P	EGC-TB	4.4	3.3	8000	300	
EAMM-A-L38-70A	EGC-TB	4.4	3.2	8000	290	
EAMM-A-L38-87A	EGC-TB	4.4	3.2	8000	480	
EAMM-A-L48-60G	EGC-TB	12.5	14.5	8000	490	
EAMM-A-L48-60H	EGC-TB	12.5	14.5	8000	430	
EAMM-A-L48-70A	EGC-TB	12.5	14.5	8000	350	
EAMM-A-L48-80P	EGC-TB	17	39	6000	660	
EAMM-A-L48-87A	EGC-TB	12.5	14.5	8000	590	
EAMM-A-L48-100A	EGC-TB	17	39	6000	990	
EAMM-A-L62-80G	EGC-TB	47	147	5500	1620	
EAMM-A-L62-100A	EGC-TB	47	147	5500	1610	
EAMM-A-L62-140A	EGC-TB	47	147	5500	2420	
EAMM-A-L95-80G-G2	ELGA-TB	120	374	4500	2771	
EAMM-A-L95-120G-G2	ELGA-TB, EGC-TB	150	374	4500	2935	
EAMM-A-L95-140A-G2	ELGA-TB, EGC-TB	143	374	4500	3175	
EAMM-A-L95-190A-G2	ELGA-TB, EGC-TB	192	374	4500	4900	
EAMM-A-M43-60G	EGC-HD-TB	12.5	14.5	8000	340	
EAMM-A-M43-60H	EGC-HD-TB	12.5	14.5	8000	330	
EAMM-A-M48-60H	EGC-HD-TB	21	39	6000	320	
EAMM-A-M48-80G	EGC-HD-TB	21	39	6000	870	
EAMM-A-M80-120G	EGC-HD-TB	75	147	5500	1370	
EAMM-A-N38-60G	ELGA-TB	12.5	14.5	8000	470	
EAMM-A-N38-60H	ELGA-TB	12.5	14.5	8000	460	
EAMM-A-N38-70A	ELGA-TB	12.5	14.5	8000	430	
EAMM-A-N38-87A	ELGA-TB	12.5	14.5	8000	646	
EAMM-A-N48-60G	ELGA-TB	12.5	14.5	8000	509	
EAMM-A-N48-60H	ELGA-TB	12.5	14.5	8000	470	
EAMM-A-N48-80G	ELGA-TB	21	39	6000	1080	
EAMM-A-N48-100A	ELGA-TB	17	39	6000	1070	
EAMM-A-N80-80G	ELGA-TB	47	147	5500	1290	
EAMM-A-N80-120G	ELGA-TB	47	147	5500	1990	
EAMM-A-N80-140A	ELGA-TB	47	147	5500	2070	
EAMM-A-S38-40A-G2	EGC-BS, EGC-HD-BS, ELGA-BS	6.5	5.87	8000	270	
EAMM-A-S38-40G-G2	EGC-BS, EGC-HD-BS, ELGA-BS	6.5	5.87	8000	410	
EAMM-A-S38-40P-G2	EGC-BS, EGC-HD-BS, ELGA-BS	6.5	5.87	8000	280	
EAMM-A-S38-42A-G2	EGC-BS, EGC-HD-BS, ELGA-BS	3.5	5.87	8000	310	
EAMM-A-S38-55A-G2	EGC-BS, EGC-HD-BS, ELGA-BS	6.5	5.87	8000	340	
EAMM-A-S38-57A-G2	EGC-BS, EGC-HD-BS, ELGA-BS	6.5	5.87	8000	340	
EAMM-A-S38-60P-G2	EGC-BS, EGC-HD-BS, ELGA-BS	6.5	5.87	8000	420	
EAMM-A-S38-67A-G2	EGC-BS, EGC-HD-BS, ELGA-BS	6.5	5.87	8000	492	
EAMM-A-S48-40G-G2	EGC-BS, EGC-HD-BS, ELGA-BS	12.5	5.87	8000	420	
EAMM-A-S48-55A-G2	EGC-BS, EGC-HD-BS, ELGA-BS	12.5	5.87	8000	370	

轴向安装组件 EAMM-A

技术参数

FESTO

主要技术参数						
型号	适用轴	可传递扭矩 [Nm]	转动惯量 [kgmm ²]	最大转速 [rpm]	重量 [g]	→ 页码
EAMM-A-S48-57A-G2	EGC-BS, EGC-HD-BS, ELGA-BS	6.5	5.87	8000	570	60, 69
EAMM-A-S48-60G-G2	EGC-BS, EGC-HD-BS, ELGA-BS	12.5	5.87	8000	440	
EAMM-A-S48-60H-G2	EGC-BS, EGC-HD-BS, ELGA-BS	12.5	5.87	8000	430	
EAMM-A-S48-60P-G2	EGC-BS, EGC-HD-BS, ELGA-BS	12.5	5.87	8000	440	
EAMM-A-S48-70A-G2	EGC-BS, EGC-HD-BS, ELGA-BS	12.5	5.87	8000	450	
EAMM-A-S48-87A-G2	EGC-BS, EGC-HD-BS, ELGA-BS	12.5	5.87	8000	590	
EAMM-A-S62-60G-G2	EGC-BS, EGC-HD-BS, ELGA-BS	17	42.3	6500	1110	
EAMM-A-S62-60H-G2	EGC-BS, EGC-HD-BS, ELGA-BS	17	42.3	6500	1100	
EAMM-A-S62-70A-G2	EGC-BS, EGC-HD-BS, ELGA-BS	17	45.5	6000	1040	
EAMM-A-S62-80G-G2	EGC-BS, EGC-HD-BS, ELGA-BS	17	34.8	6000	1180	
EAMM-A-S62-80P-G2	EGC-BS, EGC-HD-BS, ELGA-BS	17	34.8	6000	970	
EAMM-A-S62-87A-G2	EGC-BS, EGC-HD-BS, ELGA-BS	17	45.5	6000	1150	
EAMM-A-S62-100A-G2	EGC-BS, EGC-HD-BS, ELGA-BS	17	34.8	6000	1240	
EAMM-A-S62-140A-G2	EGC-BS, EGC-HD-BS, ELGA-BS	17	34.8	6000	2060	
EAMM-A-S95-100A-G2	EGC-BS, EGC-HD-BS, ELGA-BS	60	128	5500	2880	
EAMM-A-S95-140A-G2	EGC-BS, EGC-HD-BS, ELGA-BS	60	128	5500	3650	
EAMM-A-P3-28D-28A	EGSK	0.2	0.28	10000	30	71
EAMM-A-P3-28D-40P	EGSK	0.2	0.28	10000	60	
EAMM-A-P4-28B-28A	EGSK, EGSP	0.7	0.28	10000	40	
EAMM-A-P4-28B-40A	EGSK, EGSP	0.7	0.28	10000	50	
EAMM-A-P4-28B-40P	EGSK, EGSP	0.7	0.28	10000	50	
EAMM-A-P4-28B-42A	EGSK, EGSP	0.7	0.28	10000	60	
EAMM-A-P5-28B-28A	EGSK, EGSP	1.1	0.28	10000	40	
EAMM-A-P5-28B-40A	EGSK, EGSP	1.1	0.28	10000	50	
EAMM-A-P5-28B-40P	EGSK, EGSP	1.1	0.28	10000	50	
EAMM-A-P5-28B-42A	EGSK, EGSP	1.1	0.28	10000	60	
EAMM-A-P6-38A-40A	EGSK, EGSP	6.5	5.87	8000	100	
EAMM-A-P6-38A-40G	EGSK	6.5	5.87	8000	190	
EAMM-A-P6-38A-40P	EGSK	6.5	5.87	8000	110	
EAMM-A-P6-38A-42A	EGSK, EGSP	3.5	5.87	8000	160	
EAMM-A-P6-38A-55A	EGSK, EGSP	6.5	5.87	8000	130	
EAMM-A-P6-38A-57A	EGSK, EGSP	6.5	5.87	8000	130	
EAMM-A-P6-38A-60P	EGSK	6.5	5.87	8000	210	
EAMM-A-P6-38A-67A	EGSK	6.5	5.87	8000	230	
EAMM-A-P8-38A-40A	EGSK, EGSP	6.5	5.87	8000	100	
EAMM-A-P8-38A-40G	EGSK, EGSP	12.5	5.87	8000	190	
EAMM-A-P8-38A-40P	EGSK, EGSP	12.5	5.87	8000	110	
EAMM-A-P8-38A-42A	EGSK, EGSP	3.5	5.87	8000	160	
EAMM-A-P8-38A-55A	EGSK, EGSP	12.5	5.87	8000	130	
EAMM-A-P8-38A-57A	EGSK, EGSP	6.5	5.87	8000	130	
EAMM-A-P8-38A-60P	EGSK, EGSK	12.5	5.87	8000	210	
EAMM-A-P8-38A-67A	EGSK, EGSK	12.5	5.87	8000	230	
EAMM-A-P8-38A-70A	EGSK, EGSP	12.5	5.87	8000	200	
EAMM-A-P8-38A-87A	EGSK, EGSP	12.5	5.87	8000	380	
EAMM-A-P10-38A-40G	EGSP	12.5	5.87	8000	190	
EAMM-A-P10-38A-55A	EGSP	12.5	5.87	8000	130	
EAMM-A-P10-38A-57A	EGSP	6.5	5.87	8000	130	
EAMM-A-P10-38A-60P	EGSP	12.5	5.87	8000	210	
EAMM-A-P10-38A-67A	EGSP	12.5	5.87	8000	230	
EAMM-A-P10-38A-70A	EGSP	12.5	5.87	8000	200	
EAMM-A-P10-38A-87A	EGSP	12.5	5.87	8000	380	

轴向安装组件 EAMM-A

技术参数

FESTO

主要技术参数						
型号	适用轴	可传递扭矩 [Nm]	转动惯量 [kgmm ²]	最大转速 [rpm]	重量 [g]	→ 页码
EAMM-A-R27-40G	ELGG, ELGR	2	0.445	10000	240	74
EAMM-A-R27-55A	ELGG, ELGR	2	0.445	10000	170	
EAMM-A-R27-57A	ELGG, ELGR	1.6	0.355	10000	170	
EAMM-A-R27-67A	ELGG, ELGR	2	0.445	10000	280	
EAMM-A-R38-40G	ELGG, ELGR	9	3.2	8000	330	
EAMM-A-R38-57A	ELGG, ELGR	3.6	3.2	8000	280	
EAMM-A-R38-60P	ELGG, ELGR	4.4	3.3	8000	350	
EAMM-A-R38-60G	ELGG, ELGR	4.4	3.2	8000	390	
EAMM-A-R38-60H	ELGG, ELGR	4.4	3.3	8000	480	
EAMM-A-R38-70A	ELGG, ELGR	4.4	3.2	8000	350	
EAMM-A-R38-87A	ELGG, ELGR	4.4	3.2	8000	530	
EAMM-A-R48-60G	ELGG, ELGR	12.5	14.5	8000	480	
EAMM-A-R48-60H	ELGG, ELGR	12.5	14.5	8000	480	
EAMM-A-R48-70A	ELGG, ELGR	12.5	14.5	8000	450	
EAMM-A-R48-80P	ELGG, ELGR	17	39	6000	710	
EAMM-A-R48-87A	ELGG, ELGR	12.5	14.5	8000	590	
EAMM-A-R48-100A	ELGG, ELGR	17	39	6000	970	
EAMM-A-T42-57A	EGSC, ELGC-BS, ELGC-TB	6.5	3.2	8000	330	67
EAMM-A-T42-87A	EGSC, ELGC-BS, ELGC-TB	10	3.2	8000	400	
EAMM-A-T42-60P	EGSC, ELGC-BS, ELGC-TB	10	3.2	8000	310	
EAMM-A-T42-80P	EGSC, ELGC-BS, ELGC-TB	10	5.76	8000	490	
EAMM-A-T46-87A	ELGC-BS, ELGC-TB	10	3.2	8000	630	
EAMM-A-T46-60P	ELGC-BS, ELGC-TB	10	3.2	8000	410	
EAMM-A-T46-80P	ELGC-BS, ELGC-TB	10	5.76	8000	500	
EAMM-A-T46-100A	ELGC-BS, ELGC-TB	10	5.76	8000	1080	
EAMM-A-V20-28A	EGSC	0.2	0.022	10000	27	
EAMM-A-V25-42A	EGSC, ELGC-BS	0.5	0.19	10000	89	
EAMM-A-V25-40P	EGSC, ELGC-BS	0.5	0.19	10000	89	
EAMM-A-V32-42A	EGSC, ELGC-BS, ELGC-TB	1	0.19	10000	120	
EAMM-A-V32-57A	EGSC, ELGC-BS, ELGC-TB	1.5	0.19	10000	180	
EAMM-A-V32-40P	EGSC, ELGC-BS, ELGC-TB	1.5	0.19	10000	110	
EAMM-A-V32-60P	EGSC, ELGC-BS, ELGC-TB	1.5	1	10000	210	

工作和环境条件

环境温度	[°C]	-10 ... +60
贮存温度	[°C]	-25 ... +60
防护等级 ¹⁾		
EAMM-A-...		IP40
EAMM-A-...-S1		IP65
相对空气湿度	[%]	0 ... 95
耐腐蚀等级 CRC ²⁾		1
材料注意事项		RoHS 合规

1) 仅可组合连接的电机和气缸

2) 耐腐蚀等级 1，符合 Festo FN 940 070 标准
低度耐腐蚀能力。运输和贮存防护。也适用于不可见的内部区域或位于盖子下面的元件（如，气缸耳轴）。

轴向安装组件 EAMM-A

技术参数

FESTO

尺寸

CAD 相关数据 → www.festo.com

DGE-ZR-...

EAMM-A-G-...

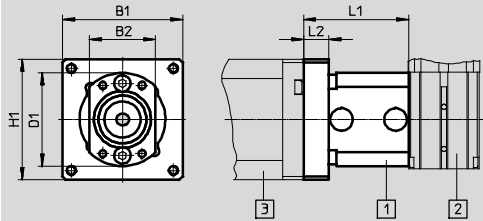

EAMM-A-F-...

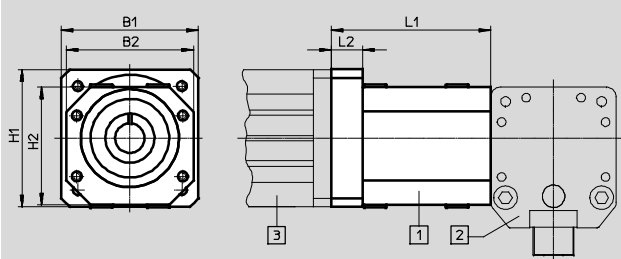

图示:

- 1 轴向安装组件
- 2 齿形带式电缸
- 3 电机

型号	B1	B2	H1	H2	L1	L2
EAMM-A-F30-40G	50	45	50	45	57.7	17.7
EAMM-A-F30-55A	55	45	55	45	51.4	105
EAMM-A-F30-57A	56.4	45	56.4	45	52.7	12
EAMM-A-F30-60G	60	45	60	45	60.7	23
EAMM-A-F30-60H	60	45	60	45	60.7	20
EAMM-A-F30-70A	70	45	70	45	54.2	13.5
EAMM-A-F30-87A	85.8	45	85.8	45	56.2	15.5
EAMM-A-F37-40G	50	45	50	45	57.7	17.7
EAMM-A-F37-55A	55	45	55	45	51.4	15
EAMM-A-F37-57A	56.4	45	56.4	45	52.7	10
EAMM-A-F37-60G	60	45	60	45	60.7	11.5
EAMM-A-F37-60H	60	45	60	45	60.7	20
EAMM-A-F37-70A	70	45	70	45	54.2	14.5
EAMM-A-F37-87A	85.8	45	85.8	45	56.2	19
EAMM-A-F40-70A	70	65	70	60	81.2	16
EAMM-A-F40-80G	90	65	90	60	89.4	24
EAMM-A-F40-87A	85.8	65	85.8	60	82.7	17.5
EAMM-A-F40-100A	100	65	100	60	86.2	21
EAMM-A-F47-80G	90	65	90	60	89.4	8.3
EAMM-A-F47-87A	85.8	65	85.8	60	82.7	12.5
EAMM-A-F47-100A	100	65	100	60	86.2	5
EAMM-A-F47-140A	138	65	138	60	95.2	105

轴向安装组件 EAMM-A

技术参数

尺寸

CAD 相关数据 → www.festo.com

DGE-ZR-...

EAMM-A-G-...

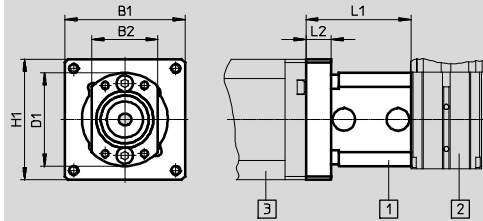

EAMM-A-F-...

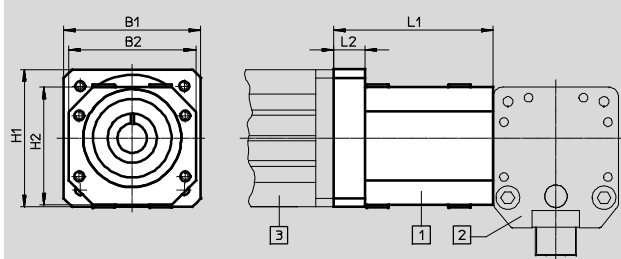

图示:



- 1 轴向安装组件
- 2 齿形带式电缸
- 3 电机

型号	B1	B2	D1	H1	H2	L1	L2
EAMM-A-F62-80G	115	100	-	115	100	119.2	28
EAMM-A-F62-100A	100	100	-	105	100	116.2	25
EAMM-A-F62-120G	115	100	-	115	100	119.2	28
EAMM-A-F62-140A	138	100	-	138	100	111.2	20
EAMM-A-F80-80G	115	100	-	115	100	119.2	12
EAMM-A-F80-100A	100	100	-	105	100	116.2	21
EAMM-A-F80-120G	115	100	-	115	100	119.2	10.5
EAMM-A-F80-140A	138	100	-	138	100	111.2	12
EAMM-A-F80-160G	160	100	-	160	100	151.2	21
EAMM-A-G13-40A	40	22	29	40	-	33.9	8.3
EAMM-A-G13-42A	42	22	29	42	-	42.2	16.5
EAMM-A-G16-40A	40	22	31	40	-	34.9	8.3
EAMM-A-G16-42A	42	22	31	42	-	42.4	18
EAMM-A-G16-55A	55	22	31	55	-	37.7	11
EAMM-A-G19-40A	48	31	44.5	48	-	38.5	9.5
EAMM-A-G19-40G	50	31	44.5	50	-	46	17
EAMM-A-G19-55A	55	31	44.5	55	-	39.7	10.5
EAMM-A-G19-57A	56.4	31	44.5	56.4	-	41	12
EAMM-A-G19-67A	67	31	44.5	67	-	45.1	16

轴向安装组件 EAMM-A

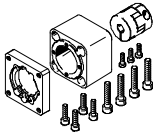

技术参数

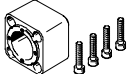
FESTO

订货数据 - 单个元件			
轴向安装组件	包括:		
	电机法兰	联轴器	联轴器壳体
			
订货号 型号	订货号 型号	订货号 型号	订货号 型号
1454254 EAMM-A-F30-40G	550986 EAMF-A-44A/B-40G	123050 EAMC-30-35-8-10	124628 EAMK-A-F30-44A
550929 EAMM-A-F30-55A	529942 EAMF-A-44A/B-55A	557390 EAMC-30-35-8-9	124628 EAMK-A-F30-44A
550930 EAMM-A-F30-57A	530081 EAMF-A-44A/B-57A	530088 EAMC-30-35-6.35-8	124628 EAMK-A-F30-44A
550931 EAMM-A-F30-60G	529944 EAMF-A-44A/B-60G	123042 EAMC-30-35-8-11	124628 EAMK-A-F30-44A
1454255 EAMM-A-F30-60H	1780430 EAMF-A-44A-60G/H	1453063 EAMC-30-35-8-14	124628 EAMK-A-F30-44A
550932 EAMM-A-F30-70A	529943 EAMF-A-44A/B-70A	123042 EAMC-30-35-8-11	124628 EAMK-A-F30-44A
550933 EAMM-A-F30-87A	530082 EAMF-A-44A/B-87A	123042 EAMC-30-35-8-11	124628 EAMK-A-F30-44A
1454257 EAMM-A-F37-40G	550986 EAMF-A-44A/B-40G	123050 EAMC-30-35-8-10	534394 EAMK-A-F37-44A/C
550942 EAMM-A-F37-55A	529942 EAMF-A-44A/B-55A	557390 EAMC-30-35-8-9	534394 EAMK-A-F37-44A/C
550943 EAMM-A-F37-57A	530081 EAMF-A-44A/B-57A	530088 EAMC-30-35-6.35-8	534394 EAMK-A-F37-44A/C
550944 EAMM-A-F37-60G	529944 EAMF-A-44A/B-60G	123042 EAMC-30-35-8-11	534394 EAMK-A-F37-44A/C
1454258 EAMM-A-F37-60H	1780430 EAMF-A-44A-60G/H	1453063 EAMC-30-35-8-14	534394 EAMK-A-F37-44A/C
550945 EAMM-A-F37-70A	529943 EAMF-A-44A/B-70A	123042 EAMC-30-35-8-11	534394 EAMK-A-F37-44A/C
550946 EAMM-A-F37-87A	530082 EAMF-A-44A/B-87A	123042 EAMC-30-35-8-11	534394 EAMK-A-F37-44A/C
550934 EAMM-A-F40-70A	529945 EAMF-A-64A/B-70A	550998 EAMC-40-66-11-15	124629 EAMK-A-F40-64A
550935 EAMM-A-F40-80G	533139 EAMF-A-64A/C-80G	123845 EAMC-40-66-15-20	124629 EAMK-A-F40-64A
550936 EAMM-A-F40-87A	533140 EAMF-A-64A/B-87A	550998 EAMC-40-66-11-15	124629 EAMK-A-F40-64A
550937 EAMM-A-F40-100A	529947 EAMF-A-64A/C/D-100A	123844 EAMC-40-66-15-19	124629 EAMK-A-F40-64A
550947 EAMM-A-F47-80G	533139 EAMF-A-64A/C-80G	123845 EAMC-40-66-15-20	534395 EAMK-A-F47-64A
550948 EAMM-A-F47-87A	533140 EAMF-A-64A/B-87A	550998 EAMC-40-66-11-15	534395 EAMK-A-F47-64A
550949 EAMM-A-F47-100A	529947 EAMF-A-64A/C/D-100A	123844 EAMC-40-66-15-19	534395 EAMK-A-F47-64A
550950 EAMM-A-F47-140A	550988 EAMF-A-64A-140A	176033 EAMC-40-66-15-24	534395 EAMK-A-F47-64A

轴向安装组件 EAMM-A

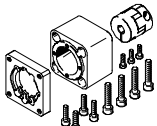
技术参数

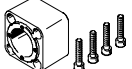
订货数据 – 单个元件			
轴向安装组件	包括:		
	电机法兰	联轴器	联轴器壳体
			
订货号 型号	订货号 型号	订货号 型号	订货号 型号
550938 EAMM-A-F62-80G	550989 EAMF-A-118A-80G	176035 EAMC-65-90-20-25	124630 EAMK-A-F62-118A/B/C
550939 EAMM-A-F62-100A	529949 EAMF-A-118C-100A	551000 EAMC-65-90-19-25	124630 EAMK-A-F62-118A/B/C
550940 EAMM-A-F62-120G	550990 EAMF-A-118A-120G	123853 EAMC-65-90-25-25	124630 EAMK-A-F62-118A/B/C
550941 EAMM-A-F62-140A	550991 EAMF-A-118B-140A	123852 EAMC-65-90-24-25	124630 EAMK-A-F62-118A/B/C
550951 EAMM-A-F80-80G	550989 EAMF-A-118A-80G	176035 EAMC-65-90-20-25	534396 EAMK-A-F80-118A/B/C
550952 EAMM-A-F80-100A	529949 EAMF-A-118C-100A	551000 EAMC-65-90-19-25	534396 EAMK-A-F80-118A/B/C
550953 EAMM-A-F80-120G	550990 EAMF-A-118A-120G	123853 EAMC-65-90-25-25	534396 EAMK-A-F80-118A/B/C
550954 EAMM-A-F80-140A	550991 EAMF-A-118B-140A	123852 EAMC-65-90-24-25	534396 EAMK-A-F80-118A/B/C
550955 EAMM-A-F80-160G	550992 EAMF-A-118A-160G	551001 EAMC-65-90-25-40	534396 EAMK-A-F80-118A/B/C
550921 EAMM-A-G13-40A	540301 EAMF-A-28A/30A-40A	540750 EAMC-B-15-22-4-6	171186 EAMK-A-G13-28A
550922 EAMM-A-G13-42A	530080 EAMF-A-28A-42A	530084 EAMC-B-15-22-4-5	171186 EAMK-A-G13-28A
550923 EAMM-A-G16-40A	540301 EAMF-A-28A/30A-40A	540750 EAMC-B-15-22-4-6	171185 EAMK-A-G16-30A
550924 EAMM-A-G16-42A	530079 EAMF-A-30A-42A	530084 EAMC-B-15-22-4-5	171185 EAMK-A-G16-30A
550925 EAMM-A-G16-55A	534807 EAMF-A-30A-55A	184262 EAMC-B-15-22-4-9	171185 EAMK-A-G16-30A
550926 EAMM-A-G19-40A	550985 EAMF-A-44A/B-40A	184265 EAMC-B-19-24-6-6	170375 EAMK-A-G19-44B
1454259 EAMM-A-G19-40G	550986 EAMF-A-44A/B-40G	1450210 EAMC-B-19-24-6-10	170375 EAMK-A-G19-44B
550927 EAMM-A-G19-55A	529942 EAMF-A-44A/B-55A	184263 EAMC-B-19-24-6-9	170375 EAMK-A-G19-44B
550928 EAMM-A-G19-57A	530081 EAMF-A-44A/B-57A	530086 EAMC-B-19-24-6-6.35	170375 EAMK-A-G19-44B
1454260 EAMM-A-G19-67A	1476305 EAMF-A-44A/B/C-67A-S1	184263 EAMC-B-19-24-6-9	170375 EAMK-A-G19-44B

轴向安装组件 EAMM-A

技术参数

FESTO

尺寸

CAD 相关数据 → www.festo.com

DGE-SP-...

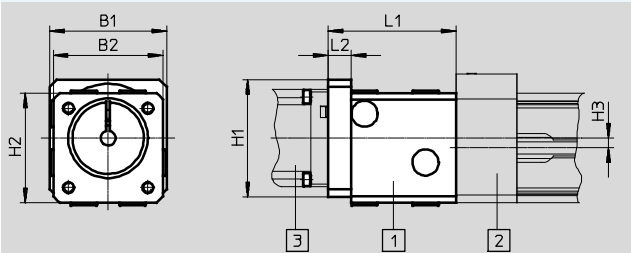

图示:

- 1 轴向安装组件
- 2 丝杆式电缸
- 3 电机

DMES-...

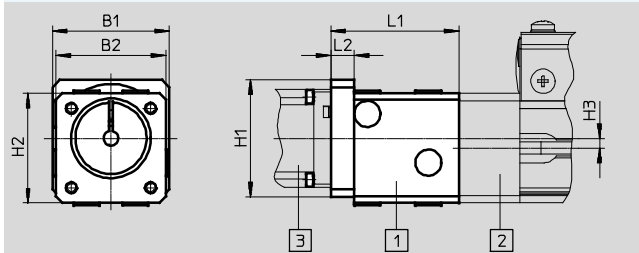

图示:

- 1 轴向安装组件
- 2 定位轴
- 3 电机

型号	B1	B2	H1	H2	H3	L1	L2
EAMM-A-E20-32B	–	33.6	–	41	–	27 ^{-0.2}	7
EAMM-A-E20-40A	40	33.5	40	31.5	–	27.5	8.3
EAMM-A-E20-42A	42	33.5	42	31.5	–	35.7	5
EAMM-A-E20-55A	55	33.5	55	31.5	–	29.5	10.5
EAMM-A-E32-40A	48	45	48	45	4	52.5	9.5
EAMM-A-E32-40G	50	45	50	45	4	60	17
EAMM-A-E32-42B	–	44.8	–	54.4	4	88	23
EAMM-A-E32-42C	–	44.8	–	54.4	4	101	36
EAMM-A-E32-55A	55	45	55	45	4	53.7	10.5
EAMM-A-E32-57A	56.4	45	56.4	45	4	55	12
EAMM-A-E32-67A	67	45	67	45	4	59.1	16
EAMM-A-E48-40G	50	64 ^{-0.3}	50	64 ^{-0.3}	5	63.5	17
EAMM-A-E48-44A-70A	70	64 ^{-0.3}	70	64 ^{-0.3}	5	60	13.5
EAMM-A-E48-52B	–	63.8	–	76.4	5	121	25
EAMM-A-E48-52C	–	63.8	–	76.4	5	135	39
EAMM-A-E48-55A	55	64 ^{-0.3}	55	64 ^{-0.3}	5	57.2	10.5
EAMM-A-E48-57A	56.4	64 ^{-0.3}	56.4	64 ^{-0.3}	5	58.5	12
EAMM-A-E48-60H	70	65 ^{-0.3}	70	64 ^{-0.3}	5	94.4	24
EAMM-A-E48-64A-70A	70	65 ^{-0.3}	70	64 ^{-0.3}	5	86.2	16
EAMM-A-E48-67A	75	65 ^{-0.3}	75	64 ^{-0.3}	5	88.6	18
EAMM-A-E48-87A	85.8	65 ^{-0.3}	85.8	64 ^{-0.3}	5	87.7	17.5
EAMM-A-E48-100A	100	65 ^{-0.3}	100	64 ^{-0.3}	5	91.2	21
EAMM-A-E72-60G	70	105.6	70	114.8	8	106.9	24.4
EAMM-A-E72-60H	70	105.6	70	114.8	8	106.9	24.4
EAMM-A-E72-70A	70	105.6	70	114.8	8	98.7	16
EAMM-A-E72-80G	90	105.6	90	114.8	8	106.9	24
EAMM-A-E72-87A	85.8	105.6	85.8	114.8	8	100.2	17.5
EAMM-A-E72-100A	100	105.6	100	114.8	8	103.7	21

轴向安装组件 EAMM-A

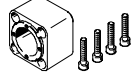

技术参数

订货数据 – 单个元件			
轴向安装组件	包括:		
	电机法兰	联轴器	联轴器壳体
			
订货号 型号	订货号 型号	订货号 型号	订货号 型号
556991 EAMM-A-E20-32B	–	533707 EAMC-15-20-5-6	533703 EAMK-A-E20-32B
550961 EAMM-A-E20-40A	552163 EAMF-A-28B-40A	540751 EAMC-B-15-22-5-6	170374 EAMK-A-E20-28B
550962 EAMM-A-E20-42A	552164 EAMF-A-28B-42A	530085 EAMC-B-15-22-5-5	170374 EAMK-A-E20-28B
550963 EAMM-A-E20-55A	529946 EAMF-A-28A/B-55A	529953 EAMC-B-15-22-5-9	170374 EAMK-A-E20-28B
550964 EAMM-A-E32-40A	550985 EAMF-A-44A/B-40A	123040 EAMC-30-35-6-6	124631 EAMK-A-E32-44A
1454247 EAMM-A-E32-40G	550986 EAMF-A-44A/B-40G	1453062 EAMC-30-35-6-10	124631 EAMK-A-E32-44A
556992 EAMM-A-E32-42B	–	533708 EAMC-30-32-6-8	533704 EAMK-A-E32-42B
556993 EAMM-A-E32-42C	–	533708 EAMC-30-32-6-8	538578 EAMK-A-E32-42C
550965 EAMM-A-E32-55A	529942 EAMF-A-44A/B-55A	530941 EAMC-30-35-6-9	124631 EAMK-A-E32-44A
550966 EAMM-A-E32-57A	530081 EAMF-A-44A/B-57A	530087 EAMC-30-35-6-6.35	124631 EAMK-A-E32-44A
1454246 EAMM-A-E32-67A	1476305 EAMF-A-44A/B/C-67A-S1	530941 EAMC-30-35-6-9	124631 EAMK-A-E32-44A
550968 EAMM-A-E48-40G	550986 EAMF-A-44A/B-40G	552640 EAMC-30-35-10-12	124632 EAMK-A-E48-44A
550971 EAMM-A-E48-44A-70A	529943 EAMF-A-44A/B-70A	123051 EAMC-30-35-11-12	124632 EAMK-A-E48-44A
556994 EAMM-A-E48-52B	–	533709 EAMC-42-50-12-12	533705 EAMK-A-E48-52B
556995 EAMM-A-E48-52C	–	533709 EAMC-42-50-12-12	538579 EAMK-A-E48-52C
550969 EAMM-A-E48-55A	529942 EAMF-A-44A/B-55A	550996 EAMC-30-35-9-12	124632 EAMK-A-E48-44A
550970 EAMM-A-E48-57A	530081 EAMF-A-44A/B-57A	550995 EAMC-30-35-6.35-12	124632 EAMK-A-E48-44A
1454249 EAMM-A-E48-60H	550987 EAMF-A-64A/B-60G/H	1452803 EAMC-40-66-12-14	529940 EAMK-A-E48-64A
557448 EAMM-A-E48-64A-70A	529945 EAMF-A-64A/B-70A	525864 EAMC-40-66-11-12	529940 EAMK-A-E48-64A
1454248 EAMM-A-E48-67A	1460114 EAMF-A-64A/B-67A-S1	1731999 EAMC-40-66-9-12	529940 EAMK-A-E48-64A
550972 EAMM-A-E48-87A	533140 EAMF-A-64A/B-87A	525864 EAMC-40-66-11-12	529940 EAMK-A-E48-64A
550973 EAMM-A-E48-100A	529947 EAMF-A-64A/C/D-100A	529952 EAMC-40-66-12-19	529940 EAMK-A-E48-64A

轴向安装组件 EAMM-A

技术参数

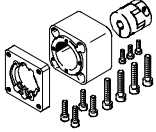
FESTO

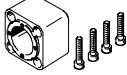
订货数据 - 单个元件			
轴向安装组件	包括:		
	电机法兰	联轴器	联轴器壳体
			
订货号 型号	订货号 型号	订货号 型号	订货号 型号
550974 EAMM-A-E72-60G	550987 EAMF-A-64A/B-60G/H	550999 EAMC-40-66-11-20	529941 EAMK-A-E72-64A
1454250 EAMM-A-E72-60H	550987 EAMF-A-64A/B-60G/H	1452809 EAMC-40-66-14-20	529941 EAMK-A-E72-64A
550975 EAMM-A-E72-70A	529945 EAMF-A-64A/B-70A	550999 EAMC-40-66-11-20	529941 EAMK-A-E72-64A
550976 EAMM-A-E72-80G	533139 EAMF-A-64A/C-80G	123849 EAMC-40-66-20-20	529941 EAMK-A-E72-64A
550977 EAMM-A-E72-87A	533140 EAMF-A-64A/B-87A	550999 EAMC-40-66-11-20	529941 EAMK-A-E72-64A
550978 EAMM-A-E72-100A	529947 EAMF-A-64A/C/D-100A	123847 EAMC-40-66-19-20	529941 EAMK-A-E72-64A

轴向安装组件 EAMM-A

技术参数

尺寸

CAD 相关数据 → www.festo.com

DGEA-...

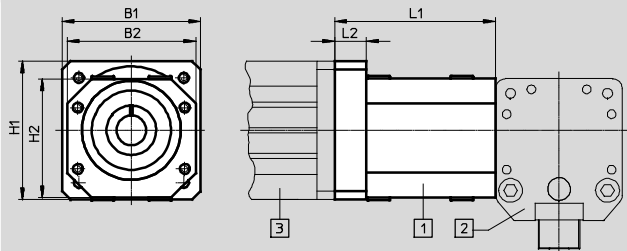

图示:

- 1 轴向安装组件
- 2 Cantilever axis
- 3 电机

型号	B1	B2	H1	H2	L1	L2
EAMM-A-F28-40G	50	45	50	45	57.7	17.7
EAMM-A-F28-57A	56.4	45	56.4	45	52.7	12
EAMM-A-F28-60G	60	45	60	45	60.7	20
EAMM-A-F28-60H	60	45	60	45	60.7	20
EAMM-A-F28-87A	85.8	45	85.8	45	56.2	15.5
EAMM-A-F32-60G	70	65	70	60	89.4	24
EAMM-A-F32-60H	70	65	70	60	89.4	24
EAMM-A-F32-87A	85.8	65	85.8	60	82.7	17.5
EAMM-A-F40-80G	90	65	90	60	89.4	24

订货数据 - 单个元件

轴向安装组件

包括:

	电机法兰	联轴器	联轴器壳体
订货号 型号	订货号 型号	订货号 型号	订货号 型号
1454251 EAMM-A-F28-40G	550986 EAMF-A-44A/B-40G	123050 EAMC-30-35-8-10	530468 EAMK-A-F28-44A
550956 EAMM-A-F28-57A	530081 EAMF-A-44A/B-57A	530088 EAMC-30-35-6.35-8	530468 EAMK-A-F28-44A
550957 EAMM-A-F28-60G	529944 EAMF-A-44A/B-60G	123042 EAMC-30-35-8-11	530468 EAMK-A-F28-44A
1454252 EAMM-A-F28-60H	1780430 EAMF-A-44A-60G/H	1453063 EAMC-30-35-8-14	530468 EAMK-A-F28-44A
550958 EAMM-A-F28-87A	530082 EAMF-A-44A/B-87A	123042 EAMC-30-35-8-11	530468 EAMK-A-F28-44A
550959 EAMM-A-F32-60G	550987 EAMF-A-64A/B-60G/H	530090 EAMC-40-66-11-11	530469 EAMK-A-F32-64A
1454256 EAMM-A-F32-60H	550987 EAMF-A-64A/B-60G/H	1452798 EAMC-40-66-11-14	530469 EAMK-A-F32-64A
550960 EAMM-A-F32-87A	533140 EAMF-A-64A/B-87A	530090 EAMC-40-66-11-11	530469 EAMK-A-F32-64A
550935 EAMM-A-F40-80G	533139 EAMF-A-64A/C-80G	123845 EAMC-40-66-15-20	124629 EAMK-A-F40-64A

轴向安装组件 EAMM-A

技术参数

FESTO

尺寸

CAD 相关数据 → www.festo.com

EGSL-...

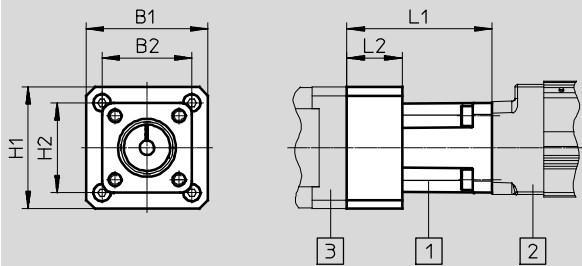

图示:

- 1 轴向安装组件
- 2 小型滑台式电缸
- 3 电机

ESBF-... 防护等级 IP40

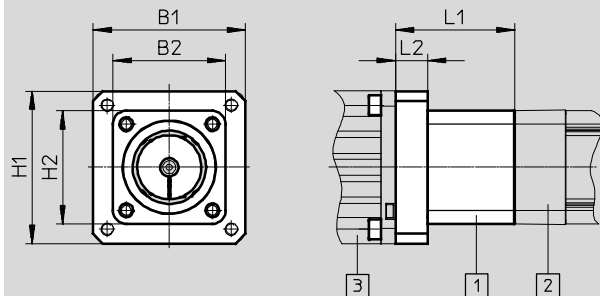

图示:

- 1 轴向安装组件
- 2 有杆电缸
- 3 电机

ERMB-...

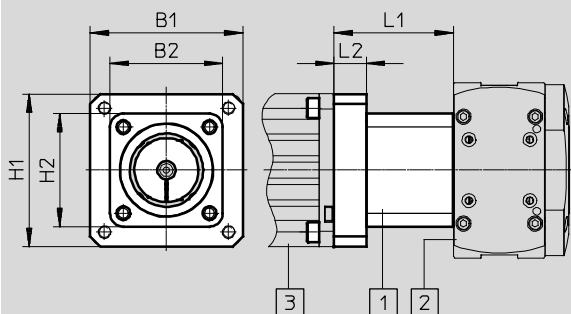

图示:

- 1 轴向安装组件
- 2 Rotary module
- 3 电机

EHMB-...

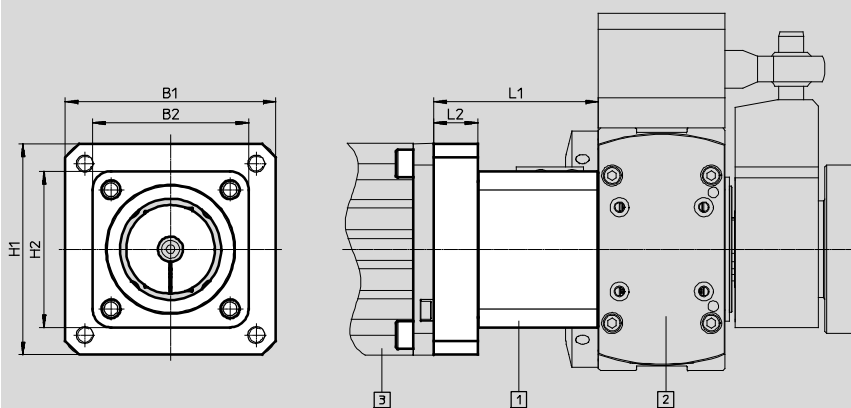

图示:

- 1 轴向安装组件
- 2 旋转/升降模块
- 3 电机

轴向安装组件 EAMM-A

技术参数



FESTO

型号	B1	B2	H1	H2	L1	L2
EAMM-A-D19-28A	30	31	30	31	46.2	15
EAMM-A-D19-40A	40	31	40	31	42.7	11.5
EAMM-A-D19-40P	39.7	31	39.7	31	45.7	14.5
EAMM-A-D19-42A	42	31	42	31	50	19
EAMM-A-D32-32B	33.6	45	41	45	43	-
EAMM-A-D32-35A-40A	-	40	-	40	46	-
EAMM-A-D32-35A-40P	-	39.7	-	39.7	49.5	-
EAMM-A-D32-40A	40	45	40	45	39.8	8.3
EAMM-A-D32-40G	60	45	60	45	62.5	24
EAMM-A-D32-40P	39.7	45	39.7	45	44	12.5
EAMM-A-D32-42A	42	45	42	45	48	5
EAMM-A-D32-55A	55	45	55	45	49.2	10.5
EAMM-A-D32-57A	56.4	45	56.4	45	50.5	12
EAMM-A-D32-60G	75	45	75	45	66.5	28
EAMM-A-D32-60H	75	45	75	45	66.5	28
EAMM-A-D32-60P	61.4	45	61.4	45	59.7	21
EAMM-A-D32-67A	67	45	67	45	54.6	16
EAMM-A-D40-40G	50	53.5	50	53.5	55.5	17
EAMM-A-D40-40G-G2	60	53.5	60	53.5	62.5	24
EAMM-A-D40-42B	44.8	53.5	54.4	53.5	88	9
EAMM-A-D40-42C	44.8	53.5	54.4	53.5	101	9
EAMM-A-D40-55A	55	53.5	55	53.5	49.2	10.5
EAMM-A-D40-57A	56.4	53.5	56.4	53.5	50.5	12
EAMM-A-D40-60G	75	53.5	75	53.5	66.5	28
EAMM-A-D40-60H	75	53.5	75	53.5	66.5	28
EAMM-A-D40-60P	61.4	53.5	61.4	53.5	59.7	21
EAMM-A-D40-67A	67	53.5	67	53.5	54.6	16
EAMM-A-D40-70A	70	53.5	70	53.5	52	13.5
EAMM-A-D40-87A	85.8	53.5	85.8	53.5	54	15.5
EAMM-A-D50-60G	90	74	90	74	87.7	35
EAMM-A-D50-60H	90	74	90	74	87.7	35
EAMM-A-D50-70A	70	74	70	74	68.2	16.2
EAMM-A-D50-80G	101	74	101	74	92.4	30
EAMM-A-D50-80P	81.3	74	81.3	74	79.7	17.5
EAMM-A-D50-87A	85.8	74	85.8	74	69.7	17.5
EAMM-A-D50-100A	100	74	100	74	84.2	21.5
EAMM-A-D60-52B	63.8	74	76.4	74	112	13
EAMM-A-D60-52C	63.8	74	76.4	74	126	13
EAMM-A-D60-60G	70	74	70	74	71.4	24
EAMM-A-D60-60G-G2	90	74	90	74	82.4	35
EAMM-A-D60-60H	90	74	90	74	82.4	35
EAMM-A-D60-70A	70	74	70	74	63.2	16
EAMM-A-D60-80G	101	74	101	74	87.4	30
EAMM-A-D60-80P	81.3	74	81.3	74	74.7	17.5
EAMM-A-D60-87A	85.8	74	85.8	74	64.7	17.5
EAMM-A-D60-100A	100	74	100	74	78.2	21
EAMM-A-D80-80G	101	100	101	100	102	30
EAMM-A-D80-100A	100	100	100	100	92	20
EAMM-A-D80-140A	140.5	100	140.5	100	102	30
EAMM-A-D100-100A	100	112	100	112	99.5	20
EAMM-A-D100-120G	143	112	143	112	111.5	32
EAMM-A-D100-140A	140.5	112	140.5	112	109.5	30

轴向安装组件 EAMM-A

技术参数

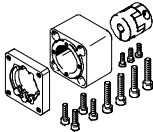
FESTO

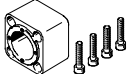
订货数据 - 单个元件			
轴向安装组件	包括:		
	电机法兰	联轴器	联轴器壳体
			
订货号 型号	订货号 型号	订货号 型号	订货号 型号
1081659 EAMM-A-D19-28A	1087613 EAMF-A-28D-28A	562676 EAMC-16-20-5-5	1087585 EAMK-A-D19-28D
1199152 EAMM-A-D19-40A	1199144 EAMF-A-28D-40A	543419 EAMC-16-20-5-6	1087585 EAMK-A-D19-28D
1981953 EAMM-A-D19-40P	1982014 EAMF-A-28D-40P	562677 EAMC-16-20-5-8	1087585 EAMK-A-D19-28D
1087642 EAMM-A-D19-42A	1087630 EAMF-A-28D-42A	562676 EAMC-16-20-5-5	1087585 EAMK-A-D19-28D
543149 EAMM-A-D32-32B	-	543420 EAMC-16-20-6-6	552156 EAMK-A-D32-32B
560281 EAMM-A-D32-35A-40A	-	558312 EAMC-30-32-6-6	560280 EAMK-A-D32-35A-40A
2207441 EAMM-A-D32-35A-40P	-	533708 EAMC-30-32-6-8	2207509 EAMK-A-D32-35A-40P
543147 EAMM-A-D32-40A	552163 EAMF-A-28B-40A	543420 EAMC-16-20-6-6	552155 EAMK-A-D32-28B
1454238 EAMM-A-D32-40G	1460095 EAMF-A-44C-40G-S1	562681 EAMC-30-32-6-10	551006 EAMK-A-D32-44A/C
vw1976465 EAMM-A-D32-40P	1976704 EAMF-A-28B-40P	1232854 EAMC-16-20-6-8	552155 EAMK-A-D32-28B
vw543148 EAMM-A-D32-42A	552164 EAMF-A-28B-42A	543419 EAMC-16-20-5-6	552155 EAMK-A-D32-28B
550979 EAMM-A-D32-55A	529942 EAMF-A-44A/B-55A	551003 EAMC-30-32-6-9	551006 EAMK-A-D32-44A/C
vw550980 EAMM-A-D32-57A	530081 EAMF-A-44A/B-57A	551002 EAMC-30-32-6-6.35	551006 EAMK-A-D32-44A/C
2946758 EAMM-A-D32-60G	1460105 EAMF-A-44C-60G/H-S1	318577 EAMC-30-32-6-11	551006 EAMK-A-D32-44A/C
2946760 EAMM-A-D32-60H	1460105 EAMF-A-44C-60G/H-S1	1233256 EAMC-30-32-6-14	551006 EAMK-A-D32-44A/C
vw1956054 EAMM-A-D32-60P	1956846 EAMF-A-44C-60P	1233256 EAMC-30-32-6-14	551006 EAMK-A-D32-44A/C
1454239 EAMM-A-D32-67A	1476305 EAMF-A-44A/B/C-67A-S1	551003 EAMC-30-32-6-9	551006 EAMK-A-D32-44A/C

Festo 核心产品范围

q 24 小时内从 Festo 工厂发出

vw 最多 5 天内发货

轴向安装组件 EAMM-A

技术参数



订货数据 - 单个元件			
轴向安装组件	包括:		
	电机法兰	联轴器	联轴器壳体
订货号 型号	订货号 型号	订货号 型号	订货号 型号
v 560282 EAMM-A-D40-40G	550986 EAMF-A-44A/B-40G	558029 EAMC-30-32-8-10	552157 EAMK-A-D40-44A/C
2256398 EAMM-A-D40-40G-G2	1460095 EAMF-A-44C-40G-S1	558029 EAMC-30-32-8-10	552157 EAMK-A-D40-44A/C
543155 EAMM-A-D40-42B	—	543422 EAMC-30-32-8-8	522158 EAMK-A-D40-42B
543156 EAMM-A-D40-42C	—	543422 EAMC-30-32-8-8	522159 EAMK-A-D40-42C
543153 EAMM-A-D40-55A	529942 EAMF-A-44A/B-55A	543423 EAMC-30-32-8-9	552157 EAMK-A-D40-44A/C
v 543154 EAMM-A-D40-57A	530081 EAMF-A-44A/B-57A	543421 EAMC-30-32-6.35-8	552157 EAMK-A-D40-44A/C
2256400 EAMM-A-D40-60G	1460105 EAMF-A-44C-60G/H-S1	551004 EAMC-30-32-8-11	552157 EAMK-A-D40-44A/C
1454242 EAMM-A-D40-60H	1460105 EAMF-A-44C-60G/H-S1	562682 EAMC-30-32-8-14	552157 EAMK-A-D40-44A/C
v 1977000 EAMM-A-D40-60P	1956846 EAMF-A-44C-60P	562682 EAMC-30-32-8-14	552157 EAMK-A-D40-44A/C
1454243 EAMM-A-D40-67A	1476305 EAMF-A-44A/B/C-67A-S1	543423 EAMC-30-32-8-9	552157 EAMK-A-D40-44A/C
550981 EAMM-A-D40-70A	529943 EAMF-A-44A/B-70A	551004 EAMC-30-32-8-11	552157 EAMK-A-D40-44A/C
v 550982 EAMM-A-D40-87A	530082 EAMF-A-44A/B-87A	551004 EAMC-30-32-8-11	552157 EAMK-A-D40-44A/C
2733786 EAMM-A-D50-60G	2256289 EAMF-A-64B-60G/H-S1	543424 EAMC-42-50-11-12	2733780 EAMK-A-D50-64B
2733796 EAMM-A-D50-60H	2256289 EAMF-A-64B-60G/H-S1	1455671 EAMC-42-50-12-14	2733780 EAMK-A-D50-64B
2733783 EAMM-A-D50-70A	529945 EAMF-A-64A/B-70A	543424 EAMC-42-50-11-12	2733780 EAMK-A-D50-64B
2733787 EAMM-A-D50-80G	2843290 EAMF-A-64C-80G-S1	2138701 EAMC-42-50-12-20	2836865 EAMK-A-D50-64C
v 2733785 EAMM-A-D50-80P	1977113 EAMF-A-64A/C-80P	551005 EAMC-42-50-12-19	2836865 EAMK-A-D50-64C
v 2733781 EAMM-A-D50-87A	533140 EAMF-A-64A/B-87A	543424 EAMC-42-50-11-12	2733780 EAMK-A-D50-64B
v 2733784 EAMM-A-D50-100A	529947 EAMF-A-64A/C/D-100A	551005 EAMC-42-50-12-19	2836865 EAMK-A-D50-64C



Festo 核心产品范围

q 24 小时内从 Festo 工厂发出
v 最多 5 天内发货

轴向安装组件 EAMM-A

技术参数

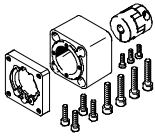
FESTO

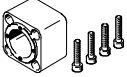
订货数据 - 单个元件			
轴向安装组件	包括:		
	电机法兰	联轴器	联轴器壳体
			
订货号 型号	订货号 型号	订货号 型号	订货号 型号
543163 EAMM-A-D60-52B	-	533709 EAMC-42-50-12-12	552161 EAMK-A-D60-52B
543164 EAMM-A-D60-52C	-	533709 EAMC-42-50-12-12	552162 EAMK-A-D60-52C
vw560283 EAMM-A-D60-60G	550987 EAMF-A-64A/B-60G/H	543424 EAMC-42-50-11-12	552160 EAMK-A-D60-64B
2256696 EAMM-A-D60-60G-G2	2256289 EAMF-A-64B-60G/H-S1	543424 EAMC-42-50-11-12	552160 EAMK-A-D60-64B
1454245 EAMM-A-D60-60H	2256289 EAMF-A-64B-60G/H-S1	1455671 EAMC-42-50-12-14	552160 EAMK-A-D60-64B
543161 EAMM-A-D60-70A	529945 EAMF-A-64A/B-70A	543424 EAMC-42-50-11-12	552160 EAMK-A-D60-64B
1499402 EAMM-A-D60-80G	2843290 EAMF-A-64C-80G-S1	2138701 EAMC-42-50-12-20	551007 EAMK-A-D60-64C
vw1977073 EAMM-A-D60-80P	1977113 EAMF-A-64A/C-80P	551005 EAMC-42-50-12-19	551007 EAMK-A-D60-64C
vw543162 EAMM-A-D60-87A	533140 EAMF-A-64A/B-87A	543424 EAMC-42-50-11-12	552160 EAMK-A-D60-64B
vw550983 EAMM-A-D60-100A	529947 EAMF-A-64A/C/D-100A	551005 EAMC-42-50-12-19	551007 EAMK-A-D60-64C
2946763 EAMM-A-D80-80G	2933286 EAMF-A-77A-80G-S1	3181801 EAMC-56-58-19-20	1593627 EAMK-A-D80-77A
1589665 EAMM-A-D80-100A	1593628 EAMF-A-77A-100A	1485673 EAMC-56-58-19-19	1593627 EAMK-A-D80-77A
1588299 EAMM-A-D80-140A	1593636 EAMF-A-77A-140A	1485674 EAMC-56-58-19-24	1593627 EAMK-A-D80-77A
3356796 EAMM-A-D100-100A	1593628 EAMF-A-77A-100A	1485674 EAMC-56-58-19-24	1593914 EAMK-A-D100-77A/B
2449341 EAMM-A-D100-120G	2449380 EAMF-A-77B-120G-S1	3187895 EAMC-67-62-24-25	1593914 EAMK-A-D100-77A/B
1588349 EAMM-A-D100-140A	1593636 EAMF-A-77A-140A	1451407 EAMC-67-62-24-24	1593914 EAMK-A-D100-77A/B

Festo 核心产品范围

q 24 小时内从 Festo 工厂发出

vw 最多 5 天内发货

轴向安装组件 EAMM-A

技术参数

尺寸

CAD 相关数据 → www.festo.com

ESBF... 防护等级 IP65

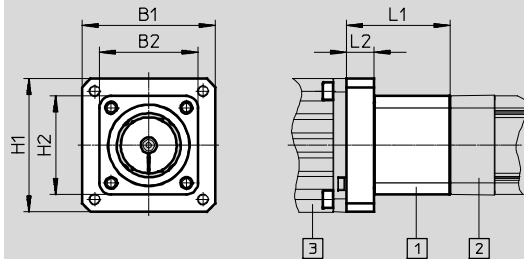

图示:



- 1 轴向安装组件
- 2 有杆电缸
- 3 电机

型号	B1	B2	H1	H2	L1	L2
EAMM-A-D32-40A-S1	40	45	40	45	41.3	8.8
EAMM-A-D32-40G-S1	60	45	60	45	62.5	24
EAMM-A-D32-40P-S1	39.7	45	39.7	45	45.5	13
EAMM-A-D32-42A-S1	42	45	42	45	49.5	5.5
EAMM-A-D32-55A-S1	55	45	55	45	50.7	11
EAMM-A-D32-57A-S1	56.4	45	56.4	45	52	12.5
EAMM-A-D32-60G-S1	75	45	75	45	67.5	28.5
EAMM-A-D32-60H-S1	75	45	75	45	67.5	28.5
EAMM-A-D32-60P-S1	61.4	45	61.4	45	60.7	21
EAMM-A-D32-67A-S1	67	45	67	45	55.6	16
EAMM-A-D40-40G-S1	60	53.5	60	53.5	63.5	24.5
EAMM-A-D40-55A-S1	55	53.5	55	53.5	50.7	11
EAMM-A-D40-57A-S1	56.4	53.5	56.4	53.5	52	12.5
EAMM-A-D40-60G-S1	75	53.5	75	53.5	67.5	28.5
EAMM-A-D40-60H-S1	75	53.5	75	53.5	67.5	28.5
EAMM-A-D40-60P-S1	61.4	53.5	61.4	53.5	61.2	22
EAMM-A-D40-67A-S1	67	53.5	67	53.5	55.5	16.4
EAMM-A-D40-70A-S1	70	53.5	70	53.5	53.5	14
EAMM-A-D40-87A-S1	85.8	53.5	85.8	53.5	55.5	16
EAMM-A-D50-60G-S1	90	74	90	74	88.7	35.5
EAMM-A-D50-60H-S1	90	74	90	74	88.7	35.5
EAMM-A-D50-70A-S1	70	74	70	74	69.2	16.5
EAMM-A-D50-80G-S1	101	74	101	74	93.4	30.5
EAMM-A-D50-80P-S1	81.3	74	81.3	74	80.7	18
EAMM-A-D50-87A-S1	85.8	74	85.8	74	70.7	18
EAMM-A-D50-100A-S1	100	74	100	74	84.2	21.5
EAMM-A-D60-60G-S1	90	74	90	74	83.4	35.5
EAMM-A-D60-60H-S1	90	74	90	74	83.4	35.5
EAMM-A-D60-70A-S1	70	74	70	74	65	16.5
EAMM-A-D60-80G-S1	101	74	101	74	88.4	30.5
EAMM-A-D60-80P-S1	81.3	74	81.3	74	75.7	18
EAMM-A-D60-87A-S1	85.8	74	85.8	74	66.5	18
EAMM-A-D60-100A-S1	100	74	100	74	80	21.5
EAMM-A-D80-80G-S1	101	100	101	100	103.5	30.5
EAMM-A-D80-100A-S1	100	100	100	100	93.5	20.5
EAMM-A-D80-140A-S1	140.5	100	140.5	100	103.5	30.5
EAMM-A-D100-100A-S1	100	112	100	112	101	20
EAMM-A-D100-120G-S1	143	112	143	112	113	32.5
EAMM-A-D100-140A-S1	140.5	112	140.5	112	111	30.5

轴向安装组件 EAMM-A

技术参数

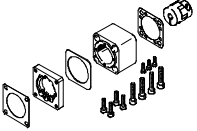
FESTO

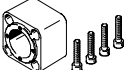
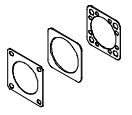
订货数据 - 单个元件				
轴向安装组件	包括:			
	电机法兰	联轴器	联轴器壳体	密封套件
				
订货号 型号	订货号 型号	订货号 型号	订货号 型号	订货号 型号
1322178 EAMM-A-D32-40A-S1	552163 EAMF-A-28B-40A	543420 EAMC-16-20-6-6	552155 EAMK-A-D32-28B	1561526 EADS-F-D32-40A
2256396 EAMM-A-D32-40G-S1	1460095 EAMF-A-44C-40G-S1	562681 EAMC-30-32-6-10	551006 EAMK-A-D32-44A/C	2253500 EADS-F-D32-40G
2207372 EAMM-A-D32-40P-S1	1976704 EAMF-A-28B-40P	1232854 EAMC-16-20-6-8	552155 EAMK-A-D32-28B	2207219 EADS-F-D32-40P
1322179 EAMM-A-D32-42A-S1	552164 EAMF-A-28B-42A	543419 EAMC-16-20-5-6	552155 EAMK-A-D32-28B	1561527 EADS-F-D32-42A
1322180 EAMM-A-D32-55A-S1	529942 EAMF-A-44A/B-55A	551003 EAMC-30-32-6-9	551006 EAMK-A-D32-44A/C	1561528 EADS-F-D32-55A
1322181 EAMM-A-D32-57A-S1	530081 EAMF-A-44A/B-57A	551002 EAMC-30-32-6-6.35	551006 EAMK-A-D32-44A/C	1561529 EADS-F-D32-57A
2946759 EAMM-A-D32-60G-S1	1460105 EAMF-A-44C-60G/H-S1	3187577 EAMC-30-32-6-11	551006 EAMK-A-D32-44A/C	8022150 EADS-F-D32-60G/H
2946761 EAMM-A-D32-60H-S1	1460105 EAMF-A-44C-60G/H-S1	1233256 EAMC-30-32-6-14	551006 EAMK-A-D32-44A/C	8022150 EADS-F-D32-60G/H
2234020 EAMM-A-D32-60P-S1	1956846 EAMF-A-44C-60P	1233256 EAMC-30-32-6-14	551006 EAMK-A-D32-44A/C	2234012 EADS-F-D32-60P
2256397 EAMM-A-D32-67A-S1	1476305 EAMF-A-44A/B/C-67A-S1	551003 EAMC-30-32-6-9	551006 EAMK-A-D32-44A/C	2253501 EADS-F-D32-67A
2256399 EAMM-A-D40-40G-S1	1460095 EAMF-A-44C-40G-S1	558029 EAMC-30-32-8-10	552157 EAMK-A-D40-44A/C	2253502 EADS-F-D40-40G
1322182 EAMM-A-D40-55A-S1	529942 EAMF-A-44A/B-55A	543423 EAMC-30-32-8-9	552157 EAMK-A-D40-44A/C	1561530 EADS-F-D40-55A
1322183 EAMM-A-D40-57A-S1	530081 EAMF-A-44A/B-57A	543421 EAMC-30-32-6.35-8	552157 EAMK-A-D40-44A/C	1561531 EADS-F-D40-57A
2256409 EAMM-A-D40-60G-S1	1460105 EAMF-A-44C-60G/H-S1	551004 EAMC-30-32-8-11	552157 EAMK-A-D40-44A/C	2253503 EADS-F-D40-60G/H
2256401 EAMM-A-D40-60H-S1	1460105 EAMF-A-44C-60G/H-S1	562682 EAMC-30-32-8-14	552157 EAMK-A-D40-44A/C	2253503 EADS-F-D40-60G/H
2151519 EAMM-A-D40-60P-S1	1956846 EAMF-A-44C-60P	562682 EAMC-30-32-8-14	552157 EAMK-A-D40-44A/C	2151545 EADS-F-D40-60P
2256695 EAMM-A-D40-67A-S1	1476305 EAMF-A-44A/B/C-67A-S1	543423 EAMC-30-32-8-9	552157 EAMK-A-D40-44A/C	2253504 EADS-F-D40-67A
1322185 EAMM-A-D40-70A-S1	529943 EAMF-A-44A/B-70A	551004 EAMC-30-32-8-11	552157 EAMK-A-D40-44A/C	1561532 EADS-F-D40-70A
1322186 EAMM-A-D40-87A-S1	530082 EAMF-A-44A/B-87A	551004 EAMC-30-32-8-11	552157 EAMK-A-D40-44A/C	1561533 EADS-F-D40-87A

轴向安装组件 EAMM-A

技术参数

FESTO

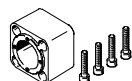
订货数据 - 单个元件				
轴向安装组件	包括:			
	电机法兰	联轴器	联轴器壳体	密封套件
				
订货号 型号	订货号 型号	订货号 型号	订货号 型号	订货号 型号
2734290 EAMM-A-D50-60G-S1	2256289 EAMF-A-64B-60G/H-S1	543424 EAMC-42-50-11-12	2733780 EAMK-A-D50-64B	2733792 EADS-F-D50-60G/H
2907418 EAMM-A-D50-60H-S1	2256289 EAMF-A-64B-60G/H-S1	1455671 EAMC-42-50-12-14	2733780 EAMK-A-D50-64B	2733792 EADS-F-D50-60G/H
2734287 EAMM-A-D50-70A-S1	529945 EAMF-A-64A/B-70A	543424 EAMC-42-50-11-12	2733780 EAMK-A-D50-64B	2733789 EADS-F-D50-70A
2734291 EAMM-A-D50-80G-S1	2843290 EAMF-A-64C-80G-S1	2138701 EAMC-42-50-12-20	2836865 EAMK-A-D50-64C	2733793 EADS-F-D50-80G
2734289 EAMM-A-D50-80P-S1	1977113 EAMF-A-64A/C-80P	551005 EAMC-42-50-12-19	2836865 EAMK-A-D50-64C	2733791 EADS-F-D50-80P
2734286 EAMM-A-D50-87A-S1	533140 EAMF-A-64A/B-87A	543424 EAMC-42-50-11-12	2733780 EAMK-A-D50-64B	2733788 EADS-F-D50-87A
2734288 EAMM-A-D50-100A-S1	529947 EAMF-A-64A/C/D-100A	551005 EAMC-42-50-12-19	2836865 EAMK-A-D50-64C	2733790 EADS-F-D50-100A
2256698 EAMM-A-D60-60G-S1	2256289 EAMF-A-64B-60G/H-S1	543424 EAMC-42-50-11-12	552160 EAMK-A-D60-64B	2253505 EADS-F-D60-60G/H
2256697 EAMM-A-D60-60H-S1	2256289 EAMF-A-64B-60G/H-S1	1455671 EAMC-42-50-12-14	552160 EAMK-A-D60-64B	2253505 EADS-F-D60-60G/H
2256699 EAMM-A-D60-70A-S1	529945 EAMF-A-64A/B-70A	543424 EAMC-42-50-11-12	552160 EAMK-A-D60-64B	8022145 EADS-F-D60-70A
2946762 EAMM-A-D60-80G-S1	2843290 EAMF-A-64C-80G-S1	2138701 EAMC-42-50-12-20	551007 EAMK-A-D60-64C	8022146 EADS-F-D60-80G
2218564 EAMM-A-D60-80P-S1	1977113 EAMF-A-64A/C-80P	551005 EAMC-42-50-12-19	551007 EAMK-A-D60-64C	2218523 EADS-F-D60-80P
1322188 EAMM-A-D60-87A-S1	533140 EAMF-A-64A/B-87A	543424 EAMC-42-50-11-12	552160 EAMK-A-D60-64B	1561536 EADS-F-D60-87A
2256700 EAMM-A-D60-100A-S1	529947 EAMF-A-64A/C/D-100A	551005 EAMC-42-50-12-19	551007 EAMK-A-D60-64C	2253507 EADS-F-D60-100A
2946764 EAMM-A-D80-80G-S1	2933286 EAMF-A-77A-80G-S1	3181801 EAMC-56-58-19-20	1593627 EAMK-A-D80-77A	8022147 EADS-F-D80-80G
1600673 EAMM-A-D80-100A-S1	1593628 EAMF-A-77A-100A	1485673 EAMC-56-58-19-19	1593627 EAMK-A-D80-77A	1593617 EADS-F-D80-100A
1600674 EAMM-A-D80-140A-S1	1593636 EAMF-A-77A-140A	1485674 EAMC-56-58-19-24	1593627 EAMK-A-D80-77A	1593671 EADS-F-D80-140A
3356931 EAMM-A-D100-100A-S1	1593628 EAMF-A-77A-100A	1485674 EAMC-56-58-19-24	1593914 EAMK-A-D100-77A/B	3356966 EADS-F-D100-100A
2946765 EAMM-A-D100-120G-S1	2449380 EAMF-A-77B-120G-S1	3187895 EAMC-67-62-24-25	1593914 EAMK-A-D100-77A/B	8022148 EADS-F-D100-120G
1600675 EAMM-A-D100-140A-S1	1593636 EAMF-A-77A-140A	1451407 EAMC-67-62-24-24	1593914 EAMK-A-D100-77A/B	1593991 EADS-F-D100-140A

轴向安装组件 EAMM-A

技术参数

FESTO

尺寸

CAD 相关数据 → www.festo.com

EGC-TB-...

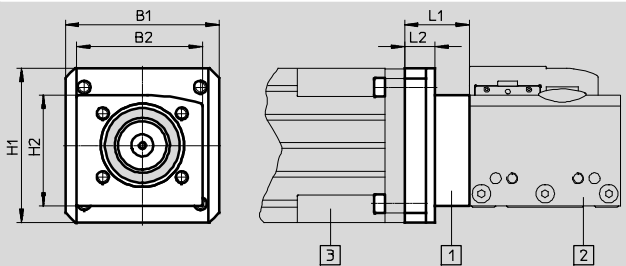

图示:

- 1 轴向安装组件
- 2 齿形带式电缸
- 3 电机

型号	B1	B2	H1	H2	L1	L2
EAMM-A-L27-40G	50	40	50	50	28.7	-
EAMM-A-L27-55A	55	40	55	55	23.1	-
EAMM-A-L27-57A	56	39.5	56	56	23.1	-
EAMM-A-L27-67A	67	41	67	67	28	-
EAMM-A-L38-55A	55	57.5	55	50.3	26.7	11
EAMM-A-L38-57A	56	57.5	56	50.3	26.7	11
EAMM-A-L38-60G	60	57.5	60	50.3	41.7	26
EAMM-A-L38-60H	60	57.5	60	50.3	41.7	24.5
EAMM-A-L38-60P	61.4	57.5	61.4	50.3	36.7	21
EAMM-A-L38-70A	70	57.5	70	50.3	29.5	13.8
EAMM-A-L38-87A	85.8	57.5	85.8	50.3	33.7	18
EAMM-A-L48-60G	60	65	60	61	52.5	24.5
EAMM-A-L48-60H	60	65	60	61	52.5	24.5
EAMM-A-L48-70A	70	65	70	61	40.2	12.2
EAMM-A-L48-80P	81.3	65	81.3	61	54	26
EAMM-A-L48-87A	85.8	65	85.8	61	44	16
EAMM-A-L48-100A	100.5	65	100.5	61	59	31
EAMM-A-L62-80G	100	100	100	90.5	62.5	14.5
EAMM-A-L62-100A	100.5	100	100.5	90.5	62.5	14.5
EAMM-A-L62-140A	140	100	140	90.5	72.5	24.5
EAMM-A-L95-120G-G2	114	140	114	120	81	32
EAMM-A-L95-140A-G2	140	140	140	120	76	27
EAMM-A-L95-190A-G2	190	140	190	120	86	37

订货数据 - 单个元件

轴向安装组件	包括:			
	电机法兰	联轴器	联轴器壳体	螺丝组
订货号 型号	订货号 型号	订货号 型号	订货号 型号	订货号 型号
557974 EAMM-A-L27-40G	558015 EAMF-A-L27-40G	557998 EAMD-19-15-10-8X10	-	-
557975 EAMM-A-L27-55A	558016 EAMF-A-L27-55A	557999 EAMD-19-15-9-8X10	-	-
560678 EAMM-A-L27-57A	560690 EAMF-A-L27-57A	561292 EAMD-16-15-6,35-8X10	-	-
1454261 EAMM-A-L27-67A	1460087 EAMF-A-L27-67A	557999 EAMD-19-15-9-8X10	-	-

Festo 核心产品范围

24 小时内从 Festo 工厂发出

最多 5 天内发货

轴向安装组件 EAMM-A

技术参数



订货数据 - 单个元件				
轴向安装组件	包括:			
	电机法兰	联轴器	联轴器壳体	螺丝组
订货号 型号	订货号 型号	订货号 型号	订货号 型号	订货号 型号
3683331 EAMM-A-L38-55A	558176 EAMF-A-38A-55A	3717923 EAMD-25-22-9-10X12	558011 EAMK-A-L38-38A	567484 EAHM-L2-M5-30
560679 EAMM-A-L38-57A	560692 EAMF-A-38A-57A	561293 EAMD-25-22-6,35-10X12	558011 EAMK-A-L38-38A	567484 EAHM-L2-M5-30
557978 EAMM-A-L38-60G	558017 EAMF-A-38A-60G/H	558000 EAMD-25-22-11-10X12	558011 EAMK-A-L38-38A	567485 EAHM-L2-M5-35
1456610 EAMM-A-L38-60H	558017 EAMF-A-38A-60G/H	1453861 EAMD-28-22-14-10X12	558011 EAMK-A-L38-38A	567485 EAHM-L2-M5-35
2037246 EAMM-A-L38-60P	1987412 EAMF-A-38A-60P	1453861 EAMD-28-22-14-10X12	558011 EAMK-A-L38-38A	567485 EAHM-L2-M5-35
557979 EAMM-A-L38-70A	558018 EAMF-A-38A-70A	558000 EAMD-25-22-11-10X12	558011 EAMK-A-L38-38A	567484 EAHM-L2-M5-30
560680 EAMM-A-L38-87A	560693 EAMF-A-38A-87A	558000 EAMD-25-22-11-10X12	558011 EAMK-A-L38-38A	567485 EAHM-L2-M5-35
557983 EAMM-A-L48-60G	558019 EAMF-A-48A-60G/H	558001 EAMD-32-32-11-16X20	558012 EAMK-A-L48-48A	567487 EAHM-L2-M5-45
1456611 EAMM-A-L48-60H	558019 EAMF-A-48A-60G/H	1377480 EAMD-32-32-14-16X20	558012 EAMK-A-L48-48A	567487 EAHM-L2-M5-45
557982 EAMM-A-L48-70A	558025 EAMF-A-48A-70A	558001 EAMD-32-32-11-16X20	558012 EAMK-A-L48-48A	567486 EAHM-L2-M5-40
2042616 EAMM-A-L48-80P	2043427 EAMF-A-48A-80P	558002 EAMD-42-40-19-16X25	558012 EAMK-A-L48-48A	567489 EAHM-L2-M5-55
560683 EAMM-A-L48-87A	560695 EAMF-A-48A-87A	558001 EAMD-32-32-11-16X20	558012 EAMK-A-L48-48A	567487 EAHM-L2-M5-45
557984 EAMM-A-L48-100A	558020 EAMF-A-48A-100A	558002 EAMD-42-40-19-16X25	558012 EAMK-A-L48-48A	567489 EAHM-L2-M5-55
557989 EAMM-A-L62-80G	558021 EAMF-A-62A-80G	558004 EAMD-56-46-20-23X27	558013 EAMK-A-L62-62A	567492 EAHM-L2-M6-65-L
557988 EAMM-A-L62-100A	558026 EAMF-A-62A-100A	558003 EAMD-56-46-19-23X27	558013 EAMK-A-L62-62A	567491 EAHM-L2-M6-65
557990 EAMM-A-L62-140A	558022 EAMF-A-62A-140A	558005 EAMD-56-46-24-23X27	558013 EAMK-A-L62-62A	567493 EAHM-L2-M6-70
3659941 EAMM-A-L95-120G-G2	3659724 EAMF-A-95A-120G-G2	558006 EAMD-67-51-25-32X32-U	3712650 EAMK-A-L95-95A/B-G2	567496 EAHM-L2-M8-70
3657226 EAMM-A-L95-140A-G2	558023 EAMF-A-95A-140A	558008 EAMD-67-51-24-32X32-U	3712650 EAMK-A-L95-95A/B-G2	567497 EAHM-L2-M8-80
3659562 EAMM-A-L95-190A-G2	1378473 EAMF-A-95A-190A	1379269 EAMD-67-51-32-32X32-U	3712650 EAMK-A-L95-95A/B-G2	567497 EAHM-L2-M8-80

Festo 核心产品范围

24 小时内从 Festo 工厂发出

最多 5 天内发货

轴向安装组件 EAMM-A

技术参数

FESTO

尺寸

CAD 相关数据 → www.festo.com

EGC-BS-...

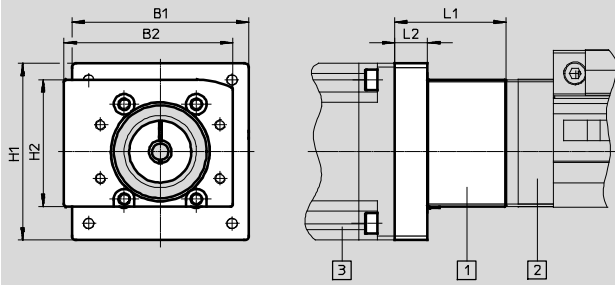

图示:

- 1 轴向安装组件
- 2 丝杆式电缸
- 3 电机

型号	B1	B2	H1	H2	L1	L2
EAMM-A-S38-40A-G2	58	55	44	44	44	7
EAMM-A-S38-40G-G2	60	55	60	44	54	17
EAMM-A-S38-40P-G2	58	55	44	44	44.7	10.7
EAMM-A-S38-42A-G2	58	55	44	44	52	15
EAMM-A-S38-55A-G2	55	55	55	44	48	11
EAMM-A-S38-57A-G2	56	55	56	55	48	11
EAMM-A-S38-60P-G2	61.4	55	61.4	44	58	21
EAMM-A-S38-67A-G2	67	55	67	44	53	16
EAMM-A-S48-40G-G2	60	70	60	53	55	17
EAMM-A-S48-55A-G2	70	70	55	53	47.2	9.2
EAMM-A-S48-57A-G2	70	70	55	53	47.2	9.2
EAMM-A-S48-60G-G2	60	70	60	53	62.5	24.5
EAMM-A-S48-60H-G2	60	70	60	53	62.5	24.5
EAMM-A-S48-60P-G2	61.4	70	61.4	53	57.2	19.2
EAMM-A-S48-70A-G2	70	70	70	53	50.2	12.2
EAMM-A-S48-87A-G2	85.8	70	85.8	53	54	16
EAMM-A-S62-60G-G2	80	80	80	70	84.5	18
EAMM-A-S62-60H-G2	80	80	80	70	84.5	18
EAMM-A-S62-70A-G2	82	80	70	70	78.5	12
EAMM-A-S62-80G-G2	100	80	100	70	81	14.5
EAMM-A-S62-80P-G2	81.3	80	81.3	70	77	10.5
EAMM-A-S62-87A-G2	85.8	80	85.8	70	81.5	15
EAMM-A-S62-100A-G2	100.5	80	100.5	70	81	14.5
EAMM-A-S62-140A-G2	140	80	140	70	91	24.5
EAMM-A-S95-100A-G2	140	140	100	110	85.5	17
EAMM-A-S95-140A-G2	140	140	140	110	95.5	27

轴向安装组件 EAMM-A

技术参数



订货数据 - 单个元件				
轴向安装组件	包括:			
	电机法兰	联轴器	联轴器壳体	螺丝组
订货号 型号	订货号 型号	订货号 型号	订货号 型号	订货号 型号
3637971 EAMM-A-S38-40A-G2	558175 EAMF-A-38B-40A	558312 EAMC-30-32-6-6	3637942 EAMK-A-S38-38A/B-G2	-
1456647 EAMM-A-S38-40G-G2	1460097 EAMF-A-38A-40G	562681 EAMC-30-32-6-10	3637942 EAMK-A-S38-38A/B-G2	567488 EAHM-L2-M5-50
vw3637972 EAMM-A-S38-40P-G2	2219077 EAMF-A-38B-40P	533708 EAMC-30-32-6-8	3637942 EAMK-A-S38-38A/B-G2	-
vw3637965 EAMM-A-S38-42A-G2	560691 EAMF-A-38B-42A	561333 EAMC-30-32-5-6	3637942 EAMK-A-S38-38A/B-G2	-
3637967 EAMM-A-S38-55A-G2	558176 EAMF-A-38A-55A	551003 EAMC-30-32-6-9	3637942 EAMK-A-S38-38A/B-G2	567488 EAHM-L2-M5-50
vw3637956 EAMM-A-S38-57A-G2	560692 EAMF-A-38A-57A	551002 EAMC-30-32-6-6.35	3637942 EAMK-A-S38-38A/B-G2	567488 EAHM-L2-M5-50
vw3637958 EAMM-A-S38-60P-G2	1987412 EAMF-A-38A-60P	1233256 EAMC-30-32-6-14	3637942 EAMK-A-S38-38A/B-G2	567489 EAHM-L2-M5-55
1456638 EAMM-A-S38-67A-G2	1490100 EAMF-A-38A-67A	551003 EAMC-30-32-6-9	3637942 EAMK-A-S38-38A/B-G2	567489 EAHM-L2-M5-55
1456650 EAMM-A-S48-40G-G2	4067069 EAMF-A-48B-40G	558029 EAMC-30-32-8-10	3637941 EAMK-A-S48-48A/B-G2	-
3637961 EAMM-A-S48-55A-G2	558177 EAMF-A-48B-55A	543423 EAMC-30-32-8-9	3637941 EAMK-A-S48-48A/B-G2	-
vw3637963 EAMM-A-S48-57A-G2	560694 EAMF-A-48B-57A	543421 EAMC-30-32-6.35-8	3637941 EAMK-A-S48-48A/B-G2	-
2256701 EAMM-A-S48-60G-G2	558019 EAMF-A-48A-60G/H	551004 EAMC-30-32-8-11	3637941 EAMK-A-S48-48A/B-G2	567489 EAHM-L2-M5-55
1456652 EAMM-A-S48-60H-G2	558019 EAMF-A-48A-60G/H	562682 EAMC-30-32-8-14	3637941 EAMK-A-S48-48A/B-G2	567489 EAHM-L2-M5-55
vw3637964 EAMM-A-S48-60P-G2	2220620 EAMF-A-48A-60P	562682 EAMC-30-32-8-14	3637941 EAMK-A-S48-48A/B-G2	567489 EAHM-L2-M5-55

Festo 核心产品范围





q 24 小时内从 Festo 工厂发出

vw 最多 5 天内发货

轴向安装组件 EAMM-A

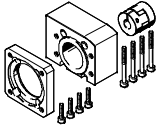
技术参数

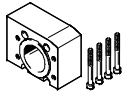
FESTO

订货数据 - 单个元件				
轴向安装组件	包括:			
	电机法兰	联轴器	联轴器壳体	螺丝组
				
订货号 型号	订货号 型号	订货号 型号	订货号 型号	订货号 型号
3637957 EAMM-A-S48-70A-G2	558025 EAMF-A-48A-70A	551004 EAMC-30-32-8-11	3637941 EAMK-A-S48-48A/B-G2	567488 EAHM-L2-M5-50
✓ 3637962 EAMM-A-S48-87A-G2	560695 EAMF-A-48A-87A	551004 EAMC-30-32-8-11	3637941 EAMK-A-S48-48A/B-G2	567489 EAHM-L2-M5-55
2297649 EAMM-A-S62-60G-G2	1460112 EAMF-A-62A-60G/H	525864 EAMC-40-66-11-12	3637940 EAMK-A-S62-62A/B-G2	567495 EAHM-L2-M6-90
1456654 EAMM-A-S62-60H-G2	1460112 EAMF-A-62A-60G/H	1452803 EAMC-40-66-12-14	3637940 EAMK-A-S62-62A/B-G2	567495 EAHM-L2-M6-90
3637959 EAMM-A-S62-70A-G2	558179 EAMF-A-62B-70A	558313 EAMC-42-66-11-12	3637940 EAMK-A-S62-62A/B-G2	-
1972530 EAMM-A-S62-80G-G2	2116672 EAMF-A-62B-80G	2138701 EAMC-42-50-12-20	3637940 EAMK-A-S62-62A/B-G2	-
✓ 3637970 EAMM-A-S62-80P-G2	2222624 EAMF-A-62B-80P	551005 EAMC-42-50-12-19	3637940 EAMK-A-S62-62A/B-G2	-
✓ 3637966 EAMM-A-S62-87A-G2	560696 EAMF-A-62B-87A	558313 EAMC-42-66-11-12	3637940 EAMK-A-S62-62A/B-G2	-
✓ 3637960 EAMM-A-S62-100A-G2	558026 EAMF-A-62A-100A	551005 EAMC-42-50-12-19	3637940 EAMK-A-S62-62A/B-G2	567494 EAHM-L2-M6-80
3637969 EAMM-A-S62-140A-G2	558022 EAMF-A-62A-140A	558314 EAMC-42-50-12-24	3637940 EAMK-A-S62-62A/B-G2	567495 EAHM-L2-M6-90
3637955 EAMM-A-S95-100A-G2	558182 EAMF-A-95B-100A	558315 EAMC-56-58-19-25	3637939 EAMK-A-S95-95A/B-G2	-
3637954 EAMM-A-S95-140A-G2	558023 EAMF-A-95A-140A	558316 EAMC-56-58-24-25	3637939 EAMK-A-S95-95A/B-G2	567498 EAHM-L2-M8-100

Festo 核心产品范围

q 24 小时内从 Festo 工厂发出

✓ 最多 5 天内发货

轴向安装组件 EAMM-A

技术参数

尺寸

CAD 相关数据 → www.festo.com

ELGA-...TB

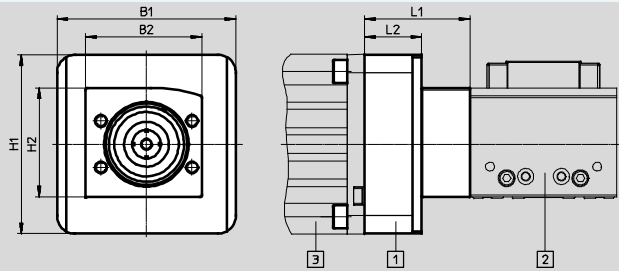

图示:





- 1 轴向安装组件
- 2 齿形带式电缸
- 3 电机

型号	B1	B2	H1	H2	L1	L2
EAMM-A-L95-80G-G2	140	140	140	120	66	17
EAMM-A-L95-120G-G2	114	140	114	120	81	32
EAMM-A-L95-140A-G2	140	140	140	120	76	27
EAMM-A-L95-190A-G2	190	140	190	120	86	37
EAMM-A-N38-60G	60	57.5	60	503	49.5	33
EAMM-A-N38-60H	60	57.5	60	503	49.5	33
EAMM-A-N38-70A	70	57.5	70	503	37.5	21
EAMM-A-N38-87A	85.5	57.5	85.5	503	42	25.5
EAMM-A-N48-60G	66	65	60	61	53.1	26
EAMM-A-N48-60H	66	65	60	61	53.1	26
EAMM-A-N48-80G	100	65	100	61	59.1	32
EAMM-A-N48-100A	100	65	100	61	59	31.9
EAMM-A-N80-80G	100	100	100	90.5	62.5	19
EAMM-A-N80-120G	124	100	124	90.5	77.5	34
EAMM-A-N80-140A	138	100	138	90.5	72.5	29

轴向安装组件 EAMM-A

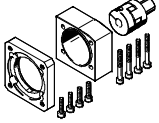
技术参数

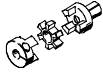
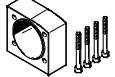
FESTO

订货数据 - 单个元件				
轴向安装组件	包括:			
	电机法兰	联轴器	联轴器壳体	螺丝组
				
订货号 型号	订货号 型号	订货号 型号	订货号 型号	订货号 型号
3660191 EAMM-A-L95-80G-G2	3305700 EAMF-A-95B-80G	3717812 EAMD-67-51-20-32X32-U	3712650 EAMK-A-L95-95A/B-G2	-
vw 3659941 EAMM-A-L95-120G-G2	3659724 EAMF-A-95A-120G-G2	558006 EAMD-67-51-25-32X32-U	3712650 EAMK-A-L95-95A/B-G2	567496 EAHM-L2-M8-70
3657226 EAMM-A-L95-140A-G2	558023 EAMF-A-95A-140A	558008 EAMD-67-51-24-32X32-U	3712650 EAMK-A-L95-95A/B-G2	567497 EAHM-L2-M8-80
3659562 EAMM-A-L95-190A-G2	1378473 EAMF-A-95A-190A	1379269 EAMD-67-51-32-32X32-U	3712650 EAMK-A-L95-95A/B-G2	567497 EAHM-L2-M8-80
vw 1202253 EAMM-A-N38-60G	1190015 EAMF-A-38D-60G/H	558001 EAMD-32-32-11-16X20	1345947 EAMK-A-N38-38D	1202262 EAHM-L5-M6-40
1456616 EAMM-A-N38-60H	1190015 EAMF-A-38D-60G/H	1377840 EAMD-32-32-14-16X20	1345947 EAMK-A-N38-38D	1202262 EAHM-L5-M6-40
1202331 EAMM-A-N38-70A	1202337 EAMF-A-38D-70A	558001 EAMD-32-32-11-16X20	1345947 EAMK-A-N38-38D	1202288 EAHM-L5-M6-35
vw 3324111 EAMM-A-N38-87A	3319868 EAMF-A-38D-87A	558001 EAMD-32-32-11-16X20	1345947 EAMK-A-N38-38D	1202288 EAHM-L5-M6-35
vw 1972527 EAMM-A-N48-60G	1460111 EAMF-A-48C-60G/H	558001 EAMD-32-32-11-16X20	1345949 EAMK-A-N48-48C	4984529 EAHM-L5-M6-45
1456618 EAMM-A-N48-60H	1460111 EAMF-A-48C-60G/H	1377840 EAMD-32-32-14-16X20	1345949 EAMK-A-N48-48C	4984529 EAHM-L5-M6-45
vw 1258793 EAMM-A-N48-80G	1190375 EAMF-A-48C-80G	1781043 EAMD-42-40-20-16X25-U	1345949 EAMK-A-N48-48C	1201874 EAHM-L5-M6-50
1201894 EAMM-A-N48-100A	1201924 EAMF-A-48C-100A	558002 EAMD-42-40-19-16X25	1345949 EAMK-A-N48-48C	1201874 EAHM-L5-M6-50
vw 2372096 EAMM-A-N80-80G	2372201 EAMF-A-80A-80G	558004 EAMD-56-46-20-23X27	1345953 EAMK-A-N80-80A	1201712 EAHM-L5-M8-60
vw 1201695 EAMM-A-N80-120G	1190702 EAMF-A-80A-120G	1188801 EAMD-56-46-25-23X27	1345953 EAMK-A-N80-80A	1201712 EAHM-L5-M8-60
1201691 EAMM-A-N80-140A	1190796 EAMF-A-80A-140A	558005 EAMD-56-46-24-23X27	1345953 EAMK-A-N80-80A	1201751 EAHM-L5-M8-75

Festo 核心产品范围

q 24 小时内从 Festo 工厂发出

vw 最多 5 天内发货

轴向安装组件 EAMM-A

技术参数

FESTO

尺寸

CAD 相关数据 → www.festo.com

ELGA-BS-...

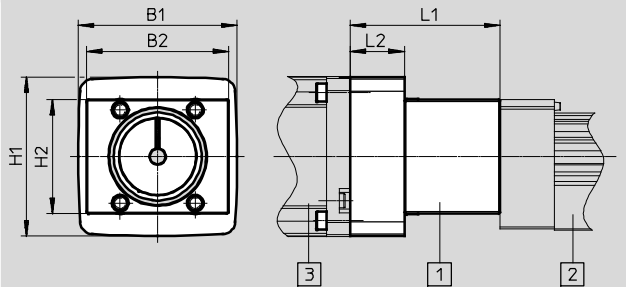

图示:

- 1 轴向安装组件
- 2 丝杆式电缸
- 3 电机

型号	B1	B2	H1	H2	L1	L2
EAMM-A-S38-40A-G2	58	55	44	44	44	7
EAMM-A-S38-40G-G2	60	55	60	44	54	17
EAMM-A-S38-40P-G2	58	55	44	44	44.7	10.7
EAMM-A-S38-42A-G2	58	55	44	44	52	15
EAMM-A-S38-55A-G2	55	55	55	44	48	11
EAMM-A-S38-57A-G2	56	55	56	44	48	11
EAMM-A-S38-60P-G2	61.4	55	61.4	44	58	21
EAMM-A-S38-67A-G2	67	55	67	44	53	16
EAMM-A-S48-40G-G2	60	70	60	53	55	17
EAMM-A-S48-55A-G2	70	70	55	53	47.2	9.2
EAMM-A-S48-57A-G2	70	70	55	53	47.2	9.2
EAMM-A-S48-60G-G2	60	70	60	53	62.5	24.5
EAMM-A-S48-60H-G2	60	70	60	53	62.5	24.5
EAMM-A-S48-60P-G2	61.4	70	61.4	53	57.2	19.2
EAMM-A-S48-70A-G2	70	70	70	53	50.2	12.2
EAMM-A-S48-87A-G2	85.8	70	85.8	53	54	16
EAMM-A-S62-60G-G2	80	80	80	70	84.5	18
EAMM-A-S62-60H-G2	80	80	80	70	84.5	18
EAMM-A-S62-70A-G2	82	80	70	70	78.5	12
EAMM-A-S62-80G-G2	100	80	100	70	81	14.5
EAMM-A-S62-80P-G2	81.3	80	81.3	70	77	10.5
EAMM-A-S62-87A-G2	85.8	80	85.8	70	81.5	15
EAMM-A-S62-100A-G2	100.5	80	100.5	70	81	14.5
EAMM-A-S62-140A-G2	140	80	140	70	91	24.5
EAMM-A-S95-100A-G2	140	140	100	110	85.5	17
EAMM-A-S95-140A-G2	140	140	140	110	95.5	27

订货数据 - 单个元件

轴向安装组件	包括:			
	电机法兰	联轴器	联轴器壳体	螺丝组
订货号 型号	订货号 型号	订货号 型号	订货号 型号	订货号 型号
3637971 EAMM-A-S38-40A-G2	558175 EAMF-A-38B-40A	558312 EAMC-30-32-6-6	3637942 EAMK-A-S38-38A/B-G2	-
1456647 EAMM-A-S38-40G-G2	1460097 EAMF-A-38A-40G	562681 EAMC-30-32-6-10	3637942 EAMK-A-S38-38A/B-G2	567488 EAHM-L2-M5-50
vw3637972 EAMM-A-S38-40P-G2	2219077 EAMF-A-38B-40P	533708 EAMC-30-32-6-8	3637942 EAMK-A-S38-38A/B-G2	-
vw3637965 EAMM-A-S38-42A-G2	560691 EAMF-A-38B-42A	561333 EAMC-30-32-5-6	3637942 EAMK-A-S38-38A/B-G2	-
3637967 EAMM-A-S38-55A-G2	558176 EAMF-A-38A-55A	551003 EAMC-30-32-6-9	3637942 EAMK-A-S38-38A/B-G2	567488 EAHM-L2-M5-50
vw3637956 EAMM-A-S38-57A-G2	560692 EAMF-A-38A-57A	551002 EAMC-30-32-6-6.35	3637942 EAMK-A-S38-38A/B-G2	567488 EAHM-L2-M5-50
vw3637958 EAMM-A-S38-60P-G2	1987412 EAMM-A-38A-60P	1233256 EAMC-30-32-6-14	3637942 EAMK-A-S38-38A/B-G2	567489 EAHM-L2-M5-55
1456638 EAMM-A-S38-67A-G2	1490100 EAMF-A-38A-67A	551003 EAMC-30-32-6-9	3637942 EAMK-A-S38-38A/B-G2	567489 EAHM-L2-M5-55

Festo 核心产品范围

q 24 小时内从 Festo 工厂发出

vw 最多 5 天内发货

轴向安装组件 EAMM-A

技术参数

FESTO

订货数据 - 单个元件				
轴向安装组件	包括:			
	电机法兰	联轴器	联轴器壳体	螺丝组
				
订货号 型号	订货号 型号	订货号 型号	订货号 型号	订货号 型号
1456650 EAMM-A-S48-40G-G2	4067069 EAMF-A-48B-40G	558029 EAMC-30-32-8-10	3637941 EAMK-A-S48-48A/B-G2	-
3637961 EAMM-A-S48-55A-G2	558177 EAMF-A-48B-55A	543423 EAMC-30-32-8-9	3637941 EAMK-A-S48-48A/B-G2	-
✓ 3637963 EAMM-A-S48-57A-G2	560694 EAMF-A-48B-57A	543421 EAMC-30-32-6.35-8	3637941 EAMK-A-S48-48A/B-G2	-
2256701 EAMM-A-S48-60G-G2	558019 EAMF-A-48A-60G/H	551004 EAMC-30-32-8-11	3637941 EAMK-A-S48-48A/B-G2	567489 EAHM-L2-M5-55
1456652 EAMM-A-S48-60H-G2	558019 EAMF-A-48A-60G/H	562682 EAMC-30-32-8-14	3637941 EAMK-A-S48-48A/B-G2	567489 EAHM-L2-M5-55
✓ 3637964 EAMM-A-S48-60P-G2	2220620 EAMF-A-48A-60P	562682 EAMC-30-32-8-14	3637941 EAMK-A-S48-48A/B-G2	567489 EAHM-L2-M5-55
3637957 EAMM-A-S48-70A-G2	558025 EAMF-A-48A-70A	551004 EAMC-30-32-8-11	3637941 EAMK-A-S48-48A/B-G2	567488 EAHM-L2-M5-50
✓ 3637962 EAMM-A-S48-87A-G2	560695 EAMF-A-48A-87A	551004 EAMC-30-32-8-11	3637941 EAMK-A-S48-48A/B-G2	567489 EAHM-L2-M5-55
2297649 EAMM-A-S62-60G-G2	1460112 EAMF-A-62A-60G/H	525864 EAMC-40-66-11-12	3637940 EAMK-A-S62-62A/B-G2	567495 EAHM-L2-M6-90
1456654 EAMM-A-S62-60H-G2	1460112 EAMF-A-62A-60G/H	1452803 EAMC-40-66-12-14	3637940 EAMK-A-S62-62A/B-G2	567495 EAHM-L2-M6-90
3637959 EAMM-A-S62-70A-G2	558179 EAMF-A-62B-70A	558313 EAMC-42-66-11-12	3637940 EAMK-A-S62-62A/B-G2	-
1972530 EAMM-A-S62-80G-G2	2116672 EAMF-A-62B-80G	2138701 EAMC-42-50-12-20	3637940 EAMK-A-S62-62A/B-G2	-
✓ 3637970 EAMM-A-S62-80P-G2	2222624 EAMF-A-62B-80P	551005 EAMC-42-50-12-19	3637940 EAMK-A-S62-62A/B-G2	-
✓ 3637966 EAMM-A-S62-87A-G2	560696 EAMF-A-62B-87A	558313 EAMC-42-66-11-12	3637940 EAMK-A-S62-62A/B-G2	-
✓ 3637960 EAMM-A-S62-100A-G2	558026 EAMF-A-62A-100A	551005 EAMC-42-50-12-19	3637940 EAMK-A-S62-62A/B-G2	567494 EAHM-L2-M6-80
3637969 EAMM-A-S62-140A-G2	558022 EAMF-A-62A-140A	558314 EAMC-42-50-12-24	3637940 EAMK-A-S62-62A/B-G2	567495 EAHM-L2-M6-90
3637955 EAMM-A-S95-100A-G2	558182 EAMF-A-95B-100A	558315 EAMC-56-58-19-25	3637939 EAMK-A-S95-95A/B-G2	-
3637954 EAMM-A-S95-140A-G2	558023 EAMF-A-95A-140A	558316 EAMC-56-58-24-25	3637939 EAMK-A-S95-95A/B-G2	567498 EAHM-L2-M8-100

Festo 核心产品范围

q 24 小时内从 Festo 工厂发出

✓ 最多 5 天内发货

轴向安装组件 EAMM-A

技术参数

尺寸

CAD 相关数据 → www.festo.com

ELGC-TB-...

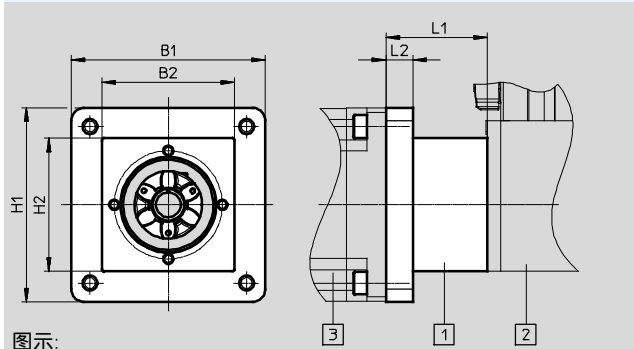

图示:

- 1 轴向安装组件
- 2 齿形带式电缸
- 3 电机

ELGC-BS-...

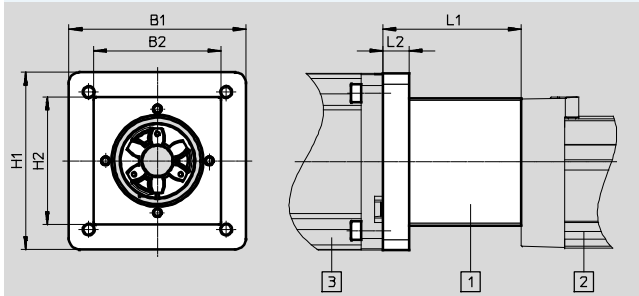

图示:

- 1 轴向安装组件
- 2 丝杆式电缸
- 3 电机

EGSC-BS-...

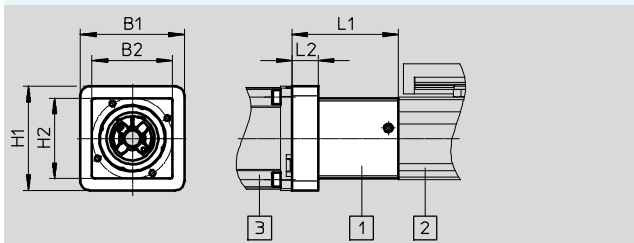

图示:

- 1 轴向安装组件
- 2 小型滑台式电缸
- 3 电机

尺寸和订货数据

型号	B1	B2	H1	H2	L1 ±0.1	L2	订货号	型号
EAMM-A-V20-28A	28	24.5	28	24.5	36.4	4	4505258	EAMM-A-V20-28A
EAMM-A-V25-40P	40	31	40	31	41	10	4491059	EAMM-A-V25-40P
EAMM-A-V25-42A	42	31	42	31	40	6	4582608	EAMM-A-V25-42A
EAMM-A-V32-40P	44	40	44	40	41	11	4595742	EAMM-A-V32-40P
EAMM-A-V32-42A	44	42	44	42	40	8	4281142	EAMM-A-V32-42A
EAMM-A-V32-57A	56.4	44	56.4	44	41.5	11	4597016	EAMM-A-V32-57A
EAMM-A-V32-60P	62	44	62	44	55.1	11	4608750	EAMM-A-V32-60P
EAMM-A-T42-57A	-	59	-	59	43	-	4327034	EAMM-A-T42-57A
EAMM-A-T42-60P	-	59	-	59	48	-	4133487	EAMM-A-T42-60P
EAMM-A-T42-80P	82	59	82	59	64.1	12	4623788	EAMM-A-T42-80P
EAMM-A-T42-87A	86	59	86	59	45	12	4610008	EAMM-A-T42-87A
EAMM-A-T46-60P	79	62	79	62	47	14	4824833	EAMM-A-T46-60P
EAMM-A-T46-80P	-	79	-	79	63.1	-	4624170	EAMM-A-T46-80P
EAMM-A-T46-87A	86	79	86	79	44	12	4048771	EAMM-A-T46-87A
EAMM-A-T46-100A	100	79	100	79	68.1	22	4624227	EAMM-A-T46-100A

轴向安装组件 EAMM-A

技术参数

FESTO

尺寸

CAD 相关数据 → www.festo.com

EGC-HD-TB...

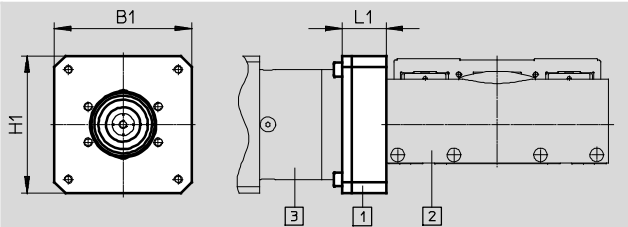

图示:

- 1 轴向安装组件
- 2 齿形带式电缸
- 3 电机

型号	B1	H1	L1
EAMM-A-M43-60G	60	60	33
EAMM-A-M43-60H	60	60	33
EAMM-A-M48-60H	66	60	26
EAMM-A-M48-80G	100	100	32
EAMM-A-M80-120G	124	124	34

订货数据 - 单个元件

轴向安装组件

包括:

电机法兰

联轴器

Centring ring

订货号 型号	订货号 型号	订货号 型号	订货号 型号
1190076 EAMM-A-M43-60G	1597579 EAMF-A-43D-60G/H	558001 EAMD-32-32-11-16X20	575962 EAML-43-4-43
1456612 EAMM-A-M43-60H	1597579 EAMF-A-43D-60G/H	1377840 EAMD-32-32-14-16X20	575962 EAML-43-4-43
1456614 EAMM-A-M48-60H	1460111 EAMF-A-48C-60G/H	3420022 EAMD-42-40-14-16X25-U	558031 EAML-48-4-48
1190421 EAMM-A-M48-80G	1190375 EAMF-A-48C-80G	1781043 EAMD-42-40-20-16X25-U	558031 EAML-48-4-48
1190774 EAMM-A-M80-120G	1190702 EAMF-A-80A-120G	1781045 EAMD-56-46-25-23X27-U	1209006 EAML-80-6-80

轴向安装组件 EAMM-A

技术参数

尺寸

CAD 相关数据 → www.festo.com

EGC-HD-BS...

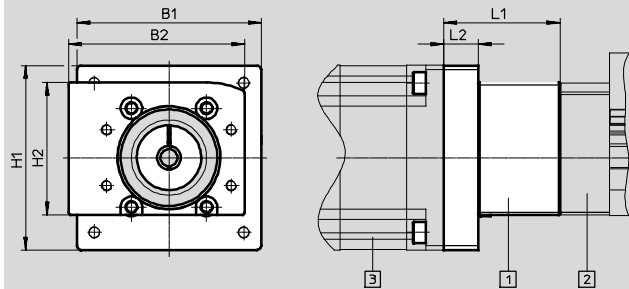

图示:

- 1 轴向安装组件
- 2 丝杆式电缸
- 3 电机

型号	B1	B2	H1	H2	L1	L2
EAMM-A-S38-40A-G2	58	55	44	44	44	7
EAMM-A-S38-40G-G2	60	55	60	44	54	17
EAMM-A-S38-40P-G2	58	55	44	44	44.7	10.7
EAMM-A-S38-42A-G2	58	55	44	44	52	15
EAMM-A-S38-55A-G2	55	55	55	44	48	11
EAMM-A-S38-57A-G2	56	55	56	44	48	11
EAMM-A-S38-60P-G2	61.4	55	61.4	44	58	21
EAMM-A-S38-67A-G2	67	55	67	44	53	16
EAMM-A-S48-40G-G2	60	70	60	53	55	17
EAMM-A-S48-55A-G2	70	70	55	53	47.2	9.2
EAMM-A-S48-57A-G2	70	70	55	53	47.2	9.2
EAMM-A-S48-60G-G2	60	70	60	53	62.5	24.5
EAMM-A-S48-60H-G2	60	70	60	53	62.5	24.5
EAMM-A-S48-60P-G2	61.4	70	61.4	53	57.2	19.2
EAMM-A-S48-70A-G2	70	70	70	53	50.2	12.2
EAMM-A-S48-87A-G2	85.8	70	85.8	53	54	16
EAMM-A-S62-60G-G2	80	80	80	70	84.5	18
EAMM-A-S62-60H-G2	80	80	80	70	84.5	18
EAMM-A-S62-70A-G2	82	80	70	70	78.5	12
EAMM-A-S62-80G-G2	100	80	100	70	81	14.5
EAMM-A-S62-80P-G2	81.3	80	81.3	70	77	10.5
EAMM-A-S62-87A-G2	85.8	80	85.5	70	81.5	15
EAMM-A-S62-100A-G2	100.5	80	100.5	70	81	14.5
EAMM-A-S62-140A-G2	140	80	140	70	91	24.5

轴向安装组件 EAMM-A

技术参数

FESTO

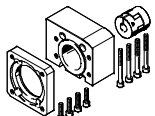
订货数据 - 单个元件				
轴向安装组件	包括:			
	电机法兰	联轴器	联轴器壳体	螺丝组
订货号 型号	订货号 型号	订货号 型号	订货号 型号	订货号 型号
3637971 EAMM-A-S38-40A-G2	558175 EAMF-A-38B-40A	558312 EAMC-30-32-6-6	3637942 EAMK-A-S38-38A/B-G2	-
1456647 EAMM-A-S38-40G-G2	1460097 EAMF-A-38A-40G	562681 EAMC-30-32-6-10	3637942 EAMK-A-S38-38A/B-G2	567488 EAHM-L2-M5-50
vw3637972 EAMM-A-S38-40P-G2	2219077 EAMF-A-38B-40P	533708 EAMC-30-32-6-8	3637942 EAMK-A-S38-38A/B-G2	-
vw3637965 EAMM-A-S38-42A-G2	560691 EAMF-A-38B-42A	561333 EAMC-30-32-5-6	3637942 EAMK-A-S38-38A/B-G2	-
3637967 EAMM-A-S38-55A-G2	558176 EAMF-A-38A-55A	551003 EAMC-30-32-6-9	3637942 EAMK-A-S38-38A/B-G2	567488 EAHM-L2-M5-50
vw3637956 EAMM-A-S38-57A-G2	560692 EAMF-A-38A-57A	551002 EAMC-30-32-6-6.35	3637942 EAMK-A-S38-38A/B-G2	567488 EAHM-L2-M5-50
vw3637958 EAMM-A-S38-60P-G2	1987412 EAMF-A-38A-60P	1233256 EAMC-30-32-6-14	3637942 EAMK-A-S38-38A/B-G2	567489 EAHM-L2-M5-55
1456638 EAMM-A-S38-67A-G2	1490100 EAMF-A-38A-67A	551003 EAMC-30-32-6-9	3637942 EAMK-A-S38-38A/B-G2	567489 EAHM-L2-M5-55
1456650 EAMM-A-S48-40G-G2	4067069 EAMF-A-48B-40G	558029 EAMC-30-32-8-10	3637941 EAMK-A-S48-48A/B-G2	-
3637961 EAMM-A-S48-55A-G2	558177 EAMF-A-48B-55A	543423 EAMC-30-32-8-9	3637941 EAMK-A-S48-48A/B-G2	-
vw3637963 EAMM-A-S48-57A-G2	560694 EAMF-A-48B-57A	543421 EAMC-30-32-6.35-8	3637941 EAMK-A-S48-48A/B-G2	-
2256701 EAMM-A-S48-60G-G2	558019 EAMF-A-48A-60G/H	551004 EAMC-30-32-8-11	3637941 EAMK-A-S48-48A/B-G2	567489 EAHM-L2-M5-55
1456652 EAMM-A-S48-60H-G2	558019 EAMF-A-48A-60G/H	562682 EAMC-30-32-8-14	3637941 EAMK-A-S48-48A/B-G2	567489 EAHM-L2-M5-55
vw3637964 EAMM-A-S48-60P-G2	2220620 EAMF-A-48A-60P	562682 EAMC-30-32-8-14	3637941 EAMK-A-S48-48A/B-G2	567489 EAHM-L2-M5-55
3637957 EAMM-A-S48-70A-G2	558025 EAMF-A-48A-70A	551004 EAMC-30-32-8-11	3637941 EAMK-A-S48-48A/B-G2	567488 EAHM-L2-M5-50
vw3637962 EAMM-A-S48-87A-G2	560695 EAMF-A-48A-87A	551004 EAMC-30-32-8-11	3637941 EAMK-A-S48-48A/B-G2	567489 EAHM-L2-M5-55
2297649 EAMM-A-S62-60G-G2	1460112 EAMF-A-62A-60G/H	525864 EAMC-40-66-11-12	3637940 EAMK-A-S62-62A/B-G2	567495 EAHM-L2-M6-90
1456654 EAMM-A-S62-60H-G2	1460112 EAMF-A-62A-60G/H	1452803 EAMC-40-66-12-14	3637940 EAMK-A-S62-62A/B-G2	567495 EAHM-L2-M6-90
3637959 EAMM-A-S62-70A-G2	558179 EAMF-A-62B-70A	558313 EAMC-42-66-11-12	3637940 EAMK-A-S62-62A/B-G2	-
1972530 EAMM-A-S62-80G-G2	2116672 EAMF-A-62B-80G	2138701 EAMC-42-50-12-20	3637940 EAMK-A-S62-62A/B-G2	-
vw3637970 EAMM-A-S62-80P-G2	2222624 EAMF-A-62B-80P	551005 EAMC-42-50-12-19	3637940 EAMK-A-S62-62A/B-G2	-
vw3637966 EAMM-A-S62-87A-G2	560696 EAMF-A-62B-87A	558313 EAMC-42-66-11-12	3637940 EAMK-A-S62-62A/B-G2	-
vw3637960 EAMM-A-S62-100A-G2	558026 EAMF-A-62A-100A	551005 EAMC-42-50-12-19	3637940 EAMK-A-S62-62A/B-G2	567494 EAHM-L2-M6-80
3637969 EAMM-A-S62-140A-G2	558022 EAMF-A-62A-140A	558314 EAMC-42-50-12-24	3637940 EAMK-A-S62-62A/B-G2	567495 EAHM-L2-M6-90

Festo 核心产品范围

q 24 小时内从 Festo 工厂发出

vw 最多 5 天内发货

轴向安装组件 EAMM-A

技术参数

尺寸

CAD 相关数据 → www.festo.com

EGSK-..., EGSP-...

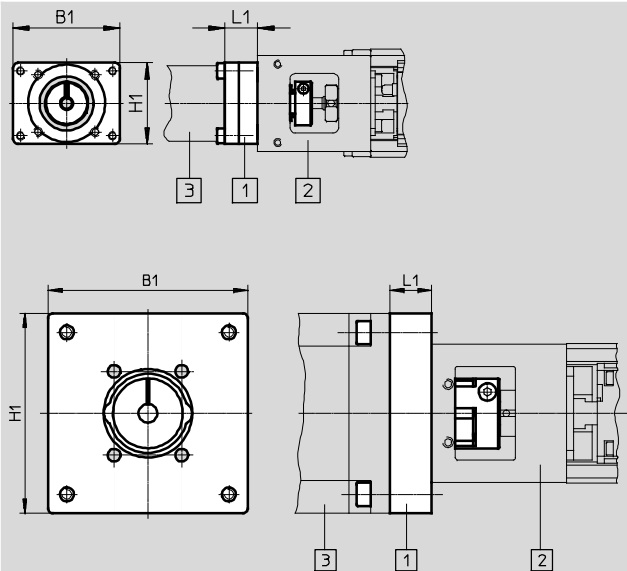

图示:

- 1 轴向安装组件
- 2 Electric slide
- 3 电机

型号	B1	H1	L1
EAMM-A-P3-28D-28A	30	30	15
EAMM-A-P3-28D-40P	39.7	39.7	14.5
EAMM-A-P4-28B-28A	39.6	30	12
EAMM-A-P4-28B-40A	40	40	8.3
EAMM-A-P4-28B-40P	39.7	39.7	12.5
EAMM-A-P4-28B-42A	42	42	16.5
EAMM-A-P5-28B-28A	39.6	30	12
EAMM-A-P5-28B-40A	40	40	8.3
EAMM-A-P5-28B-40P	39.7	39.7	12.5
EAMM-A-P5-28B-42A	42	42	16.5
EAMM-A-P6-38A-40A	50	50	9
EAMM-A-P6-38A-40G	60	60	17
EAMM-A-P6-38A-40P	50	50	10.7
EAMM-A-P6-38A-42A	55	55	15
EAMM-A-P6-38A-55A	55	55	11
EAMM-A-P6-38A-57A	56	56	11
EAMM-A-P6-38A-60P	61.4	61.4	21
EAMM-A-P6-38A-67A	67	67	16
EAMM-A-P8-38A-40A	50	50	9
EAMM-A-P8-38A-40G	60	60	17
EAMM-A-P8-38A-40P	50	50	10.7
EAMM-A-P8-38A-42A	55	55	15
EAMM-A-P8-38A-55A	55	55	11
EAMM-A-P8-38A-57A	56	56	11
EAMM-A-P8-38A-60P	61.4	61.4	21
EAMM-A-P8-38A-67A	67	67	16
EAMM-A-P8-38A-70A	70	70	13.8
EAMM-A-P8-38A-87A	85.8	85.8	18
EAMM-A-P10-38A-40G	60	60	17
EAMM-A-P10-38A-55A	55	55	11
EAMM-A-P10-38A-57A	56	56	11
EAMM-A-P10-38A-60P	61.4	61.4	21
EAMM-A-P10-38A-67A	67	67	16
EAMM-A-P10-38A-70A	70	70	13.8
EAMM-A-P10-38A-87A	85.8	85.8	18

轴向安装组件 EAMM-A

技术参数

FESTO

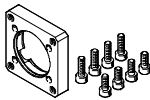
订货数据 – 单个元件		
轴向安装组件	包括:	
	电机法兰	联轴器
		
订货号 型号	订货号 型号	订货号 型号
1703478 EAMM-A-P3-28D-28A	1087613 EAMF-A-28D-28A	562672 EAMC-16-20-3-5
1982886 EAMM-A-P3-28D-40P	1982014 EAMF-A-28D-40P	2310368 EAMC-16-20-3-8
1731466 EAMM-A-P4-28B-28A	1704476 EAMF-A-28B-28A	562674 EAMC-16-20-4-5
1983071 EAMM-A-P4-28B-40P	1976704 EAMF-A-28B-40P	562675 EAMC-16-20-4-8
562637 EAMM-A-P4-28B-40A	552163 EAMF-A-28B-40A	562673 EAMC-16-20-4-6
562636 EAMM-A-P4-28B-42A	552164 EAMF-A-28B-42A	562674 EAMC-16-20-4-5
1731474 EAMM-A-P5-28B-28A	1704476 EAMF-A-28B-28A	562676 EAMC-16-20-5-5
562641 EAMM-A-P5-28B-40A	552163 EAMF-A-28B-40A	543419 EAMC-16-20-5-6
1983122 EAMM-A-P5-28B-40P	1976704 EAMF-A-28B-40P	562677 EAMC-16-20-5-8
562640 EAMM-A-P5-28B-42A	552164 EAMF-A-28B-42A	562676 EAMC-16-20-5-5
562646 EAMM-A-P6-38A-40A	562667 EAMF-A-38A-40A	558312 EAMC-30-32-6-6
2297645 EAMM-A-P6-38A-40G	1460097 EAMF-A-38A-40G	562681 EAMC-30-32-6-10
1983450 EAMM-A-P6-38A-40P	1984478 EAMF-A-38A-40P	533708 EAMC-30-32-6-8
562644 EAMM-A-P6-38A-42A	562668 EAMF-A-38A-42A	561333 EAMC-30-32-5-6
562647 EAMM-A-P6-38A-55A	558176 EAMF-A-38A-55A	551003 EAMC-30-32-6-9
562645 EAMM-A-P6-38A-57A	560692 EAMF-A-38A-57A	551002 EAMC-30-32-6-6.35
2264375 EAMM-A-P6-38A-60P	1987412 EAMF-A-38A-60P	1233256 EAMC-30-32-6-14
2297641 EAMM-A-P6-38A-67A	1490100 EAMF-A-38A-67A	551003 EAMC-30-32-6-9

轴向安装组件 EAMM-A

技术参数

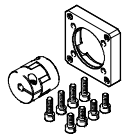
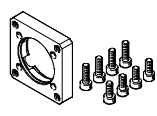
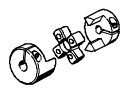
订货数据 – 单个元件		
轴向安装组件	包括:	
	电机法兰	联轴器
		
订货号 型号	订货号 型号	订货号 型号
562652 EAMM-A-P8-38A-40A	562667 EAMF-A-38A-40A	533708 EAMC-30-32-6-8
2297646 EAMM-A-P8-38A-40G	1460097 EAMF-A-38A-40G	558029 EAMC-30-32-8-10
1986292 EAMM-A-P8-38A-40P	1984478 EAMF-A-38A-40P	543422 EAMC-30-32-8-8
562650 EAMM-A-P8-38A-42A	562668 EAMF-A-38A-42A	562678 EAMC-30-32-5-8
562653 EAMM-A-P8-38A-55A	558176 EAMF-A-38A-55A	543423 EAMC-30-32-8-9
562651 EAMM-A-P8-38A-57A	560692 EAMF-A-38A-57A	543421 EAMC-30-32-6.35-8
1987308 EAMM-A-P8-38A-60P	1987412 EAMF-A-38A-60P	562682 EAMC-30-32-8-14
2297643 EAMM-A-P8-38A-67A	1490100 EAMF-A-38A-67A	543423 EAMC-30-32-8-9
564996 EAMM-A-P8-38A-70A	558018 EAMF-A-38A-70A	551004 EAMC-30-32-8-11
564998 EAMM-A-P8-38A-87A	560693 EAMF-A-38A-87A	551004 EAMC-30-32-8-11
2297648 EAMM-A-P10-38A-40G	1460097 EAMF-A-38A-40G	2310372 EAMC-30-32-10-10
562659 EAMM-A-P10-38A-55A	558176 EAMF-A-38A-55A	562680 EAMC-30-32-9-10
562658 EAMM-A-P10-38A-57A	560692 EAMF-A-38A-57A	562679 EAMC-30-32-6.35-10
2036017 EAMM-A-P10-38A-60P	1987412 EAMF-A-38A-60P	562683 EAMC-30-32-10-14
2297644 EAMM-A-P10-38A-67A	1490100 EAMF-A-38A-67A	562680 EAMC-30-32-9-10
564997 EAMM-A-P10-38A-70A	558018 EAMF-A-38A-70A	565008 EAMC-30-32-10-11
564999 EAMM-A-P10-38A-87A	560693 EAMF-A-38A-87A	565008 EAMC-30-32-10-11

轴向安装组件 EAMM-A

技术参数

FESTO

尺寸

CAD 相关数据 → www.festo.com

ELGG-..., ELGR-...

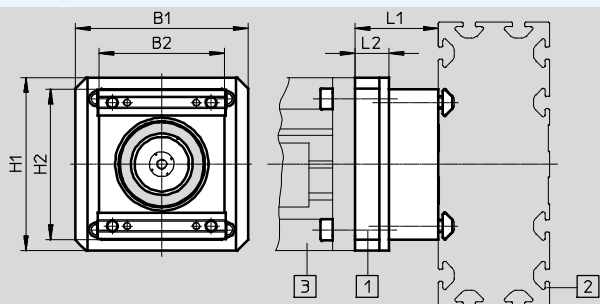

图示:





- 1 轴向安装组件
- 2 齿形带式电缸
- 3 电机

型号	B1	B2	H1	H2	L1	L2
EAMM-A-R27-40G	55	44.5	55	48.3	26	11
EAMM-A-R27-55A	55	44.5	55	48.3	26	11
EAMM-A-R27-57A	56	44.5	56	48.3	26	11
EAMM-A-R27-67A	67	44.5	67	48.3	31	16
EAMM-A-R38-40G	60	51	60	61	37	17
EAMM-A-R38-57A	56	-	-	-	31	-
EAMM-A-R38-60G	60	51	60	61	46	26
EAMM-A-R38-60H	60	51	60	61	46	26
EAMM-A-R38-60P	61.4	51	61.4	61	41	21
EAMM-A-R38-70A	70	51	70	61	33.8	13.8
EAMM-A-R38-87A	85.8	51	85.8	61	38	18
EAMM-A-R48-60G	60	55	60	81	52.5	24.5
EAMM-A-R48-60H	60	55	60	51	52.5	24.5
EAMM-A-R48-70A	70	-	-	-	402	-
EAMM-A-R48-80P	81.3	55	81.3	81	54	26
EAMM-A-R48-87A	85.5	55	85.5	81	44	16
EAMM-A-R48-100A	100.5	55	100.5	81	59	31

轴向安装组件 EAMM-A

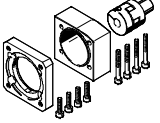
技术参数

FESTO

订货数据 - 单个元件			
轴向安装组件	包括:		
	电机法兰	联轴器	联轴器壳体
			
订货号 型号	订货号 型号	订货号 型号	订货号 型号
1456622 EAMM-A-R27-40G	1460097 EAMF-A-38A-40G	557998 EAMD-19-15-10-8X10	1133397 EAMK-A-R27-38A
1133400 EAMM-A-R27-55A	558176 EAMF-A-38A-55A	557999 EAMD-19-15-9-8X10	1133397 EAMK-A-R27-38A
vw1133403 EAMM-A-R27-57A	560692 EAMF-A-38A-57A	561292 EAMD-16-15-6.35-8X10	1133397 EAMK-A-R27-38A
1456619 EAMM-A-R27-67A	1490100 EAMF-A-38A-67A	557999 EAMD-19-15-9-8X10	1133397 EAMK-A-R27-38A
1456623 EAMM-A-R38-40G	1460097 EAMF-A-38A-40G	1453860 EAMD-25-22-10-10X12	1133398 EAMK-A-R38-38A
vw1578138 EAMM-A-R38-57A	560692 EAMF-A-38A-57A	561293 EAMD-25-22-6.35-10X12	1133398 EAMK-A-R38-38A
2310075 EAMM-A-R38-60G	558017 EAMF-A-38A-60G/H	558000 EAMD-25-22-11-10X12	1133398 EAMK-A-R38-38A
1456630 EAMM-A-R38-60H	558017 EAMF-A-38A-60G/H	1453861 EAMD-28-22-14-10X12	1133398 EAMK-A-R38-38A
vw2224996 EAMM-A-R38-60P	1987412 EAMF-A-38A-60P	1453861 EAMD-28-22-14-10X12	1133398 EAMK-A-R38-38A
1133401 EAMM-A-R38-70A	558018 EAMF-A-38A-70A	558000 EAMD-25-22-11-10X12	1133398 EAMK-A-R38-38A
vw1133404 EAMM-A-R38-87A	560693 EAMF-A-38A-87A	558000 EAMD-25-22-11-10X12	1133398 EAMK-A-R38-38A
2374780 EAMM-A-R48-60G	558019 EAMF-A-48A-60G/H	558001 EAMD-32-32-11-16X20	1133399 EAMK-A-R48-48A
1456633 EAMM-A-R48-60H	558019 EAMF-A-48A-60G/H	1377840 EAMD-32-32-14-16X20	1133399 EAMK-A-R48-48A
1578139 EAMM-A-R48-70A	558025 EAMF-A-48A-70A	558001 EAMD-32-32-11-16X20	1133399 EAMK-A-R48-48A
vw2225090 EAMM-A-R48-80P	2043427 EAMF-A-48A-80P	558002 EAMD-42-40-19-16X25	1133399 EAMK-A-R48-48A
vw1133405 EAMM-A-R48-87A	560695 EAMF-A-48A-87A	558001 EAMD-32-32-11-16X20	1133399 EAMK-A-R48-48A
vw1133402 EAMM-A-R48-100A	558020 EAMF-A-48A-100A	558002 EAMD-42-40-19-16X25	1133399 EAMK-A-R48-48A

Festo 核心产品范围

q 24 小时内从 Festo 工厂发出
vw 最多 5 天内发货

轴向安装组件 EAMM-A

附件

FESTO

密封套件

含油漆湿润缺陷物质

RoHS 合规

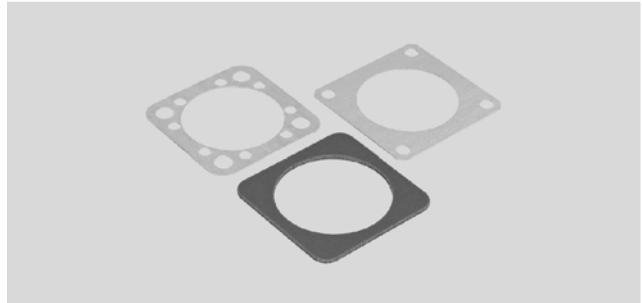

订货数据					
型号	适用轴向安装组件	适用有杆电缸	环境温度 [°C]	CRC ¹⁾	订货号 型号
EADS-F-D32-40A	EAMM-A-D32-40A	ESBF	-25 ... +60	4	1561526 EADS-F-D32-40A
EADS-F-D32-40G	EAMM-A-D32-40G				2253500 EADS-F-D32-40G
EADS-F-D32-40P	EAMM-A-D32-40P				2207219 EADS-F-D32-40P
EADS-F-D32-60G/H	EAMM-A-D32-60G EAMM-A-D32-60H				8022150 EADS-F-D32-60G/H
EADS-F-D32-60P	EAMM-A-D32-60P				2234012 EADS-F-D32-60P
EADS-F-D32-67A	EAMM-A-D32-67A				2253501 EADS-F-D32-67A
EADS-F-D32-42A	EAMM-A-D32-42A				1561527 EADS-F-D32-42A
EADS-F-D32-55A	EAMM-A-D32-55A				1561528 EADS-F-D32-55A
EADS-F-D32-57A	EAMM-A-D32-57A				1561529 EADS-F-D32-57A
EADS-F-D40-40G	EAMM-A-D40-40G				2253502 EADS-F-D40-40G
EADS-F-D40-55A	EAMM-A-D40-55A				1561530 EADS-F-D40-55A
EADS-F-D40-57A	EAMM-A-D40-57A				1561531 EADS-F-D40-57A
EADS-F-D40-60G/H	EAMM-A-D40-60G EAMM-A-D40-60H				2253503 EADS-F-D40-60G/H
EADS-F-D40-60P	EAMM-A-D40-60P				2151545 EADS-F-D40-60P
EADS-F-D40-67A	EAMM-A-D40-67A				2253504 EADS-F-D40-67A
EADS-F-D40-70A	EAMM-A-D40-70A				1561532 EADS-F-D40-70A
EADS-F-D40-87A	EAMM-A-D40-87A				1561533 EADS-F-D40-87A
EADS-F-D50-60G/H	EAMM-A-D50-60G EAMM-A-D50-60H				2733792 EADS-F-D50-60G/H
EADS-F-D50-70A	EAMM-A-D50-70A				2733789 EADS-F-D50-70A
EADS-F-D50-80G	EAMM-A-D50-80G				2733793 EADS-F-D50-80G
EADS-F-D50-80P	EAMM-A-D50-80P				2733791 EADS-F-D50-80P
EADS-F-D50-87A	EAMM-A-D50-87A				2733788 EADS-F-D50-87A
EADS-F-D50-100A	EAMM-A-D50-100A				2733790 EADS-F-D50-100A
EADS-F-D60-70A	EAMM-A-D60-70A				8022145 EADS-F-D60-70A
EADS-F-D60-80G	EAMM-A-D60-80G				8022146 EADS-F-D60-80G
EADS-F-D60-60G/H	EAMM-A-D60-60G EAMM-A-D60-60H				2253505 EADS-F-D60-60G/H
EADS-F-D60-80P	EAMM-A-D60-80P				2218523 EADS-F-D60-80P
EADS-F-D60-87A	EAMM-A-D60-87A	1561536 EADS-F-D60-87A			
EADS-F-D60-100A	EAMM-A-D60-100A	2253507 EADS-F-D60-100A			
EADS-F-D80-80G	EAMM-A-D80-80G	8022147 EADS-F-D80-80G			
EADS-F-D80-100A	EAMM-A-D80-100A	1593617 EADS-F-D80-100A			
EADS-F-D80-140A	EAMM-A-D80-140A	1593671 EADS-F-D80-140A			
EADS-F-D100-100A	EAMM-A-D100-100A	3356966 EADS-F-D100-100A			
EADS-F-D100-120G	EAMM-A-D100-120G	8022148 EADS-F-D100-120G			
EADS-F-D100-140A	EAMM-A-D100-140A	1593991 EADS-F-D100-140A			

1) 耐腐蚀等级 4，符合 Festo FN 940 070 标准
超高度耐腐蚀能力。户外暴露于极端腐蚀性条件。暴露于腐蚀性介质的元件，例如化工或食品行业。这些应用场合需要使用相应的介质进行特殊测试的结果加以支持（→ 又见 FN 940082）。