

# Proportional directional control valves VPWP



# Proportional directional control valves VPWP

Overview

FESTO

## Servo-pneumatic drive technology

Positioning and Soft Stop applications as an integral component of the valve terminal CPX – the modular peripheral system for decentralised automation tasks.

The modular design means that valves, digital inputs and outputs, positioning modules and end-position controllers, as appropriate to the application, can be combined in almost any way on the CPX terminal.

### Advantages:

- Pneumatics and electrics – control and positioning on one platform
- Innovative positioning technology – piston rod drives, rodless drives, rotary drives
- Actuation via fieldbus
- Remote maintenance, remote diagnostics, web server, SMS and e-mail alert are all possible via TCP/IP
- Modules can be quickly exchanged and expanded without altering the wiring

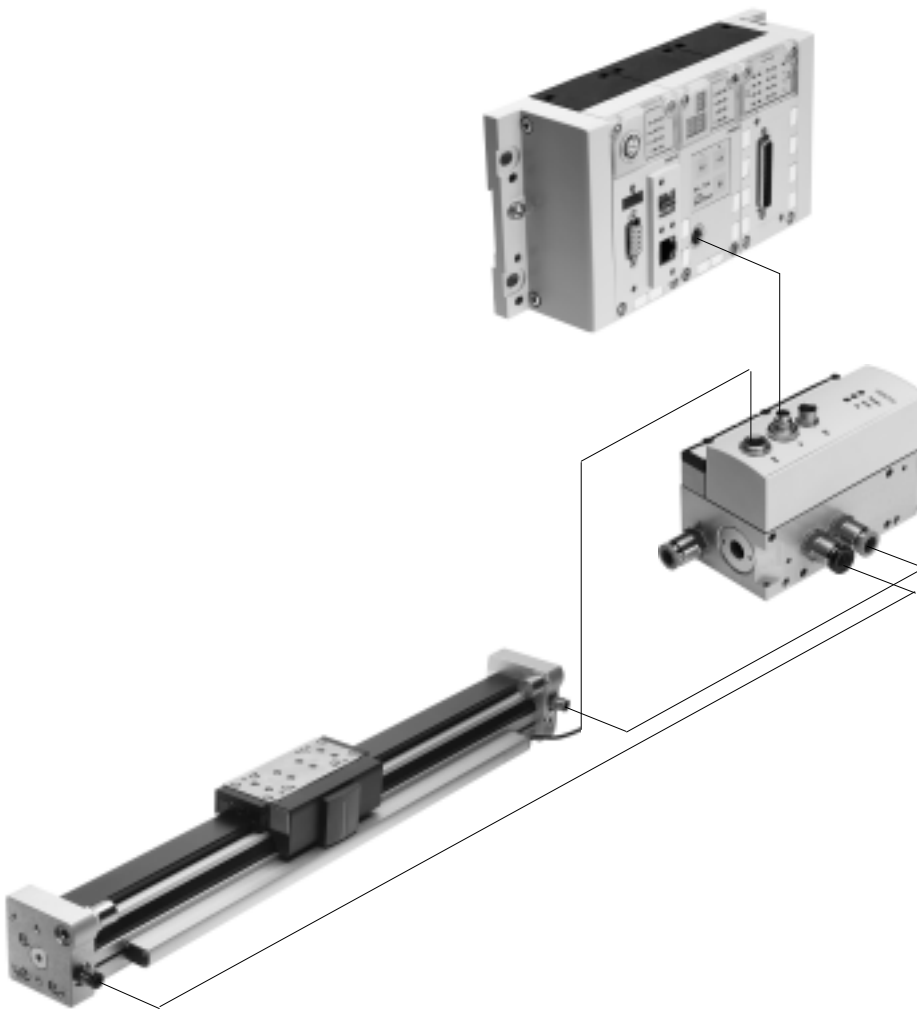

# Proportional directional control valves VPWP

Key features

## Axis controllers CPX-CMAX



**Free choice:**  
Position and force control, directly actuated or selected from one of 128 configurable position sets. If you are looking for something more:  
the configurable function for switching to the next set enables simple functional sequences to be realised in the axis controller CPX-CMAX. Everything is recognisable:  
the auto-identification function identifies each station with its device data on the controller CPX-CMAX.

**Also included:**  
The functional scope of the controller CPX-CMAX includes actuation of a brake or clamping unit via the proportional directional control valve VPWP.  
Up to 7 modules (max. 7 axes) can be operated in parallel and independently of each other. Commissioning via FCT (Festo configuration software) or via fieldbus: no programming, only configuration.

Technical data → Internet: [cpx-cmax](#)

- Advantages:**
- Greater flexibility
  - OEM friendly – commissioning also via fieldbus
  - Clear installation and fast commissioning
  - Cost-effective
  - You program the system in your PLC environment

## End-position controllers CPX-CMPX



Fast travel between the mechanical end stops of the cylinder, stopping gently and without impact in the end position.  
Fast commissioning via control panel, fieldbus or handheld unit. Improved control of downtime.  
Actuation of a brake or clamping unit via the proportional directional control valve VPWP is an integral component of the controller CMPX.

Depending on the fieldbus chosen, up to 9 end-position controllers can be actuated on the CPX terminal. All system data can be read and written via the fieldbus, including, for example the mid positions.

Technical data → Internet: [cpx-cmpx](#)

- Advantages:**
- Greater flexibility
  - OEM friendly – commissioning also via fieldbus
  - Clear installation and fast commissioning
  - Cost-effective
    - Up to 30% faster cycle rates
    - Significantly reduced system vibration
  - Improved work ergonomics thanks to significantly reduced noise level
  - The extended diagnostics help to reduce the service time of the machine

## Proportional directional control valve VPWP

Technical data → page 7



The 5/3-way proportional directional control valve for applications with Soft Stop and pneumatic positioning.  
Fully digitalised – with integrated pressure sensors, with new diagnostic functions.  
In sizes 4, 6 and 8.  
Flow rate of 350, 700 and 1400 l/min.

With switching output for actuating a brake.  
Coloured supply ports.  
Pre-assembled cables guarantee faultless and fast connection with the controllers CPX-CMPX and CPX-CMAX.

- Advantages:**
- Clear installation and fast commissioning
  - Reduction of system downtimes thanks to the new diagnostic options
  - With switching output for actuating a brake/clamping unit

# Proportional directional control valves VPWP

Drive options

FESTO

## System with linear drive DDLI, DGCI

Technical data → Internet: [ddli](#) or [dgci](#)

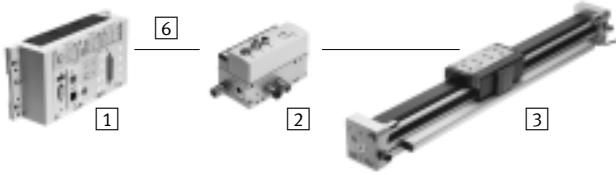

- 1 Controller module CPX-CMPX or CPX-CMAX
- 2 Proportional directional control valve VPWP
- 3 Linear drive DDLI, DGCI with displacement encoder
- 6 Connecting cable KVI-CP-3...

- Pneumatic rodless linear drive with displacement encoder, with or without recirculating ball bearing guide
- Displacement encoder with absolute and contactless measurement
- Diameters:
  - DGCI: 18 ... 63 mm
  - DDLI: 25 ... 63 mm
- Stroke: 100 ... 2000 mm in fixed lengths
- Range of applications: Soft Stop and pneumatic positioning
- Loads from 1 ... 180 kg
- No sensor interface required

Advantages:

- Complete drive unit
- DDLI for easy connection to customer's guide system
- Excellent running characteristics
- For fast and accurate positioning down to  $\pm 0.2$  mm (only with axis controller CPX-CMAX)

## System with standard cylinder DNCI, DDPC

Technical data → Internet: [dncl](#)

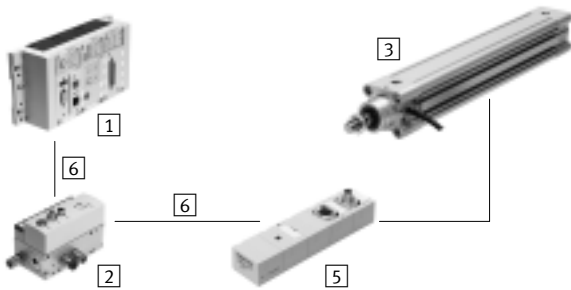

- 1 Controller module CPX-CMPX or CPX-CMAX
- 2 Proportional directional control valve VPWP
- 3 Standard cylinder DNCI, DDPC with displacement encoder
- 5 Sensor interface CASM-S-D3-R7
- 6 Connecting cable KVI-CP-3...

- Standard cylinder with integrated displacement encoder, conforms to DIN ISO 6432, VDMA 24 562, NF E 49 003.1 and Uni 10 290
- Displacement encoder with contactless and incremental measuring
- Diameter: 32 ... 100 mm
- Stroke: 100 ... 750 mm
- Range of applications: Soft Stop and pneumatic positioning
- Loads from 3 ... 450 kg and a matching sensor interface CASM-S-D3-R7
- Pre-assembled cables guarantee faultless and fast electrical connection

Advantages:

- Compact drive unit
- Can be used universally
- Also with guide unit
- For fast and accurate positioning up to  $\pm 0.5$  mm (only with axis controller CPX-CMAX)

# Proportional directional control valves VPWP

Drive options

FESTO

## System with swivel module DSMI

Technical data → Internet: dsmi

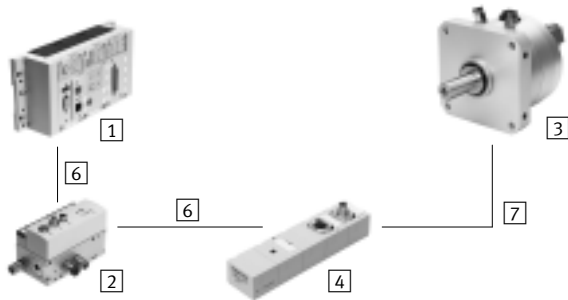

- 1 Controller module CPX-CMPX or CPX-CMAX
- 2 Proportional directional control valve VPWP
- 3 Swivel module DSMI with displacement encoder
- 4 Sensor interface CASM-S-D2-R3
- 6 Connecting cable KVI-CP-3-...
- 7 Connecting cable NEBC-P1W4-K-0,3-N-M12G5

- Swivel module DSMI with integrated displacement encoder
- Identical construction as pneumatic swivel module DSM
- Absolute displacement encoder on basis of potentiometer
- Swivel range from 0 ... 270°
- Size: 25, 40, 63
- Max. torque: 5 ... 40 Nm
- Range of application of Soft Stop and pneumatic positioning: mass moments of inertia from 15 ... 6000 kgcm<sup>2</sup> and the matching sensor interface CASM-S-D2-R3
- Pre-assembled cables guarantee faultless and fast connection with the proportional directional control valve VPWP

Advantages:

- Complete drive unit, compact, can be used immediately
- High angular acceleration
- With adjustable fixed stops
- For fast and accurate positioning down to ±0.2° (only with axis controller CPX-CMAX)

## System with potentiometer

Technical data → Internet: casm

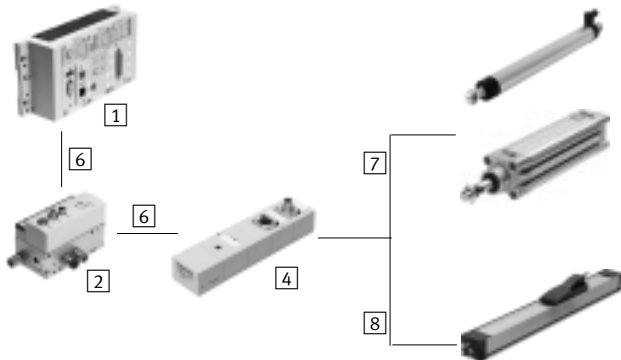

- 1 Controller module CPX-CMPX or CPX-CMAX
- 2 Proportional directional control valve VPWP
- 4 Sensor interface CASM-S-D2-R3
- 6 Connecting cable KVI-CP-3-...
- 7 Connecting cable NEBC-P1W4-K-0,3-N-M12G5
- 8 Connecting cable NEBC-A1W3-K-0,4-N-M12G5

- Attachable potentiometers with absolute measurement, with high degree of protection
- With connecting rod or moment compensator
- Measuring range:  
Connecting rod: 100 ... 750 mm  
Moment compensator: 225 ... 2000 mm
- Pre-assembled cables guarantee faultless and fast connection with the sensor interface CASM
- Range of applications: Soft Stop and pneumatic positioning with cylinder Ø 25 ... 80 mm, e.g. DNC or DSBC
- Loads from 1 ... 300 kg

Advantages:

- Easy installation and fast commissioning
- Cost-effective
- Can also be used in harsh ambient conditions
- Variety of drives: CPX-CMPX and CPX-CMAX also support cylinders with external displacement encoder

# Proportional directional control valves VPWP

Drive options

System components for Soft Stop systems with end-position controller CPX-CMPX							
[3]		Linear drive	Standard cylinder	Swivel module	Displacement encoder		→ Page/ Internet
		DDLI/DGCI	DNCI/DDPC	DSMI	MLO-LWG/-TLF	MME-MTS	
[1]	End-position controller CPX-CMPX	■	■	■	■	■	cpx-cmpx
[2]	Proportional directional control valve VPWP	■	■	■	■	■	7
[4]	Sensor interface CASM-S-D2-R3	-	-	■	■	-	casm
[5]	Sensor interface CASM-S-D3-R7	-	■	-	-	-	casm
[6]	Connecting cable KVI-CP-3-...	■	■	■	■	■	16
[7]	Connecting cable NEBC-P1W4-...	-	-	■	■ / -	-	nebc
[8]	Connecting cable NEBC-A1W3-...	-	-	-	- / ■	-	nebc
-	Connecting cable NEBP-M16W6-...	-	-	-	-	■	16

System components for pneumatic positioning systems with axis controller CPX-CMAX							
[3]		Linear drive	Standard cylinder	Swivel module	Displacement encoder		→ Page/ Internet
		DDLI/DGCI	DNCI/DDPC	DSMI	MLO-LWG/-TLF	MME-MTS	
[1]	Axis controller CPX-CMAX	■	■	■	■	■	cpx-cmax
[2]	Proportional directional control valve VPWP	■	■	■	■	■	7
[4]	Sensor interface CASM-S-D2-R3	-	-	■	■	-	casm
[5]	Sensor interface CASM-S-D3-R7	-	■	-	-	-	casm
[6]	Connecting cable KVI-CP-3-...	■	■	■	■	■	16
[7]	Connecting cable NEBC-P1W4-...	-	-	■	■ / -	-	nebc
[8]	Connecting cable NEBC-A1W3-...	-	-	-	- / ■	-	nebc
-	Connecting cable NEBP-M16W6-...	-	-	-	-	■	16

# Proportional directional control valves VPWP

Type codes

		VPWP	-	6	-	L	-	5	-	Q6	-	10	-	E	-	F	-		
<b>Series</b>																			
VPWP	Proportional directional control valve																		
<b>Nominal size</b>																			
<b>Valve type</b>																			
L	In-line valve																		
<b>Valve function</b>																			
5	5/3-way valve																		
<b>Pneumatic connection</b>																			
Q6	Push-in fitting 6 mm																		
Q8	Push-in fitting 8 mm																		
Q10	Push-in fitting 10 mm																		
Q	Thread without fitting																		
<b>Pressure range</b>																			
10	0 ... 10 bar																		
<b>Display type</b>																			
E	LED only																		
<b>Exhaust</b>																			
D	Ducted exhaust air																		
F	Flat plate silencer																		
G	Thread without fitting																		
<b>EU certification</b>																			
EX1	II 3G in accordance with EU Directive 94/9/EC																		

# Proportional directional control valves VPWP

Peripherals overview

FESTO

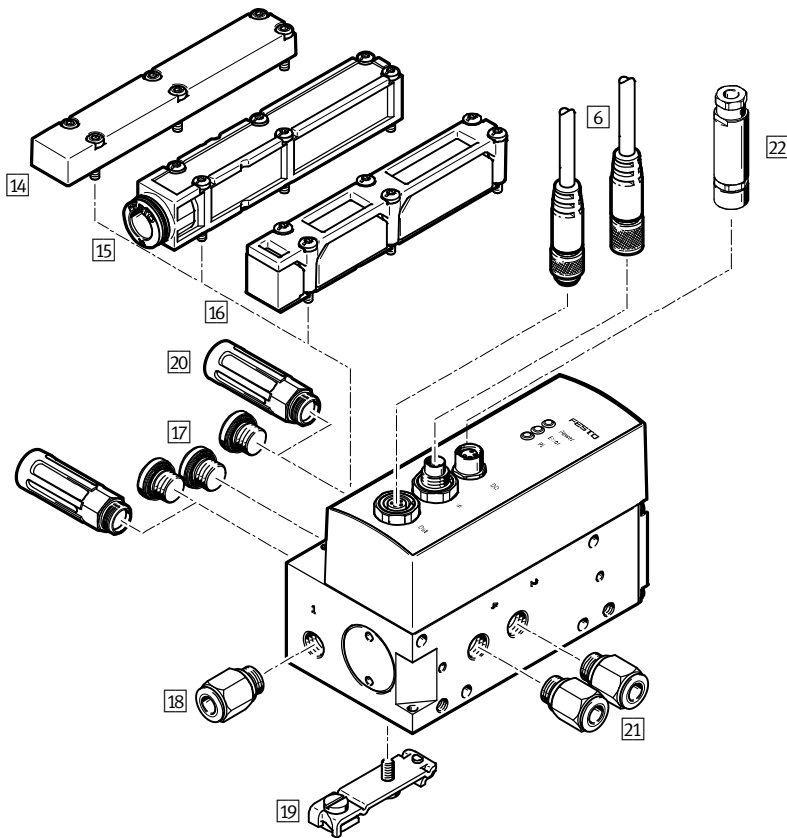

## Sub-bases VABP

The sub-base VABP [23](#) can be used to help realise specific switch-off behaviour when switching off the valve load voltage. It is a single-channel solution for uncoupling the drive from the power valve. 4 switch-off functions are possible.

Additional information

→ Internet: [vabp](#)

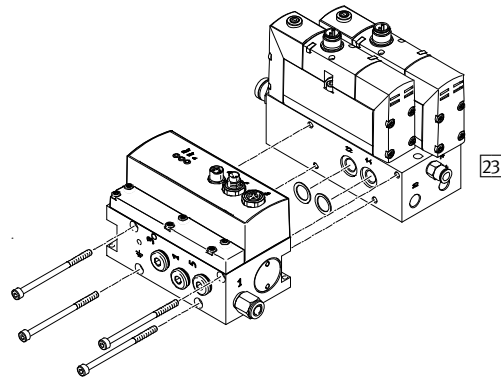



# Proportional directional control valves VPWP

Peripherals overview

Accessories				
		For nominal size	Description	→ Page/Internet
16	Connecting cable KVI-CP-3	4, 6, 8, 10	For connecting proportional directional control valve VPWP to the end-position controller CPX-CMPX/axis controller CPX-CMAX or to the sensor interface CASM	16
14	Blanking plate VABB-P3-1	4, 6, 8	For using the connections on the cover plate	16
15	Plate VMPA-AP	4, 6, 8	For ducted exhaust air	16
16	Plate VMPA-APU	4, 6, 8	With flat plate silencer	16
17	Blanking plug B	4, 6, 8	For sealing the exhaust ports on the cover plate	blanking plug
18	Push-in fitting QS	4, 6, 8	Push-in fittings for easy and error-free tubing connections can be ordered using the ordering data in the modular product system	15
19	Mounting CPASC1-BG, CPV10/14-VI-BG	4, 6, 8	For mounting on an H-rail	16
20	Silencer U	4, 6, 8, 10	<ul style="list-style-type: none"> <li>Silencers can be used as an alternative to the plates 15 and 16 with the nominal sizes 4, 6 and 8</li> <li>Silencers must be used for the exhaust air with the nominal size 10</li> </ul>	silencer
21	Push-in fitting QS	4, 6, 8	<ul style="list-style-type: none"> <li>Different coloured push-in fittings for easy and error-free tubing connections can be ordered using the ordering data in the modular product system</li> <li>For connecting compressed air tubing with standard O.D.</li> </ul>	15
		10	<ul style="list-style-type: none"> <li>Push-in fittings must be ordered separately</li> <li>For connecting compressed air tubing with standard O.D.</li> </ul>	17
22	Plug NECU	4, 6, 8, 10	For connecting the solenoid valves to the proportional directional control valve VPWP	16



# Proportional directional control valves VPWP

FESTO

Technical data

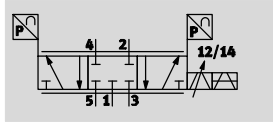
Function



-  - Voltage  
24 V DC
-  - Flow rate  
350 ... 2000 l/min
-  - Pressure  
0 ... 10 bar



General technical data				
Nominal size	4	6	8	10
Pneumatic connection	G1/8		G1/4	G3/8
Nominal size [mm]	4	6	8	10
Standard nominal flow rate [l/min]	350	700	1400	2000
Valve function	5/3-way proportional directional control valve, closed			
Design	Piston spool with integrated pressure sensors			
Sealing principle	Hard			
Actuation type	Electric			
Reset method	Magnetic spring			
Type of control	Direct			
Direction of flow	Non-reversible			
Type of mounting	Direct mounting via through-holes			
	Via H-rail			-
Mounting position <sup>1)</sup>	Preferably horizontal (display elements facing upwards)			
Product weight [g]	776	776	1060	1010
Pressure sensors				
Repetition accuracy FS [%]	< 1			
Pressure resolution [bar]	0.01			
Linearity error FS <sup>2)</sup> [%]	< 1.5			
Diagnostics				
LED displays	Green	Nominal operating voltage		
	Red	Error		
	Yellow	Load voltage		
Device-specific diagnostics via control interface	<ul style="list-style-type: none"> <li>- Undervoltage with operating and load voltage</li> <li>- Temperature monitoring</li> <li>- Valve sticking</li> <li>- Short-circuit monitoring</li> <li>- Device data</li> </ul>			
Control interface				
Data	CAN bus with Festo protocol			
	Digital			
	Integrated terminating resistor			
Electrical connection	5-pin			
	M9			
	Plug			

1) If the proportional directional control valve moves during operation, it must be mounted at right angles to the direction of movement

2) Based on 6 bar

# Proportional directional control valves VPWP

Technical data

Electrical data		
Load supply		
Operating voltage range	[V DC]	18 ... 30
Nominal operating voltage	[V DC]	24
Load voltage range	[V DC]	18 ... 30
Nominal load voltage	[V DC]	24
Residual ripple	[Vss]	4
Max. current consumption (logic)	[A]	0.15
Max. current consumption (valve drive)	[A]	1.2
Power supply requirement		PELV (Protective Extra-Low Voltage)
Safety note		The valve assumes the closed mid-position if there is a problem with the control interface
Digital output (plug D0, PIN2)		
Supply voltage	[V DC]	24 (coming from load voltage)
Max. load current	[mA]	500
Properties		<ul style="list-style-type: none"> <li>– Positive logic (PNP) to IEC 61131-2</li> <li>– No galvanic isolation</li> <li>– Protected against short circuits</li> <li>– Reverse supply with no damage</li> </ul>
Voltage output (plug D0, PIN4)		
Supply voltage	[V DC]	24 (coming from load voltage)
Max. load current	[mA]	500
Properties		<ul style="list-style-type: none"> <li>– Positive logic (PNP) to IEC 61131-2</li> <li>– No galvanic isolation</li> <li>– Protected against short circuits</li> <li>– Reverse supply with no damage</li> </ul>

Operating and environmental conditions				
Nominal size	4	6	8	10
Operating medium	Compressed air in accordance with ISO 8573-1:2010 [6:4:4]			
Note on operating/pilot medium	Operation with lubricated medium not possible			
Operating pressure	[bar]	0 ... 10		
Nominal operating pressure	[bar]	6		
Operating pressure for positioning/Soft Stop	[bar]	4 ... 8		
Ambient temperature	[°C]	0 ... 50		
Temperature of medium	[°C]	0 ... 50		
Storage temperature	[°C]	-20 ... +70		
CE marking (see declaration of conformity)	To EU EMC Directive			
Protection class <sup>1)</sup>	IP65			
Vibration resistance to DIN/IEC 68, Part 2-6	With wall mounting: tested to severity level 2			
	With H-rail mounting: tested to severity level 1		–	
Continuous shock resistance to DIN/IEC 68, Part 2-27	With wall mounting: tested to severity level 2			
	With H-rail mounting: tested to severity level 1		–	
Corrosion resistance class CRC <sup>2)</sup>	1			
Certification	C-Tick			

1) In assembled state, with plug, at nominal pressure and with tubing connected

2) Corrosion resistance class CRC 1 to Festo standard FN 940070

Low corrosion stress. For dry indoor applications or transport and storage protection. Also applies to parts behind covers, in the non-visible interior area, and parts which are covered in the application (e.g. drive trunnions).

ATEX	
ATEX category for gas	II 3G
Explosion ignition protection type for gas	Ex nA IIC T5 X Gc
Explosion-proof temperature rating	0 °C ≤ Ta ≤ +50 °C
CE marking (see declaration of conformity)	To EU Explosion Protection Directive (ATEX)

# Proportional directional control valves VPWP

Technical data

FESTO

## Materials

Sectional view

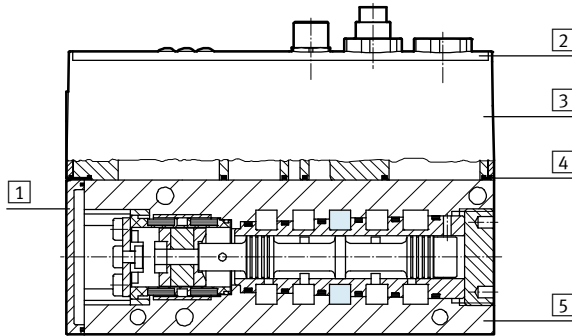

Proportional directional control valve

1	Cover	Reinforced polyamide
2	Inscription panel	Polyester
3	Electronics housing	Reinforced polyamide
4	Seals	Nitrile rubber
5	Valve housing	Anodised wrought aluminium alloy
-	Note on materials	RoHS-compliant

## Flow rate qnN as a function of digital actuation v<sub>c</sub> \* [100%]

Nominal size 4

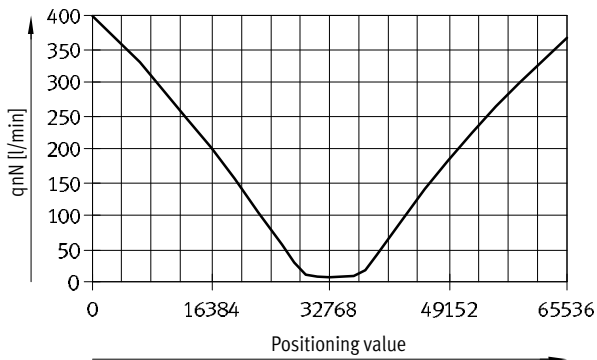

Nominal size 6

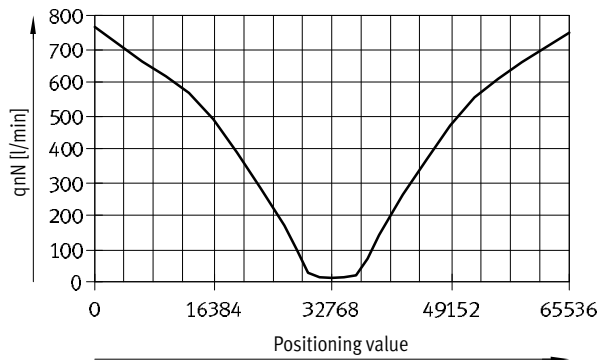

Nominal size 8

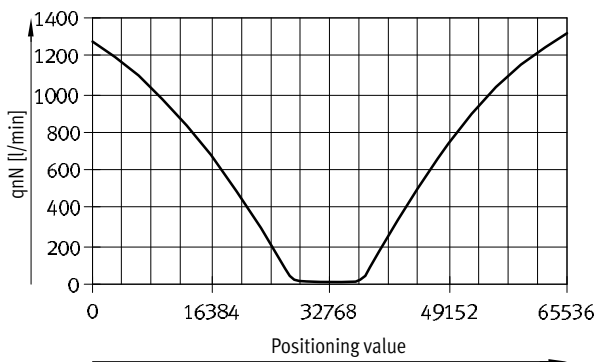

Nominal size 10

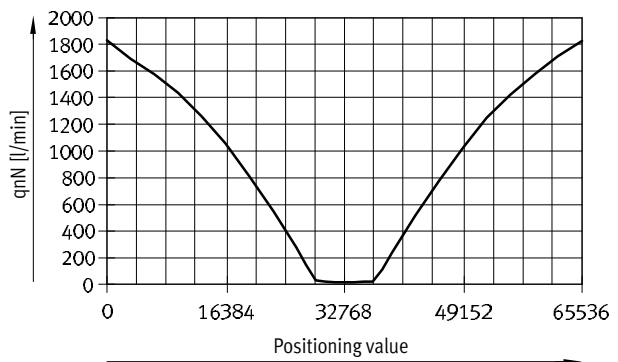

## Pin allocation

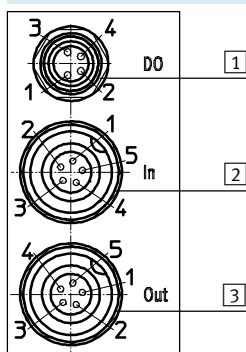

1 DO, 4-pin M8 socket	
Pin	Function
1	-
2	Digital output
3	0 V
4	24 V voltage output
-	
-	

2 IN, 5-pin M9 plug	
Pin	Function
1	24 V operating voltage
4	24 V load voltage
3	0 V
4	CAN_H
5	CAN_L
-	FE
-	

3 OUT, 5-pin M9 socket	
Pin	Function
1	24 V operating voltage
2	24 V load voltage
3	0 V
4	CAN_H
5	CAN_L
-	FE
-	

# Proportional directional control valves VPWP

Technical data

FESTO

## Dimensions

Download CAD data → [www.festo.com](http://www.festo.com)

Nominal size 4, 6, 8

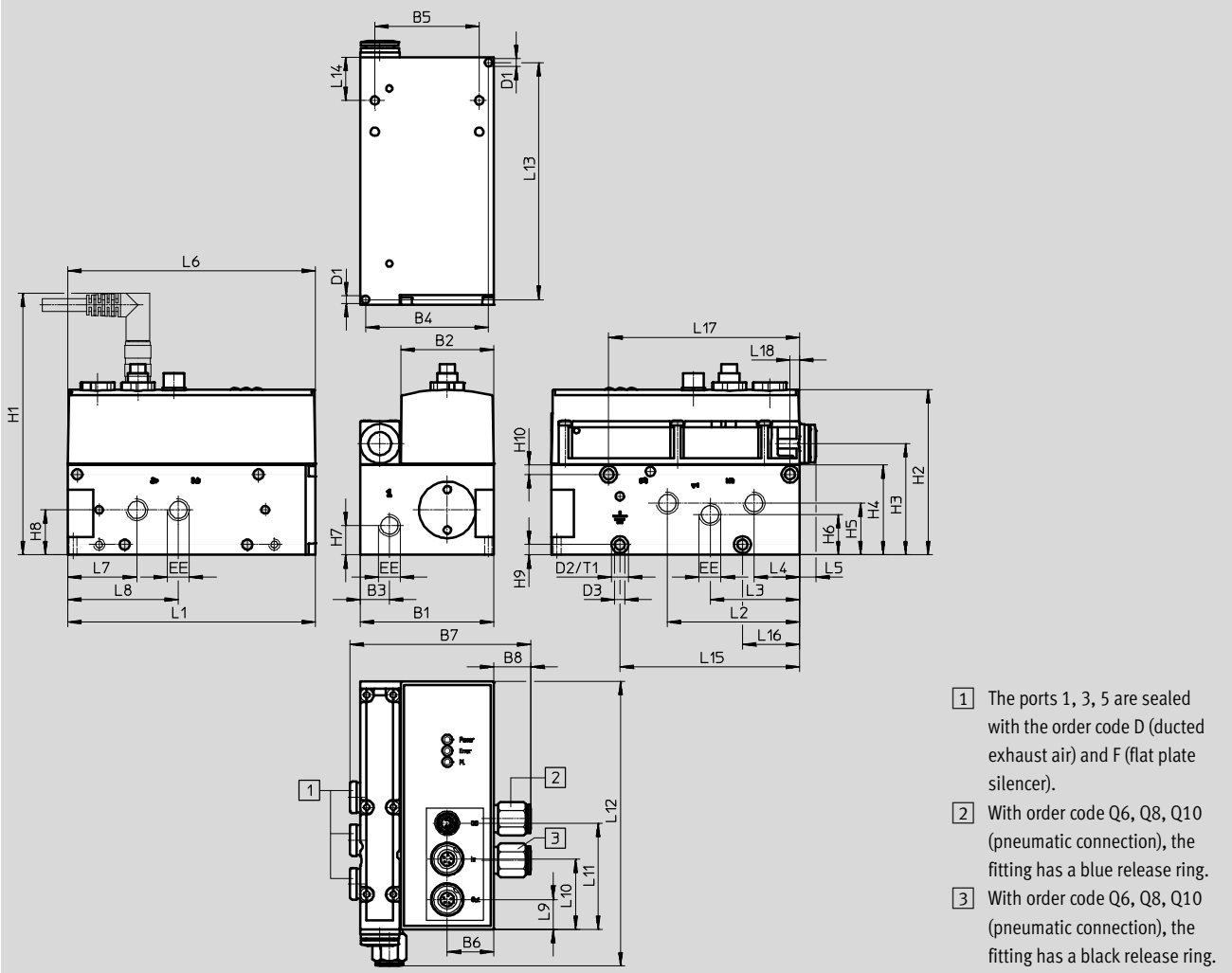

Nominal size	B1	B2	B3	B4	B5	B6	B7		B8		D1 ∅	D2 H13	D3 H13	EE
							Q6	Q8	Q6	Q8				
4	59.5	41.5	13	54.7	46.5	20.75	80.4	85.6	16.4	21.6	3.4	7.5	4.5	G1/8
6				64.5	56.5		85.6	85.6	21.6	21.6		8		
8	69.5						98.6	98.6	24.1	24.1				G1/4

Nominal size	H1 <sup>1)</sup>	H2	H3 <sup>2)</sup>	H4	H5	H6	H7	H8	H9 ±0.1	H10 ±0.1	L1	L2	L3	L4
4	approx. 120/116	73.5	50	40	23	18	13	20	5	4.7	110.4	58.8	39.8	20.3
6		81.5	58	48	28	22	15.5	24		5	122.3	67.6	45.2	22.8
8	approx. 128/124													

Nominal size	L5 <sup>2)</sup>	L6	L7	L8	L9	L10	L11	L12	L13	L14	L15 ±0.1	L16 ±0.1	L17 ±0.1	L18 ±0.1	T1
4	7.2	110.4	30.8	49.3	13.3	31.3	47.3	132	105.6	19.3	80	25.4	85	4.75	4.4
6			34	56.4				146.5	117.3	22.5	93	28.5	93	5	
8	–														

1) Angled plug/straight plug  
2) Only with variant D

# Proportional directional control valves VPWP

Technical data

FESTO

## Dimensions

Download CAD data → [www.festo.com](http://www.festo.com)

Nominal size 10

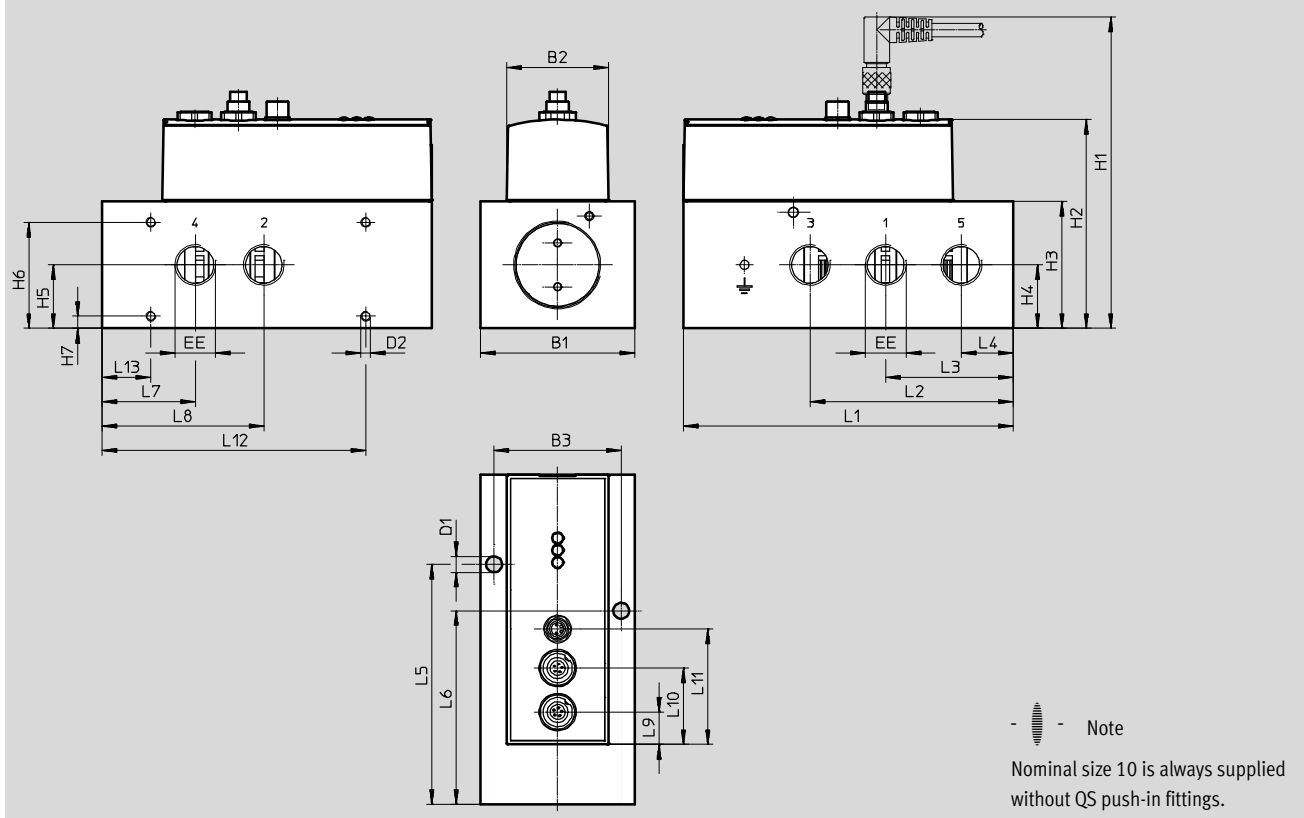

Nominal size	B1	B2	B3	D1	D2	EE	H1	H2
10	63	41.5	52	6.5	M4x10	G3/8	124	82

Nominal size	H3	H4	H5	H6	H7	L1	L2	L3	L4
10	48.5	24.25	24.25	±0.1	±0.1	135	83.2	52.2	21.2

Nominal size	L5	L6	L7	L8	L9	L10	L11	L12	L13
10	98.4	79.4	38.2	66.2	13.3	31.3	47.3	±0.1	±0.1

# Proportional directional control valves VPWP

Ordering data – Modular products

Ordering table						
Size	4	6	8	Condi- tions	Code	Enter code
<b>M</b> Module No.	<b>550170</b>	<b>550171</b>	<b>550172</b>			
Series	Proportional directional control valve				<b>VPWP</b>	VPWP
Nominal size	4	–	–		<b>-4</b>	
	–	6	–		<b>-6</b>	
	–	–	8		<b>-8</b>	
Valve type	In-line valve				<b>-L</b>	-L
Valve function	5/3-way valve				<b>-5</b>	-5
Pneumatic connection	Push-in fitting 6 mm	–	–		<b>-Q6</b>	
	Push-in fitting 8 mm	–	–		<b>-Q8</b>	
	–	–	Push-in fitting 10 mm		<b>-Q10</b>	
	Thread without fitting				<b>-Q</b>	
	G1/8	G1/8	G1/4			
Pressure range	0 ... 10 bar				<b>-10</b>	-10
Display type	LED only				<b>-E</b>	-E
Exhaust	Ducted exhaust air				<b>-D</b>	
	QSIK-S-10	QSIK-S-10	QSIK-S-10			
	Flat plate silencer				<b>-F</b>	
	Thread without fitting				<b>-G</b>	
	G1/8	G1/8	G1/4			
EU certification	II 3G				<b>-EX1</b>	

Transfer order code

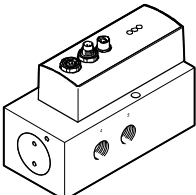
Ordering data	
Nominal size 10	Part No. Type
	1552544 VPWP-10-L-5-Q-10-E-G-EX1

# Proportional directional control valves VPWP

Accessories

FESTO

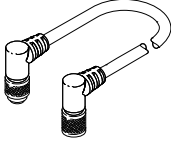
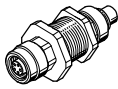
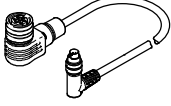
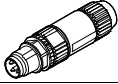
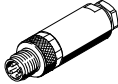
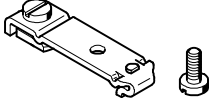
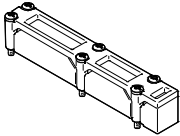
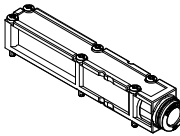
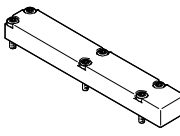
Ordering data – Connecting cables				
	Description	Cable length [m]	Part No.	Type
Connection between axis controller CPX-CMAX/end-position controller CPX-CMPX and proportional directional control valve VPWP or between proportional directional control valve VPWP and sensor interface CASM				
	Angled plug and angled socket	0.25	540327	KVI-CP-3-WS-WD-0,25
		0.5	540328	KVI-CP-3-WS-WD-0,5
		2	540329	KVI-CP-3-WS-WD-2
		5	540330	KVI-CP-3-WS-WD-5
		8	540331	KVI-CP-3-WS-WD-8
	Straight plug and straight socket	2	540332	KVI-CP-3-GS-GD-2
		5	540333	KVI-CP-3-GS-GD-5
		8	540334	KVI-CP-3-GS-GD-8
	Connector for control cabinet through-feed	–	543252	KVI-CP-3-SSD
Connection between displacement encoder MME and proportional directional control valve VPWP				
	For displacement encoder MME	2	575898	NEBP-M16W6-K-2-M9W5
Plug				
	<ul style="list-style-type: none"> <li>Insulation displacement connector</li> <li>Connection of the plug socket with cable KMC to the proportional directional control valve VPWP</li> </ul>	–	562025	NECU-S-M8G4-HX
	<ul style="list-style-type: none"> <li>Screw terminal</li> <li>Connection of the plug socket with cable KMC to the proportional directional control valve VPWP</li> </ul>	–	1068198	NECU-S-M8G4-C2
Ordering data – Mountings				
	Description		Part No.	Type
	For nominal size 4 and 6		527392	CPASC1-BG-NRH
	For nominal size 8		162556	CPV10/14-VI-BG-NRH-35
Ordering data – Exhaust variants				
	Description		Part No.	Type
	Plate with flat plate silencer for nominal size 4, 6, 8		533374	VMPA-APU
	Plate for ducted exhaust air for nominal size 4, 6, 8		533375	VMPA-AP
	Blanking plate, for using the connections on the valve block directly, for example for a silencer for nominal size 4, 6, 8		563896	VABB-P3-1



# Proportional directional control valves VPWP

Accessories

Ordering data – Push-in fittings			
	Nominal size	Part No.	Type
	Ports 2 and 4		
	4	186096	QS-G1/8-6
	4, 6	186098	QS-G1/8-8
	8	186101	QS-G1/4-10
	10	186103	QS-G3/8-12
	Port 1		
	4, 6	186098	QS-G1/8-8
	8	186101	QS-G1/4-10
	10	186103	QS-G3/8-12