

Proportional pressure regulators VEAB



Proportional-pressure regulators VEAB

Key features



Innovative

- Silent operation
- Very low power consumption
- High precision
- Short switching times
- Piezo technology

Versatile

- In-line valves
- Sub-base valves
- Simple electrical and pneumatic interfaces
- Choice of different setpoint specifications
 - Current input
 - Voltage input

Reliable

- Integrated pressure sensor with separate output
- Diagnostics
 - Operating voltage: over- and undervoltage
 - Setpoint value: falling below and exceeding
- Consistent pressure regulation performance with long-term stability
- Durable

Easy to install

- Mounting the in-line valve via three lateral through-holes
- Secure mounting on wall or H-rail

Proportional-pressure regulators VEAB

Key features – Display and operation

In-line valve

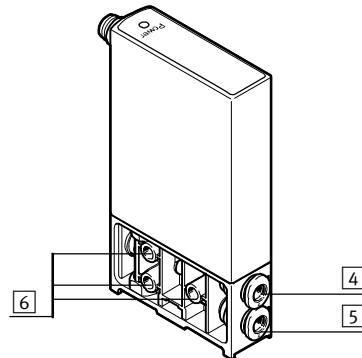
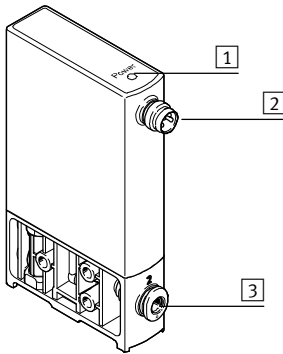

- 1 Power LED (green), fault LED (red)
- 2 Electrical connection, plug M8
- 3 Port 2, working air
- 4 Port 1, compressed air
- 5 Port 3, exhaust air
- 6 Through-holes for mounting the valve

Sub-base valve

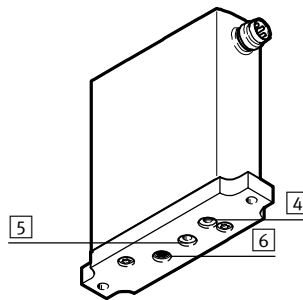
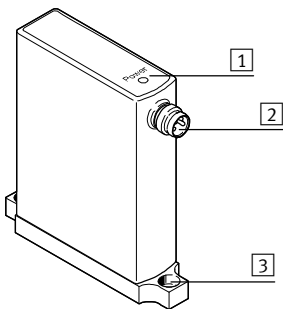

- 1 Power LED (green), fault LED (red)
- 2 Electrical connection, plug M8
- 3 Through-holes for mounting the valve on the sub-base
- 4 Port 2, working air
- 5 Port 3, exhaust air
- 6 Port 1, compressed air

Proportional-pressure regulators VEAB

Key features – Assembly

Mounting the valve manifold assembly

H-rail mounting

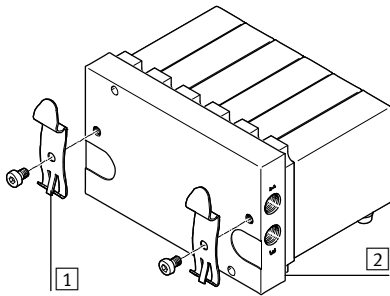

- 1 H-rail mounting
- 2 Manifold rail

The H-rail mounting can be used to mount the manifold rail on H-rails in accordance with EN 60715.

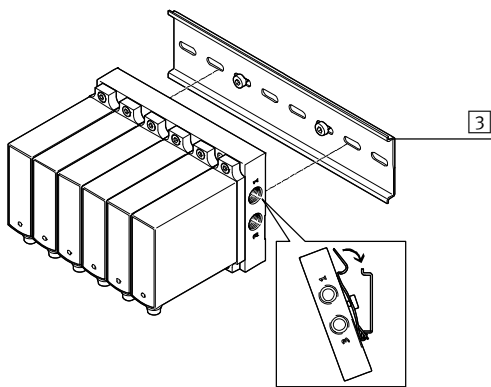

- 3 H-rail

To do this, the manifold rail with the H-rail mounting attached is mounted on the H-rail and latched in place.

Wall mounting

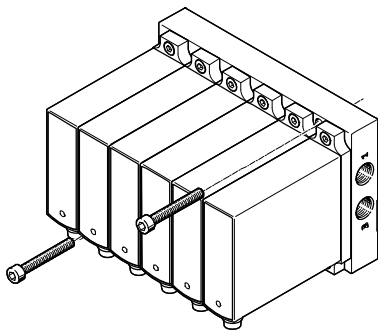

The manifold rail also has through-holes for wall mounting.

Proportional-pressure regulators VEAB

Product range overview

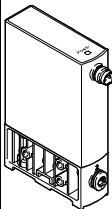
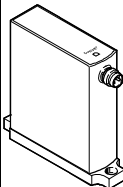
Version	Valve function	Pneumatic port 1, 2, 3	Pressure regulation range [bar]	Setpoint value input		→ Page/ Internet
				Voltage type	Current type	
				0 ... 10 V	4 ... 20 mA	
Pressure regulator	In-line valve					
	 3-way proportional-pressure regulator	Push-in connector	-1 ... -0.005 -1 ... 1 -1 ... 5 -0.5 ... 0.5 0.001 ... 0.2 0.005 ... 1 0.01 ... 2 0.03 ... 6	■	■	8
	Sub-base valve					
	 3-way proportional-pressure regulator	Via manifold rail	-1 ... -0.005 -1 ... 1 -1 ... 5 -0.5 ... 0.5 0.001 ... 0.2 0.005 ... 1 0.01 ... 2 0.03 ... 6	■	■	8

Proportional-pressure regulators VEAB

Peripherals overview

Valve manifold assembly VEAB

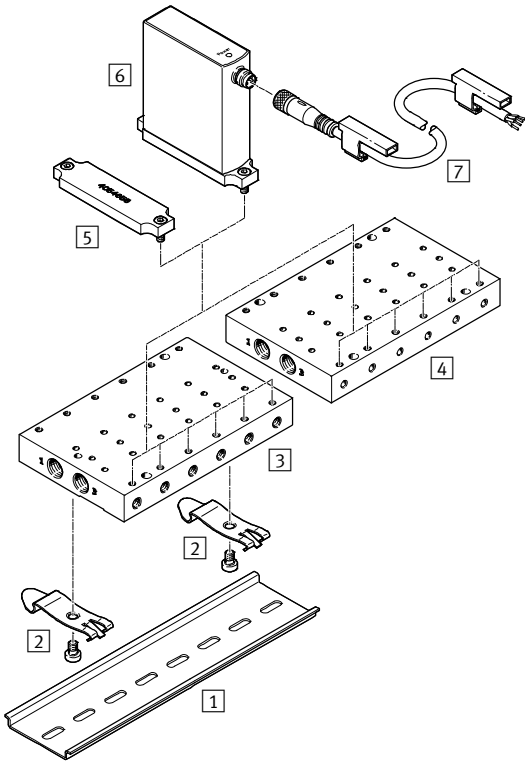

	Description	→ Page/Internet
1	H-rail NRH-35-2000 For control cabinet installation	24
2	H-rail mounting VAME For assembly of the H-rail	24
3	Manifold rail VABM-P7-G18M Connection direction at side, for control cabinet installation	23
4	Manifold rail VABM-P7-G18MB Connection direction underneath, for wall mounting and control cabinet installation	23
5	Cover plate VABB –	23
6	Proportional-pressure regulator VEAB –	23
7	Connecting cable NEBU –	24

Proportional-pressure regulators VEAB

Type codes

VEAB - [] - 26 - [] - [] - [] - 1 R1

Type

VEAB	Proportional-pressure regulator
------	---------------------------------

Valve type

B	Sub-base valve
L	In-line valve

Valve function

26	3-way proportional-pressure regulator
----	---------------------------------------

Pressure range

D2	0.01 ... 2 bar
D7	0.005 ... 1 bar
D9	0.03 ... 6 bar
D12	0.001 ... 0.2 bar
D13	-1 ... 1 bar
D14	-1 ... -0.005 bar
D15	-0.5 ... 0.5 bar
D18	-1 ... 5 bar

Pneumatic connection

F	Flange/sub-base
Q4	Push-in connector 4 mm

Setpoint input

A4	Current type 4 ... 20 mA
V1	Voltage type 0 ... 10 V

Operating voltage

1	24 V DC
---	---------

Electrical connection

R1	Plug, M8x1, 4-pin
----	-------------------

Proportional-pressure regulators VEAB

Technical data

 Flow rate
4.5 ... 20 l/min

 Voltage
24 V DC

 Pressure regulation range
-1 ... -0.005 bar
0.001 ... 0.2 bar
0.005 ... 1 bar
0.01 ... 2 bar
0.03 ... 6 bar
-1 ... 1 bar
-1 ... 5 bar
-0.5 ... 0.5 bar



General technical data		
Type	VEAB-L	VEAB-B
Valve type	In-line valve	Sub-base valve
Valve function	3-way proportional-pressure regulator	
Dimensions W x L x H	[mm] 18 x 60.5 x 85	18 x 67 x 66
Standard nominal flow rate	→ Page 11	
Pneumatic connection 1, 2, 3	Push-in connector 4 mm	Flange/via sub-base
Sealing principle	Soft	
Actuation type	Electric	
Display type	LED	
Type of control	Direct	
Reset method	Mechanical spring	
Type of mounting	Optionally with through-hole, with accessories	
Mounting position	Any	
Product weight	[g] 70	

Electrical data		
Electrical connection	Plug M8x1, 4-pin, to EN 60947-5-2	
Nominal operating voltage	[V DC] 24	
Operating voltage range	[V DC] 19 ... 29	
Residual ripple	[%] 10	
Max. electrical power consumption	[W] 1	
Setpoint input signal	Voltage	[V DC] 0 ... 10
	Current	[mA] 4 ... 20
Short circuit current rating	For all electrical connections	
Reverse polarity protection	For all electrical connections	
Degree of protection	IP65	

 **Note**

Safety position, VEAB:
If the electrical power supply fails,
the output pressure will be
unregulated and may rise or fall –
valve blocked.

Proportional-pressure regulators VEAB

Technical data

Operating and environmental conditions						
Pressure regulation range	[bar]	-1 ... -0.005	-1 ... 1	-1 ... 5	-0.5 ... 0.5	0.001 ... 0.2
Operating medium		Compressed air to ISO 8573-1:2010 [7:4:4]				
		Inert gases				
Note on the operating/pilot medium		Lubricated operation not possible				
Input pressure at port 1 ¹⁾	[bar]	-1	0 ... 2	0 ... 5.5	0 ... 2	0 ... 1
Input pressure at port 3	[bar]	-1	-1	-1	-1	-
Hysteresis FS (full scale)	[%]	0.25	0.5	0.5	0.5	0.5
Linearity error FS (full scale)	[%]	± 0.5	± 0.8	0.8	0.8	± 0.8
Repetition accuracy FS (full scale)	[%]	± 0.4				
Absolute accuracy at room temperature FS (full scale)	[%]	0.5	0.8	0.8	0.8	0.8
Accuracy of analogue output FS (full scale)	[%]	2				
Temperature coefficient	[%/K]	0.05				
Ambient temperature	[°C]	0 ... 50				
Temperature of medium	[°C]	5 ... 50				
Storage temperature	[°C]	-20 ... 70				
Corrosion resistance class CRC ²⁾		2				
CE marking (see declaration of conformity)		To EU EMC Directive ³⁾				
Certification		RCM compliance mark				

1) Input pressure 1 should always be 1 bar greater than the maximum regulated output pressure.

2) Corrosion resistance class CRC 2 to Festo standard FN 940070

Moderate corrosion stress. Indoor applications in which condensation may occur. External visible parts with primarily decorative requirements for the surface and which are in direct contact with the ambient atmosphere typical for industrial applications.

3) For information about the applicability of the component see the manufacturer's EC declaration of conformity at: www.festo.com/sp → Certificates.

If the component is subject to restrictions on usage in residential, office or commercial environments or small businesses, further measures to reduce the emitted interference may be necessary.

Operating and environmental conditions				
Pressure regulation range	[bar]	0.005 ... 1	0.01 ... 2	0.03 ... 6
Operating medium		Compressed air to ISO 8573-1:2010 [7:4:4]		
		Inert gases		
Note on the operating/pilot medium		Lubricated operation not possible		
Input pressure at port 1 ¹⁾	[bar]	0 ... 3	0 ... 4	0 ... 6.5
Input pressure at port 3	[bar]	-	-	-
Hysteresis FS (full scale)	[%]	0.25		
Linearity error FS (full scale)	[%]	± 0.5		
Repetition accuracy FS (full scale)	[%]	± 0.4		
Absolute accuracy at room temperature FS (full scale)	[%]	0.5		
Accuracy of analogue output FS (full scale)	[%]	2		
Temperature coefficient	[%/K]	0.05		
Ambient temperature	[°C]	0 ... 50		
Temperature of medium	[°C]	5 ... 50		
Storage temperature	[°C]	-20 ... 70		
Corrosion resistance class CRC ²⁾		2		
CE marking (see declaration of conformity)		To EU EMC Directive ³⁾		
Certification		RCM compliance mark		

1) Input pressure 1 should always be 1 bar greater than the maximum regulated output pressure.

2) Corrosion resistance class CRC 2 to Festo standard FN 940070

Moderate corrosion stress. Indoor applications in which condensation may occur. External visible parts with primarily decorative requirements for the surface and which are in direct contact with the ambient atmosphere typical for industrial applications.

3) For information about the applicability of the component see the manufacturer's EC declaration of conformity at: www.festo.com/sp → Certificates.

If the component is subject to restrictions on usage in residential, office or commercial environments or small businesses, further measures to reduce the emitted interference may be necessary.

Proportional-pressure regulators VEAB

Technical data

Materials	
Seals	NBR
Housing	PA-reinforced
Note on materials	RoHS-compliant
	Contains paint-wetting impairment substances

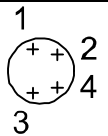
Pin allocation		
	Pin	Function
	1	+24 V DC supply voltage
	2	+ Setpoint value
	3	GND
	4	+ Actual value

Function

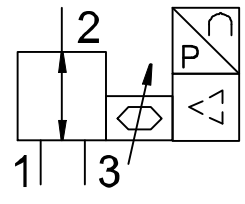

An integrated pressure sensor records the pressure at the working port and compares this value with the setpoint value.

The pressure is automatically readjusted in the event of deviations.

Proportional-pressure regulators VEAB

Technical data

VEAB-...-D14-..., pressure regulation range –1 ... –0.005

Flow rate q_n from 1 → 2 as a function of output pressure p_2

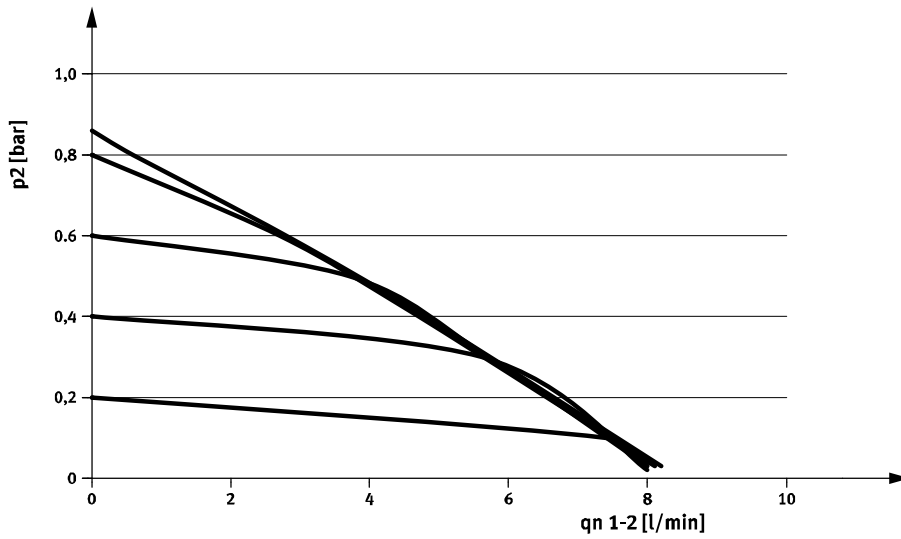

Flow rate q_n from 2 → 3 as a function of output pressure p_2

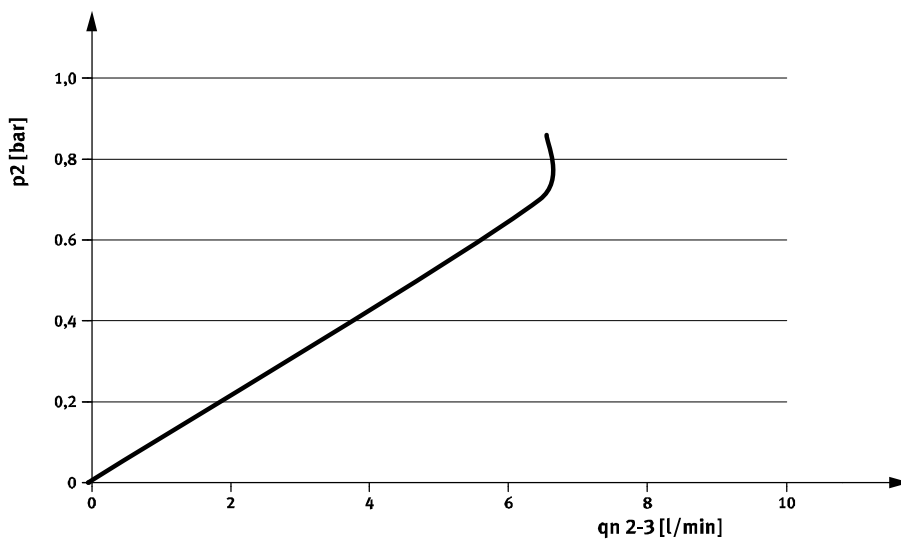

Proportional-pressure regulators VEAB

Technical data

VEAB-...-D13-..., pressure regulation range -1 ... 1

Flow rate q_n from 1 → 2 as a function of output pressure p_2

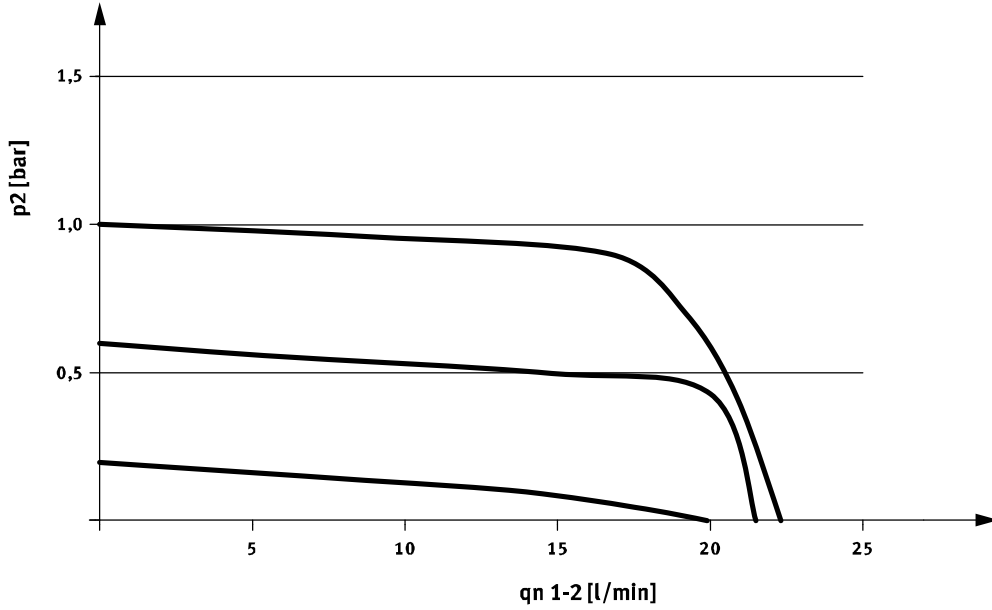

Flow rate q_n from 2 → 3 as a function of output pressure p_2

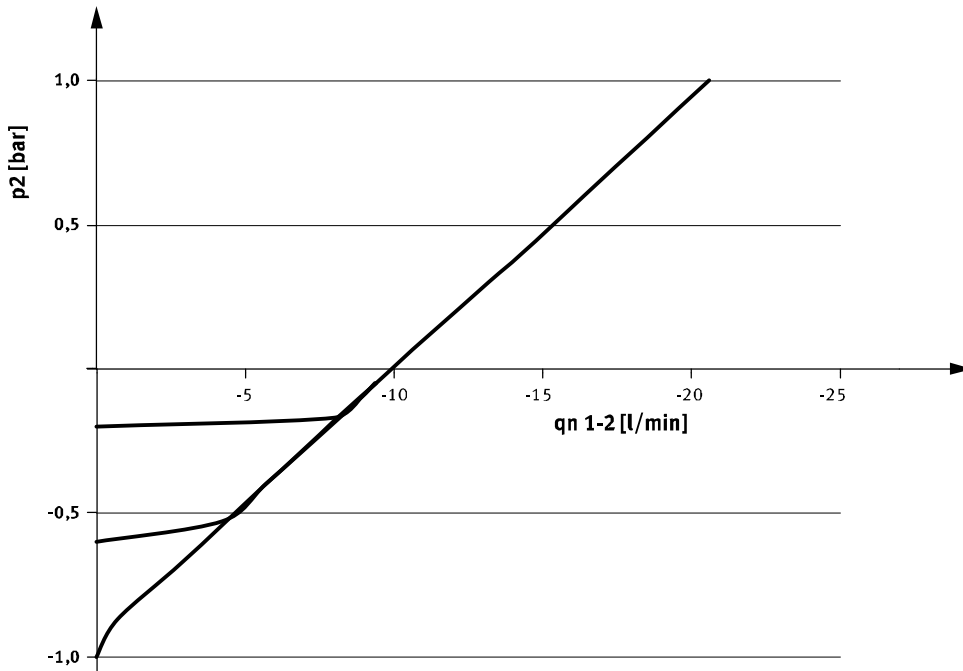

Proportional-pressure regulators VEAB

Technical data

VEAB-...-D18-..., pressure regulation range -1 ... 5

Flow rate q_n from 1 → 2 as a function of output pressure p_2

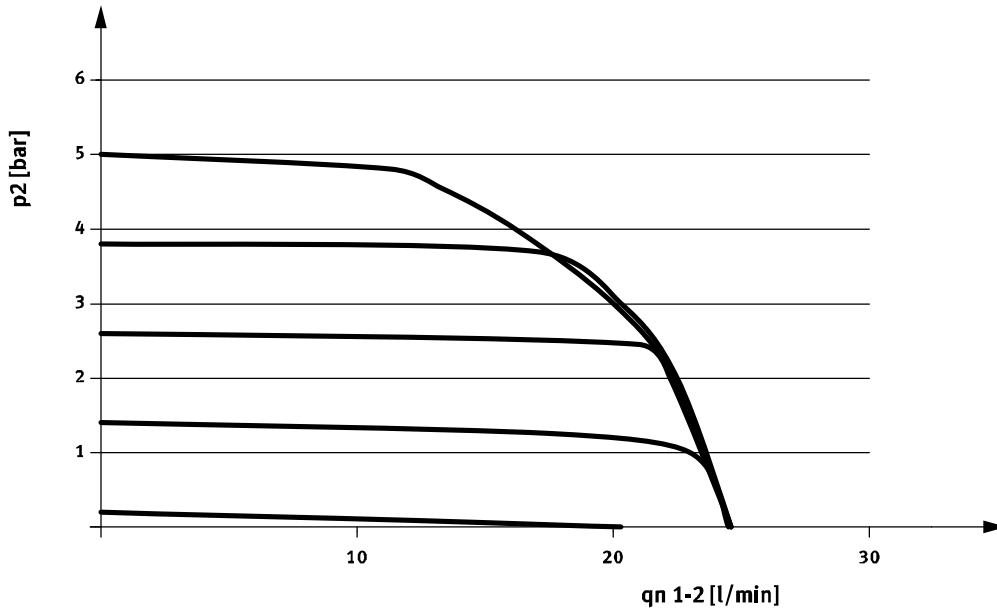

Flow rate q_n from 2 → 3 as a function of output pressure p_2

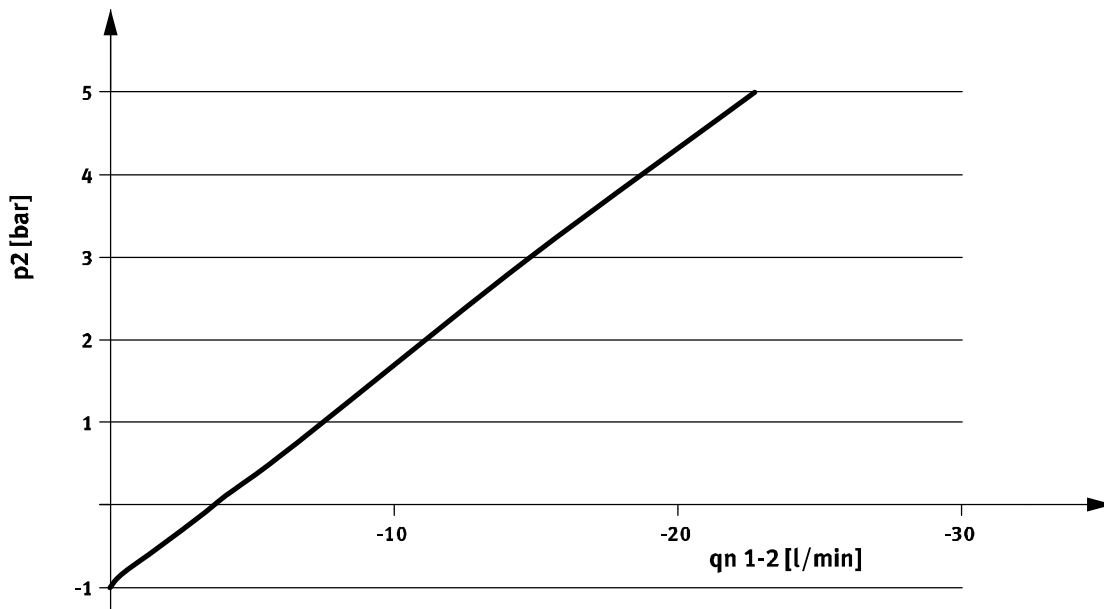

Proportional-pressure regulators VEAB

Technical data

VEAB-...-D15-..., pressure regulation range -0.5 ... 0.5

Flow rate q_n from 1 → 2 as a function of output pressure p_2

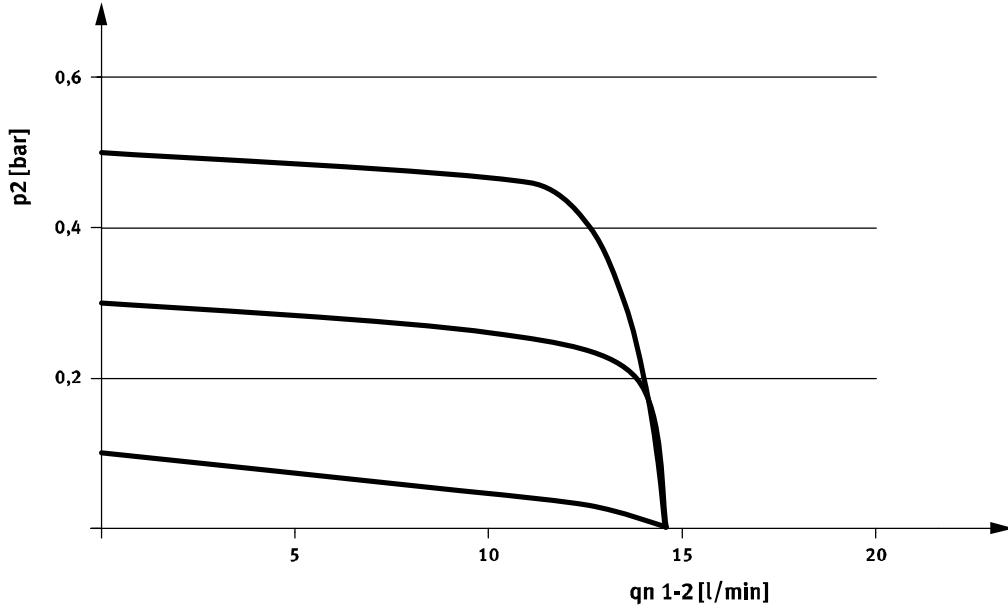

Flow rate q_n from 2 → 3 as a function of output pressure p_2

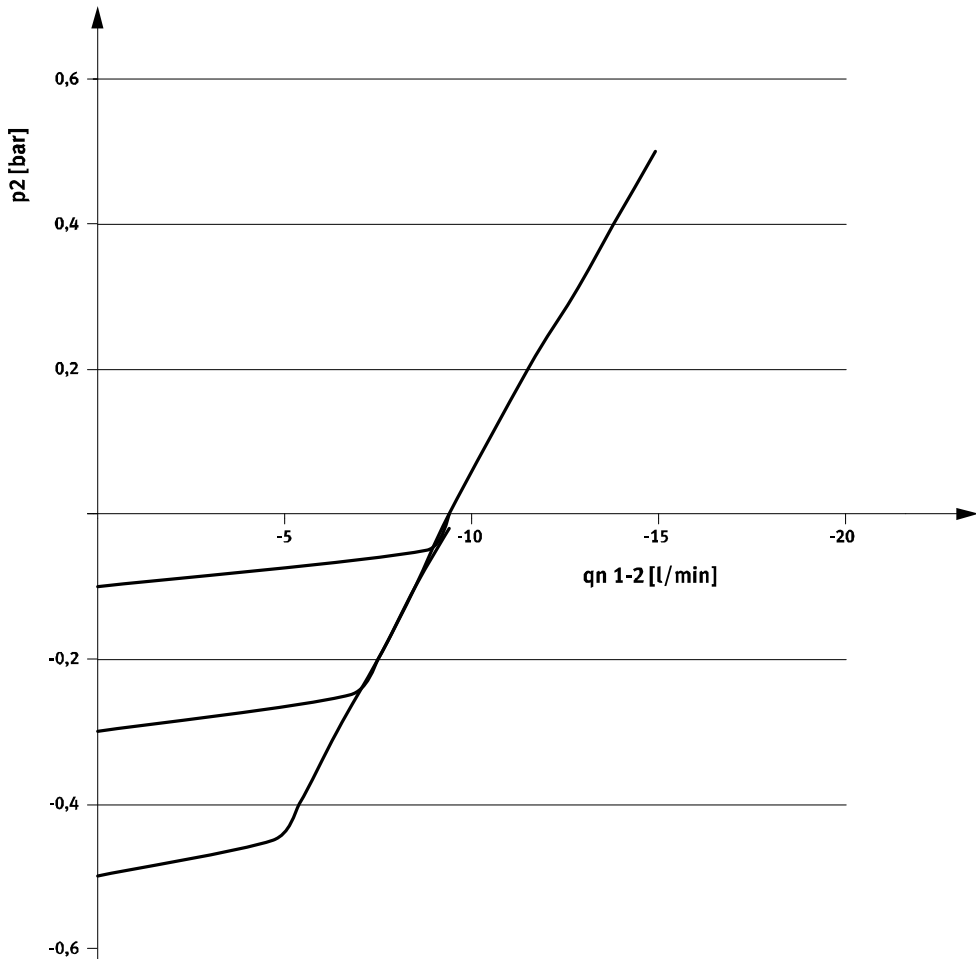

Proportional-pressure regulators VEAB

Technical data

VEAB-...-D12-..., pressure regulation range 0.001 ... 0.2

Flow rate q_n from 1 → 2 as a function of output pressure p_2

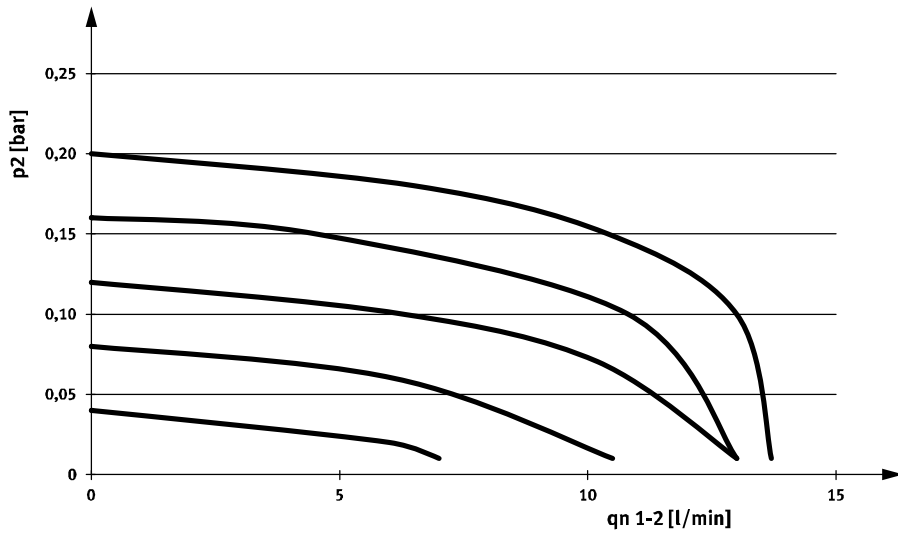

Flow rate q_n from 2 → 3 as a function of output pressure p_2

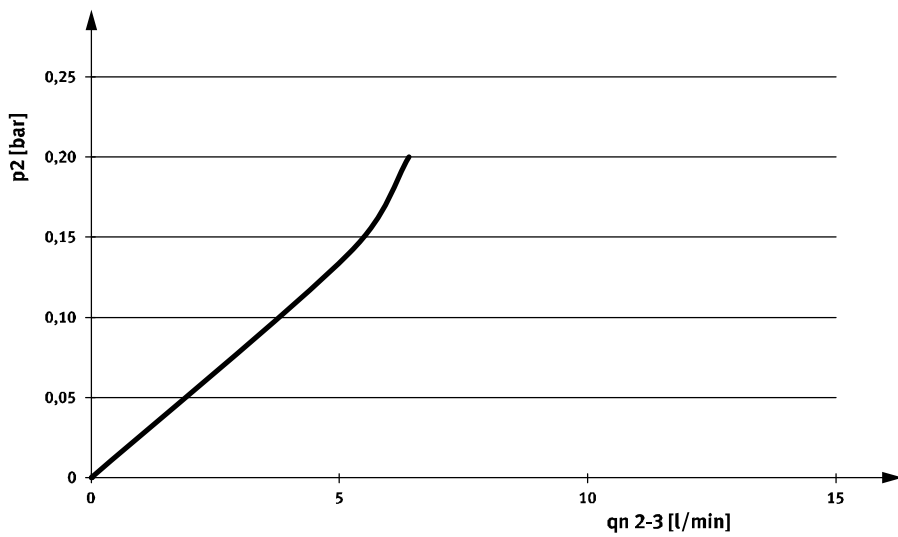

Proportional-pressure regulators VEAB

Technical data

VEAB-...-D7-..., pressure regulation range 0.005 ... 1

Flow rate q_n from 1 → 2 as a function of output pressure p_2

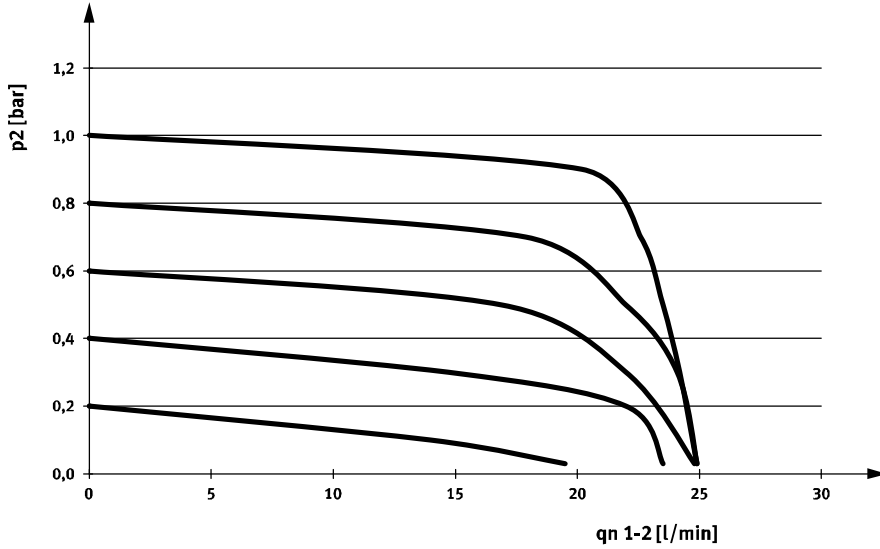

Flow rate q_n from 2 → 3 as a function of output pressure p_2

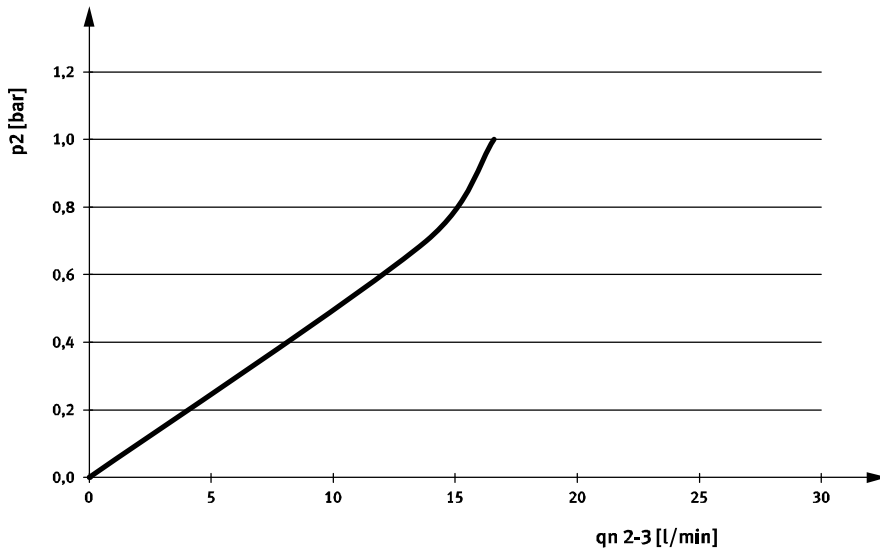

Proportional-pressure regulators VEAB

Technical data

VEAB-...-D2-..., pressure regulation range 0.01 ... 2

Flow rate q_n from 1 → 2 as a function of output pressure p_2

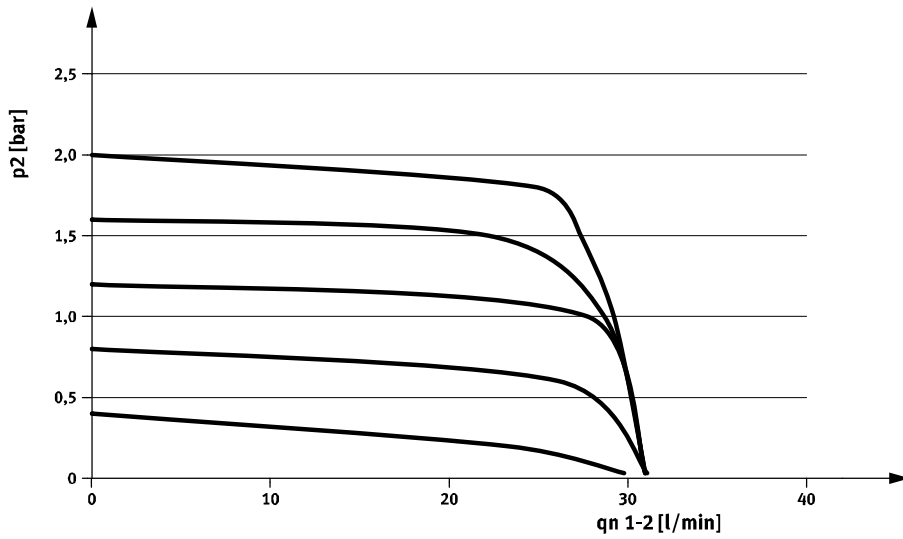

Flow rate q_n from 2 → 3 as a function of output pressure p_2

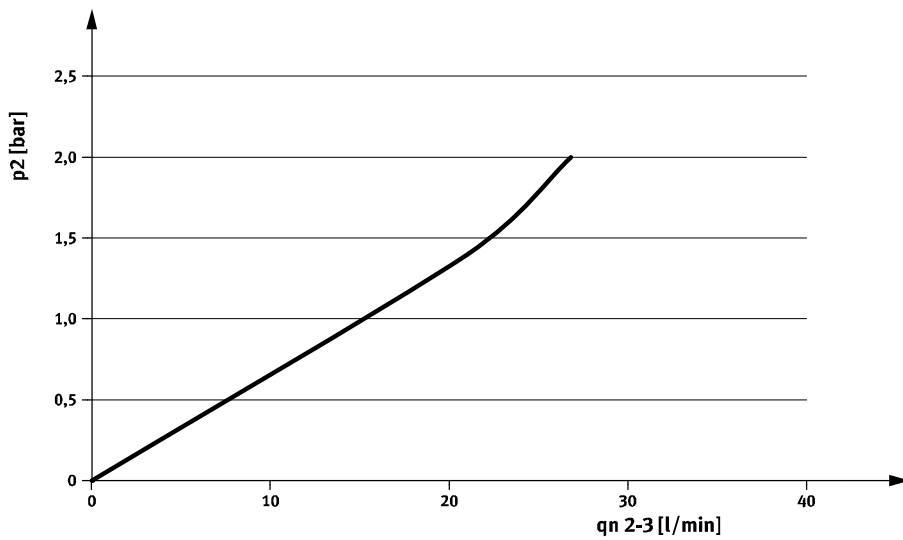

Proportional-pressure regulators VEAB

Technical data

VEAB-...-D9-..., pressure regulation range 0.03 ... 6

Flow rate q_n from 1 → 2 as a function of output pressure p_2

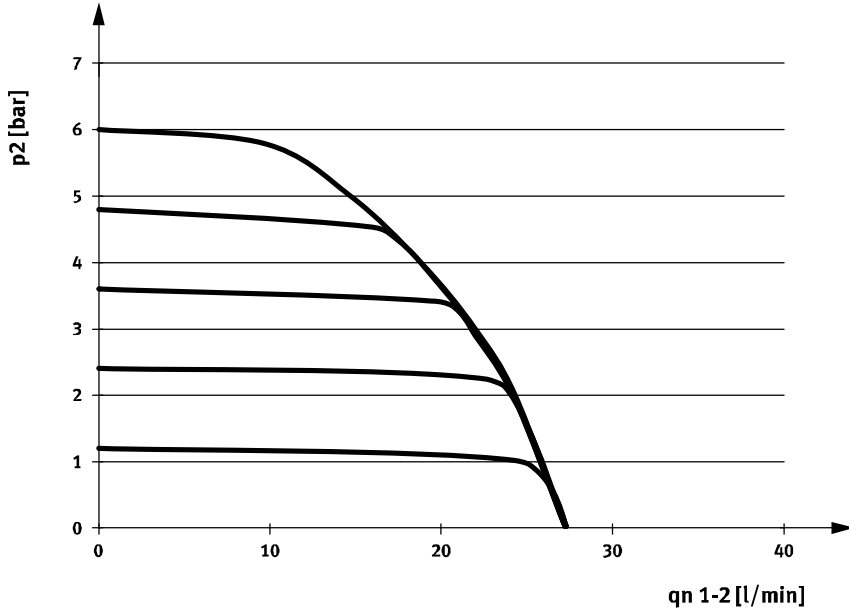

Flow rate q_n from 2 → 3 as a function of output pressure p_2

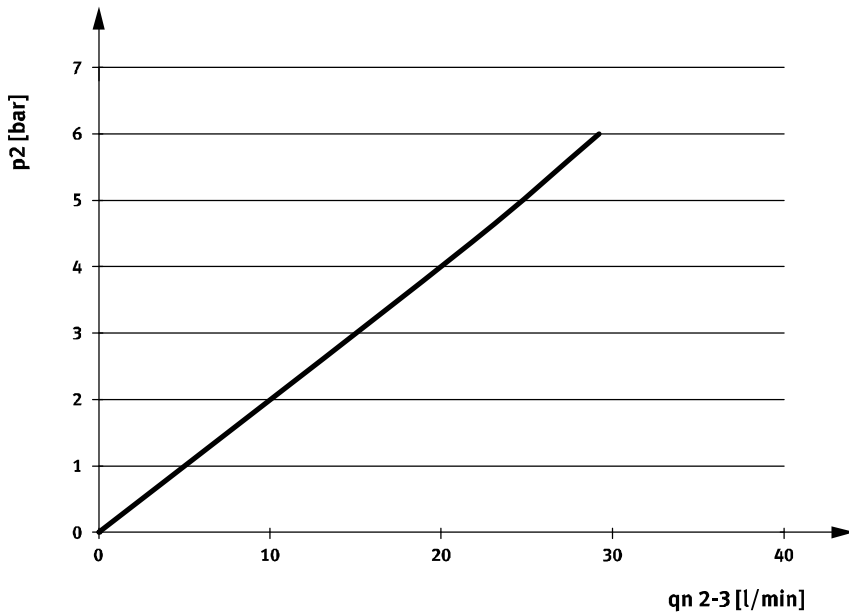

Proportional-pressure regulators VEAB

Technical data

Dimensions

Download CAD data → www.festo.com

In-line valve

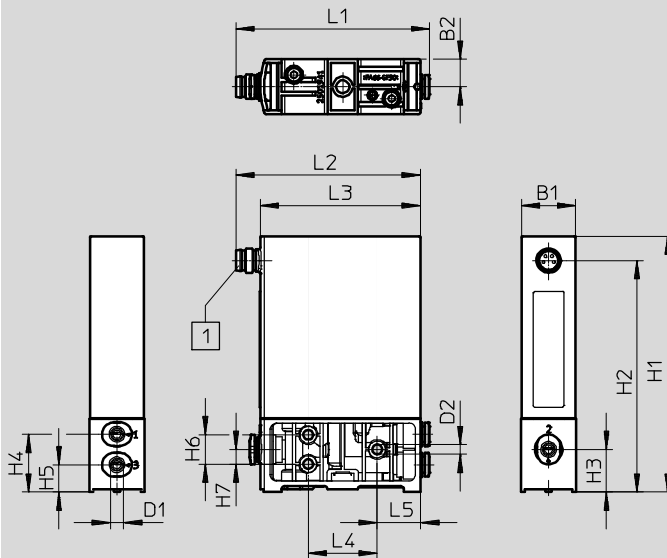

1 Plug M8x1, 4-pin

Type	B1	B2	D1	D2	H1	H2	H3	H4	H5	H6	H7
VEAB-L	18	9	4	3.2	85	76	14	19	9.5	9.6	4.8

Type	L1	L2	L3	L4	L5
VEAB-L	64	60.5	52.5	22.6	14.2

Proportional-pressure regulators VEAB

Technical data

Dimensions

Download CAD data → www.festo.com

Sub-base valve

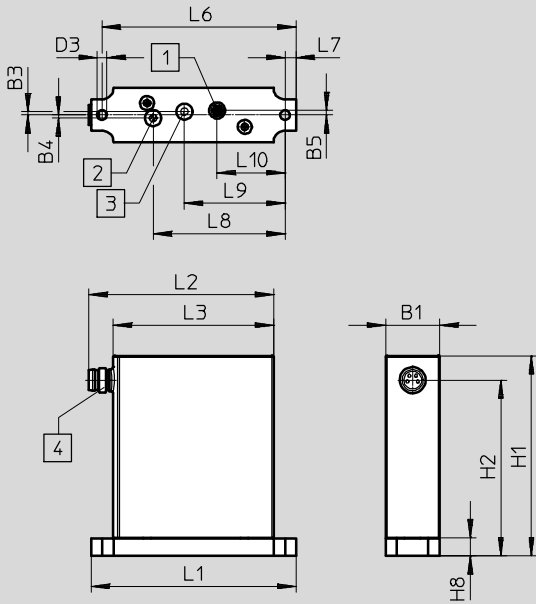

- 1 Port 1, compressed air
- 2 Port 2, working air
- 3 Port 3, exhaust air
- 4 Plug M8x1, 4-pin

Type	B1	B3	B4	B5	D3 Ø	H1	H2	H8
VEAB-B	18	1.1	1	1.5	3.2	66	58	6

Type	L1	L2	L3	L6	L7	L8	L9	L10
VEAB-B	67.2	60.5	52.5	63.6	3.6	43.3	33	22.3

Proportional-pressure regulators VEAB

Technical data

Dimensions – Manifold rail

Download CAD data → www.festo.com

Connection direction at side

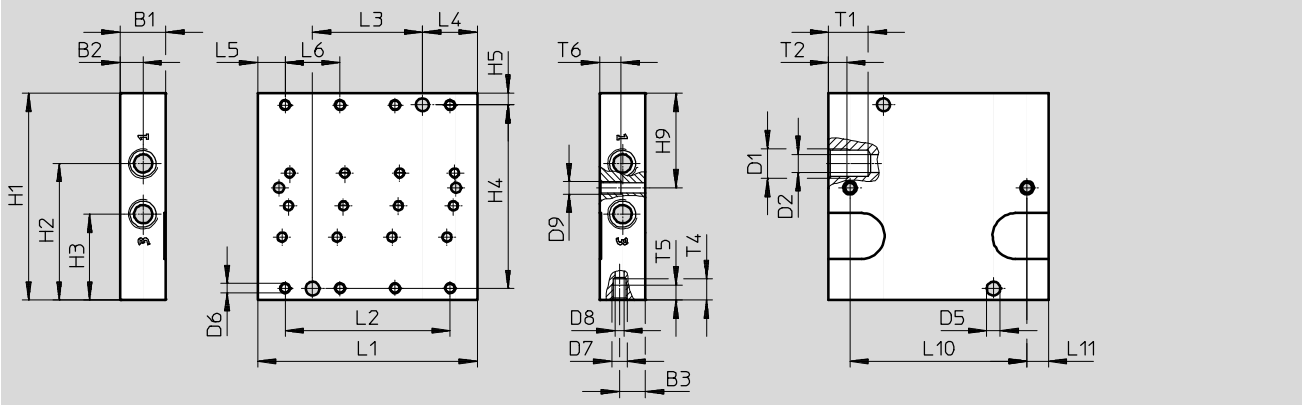

Type	B1	B2	B3	D1	D2	D5	D6	D7	D8	D9	H1	H2	H3	H4	H5	H9
VABM-P7-18M-G18-M5-4	15	7.5	8.5	G1/8	6	4.5	M3	M5	2.9	M4	67.8	44.8	28.2	60.2	3.8	31
VABM-P7-18M-G18-M5-6																
VABM-P7-18M-G18-M5-8																

Type	L1	L2	L3	L4	L5	L6	L10	L11	T1	T2	T4	T5	T6
VABM-P7-18M-G18-M5-4	72	54	36	18	9	18	58	7	13	6	7	5	7
VABM-P7-18M-G18-M5-6	108	90	72				94						
VABM-P7-18M-G18-M5-8	144	126	108				130						

Proportional-pressure regulators VEAB

Technical data

Dimensions – Manifold rail

Download CAD data → www.festo.com

Connection direction underneath

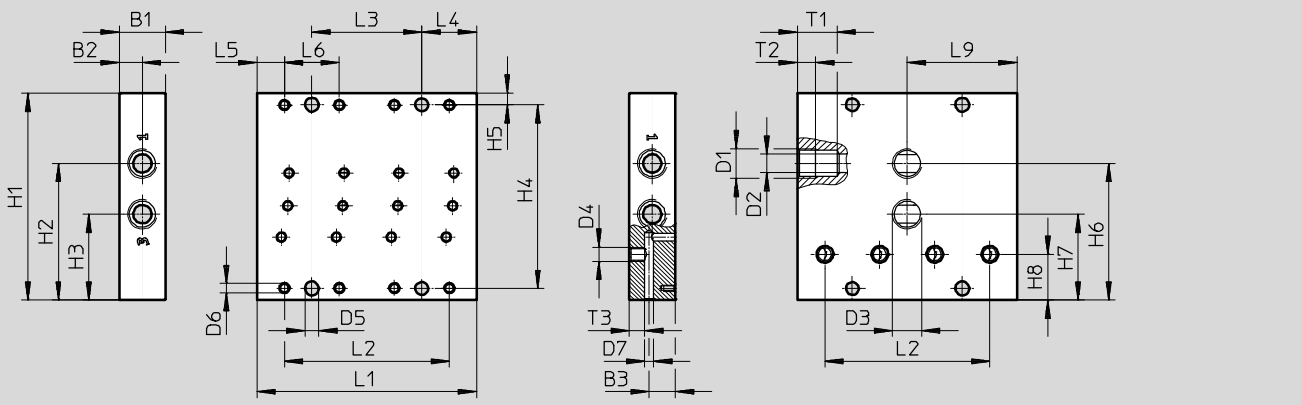



Type	B1	B2	B3	D1	D2	D3	D4	D5	D6	D7	H1	H2	H3	H4	H5	H6
VABM-P7-18MB-G18-M5-4	15	7.5	8.5	G1/8	6	G1/8	M5	4.5	M3	2.9	67.8	44.8	28.2	60.2	3.8	44.8
VABM-P7-18MB-G18-M5-6																
VABM-P7-18MB-G18-M5-8																

Type	H7	H8	L1	L2	L3	L4	L5	L6	L9	T1	T2	T3
VABM-P7-18MB-G18-M5-4	28.2	15	72	54	36	18	9	18	36	13	6	5
VABM-P7-18MB-G18-M5-6			108	90	72							
VABM-P7-18MB-G18-M5-8			144	126	108							

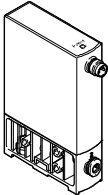
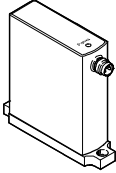
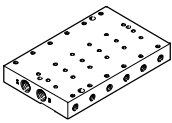
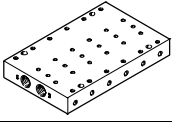

Proportional-pressure regulators VEAB

Accessories

Ordering data		Pressure regulation range [bar]	Part no.	Type
In-line valve				
	Voltage type, 0 ... 10 V	-1 ... -0.005	8046307	VEAB-L-26-D14-Q4-V1-1R1
		-1 ... 1	8067677	VEAB-L-26-D13-Q4-V1-1R1
		-1 ... 5	8067679	VEAB-L-26-D18-Q4-V1-1R1
		-0.5 ... 0.5	8067675	VEAB-L-26-D15-Q4-V1-1R1
		0.001 ... 0.2	8046301	VEAB-L-26-D12-Q4-V1-1R1
		0.005 ... 1	8046303	VEAB-L-26-D7-Q4-V1-1R1
		0.01 ... 2	8046305	VEAB-L-26-D2-Q4-V1-1R1
		0.03 ... 6	8046299	VEAB-L-26-D9-Q4-V1-1R1
	Current type, 4 ... 20 mA	-1 ... -0.005	8046308	VEAB-L-26-D14-Q4-A4-1R1
		-1 ... 1	8067678	VEAB-L-26-D13-Q4-A4-1R1
		-1 ... 5	8067680	VEAB-L-26-D18-Q4-A4-1R1
		-0.5 ... 0.5	8067676	VEAB-L-26-D15-Q4-A4-1R1
		0.001 ... 0.2	8046302	VEAB-L-26-D12-Q4-A4-1R1
		0.005 ... 1	8046304	VEAB-L-26-D7-Q4-A4-1R1
		0.01 ... 2	8046306	VEAB-L-26-D2-Q4-A4-1R1
		0.03 ... 6	8046300	VEAB-L-26-D9-Q4-A4-1R1
Sub-base valve				
	Voltage type, 0 ... 10 V	-1 ... -0.005	8046271	VEAB-B-26-D14-F-V1-1R1
		-1 ... 1	8067669	VEAB-B-26-D13-F-V1-1R1
		-1 ... 5	8067671	VEAB-B-26-D18-F-V1-1R1
		-0.5 ... 0.5	8067667	VEAB-B-26-D15-F-V1-1R1
		0.001 ... 0.2	8046265	VEAB-B-26-D12-F-V1-1R1
		0.005 ... 1	8046267	VEAB-B-26-D7-F-V1-1R1
		0.01 ... 2	8046269	VEAB-B-26-D2-F-V1-1R1
		0.03 ... 6	8046263	VEAB-B-26-D9-F-V1-1R1
	Current type, 4 ... 20 mA	-1 ... -0.005	8046272	VEAB-B-26-D14-F-A4-1R1
		-1 ... 1	8067670	VEAB-B-26-D13-F-A4-1R1
		-1 ... 5	8067672	VEAB-B-26-D18-F-A4-1R1
		-0.5 ... 0.5	8067668	VEAB-B-26-D15-F-A4-1R1
		0.001 ... 0.2	8046266	VEAB-B-26-D12-F-A4-1R1
		0.005 ... 1	8046268	VEAB-B-26-D7-F-A4-1R1
		0.01 ... 2	8046270	VEAB-B-26-D2-F-A4-1R1
		0.03 ... 6	8046264	VEAB-B-26-D9-F-A4-1R1
Manifold rail				
	Connection direction at side	4 valve positions	8076386	VABM-P7-18M-G18-M5-4
		6 valve positions	8076388	VABM-P7-18M-G18-M5-6
		8 valve positions	8076390	VABM-P7-18M-G18-M5-8
	Connection direction underneath	4 valve positions	8076387	VABM-P7-18MB-G18-M5-4
		6 valve positions	8076389	VABM-P7-18MB-G18-M5-6
		8 valve positions	8076391	VABM-P7-18MB-G18-M5-8
Cover plate				
	Including screws (2) and O-rings (3, preassembled)		4054658	VABB-P7-M

Proportional-pressure regulators VEAB

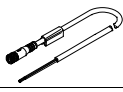
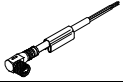
Accessories

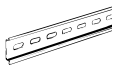
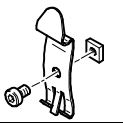
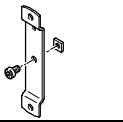
Ordering data			
	Description	Part no.	Type
Connecting cable Technical data → Internet: nebu			
	Straight socket, M8x1, 4-pin Open end, 4-wire	2.5 m	541342 NEBU-M8G4-K-2.5-LE4
		5 m	541343 NEBU-M8G4-K-5-LE4
	Angled socket, M8x1, 4-pin Open end, 4-wire	2.5 m	541344 NEBU-M8W4-K-2.5-LE4
		5 m	541345 NEBU-M8W4-K-5-LE4
	Straight socket, M8x1, 4-pin Straight plug, M8x1, 4-pin	2.5 m	554035 NEBU-M8G4-K-2.5-M8G4
H-rail			
	To EN 60715, 35 x 7.5 (WxH), for control cabinet installation	35430	NRH-35-2000
H-rail mounting			
	For H-rail NRH-35-2000	4054652	VAME-P7-T
Mounting plate			
	For in-line valve	4054656	VAME-P7-Y