

Sub-bases VABP



Sub-bases VABP

Key features

At a glance

The sub-base VABP can be used to help realise specific switch-off behaviour when switching off the valve load voltage. It is a single-channel solution for uncoupling the drive from the power valve. 4 switch-off functions are possible.

The sub-base is not a safety device, nor is it a complete safety solution. However, it can form part of a safety solution.

Features:

- Compact design
- Simple installation
- Suitable for servopneumatic drives
- Can be attached directly to the proportional directional control valve VPWP
- Connecting cable for direct connection to the proportional directional control valve VPWP
- Suitable for cylinders that are controlled by 5/2- or 5/3-way valves
- For ISO valves with spring return and external auxiliary pilot air
- Extended accessories: ISO solenoid valves with switching position sensing for producing a diagnostic rate > 60%

The technology in detail

- 1 Sub-base VABP (example with valves mounted)
- 2 Pilot air port
- 3 Function port B
- 4 Function port A
- 5 Solenoid valve VSVA, MN1H
- 6 Proportional directional control valve VPWP
- 7 Mounting screws

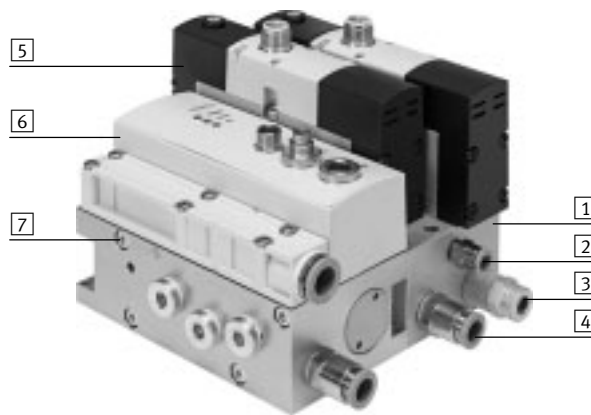

The 4 different single-channel switch-off functions can be configured using function ports 32 (A) and 34 (B):

- Stopping a movement: blocking
- De-energising: exhausting
- Reversing with reduced speed
- Switching off power: short-circuit

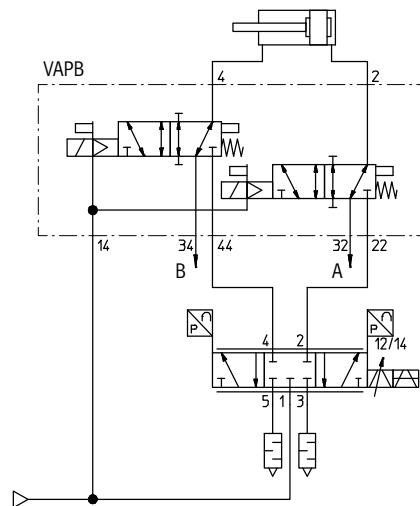

-  - Note

An application document "Demonstrating VABP protective measures" is available from the Support Portal.

Sub-bases VABP

Type codes

VABP - S3 - 26V1G - G18 - 2M - R3

Series	
VABP	Sub-base
Allocation	
S3	ISO 15407
S1	ISO 5599
Size	
26	Size 26
1	Size 1
2	Size 2
Version	
V1	Switching variant emergency stop functions
Connection type	
G	Supply air/exhaust air/pilot air supply/pilot exhaust air
Pneumatic port	
G18	G1/8
G14	G1/4
G38	G3/8
Valve positions	
2	2 valve positions
Equipment	
-	Without valves
M	With valves
Electrical connection	
-	Without
R3	Individual plug M12
A1	Individual plug type A

Sub-bases VABP

Peripherals overview

VABP-S3-26V1G / VABP-S1-1V1G

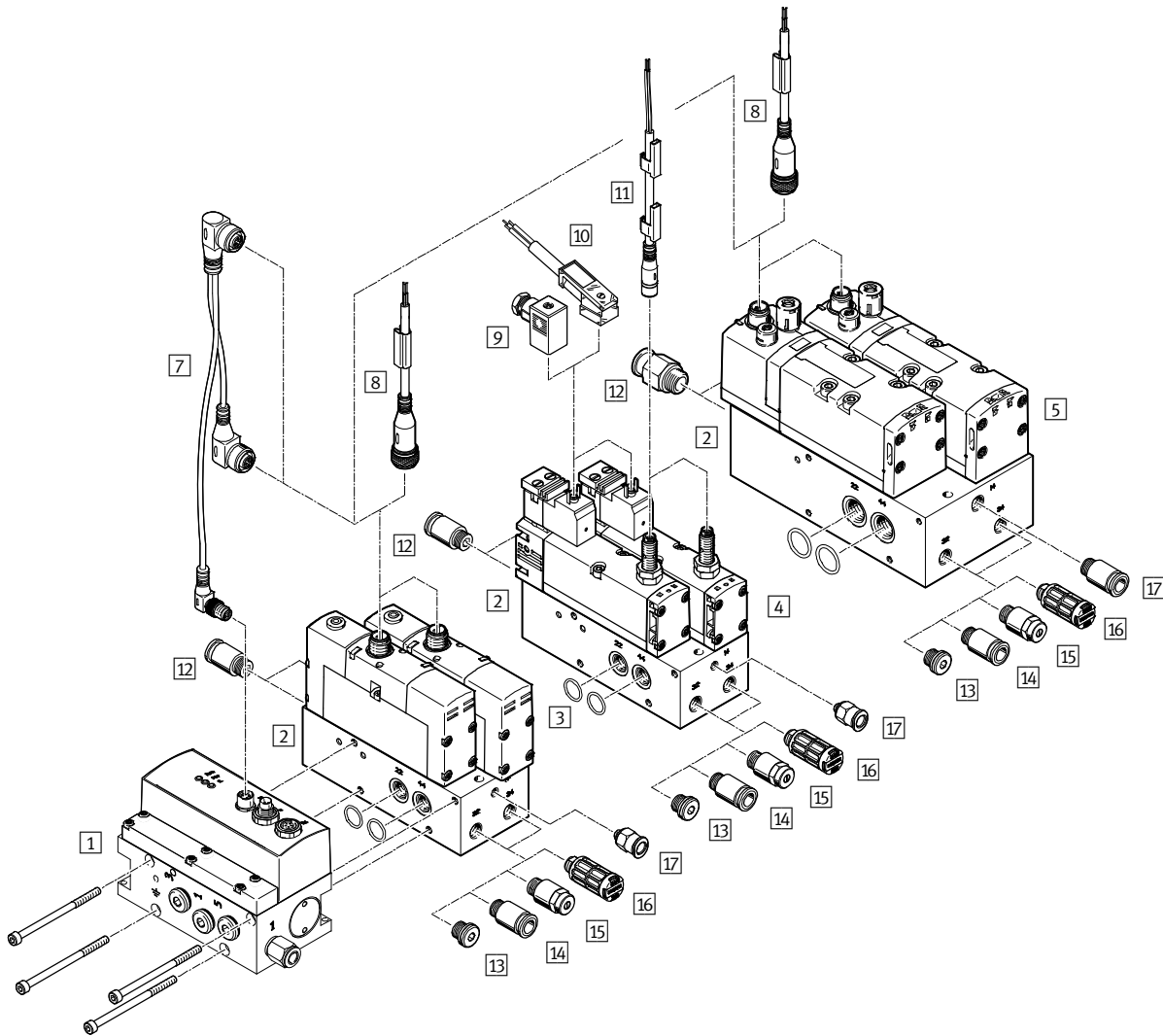

VABP-S1-2V1G

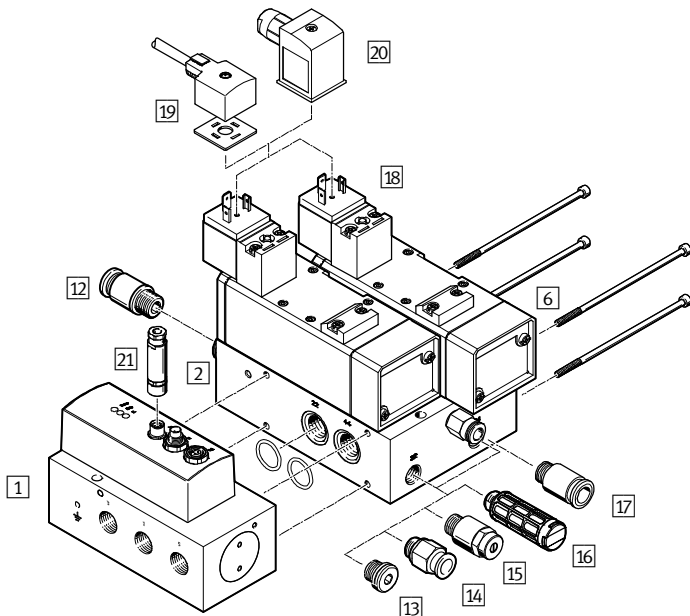

Sub-bases VABP

Peripherals overview

FESTO



Accessories		See allocation table below				Description	→ Page/ Internet
		3	4	5	6		
1	Proportional directional control valve VPWP	■	■	■	■	5/3-way proportional directional control valve for applications with Soft Stop and for pneumatic positioning	vpwp
2	Sub-base VABP	■	■	■	■	For realising specific switch-off functions	6
7	Connecting cable NEDV	■	-	■	-	Connection of solenoid valve to proportional directional control valve VPWP	15
8	Connecting cable NEBU-M12	■	-	■	-	Connection of solenoid valve to controller. Alternative to 7	15
9	Plug socket MSSD-EB	-	■	-	-	Connection of solenoid valve to controller. Alternative to 10	15
10	Plug socket with cable KMEB	-	■	-	-	Connection of solenoid valve to controller	15
11	Connecting cable NEBU-M8	-	■	-	-	Connection of switching position sensing system to controller	15
12	Push-in fitting QS	■	■	■	■	For working ports 2 and 4	15
13	Blanking plug B	■	■	■	■	<ul style="list-style-type: none"> For function ports 32 and 34 For realising a switch-off function 	14
14	Push-in fitting QS	■	■	■	■	<ul style="list-style-type: none"> For function ports 32 and 34 For realising a switch-off function 	15
15	Exhaust air flow control valve GRE	■	■	■	■	<ul style="list-style-type: none"> For function ports 32 and 34 For realising a switch-off function 	14
16	Silencer UC	■	■	■	■	<ul style="list-style-type: none"> For function ports 32 and 34 For realising a switch-off function 	14
17	Push-in fitting QS	■	■	■	■	For pilot air port 14	15
18	Solenoid coil MSN1G	-	-	-	■	For actuating the solenoid valve	14
19	Connecting cable KMC	-	-	-	■	Connection of solenoid valve to controller	15
20	Plug socket MSSD-C	-	-	-	■	Connection of solenoid valve to controller. Alternative to 19	15
21	Plug NECU	-	-	-	■	For connecting the solenoid valves to the proportional directional control valve VPWP	15

Allocation table		
Sub-base	Solenoid valve (→ 14)	Proportional directional control valve
3	VABP-S3-26V1G	VSVA-B-M52-MZH-A1-1R5L
4	VABP-S3-26V1G	VSVA-B-M52-MZ-A1-1C1-APP ¹⁾
5	VABP-S1-1V1G	VSVA-B-M52-MZD-D1-1R5L
6	VABP-S1-2V1G	MN1H-5/2-D-2-FR-S-C

1) Solenoid valve with switching position sensing

Sub-bases VABP

Technical data

-  Flow rate
800 ... 2000 l/min
-  Pressure
0 ... 16 bar

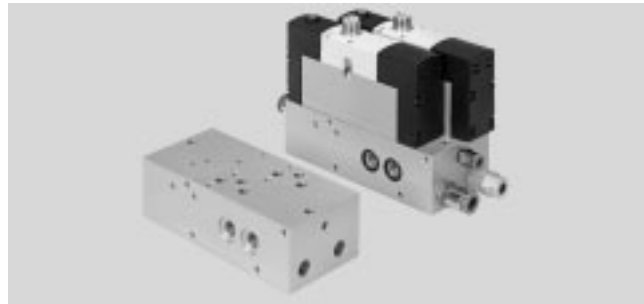

General technical data				
Type	VABP-S3-26V1G		VABP-S1-1V1G	VABP-S1-2V1G
For proportional directional control valve	VPWP-4/-6		VPWP-8	VPWP-10
Width	[mm]	26	42	54
Pneumatic port				
Working ports: 2, 4, 22, 44		G $\frac{1}{8}$	G $\frac{1}{4}$	G $\frac{3}{8}$
Pilot air supply: 14		M5	G $\frac{1}{8}$	G $\frac{1}{8}$
Function ports: 32, 34		G $\frac{1}{8}$	G $\frac{1}{8}$	G $\frac{1}{4}$
Nominal flow rate	[l/min]	800	1400	2000
Mounting position		Any		
Product weight				
Without valves	[g]	668	1623	1950
With valves	[g]	1200	2480	3400
With solenoid valve		1	2	3
Valve function		4		
Reset method		Mechanical spring		
Type of control		Piloted		
Pilot air supply		External		
Direction of flow		Reversible		
Switching position sensing		-	Yes	-
Switching element function		-	N/C contact	-
Switching output		-	PNP	-
Nominal width		9	11	11
Actuation type		Electrical		
Manual override		Without or covered		
Nominal operating voltage	[V]	24		
Perm. voltage fluctuations	[%]	±10	±10	-15/±10

Allocation table, solenoid valve	
1	VSVA-B-M52-MZH-A1-1R5L
2	VSVA-B-M52-MZ-A1-1C1-APP
3	VSVA-B-M52-MZD-D1-1R5L
4	MN1H-5/2-D-2-FR-S-C

Sub-bases VABP

Technical data

Operating and environmental conditions				
Type		VABP-S3-26V1G	VABP-S1-1V1G	VABP-S1-2V1G
Operating medium ¹⁾		Compressed air to ISO 8573-1:2010 [6:4:4]		
Operating pressure ¹⁾	[bar]	0 ... 16		
Pilot pressure with valves	[bar]	3 ... 8		
Ambient temperature	[°C]	0 ... +50		
Temperature of medium	[°C]	0 ... +50		

1) Note operating range of connected components.

Materials	
Manifold rail	Wrought aluminium alloy
O-ring	NBR
Screws	Steel
Note on materials	RoHS-compliant

Configuring the switch-off functions

The sub-base is not a safety device, nor is it a complete safety solution. However, it can form part of a safety solution.

Suitable accessories must be mounted at the function ports [32] and [34] in order to configure the different switch-off functions.

Sub-base	Silencer	Blanking plug	Exhaust air flow control valve	Push-in fitting
VABP-S3-26V1G	U-1/8	B-1/8	GRE-1/8	QS-G1/8-4, 6 or 8
VABP-S1-1V1G	U-1/8	B-1/8	GRE-1/8	QS-G1/8-4, 6 or 8
VABP-S1-2V1G	U-1/4	B-1/4	GRE-1/4	QS-G1/4-6, 8 or 10

Switch-off variants

Circuit 1: Stopping a movement – blocking

When the valves are switched off, the movement of the drive will be stopped.

Note:

- Following actuation of the switch-off function, the drive will be under pressure
- In the case of a vertical mounting position, it is possible that the payload will slowly drop

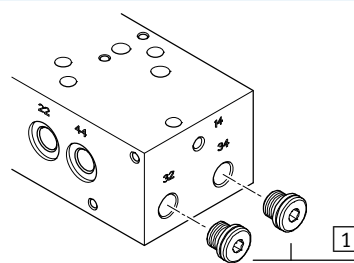

1) Blanking plug

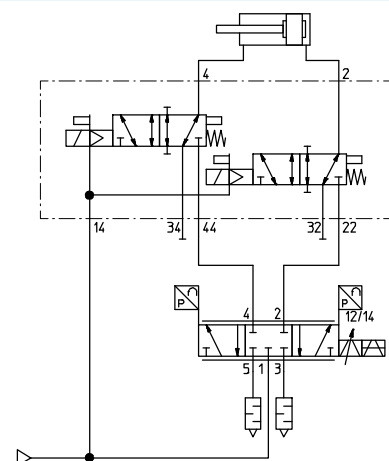

Sub-bases VABP

Technical data

Switch-off variants

Circuit 2: De-energising – exhausting

When the valves are switched off, the drive will be exhausted.

Note:

- Not suitable for a vertical mounting position without additional safety functions
- If the exhaust air flow control valves are closed, the drive will not be exhausted
- Exhausting is also possible via the silencer

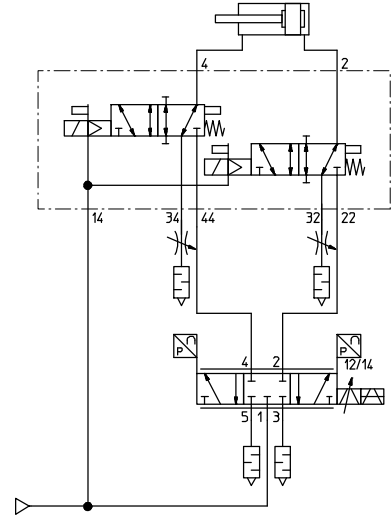
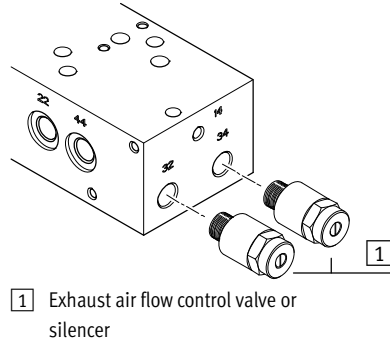

Circuit 3: Reversing (advancing) and reducing speed

When the solenoid valves are switched off, the movement of a retracting drive is reversed with simultaneous reduction of speed. The drive travels into the end position.

Note:

- The holding function is time-limited
- To generate the reversing movement even in the event of compressed air failure, an air reservoir with non-return function can be inserted at port [32] for compressed air supply.

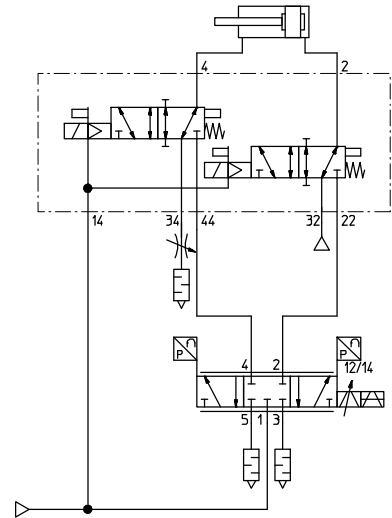
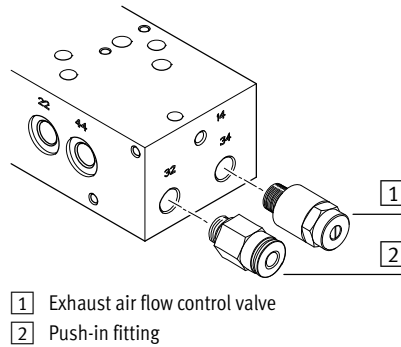

Sub-bases VABP

Technical data

Switch-off variants

Circuit 4: Reversing (retracting) and reducing speed

When the solenoid valves are switched off, the movement of an extending drive is reversed with simultaneous reduction of speed. The drive travels into the end position.

Note:

- The holding function is time-limited
- To generate the reversing movement even in the event of compressed air failure, an air reservoir with non-return function can be inserted at port [34] for compressed air supply.

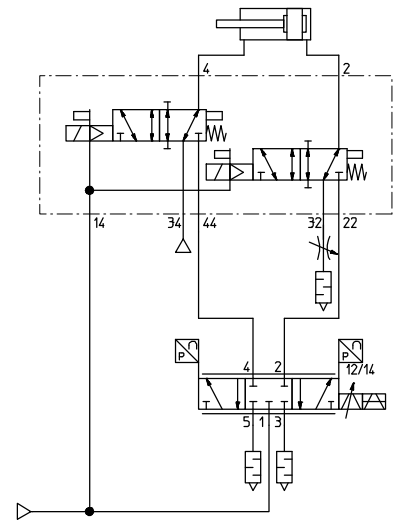
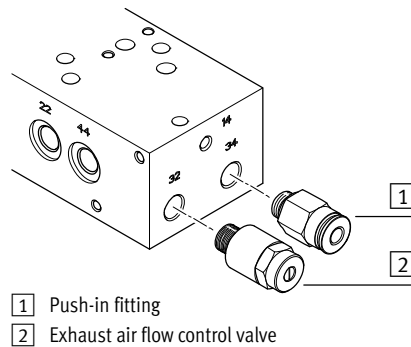

Circuit 5: Switching off power – short-circuit

When the valves are switched off, the two chambers are interconnected. The drive comes to a stop.

Note:

- Following actuation of the switch-off function, the drive will be under pressure
- Not suitable for a vertical mounting position without additional safety functions
- To restrict the run-out movement, it is recommended that a thin tube (4 or 6 mm) or a flow control valve (e.g. GRO...) is used for connecting the ports [32] and [34].

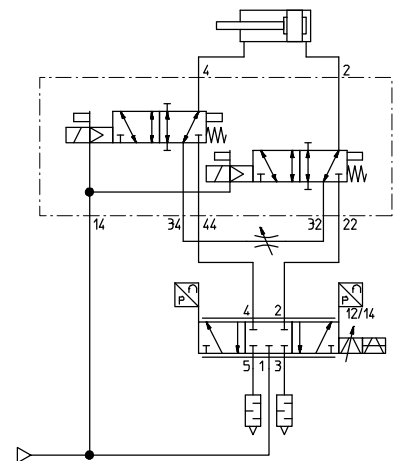
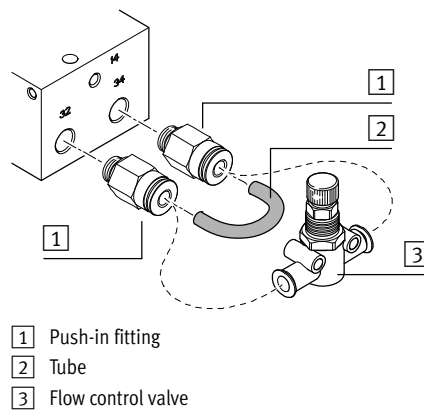

Sub-bases VABP

Technical data



Dimensions

Download CAD data → www.festo.com

VABP-S3-26V1G

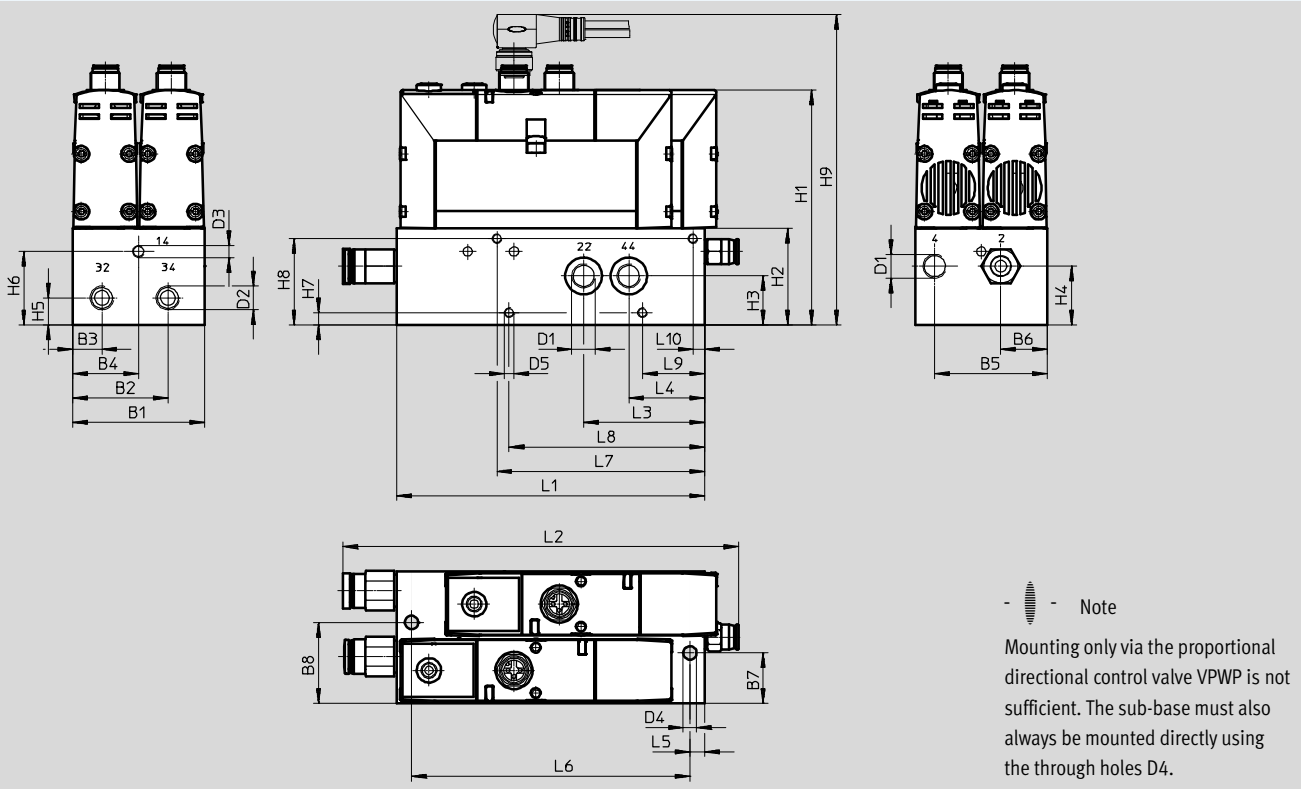

- - Note
Mounting only via the proportional directional control valve VPWP is not sufficient. The sub-base must also always be mounted directly using the through holes D4.

	B1	B2	B3	B4	B5	B6	B7	B8
Without valves	54	39	12	27	46	19	20.5	33
With valves								

	D1	D2	D3	D4	D5	H1	H2	H3
Without valves	G $\frac{1}{8}$	G $\frac{1}{8}$	M5	5.5	M4	-	39.5	20
With valves						96		

	H4	H5	H6	H7	H8	H9	L1	L2
Without valves	24	11	30	±0.1	±0.1	-	126	-
With valves				124.5	162			

	L3	L4	L5	L6	L7	L8	L9	L10
Without valves	49.5	31	6	120	±0.1	±0.1	±0.1	±0.1
With valves					85	80	25.4	4.75

Sub-bases VABP

Technical data

Dimensions

VABP-S1-1V1G

Download CAD data → www.festo.com

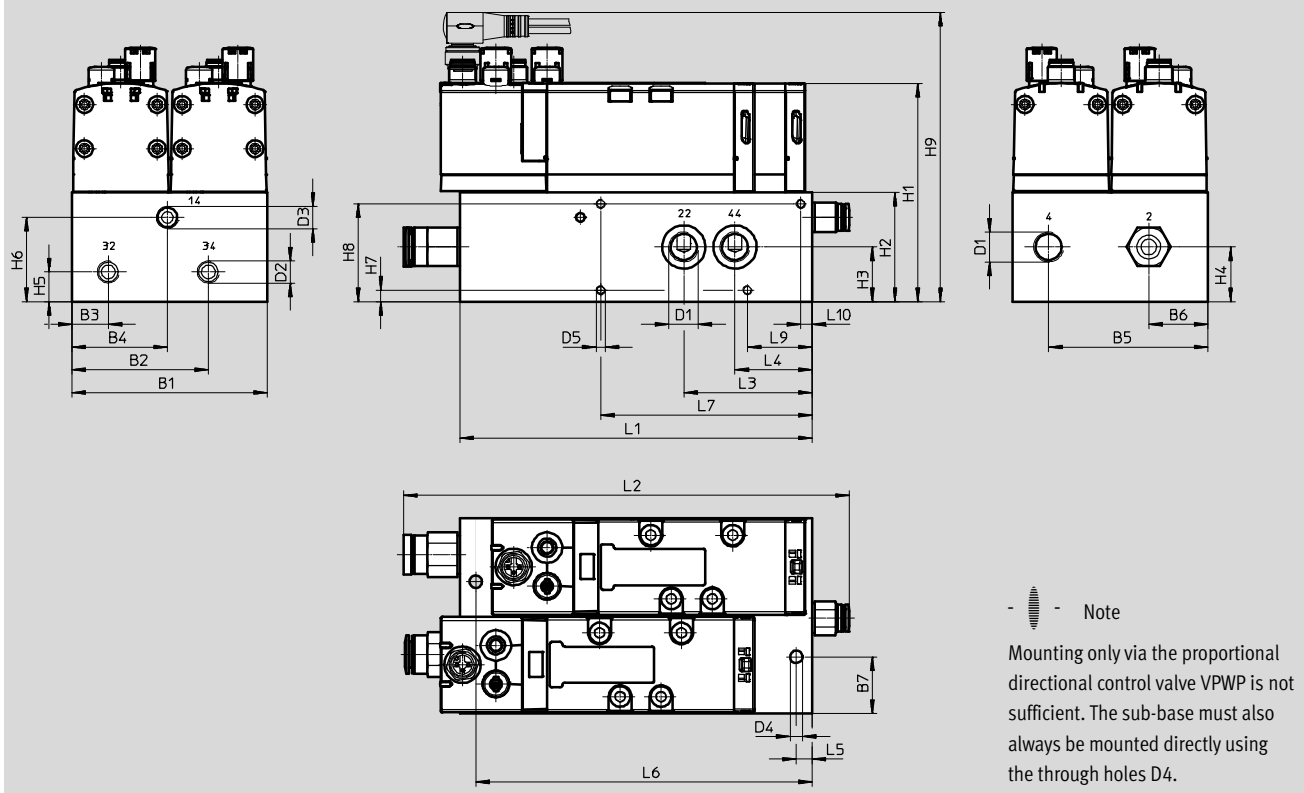

	B1	B2	B3	B4	B5	B6	B7	B8
Without valves	86	60	16	42	70	26	25	58
With valves								

	D1	D2	D3	D4	D5	H1	H2	H3
Without valves	G $\frac{1}{4}$	G $\frac{1}{8}$	G $\frac{1}{8}$	5.5	M4	–	48	24
With valves						96		

	H4	H5	H6	H7	H8	H9	L1	L2
Without valves	24	13	37	±0.1	±0.1	–	155	–
With valves				5	43	132		196

	L3	L4	L5	L6	L7	L9	L10
Without valves	56.5	34	7	148	±0.1	±0.1	±0.1
With valves					93	28.5	5

Sub-bases VABP

Technical data



Dimensions

VABP-S1-2V1G

Download CAD data → www.festo.com

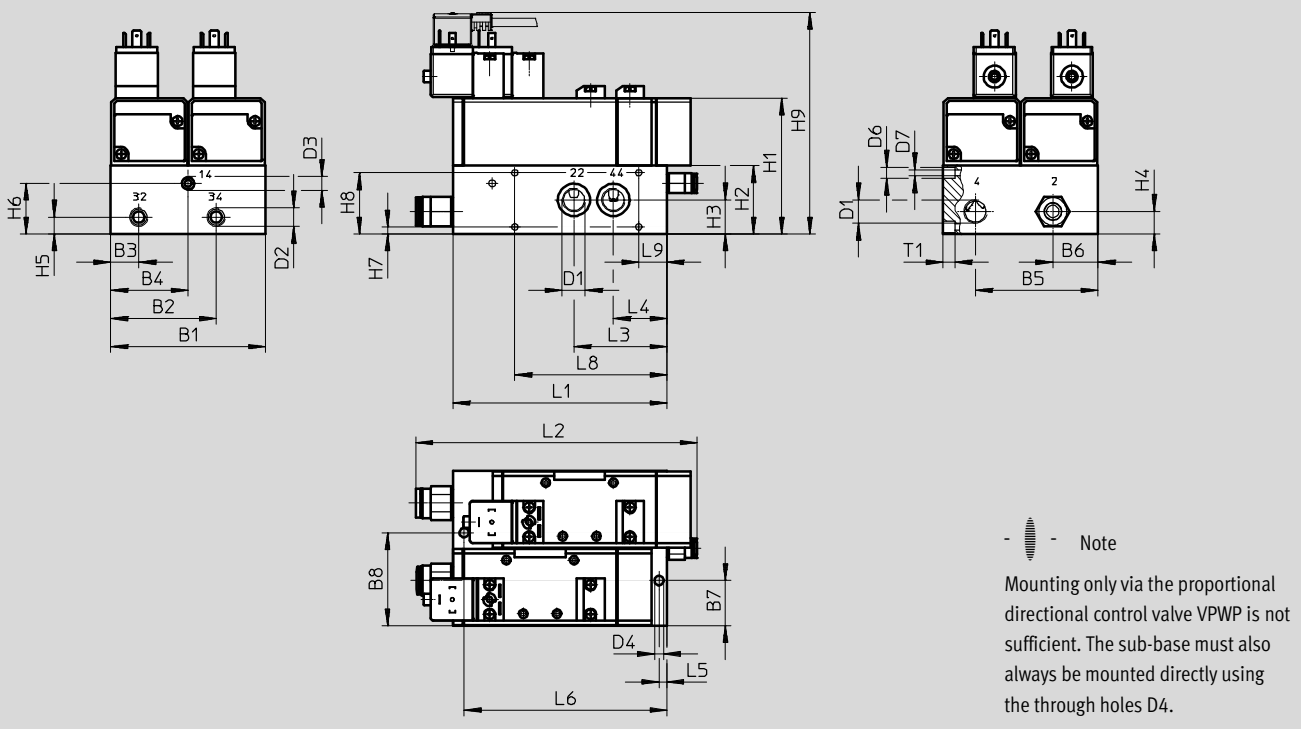

	B1	B2	B3	B4	B5	B6	B7	B8
Without valves	110	75	20	55	87	32	32	66
With valves								

	D1	D2	D3	D4	D6	D7	H1	H2
				∅	∅	∅		
					H13	H13		
Without valves	G3/8	G1/4	G1/8	6.6	4.5	8	-	48.5
With valves							96.5	

	H3	H4	H5	H6	H7	H8	H9	L1
					±0.1	±0.1		
Without valves	24.3	16	12	36	5	43.5	-	152
With valves							157	

	L2	L3	L4	L5	L6	L8	L9	T1
						±0.1	±0.1	
Without valves	-	66	38	5.5	144	108	20	8.4
With valves	200							

Sub-bases VABP

Technical data

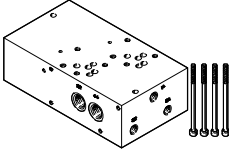
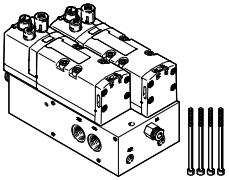
Ordering data			
	Nominal flow rate	Part No.	Type
Without valves			
	800	2605074	VABP-S3-26V1G-G18-2
	1400	2614860	VABP-S1-1V1G-G14-2
	2000	2738671	VABP-S1-2V1G-G38-2
With valves			
	800	2605075	VABP-S3-26V1G-G18-2M-R3
	1400	2614863	VABP-S1-1V1G-G14-2M-R3
	2000	2738672	VABP-S1-2V1G-G38-2M-A1





-  - Note

The solenoid valve VSVA with switching position sensing must be ordered separately → 14

Sub-bases VABP

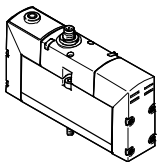
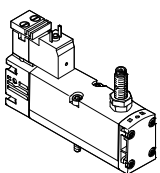
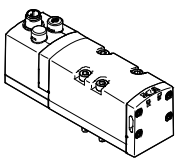
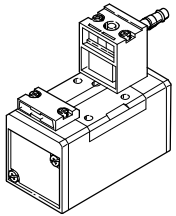
Accessories

FESTO

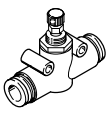



Ordering data				
	Description	Part No.	Type	PU ¹⁾
Solenoid valve				
	For sub-base: • VABP-S3-26V1G-G18-2	534546	VSVA-B-M52-MZH-A1-1R5L	1
	For sub-base: • VABP-S3-26V1G-G18-2 • With switching position sensing via inductive proximity sensor	560726	VSVA-B-M52-MZ-A1-1C1-APP	1
	For sub-base: • VABP-S1-1V1G-G14-2	561373	VSVA-B-M52-MZD-D1-1R5L	1
	For sub-base: • VABP-S1-2V1G-G38-2	159718	MN1H-5/2-D-2-FR-S-C	1
Solenoid coil				
	For solenoid valve: • MN1H-5/2-D-2-FR-S-C	123060	MSN1G-24DC-OD	1
Blanking plug				
	For realising a switch-off function	3568	B-1/8	10
		3569	B-1/4	
Silencer				
	For realising a switch-off function	161419	UC-1/8	1
		165004	UC-1/4	
Exhaust air flow control valve				
	For realising a switch-off function	10351	GRE-1/8	1
		10352	GRE-1/4	
Flow control valve				
	For realising a switch-off function	193973	GRO-QS-6	1

1) Packaging unit

Sub-bases VABP

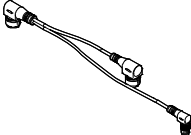
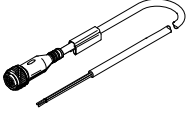
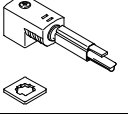
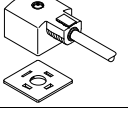
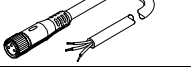
Accessories

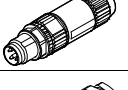
FESTO

Ordering data				
	Description	Part No.	Type	PU ¹⁾
Push-in fitting (only use push-in fitting with sealing ring)				
	For pilot air port 14			
	VABP-S3-26V1G	130896	QSM-B-M5-6-20	20
	VABP-S1-1V1G	186096	QS-G $\frac{1}{8}$ -6	10
	VABP-S1-2V1G	186098	QS-G $\frac{1}{8}$ -8	10
	For function ports 32, 34			
	VABP-S3-26V1G	186096	QS-G $\frac{1}{8}$ -6	10
	VABP-S1-1V1G	186098	QS-G $\frac{1}{8}$ -8	10
	VABP-S1-2V1G	186099	QS-G $\frac{1}{4}$ -8	10
	For working ports 2, 4, 22, 44			
	VABP-S3-26V1G	186098	QS-G $\frac{1}{8}$ -8	10
VABP-S1-1V1G	186101	QS-G $\frac{1}{4}$ -10	10	
VABP-S1-2V1G	186103	QS-G $\frac{3}{8}$ -12	10	
Connecting cable and plug socket with cable				
	Connection of solenoid valve to proportional directional control valve VPWP.	2384165	NEDV-L2R1-V7-M12W3-K-0.1L1-N-M8W4-0.2R1	1
	For the solenoid valves: • VSVA-B-M52-MZH-A1-1R5L • VSVA-B-M52-MZD-D1-1R5L			
	Connection of solenoid valve to controller.	541363	NEBU-M12G5-K-2.5-LE3	1
	For the solenoid valves: • VSVA-B-M52-MZH-A1-1R5L • VSVA-B-M52-MZD-D1-1R5L	541364	NEBU-M12G5-K-5-LE3	
	Connection of solenoid valve to controller.	151688	KMEB-1-24-2,5-LED	1
	For solenoid valve with switching position sensing • VSVA-B-M52-MZ-A1-1C1-APP	151689	KMEB-1-24-5-LED	
	Connection of solenoid valve to controller.	30931	KMC-1-24DC-2,5-LED	1
	For solenoid valve: • MN1H-5/2-D-2-FR-S-C	30933	KMC-1-24DC-5-LED	
	Connection of switching position sensing system to controller	541334	NEBU-M8G3-K-5-LE3	1
Plug and plug socket				
	Alternative plug socket for solenoid valve.	151687	MSSD-EB	1
	For solenoid valve with switching position sensing • VSVA-B-M52-MZ-A1-1C1-APP			
	Alternative plug socket for solenoid valve.	34583	MSSD-C	1
	For solenoid valve: • MN1H-5/2-D-2-FR-S-C			
	• Insulation displacement connector • Connection of the connecting cable KMC to the proportional directional control valve VPWP	562025	NECU-S-M8G4-HX	1
	• Screw terminal • Connection of the connecting cable KMC to the proportional directional control valve VPWP	1068198	NECU-S-M8G4-C2	

1) Packaging unit