

Valve manifold CPV10-EX-VI, Compact Performance

FESTO



Valve manifold CPV10-EX-VI, Compact Performance

FESTO

Key features

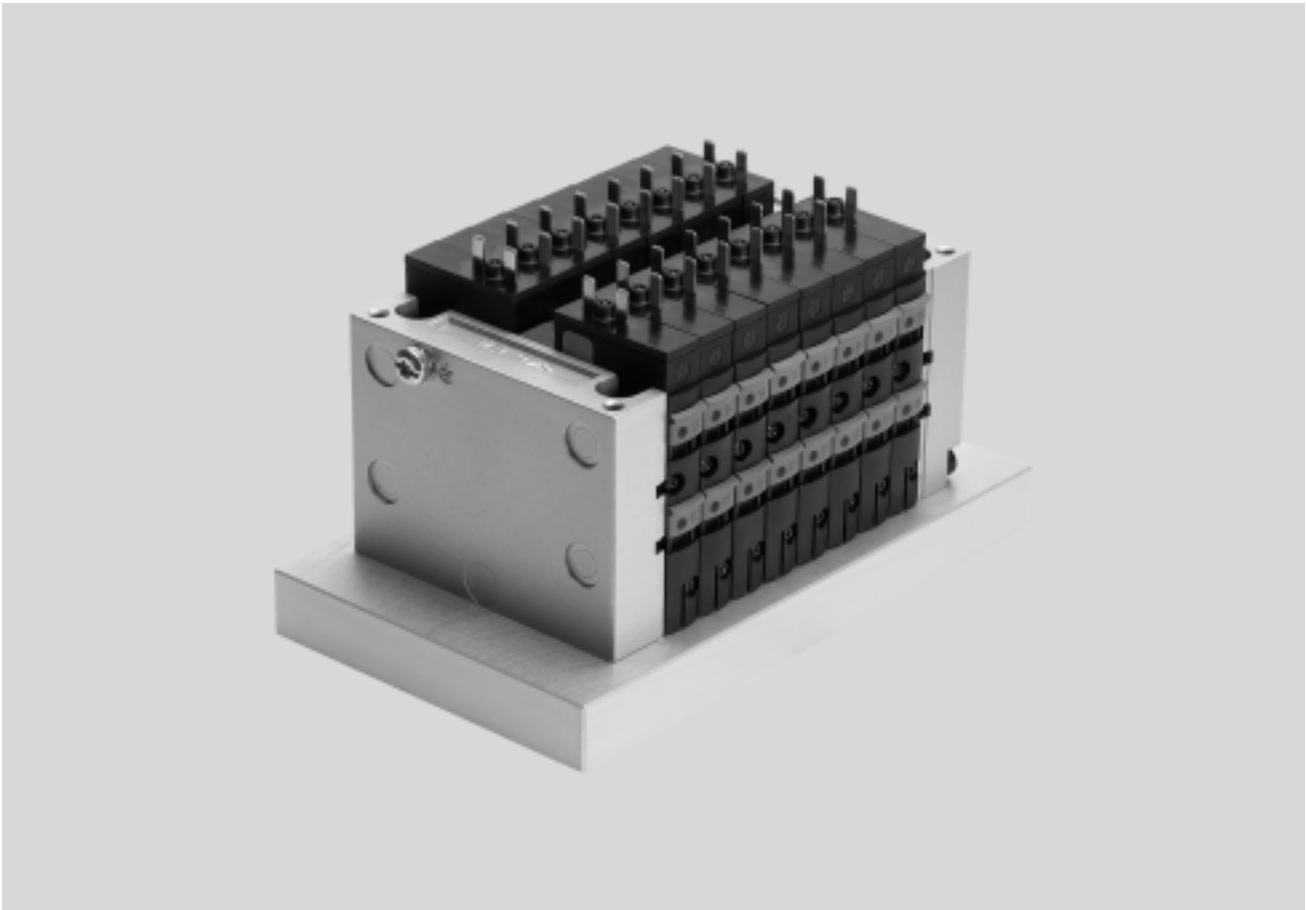

Innovative

- Cubic design for exceptional performance and low weight
- Sturdy
- Optimised for installation in a control cabinet
- Suitable for pilot control of process valves
- High flow rate with extremely compact design

Versatile

- Up to sixteen 2/2 or 3/2-way valves per valve manifold thanks to two-valve function in each slice
- Flexible and cost-effective connection of 2 to 8 valve slices
- Highly flexible thanks to:
 - various pneumatic functions (valve variants)
 - different pressure ranges
- Separator plates for creating pressure zones
- Blanking plates for future expansion

Reliable

- Manual overrides for valves
- Protection class to IP65 in the control cabinet
- Intrinsically safe valve manifold design to ATEX Category 2 (Zone 1)
- Extremely robust thanks to the metal valve design
- Long service life

Easy to mount

- Ready-to-install and tested unit
- Lower selection, ordering, installation and commissioning costs
- Secure mounting on wall or H-rail
- Pneumatic multiple connector plate – fast replacement of the valve block without the need to replace the existing tubing connections
- Valve assembly optimised for control cabinets

Valve manifold CPV10-EX-VI, Compact Performance

Key features

Main features

Simple electrical connections:
– Individual connection

Quick mounting:
– Directly using screws
– On an H-rail
– Via the pneumatic multiple connector plate

Robust metal thread or pre-assembled QS connectors

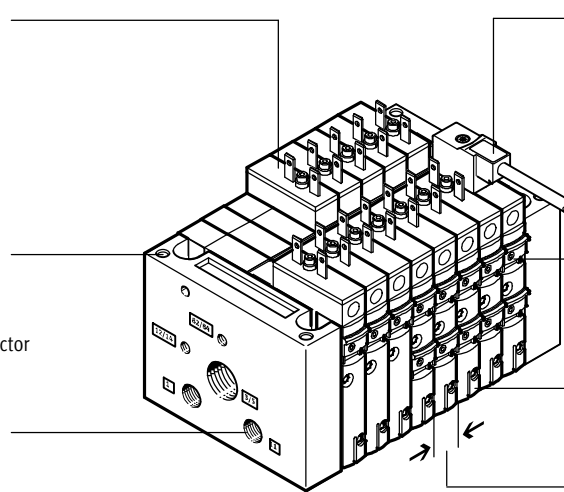

Inscription labels

Reliable operation:
Manual override, non-detenting, detenting or blocked

Comprehensive range of valve functions,
pressure zone creation, blanking plates

Width
– 10 mm

Equipment options

Valve functions

- | | | | |
|---|--|---|--|
| <ul style="list-style-type: none"> • 5/2-way valve, single solenoid • 5/2-way valve, double solenoid • 2x 3/2-way valve, normally open | <ul style="list-style-type: none"> • 2x 3/2-way valve, normally closed • 2x 3/2-way valve, 1x normally open, 1x closed | <ul style="list-style-type: none"> • 2x 3/2-way valve, normally closed, with integrated back pressure protection • 5/3-way valve¹⁾ | <ul style="list-style-type: none"> • 2x 2/2-way valve, normally closed • 2x 2/2-way valve, 1x normally open, 1x closed |
|---|--|---|--|

Special features

Individual connection

- 2 ... 8 valve positions, max. 16 solenoid coils

Intrinsically safe

The valve manifold CPV10-EX-VI features an intrinsically safe design for use in potentially explosive areas to ATEX Category 2 (Zone 1)

Pneumatic multiple connector plate

Pneumatic multiple connector plate for wall opening facilitates installation in control cabinets, seal to IP65

Operation

Actuation only via intrinsically safe circuit with individual valve connection

1) Via function block, not in conjunction with pneumatic multiple connector plate

Valve manifold CPV10-EX-VI, Compact Performance

Key features

Electrical connections

Individual connection in explosion-proof design

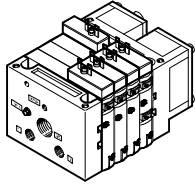

The CPV10-EX-VI is a valve manifold featuring an intrinsically safe design for use in Zone 1 potentially explosive areas (ATEX Category 2 G).
Definition of intrinsically safe:
Intrinsically safe means that the electrical outputs and solenoid coils are

designed so that no sparks or thermal effects will trigger ignition in explosive atmospheres. Each valve coil must be connected to an intrinsically safe circuit that complies with ignition protection type ia IIC or ib IIC.

Individual connection permits the selection of 2 to 16 solenoid coils (divided between two to eight valve slices, odd numbers also possible).

Range of applications

Many applications involve explosive gases or dust. Applications such as these call for equipment with increased explosion protection requirements (Category 2 corresponding to Zone 1). The possibility of sparking, for example when a solenoid coil is switched off, must be completely ruled out. There are different ways of doing this. Solenoid coils for this type of application are usually “intrinsically safe”. Intrinsically safe here means that no sparks or thermal effects can occur that would trigger ignition in an explosive atmosphere.

The valve terminal family CPV10 is already approved for explosion protection areas to ATEX. This approval is valid for Category 3. It corresponds to Zone 2 in which an explosive atmosphere either normally does not occur or occurs only briefly. The valve manifold CPV10-EX-VI extends this range for higher ATEX requirements:

- Approval for Category 2, Zone 1.

The intrinsically safe valve manifold features an integrated protective circuit that prevents ignition for gas, mist or vapour. Circuits for intrinsically safe solenoid coils are also designed so that only low voltage and power levels can occur. Hence, in this case the valve manifold is equipped with individually connected valves. The CPV10-EX-VI can only be operated in suitable intrinsically safe circuits.

In process engineering, valves for pilot control of process valves are frequently installed in a control cabinet. The pneumatic multiple connector plate type CPV10-VI-...-M7-C or -D for control cabinets simplifies the installation of the pneumatic connections. Instead of multiple bulkhead fittings and tubing connections, installation can be carried out with just a single through-hole in the cabinet wall. Protection class IP65 is achieved via a sealing ring suitable for closed control cabinet assembly. The pneumatic multiple connector plate facilitates operation of the valve manifold CPV10-EX-VI in a suitable control cabinet in Zones 1 and 21 (ATEX Category 2 GD).

Valve manifold CPV10-EX-VI, Compact Performance

Selection and development

Valve manifold configurator

Online via: → www.festo.com

The appropriate valve manifold can be chosen quickly and easily using the online catalogue. This includes an easy-to-use valve manifold configurator, which makes it much easier to find the right product.

The valve manifolds are fully assembled according to your order specification and are individually tested. This reduces assembly and installation time to a minimum.

You order a valve manifold CPV10-EX-VI using the order code.

Ordering system for CPV10-EX-VI
→ Internet: cpv10-ex

2D/3D CAD data

Online via: → www.festo.com

You can request the CAD data for a valve manifold you have configured. To do so, perform the product search as described above. Go to the shopping basket and click on the CAD

icon (compass). On the next page you can generate a 3D preview or request another data format of your choice by e-mail.



Valve manifold CPV10-EX-VI, Compact Performance

FESTO

Key features

Certification	
	In accordance with EU Directive 94/9/EC (ATEX Directive) Use in hazardous locations II 2G Ex ib IIC T4 Gb II 2D Ex ib IIC T100°C Db -5°C ≤ Ta ≤ 50°C

CPV use in Zone 1/2

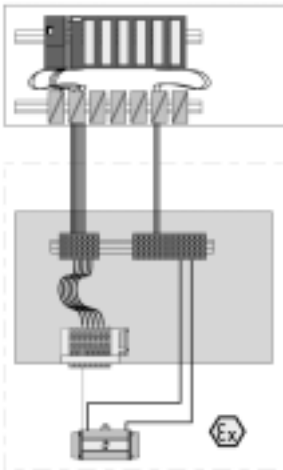

Intrinsically safe valve manifold in a control cabinet. Actuation via multi-core connecting cable.

CPV use in Zone 1/2

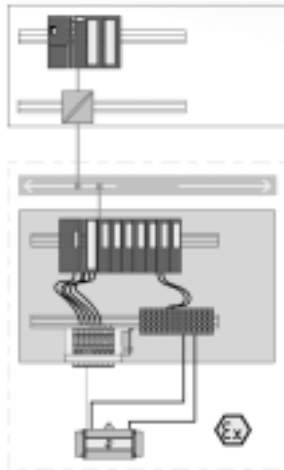

Intrinsically safe valve manifold (pneumatic multiple connector plate) and remote I/O in a control cabinet.

Valve manifold CPV10-EX-VI, Compact Performance

Key features

What does ATEX mean?

Explosive atmospheres are a constant hazard in the chemical and petro-chemical industries because of the processing techniques used. These

explosive atmospheres are caused by escaping gas, vapours and mist, for example. Explosive atmospheres can also be expected in mills, silos and

sugar and feed processing plants because of the dust/oxygen mixtures that occur there. For this reason, electrical equipment in hazardous areas is

subject to a special directive, ATEX 95a. This directive was also extended to non-electrical equipment on 1 July 2003.

What does ATEX 95a stand for and what does it mean?

- ATEX is an acronym of the French expression "Atmosphère explosible".
- ATEX 95a refers to article 95a of the corresponding EU directive.

- ATEX 95a is a working title for a project related to the **Directive 94/9/EC:**

- **Directive 94/9/EC** stipulates the minimum safety requirements for equipment and protective systems to be operated in explosive atmospheres.

- It applies to all EU member states.
- It relates to both electrical and non-electrical equipment.

What are the main amendments introduced by Directive 94/9/EC?

- Non-electrical equipment such as cylinders, pneumatic valves, service units and accessories now fall within the scope of the directive.
- Equipment will be approved for specific categories. These categories are allocated zones in which the equipment can be operated.

- Each piece of equipment must be supplied with operating instructions and a conformity declaration.
- The manufacturer's quality system must meet specifications over and above those required under ISO 9001.

- The new equipment bears the explosion protection and CE marks.
- Dust explosion protection now also falls within the scope of this directive.
- It specifies general safety requirements.

- It applies to mining as well as all other hazardous areas.
- It applies to complete protective systems.

Explosion protection classes

Gas zone	Dust zone	Frequency	Equipment group	Equipment category	Area of application
			I	M M1 M2	Mining
			II		All non-mining areas of application
0		Constant, frequent, long-term	II	1G	Gas, mist, vapour
	20		II	1D	Dust
1		Occasional	II	2G	Gas, mist, vapour
	21		II	2D	Dust
2		Seldom, short-term in the event of a fault	II	3G	Gas, mist, vapour
	22		II	3D	Dust

Valve manifold CPV10-EX-VI, Compact Performance

Key features

CPV – The benefits at a glance

The CPV has a unique design. It permits the flexible combination of pneumatic performance, electrical connection technologies and a wide range of mounting options. The pneumatic multiple connector plate supports space-saving installation in control cabinets. In many cases the valve manifold can be installed in the previously unused wall area of the control cabinet. There is no need to connect the valves in the control

cabinet. All tube couplings can be laid externally. Instead of individual holes, the pneumatic multiple connector plate requires only one rectangular cutout. The generously sized flow ducts and powerful flat plate silencers ensure high flow rates. All valves are in the form of valve slices. They are optimised for flow performance and are also extremely compact. Two functions per valve slice (e.g. 2x 3/2-way valves) mean that

twice the component density can be achieved. This saves space and reduces costs. The cubic design permits exceptional performance yet a comparatively low weight. The benefits of this design are obvious when the valve manifold is used on a drive in a moving installation. However, robustness must not be sacrificed in favour of compactness.

The connecting threads and mounting attachments are metal. The manual override for the valves can be adapted for different operating situations. If, for example, a detenting manual override is required for setting-up mode, the manual override can be easily converted for that application in a way that rules out operational errors.

The design principle

The cubic design provides a clearly assigned function on each side. Thus, for example, the electrical connection is mounted on the top.

The different combination options ensure the optimum solution for the task at hand.

- Compressed air supply connections on the left, right or underneath
- Pneumatic working lines and function blocks (vertical stacking) underneath
- Manual operation from the front
- Electrical connection surface on the top
- Mounting surface at the back or the front via a pneumatic multiple connector plate

Valve manifold CPV10-EX-VI, Compact Performance

Peripherals overview

Overview – CPV valve manifold

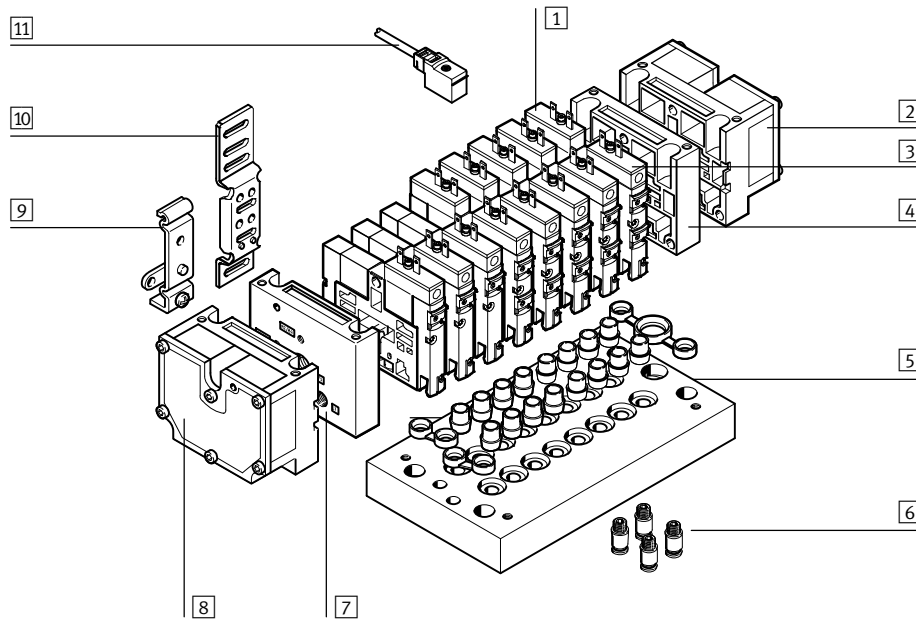

- | | | | |
|---|--|---|---------------------------|
| 1 Basic electrical unit (individual connection) | 4 Right-hand end plate (threaded connections not in conjunction with pneumatic multiple connector plate) | 6 Push-in connectors | 9 H-rail mounting |
| 2 Right-hand end plate with flat plate silencer | 5 Pneumatic multiple connector plate | 7 Left-hand end plate (threaded connections not in conjunction with pneumatic multiple connector plate) | 10 Wall mounting |
| 3 Valve slice | | 8 Left-hand end plate with flat plate silencer | 11 Plug socket with cable |

Valve manifold CPV10-EX-VI, Compact Performance

Key features – Pneumatic components

Valves

CPV valves are valves with integrated sub-base, i.e. in addition to the valve function they contain all of the pneumatic ducts for supply, exhaust and the working lines. The supply ducts

are a central component of the valve slices and allow a direct flow of air through the valve slices.

This helps achieve maximum flow rates. All valves have a pneumatic

pilot control for optimising performance. The valve function is based on a piston spool system with a patented sealing principle that guarantees its suitability for a wide range of

applications as well as a long service life.

The valve manifold is not suitable for vacuum operation.

Valve function		
Code	Circuit symbol	Description
M		<p>5/2-way valve, single solenoid</p> <ul style="list-style-type: none"> • Pneumatic spring return • Piston spool valve
J		<p>5/2-way valve, double solenoid</p> <ul style="list-style-type: none"> • Piston spool valve • The pneumatic switching position is retained in the de-energised state
C		<p>2x 3/2-way valve, single solenoid</p> <ul style="list-style-type: none"> • Normally closed • Pneumatic spring return • Piston spool valve
CY		<p>2x 3/2-way valve, single solenoid</p> <ul style="list-style-type: none"> • Normally closed • Pneumatic spring return • Piston spool valve • Integrated back pressure protection <p>-  - Note</p> <p>The valve manifold must be operated with external pilot air supply if it is necessary to ensure that the back pressure flaps are closed securely in the event of a sudden drop in operating pressure or if the operating pressure is switched off.</p>
N		<p>2x 3/2-way valve, single solenoid</p> <ul style="list-style-type: none"> • Normally open • Pneumatic spring return • Piston spool valve • The function of a 5/3-way valve with mid-position pressurised can be implemented with these valves with initial position open.
H		<p>2x 3/2-way valve, single solenoid</p> <ul style="list-style-type: none"> • Normal position 1x open (pilot control 12) 1x closed (pilot control 14) • Pneumatic spring return • Piston spool valve <p>For optimised cylinder movement. Corresponds to valve function M with simultaneous actuation of both solenoid coils (5/2-way, single solenoid). Since the piston area on each side can be pressurised or exhausted separately, it means that the cylinder can move faster.</p>

Valve manifold CPV10-EX-VI, Compact Performance

Key features – Pneumatic components

Valve function		
Code	Circuit symbol	Description
-		<p>5/3G¹⁾ function, mid-position closed</p> <p>The valve function “mid-position closed” is created from one 2x 3/2-way valve, normally closed (code C).</p> <p>The valve kit CPV10-BS-5/3G-M7 (incorporating a double piloted non-return function) is used for this. This valve kit is intended for applications with one working pressure level per valve slice, i.e. it must not be used in dual-pressure applications (where the pressure levels at port 1 and 11 are different).</p> <p>If other valve slices are to be used in dual-pressure mode, then the valve slice equipped with the 5/3G valve kit must be separated from compressed air duct 1 and 11 by means of a separator plate (code T).</p> <p>Not in first or last valve position with pneumatic multiple connector plate P and M. Cannot be used with pneumatic multiple connector plate GQC and GQD.</p> <ul style="list-style-type: none"> • Piston spool valve
-		<p>5/3E function, mid-position exhausted</p> <p>The valve function “mid-position exhausted” is created using a 2x 3/2-way valve, normally closed (code C).</p> <ul style="list-style-type: none"> • Pneumatic spring return • Piston spool valve
-		<p>5/3B function, mid-position pressurised</p> <p>The valve function “mid-position pressurised” is created using a 2x 3/2-way valve, normally open (code N).</p> <ul style="list-style-type: none"> • Pneumatic spring return • Piston spool valve
D		<p>2x 2/2-way valve, single solenoid</p> <ul style="list-style-type: none"> • Normally closed • Pneumatic spring return • Piston spool valve
I		<p>2x 2/2-way valve, single solenoid</p> <ul style="list-style-type: none"> • Normal position <ul style="list-style-type: none"> – 1x open (control side 12) – 1x closed (control side 14) • Pneumatic spring return • Piston spool valve

1) Cannot be assembled in conjunction with the control cabinet version of the pneumatic multiple connector plate CPV10-VI-P...C or CPV10-VI-P...D

Valve manifold CPV10-EX-VI, Compact Performance

Key features – Pneumatic components

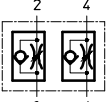
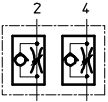
Additional pneumatic functions		
Code	Circuit symbol	Description
P	<p>Input (valve side)</p>  <p>Output (cylinder side)</p>	<p>2x one-way flow control valve, supply air flow control Module (actuator) for direct flange mounting on the CPV valves. Also suitable for pneumatic multiple connector plates. Different valve actuators cannot be combined.</p> <ul style="list-style-type: none"> • Not with valve function G • Not in first or last valve position with accessories M, P, V (pneumatic multiple connector plate) • Cannot be used with accessories GQC and GQD (pneumatic multiple connector plate)
Q	<p>Input (valve side)</p>  <p>Output (cylinder side)</p>	<p>2x one-way flow control valve, exhaust air flow control Module (actuator) for direct flange mounting on the CPV valves. Also suitable for pneumatic multiple connector plates. Different valve actuators cannot be combined.</p> <ul style="list-style-type: none"> • Not with valve function G • Not in first or last valve position with accessories M, P, V (pneumatic multiple connector plate) • Cannot be used with accessories GQC and GQD (pneumatic multiple connector plate)

-  - Note

Pneumatic multiple connector plate P, M: not in first or last valve position.

Pneumatic multiple connector plate GQC, GQD: not used.

Valve manifold CPV10-EX-VI, Compact Performance

Key features – Pneumatic components

Creating pressure zones

Different pressures at port 1 and 11 result in two pressure levels per valve. This means, for example, that a cylinder drive can be advanced using high pressure and retracted using low pressure to save energy.

The maximum number of pressure zones possible is determined by the combination of the following components:

- Use of a separator plate
- End plate pair type
- Valve slice type

The CPV valve manifold can be divided into 2 to 4 pressure zones with the aid of separator plates.

Separator plates		
Code	Graphical symbol	Note
T	<p>Separator plate (for creating pressure zones), supply duct 1 separated</p>	<p>A separator plate (code T) is used to separate the duct for the air supply (port 1 and 11) to provide two pressure zones.</p> <ul style="list-style-type: none"> • Not in first or last valve position • Not with compressed air supply A, B, C, D, U, V, W, X
S	<p>Separator plate (for creating pressure zones), supply duct 1 and exhaust 3/5 separated</p>	<p>The separator plate (code S) separates the exhaust duct 3/5 as well as the supply duct 1 and 11. This plate should be used to prevent back pressure on neighbouring valve functions.</p> <ul style="list-style-type: none"> • Not in first or last valve position • Not with compressed air supply A, B, C, D, U, V, W, X (single-side compressed air supply)
L	<p>Vacant position (blanking plate)</p>	<p>A blanking plate (code L) is used to create a vacant position where a valve can be positioned at a later date.</p>

Valve manifold CPV10-EX-VI, Compact Performance

Key features – Pneumatic components

Examples: Compressed air supply

External pilot air supply, flat plate silencer at both ends

Compressed air supply via pneumatic multiple connector plate:
code H

The diagram opposite shows an example of the configuration and connection of the compressed air supply with external pilot air supply. Port 12/14 on the pneumatic multiple connector plate is equipped with a fitting for this purpose. Ports 3/5 and 82/84 are vented via the flat plate silencers. One separating seal each can be optionally used to create pressure zones.

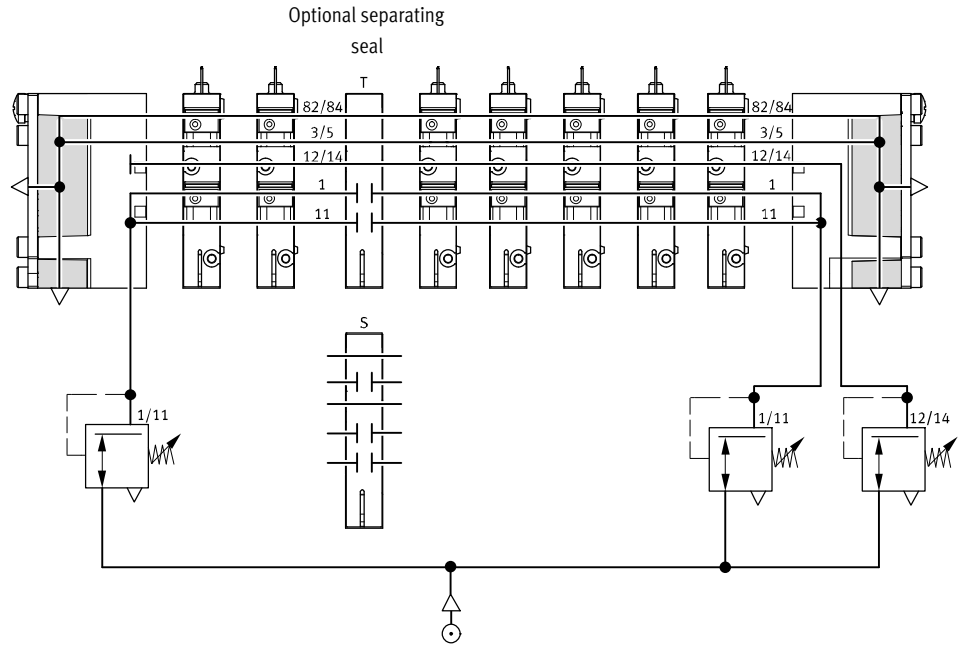

Internal pilot air supply, ducted exhaust air or threaded silencer

Compressed air supply via end plates:
code Z

The diagram opposite shows an example of the configuration and connection of the compressed air supply with internal pilot air supply. The pilot air supply is branched from port 1 or 11 via the right-hand end plate. Ports 3/5 and 82/84 are vented via the threaded silencer.

One separating seal each can be optionally used to create pressure zones.

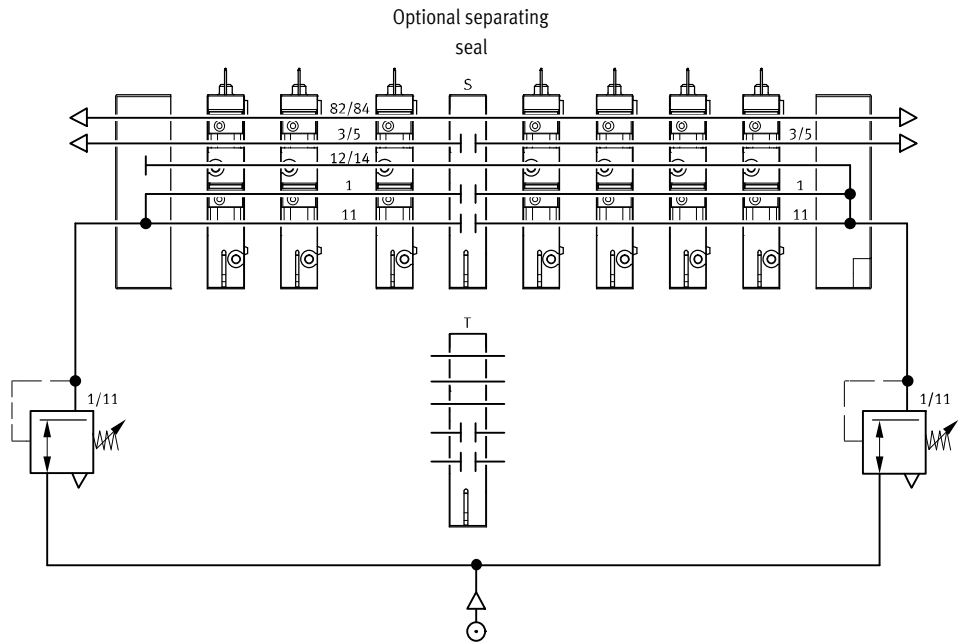

Valve manifold CPV10-EX-VI, Compact Performance

Key features – Pneumatic components

Example: Creating pressure zones

CPV with separator plate T

With the CPV valve manifold up to four pressure zones can be implemented. The diagram shows an example of the configuration and connection of four pressure zones using separator plate code T – with external pilot air supply.

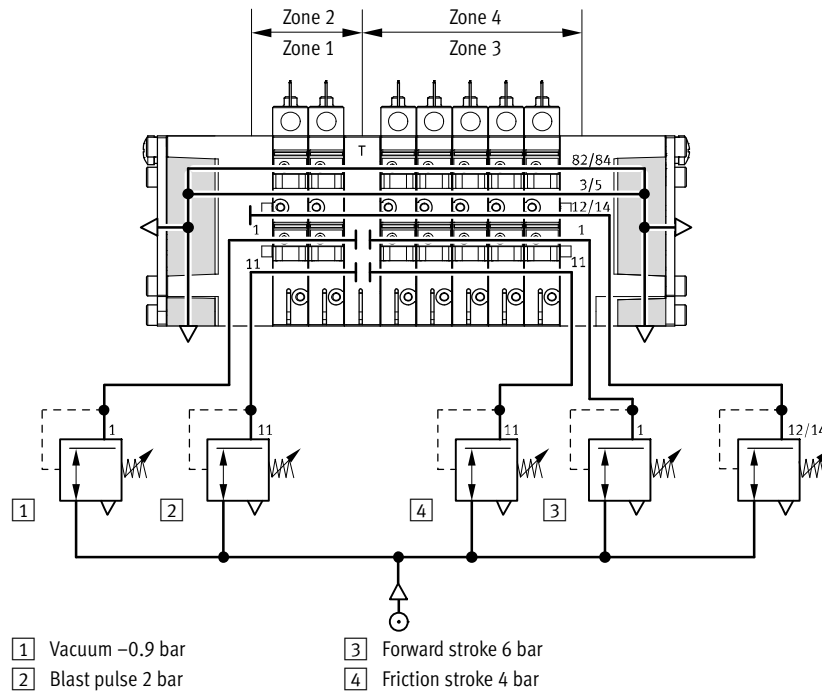

Valve manifold CPV10-EX-VI, Compact Performance

Key features – Pneumatic components

FESTO

Compressed air supply and exhausting

The two end plates that pressurise and exhaust the valve slices are a characteristic feature of a CPV valve manifold.

- Large duct cross sections ensure maximum flow rates even when multiple valves are switched in parallel

- Large flat plate silencers in the end plates
- Internal/external pilot air supply

Each individual valve is supplied with compressed air from two individual

ducts (supply ports 1/11) and exhausted via a large, integrated exhaust duct (exhaust 3/5). This design permits unique flexibility and functionality. It is the easiest way of

realising a number of pressure zones per terminal. The valve manifold is supplied via end plates, either on the left, on the right or on both sides.

Pilot air supply

Internal pilot air supply

Internal pilot air supply can be selected if the supply pressure at pneumatic port 1 is 3 ... 8 bar. With internal pilot air supply the branch is located in the left or right-hand end plate. There is no port 12/14.

External pilot air supply

External pilot air supply is required if the supply pressure at pneumatic port 1 is less than 3 bar or greater than 8 bar. In this case, pressure of

3 ... 8 bar is applied at port 12/14. If a gradual pressure build-up in the system using a pressurised on-off valve is required, external pilot supply

air should be selected. The control pressure applied during switch-on is already very high in this case.

End plates

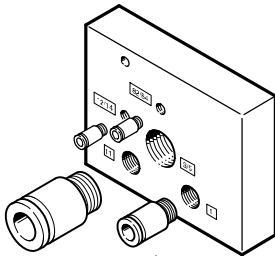

Example of an end plate: The diagram shows a left-hand end plate with external pilot air supply. The exhaust ports 3/5 and 82/84 can be equipped with fittings or with

silencers. An end plate for internal pilot air supply does not have ports 12/14 and 11. The port 82/84 is always present and

should be fitted with a silencer. The port 12/14 is connected internally with port 1 on an end plate for internal pilot air supply.

Valve manifold CPV10-EX-VI, Compact Performance

Key features – Pneumatic components

End plate combination for compressed air supply via end plate		
Code	Graphical symbol Type of pilot air supply (internal/external)	Note
U	<p>Internal pilot air supply</p>	<ul style="list-style-type: none"> • Ports in right-hand end plate only • No pressure zone separation permissible
V	<p>Internal pilot air supply</p>	<ul style="list-style-type: none"> • Ports in left-hand end plate only • No pressure zone separation permissible
W	<p>External pilot air supply</p>	<ul style="list-style-type: none"> • Ports in right-hand end plate only • No pressure zone separation permissible
X	<p>External pilot air supply</p>	<ul style="list-style-type: none"> • Ports in left-hand end plate only • No pressure zone separation permissible
Y	<p>Internal pilot air supply</p>	<ul style="list-style-type: none"> • Ports in left-hand and right-hand end plate • Maximum three pressure zones
Z	<p>External pilot air supply</p>	<ul style="list-style-type: none"> • Ports in left-hand and right-hand end plate • Maximum four pressure zones

Valve manifold CPV10-EX-VI, Compact Performance

Key features – Pneumatic components

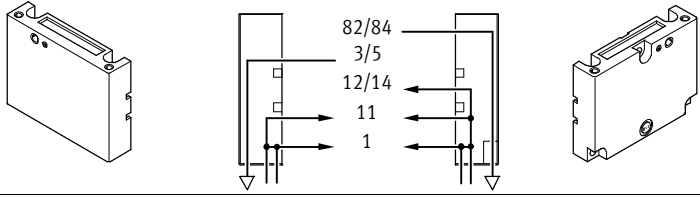
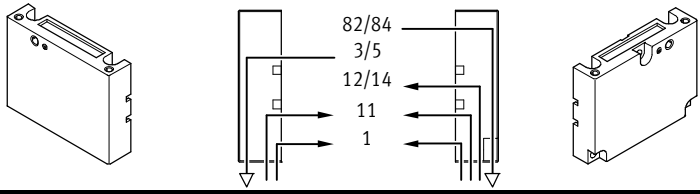
End plate combination for compressed air supply via pneumatic multiple connector plate		
Code	Graphical symbol Type of pilot air supply (internal/external)	Note
Y	Internal pilot air supply 	<ul style="list-style-type: none"> • Ports on pneumatic multiple connector plate • Pressure zone separation only permissible with separator plate (code T) • Maximum two pressure zones • Only for accessories M, P, V, GQC, GQD (pneumatic multiple connector plate)
Z	External pilot air supply 	<ul style="list-style-type: none"> • Ports on pneumatic multiple connector plate • Pressure zone separation only permissible with separator plate (code T) • Maximum three pressure zones • Only for accessories M, P, V, GQC, GQD (pneumatic multiple connector plate)

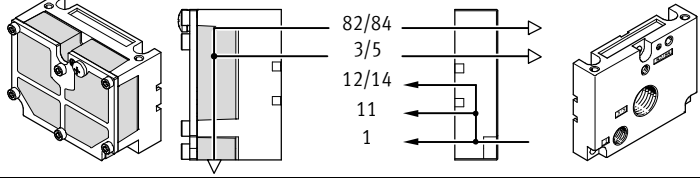
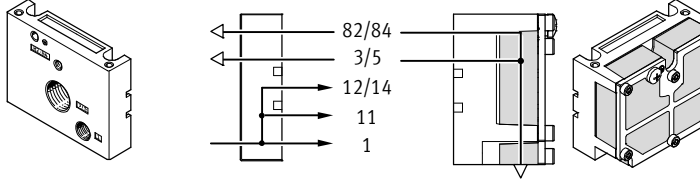
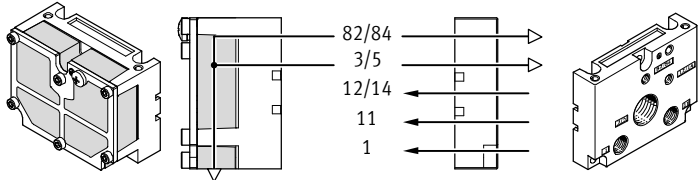
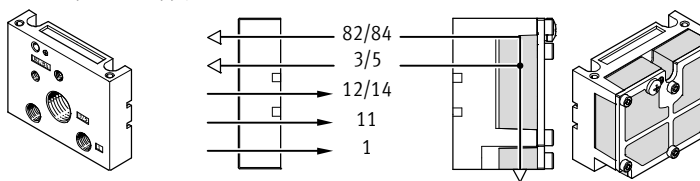
End plate combination for compressed air supply via end plates with flat plate silencer		
Code	Graphical symbol Type of pilot air supply (internal/external)	Note
A	Internal pilot air supply 	<ul style="list-style-type: none"> • Ports in right-hand end plate • No pressure zone separation permissible
B	Internal pilot air supply 	<ul style="list-style-type: none"> • Ports in left-hand end plate • No pressure zone separation permissible
C	External pilot air supply 	<ul style="list-style-type: none"> • Ports in right-hand end plate • No pressure zone separation permissible
D	External pilot air supply 	<ul style="list-style-type: none"> • Ports in left-hand end plate • No pressure zone separation permissible

Valve manifold CPV10-EX-VI, Compact Performance

Key features – Pneumatic components

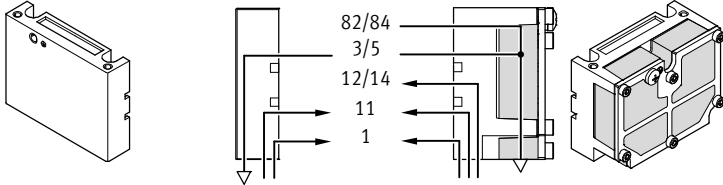
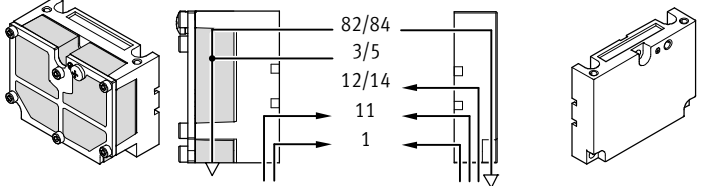
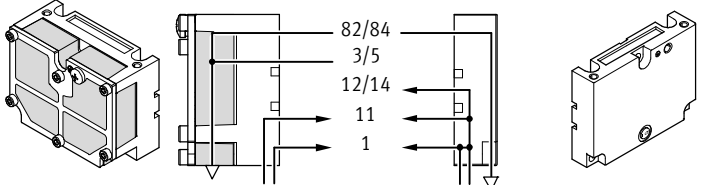
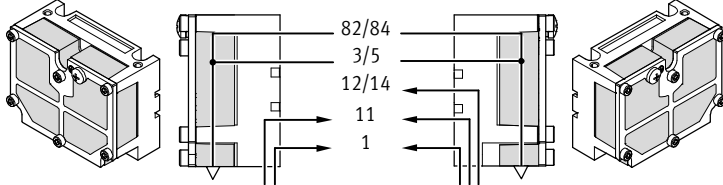
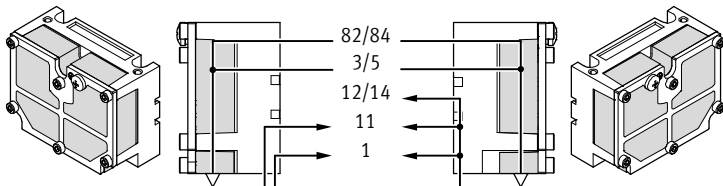
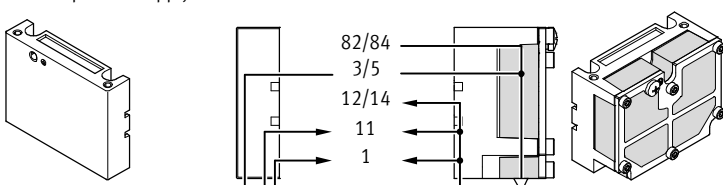
End plate combination for compressed air supply via pneumatic multiple connector plate with flat plate silencer		
Code	Graphical symbol Type of pilot air supply (internal/external)	Note
E	External pilot air supply 	<ul style="list-style-type: none"> Ports on pneumatic multiple connector plate Exhaust air vented via flat plate silencer on the right Pressure zone separation only permissible with separator plate (code T) Maximum four pressure zones Only for accessories M, P, V, GQC, GQD (pneumatic multiple connector plate)
F	External pilot air supply 	<ul style="list-style-type: none"> Ports on pneumatic multiple connector plate Exhaust air vented via flat plate silencer on the left Pressure zone separation only permissible with separator plate (code T) Maximum four pressure zones Only for accessories M, P, V, GQC, GQD (pneumatic multiple connector plate)
G	Internal pilot air supply 	<ul style="list-style-type: none"> Ports on pneumatic multiple connector plate Exhaust air vented via flat plate silencer on the left Pressure zone separation only permissible with separator plate (code T) Maximum three pressure zones Only for accessories M, P, V, GQC, GQD (pneumatic multiple connector plate)
H	External pilot air supply 	<ul style="list-style-type: none"> Ports on pneumatic multiple connector plate Exhaust air vented via flat plate silencers at both ends Pressure zone separation permissible Only for accessories M, P, V, GQC, GQD (pneumatic multiple connector plate)
J	Internal pilot air supply 	<ul style="list-style-type: none"> Ports on pneumatic multiple connector plate Exhaust air vented via flat plate silencers at both ends Pressure zone separation permissible Maximum three pressure zones Only for accessories M, P, V, GQC, GQD (pneumatic multiple connector plate)
K	Internal pilot air supply 	<ul style="list-style-type: none"> Ports on pneumatic multiple connector plate Exhaust air vented via flat plate silencer on the right Pressure zone separation permissible Maximum three pressure zones Only for accessories M, P, V, GQC, GQD (pneumatic multiple connector plate)

Valve manifold CPV10-EX-VI, Compact Performance

Key features – Pneumatic components



Pneumatic connection

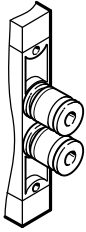

The working lines are located directly in the valve slices. Threaded connectors and Quick Star push-in fittings (QS) are available for different tubing sizes. The supply ports are located in the end plates or in the

pneumatic multiple connector plate. Push-in fittings are available fully assembled. The following working lines can be selected:

- Threaded connectors: code C
 - Large push-in connectors: code D
 - Small push-in connectors: code E
- Connection sizes for the threaded and QS push-in fittings can be found in the table below.

Pneumatic multiple connector plate

One-piece “connection plates” that contain both working lines and supply ports can be combined with a pneumatic multiple connector plate. This enables the valve manifold as a pneumatic “function” to be separated

from the valve ports. The pneumatic multiple connector plate enables different mounting options from wall mounting to direct passage through a cabinet wall.

Easy-to-service and flexible connection technology thanks to the following:

- Common connection via the pneumatic multiple connector plate with all connections on one side
- The valve manifold can be assembled/disassembled using only four screws, whereby the pneumatics remain fully connected
- Quick assembly/disassembly
- No errors when recommissioning as a result of incorrect connection of tubing

CPV valve manifold

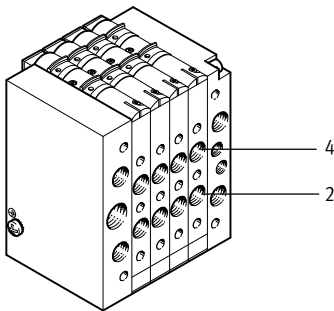

Pneumatic multiple connector plate

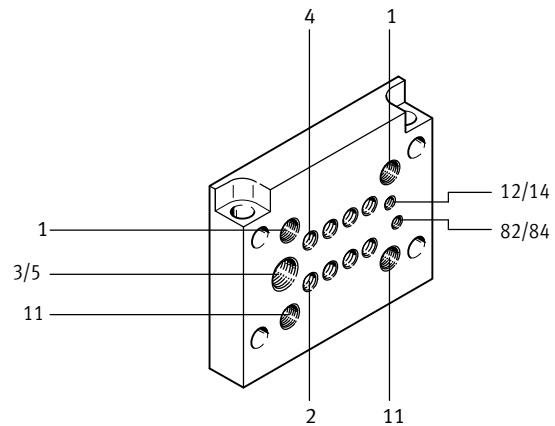

Connection sizes		
Connection to ISO 5599	CPV10	Comment
1/11 Working air	G1/8	Fitting in end plate or pneumatic multiple connector plate
2/4 Working line	M7 (QS6/QS4)	Connection in valve slice, connection for push-in fitting in brackets
3/5 Exhaust air via right-hand/left-hand end plate or pneumatic multiple connector plate	G3/8	
	G1/4	
12/14 Pilot air supply port	M5	
82/84 Exhaust air from left-hand/right-hand end plate or pneumatic multiple connector plate	M5	
	M7 (M5) ¹⁾	

1) With flanged pneumatic multiple connector plate

Valve manifold CPV10-EX-VI, Compact Performance

Key features – Pneumatic components

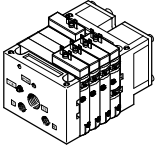
Pneumatic connection: fitting set for compressed air supply				
	Code for compressed air supply	Port	Designation	Type
	Without pneumatic multiple connector plate			
	U, V	82/84	Silencer	AMTE-M-LH-M5
		3/5	Silencer	U-3/8-B
		1	Push-in fitting	QS-1/8-8-I
	W, X	82/84	Silencer	AMTE-M-LH-M5
		3/5	Silencer	U-3/8-B
		1	Push-in fitting	QS-1/8-8-I
		12/14	Push-in fitting	QSM-M5-6-I
	Y	82/84 on right	Silencer	AMTE-M-LH-M5
		82/84 on left	Blanking plug	B-M5
		3/5 on right	Silencer	U-3/8-B
		3/5 on left	Blanking plug	B-3/8
		1/11 on left	Push-in fitting	QS-1/8-8-I
	Z	82/84 on right	Silencer	AMTE-M-LH-M5
		82/84 on left	Blanking plug	B-M5
		3/5 on right	Silencer	U-3/8-B
		3/5 on left	Blanking plug	B-3/8
		12/14 on right	Push-in fitting	QSM-M5-6-I
		12/14 on left	Blanking plug	B-M5
		1/11	Push-in fitting	QS-1/8-8-I
	With pneumatic multiple connector plate code: M			
	Y	82/84	Silencer	UC-M7
		12/14	Blanking plug	B-M7
		3/5	Silencer	U-1/4-B
		1/11 on left	Push-in fitting	QS-1/8-8-I
		11 on right	Blanking plug	B-1/8
	Z	82/84	Silencer	UC-M7
		3/5	Silencer	U-1/4-B
		12/14	Push-in fitting	QSM-M7-6-I
		1/11 on left	Push-in fitting	QS-1/8-8-I
	With pneumatic multiple connector plate code: P, GQC			
	Y	82/84	Silencer	AMTE-M-LH-M5
12/14		Blanking plug	B-M5	
3/5		Silencer	U-1/4-B	
1/11 on left		Push-in fitting	QS-1/8-8-I	
11 on right		Blanking plug	B-1/8	
Z	82/84	Silencer	AMTE-M-LH-M5	
	3/5	Silencer	U-1/4-B	
	12/14	Push-in fitting	QSM-M5-6-I	
	1/11 on left	Push-in fitting	QS-1/8-8-I	

Valve manifold CPV10-EX-VI, Compact Performance

FESTO

Key features – Pneumatic components

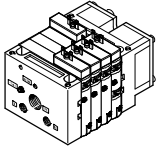
Pneumatic connection: fitting set for compressed air supply				
	Code for compressed air supply	Port	Designation	Type
	Without pneumatic multiple connector plate			
	A, B	82/84	Blanking plug	B-M5
		3/5	Blanking plug	B-3/8
		1	Push-in fitting	QS-1/8-8-l
	C, D	82/84	Blanking plug	B-M5
		3/5	Blanking plug	B-3/8
		1	Push-in fitting	QS-1/8-8-l
		12/14	Push-in fitting	QSM-M5-6-l
	With pneumatic multiple connector plate code: M			
	E, F, H	82/84	Blanking plug	B-M7
		3/5	Blanking plug	B-1/4
		1/11	Push-in fitting	QS-1/8-8-l
		12/14	Push-in fitting	QSM-M7-6-l
	G, J, K	82/84	Blanking plug	B-M7
		3/5	Blanking plug	B-1/4
		On right in 1, left	Push-in fitting	QS-1/8-8-l
		On right in 11	Blanking plug	B-1/8
		12/14	Blanking plug	B-M7
	With pneumatic multiple connector plate code: P, GQC			
	E, F, H	82/84	Blanking plug	B-M5
		3/5	Blanking plug	B-1/4
		1/11	Push-in fitting	QS-1/8-8-l
		12/14	Push-in fitting	QSM-M5-6-l
	G, J, K	82/84	Blanking plug	B-M5
3/5		Blanking plug	B-1/4	
On right in 1, left		Push-in fitting	QS-1/8-8-l	
On right in 11		Blanking plug	B-1/8	
12/14		Blanking plug	B-M5	

Valve manifold CPV10-EX-VI, Compact Performance

Key features – Pneumatic components

CPV valve manifold size 10 with valve extensions

Function blocks

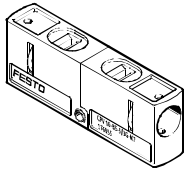

CPV10-BS-5/3G-M7

Valve kit 5/3G for creating a 5/3-way function, mid-position closed:
The valve function “mid-position closed” is created using one valve slice with 2x 3/2-way valve, normally closed (valve function code C).
The valve kit CPV10-BS-5/3G-M7 (incorporating a double piloted

non-return valve function) is used for this.
This valve kit is intended for applications with one working pressure level per valve slice, i.e. it must not be used in dual-pressure applications (where the pressure levels at port 1 and 11 are different).

Additional functions for valve positions

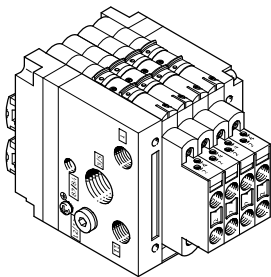

These valve extensions (vertical stacking) can be used to add further pneumatic functions to CPV valve manifold size 10 and 14:

- Two one-way flow control valves for flow regulation directly at the valve manifold for
 - supply air flow control
 - exhaust air flow control
- The vacuum flow control module must be used with the vacuum generator with or without ejector pulse and provides a non-return function and adjustable ejector pulse

 Note
The additional functions cannot be used in the first or last valve position in combination with the pneumatic multiple connector plate M, P and cannot be used in combination with the pneumatic multiple connector plate GQC, GQD.

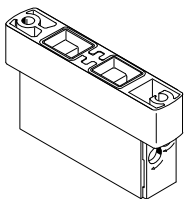

CPV10-BS-2xGRZZ-M7

- 2x one-way flow control valve for supply air flow control
- Additional function code P

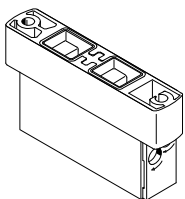

CPV10-BS-2xGRAZ-M7

- 2x one-way flow control valve for exhaust air flow control
- Additional function code Q

Valve manifold CPV10-EX-VI, Compact Performance

Key features – Assembly

Mounting options

The valve manifold have holes for four mounting screws, the mounting side is the side with the pneumatic fitting. These holes are also used to mount the valve manifold on a pneumatic multiple connector plate.

There are other mounting options in addition to this method:

- H-rail mounting
- Wall mounting
- Wall mounting via flanged pneumatic multiple connector plate

- On rear side via wall mounting
- On front side
- Mounting via through-hole in wall

The attachments are mounted with a screw and fixing bolt on the left-hand and right-hand end plates.

Attachment for H-rail

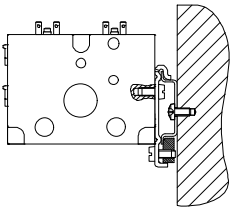

For valve manifold CPV10:
CPV10/14-VI-BG-NRH-35
(mounting code H)

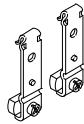

H-rail to EN 60715, not for accessories M, P, V (pneumatic multiple connector plate)

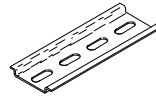

Attachment for wall mounting

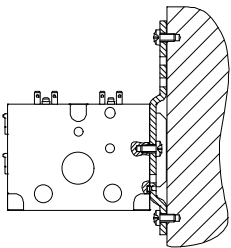

For valve manifold CPV10:
CPV10/14-VI-BG-RWL-B
(mounting code U)



Through-hole in wall, for example on the machine

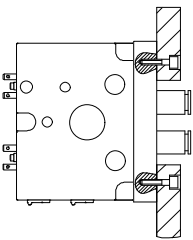

Wall mounting via pneumatic multiple connector plate

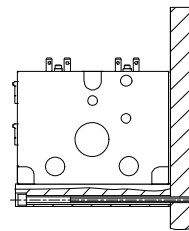

Valve manifold CPV10-EX-VI, Compact Performance

Key features – Assembly

Pneumatic multiple connector plate for wall/machine mounting

With flange, code P

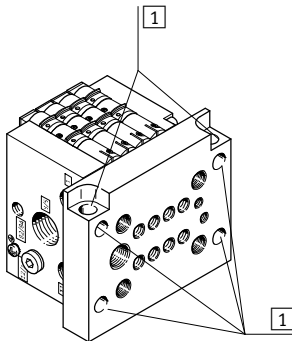

1 Mounting holes

- Multiple connector plate projects past the end plates
- Through mounting holes (without thread) in the flange
- Two additional holes running laterally through the pneumatic multiple connector plate also enable rear mounting of the CPV valve manifold

Without flange, code M

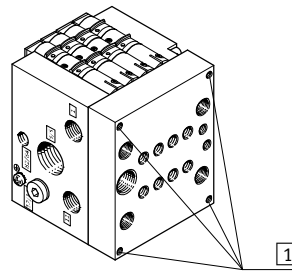

1 Mounting holes

- Multiple connector plate fits flush with the end plates
- Mounting holes (with thread) for wall or foot mounting are on the connection side of the pneumatic multiple connector plate

Pneumatic multiple connector plate for control cabinet assembly

With supply ports, code GQC

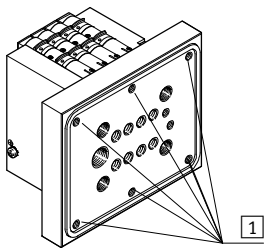

1 Mounting holes

- Multiple connector plate projects past the end plates
- Mounting holes (with thread) in the flange
- Multiple connector plate with seal

Without supply ports, code GQD

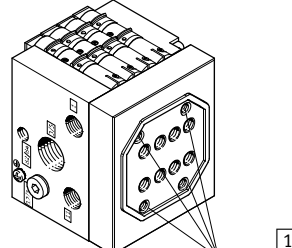

1 Mounting holes

- Multiple connector plate fits flush with the end plates
- The mounting holes (with thread) are on the connection side of the pneumatic multiple connector plate
- Multiple connector plate with seal

With supply ports, code GQE

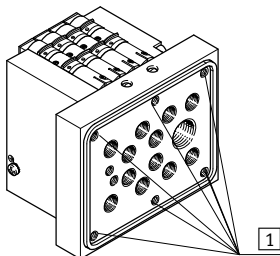

1 Mounting holes

- For 10 mm
- Multiple connector plate projects past the end plates
- Mounting holes (with thread) in the flange
- Multiple connector plate with seal
- Working port 1/8"

-  - Note

The outer valve slices cannot be equipped with valve extensions (e.g. one-way flow control valve) when using the pneumatic multiple connector plate M or P.

CPV valve manifold with flat plate silencers are only suitable for wall mounting.

If the pneumatic multiple connector plate GQC, GQD or GQE is used, the following limitations apply:

- Generally no attachment of valve extensions
- Not in combination with H-rail mounting
- Not in combination with wall mounting

Valve manifold CPV10-EX-VI, Compact Performance

Key features – Display and operation

Manual override

Three types of manual override are available:

- Non-detenting via slide
- Detenting
- Blocked

Subsequent conversion of the manual override from non-detenting to detenting or blocked is possible at any time.

The locking clip on the valve must be removed to this end. This is only possible after the individual valve has been removed or the tie rod of the valve manifold has been released.

 Note
See the manual for instructions.

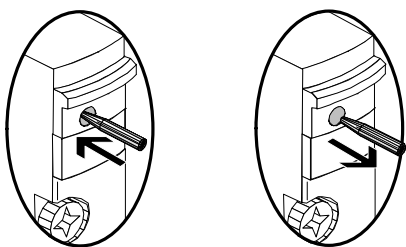
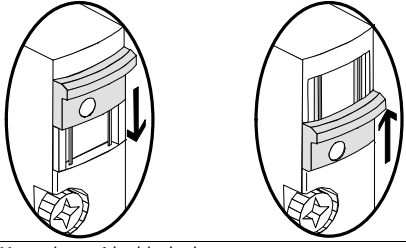
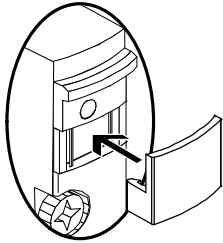
Code	Graphical symbol	Note
N	<p>Manual override, non-detenting</p> 	<p>In the “non-detenting” version, the blue slide is held via a locking clip. A pointed object (e.g. pen, etc.) can be used to activate the manual override through the opening.</p>
R	<p>Manual override, detenting</p> 	<p>In the “detenting” version, the locking clip is removed and the manual override is activated by pushing the slide down. The non-detenting function can be re-established by re-installing the locking clip.</p>
V	<p>Manual override, blocked</p> 	<p>In the “blocked” version, detenting or non-detenting activation of the manual override is prevented by means of a cover. Like the non-detenting locking clip, the cover can be added subsequently, but then remains on the valve.</p>

Valve manifold CPV10-EX-VI, Compact Performance

Key features – Display and operation

Display and operation

Inscription labels

- Clip with identification field on the cable socket

CPV valve manifold with individual connection

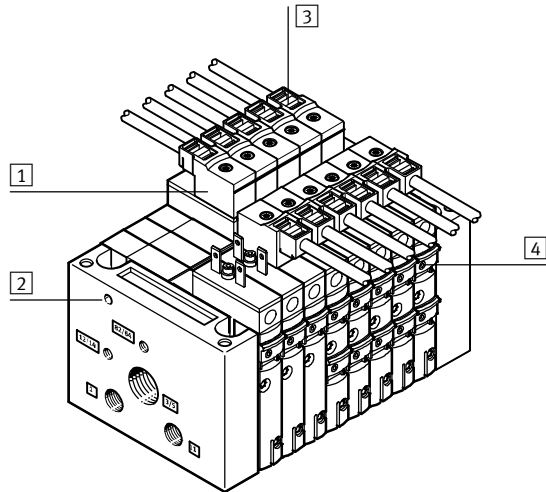

- 1 Pre-assembled connecting cable for each solenoid coil
- 2 Earth terminal
- 3 Inscription label (for each plug socket)
- 4 Manual override

Valve manifold CPV10-EX-VI, Compact Performance

Key features – Electrical components



Electrical connection

Individual connection

The corresponding connecting cables are generally designed without an LED.

The CPV10-EX-VI must only be operated in suitable intrinsically safe circuits. A wide range of well-known

manufacturers (list on request) offer appropriate controllers, barriers or

fieldbus circuits with intrinsically safe outputs.

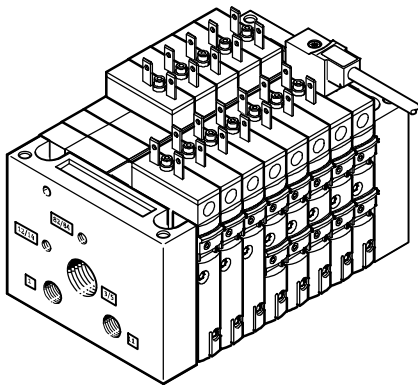

2 ... 16 solenoid coils (divided between 2 ... 8 valve slices) can be selected, odd numbers also possible. The pneumatic multiple connector plate can only be used with even numbers.

Note

The total maximum cable length of the electrical connecting cables per coil is 30 m. This value also applies when the valve manifold is installed in a control cabinet.

Ordering data

Designation		Part No.	Type
Plug socket with cable			
	Plug socket with cable	0.5 m	550324 KMYZ-4-0,5B-EX
		2.5 m	550481 KMYZ-4-2,5-B-EX
		5.0 m	550482 KMYZ-4-5,0-B-EX
Inscription label			
	Inscription labels 6x10 mm, 64 pieces in frames	18576	IBS-6x10

Dimensions – Connecting cable for individual connection

Download CAD data → www.festo.com

KMYZ-4-...-B-EX

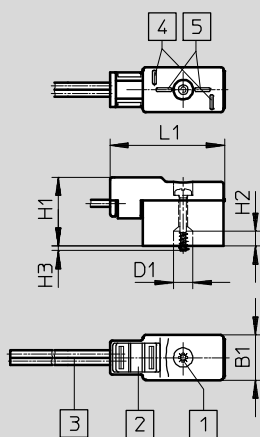

- 1 Mounting screw (self-tapping KB 18x12), max. tightening torque 0.3 Nm
- 2 Inscription label
- 3 2-wire cable 0.5 m or 2.5 m (1x 0.35 mm² 1x0.34 mm²)
- 4 Connection pattern for MSZB
- 5 Connection pattern for MSZC

	B1	D1	H1	H2	H3	L1
KMYZ-4-...-B-EX	9.8	4.3	15	3.2	1	25

Valve manifold CPV10-EX-VI, Compact Performance

Instructions for use

Equipment

Operate system equipment with unlubricated compressed air if possible. Festo valves and cylinders are designed so that, if used as designated, they will not require additional lubrication and will still achieve a long service life.

The quality of compressed air downstream of the compressor must correspond to that of unlubricated compressed air. If possible, do not operate all your system equipment with lubricated compressed air. The lubricators should, where possible, always be installed directly upstream of the actuator used.

Incorrect additional oil and too high an oil content in the compressed air reduce the service life of the valve manifold.

Use Festo special oil OFSW-32 or the alternatives listed in the Festo catalogue (as specified in DIN 51 524-HLP32; basic oil viscosity 32 CST at 40 °C).

Bio-oils

When using bio-oils (oils based on synthetic or native ester, e.g. rapeseed oil methyl ester), the maximum residual oil content of 0.1 mg/m³ must not be exceeded (see ISO 8573-1 Class 2).

Mineral oils



When using mineral oils (e.g. HLP oils to DIN 51 524, parts 1 to 3) or similar oils based on poly-alpha-olefins (PAO), the maximum residual oil content of 5 mg/m³ must not be exceeded (see ISO 8573-1 Class 4).

A higher residual oil content irrespective of the compressor oil cannot be permitted, as the basic lubricant would be flushed out over time.

Valve manifold CPV10-EX-VI, Compact Performance

FESTO

Technical data

-  - Flow rate up to 400 l/min
-  - Valve width 10 mm
-  - Voltage 24 V DC

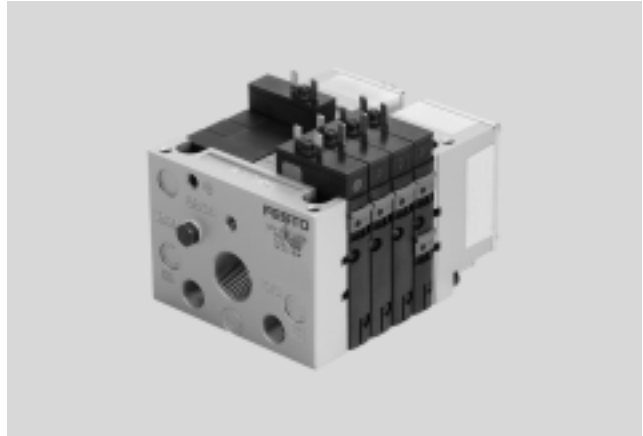

General technical data		CPV10-EX-VI
Design		Electromagnetically actuated piston spool valve
Lubrication		Life-time lubrication, PWIS-free (free of paint-wetting impairment substances)
Type of mounting		Via pneumatic multiple connector plate Via backwall On H-rail
Mounting position		Any
Lap		Overlap
Manual override		Non-detenting/detenting/blocked
Width	[mm]	10
Nominal size	[mm]	4
Nominal flow rate without fitting	[l/min]	400
b value		0.4 0.35 ²⁾
c value	[l/sbar]	1.6
Protection class		IP50
Pneumatic connections ¹⁾		
Pneumatic connection		Via end plate or pneumatic multiple connector plate
Supply port	1/11	G1/8
Exhaust	3/5	G3/8 (G1/4)
Working ports	2/4	M7
Pilot air supply	12/14	M5 (M7)
Pilot exhaust port	82/84	M5 (M7)

1) Connection dimensions in brackets for pneumatic multiple connector plate
2) Values for 2x 2/2-way valve

Safety characteristics		CPV10-EX-VI
Note on forced switch on/off		Switching frequency min. 1/week
Max. positive test pulse with 0 signal	[μs]	1400
Max. negative test pulse with 1 signal	[μs]	700
Shock resistance		Shock test with severity level 2, to EN 60068-2-27
Vibration resistance		Transport application test with severity level 2, to EN 60068-2-6

Valve manifold CPV10-EX-VI, Compact Performance

Technical data

Operating and environmental conditions	
Valve function order code	M J N C CY H D I
Operating medium	Compressed air to ISO 8573-1:2010 [7:4:4] → page 29
Note on operating/pilot medium	Lubricated operation possible (in which case lubricated operation will always be required)
Operating pressure [bar]	0 ... 10 +0.1 ... +10 0 ... 10
Operating pressure for valve manifold with internal pilot air supply [bar]	3 ... 8
Pilot pressure [bar]	3 ... 8
Ambient temperature [°C]	-5 ... +50
Temperature of medium [°C]	-5 ... +50
Relative air humidity at 25 °C [%]	90 with no condensation
Note on materials	RoHS-compliant
Certification	c UL us Recognized (OL) C-Tick

Certifications	
This product is certified for use in ATEX zones in accordance with the EU ATEX Directive	
ATEX category gas	II 2G
Ex-ignition protection type gas	Ex ib IIC T4 Gb
ATEX category dust	II 2D
EX-ignition protection type dust	Ex ib IIIC T100°C Db
Explosion-proof temperature rating [°C]	Pi 0,76W: -5°C ≤ Ta ≤ +50°C
[°C]	Pi 0,93W: -5°C ≤ Ta ≤ +40°C
Explosion protection certification outside the EU	EPL Db (IEC-EX) EPL Dc (IECEX) EPL Gb (IECEX) EPL Gc (IECEX)
Certificate issuing authority	IBExU12ATEX1110X IECEX IBE13.0046X
CE mark (see declaration of conformity)	To EU Explosion Protection Directive (ATEX)

 Note

The ATEX certification in accordance with the EU ATEX directive only applies to fully assembled valve terminals.

Valve manifold CPV10-EX-VI, Compact Performance

FESTO

Technical data

Electrical data – Valve solenoid		
Width	[mm]	10
Max. ambient temperature	[°C]	+50
Max. input voltage U_i	[V DC]	32
Max. input current I_i	[A]	0.2
Max. input power P_i	[W]	0.76
Required current consumption	[A]	0.016
Effective internal inductance L_i	[μH]	≈0
Effective internal capacity C_i	[nF]	≈0
Resistance R_{20}	[Ω]	920 ±5%
Power supply	Only from certified intrinsically safe circuits EEx ia IIC or ib IIC	
Duty cycle ED	[%]	100
Protection class to EN 60529	IP50	
	IP65 with pneumatic multiple connector plate for control cabinets	
Max. connecting cable length per coil	[m]	30

1) The minimum required current consumption drops at higher pilot pressures

Valve switching times [ms]									
Valve function order code		M	J	N	C	CY	H	D	I
Switching times	On	17	–	17	17	17	17	15	15
	Off	40	–	37	37	37	37	17	17
	Change-over	–	10	–	–	–	–	–	–

Materials	
Valve slices	Die-cast aluminum
Valve module 5/3G	Cast aluminium, POM
Blanking plate/separator plate	PA
End plates	Die-cast aluminum
Flat plate silencer	Die-cast aluminium, PE
Pneumatic multiple connector plate	Wrought aluminum alloy
Seal	NBR

Product weight	
Approx. weight	[g]
End plates (2 pieces)	160
Pneumatic multiple connector plate	
• on valve manifold with 2 valve positions	120
• on valve manifold with 4 valve positions	165
• on valve manifold with 6 valve positions	225
• on valve manifold with 8 valve positions	270
Flat plate silencer	147
Blanking plate	25
Separator plate	25
Valve sub-base	73
Function element: 5/3G function	46
Function element: one-way flow control valve	25

Valve manifold CPV10-EX-VI, Compact Performance

Technical data

Dimensions

Download CAD data → www.festo.com

Valve manifold CPV10-EX-VI with supply ports in the end plates

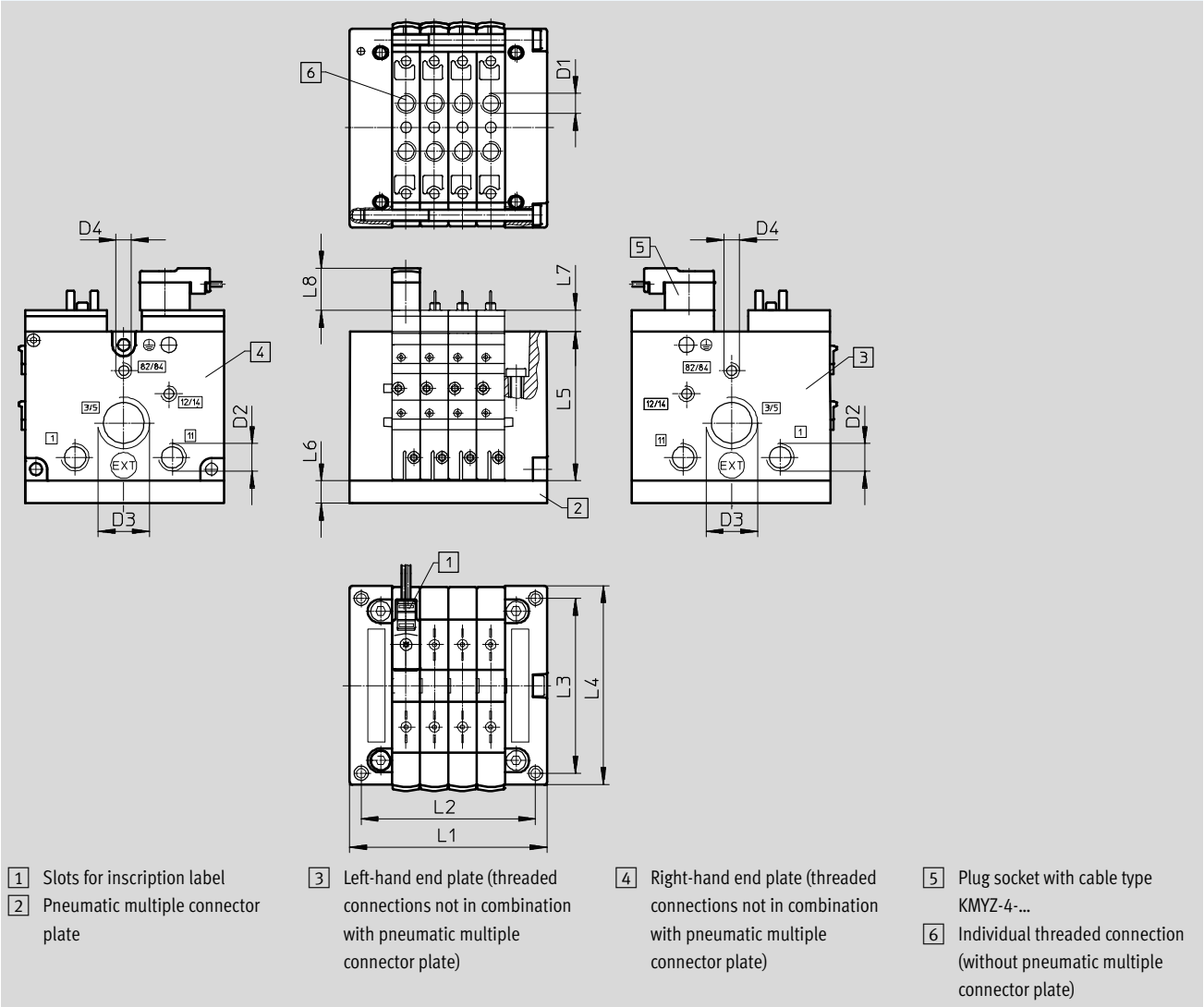

	L1	L2	L3	L4	L5	L6	L7	L8	D1	D2	D3	D4
2-way	50	41.8	62	71	52.8	15	7.8	15	M7	G1/8	G3/8	M5
3-way	60	51.8										
4-way	70	61.8										
5-way	80	71.8										
6-way	90	81.8										
7-way	100	91.8										
8-way	110	101.8										

Valve manifold CPV10-EX-VI, Compact Performance

Technical data

Dimensions

Download CAD data → www.festo.com

Valve manifold CPV10-EX-VI with flat plate silencer

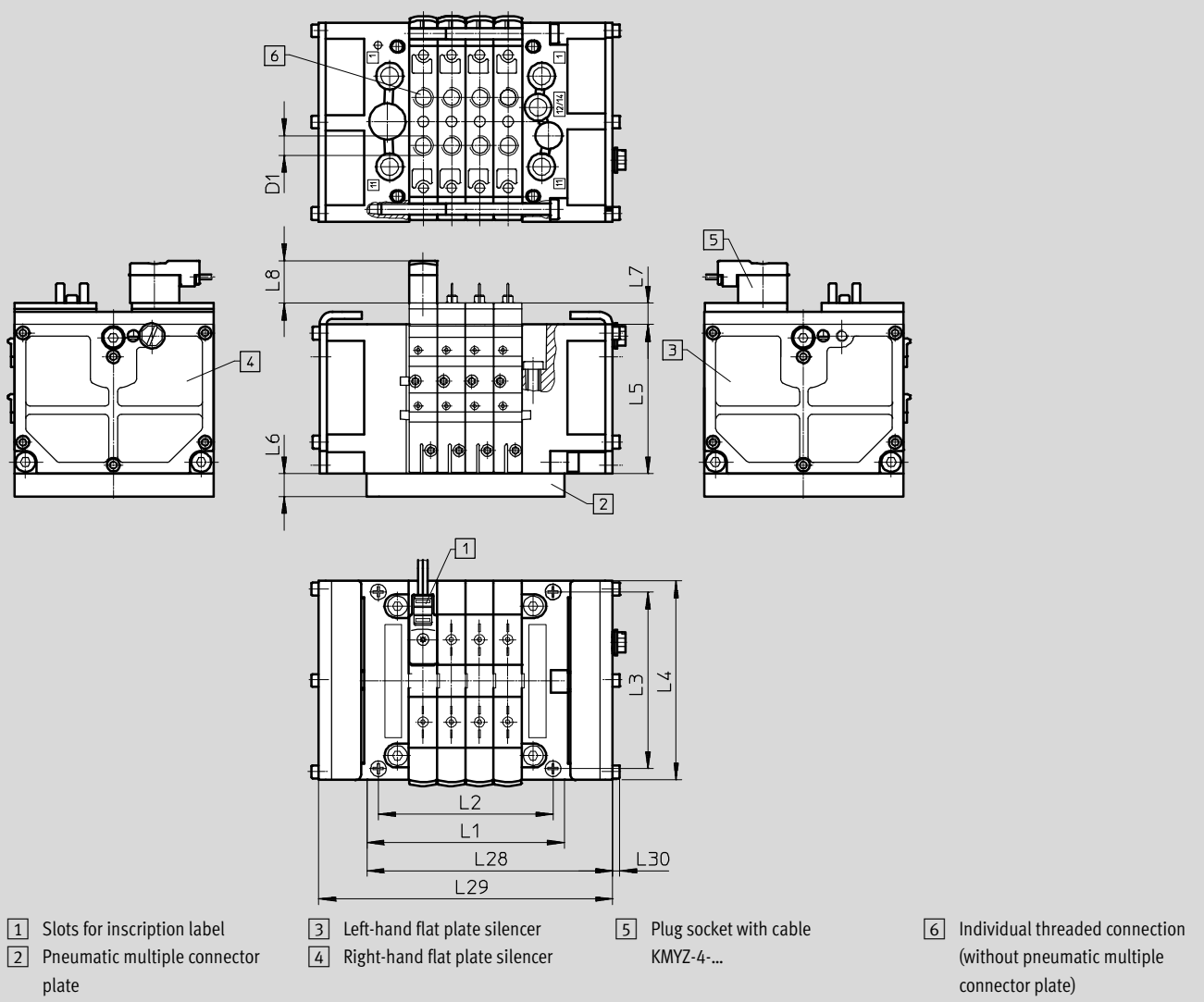

	L1	L2	L3	L4	L5	L6	L7	L8	L28	L29	L30	D1
2-way	50	41.8	62	71	52.8	15	7.6	15	67	84	2.5	M7
3-way	60	51.8							77	94		
4-way	70	61.8							87	104		
5-way	80	71.8							97	114		
6-way	90	81.8							107	124		
7-way	100	91.8							117	134		
8-way	110	101.8							127	144		

Valve manifold CPV10-EX-VI, Compact Performance

Technical data

Dimensions

Download CAD data → www.festo.com

Wall mounting CPV10-VI-BG-RWL-B

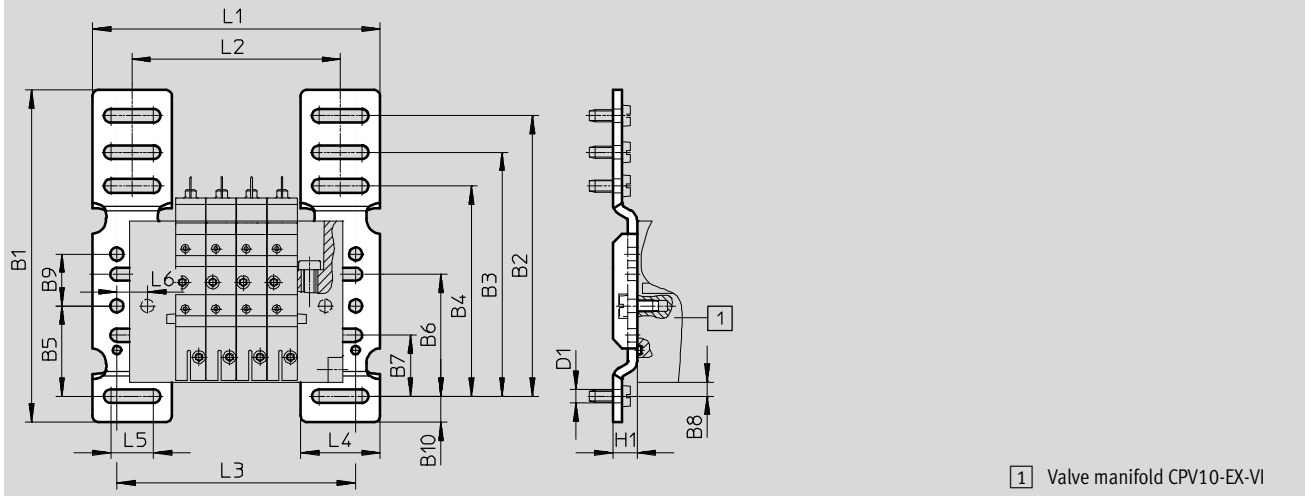

CPV10	2-way	3-way	4-way	5-way	6-way	7-way	8-way
L1	74	84	94	104	114	124	134
L2	48	58	68	78	88	98	108
L3	58	78	88	98	108	118	128

	B1	B2	B3	B4	B5	B6	B7	B8	B9	B10	D1	H1	L4	L5	L6
CPV10	109	92	80	69	29.6	40	20	4.6	17	8.5	4.5	8	26	14	10

Valve manifold CPV10-EX-VI, Compact Performance

Technical data

Dimensions

Download CAD data → www.festo.com

Attachment for H-rail mounting CPV10-VI-BG-NRH-35

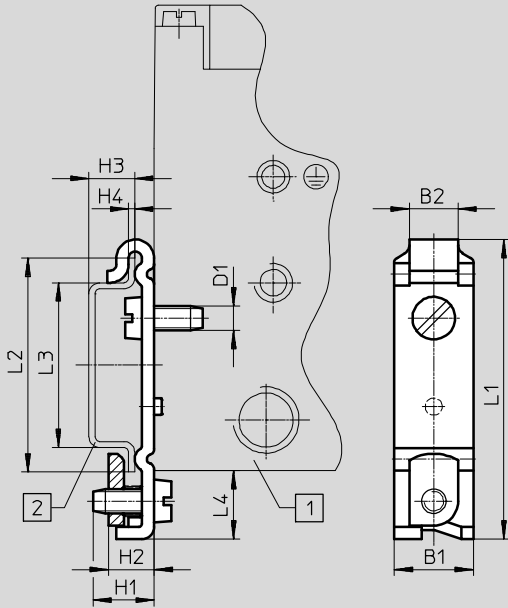

- 1 Valve manifold CPV10-EX-VI
- 2 H-rail to EN 60715

	B1	B2	D1	H1	H2	H3	H4	L1	L2	L3	L4
	±0.1					-0.1	±0.1		±0.1	±0.1	
CPV10	13	8	M4	10	7.5	7.5	1	49.1	35	27	11.2

Valve manifold CPV10-EX-VI, Compact Performance

Technical data

Dimensions

Download CAD data → www.festo.com

Pneumatic multiple connector plate

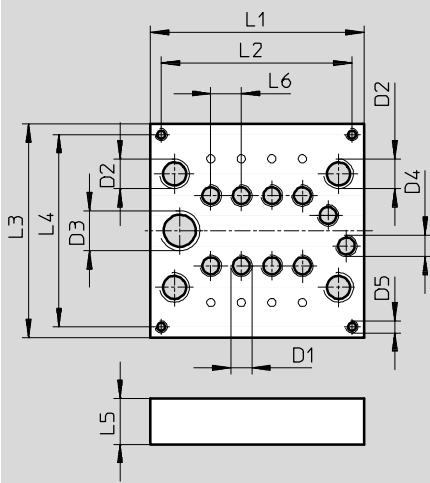

	L1	L2	L3	L4	L5	L6	D1	D2	D3	D4	D5
2-way	49.5	42.5	70	63	15	10	M7	G1/8	G1/4	M7	M4
4-way	69.5	62.5									
6-way	89.5	82.5									
8-valve	109.5	102.5									

Flanged pneumatic multiple connector plate

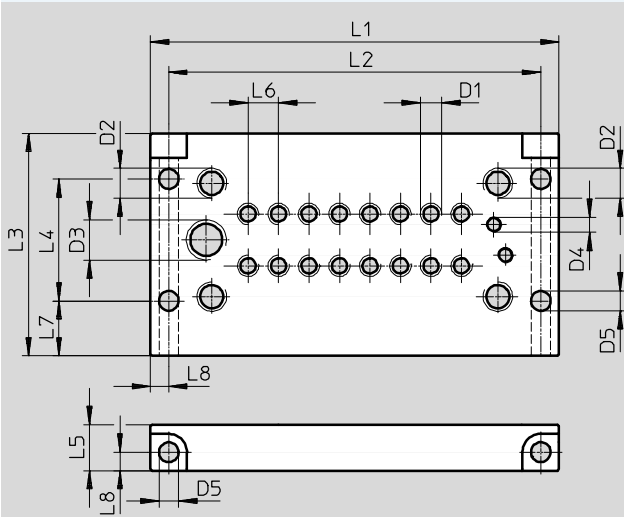

	L1	L2	L3	L4	L5	L6	L7	L8	D1	D2	D3	D4
2-way	74	62	73	40	15	10	18	6	M7	G1/8	G1/4	M5
4-way	94	82										
6-way	114	102										
8-way	134	122										

Valve manifold CPV10-EX-VI, Compact Performance

Technical data

Dimensions

Download CAD data → www.festo.com

Pneumatic multiple connector plate for control cabinet installation, without supply ports

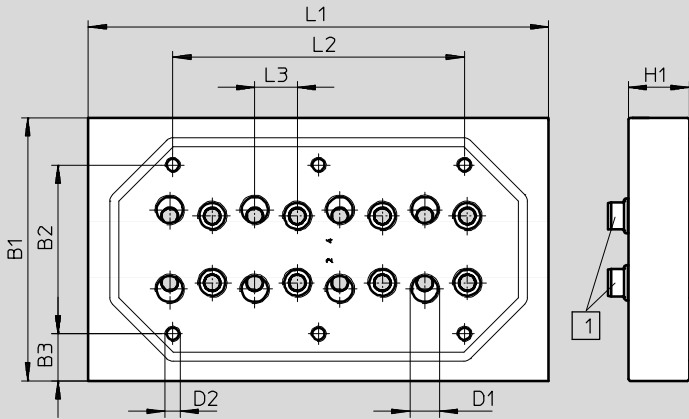

1 Seal

	L1	L2	L3	B1	B2	B3	D1	D2	H1
2-way	49.5	-	10	70	40	15	M7	M5	10
4-way	69.5	28							
6-way	89.5	49							
8-way	109.5	68							

Pneumatic multiple connector plate for control cabinet installation, with supply ports

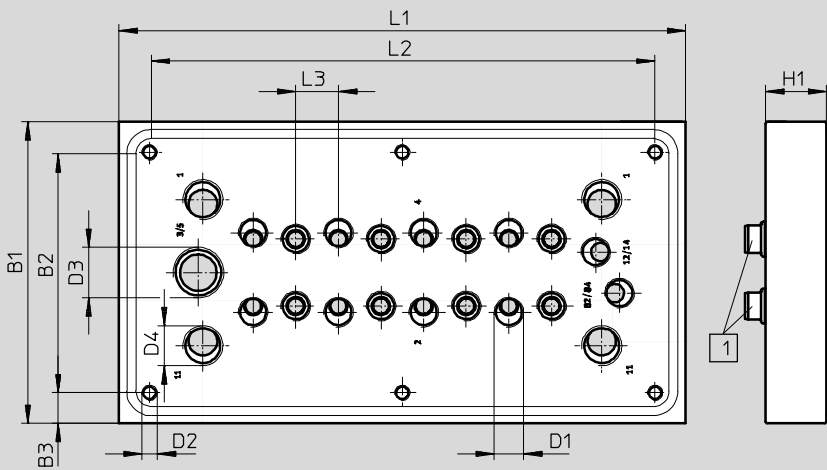

1 Seal

	L1	L2	L3	B1	B2	B3	D1	D2	D3	D4	H1
2-way	82	62	10	84	64	10	M7	M5	G1/4	G1/8	15
4-way	102	82									
6-way	122	102									
8-way	142	122									

Valve manifold CPV10-EX-VI, Compact Performance

Technical data

Dimensions

Download CAD data → www.festo.com

Valve kit for 5/3-way function

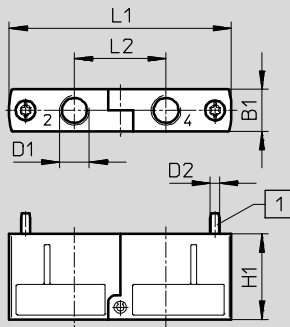

1 Mounting screw enclosed separately

Type	B1	D1	D2	H1	L1	L2
CPV10-BS-5/3G-M7	9.9	M7	M2.5	22	55.8	23

Additional function – One-way flow control valve

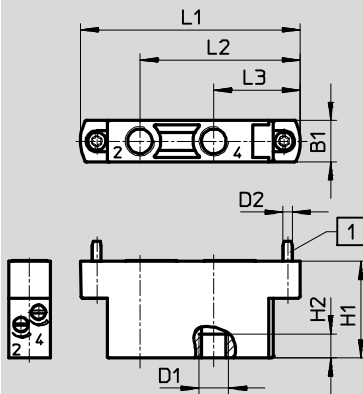

1 Mounting screw enclosed separately

Type	B1	D1	D2	H1	H2	L1	L2	L3
CPV10-BS-2xGR...-M7	9.9	M7	M2.5	26	6	55.8	41.4	22.9
CPV10-BS-2xGRZ-V...-M7							-	

Valve manifold CPV10-EX-VI, Compact Performance

FESTO

Accessories

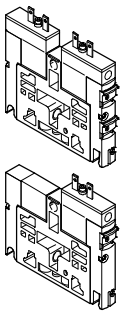
Ordering data				
	Code	Valve function	Part No.	Type
Individual sub-base valve size 10				
	M	5/2-way valve, single solenoid, piston spool valve	550696	CPV10-M1H-5LS-M7-B-EX
	J	5/2-way valve, double solenoid, piston spool valve	550697	CPV10-M1H-5JS-M7-B-EX
	N	2x 3/2-way valve, normally open, piston spool valve	550698	CPV10-M1H-2x3-OLS-M7-B-EX
	C	2x 3/2-way valve, normally closed, piston spool valve	550700	CPV10-M1H-2x3-GLS-M7-B-EX
	CY	2x 3/2-way valve, normally closed, integrated back pressure protection, piston spool valve	553261	CPV10-M1H-2x3-GLS-Y-M7-B-EX
	H	2x 3/2-way valve, 1x normally open, 1x closed, piston spool valve	550699	CPV10-M1H-30LS-3GLS-M7-B-EX
	D	2x 2/2-way valve, normally closed, piston spool valve	550701	CPV10-M1H-2x2-GLS-M7-B-EX
	I	2x 2/2-way valve, 1x normally open, 1x closed, piston spool valve	550702	CPV10-M1H-20LS-2GLS-M7-B-EX

Valve manifold CPV10-EX-VI, Compact Performance

FESTO



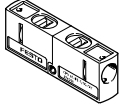
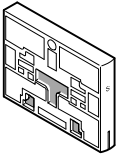
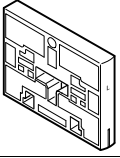
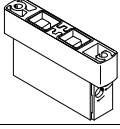
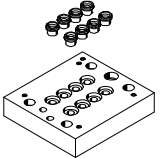



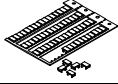

Accessories

Ordering data				
	Code	Designation	Part No.	Type
Function block				
	G	Valve kit for 5/3-way valve function, closed (in combination with valve slice C) for size 10	176055	CPV10-BS-5/3G-M7
Separator plates				
	T	Separator plate, duct 1/11 closed	161369	CPV10-DZP
	S	Separator plate, duct 1/11, 3/5 closed	178678	CPV10-DZPR
Blanking plate				
	L	Blanking plate	161368	CPV10-RZP
Additional functions for valve positions				
	P	One-way flow control valve, 2x supply air	184140	CPV10-BS-2XGRZZ-M7
	Q	One-way flow control valve, 2x exhaust air	184141	CPV10-BS-2XGRAZ-M7
Pneumatic multiple connector plate				
	M	Pneumatic multiple connector plate, for wall/machine mounting, without side flange	2-valve	161969 CPV10-VI-P2-M7
			4-valve	161970 CPV10-VI-P4-M7
			6-valve	161971 CPV10-VI-P6-M7
			8-valve	163893 CPV10-VI-P8-M7
	P	Pneumatic multiple connector plate, for wall/machine mounting, with side flange	2-valve	152420 CPV10-VI-P2-M7-B
			4-valve	152421 CPV10-VI-P4-M7-B
			6-valve	152422 CPV10-VI-P6-M7-B
			8-valve	152423 CPV10-VI-P8-M7-B
	GQC	Pneumatic multiple connector plate with sealing ring, for control cabinet assembly, with supply ports	2-valve	538807 CPV10-VI-P2-M7-C
			4-valve	538808 CPV10-VI-P4-M7-C
			6-valve	538809 CPV10-VI-P6-M7-C
			8-valve	538810 CPV10-VI-P8-M7-C
	GQD	Pneumatic multiple connector plate with sealing ring, for control cabinet assembly, without supply ports	2-valve	538811 CPV10-VI-P2-M7-D
			4-valve	538812 CPV10-VI-P4-M7-D
			6-valve	538813 CPV10-VI-P6-M7-D
			8-valve	538814 CPV10-VI-P8-M7-D
-	Pneumatic multiple connector plate with sealing ring, for control cabinet assembly, with all ports	2-valve	566709 CPV10-VI-P2-1/8-C	
		4-valve	566710 CPV10-VI-P4-1/8-C	
		6-valve	566711 CPV10-VI-P6-1/8-C	
		8-valve	566712 CPV10-VI-P8-1/8-C	

Valve manifold CPV10-EX-VI, Compact Performance

FESTO

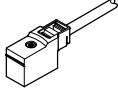
Accessories

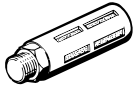
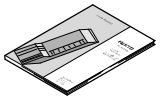
Ordering data				
	Code	Designation	Part No.	Type
Inscription labels				
	-	6x10 mm in frames, 64 pieces	18576	IBS 6x10
Mounting attachments				
	H	Attachment for H-rail	162556	CPV10/14-VI-BG-NRH-35
	U	Attachment for wall mounting	189541	CPV10/14-VI-BG-RWL-B
	X	Attachment for individual connection	165801	CPV10-VI-BG-ET200X
Manual override				
	-	Locking clip (for manual override), non-detachable	526203	CPV10/14-HS
	V	Locking clip (cover for manual override)	530055	CPV10/14-HV
Cable for individual connection, electrical				
	-	Plug socket with cable	0.5 m	550324 KMYZ-4-0,5-B-EX
	-		2.5 m	550481 KMYZ-4-2,5-B-EX
	-		5.0 m	550482 KMYZ-4-5,0-B-EX
Blanking plug				
	-	For thread M5	3843	B-M5
	-	For thread M7	174309	B-M7
	-	For thread G $\frac{1}{8}$	3568	B-1/8
Push-in fitting				
	-	Connecting thread R1/8, for tubing O.D. 8 mm	153015	QS-1/8-8-I
	-	Male thread M5, for tubing O.D. 6 mm	153317	QSM-M5-6-I
	-	Male thread M7, for tubing O.D. 6 mm	153321	QSM-M7-6-I
Silencer				
	-	For thread M5	1205858	AMTE-M-LH-M5
	-	For thread G $\frac{1}{4}$	6842	U-1/4-B
	-	For thread G $\frac{3}{8}$	6843	U-3/8-B
	-	For thread M7	161418	UC-M7
Manual				
	-	CPV Pneumatics Manual	German	547039 P.BE-CPV10-EX-VI-DE
	-		English	547040 P.BE-CPV10-EX-VI-EN
	-		French	547041 P.BE-CPV10-EX-VI-FR
	-		Italian	547042 P.BE-CPV10-EX-VI-IT
	-		Spanish	547043 P.BE-CPV10-EX-VI-ES
	-		Swedish	547044 P.BE-CPV10-EX-VI-SV