

3-dimensional gantries



3-dimensional gantries

Key features

At a glance

The 3-dimensional gantry facilitates movement in 3D space. Depending on the requirements, the gantry is either composed of several axis modules (YXCR) or using the planar surface gantries EXCM or EXCH (YXMR). All of these are tried-and-tested components from Festo.

- Can be used universally for handling light to very heavy workpieces or high payloads
 - Especially suitable for very long strokes
 - High mechanical rigidity and sturdy design
 - Pneumatic and electric components – freely combinable
 - As an electrical solution – freely positionable/any intermediate positions
- Range of application:
- For any movements in 3D space
 - Very high requirements for precision and/or very heavy workpieces combined with long strokes

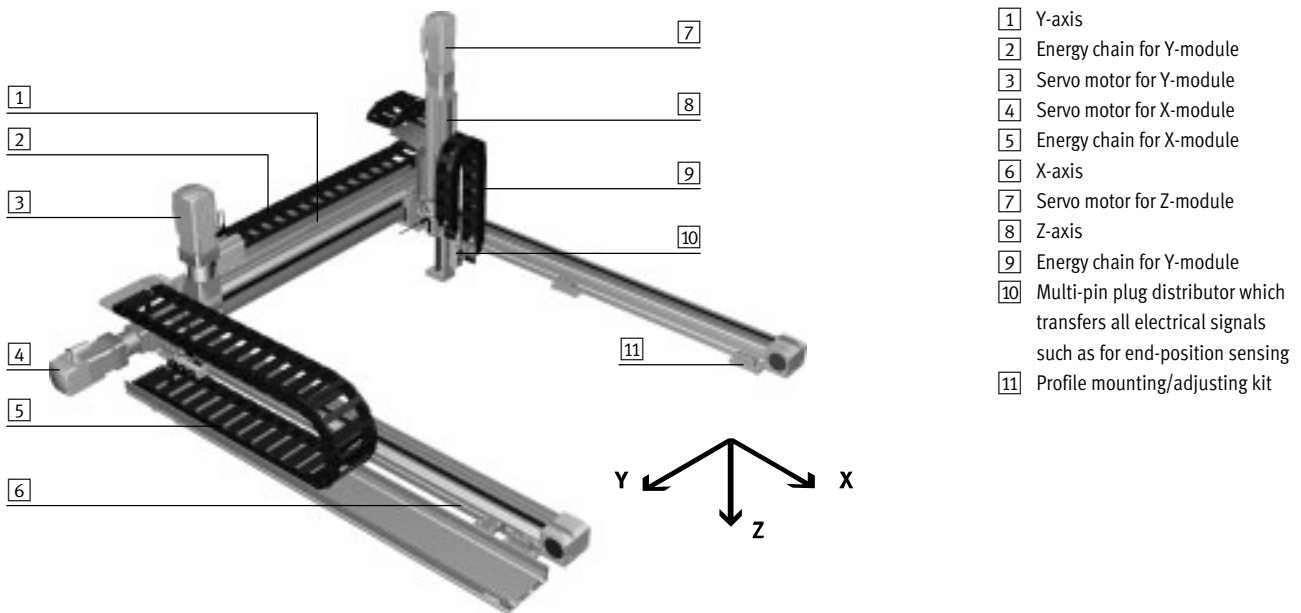

Description of the modules

X-module

Configuration:

The X-module EHMx comprises two parallel toothed belt axes which are connected by a connecting shaft. They are powered by a servo motor. Adapters are installed on the slides of the X-axes to connect the Y-module. The position of the motor and energy chain can be selected using the configurator.

The following components are located on the motor side:

- Energy chain
- Multi-pin plug distributor for proximity sensor (if sensor package has been selected)

Sample image:

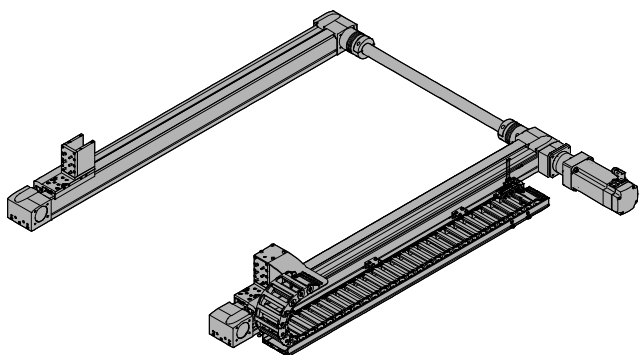

3-dimensional gantries

Key features

Description of the modules

Y-module

Configuration:

The Y-module EHYM comprises a linear axis which is powered by a servo motor. Adapters are installed on the slides of the Y-axis to connect the Z-module.

The position of the motor and energy chain is dependent on the position of the motor on the X-module.

The following components are located on the motor side:

- Energy chain
- Multi-pin plug distributor for proximity sensor (if sensor package has been selected)

Sample image:

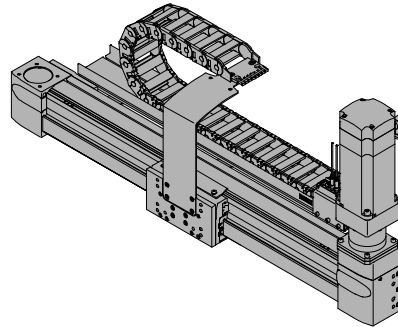

Z-module

Configuration:

The Z-module EHMZ comprises an electric drive, the DHMZ comprises a pneumatic drive. In both variants, an energy chain is attached as a cable guide.

The Z-module can be selected using the configurator, depending on the application.

Sample image:

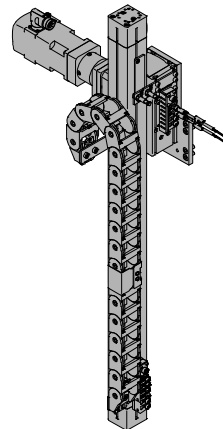

XY-module (EXCM, EXCH)

Configuration:

A slide is moved in a two-dimensional space (X-axis/Y-axis) via a toothed belt. The system is powered by two fixed motors. The motors are coupled to the toothed belt. The belt is guided via pulleys so that the slide can move to any position in a working space when the motors are actuated.

When using attachment components, additional processes can be carried out by independent Z-axes.

Sample image:

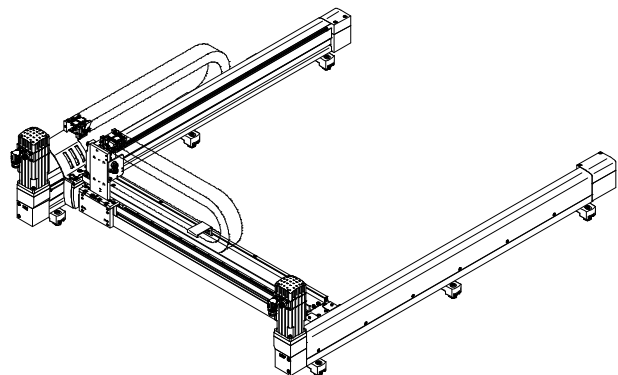

3-dimensional gantries

Key features



Description of the modules

Z-module (EXCM, EXCH)

Configuration:

The Z-module comprises either an electric drive (EHMZ) or a pneumatic drive (DHMZ).

The Z-module can be selected using the configurator, depending on the application.

Sample image:

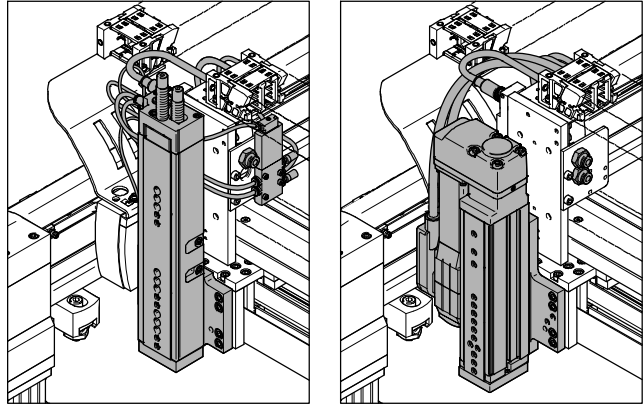

Dispatch options

Fully assembled:

The 3-dimensional gantry is fully assembled. All cables and tubing are installed and connected. The system is already set up on delivery, but must be adapted to the particular mounting surface during installation.

Note flatness → table below.

Partially assembled:

The 3-dimensional gantry is delivered partially assembled. This means that all three axis modules (X-/Y-/Z-axis) are assembled, each with the optional motors. The partially assembled system must be completed by the customer. Help can be found in the assembly instructions provided.

Optional accessories (→ page 11) are enclosed.

Note flatness → table below.

System overview¹⁾

Size	YXCR-1	YXCR-2	YXCR-3	YXCR-4
Max. working stroke	X: 1900 mm Y: 1900 mm Z: 50 mm	X: 3000 mm Y: 2000 mm Z: 800 mm	X: 3000 mm Y: 2000 mm Z: 800 mm	X: 3000 mm Y: 2000 mm Z: 800 mm
Max. payload	Dependent on the selected dynamic response			
Required flatness of the mounting surface	≤ 0.1 mm/m			
Mounting position	Horizontal			

Size	YXMR-1	YXMR-2	YXMR-3
Max. working stroke	X: 700 mm Y: 510 mm Z: 100 mm (electric) 150 mm (pneumatic)	X: 2000 mm Y: 1000 mm Z: 200 mm (electric) 150 mm (pneumatic)	X: 2500 mm Y: 1500 mm Z: 200 mm
Max. payload	Dependent on the selected dynamic response		
Required flatness of the mounting surface	≤ 0.1 mm/m		
Mounting position	Horizontal		

1) Drive package depending on configuration selected.

3-dimensional gantries

Key features

Configurator: Handling Guide Online (HGO)

Selecting a handling system

Planning complex handling systems takes a lot of time. You can use the configurator "Handling Guide Online" (HGO) to design a customised handling system for your application in just a few steps.

You can choose from the following systems:

- Single-axis system
- 2D linear gantry
- 2D planar surface gantry
- 3-dimensional gantry

Advantages:

- Automatic selection of all relevant components
- Automatic design and calculation of workload
- Quote created automatically
- CAD model available immediately
- Fully automated processing
- You can order fully or partially assembled systems through the Online Shop
- Lots of possible options



Selecting the handling solution

Select your handling system.

Single-axis system

Single-axis movement
Single-axis module as a complete system
Easy to connect to your own front end
 Armature

2D linear gantry

Movements in 2D in the vertical working space
Linear gantries as complete systems
Electric and pneumatic axes can be combined
 Armature

2D gantry

Movements in 2D in the horizontal working space
Planar surface gantries as complete systems
CONTAINING ELECTRIC AXES
Easy to connect to your own 2-nd
 Armature

3D gantry

Movements in 3D
Three-dimensional gantries as complete systems
Electric and pneumatic axes can be combined
 Armature

Add to basket
 Create CAD
 Documentation
 Transmission
 Start project
 Handling solution
 Standard system
 Save system
 Load system
 Selected axes
 Filter system ID:

Entering the application data

- Payload
- Drive system of the axis
- Distance from the centre of the load
- Working stroke
- Reference cycle



Axis definition and payload

Axis definition

Drive system of the axis

ELECTRIC several positions
 ELECTRIC several positions
 Pneum. select

Regular working stroke

X: mm

Y: mm

Working stroke in Z direction

Z: mm

Take care: always measured into movement in given specifications

Payload

Payload (front end and envelope)

kg

Distance from the centre of the load

X: mm

Y: mm

Z: mm

Add to basket
 Create CAD
 Documentation
 Transmission
 Start project
 Handling solution
 Standard system
 Save system
 Load system
 Selected axes

3-dimensional gantries

Key features

Configurator: Handling Guide Online (HGO)

Result of calculation

You will be offered a selection of systems calculated based on the application data you entered.

The following are available immediately:

- CAD model
- Data sheet of the selected system
- Price information

Result of calculation
Select the appropriate system and condition with the configuration: 1

No.	System name	System workload	Repetition accuracy (µm)
<input checked="" type="checkbox"/>	1	100N/2	10 µm
<input type="checkbox"/>	2	100N/2	10 µm
<input type="checkbox"/>	3	100N/2	10 µm
<input type="checkbox"/>	4	100N/2	10 µm
<input type="checkbox"/>	5	100N/2	10 µm

3D gantry YK30-C-40

Drive module	X module (rotated ball axis) SSC-60	Y module (rotated ball axis) SSC-60	Z module (Electric mini slide) SRS-45
Stroke	300 mm	300 mm	100 mm
Repetition accuracy (µm)	0/0 mm	0/0 mm	0/0 mm
Clearance	0-1	0-1	Without
Motor type	Servo motor EM60-K2	Servo motor EM60-K2	Servo motor EM60-K2
Motor position	Inside	Left	Top
Motor controller	CAMP-60-AD	CAMP-60-AD	CAMP-60-AD
Rated voltage phases	1 phase	1 phase	1 phase

Navigation sidebar:

- ADD TO BASKET
- 3D CAD
- Documentation
- Technical data
- Send request
- Handling solution
- Standard system
- Save system
- Load system
- Selected system # 1

System overview

You will be given an overview of the whole system.

You will also have the following options:

- Request price
- Send request
- Add to basket

Your handling solution
View selected system overview

Your system ID: **C137963**

Your next steps:

Navigation sidebar:

- ADD TO BASKET
- 3D CAD
- Documentation
- Technical data
- Send request
- Handling solution
- Standard system
- Save system
- Load system
- Selected system # 1

View our technology
Find the right vacuum generators and suction cups for your application.

3-dimensional gantries

Key features

Standard components within the handling system

The handling system comprises a number of tried-and-tested standard components from Festo. Different components are used depending on the configuration. The single axes installed will be displayed in the configurator HGO on the "Result of calculation" page.

No.	Symbol name	Symbol number	Quantity	Unit
1	EGC-TB-KF	2010	1	EA
2	EGC-TB-KF	2010	1	EA
3	EGC-TB-KF	2010	1	EA
4	EGC-TB-KF	2010	1	EA

Drives/axes

X-axis

Toothed belt axis EGC-TB-KF



- Electric
- Rigid, closed profile
- Recirculating ball bearing guide for high loads and torques
- High dynamic response and minimum vibration

Y-axis

Toothed belt axis EGC-TB-KF



- Electric
- Rigid, closed profile
- Recirculating ball bearing guide for high loads and torques
- High dynamic response and minimum vibration

Toothed belt axis EGC-HD-TB



- Electric
- Flat drive unit with rigid, closed profile
- Duo guide rail
- For maximum loads and torques, high feed forces and speeds and long service life

Z-axis

Mini slide DGSL



- Pneumatic
- Flat design
- High load capacity
- High dynamic response
- Easy adjustment of end positions

Mini slide EGSL



- Electric
- Compact design
- High load capacity
- High dynamic response
- Easy adjustment of end positions

Spindle axis EGC-BS-KF



- Electric
- Rigid, closed profile
- Recirculating ball bearing guide for high loads and torques
- High dynamic response and minimum vibration
- Various spindle pitches

Cantilever axis DGEA



- Electric
- High rigidity
- High load capacity
- High dynamic response

3-dimensional gantries

Key features

Drives/axes

Z-axis

Mini slide EGSC



- Electric
- Compact design
- High load capacity
- Precision guide and ball screw drive
- Easy adjustment of end positions

Possible axis combinations¹⁾

Size	X-module	Y-module	Z-module
YXCR-1	<ul style="list-style-type: none"> • Toothed belt axis EGC-50-TB-KF 	<ul style="list-style-type: none"> • Toothed belt axis EGC-50-TB-KF 	<ul style="list-style-type: none"> • Mini slide Pneumatic: DGSL-6 Electric: EGSL-35
YXCR-2	<ul style="list-style-type: none"> • Toothed belt axis EGC-80-TB-KF 	<ul style="list-style-type: none"> • Toothed belt axis EGC-80-TB-KF • Toothed belt axis with heavy-duty guide EGC-HD-125-TB 	<ul style="list-style-type: none"> • Mini slide Pneumatic: DGSL-12/16 Electric: EGSL-45/55 • Cantilever axis DGEA-18 • Spindle axis EGC-70-BS-KF
YXCR-3	<ul style="list-style-type: none"> • Toothed belt axis EGC-120-TB-KF 	<ul style="list-style-type: none"> • Toothed belt axis EGC-120-TB-KF • Toothed belt axis with heavy-duty guide EGC-HD-160-TB 	<ul style="list-style-type: none"> • Mini slide Pneumatic: DGSL-20/25 Electric: EGSL-75 • Cantilever axis DGEA-25/40 • Spindle axis EGC-80-BS-KF
YXCR-4	<ul style="list-style-type: none"> • Toothed belt axis EGC-185-TB-KF 	<ul style="list-style-type: none"> • Toothed belt axis EGC-185-TB-KF • Toothed belt axis with heavy-duty guide EGC-HD-220-TB 	<ul style="list-style-type: none"> • Cantilever axis DGEA-40 • Spindle axis EGC-120-BS-KF
YXMR-1	<ul style="list-style-type: none"> • Planar surface gantry EXCM-30 	<ul style="list-style-type: none"> • Planar surface gantry EXCM-30 	<ul style="list-style-type: none"> • Mini slide Pneumatic: DGSL-8/10/12 Electric: EGSC-25/32
YXMR-2	<ul style="list-style-type: none"> • Planar surface gantry EXCM-40, EXCH-40 	<ul style="list-style-type: none"> • Planar surface gantry EXCM-40, EXCH-40 	<ul style="list-style-type: none"> • Mini slide Pneumatic: DGSL-16 Electric: EGSL-45
YXMR-3	<ul style="list-style-type: none"> • Planar surface gantry EXCH-60 	<ul style="list-style-type: none"> • Planar surface gantry EXCH-60 	<ul style="list-style-type: none"> • Mini slide Pneumatic: DGSL-20 Electric: EGSL-55

1) Drive package depending on configuration selected.

3-dimensional gantries

Key features

Standard components within the handling system

The handling system comprises a number of tried-and-tested standard components from Festo. Different components are used depending on the configuration. You can alter the scope and design of the drive package in the configurator HGO on the "System configuration" page.



Motors and controllers

Servo motors EMMS-AS



- Dynamic, brushless, permanently excited servo motor
- Digital absolute displacement encoder in single-turn or multi-turn version
- With optional brake

Servo motors EMME-AS



- Dynamic, brushless, permanently excited servo motor
- Digital absolute displacement encoder in single-turn or multi-turn version
- With optional brake

Stepper motors EMMS-ST



- 2-phase hybrid technology
- Step angle 1.8°
- With optional brake

Gear unit EMGA



- Low-backlash planetary gear
- Gear ratio
 $i = 3$ and 5
- Life-time lubrication

Motor controller CMMP-AS for servo motor



- Complete integration of all components for controller and power section, including USB interface
- Integrated brake chopper
- Integrated EMC filters
- Automatic activation for a brake

Selectable:

- Safety function: safe torque off (STO)/category 4, Performance level e
- Additional digital inputs and outputs

- Bus protocols
 - CANopen
 - DeviceNet®
 - EtherCAT®
 - EtherNet/IP
 - PROFIBUS DP
 - PROFINET

3-dimensional gantries

Key features

Standard components within the handling system

The handling system comprises a number of tried-and-tested standard components from Festo. Different components are used depending on the configuration. You can alter the scope and design of the drive package in the configurator HGO on the "System configuration" page.



Motor controller CMMS-ST for stepper motor



- Complete integration of all components for controller and power section, including RS232 interface
- Integrated brake chopper
- Integrated EMC filters
- Automatic activation for a brake

- Selectable:
- Safety function: safe torque off (STO)/category 3, Performance level d

- Bus protocols
 - CANopen
 - DeviceNet®
 - PROFIBUS DP

Motor controller CMMO-ST for stepper motor



- Separate load and logic supply
- Monitoring of freely defined positions and torque ranges
- Backup file enables seamless device replacement

- Encoder option (closed loop), in other words no step losses, following errors are corrected
- Selectable:
- Safety function: safe torque off (STO)/category 3, Performance level e

- Easy activation via:
 - I/O interface
 - IO-Link or I-Port
 - Modbus TCP

Controller CMXH-ST2 for stepper motor



- The controller controls two servo stepper motors which drive an H-shaped rotating toothed belt. The toothed belt moves a slide, whose position is calculated by the controller from the encoder signals of the motors

- Selectable:
- Safety function: safe torque off (STO)/category 3, Performance level e

- Bus protocols
 - I/O interface
 - CAN interface
 - Ethernet TCP/IP

3-dimensional gantries

Ordering data – Accessories

FESTO

Module/motor combinations



We recommend that the 3-dimensional gantry is operated with the proposed motors from Festo. These precisely match the mechanical system. When using third-party motors, it is essential that the technical limits are observed.

Module	Motor		
	Servo motor	Servo motor	Stepper motor
X-module			
EHMZ-EGC-50-TB-KF	–	EMME-AS-40-M-LV-...	EMMS-ST-42-S-...
EHMZ-EGC-80-TB-KF	EMMS-AS-70-M-LS-...	EMME-AS-60-M-LS-...	EMMS-ST-57-S-...
EHMZ-EGC-120-TB-KF	EMMS-AS-100-M-HS-...	EMME-AS-80-S-LS-...	–
EHMZ-EGC-185-TB-KF	EMMS-AS-140-L-HS-...	–	–
Y-module			
EHMY-...-EGC-50-TB-KF	–	EMME-AS-40-S-LV-...	EMMS-ST-57-M-...
EHMY-...-EGC-80-TB-KF	EMMS-AS-55-S-LS-...	EMME-AS-60-M-LS-...	EMMS-ST-57-S-...
EHMY-...-EGC-120-TB-KF	EMMS-AS-100-S-HS-...	EMME-AS-80-S-LS-...	EMMS-ST-87-S-...
EHMY-...-EGC-125-TB-HD	EMMS-AS-70-S-LS-...	EMME-AS-60-M-LS-...	EMMS-ST-57-S-...
EHMY-...-EGC-160-TB-HD	EMMS-AS-100-S-HS-...	EMME-AS-80-S-LS-...	EMMS-ST-87-S-...
EHMY-...-EGC-185-TB-KF	EMMS-AS-100-M-HS-...	EMME-AS-100-M-HS-...	–
	EMMS-AS-140-S-HS-...		
EHMY-...-EGC-220-TB-HD	EMMS-AS-100-M-HS-...	EMME-AS-100-M-HS-...	–
	EMMS-AS-140-S-HS-...		
Z-module			
EHMZ-DGEA-18-TB-KF	EMMS-AS-55-S-LS-...	EMME-AS-60-M-LS-...	EMMS-ST-57-S-...
EHMZ-DGEA-25-TB-KF	EMMS-AS-70-S-LS-...	EMME-AS-60-M-LS-...	EMMS-ST-57-S-...
EHMZ-DGEA-40-TB-KF	EMMS-AS-100-S-HS-...	EMME-AS-80-M-LS-...	–
EHMZ-EGC-70-BS-KF	EMMS-AS-55-S-LS-...	EMME-AS-60-M-LS-...	EMMS-ST-57-S-...
EHMZ-EGC-80-BS-KF	EMMS-AS-70-S-LS-...	EMME-AS-60-M-LS-...	EMMS-ST-57-S-...
EHMZ-EGC-120-BS-KF	EMMS-AS-100-S-HS-...	EMME-AS-80-S-LS-...	–
EHMZ-EGSL-35-BS-KF	–	EMME-AS-40-S-LV-...	EMMS-ST-28-L-...
EHMZ-EGSL-45-BS-KF	EMMS-AS-40-M-LS-...	EMME-AS-40-S-LV-...	EMMS-ST-57-S-...
EHMZ-EGSL-55-BS-KF	EMMS-AS-55-S-LS-...	EMME-AS-60-M-LS-...	EMMS-ST-57-S-...
EHMZ-EGSL-75-BS-KF	EMMS-AS-70-M-LS-...	EMME-AS-80-S-LS-...	EMMS-ST-87-S-...
XY-module (EXCM, EXCH)			
EXCM-30	–	–	EMMS-ST-42-S-...
EXCM-40	–	–	EMMS-ST-57-M-...
EXCH-40	EMMS-AS-70-M-LS-...	–	–
EXCH-40	EMMS-AS-100-S-HS-...	–	–
EXCH-60	EMMS-AS-100-M-HS-...	–	–
EXCH-60	EMMS-AS-140-S-HV-...	–	–
Z-module (EXCM, EXCH)			
EHMZ-EGSC-BS-KF-25-...-V1	–	–	EMMS-ST-28-L-...
EHMZ-EGSC-BS-KF-32-...-V1	–	–	EMMS-ST-42-S-...
EHMZ-EGSL-45-BS-KF	EMMS-AS-40-M-LS-...	–	–
EHMZ-EGSL-55-BS-KF	EMMS-AS-55-S-LS-...	–	–

3-dimensional gantries

Ordering data – Accessories

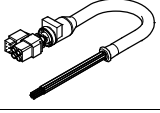
FESTO

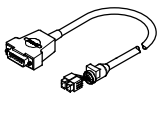
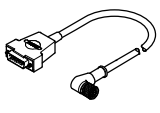
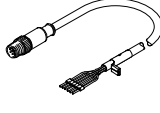
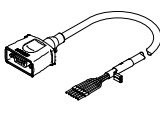
Designation	Description	Cable length	Part no.	Type
For servo motor				
Motor cable¹⁾				
	<ul style="list-style-type: none"> For servo motor EMMS-AS-40-M-LS-.../ EMMS-AS-55-S-LS-... 	5 m	550306	NEBM-T1G8-E-5-Q7N-LE8
		10 m	550307	NEBM-T1G8-E-10-Q7N-LE8
		15 m	550308	NEBM-T1G8-E-15-Q7N-LE8
Motor cable¹⁾				
	<ul style="list-style-type: none"> For servo motor EMMS-AS-70-S-LS-.../ EMMS-AS-70-M-LS-.../EMMS-AS-100-S-HS-.../ EMMS-AS-100-M-HS-.../EMMS-AS-140-S-HS-.../ EMMS-AS-140-L-HS-... 	5 m	550310	NEBM-M23G8-E-5-Q9N-LE8
		10 m	550311	NEBM-M23G8-E-10-Q9N-LE8
		15 m	550312	NEBM-M23G8-E-15-Q9N-LE8
Encoder cable¹⁾				
	<ul style="list-style-type: none"> For servo motor EMMS-AS-40-M-LS-.../ EMMS-AS-55-S-LS-... 	5 m	550314	NEBM-T1G8-E-5-N-S1G15
		10 m	550315	NEBM-T1G8-E-10-N-S1G15
		15 m	550316	NEBM-T1G8-E-15-N-S1G15
Encoder cable¹⁾				
	<ul style="list-style-type: none"> For servo motor EMMS-AS-70-S-LS-.../ EMMS-AS-70-M-LS-.../EMMS-AS-100-S-HS-.../ EMMS-AS-100-M-HS-.../EMMS-AS-140-S-HS-.../ EMMS-AS-140-L-HS-... 	5 m	550318	NEBM-M12W8-E-5-N-S1G15
		10 m	550319	NEBM-M12W8-E-10-N-S1G15
		15 m	550320	NEBM-M12W8-E-15-N-S1G15
For stepper motor				
Motor cable¹⁾				
	<ul style="list-style-type: none"> For stepper motor EMMS-ST-28-L-... 	1.5 m	1449600	NEBM-SM12G8-E-1.5-Q5-LE6
		2.5 m	1449601	NEBM-SM12G8-E-2.5-Q5-LE6
		5 m	1449602	NEBM-SM12G8-E-5-Q5-LE6
		7 m	1449603	NEBM-SM12G8-E-7-Q5-LE6
		10 m	1449604	NEBM-SM12G8-E-10-Q5-LE6
Motor cable¹⁾				
	<ul style="list-style-type: none"> For stepper motor EMMS-ST-42-S-.../EMMS-ST-57-M-... 	2.5 m	1450369	NEBM-S1G9-E-2.5-Q5-LE6
		5 m	1450370	NEBM-S1G9-E-5-Q5-LE6

1) Cables especially suitable for the motor controller and motor.
Degree of protection to IP65 (in assembled state)

3-dimensional gantries

Ordering data – Accessories

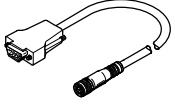
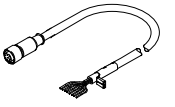
Designation	Description	Cable length	Part no.	Type
For stepper motor				
Encoder cable ¹⁾				
	<ul style="list-style-type: none"> For stepper motor EMMS-ST-28-L-.../EMMS-ST-42-S-.../EMMS-ST-57-M-... and motor controller CMMS-ST 	5 m	550748	NEBM-M12G8-E-5-S1G9
		10 m	550749	NEBM-M12G8-E-10-S1G9
		15 m	550750	NEBM-M12G8-E-15-S1G9
Encoder cable ¹⁾				
	<ul style="list-style-type: none"> For stepper motor EMMS-ST-28-L-... and motor controller CMMO-ST 	2.5 m	1451587	NEBM-M12G8-E-2.5-LE8
		5 m	1451588	NEBM-M12G8-E-5-LE8

1) Cables especially suitable for the motor controller and motor.
Degree of protection to IP65 (in assembled state)

Possible cable and tube lengths

- Cables and tubing are selected so that the length specified when ordering will be the minimum connection length from the energy chain output.
- Cables and tubing are only available in fixed lengths as stated in the table below. This can mean that the plug connectors of the different cables do not end at the same point.

Length	1 m	2 m	5 m	7 m	10 m
Motor cable	–	■	■	■	■
Encoder cable	–	■	■	■	■
Multi-pin plug connecting cable	–	■	■	■	■
Tubing (for DHMZ only)	■	■	■	–	–

3-dimensional gantries



Ordering data – Accessories



Standard components within the handling system

The handling system comprises a number of tried-and-tested standard components from Festo. Different components are used depending on the configuration. You can alter the scope and design of the accessories in the configurator HGO on the "System configuration" page.

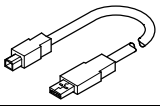
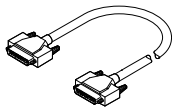
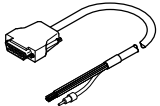
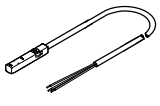

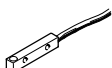
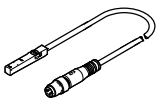
Designation	Description	Cable length	Part no.	Type	
Programming cable					
	<ul style="list-style-type: none"> High-speed USB 2.0 connecting cable For controller CMMP-AS 	1.8 m	1501332	NEBC-U1G4-K-1.8-N-U2G4	
	<ul style="list-style-type: none"> For controller CMMS-ST 	2 m	160786	PS1-ZK11-NULLMODEM-2,0M	
Control cable (for I/O interface to any controller)					
	<ul style="list-style-type: none"> For controller CMMP-AS, CMMS-ST 	2.5 m	552254	NEBC-S1G25-K-2.5-N-LE26	
	<ul style="list-style-type: none"> For controller CMMO-ST 	3.2 m	8001373	NEBC-S1G25-K-3.2-N-LE25	
	<ul style="list-style-type: none"> For controller CMXH-ST2 	2.5 m	2052917	NEBC-S1H15-E-2.5-N-LE15	
Proximity sensor (inductive) for sensing the position of the slide on the X-/Z-axis					
	Cable with open end				
	<ul style="list-style-type: none"> For toothed belt axis EGC-TB 	PNP, N/C contact	7.5 m	551391	SIES-8M-PO-24V-K-7,5-OE
	<ul style="list-style-type: none"> For spindle axis EGC-BS 	PNP, N/O contact	7.5 m	551386	SIES-8M-PS-24V-K-7,5-OE
	<ul style="list-style-type: none"> For mini slide EGSL 	NPN, N/C contact	7.5 m	551401	SIES-8M-NO-24V-K-7,5-OE
<ul style="list-style-type: none"> For direct voltage 	NPN, N/O contact	7.5 m	551396	SIES-8M-NS-24V-K-7,5-OE	
Included if "Festo sensor package" is selected:					
	<ul style="list-style-type: none"> For EGC: 2 pieces For EGSL: 1 piece 				
Proximity sensor for sensing the position of the slide on the X-axis					
	<ul style="list-style-type: none"> For EXCM-40, EXCH-40, EXCH-60 	N/O contact	–	150491	SIES-V3B-PS-S-L
	<ul style="list-style-type: none"> For EXCM-40, EXCH-40, EXCH-60 	N/C contact	–	174552	SIES-Q8B-PO-K-L
Proximity sensor (inductive) for sensing the position of the slide on the Y-axis					
	Cable with plug				
	<ul style="list-style-type: none"> For toothed belt axis EGC-TB, 	PNP, N/C contact	0.3	551392	SIES-8M-PO-24V-K-0,3-M8D
	<ul style="list-style-type: none"> EGC-HD-TB 	PNP, N/C contact	2.5	551393	SIES-8M-PO-24V-K-2,5-M8D
	<ul style="list-style-type: none"> For direct voltage 	PNP, N/O contact	0.3	551387	SIES-8M-PS-24V-K-0,3-M8D
	<ul style="list-style-type: none"> Included if "Festo sensor package" is selected: 	PNP, N/O contact	2.5	551388	SIES-8M-PS-24V-K-2,5-M8D
	<ul style="list-style-type: none"> 2 pieces 	NPN, N/C contact	0.3	551402	SIES-8M-NO-24V-K-0,3-M8D
		NPN, N/C contact	2.5	551403	SIES-8M-NO-24V-K-2,5-M8D
		NPN, N/O contact	0.3	551397	SIES-8M-NS-24V-K-0,3-M8D
	NPN, N/O contact	2.5	551398	SIES-8M-NS-24V-K-2,5-M8D	

3-dimensional gantries

Ordering data – Accessories

FESTO

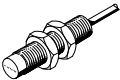
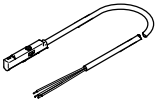

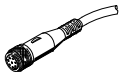
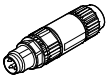
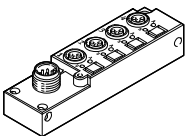
Designation	Description	Cable length	Part no.	Type
Proximity sensor (inductive) for sensing the position of the slide on the Z-axis				
	Cable with open end			
	• For cantilever axis DGEA	PNP, N/C contact	2.5 m	150398 SIEN-M8NB-PO-K-L
	• For direct voltage	PNP, N/O contact	2.5 m	150394 SIEN-M8NB-PS-K-L
	Included if "Festo sensor package" is selected:	NPN, N/C contact	2.5 m	150396 SIEN-M8NB-NO-K-L
• 2 pieces	NPN, N/O contact	2.5 m	150392 SIEN-M8NB-NS-K-L	
Proximity sensor (magneto-resistive) for sensing the position of the slide on the Z-axis				
	Cable with open end			
	• For mini slide DGSL	PNP, N/O contact	2.5 m	551373 SMT-10M-PS-24V-E-2,5-L-OE
• For direct voltage	NPN, N/O contact	2.5 m	551377 SMT-10M-NS-24V-E-2,5-L-OE	
Included if "Festo sensor package" is selected:				
• 2 pieces				

Designation	Description	Cable length	Part no.	Type
Plug socket with cable				
	• Connection between multi-pin plug distributor and control cabinet	5 m	525618	SIM-M12-8GD-5-PU
		10 m	570008	SIM-M12-8GD-10-PU
Plug				
	• For connection to the multi-pin plug distributor	–	562024	NECU-S-M8G3-HX
Multi-pin plug distributor				
	• With the help of the multi-pin plug distributor, all electrical signals such as for end-position sensing can be transferred Selectable: – 4 individual connections – 6 individual connections	–	574586	NEDU-L4R1-M8G3L-M12G8
			574587	NEDU-L6R1-M8G3L-M12G8

3-dimensional gantries

Ordering data – Accessories

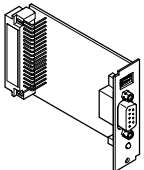
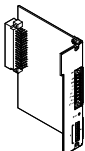
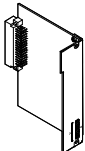
FESTO

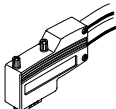
Designation	Description	Part no.	Type
Interface			
	For additional I/Os	567855	CAMC-D-8E8A
	For DeviceNet®	547451	CAMC-DN
	For EtherCAT®	567856	CAMC-EC
	For EtherNet/IP	1911917	CAMC-F-EP
	For PROFINET RT	1911916	CAMC-F-PN
	For PROFIBUS DP	547450	CAMC-PB
Safety module			
	<ul style="list-style-type: none"> For safe torque off (STO) 	1501330	CAMC-G-S1
Switch module			
	<ul style="list-style-type: none"> If the safety module CAMC-G-S1 is not used, the switch module is absolutely essential for operating the motor controller CMMP-AS-...-M3 	1501329	CAMC-DS-M1
Bus connection			
	<ul style="list-style-type: none"> For DeviceNet interface 	525635	FBSD-KL-2X5POL
Plug			
	<ul style="list-style-type: none"> For CANopen interface 	533783	FBS-SUB-9-WS-CO-K
	<ul style="list-style-type: none"> For PROFIBUS interface 	533780	FBS-SUB-9-WS-PB-K

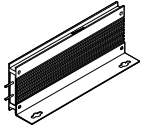
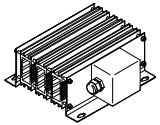
Designation	Description	Part no.	Type
Braking resistor			
	<ul style="list-style-type: none"> For EXCH-40 Essential for a vertical mounting position 	2882342	CACR-LE2-50-W500
	<ul style="list-style-type: none"> For EXCH-60 Essential for a vertical mounting position 	2882343	CACR-KL2-40-W2000

3-dimensional gantries

Ordering data – Accessories

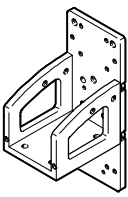
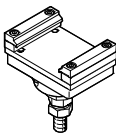
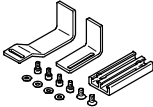
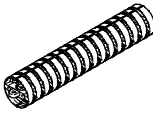
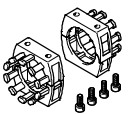
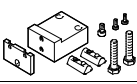
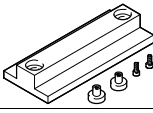
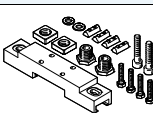
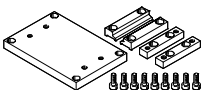
Designation	Description	Part no.	Type
Mounting kit			
	<ul style="list-style-type: none"> Mounting kit for the energy chain and a Z-axis, like EGSL, DGSL 	EXCM-30	4070088 EAHT-E9-FB-3D-30
Adjusting kit			
	<ul style="list-style-type: none"> Height-adjustable mounting kit 	EXCM-30	4070088 EADC-E11-30
Sensor mounting			
	<ul style="list-style-type: none"> For homing in combination with third-party motors 	EXCM-30	4070088 EAPR-E11-30
Energy chain			
	<ul style="list-style-type: none"> As a cable guide for the Z-axis 	EXCM-30	8059999 EADH-U-3D-30
			8060324 EADH-U-3D-40
Connector set			
	<ul style="list-style-type: none"> Holder for mounting the energy chain 	EXCM-30	8060325 EAHT-AE-3D-30
			8060326 EAHT-AE-3D-40
Sensor mounting			
	<ul style="list-style-type: none"> For mounting the proximity sensors SIES-Q8B, SIES-V3B on the X-axis 	EXCM-40, EXCH-40	2536353 EAPR-E12-40
		EXCH-60	2478805 EAPR-E12-60
Adjusting tool			
	<ul style="list-style-type: none"> For aligning and checking the levelness of the planar surface gantry 		3197697 EADT-W-E12
Adjusting kit			
	<ul style="list-style-type: none"> Used to mount the handling system on the bearing surface Can be used to easily compensate for any unevenness in the bearing surface 	EHMY-...-EGC-50-TB-KF	8047565 EADC-E15-50-E7
		EHMY-...-EGC-80-TB-KF	8047566 EADC-E15-80-E7
		EHMY-...-EGC-120-TB-KF	8047567 EADC-E15-120-E7
		EHMY-...-EGC-185-TB-KF	8047568 EADC-E15-185-E7
Profile mounting			
	<ul style="list-style-type: none"> Used to mount the handling system on the bearing surface It is not height-adjustable 		-

3-dimensional gantries

Programming aid

Easy programming with

FCT software – Festo Configuration Tool

Software platform for electric drives from Festo

- All drives in a system can be managed and saved in a common project
- Project and data management for all supported types of equipment
- Easy to use thanks to graphically supported parameter entry
- Universal mode of operation for all drives
- Work offline at your desk or online at the machine

