

Feed separators HPV



Feed separators HPV

Key features at a glance

Separation of workpieces in the supply process

Previously

- Required at least 2 drives, 2 valves and 4 proximity sensors
- Extensive programming required

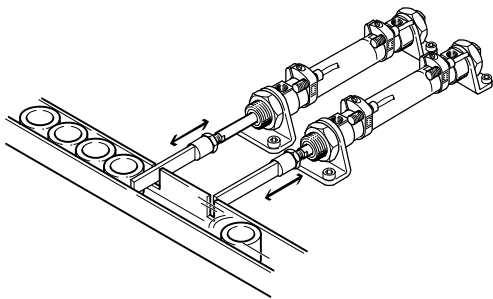

Today

- One unit (1 drive, 1 valve and 2 proximity sensors)
- More cost-effective
- Reliable
- No programming required

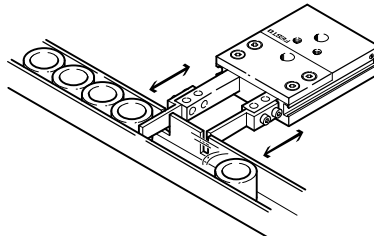

High functionality

- 1 Corrosion-resistant thanks to stainless steel plungers
- 2 Optimum, accurate combination options with centring sleeves
- 3 Supply ports optionally at top or rear
- 4 Supports proximity sensors that can be integrated in the housing (SME/SMT-8)

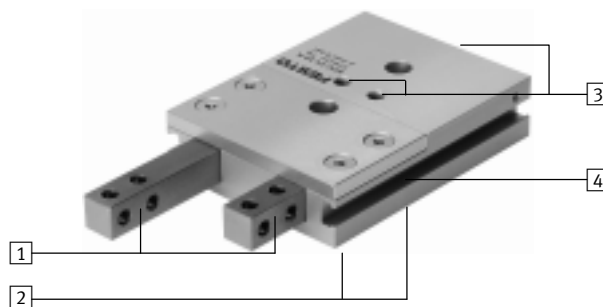

Note

An integrated mechanical locking mechanism between the two plungers ensures that one piston cannot retract until the other has advanced.

Both plungers are briefly extended upon changeover and the part to be separated is surrounded.

Function principle

Plunger A is retracted. The locking mechanism locks plunger B.

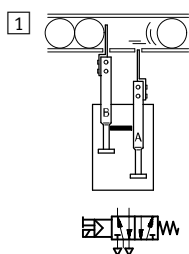

Plunger A advances.

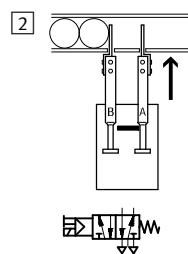

Plunger B cannot retract from the locking mechanism until plunger A is fully advanced.

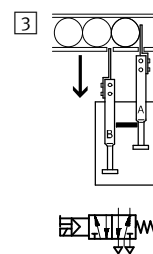

Plunger B advances.

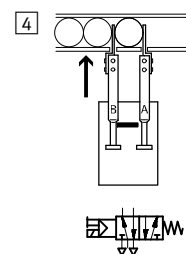

Plunger A cannot retract from the locking mechanism until plunger B is fully advanced.

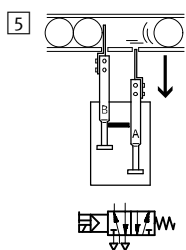

Feed separators HPV

Peripherals overview and type codes

Peripherals overview

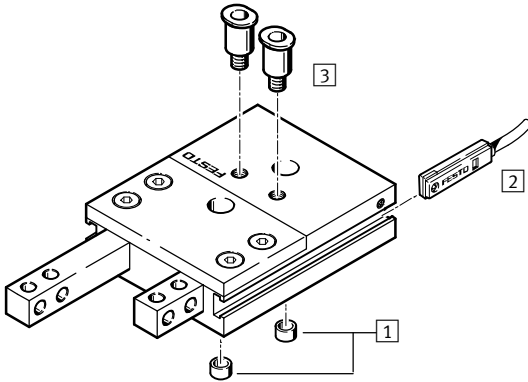

Accessories			
	Description	→ Page/Internet	
1	Centring sleeve, connecting sleeve	For centring when mounting	9
2	Proximity sensor	For position sensing, sensor is integrated in sensor slot	9
3	QS push-in fitting	For connecting compressed air tubing with standard external diameter	qs

Type codes



Type

Double-acting

HPV | Feed separator

Size [mm]

Stroke [mm]

Position sensing

A | Via proximity sensor

Feed separators HPV

Technical data

FESTO

Function

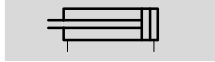

- Ø - Size
10 ... 22

- l - Stroke length
20 ... 60 mm

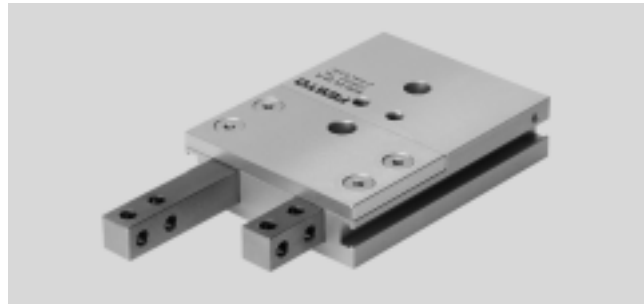

General technical data			
Size	10	14	22
Pneumatic connection	M5/M3	M5/M5	
Mode of operation	Double-acting		
Operating medium	Compressed air in accordance with ISO 8573-1:2010 [7:4:4]		
Note on operating/pilot medium	Operation with lubricated medium possible (in which case lubricated operation will always be required)		
Design	Twin piston		
	Piston rod		
	Locking mechanism		
	Non-rotating		
Protection against torsion/guide	Square plungers		
Max. interchangeability [mm]	0.3		
Cushioning	None		
Position sensing	Via proximity sensor		
Type of mounting	Via through-holes		
	Via female thread		
Mounting position	Any		

Operating and environmental conditions			
Operating pressure [bar]	3 ... 8		
Ambient temperature [°C]	+5 ... +60		
Protection class	IP40		
Corrosion resistance class CRC ¹⁾	2		

1) Corrosion resistance class 2 to Festo standard 940 070

Components subject to moderate corrosion stress. Externally visible parts with primarily decorative surface requirements which are in direct contact with a normal industrial environment or media such as coolants or lubricating agents.

Forces [N]			
Size	10	14	22
Theoretical force at 6 bar Advancing	45	90	225
Theoretical force at 6 bar Retracting	35	75	180

Weights [g]					
Size	10		14		22
Stroke	10	20	40	30	60
Product weight	135	290	460	950	1,500

Feed separators HPV

Technical data

Materials

Sectional view

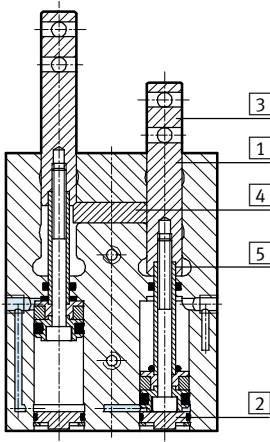

Feed separator

1	Body	Wrought aluminium alloy (with CompCoat)
2	End cover	High-alloy steel
3	Plunger	High-alloy steel
4	Locking mechanism	Case-hardened steel
5	Piston rod	High-alloy steel
-	Seals	Nitrile rubber
Note on materials		Copper and PTFE
		Conforms to RoHS

Note

The plunger slideways in the housing are determined by the appropriate fit selected and cannot be adjusted. The

necessary basic lubrication is performed during assembly. We recommend that the feed separator

be re-lubricated after 2 million cycles.

Cycle times [ms] without add-on plunger separators at 6 bar (unrestricted)

Half the cycle time:

Number 1 ... 3

Cycle time:

Number 1 ... 5

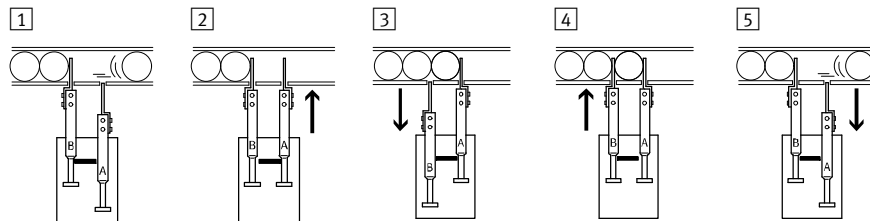

Size	10	14	22		
Stroke	10	20	30	40	60
Half the cycle time	26.5	111.5	234.2	152.4	398.1
Cycle time	52.5	223	468.4	304.8	796.1

Max. permissible weight [g] of add-on plunger separators for unrestricted operation

Size	10	14	22
Add-on plunger separators ¹⁾	56	150	395

1) If the max. permissible weights of the add-on plunger separators are exceeded, the retracting and advancing times must be adapted in accordance with the table below using one-way flow control valves. Failure to do so may result in components of the feed separator being damaged.

Retracting and advancing times [s] with add-on plunger separators as a function of the load [g] of the fingers

Size	10	14	22			
Stroke	10	20	30	40	60	
Applied load	100 g	0.03	-	-	-	-
	200 g	0.04	0.03	0.05	-	-
	300 g	0.05	0.04	0.08	-	-
	400 g	0.06	0.05	0.11	0.24	0.48
	500 g	-	0.07	0.13	0.3	0.6
	600 g	-	-	-	0.36	0.72
	700 g	-	-	-	0.42	0.84
	800 g	-	-	-	0.48	0.96

Feed separators HPV

Technical data

FESTO

Permissible characteristic static load values at the plungers

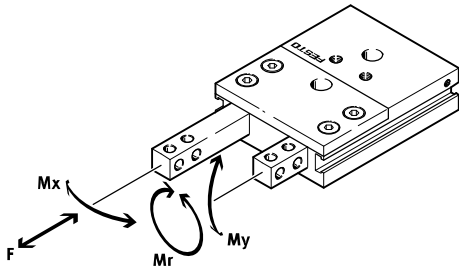

Size	10	14	22	
Force F	[N]	75	100	180
Torque M_x	[Nm]	3	5	9
Torque M_y	[Nm]	3	5	9
Torque M_r	[Nm]	3	5	9

Plunger backlash

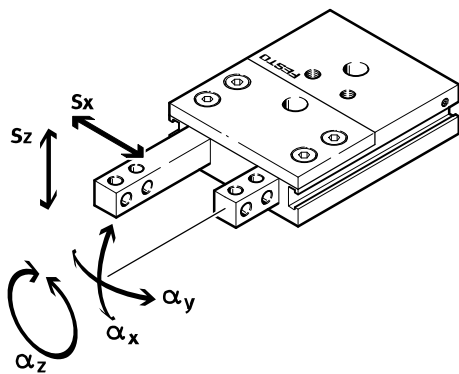

Size	10	14	22			
Stroke	10	20	40	30	60	
S_x	[mm]	0.05	0.05	0.05	0.05	0.05
S_z	[mm]	0.03	0.03	0.03	0.03	0.03
α_x	[°]	0.12	0.12	0.07	0.06	0.04
α_y	[°]	0.2	0.2	0.12	0.11	0.07
α_z	[°]	0.262	0.175	0.175	0.12	0.12

Minimum clearances

To prevent malfunctioning of the proximity sensors, the feed separators must comply with the minimum clearances specified in the table.

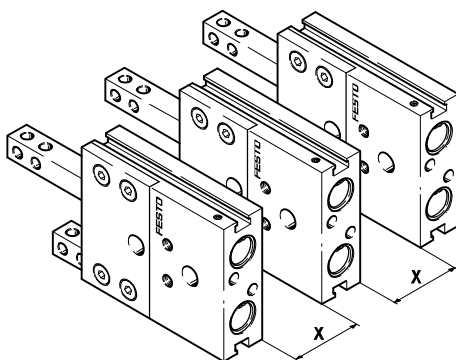

Size	10	14	22	
For SME-8-...	[mm]	60	59	73
For SMT-8-...-B	[mm]	60	54	69

Feed separators HPV

Technical data

Projection of proximity sensors

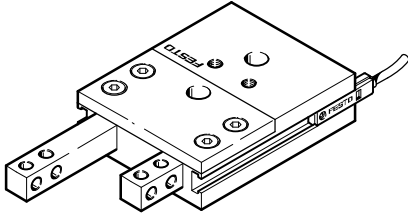

Size		10	14	22
For SME-8-...	[mm]	14		
For SMT-8-...	[mm]	22		

Mounting options

Only the mounting surface on the underside (opposite the supply ports) may be used.

From above via through-holes

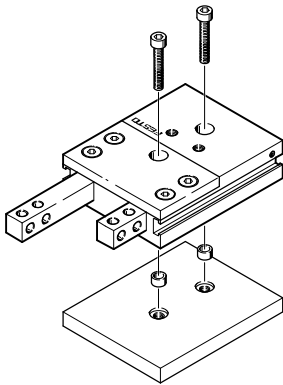

Size	10	14	22
Screw	M3	M4	M6
Permitted tightening torque [Nm]	1.2	2.9	9.9

From below via female threads

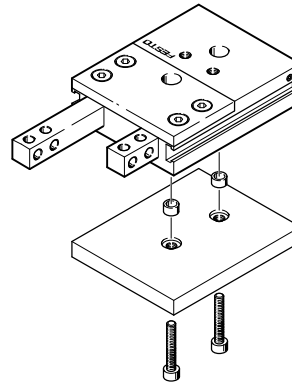

Size	10	14	22
Screw	M4	M5	M8
Permitted tightening torque [Nm]	2.9	5.9	24

Surface finish and positional accuracy of bearing surface

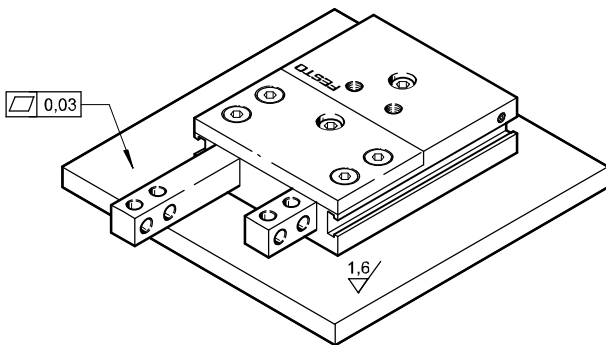

Feed separators HPV

Technical data

FESTO

Dimensions

Download CAD data → www.festo.com

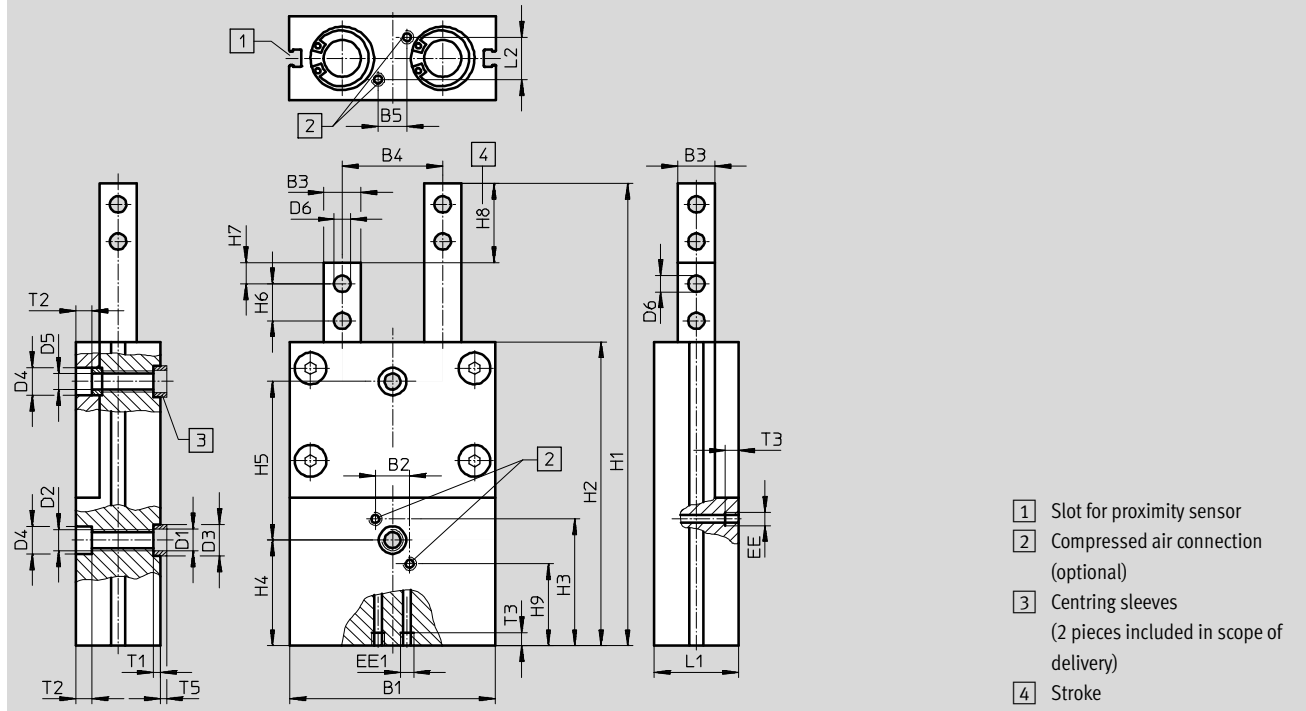

Type	B1	B2	B3	B4	B5	D1	D2	D3	D4	D5	D6	EE	EE1	H1
			±0.02	±0.05		∅		H8/h7 ∅	H13 ∅	H13 ∅	H13 ∅			
HPV-10-10-A	47	6	7	20	7	5.3	M4	7	6	–	3.2	M5	M3	78
HPV-14-20-A	60	12	10	30	10	5.3	M5	7	7.4	–	4.2	M5	M5	119
HPV-14-40-A	60	12	10	30	10	5.3	M5	7	7.4	–	4.2	M5	M5	189
HPV-22-30-A	78	13	14	38	11	8.4	M8	12	10.4	6.2	6.2	M5	M5	175
HPV-22-60-A	78	13	14	38	11	8.4	M8	12	10.4	6.2	6.2	M5	M5	280

Type	H2	H3	H4	H5 ¹⁾	H6	H7	H8	H9	L1	L2	T1	T2	T3	T5
			±0.1		±0.2	±0.1	±0.5				+0.1		min.	–0.3
HPV-10-10-A	53	24.5	16	30	7	4	10	7.5	18	9	1.6	3.1	4	1.4
HPV-14-20-A	79	36	20	30	10	5	20	36	19	7	1.6	4.6	5	1.4
HPV-14-40-A	129	56	20	60	10	5	40	56	19	7	1.6	4.6	5	1.4
HPV-22-30-A	115	48	40	60	14	8	30	48	32	16	2.6	6.1	5	2.4
HPV-22-60-A	190	78	40	120	14	8	60	78	32	16	2.6	6.1	5	2.4

1) Tolerance for centring hole ±0.02
 Tolerance for threaded and through-hole ±0.1

Ordering data			
Size	Stroke [mm]	Part No.	Type
10	10	550908	HPV-10-10-A
14	20	529351	HPV-14-20-A
	40	529352	HPV-14-40-A
22	30	529353	HPV-22-30-A
	60	529354	HPV-22-60-A

Feed separators HPV

Accessories



FESTO

Ordering data		Technical data → Internet: zbh		
For size	Part No.	Type	PU ¹⁾	
Centring sleeve ZBH				
	10, 14	186717	ZBH-7	10
	22	189653	ZBH-12	10

1) Packaging unit quantity

Ordering data – Proximity sensors for T-slot, magneto-resistive					Technical data → Internet: smt	
Type of mounting	Switch output	Electrical connection	Cable length [m]	Part No.	Type	
N/O contact						
	Insertable in the slot from above, flush with cylinder profile, short design	PNP	Cable, 3-wire	2.5	574335	SMT-8M-A-PS-24V-E-2,5-OE
			Plug M8x1, 3-pin	0.3	574334	SMT-8M-A-PS-24V-E-0,3-M8D

Ordering data – Proximity sensors for T-slot, magnetic reed					Technical data → Internet: sme	
Type of mounting	Switch output	Electrical connection	Cable length [m]	Part No.	Type	
N/O contact						
	Insertable in the slot lengthwise, flush with the cylinder profile	Via contact	Cable, 3-wire	2.5	150855	SME-8-K-LED-24
			Plug M8x1, 3-pin	0.3	150857	SME-8-S-LED-24

Ordering data – Connecting cables				Technical data → Internet: nebu	
Electrical connection, left	Electrical connection, right	Cable length [m]	Part No.	Type	
	Straight socket, M8x1, 3-pin	Cable, open end, 3-wire	2.5	541333	NEBU-M8G3-K-2.5-LE3
			5	541334	NEBU-M8G3-K-5-LE3
	Straight socket, M12x1, 5-pin	Cable, open end, 3-wire	2.5	541363	NEBU-M12G5-K-2.5-LE3
			5	541364	NEBU-M12G5-K-5-LE3
	Angled socket, M8x1, 3-pin	Cable, open end, 3-wire	2.5	541338	NEBU-M8W3-K-2.5-LE3
			5	541341	NEBU-M8W3-K-5-LE3
	Angled socket, M12x1, 5-pin	Cable, open end, 3-wire	2.5	541367	NEBU-M12W5-K-2.5-LE3
			5	541370	NEBU-M12W5-K-5-LE3

Ordering data – Slot covers			Part No.	Type
Mounting	Length [m]			
	Inserted from above	2 x 0.5	151680	ABP-5-S

Ordering data – One-way flow control valves				Technical data → Internet: gra-m5-qs	
Connection	Material	Part No.		Type	
		Thread	For tubing outer Ø		
	Metal design	M5	3	193137	GRLA-M5-QS-3-D
			4	193138	GRLA-M5-QS-4-D
			6	193139	GRLA-M5-QS-6-D