

Heavy-duty three-point grippers HGDT

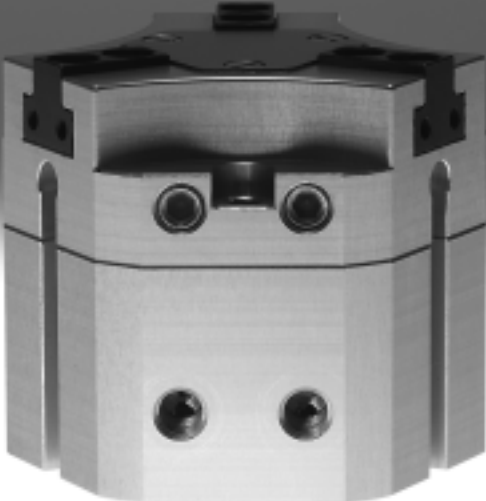

# Heavy-duty three-point grippers HGDT

Key features

## At a glance

The force generated by the linear motion is translated into the gripper jaw movement via a force-guided triple wedge mechanism. This also guarantees synchronous movement of the gripper jaw. The virtually backlash-free slideway is realised using ground-in gripper jaws.

A wide range of uses:

- Double-acting gripper
- Compression springs for supplementing or retaining gripper forces, or for use as a single-acting gripper with only one compressed air connection
- Suitable for external and internal gripping

Sealing air connection:

Compressed air flows past the gripper jaw when sealing air (max. 0.5 bar) is connected.

This prevents particles and soluble oil, etc. from entering the gripper jaw guides.

There are two variants available:

Standard – HGDT...

Stroke per gripper jaw:

3 ... 10 mm

Total gripping force:

207 ... 1728 N

High force – HGDT...-F

Stroke per gripper jaw:

1.5 ... 5 mm

Total gripping force:

411 ... 3372 N

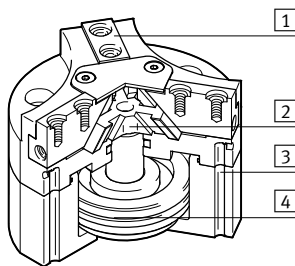

- 1 Gripper jaw
- 2 Triple wedge mechanism
- 3 Slot for proximity sensor
- 4 Piston with magnet

-  - Note

Design software for gripper selection  
 → [www.festo.com](http://www.festo.com)

## Wide range of supply ports

Direct from the front

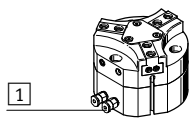

- 1 Supply ports
- 2 O-rings

Via adapter plate from underneath

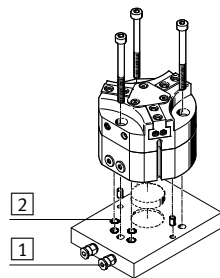

## Mounting options

Direct mounting from above

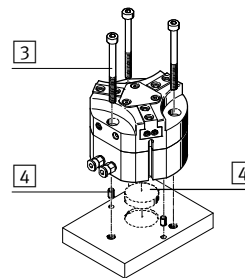

- 3 Mounting screws
- 4 Centring pins or centring disc

Via adapter plate from underneath

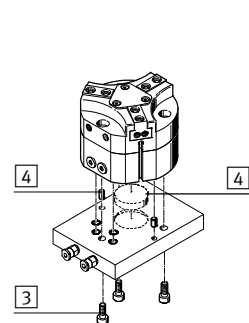

-  - Note

These grippers are not suitable or are of limited suitability for the following application examples:

Not suitable for:

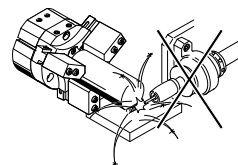

- Welding splashes

Of limited suitability for:

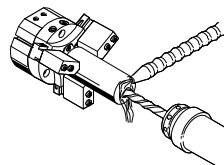

- Machining with sealing air possible
- Aggressive media only possible after consultation with Festo

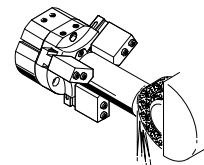

# Heavy-duty three-point grippers HGDT

Peripherals overview and type codes

Peripherals overview

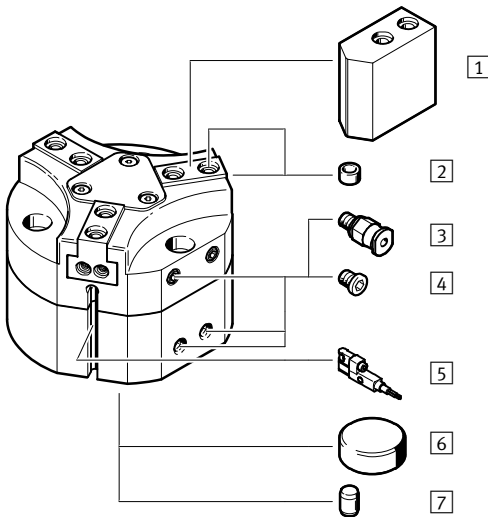

System product for handling and assembly technology

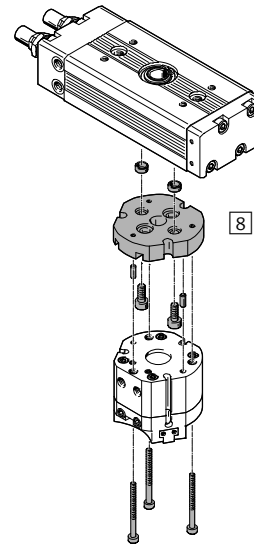

Accessories			
Type	Description	→ Page/Internet	
1	Gripper jaw blank BUB-HGDT	Blank specially matched to the gripper jaws for custom production of gripper fingers	17
2	Centring sleeve ZBH	For centring gripper jaw blanks/gripper fingers on the gripper jaws	18
3	Push-in fitting QS	For connecting compressed air tubing with standard O.D.	qs
4	Blanking plug B	For sealing supply ports when using ports at the front	18
5	Proximity sensor SMT-10/SMT-10G	For sensing the piston position, 3 slots available	18
6	Central mounting SLZZ	For centring the gripper during mounting	18
7	Dowel pin	For centring the gripper during mounting	-
8	Adapter kit DHAA, HAPG	Drive/gripper connections	15

Type codes

HGDT – 25 – A – F – G1

Type	
HGDT	Three-point gripper
Size	
25	
Position sensing	
A	Via proximity sensor
Force variant	
F	High force
Gripping force backup	
G1	Opening
G2	Closing



# Heavy-duty three-point grippers HGDT

Technical data

FESTO

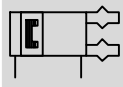
Function  
Double-acting  
HGDT-...-A



 Size  
25 ... 63  
 Stroke  
1.5 ... 10 mm



Single-acting or  
with gripping force retention ...  
... opening HGDT-...-G1



... closing HGDT-...-G2



General technical data						
Size		25	35	40	50	63
Constructional design		Wedge-shaped actuator				
		Force-guided motion sequence				
Mode of operation		Double-acting				
Gripper function		3-point				
Number of gripper jaws		3				
Max. load per external gripper finger <sup>1)</sup>	[g]	10	30	70	160	250
Stroke per gripper jaw	HGDT-...-A [mm]	3	4	6	8	10
	HGDT-...-A-F [mm]	1.5	2	3	4	5
Pneumatic connection		M5	M5	M5	G1/8	G1/8
Pneumatic connection for sealing air		M5				
Repetition accuracy <sup>2)</sup>	[mm]	≤0.03				
Max. operating frequency	[Hz]	≤4				
Position sensing		Via proximity sensor				
Type of mounting		Via through-hole, locating pin or centring disc				
		Via female thread, locating pin or centring disc				
Mounting position		Any				

1) Valid for unthrottled operation

2) Concentric to the central shaft

Operating and environmental conditions		
Min. operating pressure	HGDT-... [bar]	3
	HGDT-...-G... [bar]	4
Max. operating pressure	[bar]	8
Sealing air operating pressure	[bar]	0 ... 0.5
Operating medium		Compressed air in accordance with ISO 8573-1:2010 [7:4:4]
Note on operating/pilot medium		Operation with lubricated medium possible (in which case lubricated operation will always be required)
Ambient temperature <sup>1)</sup>	[°C]	+5 ... +60
Corrosion resistance class CRC <sup>2)</sup>		2

1) Note operating range of proximity sensors

2) CRC2: Corrosion resistance class to Festo standard 940 070

Components with medium corrosion exposure. Externally visible components with significant decorative function in direct contact with normal industrial atmosphere or media such as coolants and lubricants.

# Heavy-duty three-point grippers HGDT

Technical data

FESTO

Weight [g]					
Size	25	35	40	50	63
HGDT-...	185	307	712	1104	1873
HGDT-...-G1	203	337	840	1592	2469
HGDT-...-G2	203	385	837	1440	2543

## Materials

Sectional view

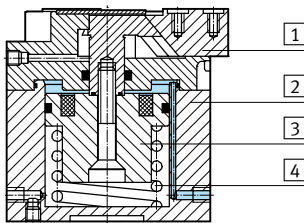

Three-point gripper		
1	Gripper jaw	Hardened steel
2	Housing	Smooth anodised aluminium
3	Piston	Anodised aluminium
4	Spring	Spring steel
-	Seals	Nitrile rubber
-	Note on materials	Free of copper and PTFE RoHS-compliant

## Characteristic load values at the gripper jaws

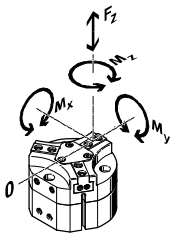

The indicated permissible forces and torques apply to a single gripper jaw. They include the lever arm, additional applied loads due to the workpiece or external gripper fingers and acceleration forces occurring during movement.

The zero coordinate line (gripper finger point of rotation) must be taken into consideration for the calculation of torques.

Size		25	35	40	50	63
Max. permissible force $F_z$	[N]	350	400	800	1500	2500
Max. permissible torque $M_x$	[Nm]	7	15	30	50	80
Max. permissible torque $M_y$	[Nm]	10	10	20	30	50
Max. permissible torque $M_z$	[Nm]	5	10	25	40	60

## Moment of inertia [kgcm<sup>2</sup>]

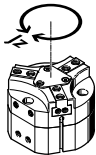

Mass moment of inertia of the three-point gripper in relation to the central axis, without external gripper fingers, without load.

Size		25	35	40	50	63
HGDT-...		0.48	1.17	4.37	11.05	28.77
HGDT-...-G1		0.5	1.37	5.59	15.33	42.44
HGDT-...-G2		0.5	1.37	5.23	13.92	39.50

# Heavy-duty three-point grippers HGDT

Technical data

FESTO

## Opening and closing times [ms] at 6 bar

Without external gripper fingers

With external gripper fingers

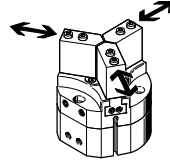
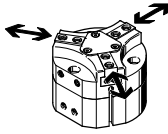

The indicated opening and closing times [ms] have been measured at room temperature at an operating pressure of 6 bar with horizontally mounted gripper without additional

gripper fingers. The grippers must be throttled for greater loads [g]. Opening and closing times must then be adjusted accordingly.

Size			25	35	40	50	63
<b>Without external gripper fingers</b>							
Standard	HGDT-...-A	opening	28	40	62	85	152
		closing	25	45	59	75	142
	HGDT-...-A-G1	opening	27	32	58	32	48
		closing	33	56	160	146	246
	HGDT-...-A-G2	opening	33	46	111	61	159
		closing	25	35	87	70	107
High force	HGDT-...-A-F	opening	20	43	48	96	163
		closing	30	39	49	83	162
	HGDT-...-A-F-G1	opening	25	29	63	31	70
		closing	61	67	190	170	299
	HGDT-...-A-F-G2	opening	38	53	117	88	169
		closing	33	36	104	65	128
<b>With external gripper fingers (as a function of the load per gripper finger)</b>							
HGDT-...		20 g	80	–	–	–	–
		30 g	100	130	–	–	–
		70 g	150	200	115	–	–
		100 g	180	240	140	–	–
		150 g	220	290	170	–	–
		200 g	–	335	200	190	–
		250 g	–	–	220	210	190
		300 g	–	–	–	230	200
		400 g	–	–	–	270	230
		500 g	–	–	–	–	260

## Gripping force [N] at 6 bar

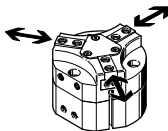

Size			25	35	40	50	63
<b>Gripping force per gripper jaw</b>							
Standard	HGDT-...-A	opening	82	164	229	347	576
		closing	69	152	206	307	551
High force	HGDT-...-A-F	opening	180	294	367	740	1124
		closing	148	274	330	625	864
<b>Total gripping force</b>							
Standard	HGDT-...-A	opening	246	492	687	1041	1728
		closing	207	456	618	921	1653
High force	HGDT-...-A-F	opening	540	882	1101	2220	3372
		closing	444	822	990	1875	2592
<b>Total gripping force with spring support (gripping force retention)</b>							
Standard	HGDT-...-A	opening	286	555	814	1159	2186
		closing	228	547	712	1052	2172
High force	HGDT-...-A-F	opening	708	1254	1629	2800	4456
		closing	612	1194	1518	2655	4338

# Heavy-duty three-point grippers HGDT

Technical data

## Standard – HGDT-...

### Gripping force $F_{Grip}$ per gripper jaw as a function of operating pressure and lever arm $x$

The gripping forces as a function of operating pressure and lever arm can be determined from the following graphs.

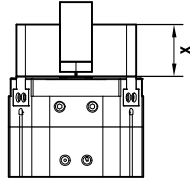

## External gripping (closing)

HGDT-25-A

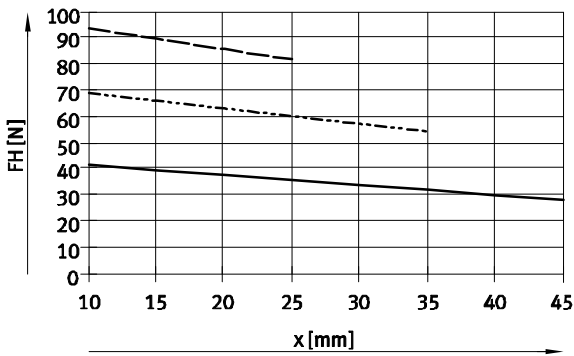

HGDT-35-A

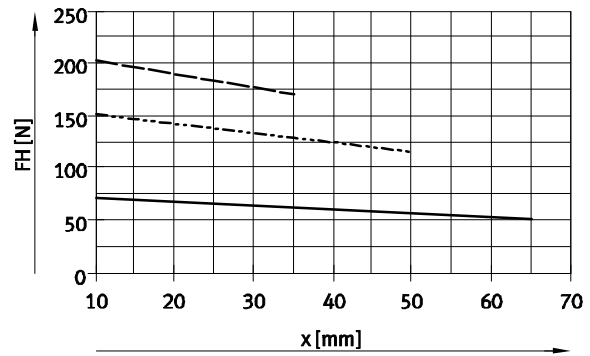

HGDT-40-A

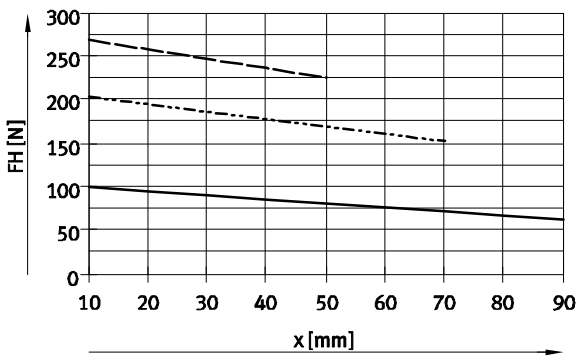

HGDT-50-A

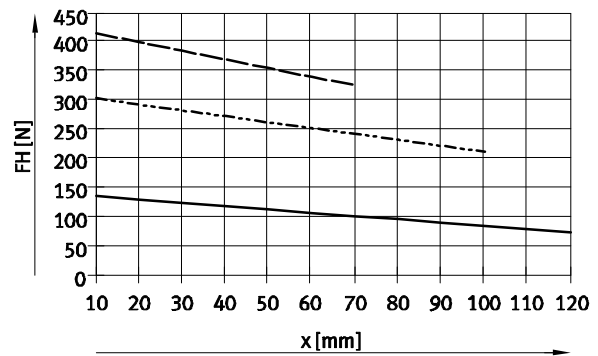

HGDT-63-A

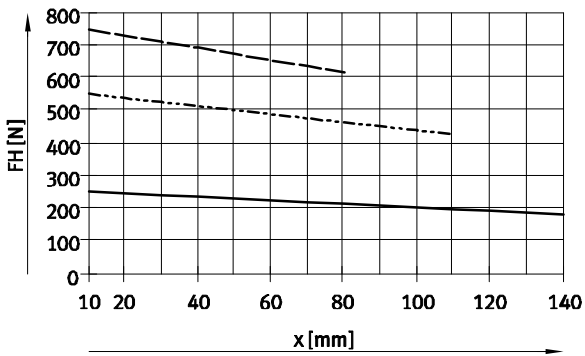

- 3 bar
- - - 6 bar
- 8 bar

# Heavy-duty three-point grippers HGDT

Technical data

## Standard – HGDT-...

### Gripping force $F_{Grip}$ per gripper jaw as a function of operating pressure and lever arm $x$

The gripping forces as a function of operating pressure and lever arm can be determined from the following graphs.

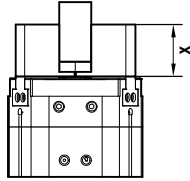

## Internal gripping (opening)

HGDT-25-A

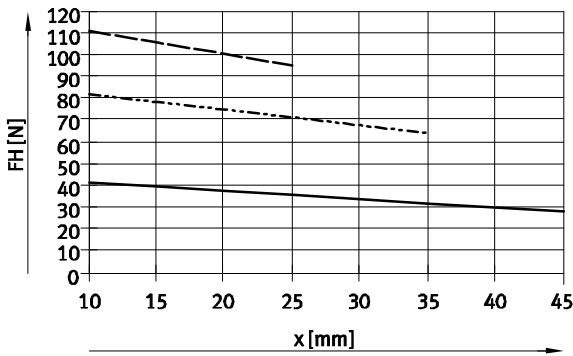

HGDT-35-A

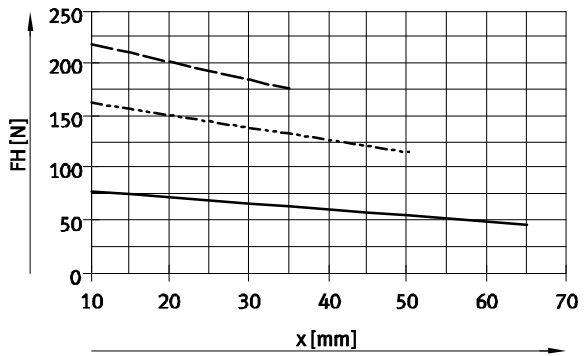

HGDT-40-A

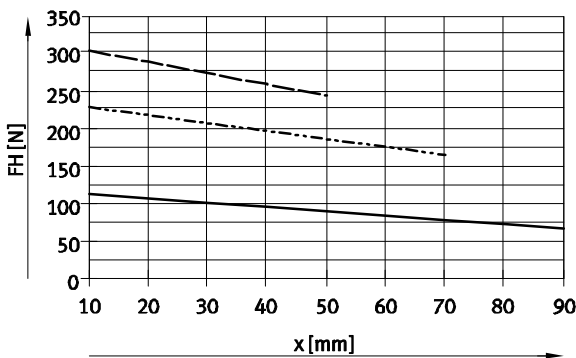

HGDT-50-A

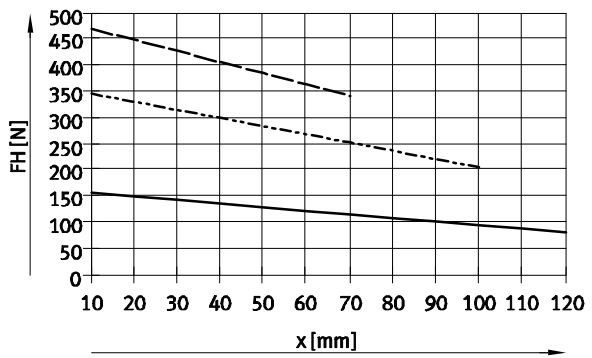

HGDT-63-A

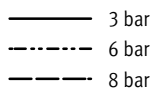
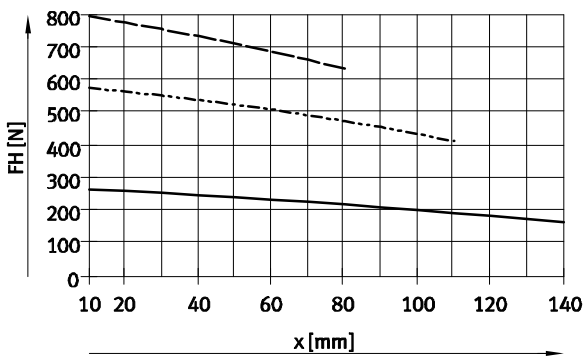



# Heavy-duty three-point grippers HGDT

Technical data

## High force – HGDT...-F

Gripping force  $F_{Grip}$  per gripper jaw as a function of operating pressure and lever arm  $x$

The gripping forces as a function of operating pressure and lever arm can be determined from the following graphs.

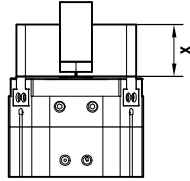

## External gripping (closing)

HGDT-25-A-F

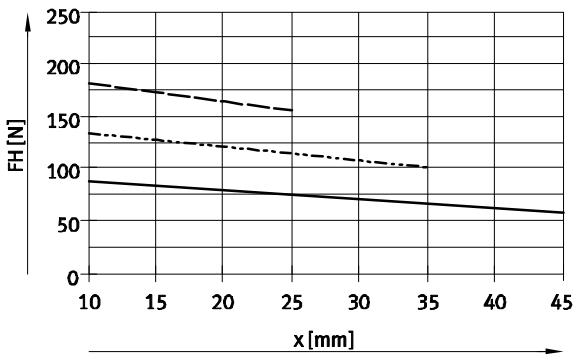

HGDT-35-A-F

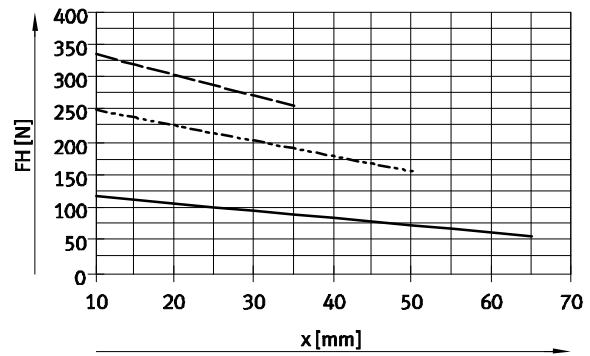

HGDT-40-A-F

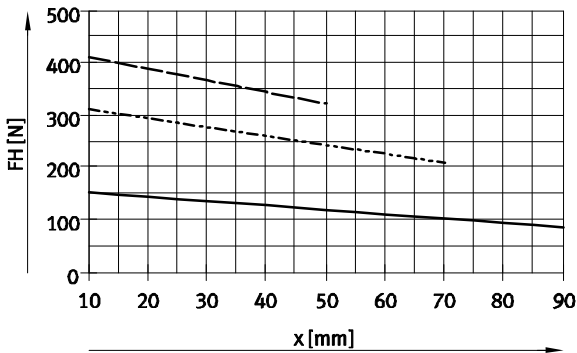

HGDT-50-A-F

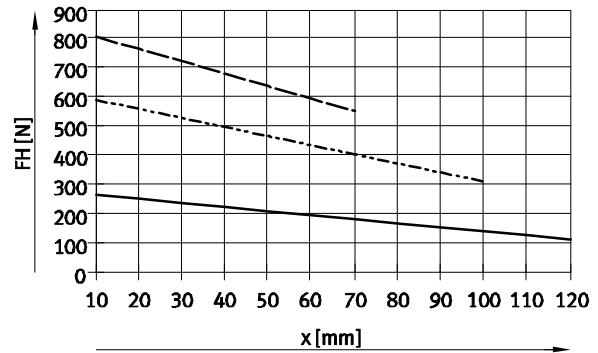

HGDT-63-A

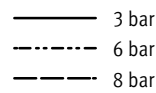
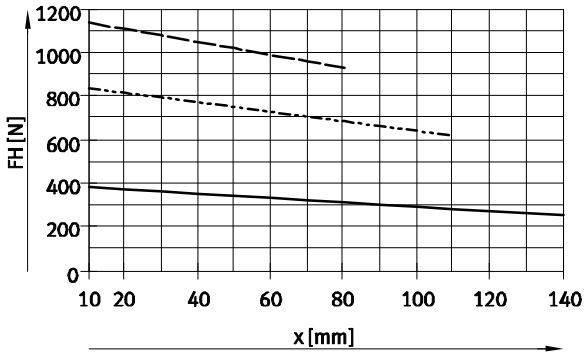

# Heavy-duty three-point grippers HGDT

Technical data

## High force – HGDT...-F

Gripping force  $F_{Grip}$  per gripper jaw as a function of operating pressure and lever arm  $x$

The gripping forces as a function of operating pressure and lever arm can be determined from the following graphs.

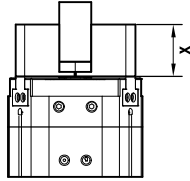

## Internal gripping (opening)

HGDT-25-A-F

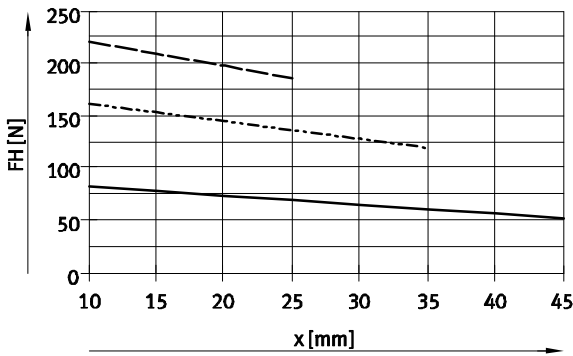

HGDT-35-A-F

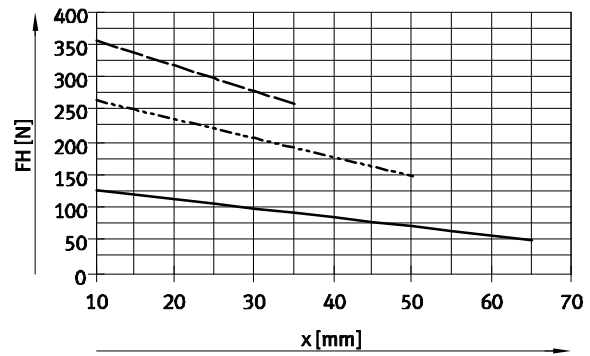

HGDT-40-A-F

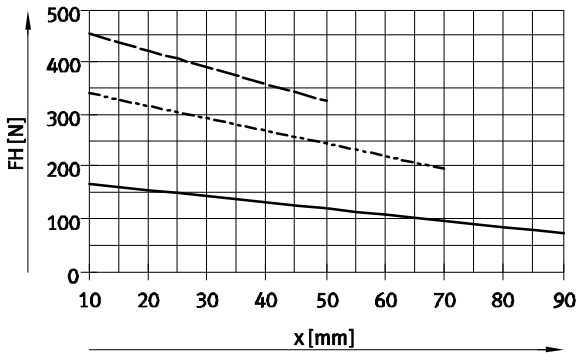

HGDT-50-A-F

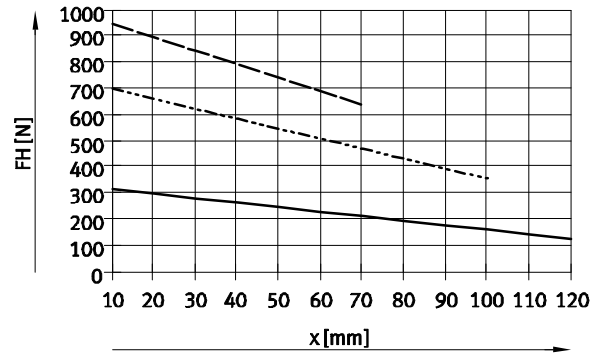

HGDT-63-A-F

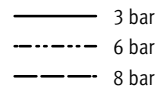
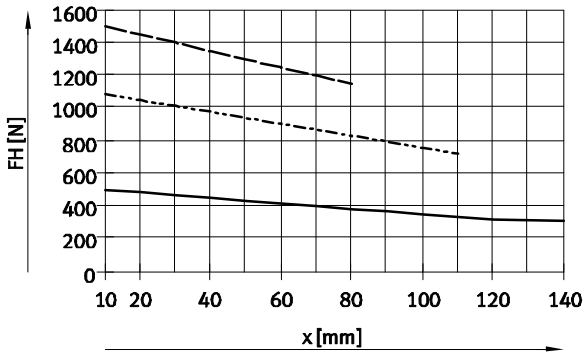

# Heavy-duty three-point grippers HGDT

Technical data

## Spring force $F_S$ as a function of size, gripper jaw stroke $l$ and gripper length $x$ , per gripper finger

Gripping force retention for HGDT-...-G...

The spring forces  $F_S$  as a function of the gripper jaw stroke can be determined from the following graph.

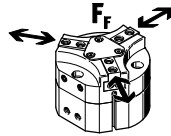

### Standard – HGDT-...

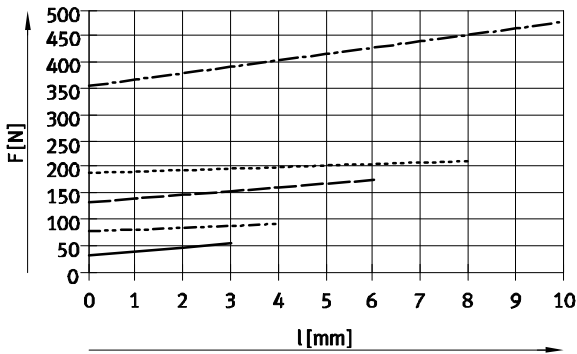

- HGDT-25-A-G...
- HGDT-35-A-G...
- HGDT-40-A-G...
- HGDT-50-A-G...
- HGDT-63-A-G...

### High force – HGDT-...-F-...

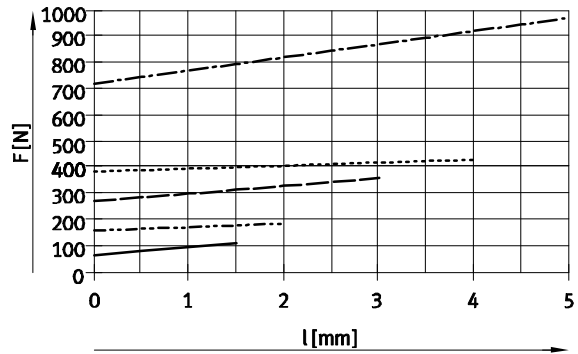

- HGDT-25-A-F-G...
- HGDT-35-A-F-G...
- HGDT-40-A-F-G...
- HGDT-50-A-F-G...
- HGDT-63-A-F-G...

The lever arm  $x$  [mm] must be taken into consideration when determining the actual spring force  $F_{Stotal}$ .

The formulae for calculating the spring force are provided in the table below.

Size	$F_{Stotal}$ , per gripper finger	
	Standard – HGDT-...	High force – HGDT-...-F
25	$-0.3 * x + 0.85 * F_S$	$-2.24 * x + 0.64 * F_S$
35	$-0.5 * x + 0.75 * F_S$	$-0.97 * x + 0.7 * F_S$
40	$-0.5 * x + 0.8 * F_S$	$-1.45 * x + 0.66 * F_S$
50	$-0.6 * x + 0.7 * F_S$	$-0.97 * x + 0.51 * F_S$
63	$-0.6 * x + 0.75 * F_S$	$-2.35 * x + 0.72 * F_S$

## Determining the actual gripping forces $F_{Gr}$ for HGDT-...-A-G1 and HGDT-...-A-G2 as a function of the application, per gripper finger

The three-point grippers with integrated spring type HGDT-...-G1 (opening gripping force retention) and HGDT-...-G2 (closing gripping force retention) can be used as:

- single-acting grippers

- grippers with supplementary gripping force and
- grippers with gripping force retention depending on the requirements.

In order to calculate the available gripping forces  $F_{Gr}$  (per gripper finger), the gripping force ( $F_{Grip}$ ) and spring force ( $F_{Stotal}$ ) must be combined accordingly.

### Application forces per gripper finger

#### Single-acting

- Gripping with spring force:  
 $F_{Gr} = F_{Stotal}$
- Gripping with pressure force:  
 $F_{Gr} = F_{Grip} - F_{Stotal}$

#### Supplementary gripping force

- Gripping with pressure and spring force:  
 $F_{Gr} = F_{Grip} + F_{Stotal}$

#### Gripping force retention

- Gripping with spring force:  
 $F_{Gr} = F_{Stotal}$

# Heavy-duty three-point grippers HGDT

Technical data

FESTO

## Dimensions

Download CAD data → [www.festo.com](http://www.festo.com)

- 1 Supply port, opening
- 2 Supply port, closing
- 3 Alternative air connection (supplied sealed)
- 4 Sealing air connection (supplied sealed)
- 5 Lubrication nipple (supplied sealed)
- 6 Slot for proximity sensor
- 7 Centring disc

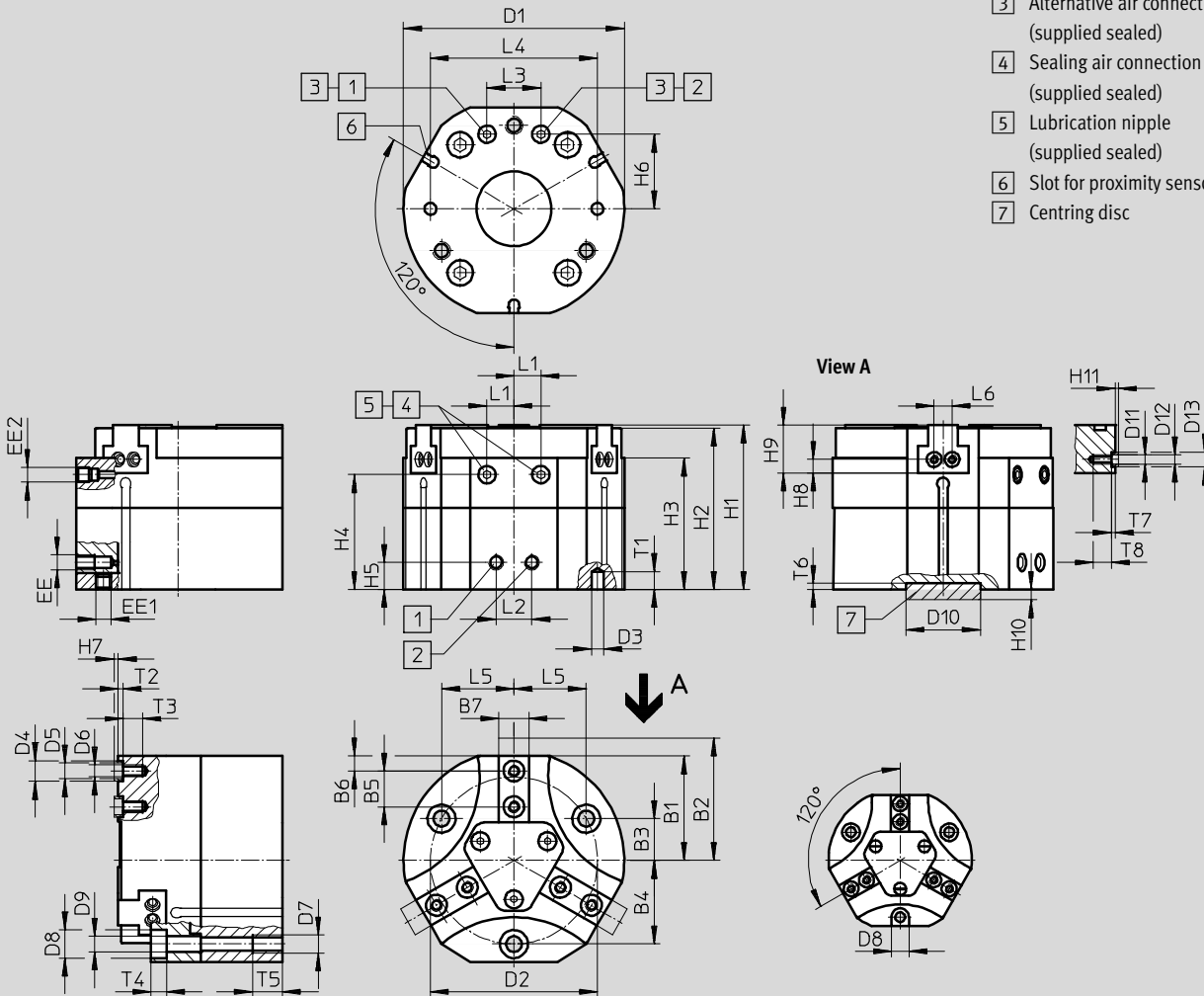

Size	B1	B2		B3	B4	B5	B6	B7	D1	D2
		with HGDT-...	with HGDT-...F							
[mm]	±0.5	±0.5	±0.5			±0.02	±0.02	-0.05 -0.1	∅ ±0.1	∅ ±0.1
HGDT-25-A	22	25	23.5	9.5	19	6	3	6	48	38
HGDT-25-A-G...										
HGDT-35-A	27	31	29	11	22	8	4	6.5	58	44
HGDT-35-A-G...										
HGDT-40-A	35	41	38	14	28	12	5	10	74	56
HGDT-40-A-G...										
HGDT-50-A	43.5	51.5	47.5	17.5	35	15	6	12	93	70
HGDT-50-A-G...										
HGDT-63-A	54	64	59	22.5	45	18	10	14	116	90
HGDT-63-A-G...										

# Heavy-duty three-point grippers HGDT

Technical data

Size [mm]	D3 ∅ H8	D4 ∅ H8/h7	D5 ∅	D6 ∅	D7 ∅	D8 ∅ H13	D9 ∅ H13	D10 ∅ H8	D11	D12 ∅	D13 ∅ H8/h7	EE	EE1
HGDT-25-A	3	5	3.2	M3	M4	5.9	3.3	14	M2	-	-	M5	M3
HGDT-25-A-G...													
HGDT-35-A	3	5	3.2	M3	M4	5.9	3.3	25	M3	3.2	5	M5	M3
HGDT-35-A-G...													
HGDT-40-A	4	7	5.3	M4	M6	9.4	5.1	25	M3	3.2	5	M5	M5
HGDT-40-A-G...													
HGDT-50-A	5	9	6.4	M6	M8	10.2	6.4	25	M5	5.3	7	G1/8	M5
HGDT-50-A-G...													
HGDT-63-A	5	9	6.4	M6	M8	10.4	6.4	25	M5	5.3	7	G1/8	M5
HGDT-63-A-G...													

Size [mm]	EE2	H1 ±0.05	H2 ±0.05	H3	H4	H5 ±0.1	H6 ±0.1	H7 -0.3	H8	H9 -0.02	H10 -0.2	H11 -0.3	L1 ±0.5
HGDT-25-A	M5	41.5	40.5	32.5	29.3	9	13.5	1.1	2.25±0.1	8.5	3.5	-	6
HGDT-25-A-G...													
HGDT-35-A	M5	46	45	37	33.5	9	18.5	1.1	3±0.02	12	3.5	1.1	7
HGDT-35-A-G...		52	51	43	39.5								
HGDT-40-A	M5	55	54	44	38.4	9	25	1.4	4.5±0.02	16	3.5	1.1	9
HGDT-40-A-G...		72	71	61	55.4								
HGDT-50-A	M5	64.5	63.5	50.5	45	12	32	1.9	5.5±0.02	19	3.5	1.4	9
HGDT-50-A-G...		82	81	68	62.5								
HGDT-63-A	M5	69	68	50	44.5	12	42	1.9	5.5±0.02	22	3.5	1.4	12
HGDT-63-A-G...		96	95	77	71.5								

Size [mm]	L2 ±0.1	L3 ±0.1	L4 ±0.02	L5	L6	T1 min.	T2 +0.1	T3 min.	T4 +0.2	T5 min.	T6 +0.1	T7 +0.1	T8 min.
HGDT-25-A	12	12	38	16.45	6±0.1	3.5	1.3	5	3.2	8	2	-	3
HGDT-25-A-G...													
HGDT-35-A	12	15	45	19.05	6±0.02	5	1.3	5.5	3.2	8	2	1.3	6
HGDT-35-A-G...													
HGDT-40-A	12	18	56	24.25	6±0.02	6	1.6	6.5	5.1	10	2	1.3	6
HGDT-40-A-G...													
HGDT-50-A	24	18	70	30.31	13±0.02	8	2.1	10.5	6.1	12	2	1.6	9
HGDT-50-A-G...													
HGDT-63-A	24	24	90	38.97	13±0.02	8	2.1	10.5	6.1	12	2	1.6	9
HGDT-63-A-G...													

# Heavy-duty three-point grippers HGDT



Technical data

Ordering data						
Size [mm]	Double-acting without compression spring		Single-acting or with gripping force retention			
	Part No.	Type	opening		closing	
	Part No.	Type	Part No.	Type	Part No.	Type
Standard						
25	540859	HGDT-25-A	540860	HGDT-25-A-G1	540861	HGDT-25-A-G2
35	540862	HGDT-35-A	540863	HGDT-35-A-G1	540864	HGDT-35-A-G2
40	540865	HGDT-40-A	540866	HGDT-40-A-G1	540867	HGDT-40-A-G2
50	540868	HGDT-50-A	540869	HGDT-50-A-G1	540870	HGDT-50-A-G2
63	540871	HGDT-63-A	540872	HGDT-63-A-G1	540873	HGDT-63-A-G2
High force						
25	560177	HGDT-25-A-F	560178	HGDT-25-A-F-G1	560179	HGDT-25-A-F-G2
35	560180	HGDT-35-A-F	560181	HGDT-35-A-F-G1	560182	HGDT-35-A-F-G2
40	560183	HGDT-40-A-F	560184	HGDT-40-A-F-G1	560185	HGDT-40-A-F-G2
50	560186	HGDT-50-A-F	560187	HGDT-50-A-F-G1	560188	HGDT-50-A-F-G2
63	560189	HGDT-63-A-F	560190	HGDT-63-A-F-G1	560191	HGDT-63-A-F-G2

# Heavy-duty three-point grippers HGDT

Accessories

FESTO

Adapter kit  
DHAA, HAPG

Material:  
Wrought aluminium alloy  
Free of copper and PTFE  
RoHS-compliant

 Note  
The kit includes the individual mounting interface as well as the necessary mounting material.

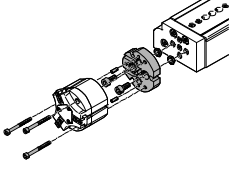
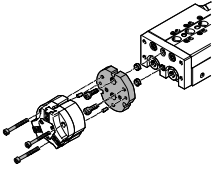
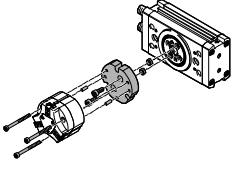
Permissible drive/gripper combinations with adapter kit				Download CAD data → <a href="http://www.festo.com">www.festo.com</a>	
Combination	Drive	Gripper	Adapter kit		
	Size	Size	CRC <sup>1)</sup>	Part No.	Type
DGSL/HGDT	DGSL	HGDT	HAPG		
	16	25	2	542439	HAPG-SD2-32
	16	35		542436	HAPG-94
	20, 25	35		548805	ZBV-9-7
	20, 25	40		542436	HAPG-94
	25	50		542437	HAPG-95
					542443
			548806	ZBV-12-9	
SLT/HGDT	SLT	HGDT	HAPG		
	16	25	2	542433	HAPG-97
	20	25		542439	HAPG-SD2-32
	16	35		542435	HAPG-99
	20, 25	35		542436	HAPG-94
	20, 25	40		542437	HAPG-95
	25	50		542443	HAPG-SD2-36
DRRD/HGDT	DRRD	HGDT	DHAA		
	16	25	2	2079812	DHAA-G-Q11-16-B7/B7G-25
	20	25		2079695	DHAA-G-Q11-20-B7/B7G-25
	20	35		2077056	DHAA-G-Q11-20-B7-35
	25	35		1735057	DHAA-G-Q11-25-B7-35
	25	40		1735103	DHAA-G-Q11-25-B7-40
	32	40		2077253	DHAA-G-Q11-32-B7-40
	32	50		2077335	DHAA-G-Q11-32-B7-50
	35	50		2079063	DHAA-G-Q11-35-B7-50
	35, 40	63		2079274	DHAA-G-Q11-35/40-B7-63
	DRRD	HGDT-G		DHAA	
	20	35	2	2832455	DHAA-G-Q11-20-B7G-35
	25	35		2832483	DHAA-G-Q11-25-B7G-35
	25	40		2832545	DHAA-G-Q11-25-B7G-40
	32	40		2832575	DHAA-G-Q11-32-B7G-40
	32	50		2832600	DHAA-G-Q11-32-B7G-50
	35	50		2832617	DHAA-G-Q11-35-B7G-50
35, 40	63	2832631		DHAA-G-Q11-35/40-B7G-63	

1) CRC2: Corrosion resistance class to Festo standard 940 070  
Components with medium corrosion exposure. Externally visible components with significant decorative function in direct contact with normal industrial atmosphere or media such as coolants and lubricants.

# Heavy-duty three-point grippers HGDT

Accessories

FESTO

**Adapter kit  
HAPG**

Material:  
Wrought aluminium alloy  
Free of copper and PTFE  
RoHS-compliant



Note

The kit includes the individual mounting interface as well as the necessary mounting material.

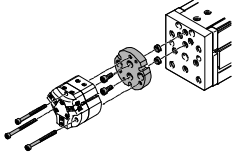
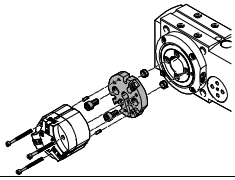
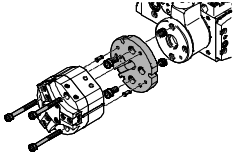
Permissible drive/gripper combinations with adapter kit						Download CAD data → <a href="http://www.festo.com">www.festo.com</a>
Combination	Drive	Gripper	Adapter kit			
	Size	Size	CRC <sup>1)</sup>	Part No.	Type	
	EGSL	HGDT	HAPG			
	35	25	2	<b>542433</b>	<b>HAPG-97</b>	
	45, 55	25		<b>542439</b>	<b>HAPG-SD2-32</b>	
	45, 55, 75	35		<b>542436</b>	<b>HAPG-94</b>	
	75	40		<b>542437</b>	<b>HAPG-95</b>	
	75	50		<b>542443</b>	<b>HAPG-SD2-36</b>	
	ERMB	HGDT	HAPG			
	20, 25	25	2	<b>542440</b>	<b>HAPG-SD2-33</b>	
	20, 25, 32	35		<b>542441</b>	<b>HAPG-SD2-34</b>	
	25, 32	40		<b>542442</b>	<b>HAPG-SD2-35</b>	
	32	50		<b>542443</b>	<b>HAPG-SD2-36</b>	
	EHMB	HGDT	HAPG			
	20	35	2	<b>542441</b>	<b>HAPG-SD2-34</b>	
	20	40		<b>542442</b>	<b>HAPG-SD2-35</b>	
	20	50		<b>542443</b>	<b>HAPG-SD2-36</b>	

1) CRC2: Corrosion resistance class to Festo standard 940 070  
Components with medium corrosion exposure. Externally visible components with significant decorative function in direct contact with normal industrial atmosphere or media such as coolants and lubricants.



# Heavy-duty three-point grippers HGDT

Accessories

**Gripper jaw blank BUB-HGDT**  
(scope of delivery: 3 pieces)

Material:  
Wrought aluminium alloy  
Free of copper and PTFE

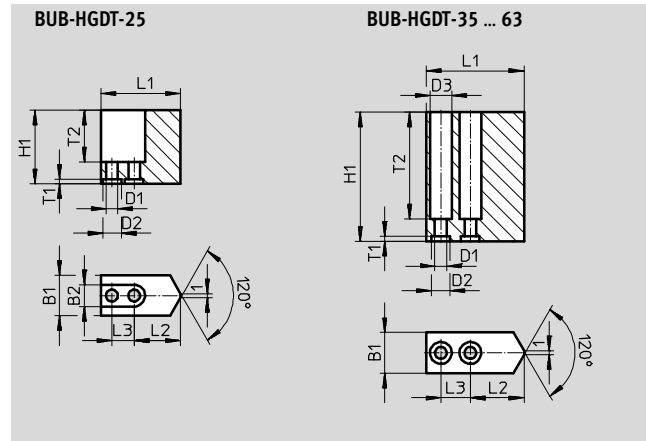

Dimensions and ordering data							
For size	B1	B2	D1	D2	D3	H1	L1
[mm]	±0.05	+0.22	∅ H13	∅ H8	∅ +0.22	±0.05	±0.05
25	11	5.9	3.2	5	-	20	21.6
35	11	-	3.2	5	5.9	35	26.5
40	16	-	4.3	7	7.4	50	34
50	20	-	6.3	9	10.4	65	42
63	24	-	6.3	9	10.4	80	52



For size	L2	L3	T1	T2	Weight per blank [g]	Part No.	Type
[mm]	±0.02 <sup>1)</sup> ±0.1 <sup>2)</sup>	±0.01 <sup>1)</sup> ±0.1 <sup>1)</sup>	+0.1				
25	12.6	6	1.3	14	10	541101	BUB-HGDT-25
35	14.5	8	1.3	29	22	541102	BUB-HGDT-35
40	17	12	1.6	45	59	541103	BUB-HGDT-40
50	21	15	2.1	58	112	541104	BUB-HGDT-50
63	24	18	2.1	73	222	541105	BUB-HGDT-63

1) For centring  
2) For through-hole

# Heavy-duty three-point grippers HGDT

Accessories



FESTO

Ordering data						
	For size [mm]	Remarks	Weight [g]	Part No.	Type	PU <sup>1)</sup>
Centring sleeve ZBH <span style="float: right;">Technical data → Internet: zbh</span>						
	25, 35	For centring gripper jaw blanks/gripper fingers on the gripper jaws	1	<b>189652</b>	<b>ZBH-5</b>	10
	40		1	<b>186717</b>	<b>ZBH-7</b>	
	50, 63		1	<b>150927</b>	<b>ZBH-9</b>	
	35, 40	For lateral centring of gripper fingers on the gripper jaws	1	<b>189652</b>	<b>ZBH-5</b>	
	50, 63		1	<b>186717</b>	<b>ZBH-7</b>	
Central mounting SLZZ <span style="float: right;">Technical data → Internet: slzz</span>						
	25	For centring the gripper during mounting	21	<b>150900</b>	<b>SLZZ-16/10</b>	-
	35, 40, 50, 63		40	<b>150901</b>	<b>SLZZ-25/16</b>	
Blanking plug B <span style="float: right;">Technical data → Internet: blanking plug</span>						
	25 ... 63	For sealing the supply ports	0.6	<b>30979</b>	<b>B-M3-S9</b>	10
			1	<b>174308</b>	<b>B-M5-B</b>	
			5	<b>3568</b>	<b>B-1/8</b>	

1) Packaging unit

Ordering data – Proximity sensors for C-slot, magneto-resistive							Technical data → Internet: smt
	Type of mounting	Electrical connection, connection direction	Switching output	Cable length [m]	Part No.	Type	
N/O contact							
	Insertable in the slot from above	Cable, 3-wire, in-line	PNP	2.5	<b>551373</b>	<b>SMT-10M-PS-24V-E-2,5-L-OE</b>	
		Plug M8x1, 3-pin, in-line		0.3	<b>551375</b>	<b>SMT-10M-PS-24V-E-0,3-L-M8D</b>	

Ordering data – Proximity sensors for C-slot, magneto-resistive							Technical data → Internet: smt
	Type of mounting	Electrical connection, connection direction	Switching output	Cable length [m]	Part No.	Type	
N/O contact							
	Insertable in the slot lengthwise	Cable, 3-wire, lateral	PNP	2.5	<b>547862</b>	<b>SMT-10G-PS-24V-E-2,5Q-OE</b>	
		Plug M8x1, 3-pin, lateral		0.3	<b>547863</b>	<b>SMT-10G-PS-24V-E-0,3Q-M8D</b>	
		Cable, 3-wire, lateral	NPN	2.5	<b>8065030</b>	<b>SMT-10G-NS-24V-E-2,5Q-OE</b>	
		Plug M8x1, 3-pin, lateral		0.3	<b>8065029</b>	<b>SMT-10G-NS-24V-E-0,3Q-M8D</b>	

Ordering data – Connecting cables							Technical data → Internet: nebu
	Electrical connection, left	Electrical connection, right	Cable length [m]	Part No.	Type		
	Straight socket, M8x1, 3-pin	Cable, open end, 3-wire	2.5	<b>541333</b>	<b>NEBU-M8G3-K-2.5-LE3</b>		
			5	<b>541334</b>	<b>NEBU-M8G3-K-5-LE3</b>		
	Angled socket, M8x1, 3-pin	Cable, open end, 3-wire	2.5	<b>541338</b>	<b>NEBU-M8W3-K-2.5-LE3</b>		
			5	<b>541341</b>	<b>NEBU-M8W3-K-5-LE3</b>		