

Swivel/gripper units HGDS-B

FESTO



Swivel/gripper units HGDS-B

Key features

At a glance

- Combination of parallel gripper with T-slot guide and swivel module on the basis of swivel module DSM
- Infinitely adjustable swivel angle (max. 210°)
- Supply ports and position sensing outside the swivel range
- High performance (torque, mass moment of inertia)
- All connections accessible from one side
- Compact design and low weight

The technology in detail

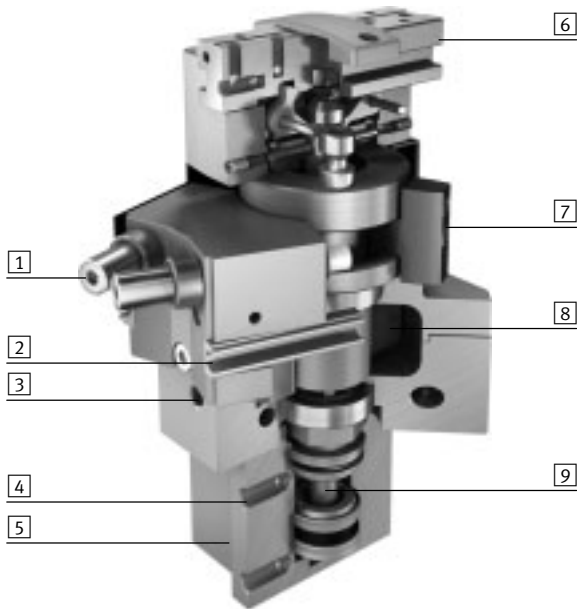

- 1 Three types of cushioning for swivel motion:
 - Flexible cushioning elements (P)
 - Adjustable flexible cushioning components with metal fixed stop (P1)
 - Shock absorbers with metal fixed stop (YSRT)
- 2 Slot for proximity sensor SME/SMT-10 for sensing the swivel position
- 3 Supply port for swivelling function
- 4 Supply port for gripping function
- 5 Slot for proximity sensor SME/SMT-10 for sensing the gripping position
- 6 Gripper jaw with T-slot guide
- 7 Adjustable stop cams for adjusting the swivel motion
- 8 Rotary vane
- 9 Piston rod for gripping motion

Mounting options

Direct mounting

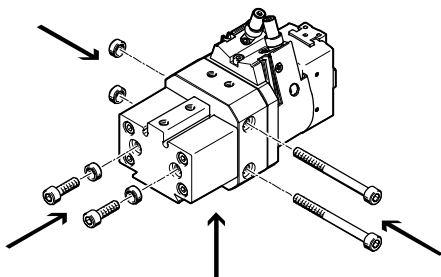

Dovetail connection

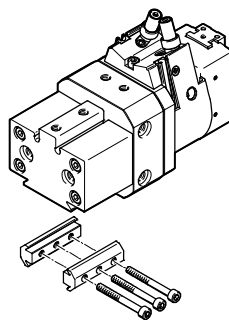

The swivel/gripper unit can be mounted on four sides.

-  Note

Swivel/gripper units are not suitable for the following or similar applications:

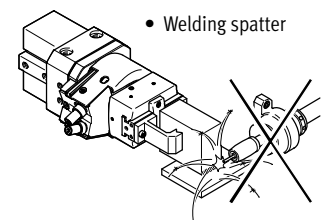
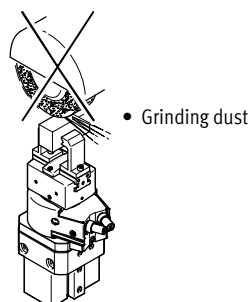
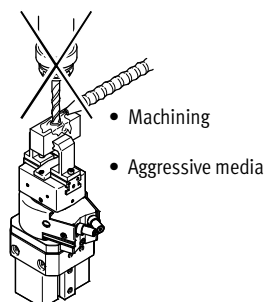

Swivel/gripper units HGDS-B

Peripherals overview and type codes

Peripherals overview

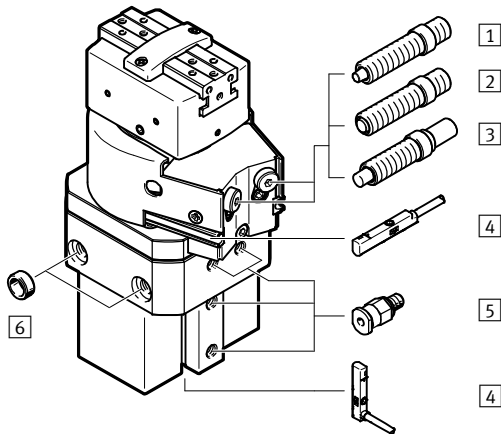

System product for handling and assembly technology

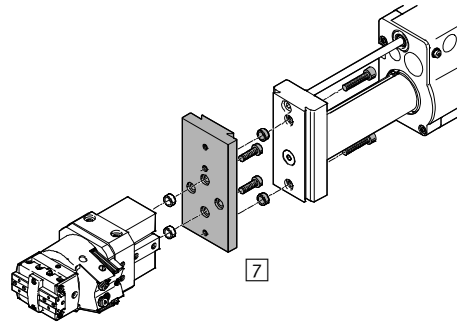

Accessories			
Type	Description	→ Page/Internet	
1 Cushioning P	Flexible cushioning components at both ends	14	
2 Cushioning P1	Adjustable flexible cushioning components at both ends, with metal fixed stop	14	
3 Cushioning YSRT	Self-adjusting shock absorbers at both ends, with metal fixed stop	14	
4 Proximity sensor SME/SMT-10	For sensing the gripping and swivelling position	16	
5 Push-in fitting QS	For connecting compressed air tubing with standard O.D.	qs	
6 Centring sleeve ZBH	For centring the gripper when mounting (2 included in the scope of delivery)	16	
7 Adapter kit HAVB, HMSV, HMVA	Drive/gripper connections	15	

Type codes

HGDS – PP – 16 – YSRT – A – B

Type	
HGDS	Swivel/gripper unit

Gripper function	
PP	Parallel gripper

Size	
16	

Cushioning	
P	Flexible cushioning components at both ends
P1	Adjustable flexible cushioning components at both ends
YSRT	Self-adjusting shock absorbers at both ends

Position sensing	
A	Via proximity sensor

Generation	
B	B series

Swivel/gripper units HGDS-B



Technical data

FESTO

Function
Swivelling/gripping

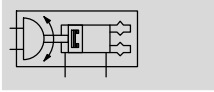
 www.festo.com



-  - Size
12, 16, 20 mm
-  - Stroke
5, 9, 14 mm

General technical data			
Size	12	16	20
Design	Parallel gripper Swivel module Gripper module		
Mode of operation	Double-acting		
Pneumatic connection	M5		
Type of mounting	Via female thread and centring sleeve Via through-hole and centring sleeve Via dovetail slot		
Cushioning	Flexible cushioning at both ends components Adjustable flexible cushioning components at both ends Self-adjusting shock absorbers at both ends		
P cushioning	Flexible cushioning at both ends components		
P1 cushioning	Adjustable flexible cushioning components at both ends		
YSRT cushioning	Self-adjusting shock absorbers at both ends		
Mounting position	Any		
Relubrication intervals of guide	10 million switching cycles		
Product weight [g]	505	730	1260
Technical data – swivelling	→ page 5		
Technical data – gripping	→ page 8		

Operating and environmental conditions		
Operating pressure [bar]	3 ... 8	
Operating medium	Compressed air in accordance with ISO 8573-1:2010 [7:4:4]	
Note on operating/pilot medium	Operation with lubricated medium possible (in which case lubricated operation will always be required)	
Ambient temperature ¹⁾ [°C]	+5 ... +60	
Corrosion resistance class CRC ²⁾	2	

1) Note operating range of proximity sensors

2) Corrosion resistance class 2 according to Festo standard 940 070

Components subject to moderate corrosion stress. Externally visible parts with primarily decorative surface requirements which are in direct contact with a normal industrial environment or media such as coolants or lubricating agents.

Materials

Sectional view

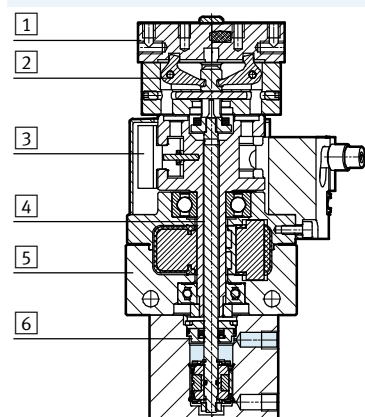

Swivel/gripper unit		
1	Gripper jaw	Stainless steel
2	Lever	Hardened steel
3	Stop	Stainless steel
4	Piston rod	Stainless steel
5	Housing	Wrought aluminium alloy
6	Piston	Nitrile rubber, polyurethane
-	Rubber buffer	Nitrile rubber

Swivel/gripper units HGDS-B

Technical data

Technical data – Swivelling

Size		12	16	20
Swivel angle	[°]	0 ... 210		
Theoretical torque ¹⁾	[Nm]	0.85	1.25	2.5
Repetition accuracy ¹⁾				
P cushioning	[°]	< 0.2		
P1 cushioning	[°]	< 0.02		
YSRT cushioning	[°]	< 0.02		
Max. swivel frequency ¹⁾				
P cushioning	[Hz]	2		
P1 cushioning	[Hz]	2		
YSRT cushioning	[Hz]	1.5		
Position sensing		Via proximity sensor		

1) At an operating pressure of 6 bar

Mass moments of inertia J at 6 bar as a function of swivel time t and swivel angle

HGDS-PP-12-P-A-B

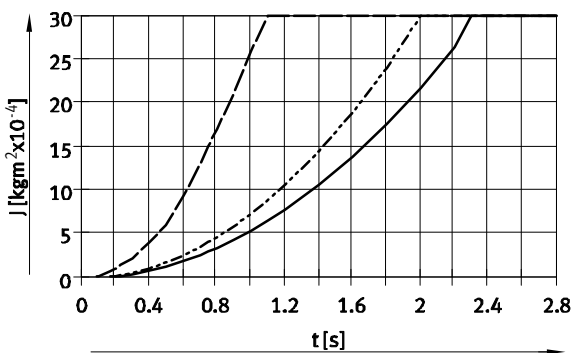

HGDS-PP-12-P1-A-B

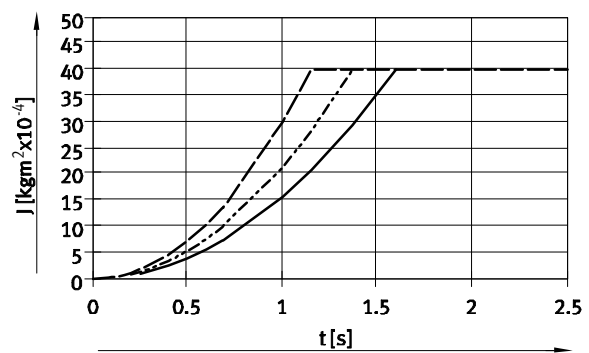

HGDS-PP-16-P-A-B

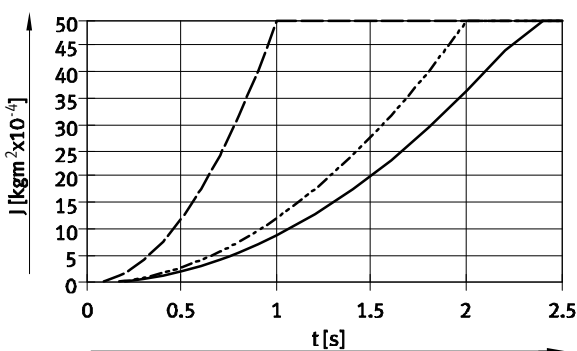

HGDS-PP-16-P1-A-B

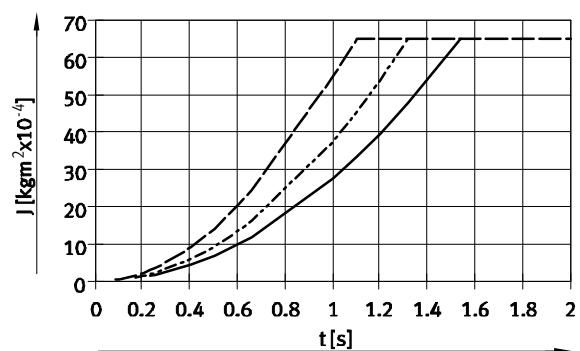

HGDS-PP-20-P-A-B

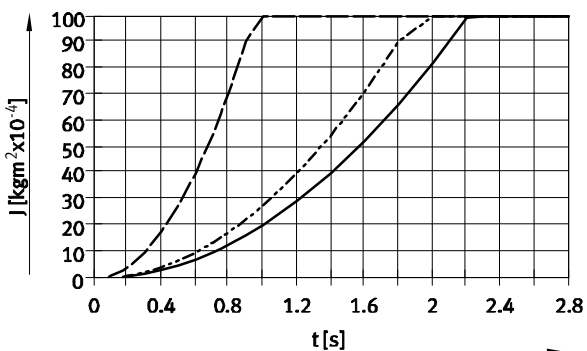

HGDS-PP-20-P1-A-B

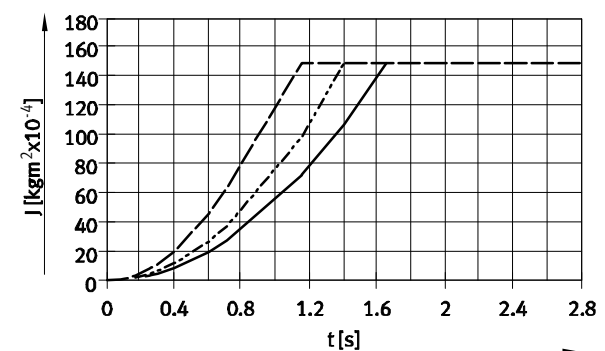

Swivel angle 210°
 Swivel angle 90°
 Swivel angle 180°

Swivel/gripper units HGDS-B

Technical data

Mass moments of inertia J at 6 bar as a function of swivel time t and swivel angle

HGDS-PP-12-YSRT-A-B

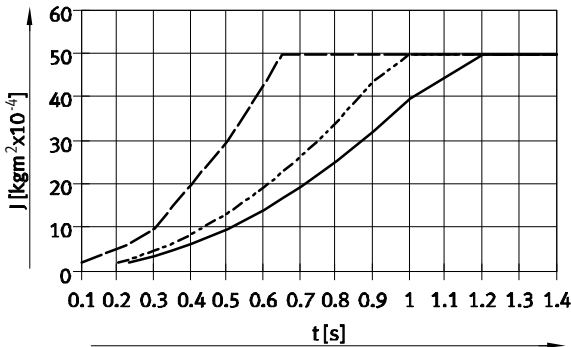

HGDS-PP-16-YSRT-A-B

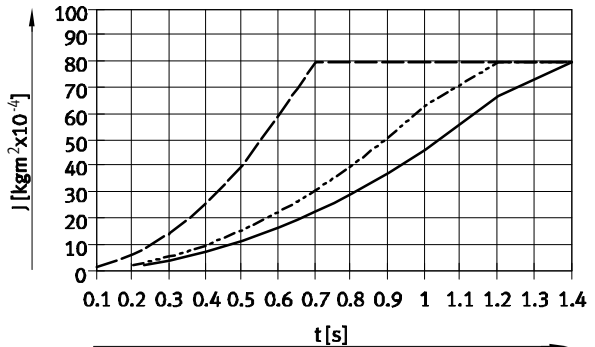

HGDS-PP-20-YSRT-A-B

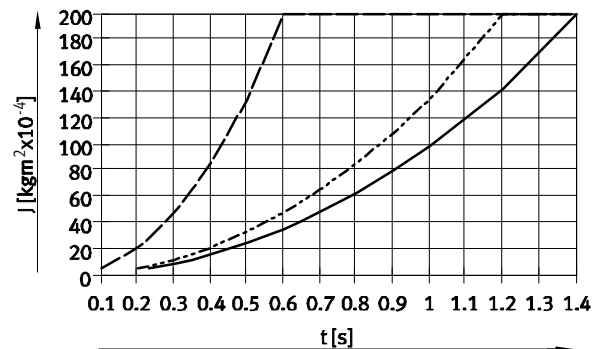

— Swivel angle 210°
 - - - Swivel angle 180°
 - · - Swivel angle 90°

Dependency between operating pressure and swivel time

Reducing the operating pressure reduces the gripping force.

To ensure that the gripper's jaws do not open during swivelling, the swivel time must be increased by 15% per bar of operating pressure (same mass moment of inertia).

Example:

Given:

HGDS-PP-16-YSRT-A-B

Operating pressure 6 bar

Swivel angle 90°

$J = 40 \text{ kgm}^2 \times 10^{-4}$

To be calculated:

Swivel time at an operating pressure

of 4 bar

Swivel time at 6 bar = 0.5 s, see graph opposite

Swivel time at 4 bar:

$$t = 0.5 + 2 \times 15\% = 0.65 \text{ s}$$

Cushioning time of the shock absorber = 0.1 s

This yields a total swivel time of

$$t_{\text{tot.}} = 0.65 \text{ s} + 0.1 \text{ s} = 0.75 \text{ s}$$

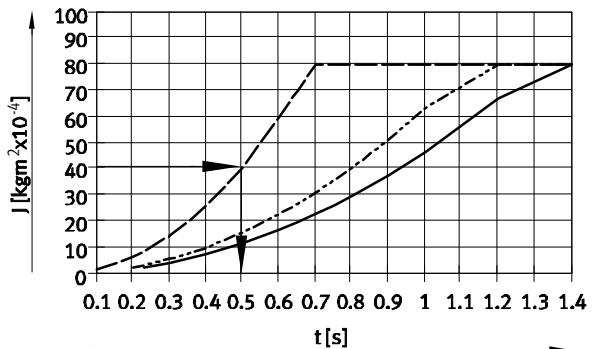

Swivel/gripper units HGDS-B

Technical data

Precision adjustment of the swivel angle

The swivel angle can be roughly adjusted by moving the cam stops
→ page 2.

The procedure for precision adjustment is the same for all cushioning variants (P, P1 and YSRT).

The swivel angle can be precisely adjusted by unscrewing or screwing in the cushioning component.

Swivelling to a metal stop enables high repetition accuracy.

- 1) Loosen the locking screw underneath the cushioning component.

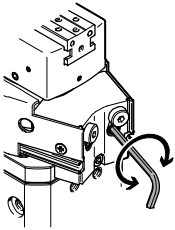

- 2) Adjust the cushioning component as required. Note the adjustment range.

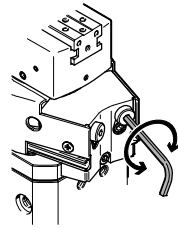

Size		12	16	20
Precision adjustment range				
P cushioning	[°]	-6		
P1 cushioning	[°]	-6		
YSRT cushioning	[°]	-2.5		
Adjustment range of the cushioning component				
P cushioning	[mm]	2	2.6	2.8
P1 cushioning	[mm]	2	2.6	2.8
YSRT cushioning	[mm]	1	1.3	1.4

Swivel/gripper units HGDS-B

Technical data

Technical data – Gripping

Size	12	16	20
Gripper function	Parallel		
Number of gripper jaws	2		
Max. load per external gripper finger ¹⁾ [g]	30	50	100
Stroke per gripper jaw [mm]	2.5	4.5	7
Max. gripper jaw backlash [mm]	0.02		
Max. gripper jaw angular play [°]	0.1		
Repetition accuracy [mm]	±0.01		±0.015
Max. operating frequency [Hz]	4		
Position sensing	Via proximity sensor		

1) Valid for unthrottled operation

Opening and closing times [ms] at 6 bar

Without external gripper fingers

With external gripper fingers

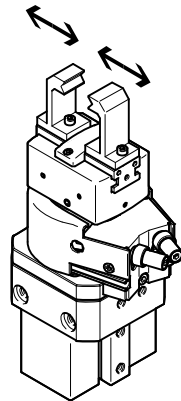
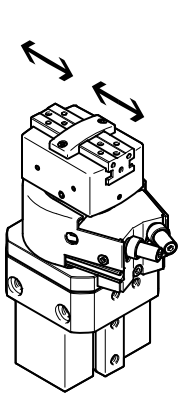

The indicated opening and closing times [ms] have been measured at room temperature and 6 bar operating pressure with vertically mounted swivel/gripper unit without additional

gripper fingers. The grippers must be throttled for greater loads [g]. Opening and closing times must then be adjusted accordingly.

With external gripper fingers (as a function of the load per gripper finger)

Size	12	16	20
Max. load	30 g	50 g	100 g
Unthrottled	Opening	40	60
	Closing	60	70

With external gripper fingers (as a function of the load per gripper finger)

Size	12	16	20		
Load	100 g	200 g	100 g	200 g	
Throttled	Closing	100	150	100	200
		100	250		

Swivel/gripper units HGDS-B

Technical data

Static characteristic load values per gripper jaw

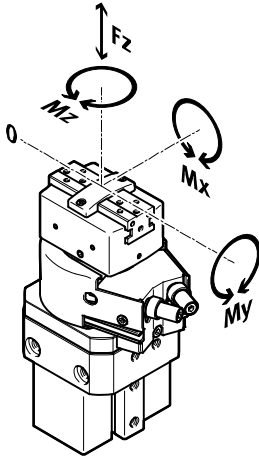

The indicated permissible forces and torques apply to a single gripper jaw. The indicated values include the lever arm, additional applied loads caused by the workpiece or external gripper fingers, as well as forces which occur during movement.

The zero coordinate line (gripper finger guide) must be taken into consideration for the calculation of torques.

Size		12	16	20
Max. permissible force F_z	[N]	90	150	250
Max. permissible torque M_x	[Nm]	6	11	22
Max. permissible torque M_y	[Nm]	6	11	22
Max. permissible torque M_z	[Nm]	6	11	22

Gripping force [N] at 6 bar with a lever arm of 25 mm

Size		12	16	20
Gripping force per gripper jaw				
Opening		42	58	96
Closing		37	51	84
Total gripping force				
Opening		84	116	192
Closing		74	102	168

Swivel/gripper units HGDS-B

Technical data

Gripping force F_H per gripper jaw as a function of operating pressure p

Gripping forces as a function of operating pressure and lever arm can be determined for the various sizes using the following graphs.

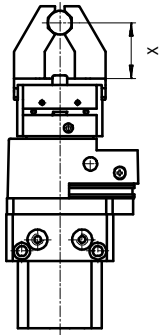

- 3 bar
- - - 6 bar
- · - 8 bar

HGDS-12

Opening

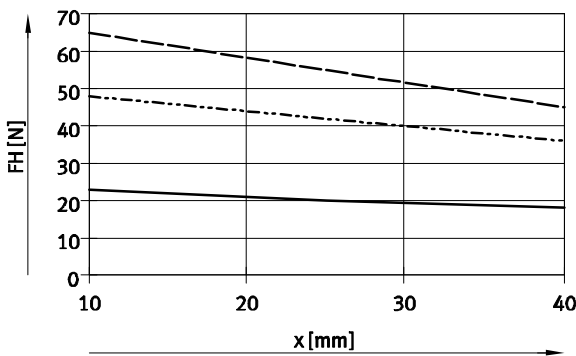

Closing

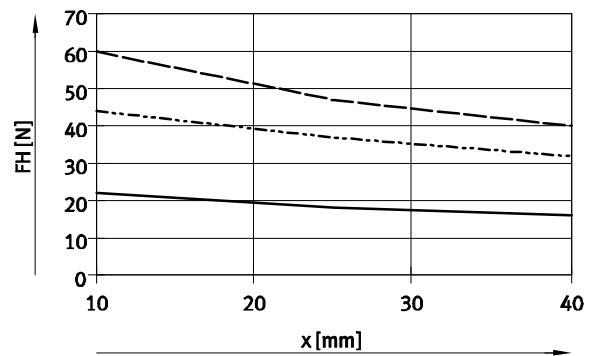

HGDS-16

Opening

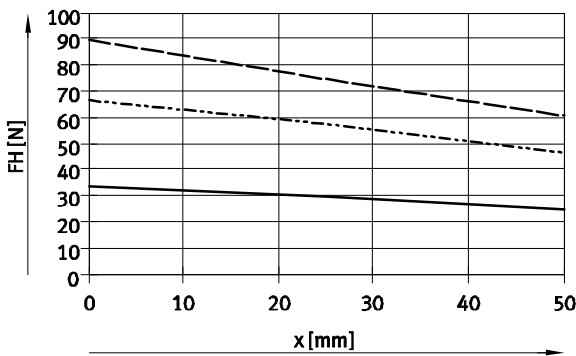

Closing

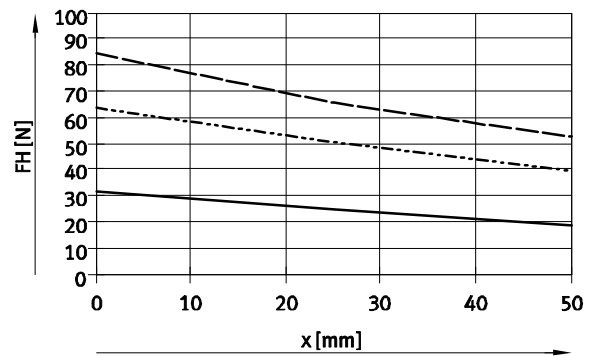

HGDS-20

Opening

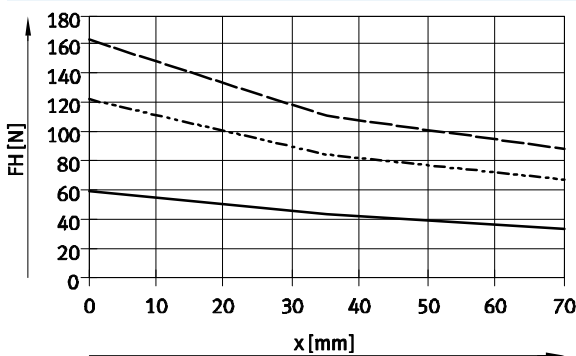

Closing

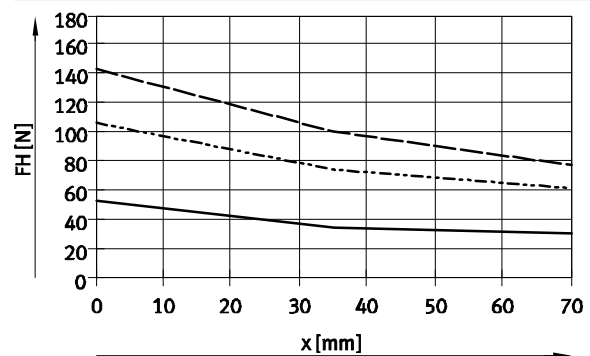

Swivel/gripper units HGDS-B

Technical data

Gripping force F_H per gripper jaw at 6 bar as a function of lever arm x and eccentricity a and b

The following formula must be used to calculate the lever arm x with eccentric gripping:

$$x = \sqrt{a^2 + b^2}$$

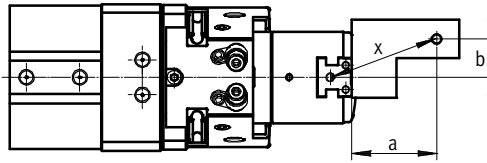

The gripping force F_H can be read from the graphs (→ from page 10) using the calculated value x .

Calculation example

Given:

Distance $a = 25$ mm

Distance $b = 20$ mm

To be calculated:

The gripping force at 6 bar, with an HGDS-16, used as an external gripper

Procedure:

Calculating the lever arm x

$$x = \sqrt{25^2 + 20^2}$$

$x = 32$ mm

The graph (→ page 10) gives a value of $F_H = 47$ N for the gripping force.

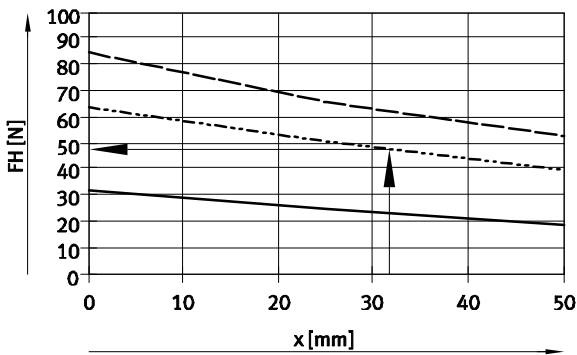

Swivel/gripper units HGDS-B

Technical data

FESTO

Dimensions

Download CAD data → www.festo.com

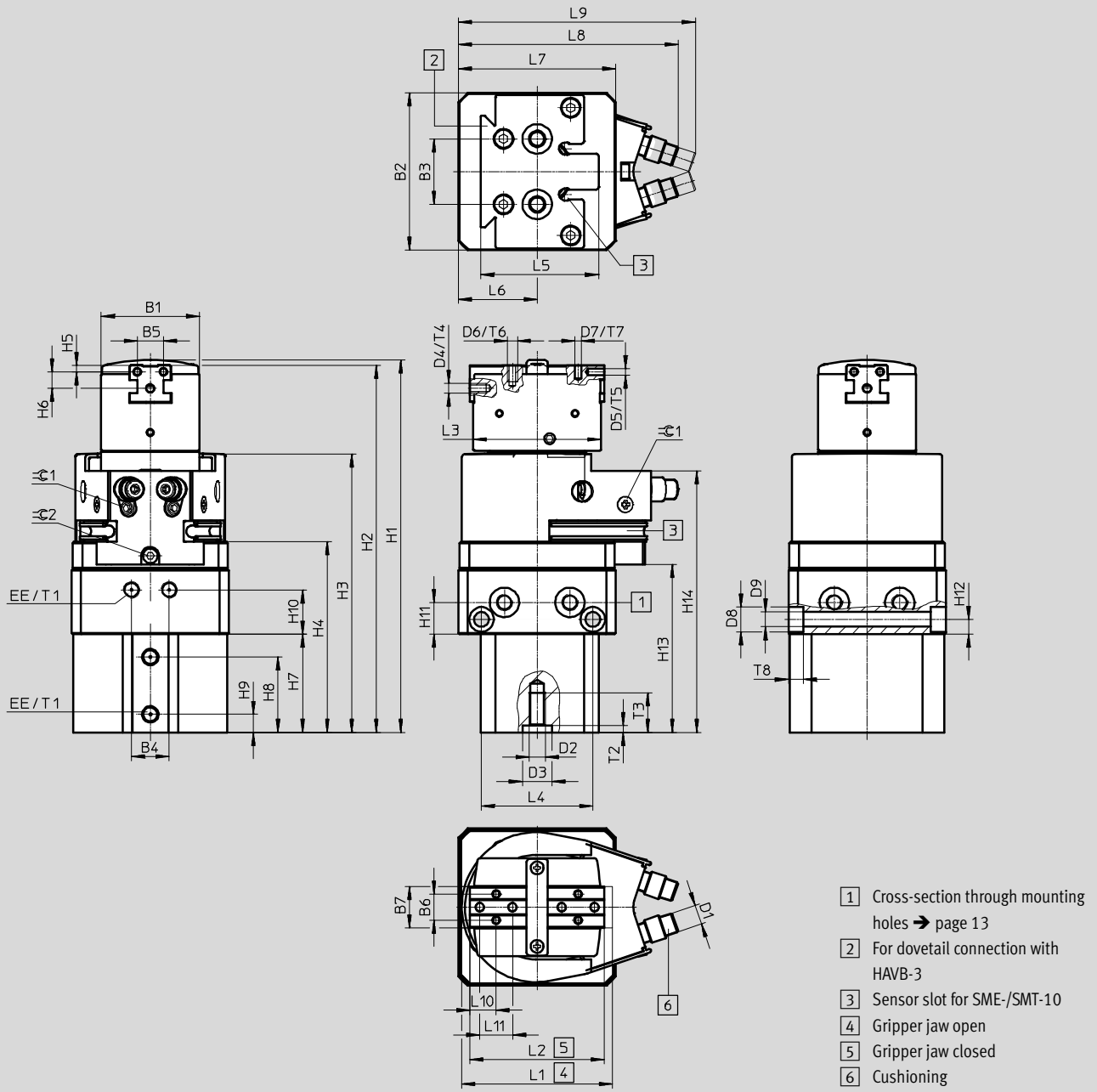

Swivel angle

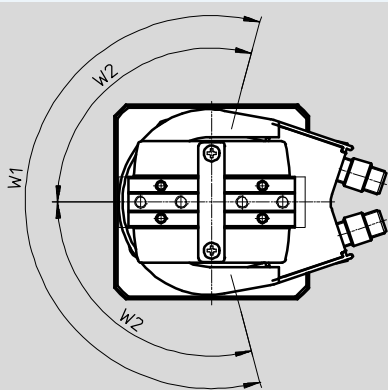

Swivel/gripper units HGDS-B

Technical data

FESTO

Cross-section at 1 → page 12

Size 12

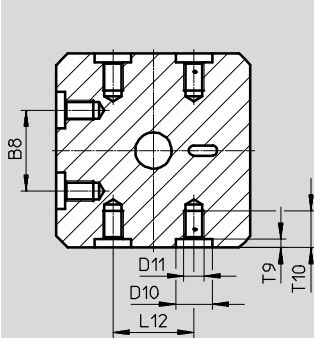

Size 16

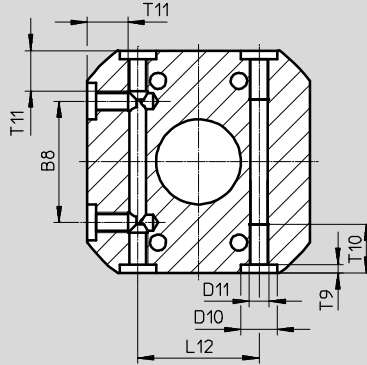

Size 20

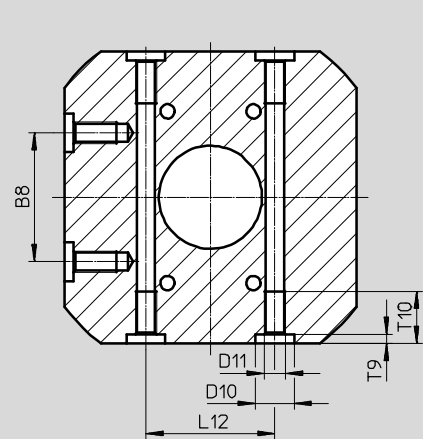

Size	B1	B2	B3	B4	B5	B6	B7	B8 ¹⁾	D1	D2	D3 ∅ H7	D4
[mm]		±0.03	±0.02		±0.02	±0.02	±0.1					
12	30	48	20	11.5	8	8	12.5	20	M6x0.5	M5	9	M3
16	34	55	30	13	10	10	16	30	M8x1	M5	9	M3
20	40	67.4	30	16	12	12	20	30	M10x1	M5	9	M4

Size	D5 ∅	D6	D7 ∅	D8 ∅	D9 ∅	D10 ∅	D11	EE	H1	H2	H3	H4
[mm]	H8		H8	H13	H13	H7			+1/-0.6	+0.8/-0.4	+1.3/-0.2	+0.8/-0.2
12	2	M3	2	7.5	4.5	9	M5	M5	113.4	111.9	85	58.2
16	2	M3	2	-	4.2	9	M5	M5	121.7	120.1	92.3	64.3
20	2.5	M4	2.5	-	4.2	9	M5	M5	154.8	152.8	112.3	81.7

Size	H5	H6	H7	H8	H9	H10	H11	H12	H13	H14	L1	L2
[mm]	±0.02	±0.12	±0.1	±0.1			-0.1		+1/-0.2	+1/-0.2	±0.5	±0.5
12	2	5	30	23	7.5	13.5	9.7	4.5	51.3	79.8	46	41
16	3	5	34.5	26	6.3	14	8	-	58.2	86.7	58	49
20	3	7	43	34.6	5.3	19	9	-	73.1	105.6	78	64

Size	L3	L4	L5	L6	L7	L8 ±1 P	L9 ±1		L10	L11	L12 ¹⁾	T1
							P1	YSRT				
[mm]	±0.5	±0.1		±0.05	±0.03				±0.02			min.
12	39	34	36	24	48	67	72.4	72.4	8	10	20	5.3
16	47	-	40.5	27.5	55	80.2	81.6	81.6	8	10	30	5
20	61	-	40.5	34	67.4	93.3	97	97	12	14	30	6

Size	T2	T3	T4	T5	T6	T7	T8	T9	T10	T11	W1	W2	∠ 1	∠ 2
[mm]	+0.1		±0.4	max.	min.	max.		+0.1						
12	2.1	12.1	6	5	3.5	6	4.6	2.1	10	-	210°	105°	2	2
16	2.1	12.1	6	6	4.5	6	-	2.1	12.1	10	210°	105°	2.5	2.5
20	2.1	12.1	9	8	6	7.5	-	2.1	12.1	-	210°	105°	3	2.5

1) Tolerance for centring holes ∅9 H7, tolerance for thread M5 ±0.1 mm

Swivel/gripper units HGDS-B

Technical data

FESTO

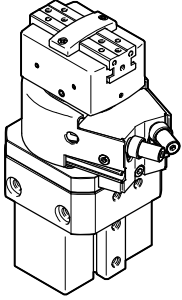
Ordering data			
	Size [mm]	Part No.	Type
	With cushioning P		
	12 ¹⁾	1187955	HGDS-PP-12-P-A-B
	16 ¹⁾	1187958	HGDS-PP-16-P-A-B
	20 ¹⁾	1187961	HGDS-PP-20-P-A-B
	With cushioning P1		
	12 ¹⁾	1187956	HGDS-PP-12-P1-A-B
	16 ¹⁾	1187959	HGDS-PP-16-P1-A-B
	20 ¹⁾	1187962	HGDS-PP-20-P1-A-B
	With cushioning YSRT		
	12 ¹⁾	1187957	HGDS-PP-12-YSRT-A-B
	16 ¹⁾	1187960	HGDS-PP-16-YSRT-A-B
	20 ¹⁾	1187963	HGDS-PP-20-YSRT-A-B

1) Two centring sleeves are included in the scope of delivery of the swivel/gripper unit.

Swivel/gripper units HGDS-B



Accessories



Adapter kit
HMVA, HMSV, HAVB

Material:
Wrought aluminium alloy
Free of copper and PTFE
RoHS-compliant

 Note
The kit includes the individual mounting interface as well as the necessary mounting material.

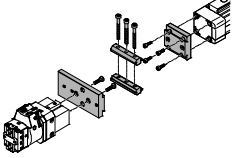

Permissible drive/gripper combinations with adapter kit					Download CAD data → www.festo.com		
Combination	Drive Size	Gripper Size	Mounting option		CRC ¹⁾	Part No.	Type
							
DGP..., DGE-..., DGEA/HGDS	DG...	HGDS					
	DGP...-25	12, 16, 20	■	■	2	177653	HMSV-7
	DGE-25		■	■		534290	HMSV-38
	DGEA-18					196788	HMVA-DLA18/25
	DGP...-40	12, 16, 20	■	■		177653	HMSV-7
	DGE-40		■	■		534290	HMSV-38
						196790	HMVA-DLA40

1) Corrosion resistance class CRC 2 to Festo standard FN 940070
Moderate corrosion stress. Indoor applications in which condensation may occur. External visible parts with primarily decorative requirements for the surface and which are in direct contact with the ambient atmosphere typical for industrial applications.

Swivel/gripper units HGDS-B

Accessories



FESTO



Ordering data					
	For size	Brief description	Part No.	Type	PU ¹⁾
Cushioning kit for P/P1/YSRT cushioning					
	12	P cushioning: – Flexible cushioning component	1731537	HGDS-12-P-B	1
	16		1731540	HGDS-16-P-B	
	20		1731544	HGDS-20-P-B	
	12	P1 cushioning: – Flexible cushioning component – Adjustable – With metal fixed stop	1731536	HGDS-12-P1-B	
	16		1731539	HGDS-16-P1-B	
	20		1731542	HGDS-20-P1-B	
	12	YSRT cushioning: – Shock absorber – Self-adjusting – With metal fixed stop	1731538	HGDS-12-YSRT-B	1
	16		1731541	HGDS-16-YSRT-B	
	20		1731545	HGDS-20-YSRT-B	



1) Packaging unit

Ordering data					Technical data → Internet: zbh	
	For size	Weight [g]	Part No.	Type	PU ¹⁾	
Centring sleeve ZBH						
	12, 16, 20	1	150927	ZBH-9	10	

1) Packaging unit

Ordering data – Proximity sensors for C-slot, magneto-resistive					Technical data → Internet: smt	
	Type of mounting	Electrical connection, connection direction	Switching output	Cable length [m]	Part No.	Type
N/O contact						
	Insertable in the slot from above	Cable, 3-wire, in-line	PNP	2.5	551373	SMT-10M-PS-24V-E-2,5-L-OE
		Plug M8x1, 3-pin, in-line		0.3	551375	SMT-10M-PS-24V-E-0,3-L-M8D
		Cable, 3-wire, lateral		2.5	551374	SMT-10M-PS-24V-E-2,5-Q-OE
		Plug M8x1, 3-pin, lateral		0.3	551376	SMT-10M-PS-24V-E-0,3-Q-M8D

Ordering data – Proximity sensors for C-slot, magnetic reed					Technical data → Internet: sme	
	Type of mounting	Electrical connection, connection direction	Switching output	Cable length [m]	Part No.	Type
N/O contact						
	Insertable in the slot from above	Cable, 3-wire, in-line	Contacting	2.5	551365	SME-10M-DS-24V-E-2,5-L-OE
		Cable, 2-wire, in-line		2.5	551369	SME-10M-ZS-24V-E-2,5-L-OE
		Plug M8x1, 3-pin, in-line		0.3	551367	SME-10M-DS-24V-E-0,3-L-M8D
		Cable, 3-wire, lateral		2.5	551366	SME-10M-DS-24V-E-2,5-Q-OE
		Cable, 2-wire, lateral		2.5	551370	SME-10M-ZS-24V-E-2,5-Q-OE
		Plug M8x1, 3-pin, lateral		0.3	551368	SME-10M-DS-24V-E-0,3-Q-M8D

Ordering data – Connecting cables				Technical data → Internet: nebu	
	Electrical connection, left	Electrical connection, right	Cable length [m]	Part No.	Type
	Straight socket, M8x1, 3-pin	Cable, open end, 3-wire	2.5	541 333	NEBU-M8G3-K-2.5-LE3
			5	541 334	NEBU-M8G3-K-5-LE3
	Angled socket, M8x1, 3-pin	Cable, open end, 3-wire	2.5	541 338	NEBU-M8W3-K-2.5-LE3
			5	541 341	NEBU-M8W3-K-5-LE3