

Mini slides DGST



Mini slides DGST

Key features

At a glance

- Compact mini slide
- Slide and yoke plate as a single component
- Excellent price/performance ratio
- High feed forces
- Symmetrical mounting interfaces
- Precise and resilient roller bearing guide
- Simple design with symmetrical mounting interfaces
- Can be operated without additional cushioning components

The technology in detail

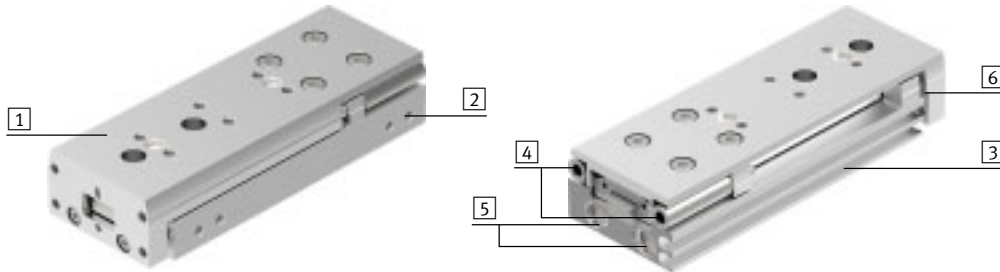

1 Slide and yoke plate



- Slide and yoke plate as a single component, ensuring very high rigidity, precision and angular alignment

2 Supply ports



- All connections on one side

3 Sensor slots for sensing the slide position

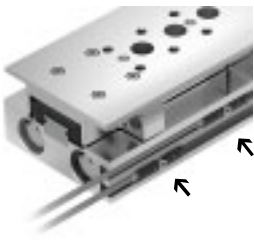

- Proximity sensors can be integrated, so there are no projecting parts
- Both end positions can be sensed from one side
- Two sensor slots for sensing

4 Cushioning and precision end-position adjustment

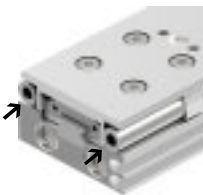

- Choice of three cushioning types:
 - Elastic cushioning at both ends, without end-position adjustment (E1)
 - Elastic cushioning at both ends, non-adjustable, with end-position adjustment (P)
 - Shock absorber at both ends, self-adjusting, with end-position adjustment (Y12)
- Precision end-position adjustment is possible from one side

5 Twin-piston drive

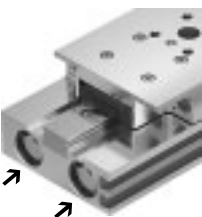

- Theoretical force at 6 bar: 34 ... 590 N
- Max. payload: 0.7 ... 17 kg

6 Backlash-free piston rod/yoke connection

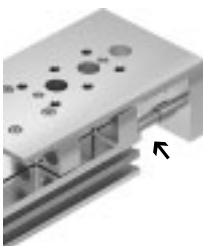

- Enhanced precision
- Longer service life

Mini slides DGST

Key features

Areas of application

Mainly in industry segments such as:

- Electronics and light assembly
- Machine building
- Handling technology

Examples:

- Pick & place handling units
- Piggyback handling units
- Precise positioning
- Precise press-fitting

Application examples

Pick & place handling unit

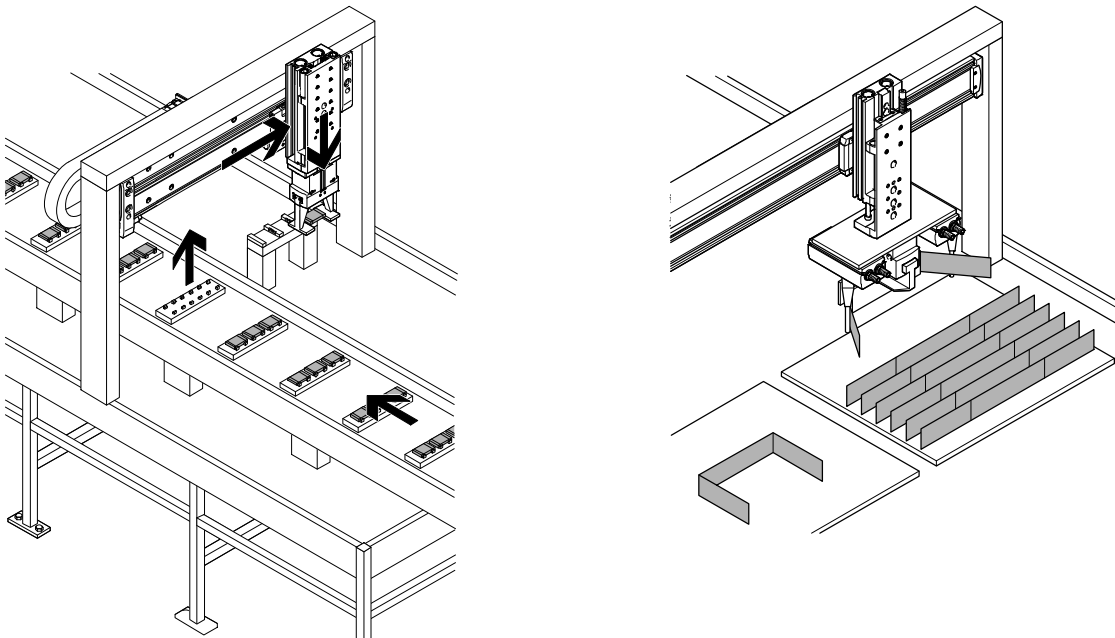

Precise positioning

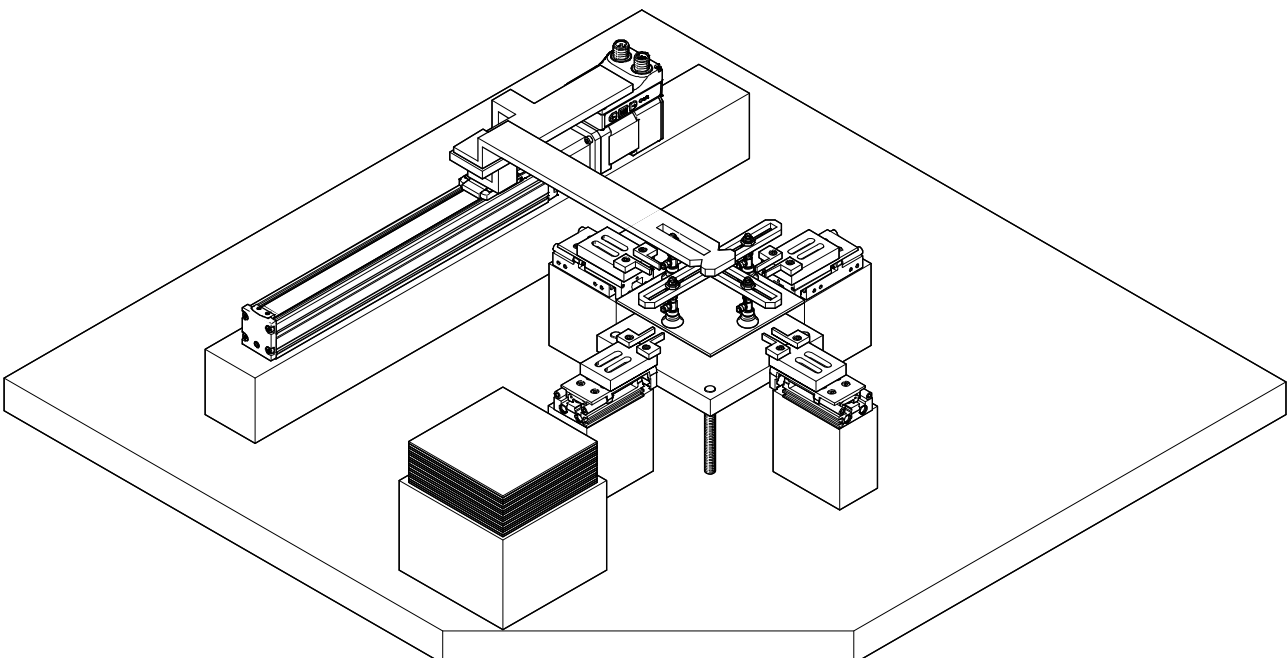

Mini slides DGST

Key features

Possible combinations of pick & place applications without adapter plate

Sizes 6 to 8

Other combinations

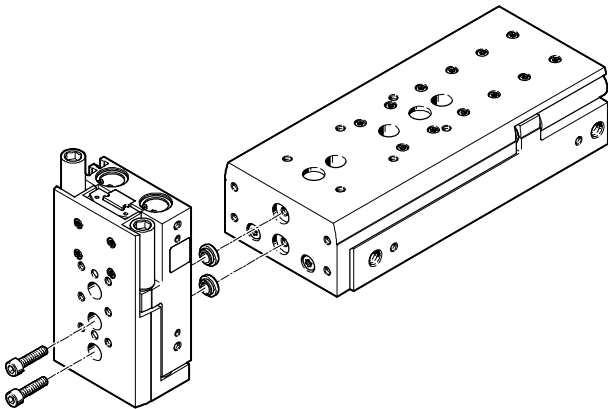
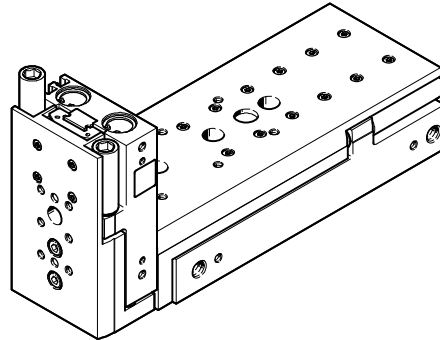
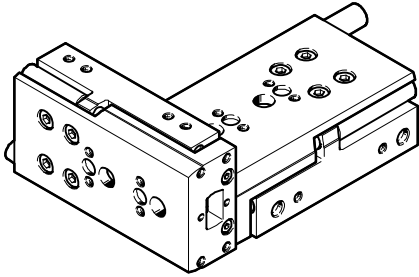

		1 Basic drive							
		Size	6	8	10	12	16	20	25
2 Assembly drive	6		-	2x M3x14 2x ZBH-5	2x M3x14 2x ZBH-5	-	-	-	-
	8		-	-	2x M3x18 2x ZBH-5	-	-	-	-
	10		-	-	-	2x M4x22 2x ZBH-7	2x M4x22 2x ZBH-7	-	-
	12		-	-	-	-	2x M4x27 2x ZBH-7	-	-
	16		-	-	-	-	-	2x M5x30 2x ZBV-12-9	-
	20		-	-	-	-	-	-	2x M6x40 2x ZBH-12

 Note

The mounting components are not included in the scope of delivery of the mini slide.

Mini slides DGST

Type code

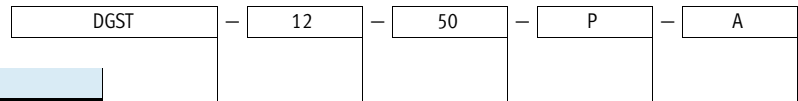

Type code	
Double-acting	
DGST	Mini slide

Size [mm]	
-----------	--

Stroke [mm]	
-------------	--

Cushioning	
E1	Elastic cushioning at both ends, without end-position adjustment
P	Elastic cushioning at both ends, non-adjustable, with end-position adjustment
Y12	Shock absorber at both ends, self-adjusting, with end-position adjustment

Position sensing	
A	Via proximity sensor

Mini slides DGST

Peripherals overview

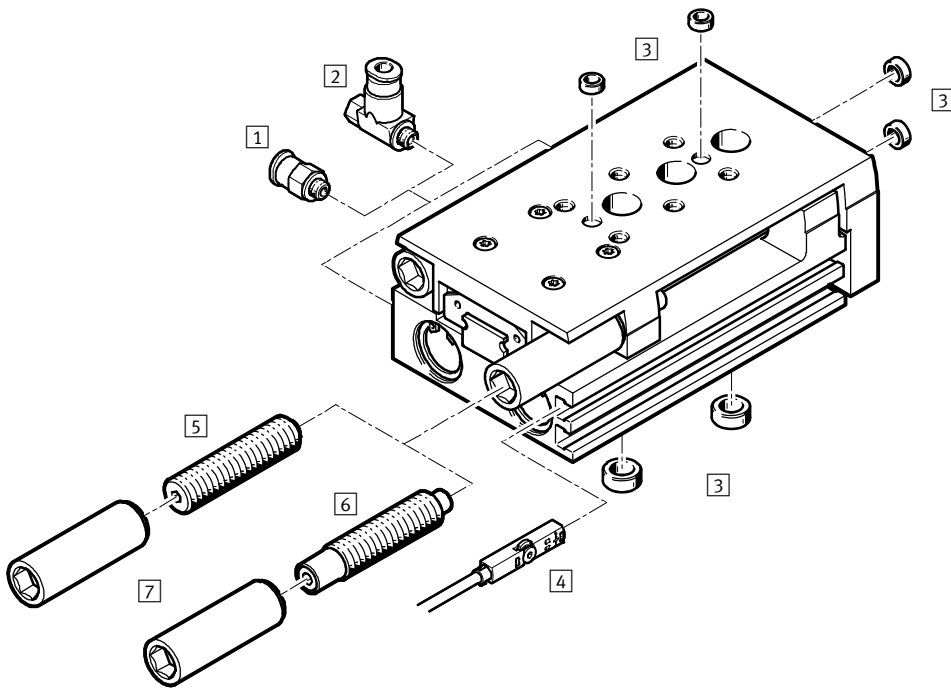



Accessories		
	Description	→ Page/Internet
1	Push-in fitting QSM	For connecting tubing with standard outside diameter 40
2	One-way flow control valve GRLA	For speed regulation 40
3	Centring sleeve ZBH	<ul style="list-style-type: none"> For centring loads and attachments (Centring sleeves not included in the scope of delivery of the mini slide) 40
4	Proximity sensor SMT-10/-8	For position sensing. Can be integrated in the sensor slot, which means there is no projection 41
	Position transmitter SMAT-8M, SDAT	<ul style="list-style-type: none"> Analogue position feedback possible Choice of analogue output: 0 ... 10 V, 0 ... 20 mA 41
5	Cushioning P	Elastic cushioning at both ends, non-adjustable, with end-position adjustment 40
6	Cushioning Y12	Shock absorber at both ends, self-adjusting, with end-position adjustment 40
7	Threaded sleeve	<ul style="list-style-type: none"> For mounting the cushioning components Included in the scope of delivery of cushioning 5/6 40

Mini slides DGST

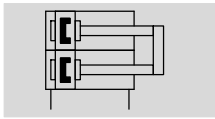
Technical data



-  Size
6 ... 25
-  Stroke length
10 ... 200 mm



General technical data									
Size	6	8	10	12	16	20	25		
Design	Scotch yoke system								
Guide	Recirculating ball bearing guide						Three-part cage guide		
Mode of operation	Double-acting								
Type of mounting	Via through-hole								
	Via female thread								
Pneumatic connection	M3		M5			G1/8			
Stroke ¹⁾	[mm]	10 ... 50	10 ... 80	10 ... 100	10 ... 100	10 ... 150	10 ... 200	10 ... 200	
Cushioning									
DGST-...-E1	Elastic cushioning at both ends, without end-position adjustment								
DGST-...-P	Elastic cushioning at both ends, non-adjustable, with end-position adjustment								
DGST-...-Y12	Shock absorber at both ends, self-adjusting, with end-position adjustment								
Max. cushioning length									
DGST-...-E1 ²⁾	[mm]	0.25/0.9	0.5/1.5	0.6/1.6	0.5/1.1	0.6/0.8	0.5/1	0.5/1.2	
DGST-...-P	[mm]	0.9	1.8	1.8	2	1.8	2	2	
DGST-...-Y12	[mm]	4	4	4	5	5	8	10	
Position sensing	For proximity sensor								
Mounting position	Any								
Max. speed									
DGST-...-E1	[m/s]	0.5							
DGST-...-P	[m/s]	0.5	0.8						
DGST-...-Y12	[m/s]	0.5							
Repetition accuracy									
DGST-...-E1	[mm]	≤ 0.3							
DGST-...-P	[mm]	≤ 0.3							
DGST-...-Y12	[mm]	≤ 0.02							

1) For variant DGST-...-E1, the actual stroke is somewhat longer → Page 18

2) Advanced end position/retracted end position

Operating and environmental conditions								
Size	6	8	10	12	16	20	25	
Operating medium	Compressed air to ISO 8573-1:2010 [7:4:4]							
Note on the operating medium	Lubricated operation possible (in which case lubricated operation will always be required)							
Operating pressure ¹⁾	[bar]	1.5 ... 8		1 ... 8				
Ambient temperature	[°C]	-10 ... +60						
Corrosion resistance class CRC ²⁾		1						

1) For sizes 6/8/10/12, the min. operating pressure can be increased slightly after a rest period > 24 h.

2) Corrosion resistance class CRC 1 to Festo standard FN 940070

Low corrosion stress. For dry indoor applications or transport and storage protection. Also applies to parts behind covers, in the non-visible interior area, and parts which are covered in the application (e.g. drive trunnions).

Mini slides DGST

Technical data

Forces and impact energy								
Size		6	8	10	12	16	20	25
Theoretical force at 6 bar, advancing	[N]	34	60	94	136	241	377	589
Theoretical force at 6 bar, retracting	[N]	25	45	79	102	207	317	495
Impact energy in the end positions								
DGST-...-E1	[Nm]	0.005	0.03	0.05	0.07	0.15	0.2	0.3
DGST-...-P	[Nm]	0.018	0.05	0.08	0.12	0.25	0.35	0.45
DGST-...-Y12 per stroke	[Nm]	0.09	0.18	0.28	0.48	0.85	1.9	3.6
Max. operating frequency								
DGST-...-Y12	[cycles/min]	50	80	80	80	70	50	50

For cushioning DGST-...-E1/-P, the following applies:

Permissible impact velocity:
$$v_{perm.} = \sqrt{\frac{2 \times E_{perm.}}{m_{intrinsic} + m_{Load}}}$$

Maximum permissible load:
$$m_{Load} = \frac{2 \times E_{perm.}}{v^2} - m_{intrinsic}$$

- $v_{perm.}$ Perm. impact velocity
- $E_{perm.}$ Max. impact energy
- $m_{intrinsic}$ Moving mass (drive)
- m_{Load} Moving payload

 **Note**
These specifications represent the maximum values that can be achieved. Note the maximum permissible impact energy.

For cushioning DGST-...-Y12, the following applies:

Permissible impact velocity:
$$v_{perm.} = \sqrt{\frac{2 \times (E_{vel.} - (F + (m_{Load} + m_{intrinsic}) \times g \times \sin(\alpha)) \times s)}{m_{Load} + m_{intrinsic}}}$$

Maximum permissible load:
$$m_{Load} = \frac{E_{vel.} - F \times s}{\frac{1}{2} \times v^2 + g \times s \times \sin(\alpha)} - m_{intrinsic}$$

- $v_{perm.}$ Perm. impact velocity
- $E_{vel.}$ Kinetic impact energy
- F Cylinder force minus friction force
- m_{Load} Moving payload
- $m_{intrinsic}$ Moving mass (drive)
- g Acceleration due to gravity
- s Shock absorber stroke
- α Impact angle
- v Impact velocity

 **Note**
These specifications represent the maximum values that can be achieved. Note the maximum permissible impact energy.

Mini slides DGST

Technical data

Weight [g]								
Size	Stroke [mm]	6	8	10	12	16	20	25
Product weight without cushioning component								
	10	90	129	247	391	454	978	1463
	20	107	154	254	456	526	970	1528
	30	124	176	292	501	510	994	1547
	40	140	200	324	563	629	1055	1743
	50	172	236	359	611	690	1196	1816
	80	–	310	496	776	930	1618	2452
	100	–	–	561	988	1060	1962	2868
	125	–	–	–	–	1294	2346	3507
	150	–	–	–	–	1402	2686	3927
	200	–	–	–	–	–	3275	4803
Moving mass without cushioning component								
	10	49	69	124	195	235	440	714
	20	57	80	134	238	278	456	762
	30	65	92	146	242	277	455	762
	40	73	103	165	284	324	498	877
	50	88	122	177	290	342	549	897
	80	–	155	240	360	462	759	1217
	100	–	–	269	465	515	890	1388
	125	–	–	–	–	637	1068	1703
	150	–	–	–	–	660	1221	1877
	200	–	–	–	–	–	1460	2282
Cushioning components (two cushioning components and two threaded sleeves)								
DGST-...-P		5	8.4	11.7	23	41	72.5	136.5
DGST-...-Y12		3.9	7.8	10.2	16	33	57	105

Materials

Sectional view

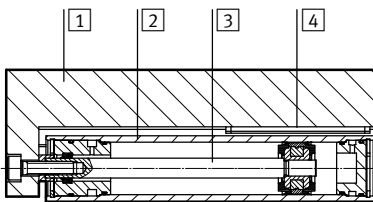

Mini slide	
1	Slide Anodised wrought aluminium alloy
2	Housing Anodised wrought aluminium alloy
3	Piston rod High-alloy stainless steel
4	Guide High-alloy stainless steel, POM, TPE
–	Seals HNBR
Note on materials Free of copper and PTFE RoHS-compliant	

Mini slides DGST

Technical data

Parallelism

The term parallelism refers to the alignment accuracy between the mounting surface and the slide surface in the longitudinal direction.

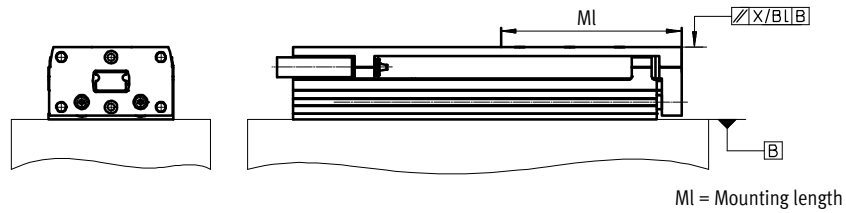

MI = Mounting length

Size Stroke [mm]	6	8	10	12	16	20	25
10	0.092/43 ¹⁾	0.09/45	0.093/54	0.086/55	0.089/61	0.081/80	0.088/90
20	0.082/43	0.081/45	0.09/54	0.08/55	0.085/61	0.081/80	0.088/90
30	0.079/43	0.078/45	0.084/54	0.076/55	0.081/61	0.081/80	0.082/90
40	0.114/65	0.118/70	0.085/54	0.075/55	0.083/61	0.075/80	0.076/90
50	0.096/65	0.103/70	0.113/76	0.101/77	0.109/85	0.065/80	0.07/90
80	-	0.095/70	0.091/76	0.095/77	0.084/85	0.074/130	0.074/130
100	-	-	0.091/76	0.072/77	0.098/101	0.062/130	0.061/130
125	-	-	-	-	0.081/101	0.063/160	0.063/160
150	-	-	-	-	0.079/101	0.055/160	0.055/160
200	-	-	-	-	-	0.044/160	0.044/160

1) Parallelism/mounting length

Linearity

The term linearity refers to the alignment accuracy between the mounting surface and the slide surface in relation to the stroke.

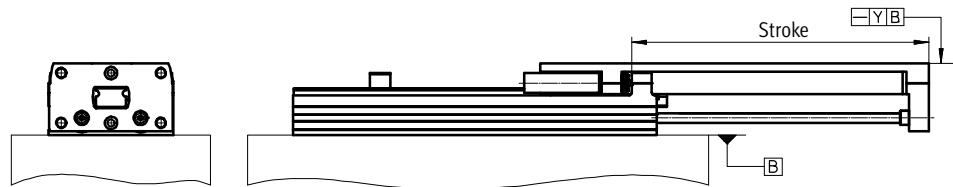

Size Stroke [mm]	6	8	10	12	16	20	25
10	0.013	0.012	0.011	0.011	0.01	0.009	0.009
20	0.021	0.02	0.018	0.016	0.016	0.014	0.014
30	0.025	0.024	0.023	0.021	0.021	0.02	0.018
40	0.029	0.028	0.026	0.025	0.025	0.022	0.021
50	0.031	0.029	0.029	0.027	0.026	0.024	0.023
80	-	0.034	0.032	0.032	0.03	0.02	0.027
100	-	-	0.035	0.032	0.032	0.027	0.027
125	-	-	-	-	0.033	0.028	0.028
150	-	-	-	-	0.035	0.03	0.03
200	-	-	-	-	-	0.032	0.032

Mini slides DGST

Technical data

Adjustable end-position range

Precision adjustment of the advanced and retracted end position

Precision adjustment of the required stroke reduction is possible using the cushioning components.

Advantages:

- No readjustment required; position is fully maintained under load
- Stroke reduction down to the next smaller standard stroke is possible
- Fast and simple adjustment using two tools

Step 1:

Screw the cushioning component and sleeve into the holder using a hex wrench until the stop is reached

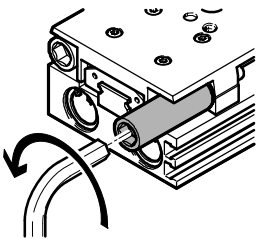

Step 2:

Set the exact end position using a smaller hex wrench

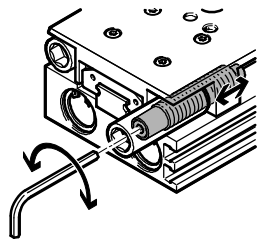

Step 3:

Lock the cushioning component in place by tightening the sleeve

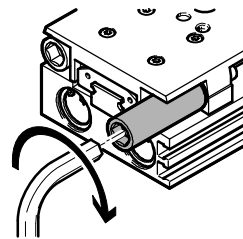

Adjustable end-position range [mm] per end position/stroke reduction								
Size		6	8	10	12	16	20	25
Extended end position								
With cushioning	P	-12.1	-14.3	-15.6	-21.1	-21.7	-32.0	-46.0
	Y12	-10.2	-15.8	-15.1	-15.7	-15.9	-27.0	-31.0
Retracted end position								
With cushioning	P	-12.1	-14.6	-15.8	-21.5	-22.0	-31.5	-46.0
	Y12	-10.2	-16.1	-15.3	-16.1	-16.2	-26.5	-31.0

End-position adjustment

To prevent damage to the mini slide, adjustment length L should not fall below the specified length.

Dimensions:

For DGST-...-P: → Page 35

For DGST-...-Y12: → Page 36

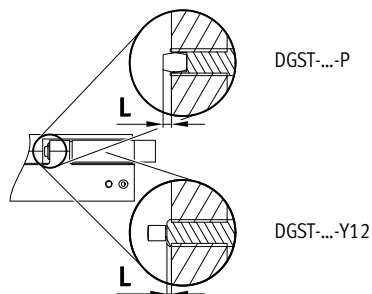

 Note

Adjust and secure the shock absorber under compressed air.

Mini slides DGST

Technical data

Dynamic characteristic load values

The indicated torques refer to the centre of the guide.
These values must not be exceeded during dynamic operation. Special attention must be paid to the cushioning phase.

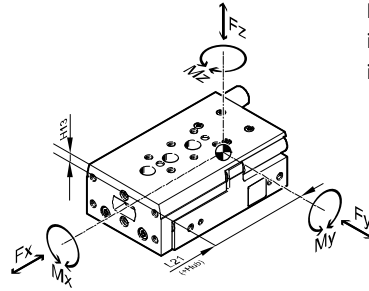

If the drive is simultaneously subjected to several of the forces and torques indicated below, the following equation must be satisfied in addition to the indicated maximum loads:

$$f_v = \frac{|F_{y,dyn}|}{F_{y,max}} + \frac{|F_{z,dyn}|}{F_{z,max}} + \frac{|M_{x,dyn}|}{M_{x,max}} + \frac{|M_{y,dyn}|}{M_{y,max}} + \frac{|M_{z,dyn}|}{M_{z,max}} \leq 1$$

f_v = load comparison factor:

Position of the guide centre

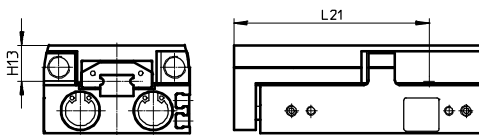

Calculation example

Given:

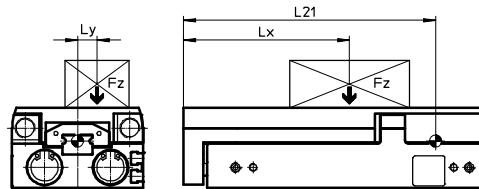

- Mini slide = DGST-10
- Stroke length = 80 mm
- Lever arm L_x = 50 mm
- Lever arm L_y = 30 mm
- Mass F_z = 0.8 kg
- Acceleration a = 0 m/s²

To be calculated:

- F_y, F_z, M_x, M_y, M_z
- and
- Verification of operation with combined load

Solution:

$L_{21} = 110.2$ mm from table

$F_y = 0$ N

$F_z = m \times g$
= 0.8 kg x 9.81 m/s² = 7.848 N

$M_x = m \times g \times L_y$
= 0.8 kg x 9.81 m/s² x 30 mm = 0.236 Nm

$M_y = m \times g \times [(L_{21} + \text{stroke}) - L_x]$
= 0.8 kg x 9.81 m/s² x [(110.2 mm + 80 mm) - 50 mm] = 1.1 Nm

$M_z = 0$ Nm

Combined load:

$$f_v = \frac{|F_{y,dyn}|}{F_{y,max}} + \frac{|F_{z,dyn}|}{F_{z,max}} + \frac{|M_{x,dyn}|}{M_{x,max}} + \frac{|M_{y,dyn}|}{M_{y,max}} + \frac{|M_{z,dyn}|}{M_{z,max}} \leq 1$$

$$= 0 + \frac{7.848\text{N}}{52\text{N}} + \frac{0.236\text{Nm}}{6\text{Nm}} + \frac{1.1\text{Nm}}{5\text{Nm}} + 0 = 0.274 \leq 1$$

Permissible forces and torques					Geometric characteristics	
Size	Stroke [mm]	$F_{y,max}, F_{z,max}$ [N]	$M_{x,max}$ [Nm]	$M_{y,max}, M_{z,max}$ [Nm]	H13 [mm]	L21 [mm]
6						
	10	200	1.1	0.7	9.35	31
	20	220	1.1	1		39.5
	30	240	1.1	1.2		51
	40	260	1.2	1.2		59.5
	50	280	1.4	1.2		73.5
8						
	10	250	2	2	10.75	31
	20	275	2	2		39.5
	30	300	2.8	2		51
	40	325	3	2.5		59.5
	50	350	3.2	3		73.5
	80	375	3.2	3		103.5

Mini slides DGST

Technical data

Permissible forces and torques					Geometric characteristics	
Size	Stroke [mm]	F _y max, F _z max [N]	M _x max [Nm]	M _y max, M _z max [Nm]	H13 [mm]	L21 [mm]
10						
	10	470	3	3	12.25	45.7
	20	480	3	3		45.7
	30	490	3.5	3		58.5
	40	500	4	4.5		65.7
	50	510	5	4.5		78.5
	80	520	6	5		110.2
	100	530	6	6		130.2
12						
	10	500	4.2	4.2	14.5	43
	20	520	4.2	4.2		53
	30	540	4.2	4.2		63
	40	560	5.8	5.8		73
	50	580	7	5.8		83
	80	600	8.9	6.5		113
	100	620	10	6.8		139
16						
	10	820	11.3	7	16.5	48.5
	20	840	11.3	7		55.5
	30	860	11.3	7.5		59.5
	40	880	11.3	8		71.5
	50	900	11.3	8		88.5
	80	920	12	10		119
	100	940	12	10		139
	125	960	14	15		171.5
	150	960	14	16		196.5
20						
	10	1600	16	18	16	70
	20	1270	13	14		70
	30	1110	11	12		71
	40	930	10	11		82
	50	1080	9	10		93.6
	80	1030	14	11		131.4
	100	1160	18	11		160.3
	125	1380	20	17		192.6
	150	1300	20	17		222.8
	200	1170	20	17		279.6
25						
	10	1840	19	21	21	69.2
	20	1460	16	16		69.2
	30	1280	14	14		78.2
	40	1310	13	12		88.2
	50	1080	12	11		98.2
	80	1030	14	11		133.4
	100	1160	18	11		162.8
	125	1380	20	17		194.6
	150	1300	20	17		224.8
	200	1170	20	17		281.6

Mini slides DGST

Technical data

Payload load m as a function of impact velocity v and cushioning $P/E1$

DGST-6

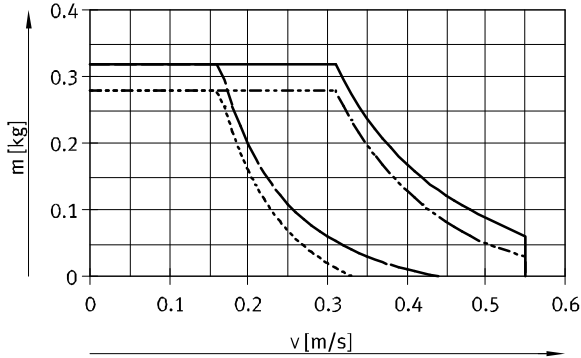

- DGST-6-10-P
- - - DGST-6-50-P
- DGST-6-10-E1
- - - DGST-6-50-E1

DGST-8

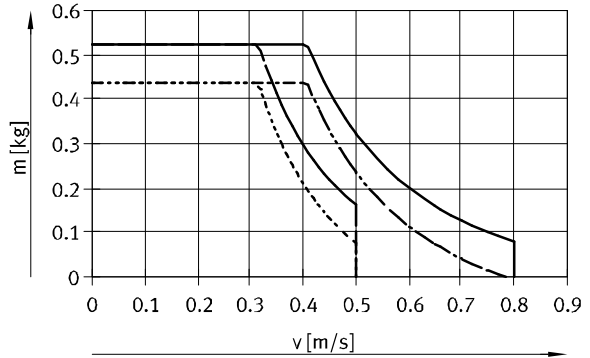

- DGST-8-10-P
- - - DGST-8-80-P
- DGST-8-10-E1
- - - DGST-8-80-E1

DGST-10

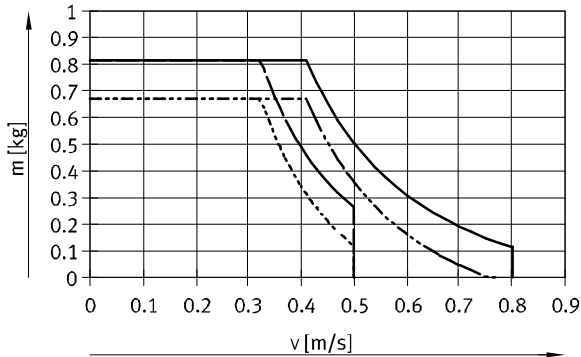

- DGST-10-10-P
- - - DGST-10-100-P
- DGST-10-10-E1
- - - DGST-10-100-E1

DGST-12

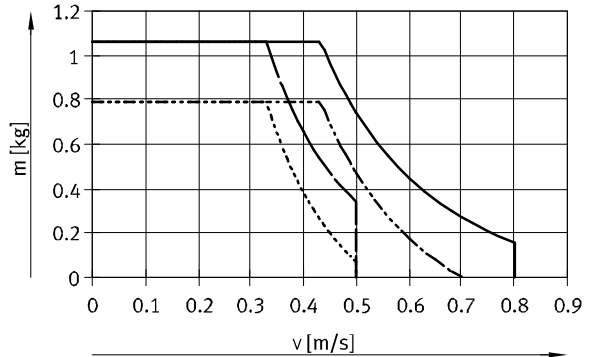

- DGST-12-10-P
- - - DGST-12-100-P
- DGST-12-10-E1
- - - DGST-12-100-E1

Mini slides DGST

Technical data

Payload load m as a function of impact velocity v and cushioning P/E1

DGST-16

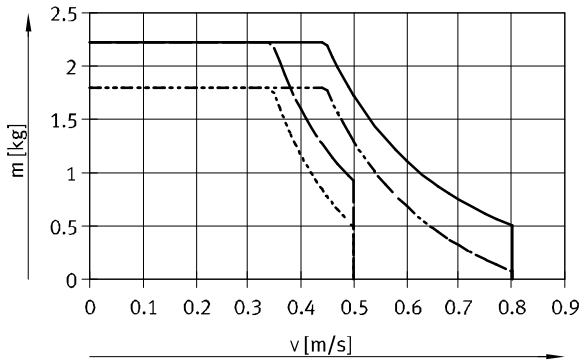

- DGST-16-10-P
- - - DGST-16-150-P
- DGST-16-10-E1
- - - DGST-16-150-E1

DGST-20

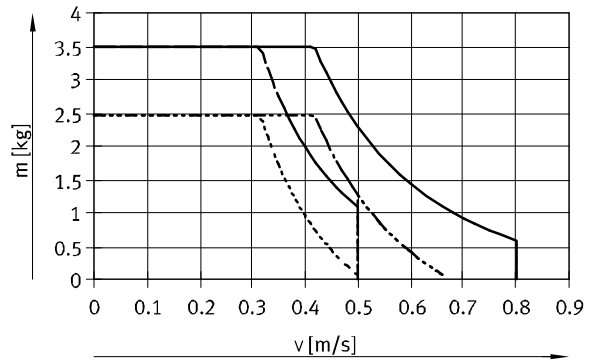

- DGST-20-10-P
- - - DGST-20-200-P
- DGST-20-10-E1
- - - DGST-20-200-E1

DGST-25

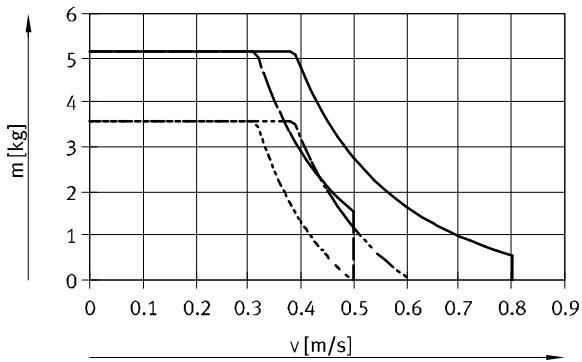

- DGST-25-10-P
- - - DGST-25-200-P
- DGST-25-10-E1
- - - DGST-25-200-E1

Mini slides DGST

Technical data

Payload load m as a function of impact velocity v and cushioning Y12

DGST-6

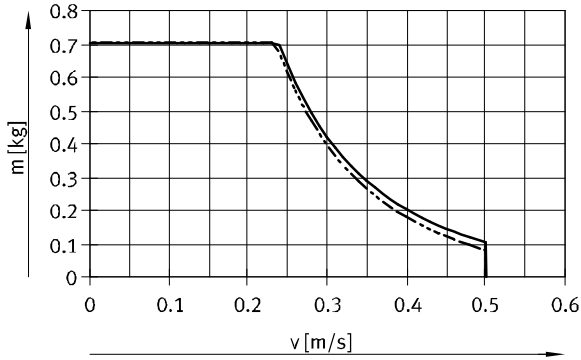

- DGST-6-30-Y12
- - - DGST-6-50-Y12

DGST-8

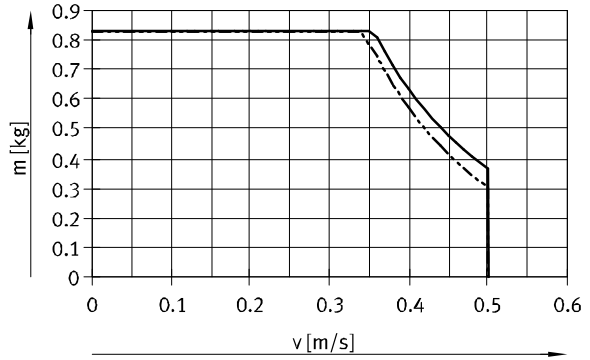

- DGST-8-30-Y12
- - - DGST-8-80-Y12

DGST-10

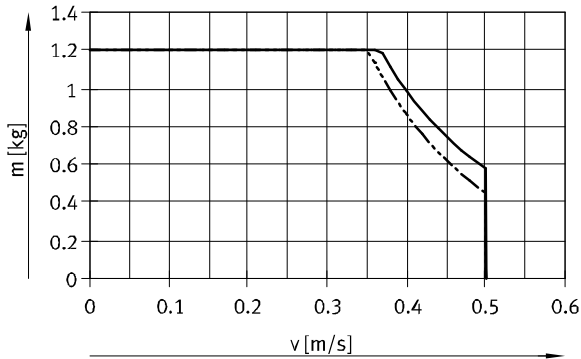

- DGST-10-30-Y12
- - - DGST-10-100-Y12

DGST-12

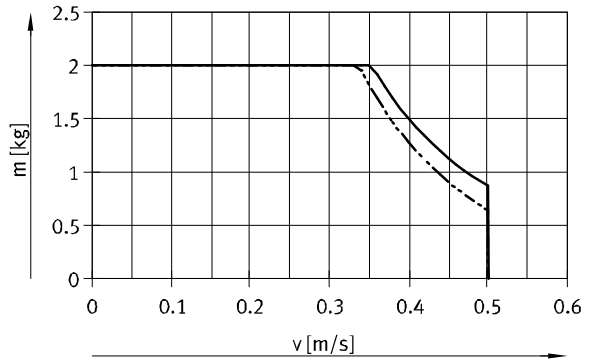

- DGST-12-30-Y12
- - - DGST-12-100-Y12

Mini slides DGST

Technical data

Payload load m as a function of impact velocity v and cushioning Y12

DGST-16

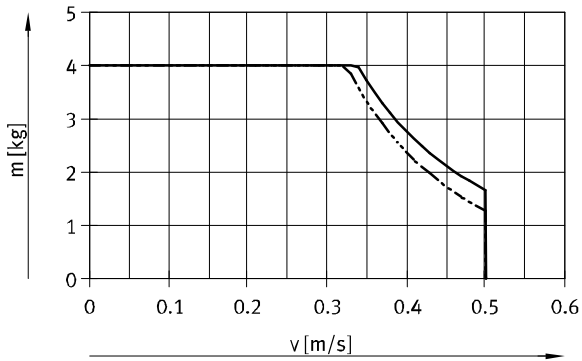

- DGST-16-30-Y12
- - - DGST-16-150-Y12

DGST-20

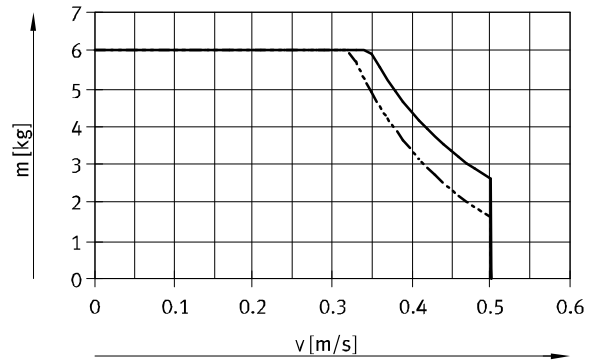

- DGST-20-30-Y12
- - - DGST-20-200-Y12

DGST-25

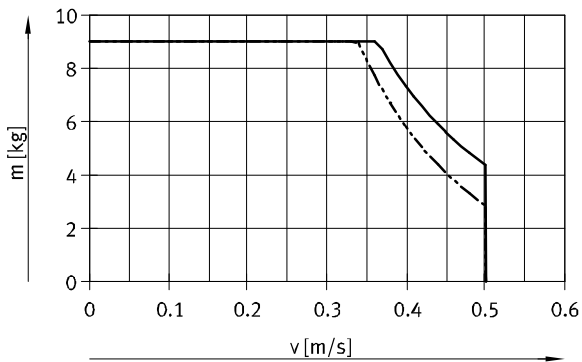

- DGST-25-30-Y12
- - - DGST-25-200-Y12

Mini slides DGST

Technical data

Dimensions

Download CAD data → www.festo.com

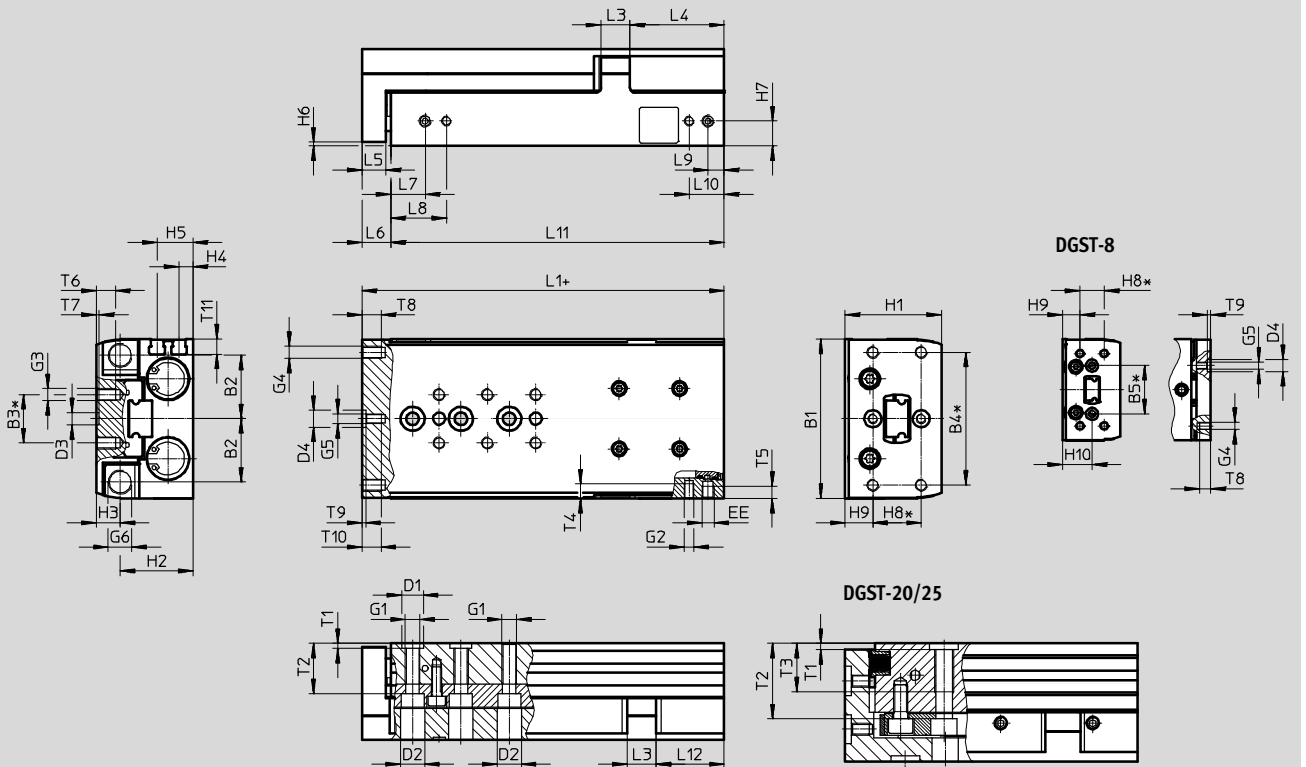

Actual stroke for variant DGST...-E1 =
 Stroke + additional stroke without cushioning + cushioning stroke
 (Values → Page 19)

+ plus stroke length
 * ±0.02 mm for the centring
 ±0.1 mm for the thread

Size	B1	B2	B3	B4	B5	D1	D2	D3	D4	EE	G1	G2	G3	G4
			±0.1	±0.1		∅ H7	∅	∅ H7	∅					
6	35	14.4	10	30	-	5	6	5	2 ^{H8}	M3	M4	M3	M3	M3
8	42	17	10	30	20	5	6	5	5 ^{H7}	M5	M4	M3	M3	M3
10	50	20.8	20	40	-	7	8	5	5 ^{H7}	M5	M5	M4	M4	M4
12	60	24.5	20	40	-	7	8	5	7 ^{H7}	M5	M5	M4	M4	M4
16	66	26.3	20	55	-	9	10	5	7 ^{H7}	M5	M6	M4	M5	M5
20	85	34.5	40	70	-	12	11	12	12 ^{H7}	G1/8	M8	M5	M5	M5
25	104	42	40	80	-	12	11	12	12 ^{H7}	G1/8	M8	M6	M6	M6

Size	G5	G6	H1	H2	H3	H4	H5	H6	H7	H8	H9	H10	L3	L4
6	-	M4x0.5	20	14.5	5.5	2.5	7	1.5	4.5	10	5	-	5	22
8	M3	M5x0.5	24	17.7	6.3	3.1	8.1	1.5	5.6	10	7.25	12.3	6	30.5
10	M3	M6x0.5	29	21	8	4	10	1.5	7	20	5	-	8	31
12	M4	M8x1	36	26.5	9.5	5.9	11.9	1.5	8.9	20	9.5	-	10	36
16	M4	M10x1	40	30	10	5.8	14.8	1.5	10.3	20	11.55	-	12	39
20	M5	M12x1	49	36.5	12.5	8.7	17.7	2.5	13.2	20	15.5	-	14.5	51
25	M6	M14x1	60	44.5	15.5	11	21	2.5	16	40	10	-	17.5	65

Mini slides DGST

Technical data

Size	L5	L6 ¹⁾	L7	L8 ²⁾	L9	L10 ²⁾	T1	T2	T3	T4	T5
									max.	max.	max.
6	6	8	8.5	15.4	5.8	12.7	1.3 ^{+0.1}	8.9	–	4	4
8	6	8	8.5	16.5	5.5	13.5	1.3 ^{+0.1}	11.5	–	5	4.5
10	8	10	8.9	17.9	6.6	15.6	1.6 ^{+0.1}	14.5	–	6.2	5
12	8	10	10.7	19.5	7	15.8	1.6 ^{+0.1}	19.8	–	7	5.5
16	10	12	14.2	23	6.7	15.5	2.1 ^{+0.1}	20.8	–	6	5
20	10	12.5	16.5	30.5	8	22	2.6 ^{+0.3}	31.2	20	8	8.5
25	12	14.5	16.5	31.5	10.5	25.5	2.6 ^{+0.3}	37.2	20	9.5	8

Size	T7	T8	T9	T10	T11	Additional stroke without cushioning for variant DGST-...-E1		Max. cushioning stroke in the end positions for variant DGST-...-E1	
						min.	max.	Advanced	Retracted
6	1.3 ^{+0.1}	4.5	–	–	4.6	0.65	1.3	0.25	0.9
8	1.3 ^{+0.1}	4.5	1.3 ^{+0.1}	–	5	0	0.7	0.5	1.6
10	1.3 ^{+0.1}	6.5	1.3 ^{+0.1}	6.5	5.9	0	0.7	0.6	1.6
12	1.3 ^{+0.1}	6.5	1.6 ^{+0.1}	8	7	0.4	1.1	0.5	1.1
16	1.3 ^{+0.1}	8	1.6 ^{+0.1}	8	6.3	0.65	1.4	0.6	0.65
20	2.6 ^{+0.3}	8	2.6 ^{+0.3}	10	9.1	0.4	1.1	0.5	1
25	2.6 ^{+0.3}	10	2.6 ^{+0.3}	13	8.8	0.5	1.2	0.5	1.2

Stroke [mm]	10	20	30	40	50	80	100	125	150	200
Size										
	L1 ¹⁾									
6	48	58	68	78	95	–	–	–	–	–
8	51	61	71	81	95	126	–	–	–	–
10	66	68	78	88	98	136	156	–	–	–
12	66	76	86	96	106	136	169.5	–	–	–
16	73	80	87	97	112	150	170	210	235	–
20	97	97	97	107	121	166	204.5	244	279	343
25	102	102	108	118	128	168	207	246	281	345
	L11									
6	40	50	60	70	87	–	–	–	–	–
8	43	53	63	73	87	118	–	–	–	–
10	56	58	68	78	88	126	146	–	–	–
12	56	66	76	86	96	126	159.5	–	–	–
16	61	68	75	85	100	138	158	198	223	–
20	84.5	84.5	84.5	94.5	108.5	153.5	192	231.5	266.5	330.5
25	87.5	87.5	93.5	103.5	113.5	153.5	192.5	231.5	266.5	330.5
	L12									
6	16	16	16	16	22	–	–	–	–	–
8	15.7	15.7	15.7	15.7	19.7	20.7	–	–	–	–
10	24.6	16.6	16.6	16.6	16.6	24.6	24.6	–	–	–
12	20.6	20.6	20.6	20.6	20.6	20.6	34.1	–	–	–
16	21.2	18.2	15.2	15.2	20.2	28.2	28.2	39	39	–
20	39.5	29.5	19.5	19.5	23.5	38.5	51	51	51	51
25	36.5	26.5	22.5	22.5	22.5	32.5	51.5	65	65	65
	T6 (max.)									
6	4	4	4	4	4	–	–	–	–	–
8	5.5	5.5	5.5	5.5	5.5	5.5	–	–	–	–
10	4.5	4.5	4.5	4.5	4.5	7.5	7.5	–	–	–
12	5.2	5.2	5.2	5.2	5.2	8	8	–	–	–
16	7.2	7.2	7.2	7.2	7.2	8	8	8	8	–
20	8	8	8	8	8	8	8	8	8	8
25	11	11	11	11	11	11	11	11	11	11

1) At an operating pressure with 6 bar

2) Not available with sizes 6 and 8 with stroke of 10 mm. For size 16 with stroke of 80 ... 150 mm, the measurement is 14.5 mm

Mini slides DGST

Technical data

Hole pattern for mounting threads and centring holes

Download CAD data → www.festo.com

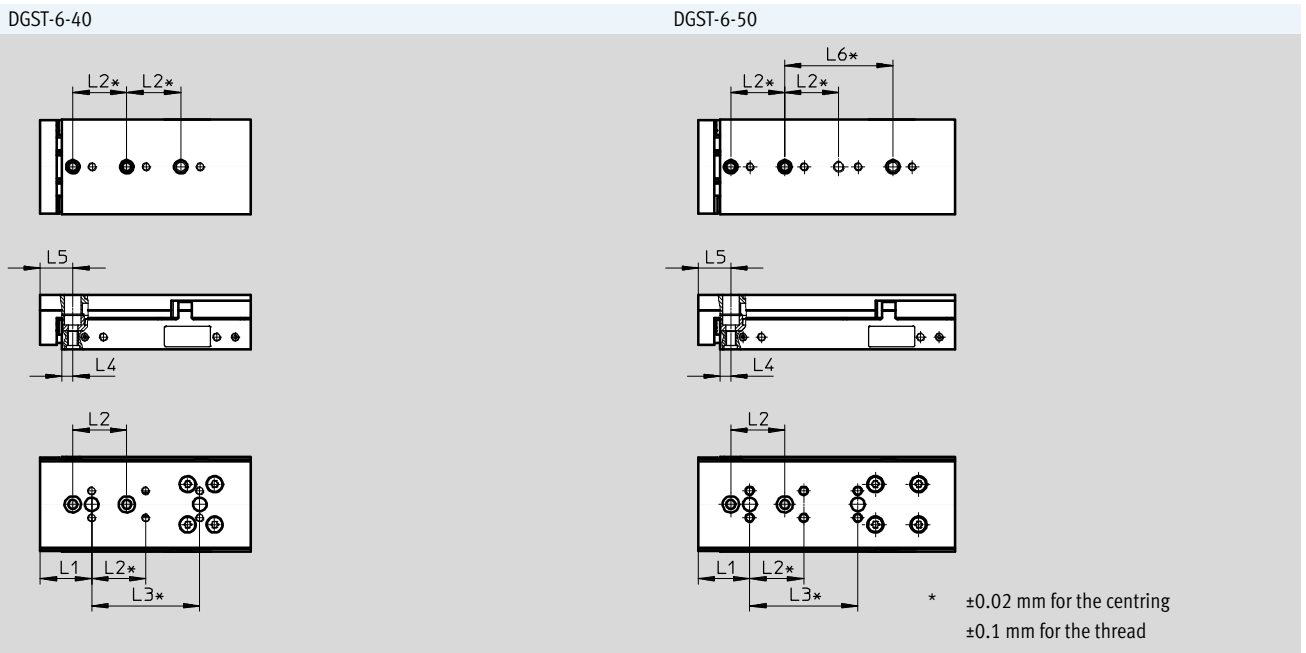
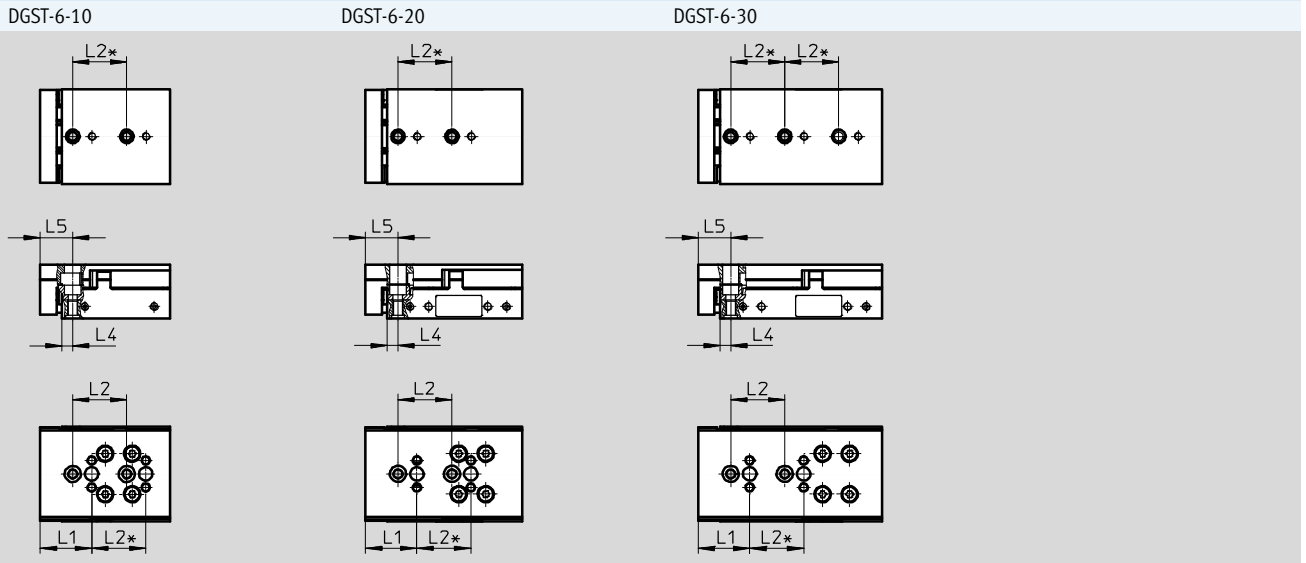

Size	Stroke [mm]	L1	L2	L3	L4	L5	L6
6	10	19	20	-	4	12	-
	20			-			-
	30			-			-
	40			40			-
	50			40			40

Mini slides DGST

Technical data

Hole pattern for mounting threads and centring holes

Download CAD data → www.festo.com

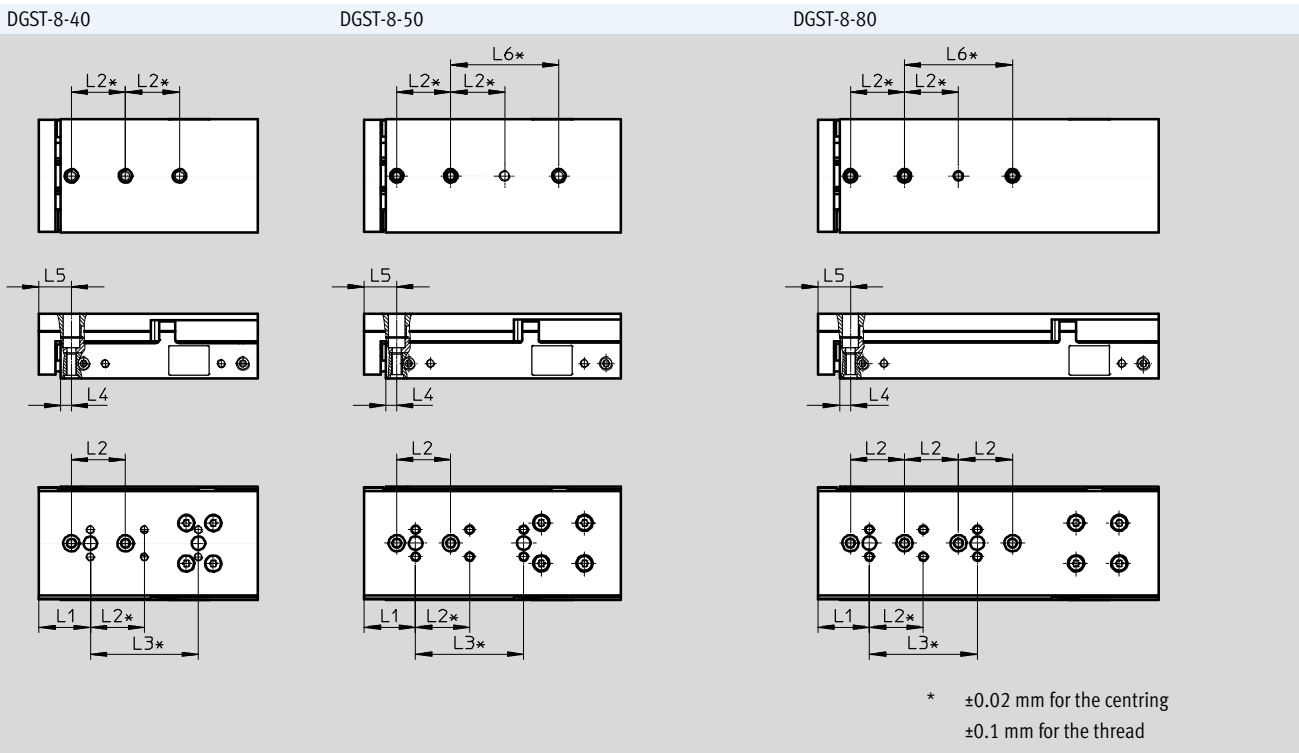
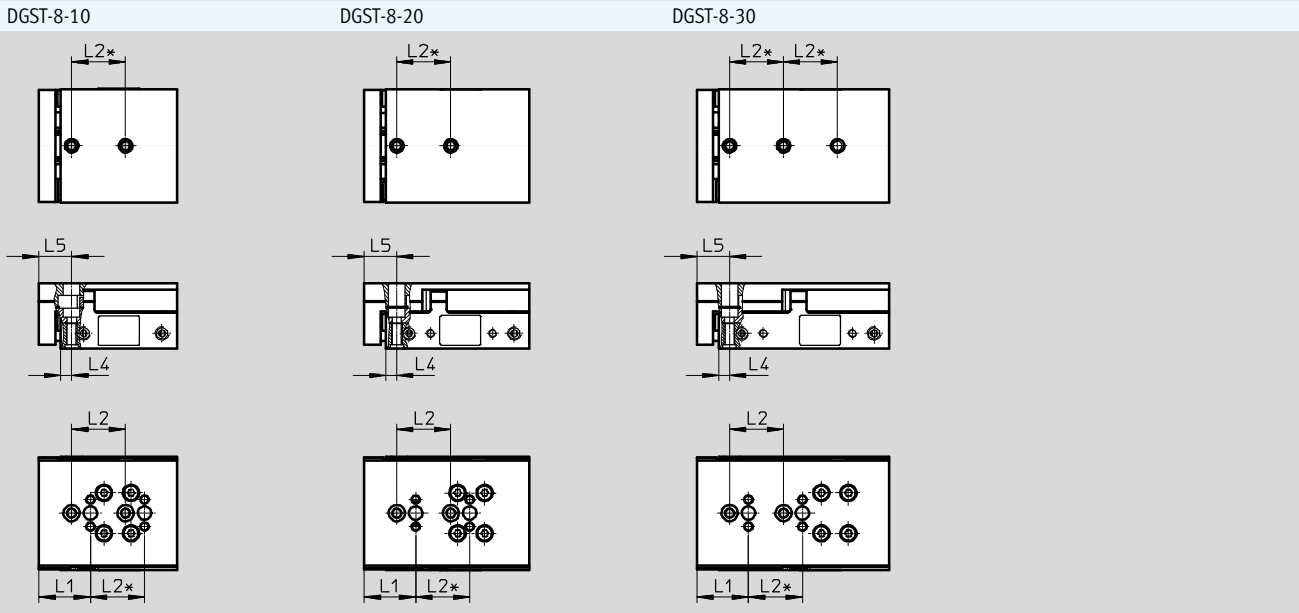

Size	Stroke [mm]	L1	L2	L3	L4	L5	L6
8	10	19	20	-	4	12	-
	20			-			-
	30			-			-
	40			40			-
	50			40			40
	80			40			40

Mini slides DGST

Technical data

Hole pattern for mounting threads and centring holes

Download CAD data → www.festo.com

DGST-10-10/20

DGST-10-30

DGST-10-40/50

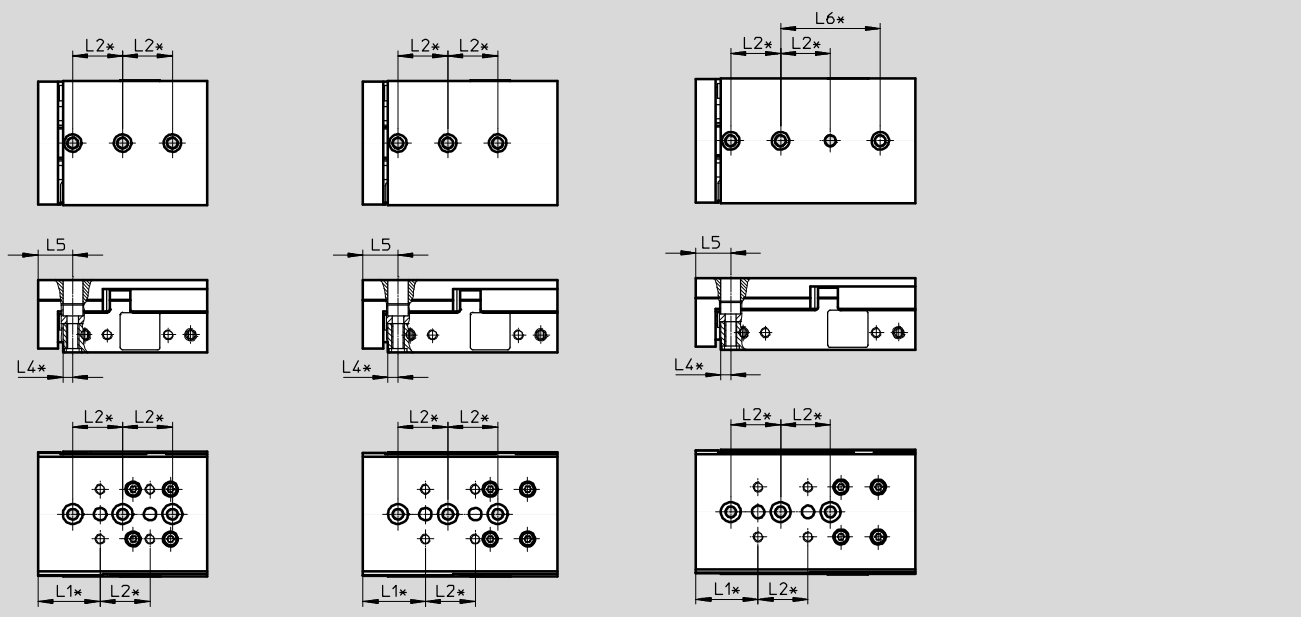

DGST-10-80

DGST-10-100

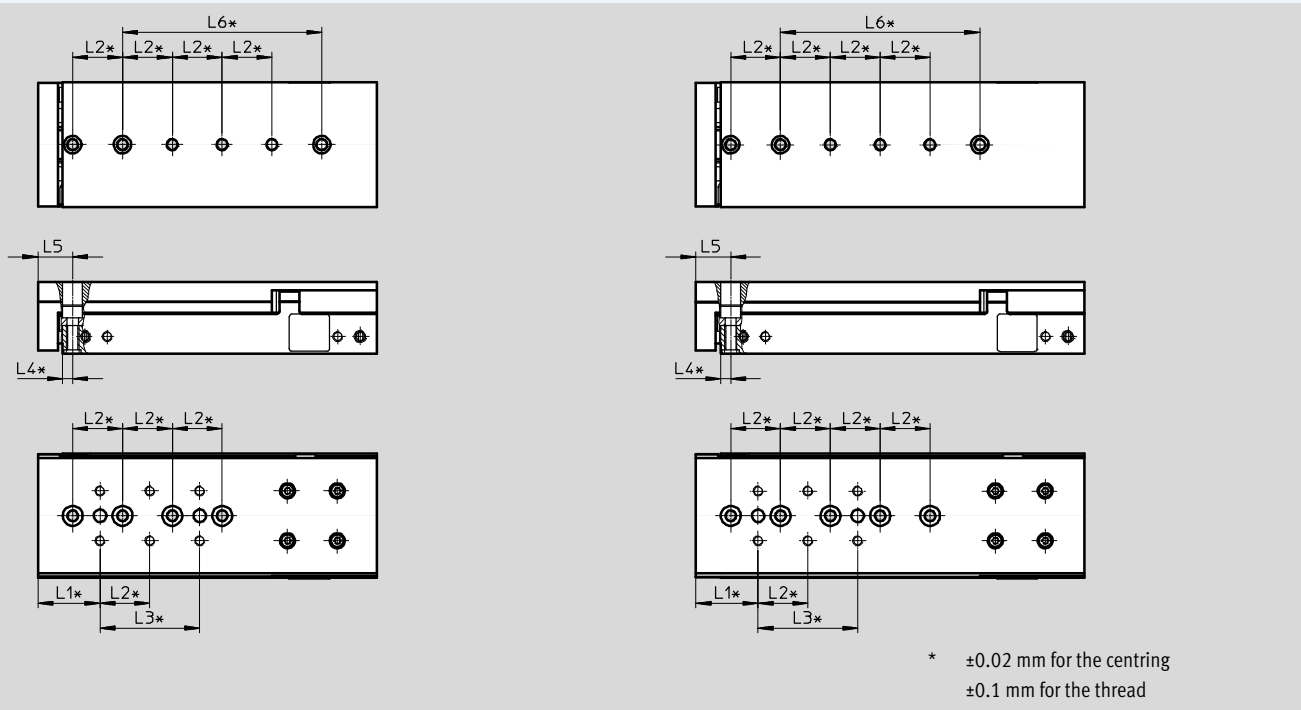

Size	Stroke [mm]	L1	L2	L3	L4	L5	L6
10	10, 20	25	20	-	4	14	-
	30			-			-
	40, 50			-			40
	80			40			80
	100			40			80

Mini slides DGST

Technical data

Hole pattern for mounting threads and centring holes

Download CAD data → www.festo.com

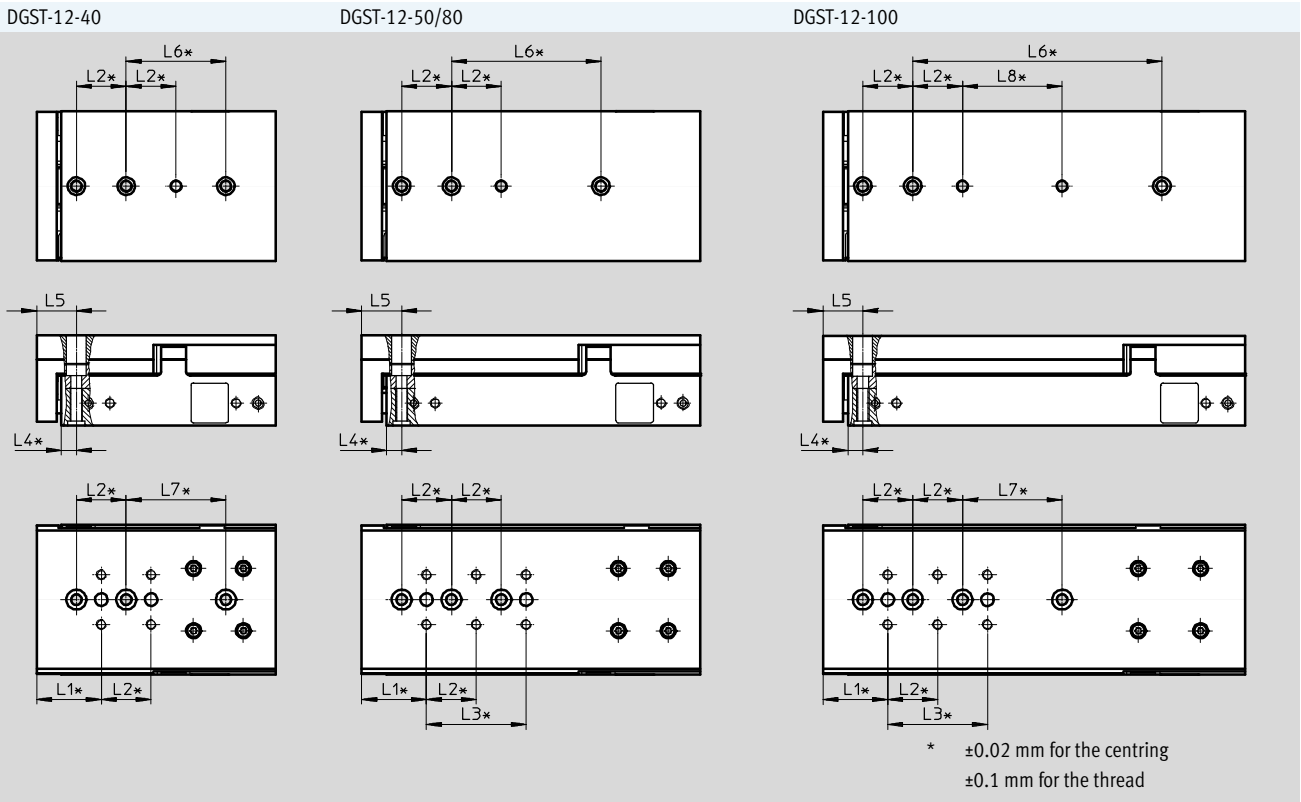
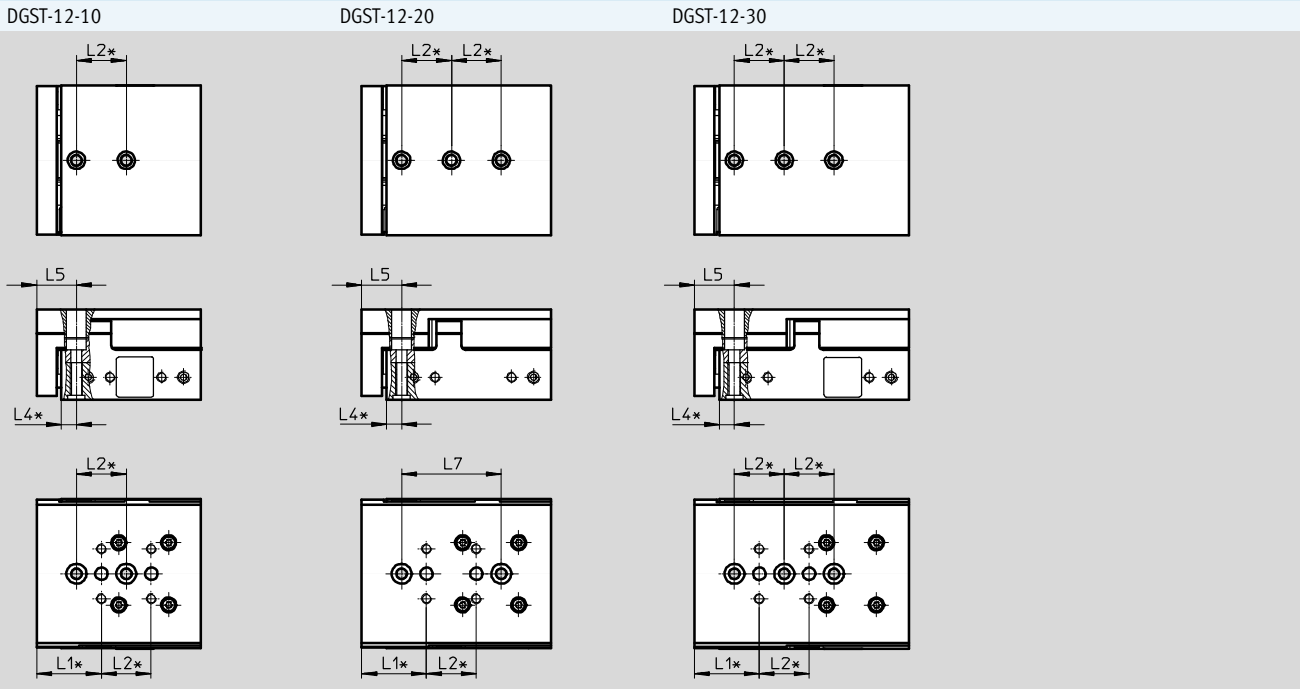

Size	Stroke [mm]	L1	L2	L3	L4	L5	L6	L7	L8
12	10	26	20	-	6	16	-	-	-
	20			-			40	-	
	30			-			-	-	
	40			40			40	-	
	50, 80			40			-	-	
	100			40			100	40	40

Mini slides DGST

Technical data

Hole pattern for mounting threads and centring holes

Download CAD data → www.festo.com

DGST-16-10

DGST-16-20/30

DGST-16-40

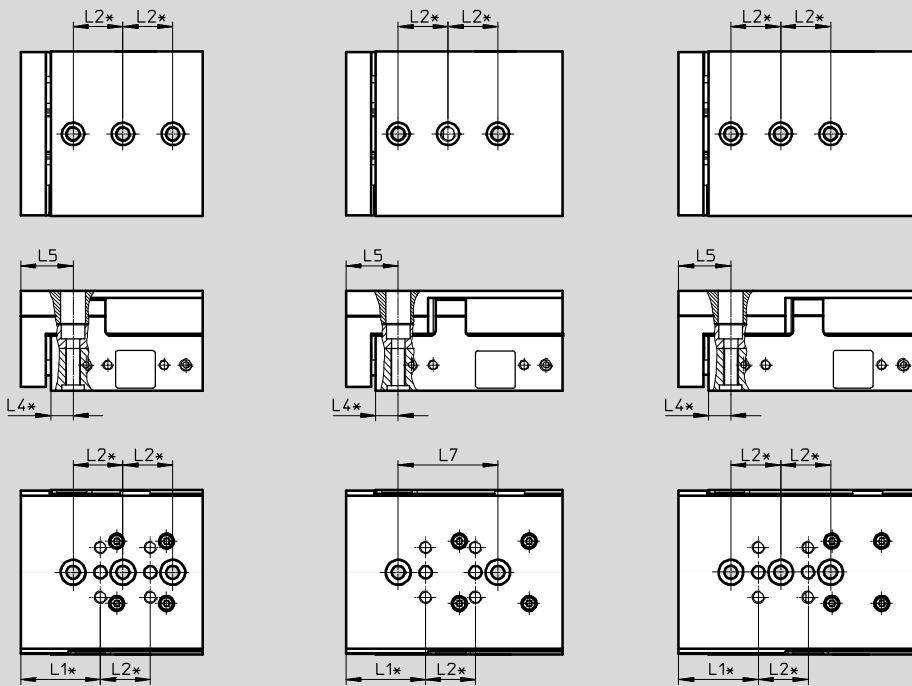

* ±0.02 mm for the centring
±0.1 mm for the thread

Size	Stroke [mm]	L1	L2	L4	L5	L7
16	10	32	20	9	21	–
	20					40
	30					40
	40					–

Mini slides DGST

Technical data

Hole pattern for mounting threads and centring holes

Download CAD data → www.festo.com

DGST-16-50

DGST-16-80

DGST-16-100

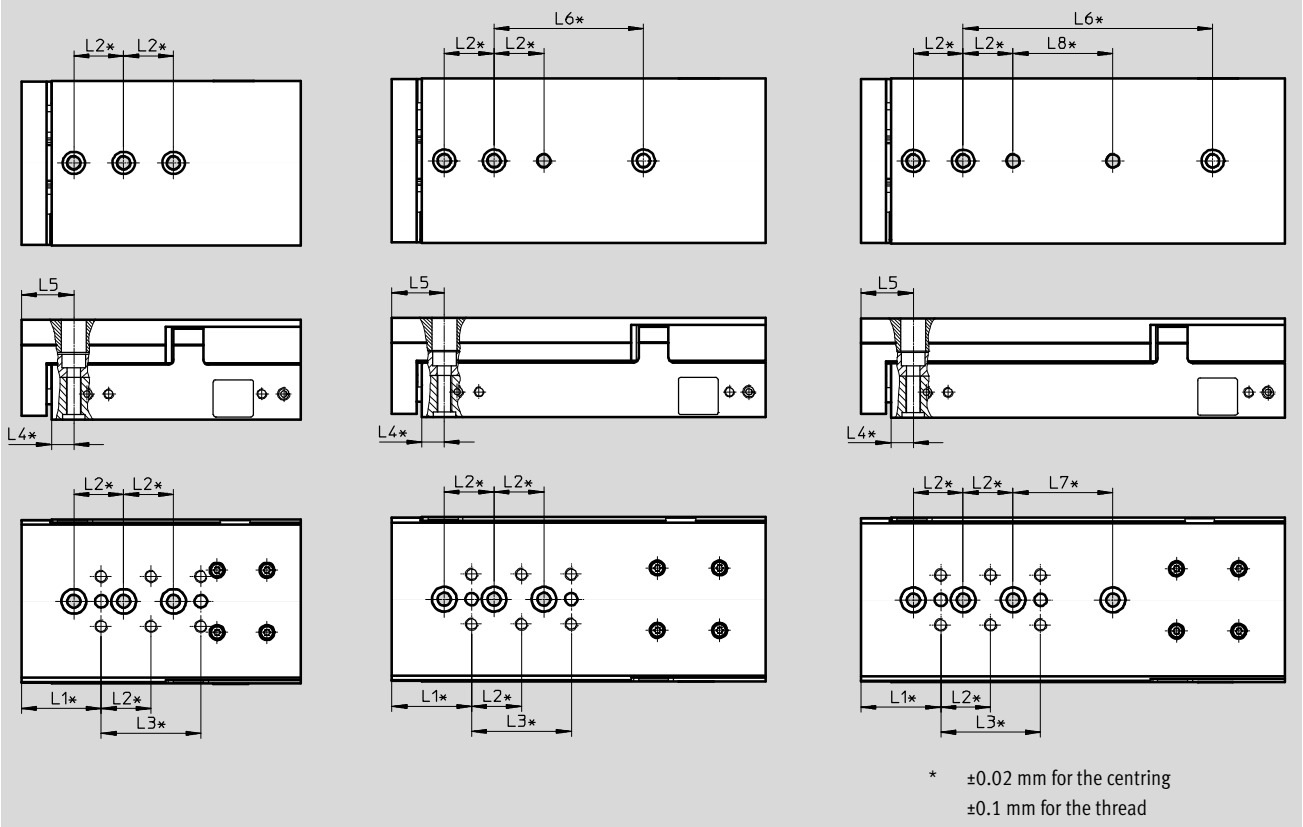

Size	Stroke [mm]	L1	L2	L3	L4	L5	L6	L7	L8
16	50	32	20	40	9	21	-	-	-
	80						60	-	-
	100						100	40	40

Mini slides DGST

Technical data

Hole pattern for mounting threads and centring holes

Download CAD data → www.festo.com

DGST-16-125

DGST-16-150

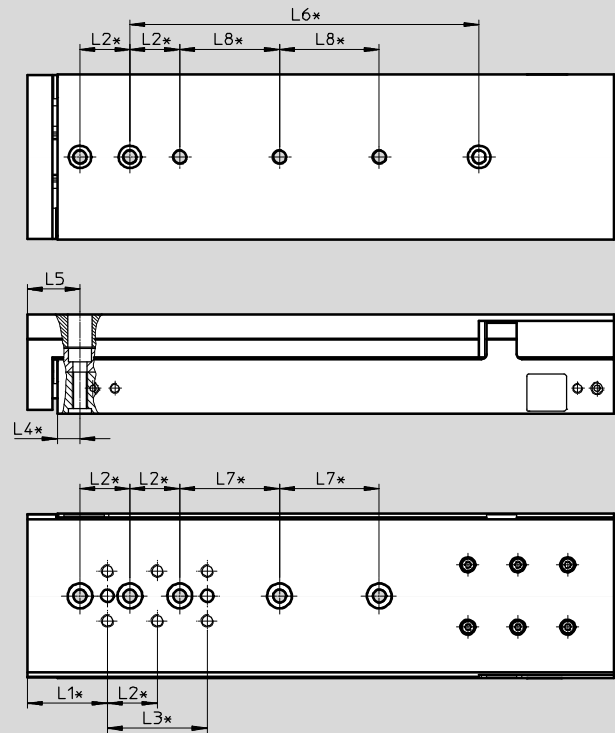
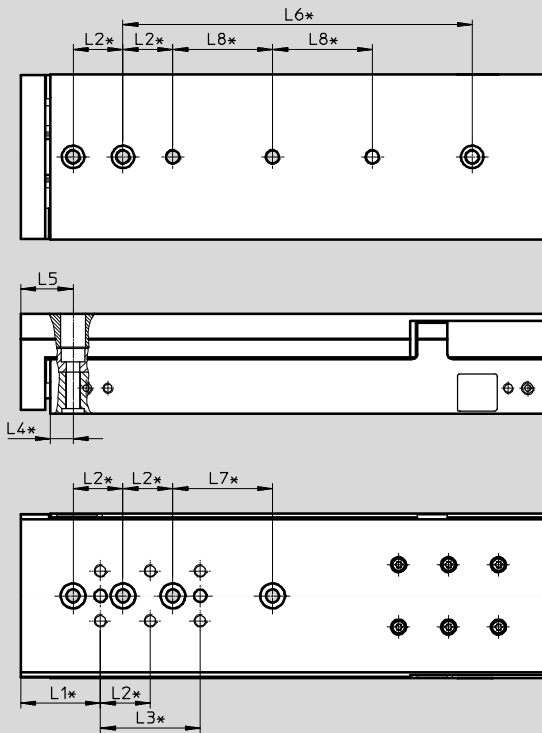

* ±0.02 mm for the centring
±0.1 mm for the thread

Size	Stroke [mm]	L1	L2	L3	L4	L5	L6	L7	L8
16	125	32	20	40	9	21	140	40	40
	150								

Mini slides DGST

Technical data

Hole pattern for mounting threads and centring holes

Download CAD data → www.festo.com

DGST-20-10/20/30/40

DGST-20-50

DGST-20-80

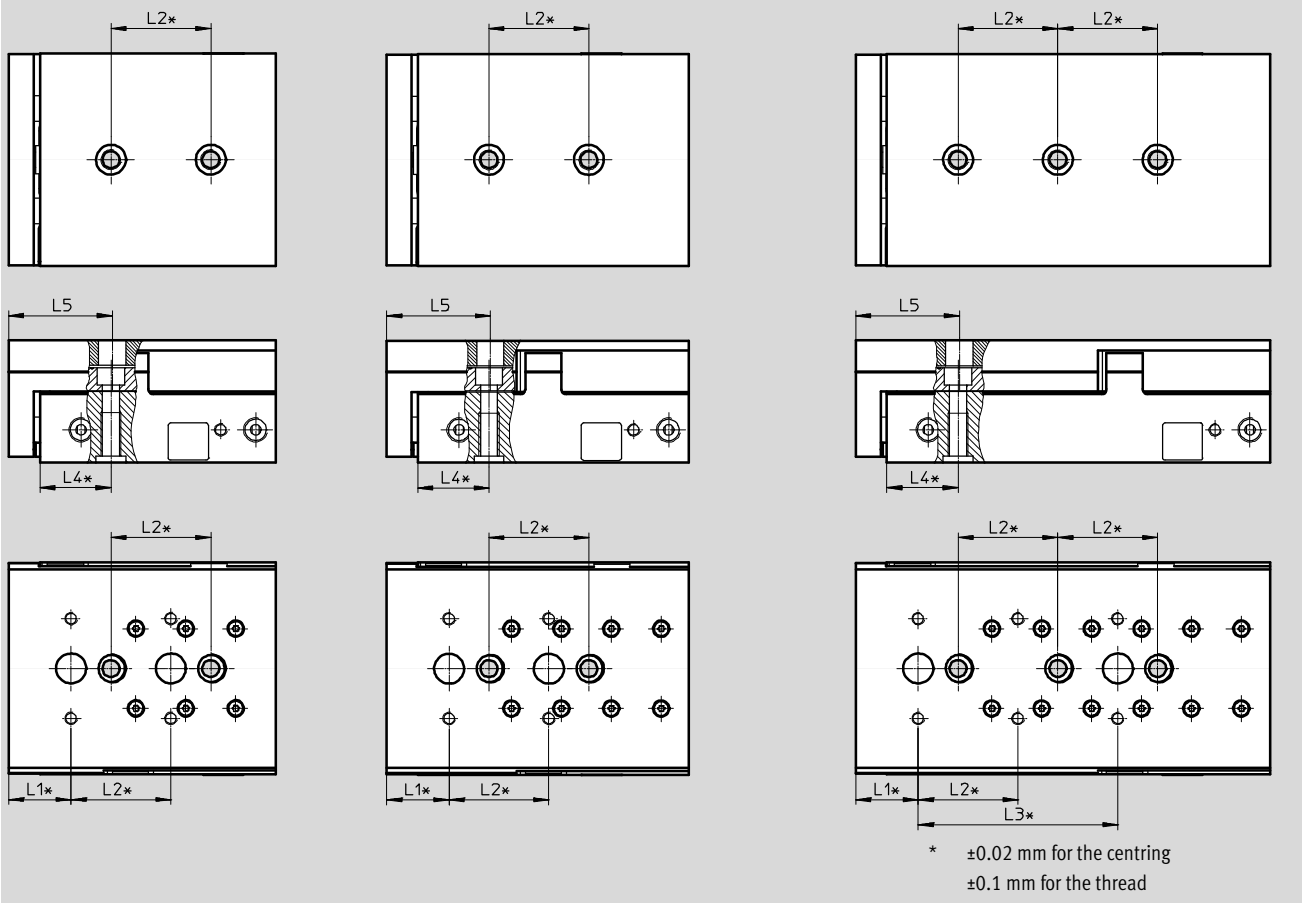

Size	Stroke [mm]	L1	L2	L3	L4	L5
20	10	25	40	-	28.5	41.5
	20			-		
	30			-		
	40			-		
	50			-		
	80			80		

Mini slides DGST

Technical data

Hole pattern for mounting threads and centring holes

Download CAD data → www.festo.com

DGST-20-100

DGST-20-125

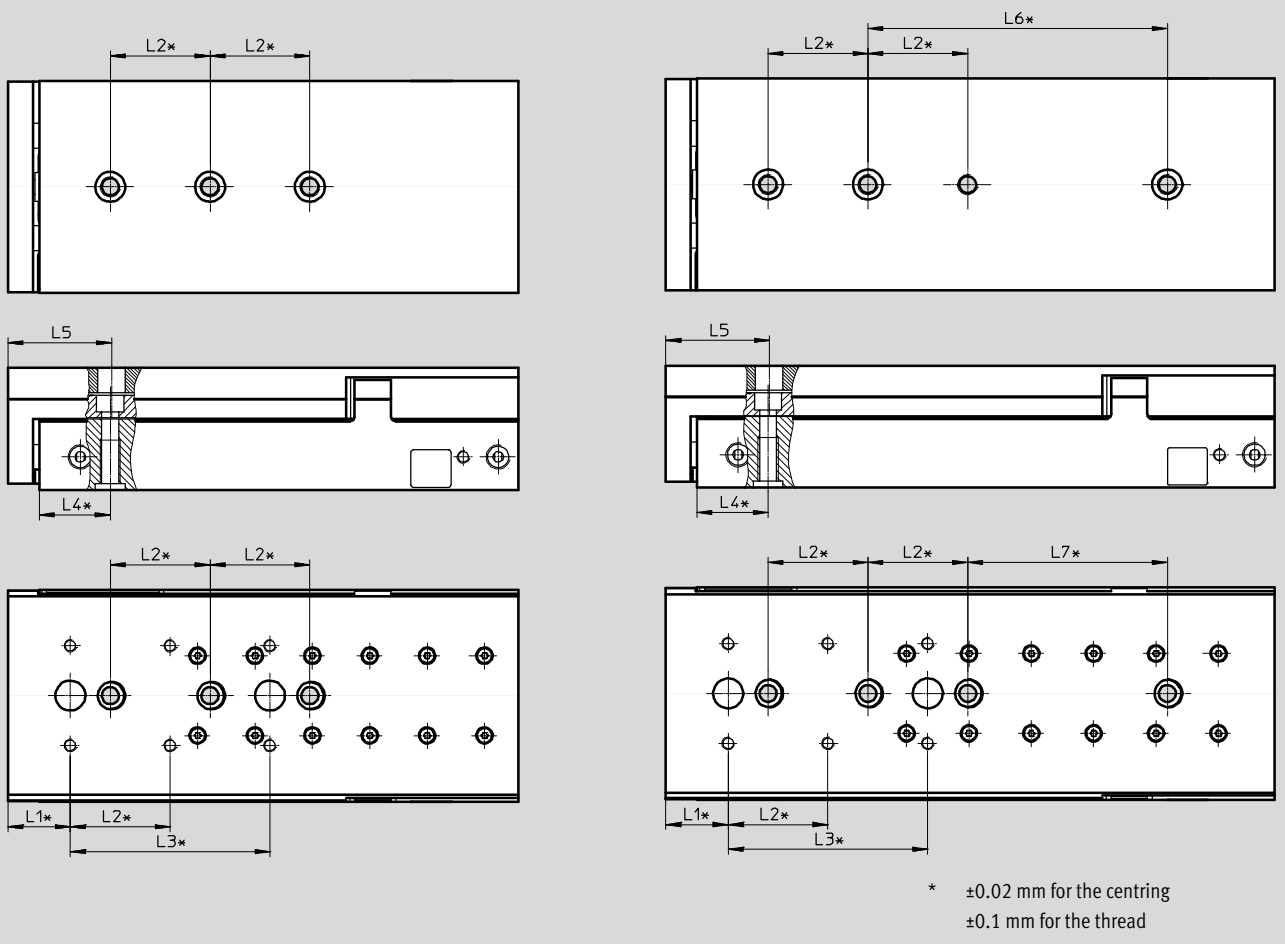

Size	Stroke [mm]	L1	L2	L3	L4	L5	L6	L7
20	100	25	40	80	28.5	41.5	-	80
	125						120	

Mini slides DGST

Technical data

Hole pattern for mounting threads and centring holes

Download CAD data → www.festo.com

DGST-20-150

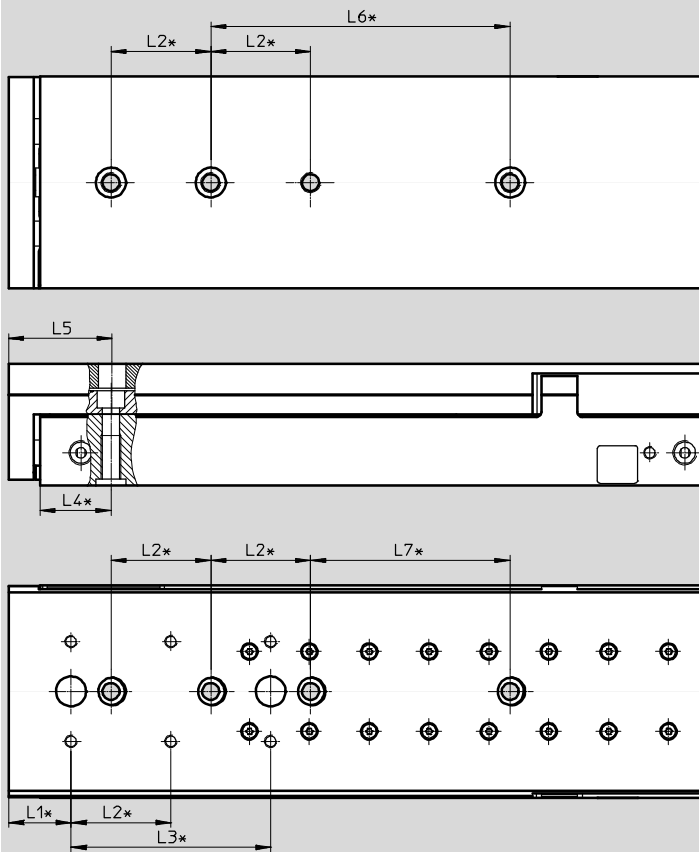

* ± 0.02 mm for the centring
 ± 0.1 mm for the thread

Size	Stroke [mm]	L1	L2	L3	L4	L5	L6	L7
20	150	25	40	80	28.5	41.5	120	80

Mini slides DGST

Technical data

Hole pattern for mounting threads and centring holes

Download CAD data → www.festo.com

DGST-20-200

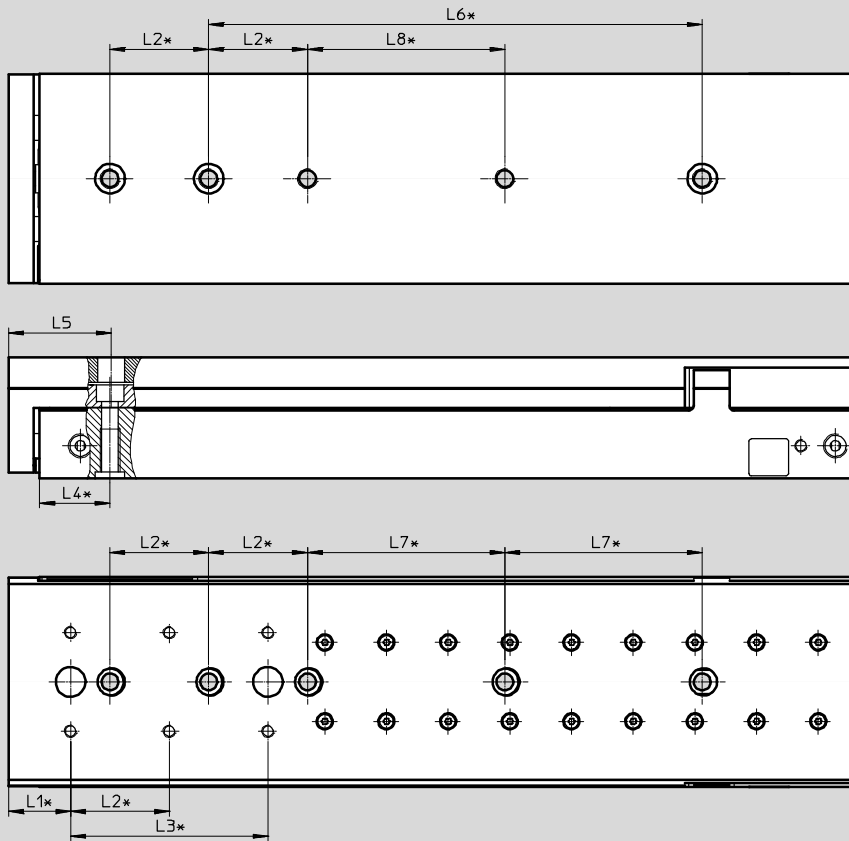

* ±0.02 mm for the centring
±0.1 mm for the thread

Size	Stroke [mm]	L1	L2	L3	L4	L5	L6	L7	L8
20	200	25	40	80	28.5	41.5	200	80	80

Mini slides DGST

Technical data

Hole pattern for mounting threads and centring holes

Download CAD data → www.festo.com

DGST-25-10/20/30/40

DGST-25-50

DGST-25-80

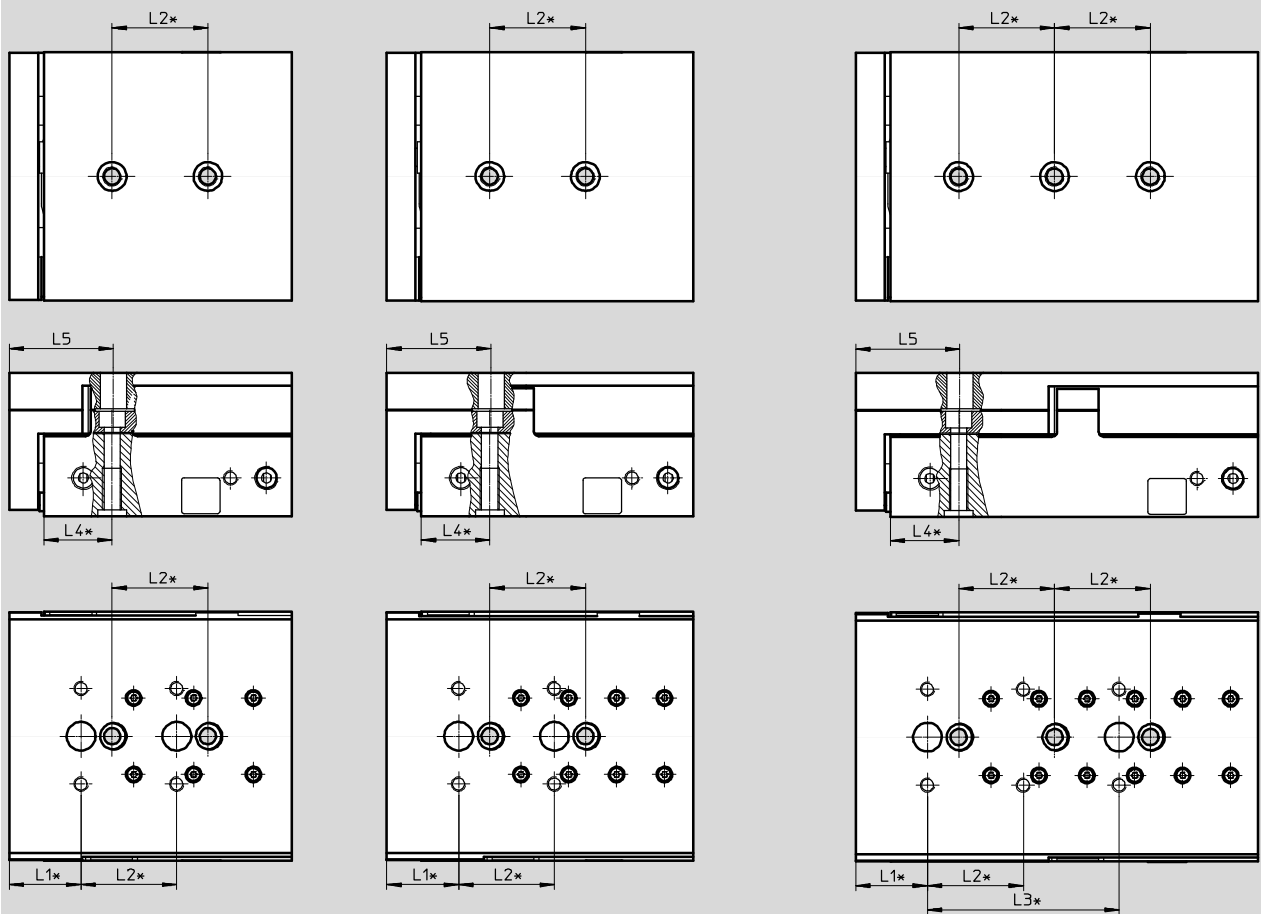

* ±0.02 mm for the centring
±0.1 mm for the thread

Size	Stroke [mm]	L1	L2	L3	L4	L5
25	10	30	40	-	28.5	43.5
	20			-		
	30			-		
	40			-		
	50			-		
	80			80		

Mini slides DGST

Technical data

Hole pattern for mounting threads and centring holes

Download CAD data → www.festo.com

DGST-25-100

DGST-25-125

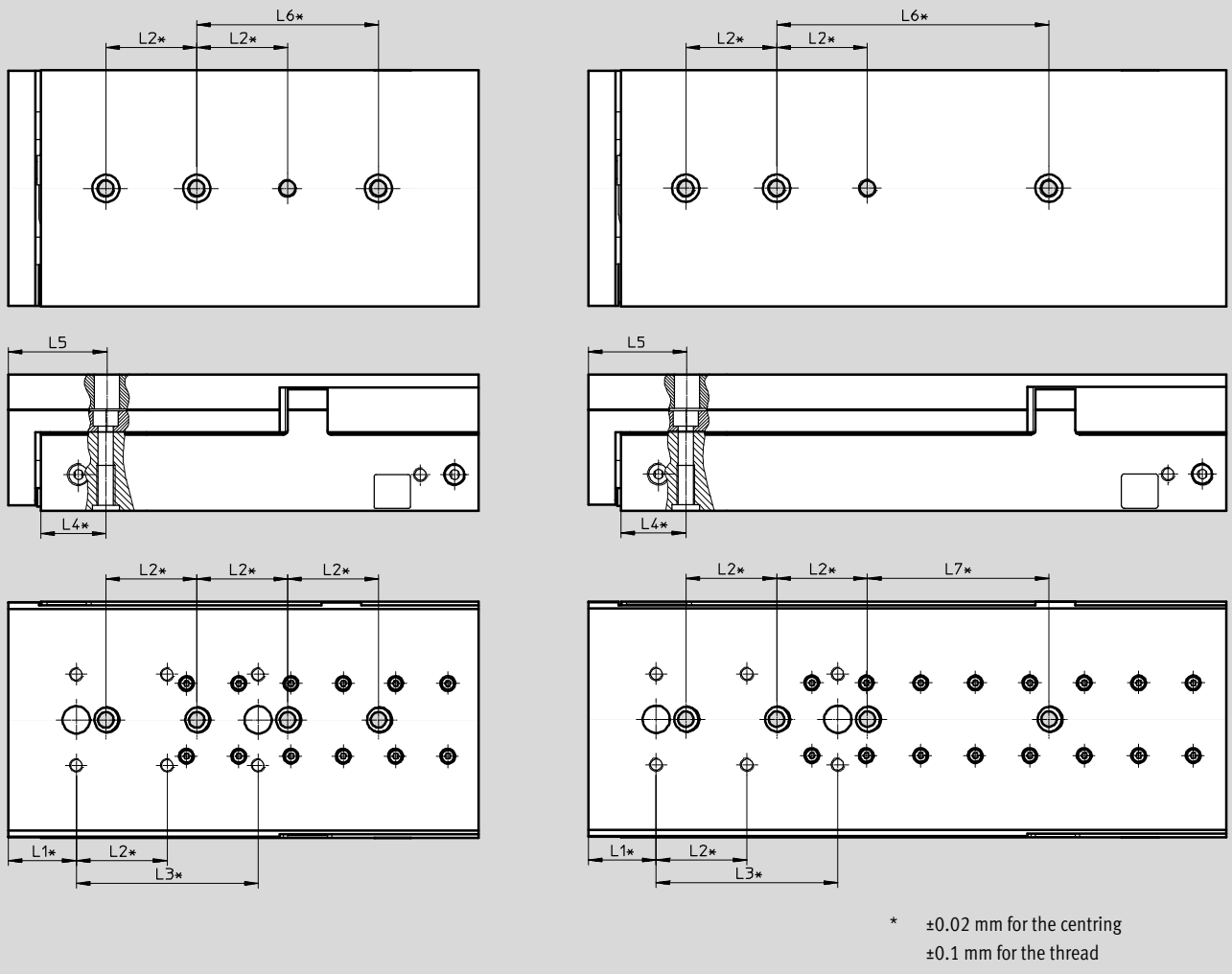

Size	Stroke [mm]	L1	L2	L3	L4	L5	L6	L7
25	100	30	40	80	28.5	43.5	80	80
	125						120	

Mini slides DGST

Technical data

Hole pattern for mounting threads and centring holes

Download CAD data → www.festo.com

DGST-25-150

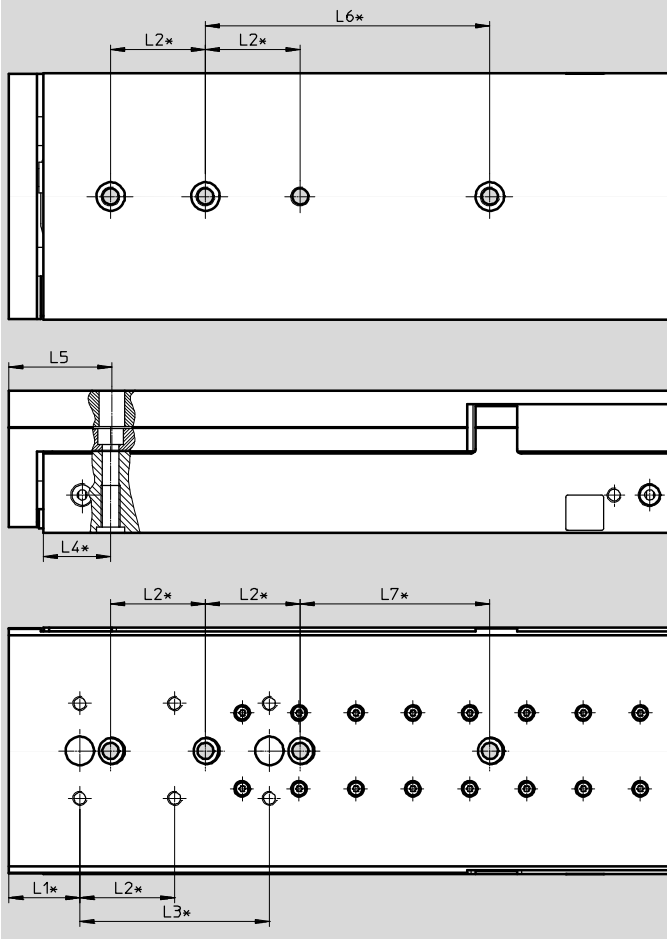

* ±0.02 mm for the centring
±0.1 mm for the thread

Size	Stroke [mm]	L1	L2	L3	L4	L5	L6	L7
25	150	30	40	80	28.5	43.5	120	80

Mini slides DGST

Technical data

Hole pattern for mounting threads and centring holes

Download CAD data → www.festo.com

DGST-25-200

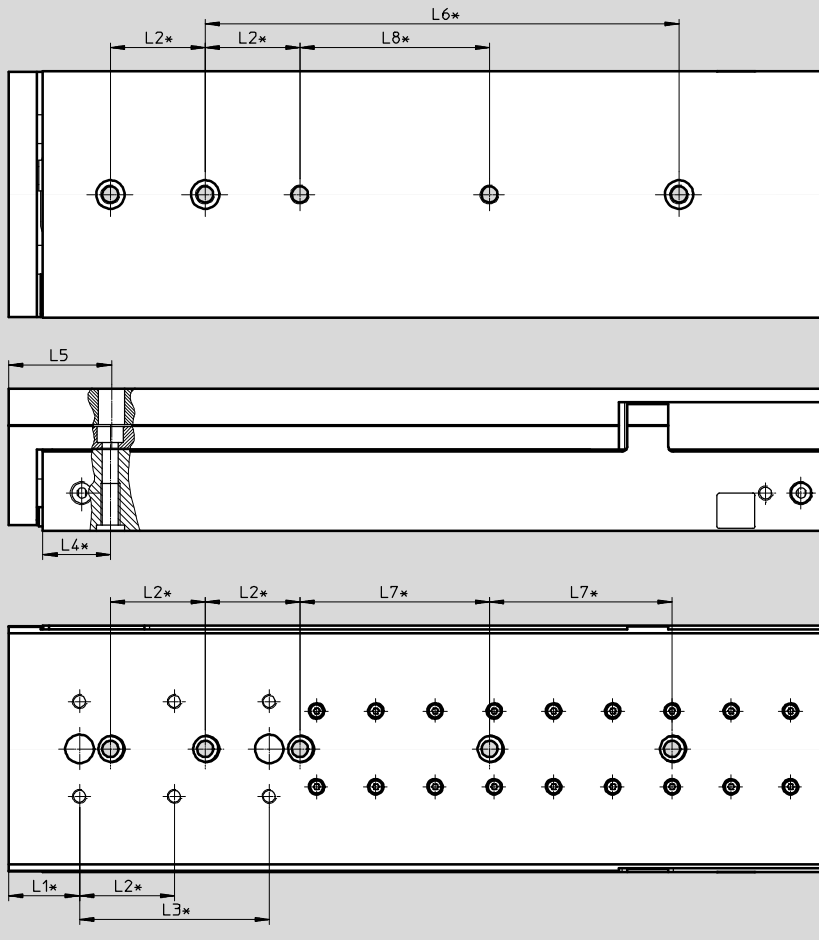

* ± 0.02 mm for the centring
 ± 0.1 mm for the thread

Size	Stroke [mm]	L1	L2	L3	L4	L5	L6	L7	L8
25	200	30	40	80	28.5	43.5	200	80	80

Mini slides DGST

Technical data

Dimensions

Download CAD data → www.festo.com

DGST...-P: Adjustment length and projection in the end positions

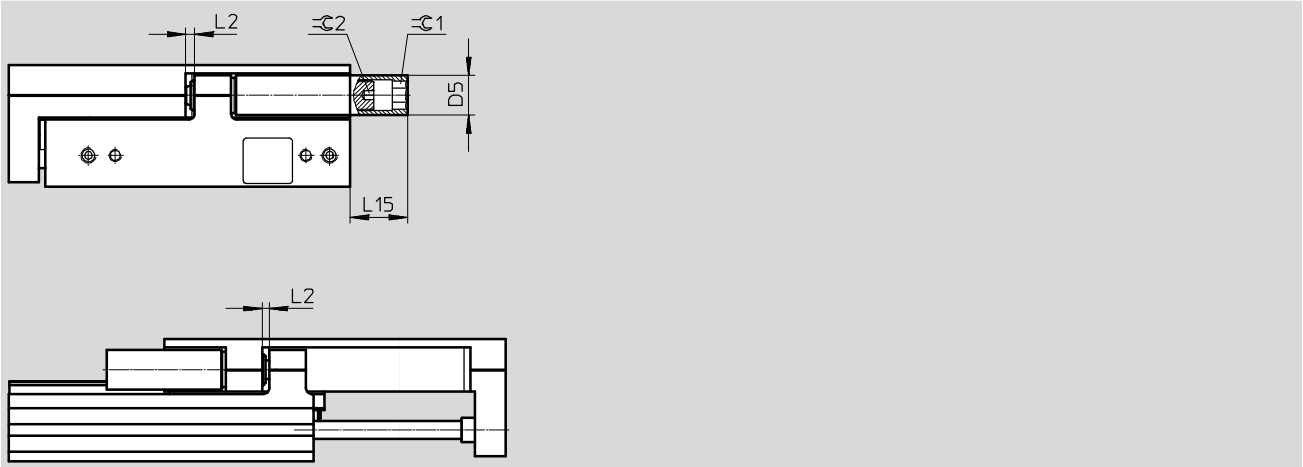

Size	Stroke [mm]	D5 ∅	L2 Retracted		L2 Advanced		L15	\sqrt{Ra} 1	\sqrt{Ra} 3
			min.	max.	min.	max.			
6	10, 20, 30, 40	6	2.5	15	1.5	15	6	3	1.3
	50						0		
8	10, 20, 30, 40	7	3	18.5	2.3	18.5	14.8	4	1.5
	50						10.8		
	80						9.8		
10	10	8	3	19.5	2.4	19.5	6.4	5	2
	20, 30, 40, 50						13.9		
	80, 100						5.9		
12	10, 20, 30, 40, 50, 80	10	3	25	2.4	25	15.4	6	2.5
	100						1.9		
16	10	13	3	26	2.35	26	17.85	8	3
	20						20.85		
	30, 40						23.85		
	50						18.85		
	80, 100						10.85		
	125, 150						0		
20	10	15	3.5	36	2.25	36	11.5	10	4
	20						21.5		
	30, 40						31.5		
	50						27.5		
	80						12.5		
	100, 125, 150, 200						0		
25	10	18	3.5	50	2.5	50	28.5	10	4
	20						38.5		
	30, 40, 50						42.5		
	80						32.5		
	100						13.5		
	125, 150, 200						0		

Mini slides DGST

Technical data

Dimensions

Download CAD data → www.festo.com

DGST-...-Y12: Adjustment length and projection in the end positions

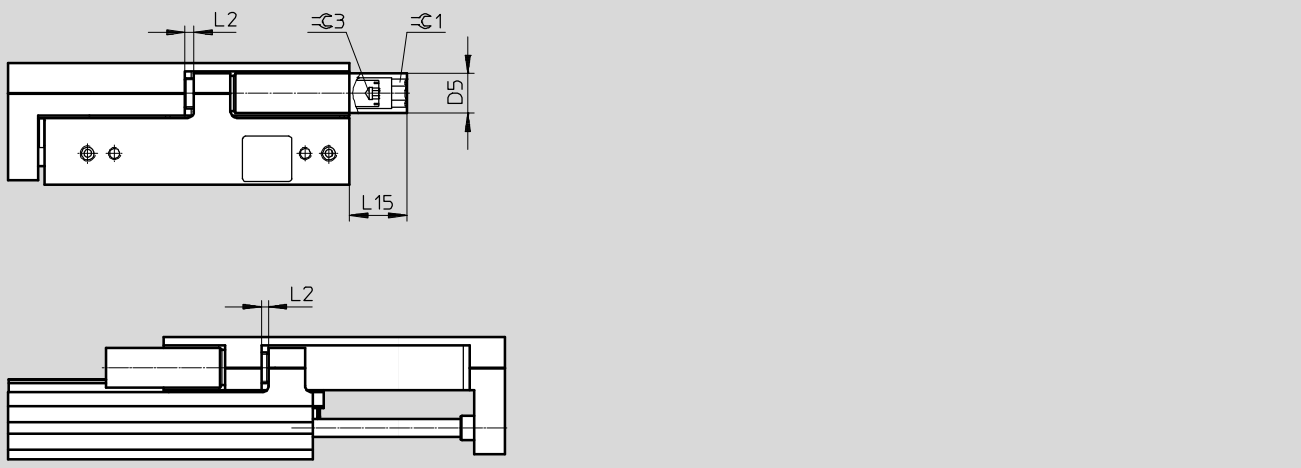

Size	Stroke [mm]	D5 ∅	L2 Retracted		L2 Advanced		L15	⊙ 1	⊙ 3
			min.	max.	min.	max.			
6	30, 40	6	2.5	13	1.5	13	6	3	-1)
	50						0		
8	30, 40	7	3	19.5	2.3	19.5	14.8	4	2
	50						10.8		
	80						9.8		
10	30, 40, 50	8	3	19	2.4	19	13.9	5	2
	80, 100						5.9		
12	30, 40, 50, 80	10	3	19.5	2.4	19.5	15.4	6	2.5
	100						1.9		
16	30, 40	13	3	19.5	2.35	19.5	23.85	8	3
	50						18.85		
	80, 100						10.85		
	125, 150						0		
20	30, 40	15	3.5	30.5	2.25	30.5	31.5	10	4
	50						27.5		
	80						12.5		
	100, 125, 150, 200						0		
25	30, 40, 50	18	3.5	35	2.5	35	42.5	10	4
	80						32.5		
	100						13.5		
	125, 150, 200						0		

1) There is a slit in the shock absorber so it can be screwed in.

Mini slides DGST

Technical data

Ordering data							
Size	Stroke [mm]	Part no.	Type code	Size	Stroke [mm]	Part no.	Type code
With cushioning E1				With cushioning P			
6	10	8078828	DGST-6-10-E1A	6	10	8085105	DGST-6-10-PA
	20	8078829	DGST-6-20-E1A		20	8085106	DGST-6-20-PA
	30	8078830	DGST-6-30-E1A		30	8085107	DGST-6-30-PA
	40	8078831	DGST-6-40-E1A		40	8085108	DGST-6-40-PA
	50	8078832	DGST-6-50-E1A		50	8085109	DGST-6-50-PA
8	10	8078833	DGST-8-10-E1A	8	10	8085110	DGST-8-10-PA
	20	8078834	DGST-8-20-E1A		20	8085111	DGST-8-20-PA
	30	8078835	DGST-8-30-E1A		30	8085112	DGST-8-30-PA
	40	8078836	DGST-8-40-E1A		40	8085113	DGST-8-40-PA
	50	8078837	DGST-8-50-E1A		50	8085114	DGST-8-50-PA
10	10	8078839	DGST-10-10-E1A	10	10	8085116	DGST-10-10-PA
	20	8078840	DGST-10-20-E1A		20	8085117	DGST-10-20-PA
	30	8078841	DGST-10-30-E1A		30	8085118	DGST-10-30-PA
	40	8078842	DGST-10-40-E1A		40	8085119	DGST-10-40-PA
	50	8078843	DGST-10-50-E1A		50	8085120	DGST-10-50-PA
	80	8078844	DGST-10-80-E1A		80	8085121	DGST-10-80-PA
12	10	8078846	DGST-12-10-E1A	12	10	8085123	DGST-12-10-PA
	20	8078847	DGST-12-20-E1A		20	8085124	DGST-12-20-PA
	30	8078848	DGST-12-30-E1A		30	8085125	DGST-12-30-PA
	40	8078849	DGST-12-40-E1A		40	8085126	DGST-12-40-PA
	50	8078850	DGST-12-50-E1A		50	8085127	DGST-12-50-PA
	80	8078851	DGST-12-80-E1A		80	8085128	DGST-12-80-PA
16	10	8078853	DGST-16-10-E1A	16	10	8085130	DGST-16-10-PA
	20	8078854	DGST-16-20-E1A		20	8085131	DGST-16-20-PA
	30	8078855	DGST-16-30-E1A		30	8085132	DGST-16-30-PA
	40	8078856	DGST-16-40-E1A		40	8085133	DGST-16-40-PA
	50	8078857	DGST-16-50-E1A		50	8085134	DGST-16-50-PA
	80	8078858	DGST-16-80-E1A		80	8085135	DGST-16-80-PA
	100	8078859	DGST-16-100-E1A		100	8085136	DGST-16-100-PA
	125	8078860	DGST-16-125-E1A		125	8085137	DGST-16-125-PA
	150	8078861	DGST-16-150-E1A		150	8085138	DGST-16-150-PA

Mini slides DGST

Technical data

Ordering data							
Size	Stroke [mm]	Part no.	Type code	Size	Stroke [mm]	Part no.	Type code
With cushioning E1				With cushioning P			
20	10	8078862	DGST-20-10-E1A	20	10	8085139	DGST-20-10-PA
	20	8078863	DGST-20-20-E1A		20	8085140	DGST-20-20-PA
	30	8078864	DGST-20-30-E1A		30	8085141	DGST-20-30-PA
	40	8078865	DGST-20-40-E1A		40	8085142	DGST-20-40-PA
	50	8078866	DGST-20-50-E1A		50	8085143	DGST-20-50-PA
	80	8078867	DGST-20-80-E1A		80	8085144	DGST-20-80-PA
	100	8078868	DGST-20-100-E1A		100	8085145	DGST-20-100-PA
	125	8078869	DGST-20-125-E1A		125	8085146	DGST-20-125-PA
	150	8078870	DGST-20-150-E1A		150	8085147	DGST-20-150-PA
	200	8078871	DGST-20-200-E1A		200	8085148	DGST-20-200-PA
25	10	8078872	DGST-25-10-E1A	25	10	8085149	DGST-25-10-PA
	20	8078873	DGST-25-20-E1A		20	8085150	DGST-25-20-PA
	30	8078874	DGST-25-30-E1A		30	8085151	DGST-25-30-PA
	40	8078875	DGST-25-40-E1A		40	8085152	DGST-25-40-PA
	50	8078876	DGST-25-50-E1A		50	8085153	DGST-25-50-PA
	80	8078877	DGST-25-80-E1A		80	8085154	DGST-25-80-PA
	100	8078878	DGST-25-100-E1A		100	8085155	DGST-25-100-PA
	125	8078879	DGST-25-125-E1A		125	8085156	DGST-25-125-PA
	150	8078880	DGST-25-150-E1A		150	8085157	DGST-25-150-PA
	200	8078881	DGST-25-200-E1A		200	8085158	DGST-25-200-PA

Mini slides DGST





Technical data

Ordering data			
Size	Stroke [mm]	Part no.	Type code
With cushioning Y12			
6	30	8085159	DGST-6-30-Y12A
	40	8085160	DGST-6-40-Y12A
	50	8085161	DGST-6-50-Y12A
8	30	8085162	DGST-8-30-Y12A
	40	8085163	DGST-8-40-Y12A
	50	8085164	DGST-8-50-Y12A
	80	8085165	DGST-8-80-Y12A
10	30	8085166	DGST-10-30-Y12A
	40	8085167	DGST-10-40-Y12A
	50	8085168	DGST-10-50-Y12A
	80	8085169	DGST-10-80-Y12A
	100	8085170	DGST-10-100-Y12A
12	30	8085171	DGST-12-30-Y12A
	40	8085172	DGST-12-40-Y12A
	50	8085173	DGST-12-50-Y12A
	80	8085174	DGST-12-80-Y12A
	100	8085175	DGST-12-100-Y12A
16	30	8085176	DGST-16-30-Y12A
	40	8085177	DGST-16-40-Y12A
	50	8085178	DGST-16-50-Y12A
	80	8085179	DGST-16-80-Y12A
	100	8085180	DGST-16-100-Y12A
	125	8085181	DGST-16-125-Y12A
	150	8085182	DGST-16-150-Y12A
20	30	8085183	DGST-20-30-Y12A
	40	8085184	DGST-20-40-Y12A
	50	8085185	DGST-20-50-Y12A
	80	8085186	DGST-20-80-Y12A
	100	8085187	DGST-20-100-Y12A
	125	8085188	DGST-20-125-Y12A
	150	8085189	DGST-20-150-Y12A
	200	8085190	DGST-20-200-Y12A
25	30	8085191	DGST-25-30-Y12A
	40	8085192	DGST-25-40-Y12A
	50	8085193	DGST-25-50-Y12A
	80	8085194	DGST-25-80-Y12A
	100	8085195	DGST-25-100-Y12A
	125	8085196	DGST-25-125-Y12A
	150	8085197	DGST-25-150-Y12A
	200	8085198	DGST-25-200-Y12A

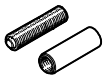
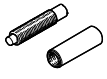
Mini slides DGST

Accessories

Ordering data – Shock absorber					
	For size	Description	Part no.	Type code	
For DGST-...-P Technical data → Internet: dyef					
	6	• Elastic cushioning at both ends, self-adjusting, with end-position adjustment	8073902	DYEF-G8-M4-Y1	
	8		8073903	DYEF-G8-M5-Y1	
	10	• Scope of delivery: 1 cushioning component and 1 threaded sleeve	8073904	DYEF-G8-M6-Y1	
	12		8073905	DYEF-G8-M8-Y1	
	16		8073906	DYEF-G8-M10-Y1	
	20		8073907	DYEF-G8-M12-Y1	
	25		8073908	DYEF-G8-M14-Y1	
For DGST-...-Y12 Technical data → Internet: dyss					
	6	• Shock absorber at both ends, self-adjusting, with end-position adjustment	8073911	DYSS-G8-2-4-Y1F	
	8		8073912	DYSS-G8-3-4-Y1F	
	10	• Scope of delivery: 1 cushioning component and 1 threaded sleeve	8073913	DYSS-G8-4-4-Y1F	
	12		8073914	DYSS-G8-5-5-Y1F	
	16		8073915	DYSS-G8-7-5-Y1F	
	20		8073916	DYSS-G8-8-8-Y1F	
	25		8073917	DYSS-G8-10-10-Y1F	

Ordering data					
	For size	Description	Part no.	Type code	PU ¹⁾
Centring sleeve/centring pin ZBH, ZBS Technical data → Internet: zbh					
	6, 8, 10, 12, 16	For centring loads and attachments on the slide	189652	ZBH-5	10
	20, 25		189653	ZBH-12	
	6	For centring loads and attachments on the yoke plate	525273	ZBS-2	
	8, 10		189652	ZBH-5	
	12, 16		186717	ZBH-7	
	20, 25		189653	ZBH-12	
	6, 8		For centring the mini slide during mounting	189652	
	10, 12	186717		ZBH-7	
	16	150927		ZBH-9	
	20, 25	189653		ZBH-12	
Connector sleeve ZBV Technical data → Internet: zbv					
	20	For centring loads and attachments on the yoke plate	548806	ZBV-12-9	10
One-way flow control valve GRLA Technical data → Internet: grla					
	6	For speed regulation	175041	GRLA-M3-QS-3	1
	8, 10, 12, 16		193139	GRLA-M5-QS-6-D	
	20, 25		193145	GRLA-1/8-QS-8-D	
Push-in fitting QSM Technical data → Internet: qsm					
	6	For connecting tubing with standard outside diameter	153303	QSM-M3-4	10
	8, 10, 12, 16		153304	QSM-M5-4	
	20, 25		153307	QSM-1/8-6	

1) Packaging unit

Mini slides DGST

Accessories

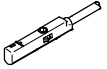

Proximity sensors for size 6 ... 12

Ordering data – Proximity sensors for C-slot, magnetoresistive						Technical data → Internet: smt	
	Type of mounting	Switching output	Electrical connection, connection outlet direction	Cable length [m]	Part no.	Type code	
N/O contact							
	Insertable in the slot from above	PNP	Cable, 3-wire, lengthwise	2.5	551373	SMT-10M-PS-24V-E-2,5-L-OE	
			Plug M8x1, 3-pin, lengthwise	0.3	551375	SMT-10M-PS-24V-E-0,3-L-M8D	
			Plug M8x1, 3-pin, crosswise	0.3	551376	SMT-10M-PS-24V-E-0,3-Q-M8D	

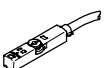
Proximity sensor for size 16 ... 25

Ordering data – Proximity sensors for T-slot, magnetoresistive						Technical data → Internet: smt	
	Type of mounting	Switching output	Electrical connection	Cable length [m]	Part no.	Type code	
N/O contact							
	Inserted in the slot from above, flush with the cylinder profile, short design	PNP	Cable, 3-wire	2.5	574335	SMT-8M-A-PS-24V-E-2,5-OE	
			Plug connector M8x1, 3-pin	0.3	574334	SMT-8M-A-PS-24V-E-0,3-M8D	
		NPN	Cable, 3-wire	2.5	574338	SMT-8M-A-NS-24V-E-2,5-OE	
			Plug connector M8x1, 3-pin	0.3	574339	SMT-8M-A-NS-24V-E-0,3-M8D	

Ordering data – Connecting cables

Ordering data – Connecting cables					Technical data → Internet: nebu	
	Electrical connection, left	Electrical connection, right	Cable length [m]	Part no.	Type code	
	Straight socket, M8x1, 3-pin	Cable, open end, 3-wire	2.5	541333	NEBU-M8G3-K-2.5-LE3	
			5	541334	NEBU-M8G3-K-5-LE3	
	Angled socket, M8x1, 3-pin	Cable, open end, 3-wire	2.5	541338	NEBU-M8W3-K-2.5-LE3	
			5	541341	NEBU-M8W3-K-5-LE3	

Position transmitter

The position transmitter continuously senses the position of the piston.

It has an analogue output with an output signal in proportion to the piston position.

Ordering data – Position transmitter for T-slot

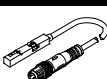
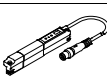
Ordering data – Position transmitter for T-slot							Technical data → Internet: position transmitter		
	For Ø	Position measuring range	Analogue output		Type of mounting	Electrical connection	Cable length [m]	Part no.	Type code
			[V]	[mA]					
	16 ... 25	0 ... 40	0 ... 10	–	Insertable in the slot from above	Plug M8x1, 4-pin, lengthwise	0.3	553744	SMAT-8M-U-E-0,3-M8D
	16 ... 25	0 ... 50	–	4 ... 20	Insertable in the slot from above	Plug M8x1, 4-pin, lengthwise	0.3	1531265	SDAT-MHS-M50-1L-SA-E-0.3-M8
		0 ... 80						1531266	SDAT-MHS-M80-1L-SA-E-0.3-M8
		0 ... 100						1531267	SDAT-MHS-M100-1L-SA-E-0.3-M8
		0 ... 125						1531268	SDAT-MHS-M125-1L-SA-E-0.3-M8
		0 ... 160						1531269	SDAT-MHS-M160-1L-SA-E-0.3-M8

Ordering data – Connecting cables

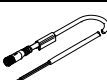
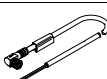
Ordering data – Connecting cables					Technical data → Internet: nebu	
	Electrical connection, left	Electrical connection, right	Cable length [m]	Part no.	Type code	
	Straight socket, M8x1, 4-pin	Cable, open end, 4-wire	2.5	541342	NEBU-M8G4-K-2.5-LE4	
			5	541343	NEBU-M8G4-K-5-LE4	
	Angled socket, M8x1, 4-pin	Cable, open end, 4-wire	2.5	541344	NEBU-M8W4-K-2.5-LE4	
			5	541345	NEBU-M8W4-K-5-LE4	