

Mini guided cylinders DFC

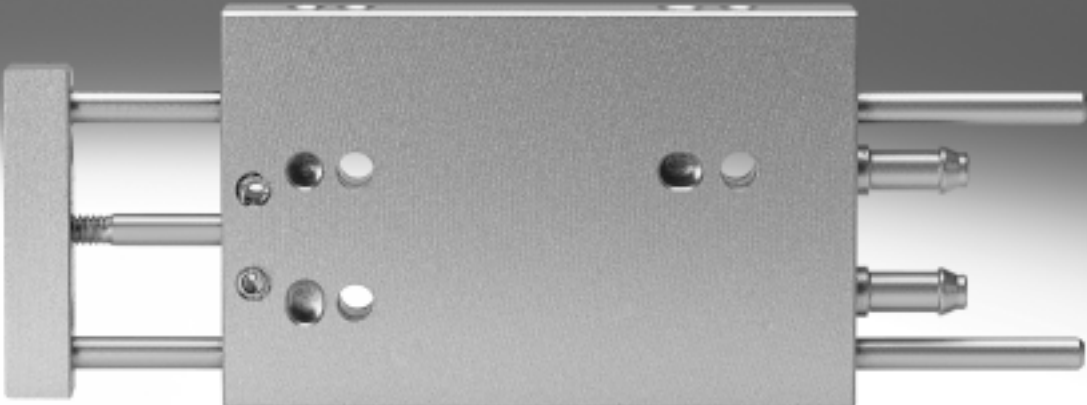

# Mini guided cylinders DFC

Product range and peripherals overview

FESTO

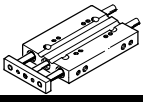
Function	Version	Type	Piston Ø [mm]	Stroke [mm]
Double-acting		DFC	4	5, 10, 15, 20
			6	5, 10, 15, 20, 25, 30
			10	5, 10, 15, 20, 25, 30

Piston Ø 4 mm

Piston Ø 6, 10 mm

Integrated push-in/threaded fitting

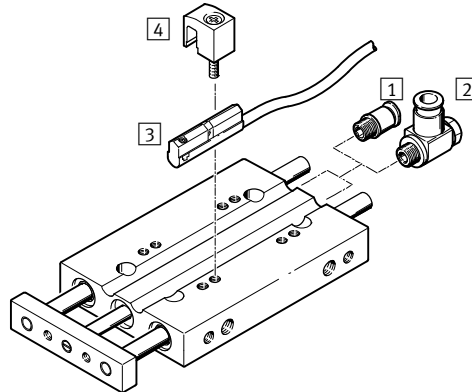
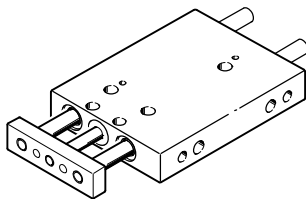

Accessories		Description	Piston Ø 4 mm	Piston Ø 6 mm	Piston Ø 10 mm	→ Page/Internet
1	Push-in/threaded fitting QSM	For connecting compressed air tubing with standard O.D.	-	■	■	qs
2	One-way flow control valve GRLZ	For speed regulation	-	-	■	10
3	Proximity sensor SME/SMT-10	-	-	■	■	10
4	Sensor bracket	Included in the scope of delivery of the mini slide unit	-	■	■	-

## Mounting options

Horizontal mounting from above

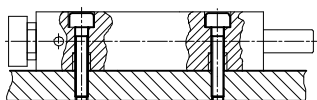

Horizontal mounting from below

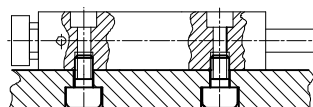

Side mounting from below

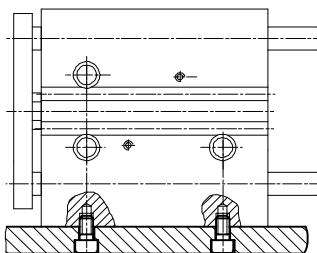

Yoke mounting

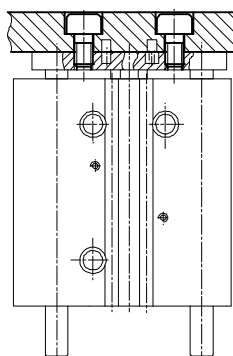

# Mini guided cylinders DFC

Type code

DFC – 6 – 20 – P – A – GF

**Type**

Double-acting	
DFC	Mini guided cylinder

**Piston Ø [mm]**

**Stroke [mm]**

**Cushioning**

P	Flexible cushioning rings/plates at both ends
---	---

**Position sensing**

	No position sensing
A	For proximity sensing

**Guide**

GF	Plain-bearing guide
KF	Recirculating ball bearing guide

# Mini guided cylinders DFC



Technical data

FESTO

Function

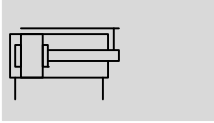
**DFC-...**  
without end-position sensing



-  - Diameter  
4, 6, 10 mm
-  - Stroke length  
5 ... 30 mm
-  - [www.festo.com](http://www.festo.com)

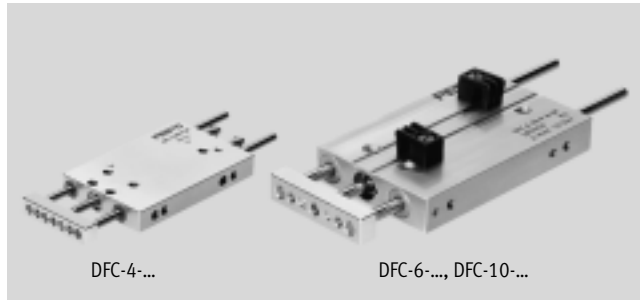

**DFC-...-A-...**

with end position sensing

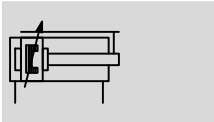

General technical data			
Piston $\varnothing$	4	6	10
Pneumatic connection	Barbed fitting PK-3 for 3 mm plastic tubing	M3	M5
Operating medium	Compressed air in accordance with ISO 8573-1:2010 [7:4:4]		
Note on operating/pilot medium	Operation with lubricated medium possible (in which case lubricated operation will always be required)		
Operating pressure [bar]	3.5 ... 7.0	1.5 ... 10.0	1.0 ... 10.0
Constructional design	Piston		
	Piston rod		
	Guide rods with yoke		
Cushioning	Flexible cushioning rings/plates at both ends		
Position sensing	-	For proximity sensing	
Type of mounting	Via through holes		
	Via female thread		
Mounting position	Any		
Protection against torsion/guide	Guide rod with yoke with plain-bearing guide	Guide rod with yoke with plain-bearing or ball bearing guide	

Ambient conditions		
Variant	Plain-bearing guide GF	Recirculating ball bearing guide KF
Ambient temperature <sup>1)</sup> [°C]	-5 ... +60	
Corrosion resistance class CRC <sup>2)</sup>	2	-

1) Note operating range of proximity sensors.

2) Corrosion resistance class 2 according to Festo standard 940 070

Components requiring moderate corrosion resistance. Externally visible parts with primarily decorative surface requirements which are in direct contact with a surrounding industrial atmosphere or media such as cooling or lubricating agents.

Speeds [m/s] at maximum stroke length			
Piston $\varnothing$	4	6	10
Maximum speed	1.0	1.0	1.0
Minimum speed	0.1	0.1	0.1

Forces [N]			
Piston $\varnothing$	4	6	10
Theoretical force at 6 bar, advancing	7.5	17	47
Theoretical force at 6 bar, retracting	5.5	12.5	35

# Mini guided cylinders DFC

Technical data

Impact energy [J]			
Piston Ø	4	6	10
Max. impact energy at end positions	0.006	0.008	0.05

Permissible impact velocity: 
$$v_{perm.} = \sqrt{\frac{2 \times E_{perm.}}{m_{dead} + m_{load}}}$$

Maximum permissible load: 
$$m_{load} = \frac{2 \times E_{perm.}}{v^2} - m_{dead}$$

$v_{perm.}$  Permissible impact velocity  
 $E_{perm.}$  Max. impact energy  
 $m_{dead}$  Moving load (drive)  
 $m_{load}$  Moving work load

 Note  
 These specifications represent the maximum values which can be reached. Note the maximum permitted impact energy.

Maximum permissible load m as a function of the impact speed v

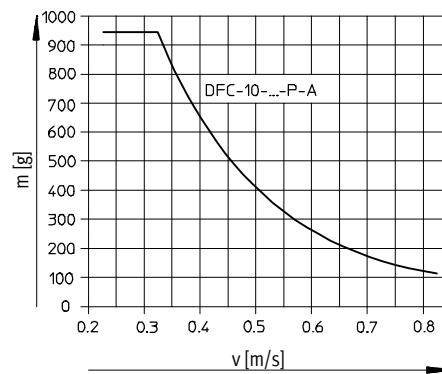
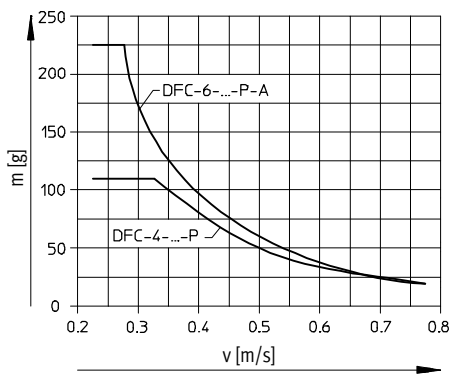

Weights [g]				
Piston Ø	4	6	10	
Product weight	at 5 mm stroke	10	28	91
	at 10 mm stroke	12	34	100
	at 15 mm stroke	15	39	108
	at 20 mm stroke	18	44	117
	at 25 mm stroke	–	49	125
	at 30 mm stroke	–	55	134
Moving load at 0 mm stroke	3.2	8.8	27.2	
Additional load per 10 mm stroke	1.3	2.8	7.2	

## Materials

Sectional view

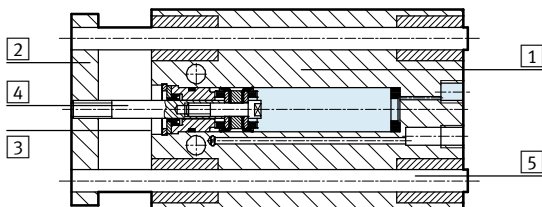

Mini guided cylinder		
1	Housing	Wrought aluminium alloy
2	Yoke plate	Wrought aluminium alloy
3	Cover	Wrought aluminium alloy
4	Piston rod	High-alloy stainless steel
5	Guide rods	High-alloy steel
–	Seals	Polyurethane, nitrile rubber

# Mini guided cylinders DFC

Technical data

FESTO

## Maximum effective load F [N]

Plain-bearing guide GF and recirculating ball bearing guide KF

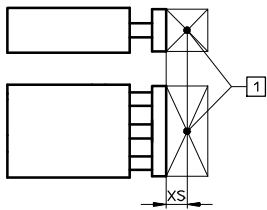

1 Centre of gravity of effective load

Piston Ø [mm]	XS [mm]	Stroke [mm]						
		5	10	15	20	25	30	
4	GF	5	1.7	1.7	1.7	1.7	–	–
	KF	5	–	–	–	–	–	–
6	GF	10	4.8	4.8	4.8	4.8	4.8	4.8
	KF	10	4.6	4.6	4.6	4.6	4.6	4.6
10	GF	15	12.2	12.2	12.2	12.2	12.2	12.2
	KF	15	9.8	9.8	9.8	9.8	9.8	9.8

## Permissible torque load M [Nm]

Plain-bearing guide GF and recirculating ball bearing guide KF

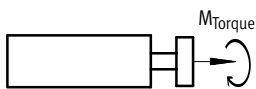

Piston Ø [mm]	Stroke [mm]	5	10	15	20	25	30
		4	GF	0.02	0.02	0.02	0.02
	KF	–	–	–	–	–	–
6	GF	0.1	0.1	0.1	0.1	0.1	0.1
	KF	0.1	0.1	0.1	0.1	0.1	0.1
10	GF	0.4	0.4	0.4	0.4	0.4	0.4
	KF	0.3	0.3	0.3	0.3	0.3	0.3

## Torsional backlash p

Plain-bearing guide GF and recirculating ball bearing guide KF

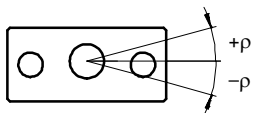

Piston Ø		4	6	10
In retracted state				
Torsional backlash [°]	GF	0.07	0.05	0.04
	KF	0.07	0.05	0.03
In advanced state with maximum stroke				
Torsional backlash [°]	GF	0.11	0.07	0.06
	KF	0.12	0.08	0.05

# Mini guided cylinders DFC

Technical data

## Deflection of piston rod

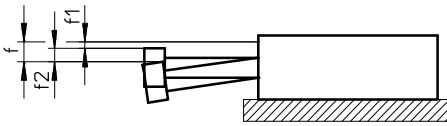

$$f = f_1 + f_2$$

f = Total deflection of piston rod

f<sub>1</sub> = Deflection due to bearing backlash = max. 0.02 mm

f<sub>2</sub> = Deflection due to lateral force

## Deflection f<sub>2</sub> due to lateral force F as a function of the stroke

Piston Ø 4 mm

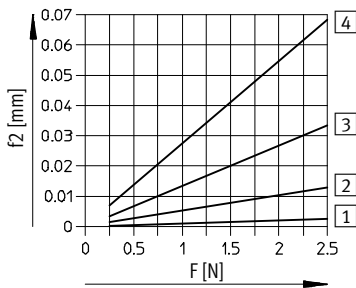

Piston Ø 6 mm

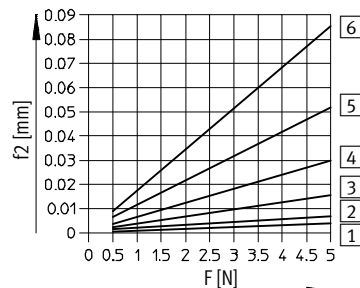

Piston Ø 10 mm

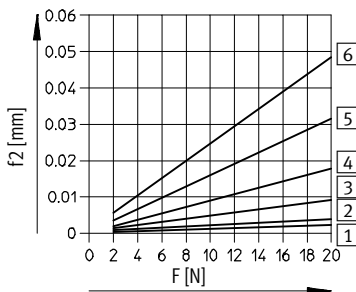

- 1 5 mm stroke
- 2 10 mm stroke
- 3 15 mm stroke
- 4 20 mm stroke
- 5 25 mm stroke
- 6 30 mm stroke

# Mini guided cylinders DFC

Technical data

FESTO

## Dimensions

Download CAD data → [www.festo.com](http://www.festo.com)

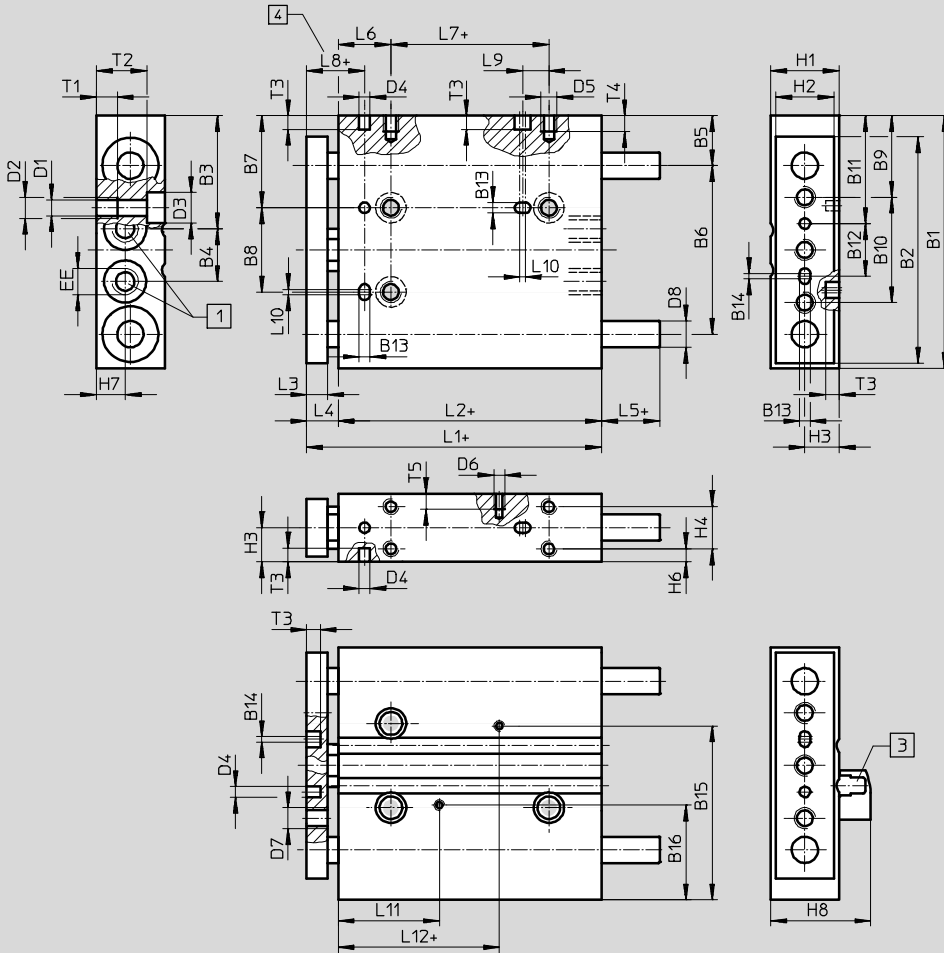

- 1 Supply port
- 3 Sensor bracket  
(included in the scope of  
delivery of the mini slide unit)
- 4 Dimension L8 set when  
extended

+ = plus stroke length

## Piston Ø 4 mm

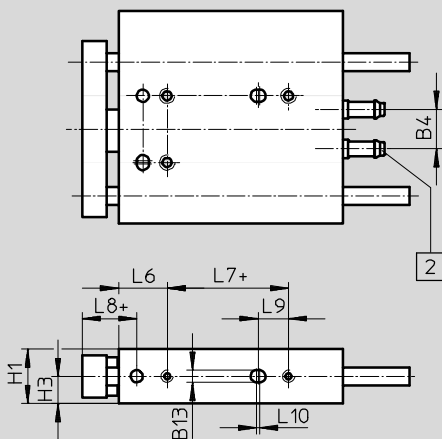

- 2 Barbed fitting PK-3 for 3 mm  
plastic tubing

+ = plus stroke length



# Mini guided cylinders DFC

Technical data

FESTO

∅ [mm]	B1	B2	B3	B4	B5	B6	B7	B8	B9	B10	B11	B12	B13 H8	B14	B15	B16	D1 ∅
4	24	20	9.8	7.4	6	15	9.5	8	8.5	10	11	5	2	-	-	-	2.1
6	35	29	17	6.5	8.5	22	14	11	12	15	15.75	8	2	1	26.2	12.8	2
10	48	43	21.5	10	9.5	32	17.5	16	15.5	20	20.5	10	2	1	33	18	3.2

∅ [mm]	D2	D3 ∅	D4 ∅ H8	D5	D6 ∅	D7	D8 ∅	EE	H1	H2	H3	H4	H6	H7	H8	L1	L2
4	-	-	2	M2	-	M2	2	-	5.5	4.5	2.75	-	2.75	2.75	-	24	18
6	M2.5	4	2	M2.5	M2	M2.5	3	M3	9	7	4.5	-	4.5	3.5	15	34	27
10	M4	5.8	2	M3	M2	M4	5	M5	13	11	6.5	8	2.5	5.5	19	48	40

∅ [mm]	L3	L4 +0.3 -0.9	L5	L6	L7	L8 +0.2	L9	L10	L11	L12	T1	T2	T3	T4	T5
4	4	6	1	8	3	11	3.5	0.5	-	-	-	5.5	2	4	-
6	5	7	1	8	10	10	5	0.5	16	19.35	3	6.1	2.6	5	2.5
10	6	8	1	10	20	13	5	1	22.2	25.6	4	9.6	2.6	3	3

Ordering data					
Piston ∅ [mm]	Stroke [mm]	Plain-bearing guide GF		Recirculating ball bearing guide KF	
		Part No.	Type	Part No.	Type
4	5	189479	DFC-4-5-P-GF	-	
	10	189452	DFC-4-10-P-GF		
	15	189453	DFC-4-15-P-GF		
	20	189454	DFC-4-20-P-GF		
6	5	189455	DFC-6-5-P-A-GF <sup>1)</sup>	189461	DFC-6-5-P-A-KF <sup>1)</sup>
	10	189456	DFC-6-10-P-A-GF <sup>1)</sup>	189462	DFC-6-10-P-A-KF <sup>1)</sup>
	15	189457	DFC-6-15-P-A-GF <sup>1)</sup>	189463	DFC-6-15-P-A-KF <sup>1)</sup>
	20	189458	DFC-6-20-P-A-GF <sup>1)</sup>	189464	DFC-6-20-P-A-KF <sup>1)</sup>
	25	189459	DFC-6-25-P-A-GF <sup>1)</sup>	189465	DFC-6-25-P-A-KF <sup>1)</sup>
	30	189460	DFC-6-30-P-A-GF <sup>1)</sup>	189466	DFC-6-30-P-A-KF <sup>1)</sup>
10	5	189467	DFC-10-5-P-A-GF <sup>1)</sup>	189473	DFC-10-5-P-A-KF <sup>1)</sup>
	10	189468	DFC-10-10-P-A-GF <sup>1)</sup>	189474	DFC-10-10-P-A-KF <sup>1)</sup>
	15	189469	DFC-10-15-P-A-GF <sup>1)</sup>	189475	DFC-10-15-P-A-KF <sup>1)</sup>
	20	189470	DFC-10-20-P-A-GF <sup>1)</sup>	189476	DFC-10-20-P-A-KF <sup>1)</sup>
	25	189471	DFC-10-25-P-A-GF <sup>1)</sup>	189477	DFC-10-25-P-A-KF <sup>1)</sup>
	30	189472	DFC-10-30-P-A-GF <sup>1)</sup>	189478	DFC-10-30-P-A-KF <sup>1)</sup>

1) Mounting kits for proximity sensors included in scope of delivery.



# Mini guided cylinders DFC

Accessories

**FESTO**

Ordering data – Proximity sensors for C-slot, magneto-resistive						Technical data → Internet: smt	
	Type of mounting	Switch output	Electrical connection, connection direction	Cable length [m]	Part No.	Type	
N/O contact							
	Insertable in the slot from above	PNP	Plug M8x1, 3-pin, in-line	0.3	<b>551375</b>	<b>SMT-10M-PS-24V-E-0,3-L-M8D</b>	
			Cable, 3-wire, in-line	2.5	<b>551373</b>	<b>SMT-10M-PS-24V-E-2,5-L-OE</b>	

Ordering data – Proximity sensors for C-slot, magnetic reed						Technical data → Internet: sme	
	Type of mounting	Switch output	Electrical connection, connection direction	Cable length [m]	Part No.	Type	
N/O contact							
	Insertable in the slot lengthwise	Contacting	Plug M8x1, 3-pin, in-line	0.3	<b>173212</b>	<b>SME-10-SL-LED-24</b>	
			Cable, 3-wire, in-line	2.5	<b>173210</b>	<b>SME-10-KL-LED-24</b>	

Ordering data – Connecting cables					Technical data → Internet: nebu		
	Electrical connection, left		Electrical connection, right	Cable length [m]	Part No.	Type	
	Straight socket, M8x1, 3-pin		Cable, open end, 3-wire	2.5	<b>541333</b>	<b>NEBU-M8G3-K-2.5-LE3</b>	
				5	<b>541334</b>	<b>NEBU-M8G3-K-5-LE3</b>	
	Angled socket, M8x1, 3-pin		Cable, open end, 3-wire	2.5	<b>541338</b>	<b>NEBU-M8W3-K-2.5-LE3</b>	
				5	<b>541341</b>	<b>NEBU-M8W3-K-5-LE3</b>	

Ordering data – One-way flow control valves				Technical data → Internet: grlz		
	Connection		Material	Part No.	Type	
	Thread	For tubing OD				
	M5	3	Metal design	<b>193153</b>	<b>GRLZ-M5-QS-3-D</b>	
		4		<b>193154</b>	<b>GRLZ-M5-QS-4-D</b>	
		6		<b>193155</b>	<b>GRLZ-M5-QS-6-D</b>	