

真空吸盘，带支座吸盘 ESS 和吸盘 ESV







FESTO



真空吸盘, 带支座吸盘 ESS



产品范围概览



型号	吸盘 \varnothing [mm]	吸盘支座 规格	安装螺纹	公称通径 [mm]	符合 FDA 食品认证	材料						→ 页码/ Internet		
						氟化橡胶	丁腈橡胶	丁腈橡胶, 抗静电	硅胶	聚氨酯	Vulkolan®			
标准圆形 ESS-...-S...		2	1	$\varnothing 3$	0.6	■	■	■	■	■	■	-	7	
		4			1.2	■	■	■	■	■	■	-		
		6	2	$\varnothing 4$	2.0	■	■	■	■	■	■	-		
		8												
		10	3	M4x0.7	2.0	■	■	■	■	■	■	-	7	
		15												
		20	4	M6x1	3.0	■	■	■	■	■	■	-		
		30												
		40												
		50												
		60	5	M10x1.5	6.0	■	■	■	■	■	■	-		
		80												
		100												
		150	6	M20x2	10.0	■	■	■	■	■	■	-		
200														
深圆形 ESS-...-E...		15	3	M4x0.7	2.0	-	■	■	-	■	■	-	11	
		20	4	M6x1	3.0									
		30												
		40												
		50												
		60	5	M10x1.5	6.0									
		80												
		100												
波状圆形, 1.5 圈褶 ESS-...-B...		10	3	M4x0.7	2.0	-	-	■	-	■	■	-	14	
		20	4	M6x1	3.0									
		30												
		40												
		50												
波状圆形, 1.5 圈褶 ESS-...-BT...		40	4	M6	2.5							■	16	
				M10										
				G $\frac{3}{4}$ -I										
				G $\frac{3}{4}$										
		50	4	M6	2.5									■
				M10										
				G $\frac{3}{4}$ -I										
				G $\frac{3}{4}$										
		80	5	M10	2.5									■
				G $\frac{3}{4}$ -I										
波状 圆形, 3.5 圈褶 ESS-...-C...		10	3	M4x0.7	2.0	-	-	■	-	■	-	-	18	
		20	4	M6x1	3.0									
		30												
		40												
		50												







真空吸盘, 带支座吸盘 ESS

产品范围概览

型号	吸盘 ∅ 或吸盘规格	吸盘 支座	安装螺纹	公称通径	材料		→ 页码/ Internet	
					丁腈橡胶	Vulkollan®		
	[mm]	规格		[mm]				
椭圆形吸盘 ESS-...-0...		4x10	4	M6x1	3.0	■	-	20
		4x20						
		6x10						
		6x20						
		8x20						
		8x30						
		10x30						
		15x45	5	M10x1.5	6.0	■	-	
		20x60						
		25x75						
30x90								
铃形 ESS-...-GT-...		30	4	M6	2.5	-	■	22
				M10				
				G ¹ / ₈ -I				
				G ¹ / ₈				
		40	4	M6	2.5	-	■	
				M10				
				G ¹ / ₄ -I				
		50	4	M6	2.5	-	■	
				M10				
				G ¹ / ₈ -I				
		60	5	M10	2.5	-	■	
				G ¹ / ₄ -I				
				G ¹ / ₄				
		80	5	M10	5.5	-	■	
				G ¹ / ₄ -I				
				G ¹ / ₄				
		100	5	M10	5.5	-	■	
				G ¹ / ₄ -I				
G ¹ / ₄								

吸盘 ESV

产品范围概览

型号	吸盘 \varnothing [mm]	吸盘 支座 规格	安装螺纹	符合 FDA 食品认证	材料						→ 页码/ Internet	
					氟化橡胶	丁腈橡胶	丁腈橡胶 抗静电	硅胶	聚氨酯	Vulkollan®		
标准圆形 ESV-...-S...		20	4	M6x1		■	■	■	■	■	-	7
		30										
		40										
		50										
		60	5	M10x1.5	■	■	■	-	■	■	-	
		80										
		100										
150	6	M20x2	■	■	■	-	■	■	-			
200												
深圆形 ESV-...-E...		20	4	M6x1	-	■	■	-	■	■	-	11
		30										
		40										
		50										
		60	5	M10x1.5	-	■	■	-	■	■	-	
		80										
100												
波状 圆形, 1.5 圈褶 ESV-...-B...		20	4	M6x1	-	-	■	-	■	■	-	14
		30										
		40										
		50										
80	5	M10x1.5	-	-	■	-	■	■	-			
波状 圆形, 1.5 圈褶 ESV-...-BT...		40	4	-	-	-	-	-	-	■	16	
		50										
		80	5	-	-	-	-	-	-	■		
波状 圆形, 3.5 圈褶 ESV-...-C...		20	4	M6x1	-	-	■	-	■	-	-	18
		30										
		40										
		50	5	M10x1	-	-	■	-	■	-	-	
铃形 ESV-...-GT...		30	4	-	-	-	-	-	-	■	22	
		40										
		50										
		60	5	-	-	-	-	-	-	■		
		80										
		100										

真空吸盘，带支座吸盘 ESS/吸盘 ESV

型号代码

FESTO

ESS		10	S	N	M6
型号					
ESS	吸盘, 带支座				
ESV	吸盘				
吸盘 ∅ 或吸盘规格 [mm]					
2...200	圆形				
4x10	椭圆形				
4x20	椭圆形				
6x10	椭圆形				
6x20	椭圆形				
8x20	椭圆形				
8x30	椭圆形				
10x30	椭圆形				
15x45	椭圆形				
20x60	椭圆形				
25x75	椭圆形				
30x90	椭圆形				
吸盘 design					
S	标准圆形				
E	深圆形				
B	波状圆形, 1.5圈褶				
C	波状圆形, 3.5圈褶				
O	椭圆形				
G	铃形				
材料					
F	氟化橡胶				
N	丁腈橡胶				
NA	丁腈橡胶, 抗静电				
S	硅胶				
U	聚氨酯				
T	Vulkollan®				
接口规格					
M6	M6 螺纹				
M10	M10 螺纹				
G $\frac{1}{8}$	G $\frac{1}{8}$ 螺纹				
G $\frac{1}{4}$	G $\frac{1}{4}$ 螺纹				
G $\frac{1}{8}$ -I	G $\frac{1}{8}$ -I 内螺纹				
G $\frac{1}{4}$ -I	G $\frac{1}{4}$ -I 内螺纹				

 注意

可用组合见订货数据。

® 拜耳材料科技集团公司注册商标

真空吸盘，带支座吸盘 ESS/吸盘 ESV

技术参数

FESTO

主要技术参数						
型号	ESS/ESV-...					
	F	N	NA	S	U	T
工作介质	大气空气					
安装位置	任意					
材料	氟化橡胶	丁腈橡胶	丁腈橡胶， 抗静电	硅胶	聚氨酯	Vulkollan®
肖氏硬度	60±5	50±5 (60±5) ¹⁾	50±5	50±5	60±5	72±5
颜色	灰色	黑色	黑色带白点	透明	蓝色	红棕色
材料注意事项	不含油漆湿润缺陷物质			含有油漆湿润缺陷物质		不含油漆湿润缺陷物质
	不含铜、聚四氟乙烯和硅 → 订货数据					

1) 括号内数值适用于带支座吸盘 ESS-...SN,吸盘 ∅ 10 ... 100 mm 和吸盘 ESS-...EN.

环境条件						
型号	ESS/ESV-...					
	F	N	NA	S	U	T
环境温度 [°C]	-10 ... +200	-10 ... +70	-10 ... +70	-30 ... +180	-20 ... +60	-10 ... +80
耐腐蚀等级 CRC ¹⁾	1					2

1) CRC1: 耐腐蚀等级 1, 符合Festo 940 070标准
 元件只需具备低度耐腐蚀能力。运输和贮存防护。这些元件无表面基本涂层要求，譬如：内部元件或位于盖子下面的元件。
 CRC2: 耐腐蚀等级 2, 符合Festo 940 070标准
 元件必须具备一定的耐腐蚀能力。外部可视元件具备基本的涂层表面，可直接与工业环境或与冷却液、润滑剂等介质接触。

真空吸盘，带支座吸盘 ESS/吸盘 ESV，标准圆形

FESTO

技术参数

ESS-...-S...
ESV-...-S...

-  - 温度范围
-30 ... +200 °C

功能

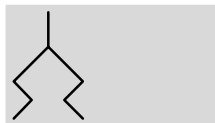

-  - 直径
2 ... 200 mm

符合 FDA 食品认证



主要技术参数								
吸盘 Ø [mm]	吸盘支座适用规格	安装螺纹	有效吸盘 Ø [mm]	脱离力, -0.7 bar [N]	吸盘体积 ³⁾ [cm ³]	工件最小半径 R ²⁾ [mm]	重量	
							ESS [g]	ESV [g]
2	规格 1	Ø 3 ¹⁾	1.4	0.1	0.002	10	0.1	-
4			3.3	0.4	0.008	10	0.1	-
6	规格 2	Ø 4 ¹⁾	5.2	1.1	0.015	15	0.2	-
8			7.2	2.3	0.030	20	0.2	-
10	规格 3	M4x0.7	8.3	3.9	0.050	30	1.5	-
15			13.5	8.5	0.208	35	1.9	-
20	规格 4	M6x1	17.6	16.3	0.318	60	6.4	1.6
30			18.4	40.8	0.867	110	9	2.7
40			26.5	69.6	1.566	230	16.3	7.4
50			33.3	105.8	2.387	330	22	11.2
60	规格 5	M10x1.5	42.0	166.1	3.953	350	49	22
80			57.8	309.7	19.312	400	133	33
100			75.2	503.6	29.779	460	222	59
150	规格 6	M20x2	114.3	900	173.826	480	719	361
200			151.7	1,610	245.454	680	1,198	840

1) 插到吸盘支座上火插入吸盘支座

2) 待抓取工件最小圆弧半径

3) 抽空容积

侧向力 F [N], pu = -0.7 bar; Ra = 7 µm					
吸盘 Ø [mm]	ESS-...-SN	ESS-...-SS	ESS-...-SU	ESS-...-SF	ESS-...-SNA
2	0.5	0.5	0.5	0.5	0.5
4	0.5	0.5	0.5	0.5	0.5
6	3.5	2.5	3	1.5	2
8	9.5	3.5	5	3.5	4
10	3.5	4	7	4.5	7.5
15	10.5	6.5	9	10.5	13.5
20	11.5	10.5	23	15.5	14.5
30	19.5	23.5	19	22	20
40	60	25	83	25	49
50	135	84	130	69.5	81.5
60	136	85	151	117.5	-
80	315	104	295	139.5	-
100	600	130	482.5	299	-
150	675	400	1,000	480	-
200	850	425	1,000	500	-

真空吸盘, 带支座吸盘 ESS/吸盘 ESV, 标准圆形

技术参数

FESTO

尺寸

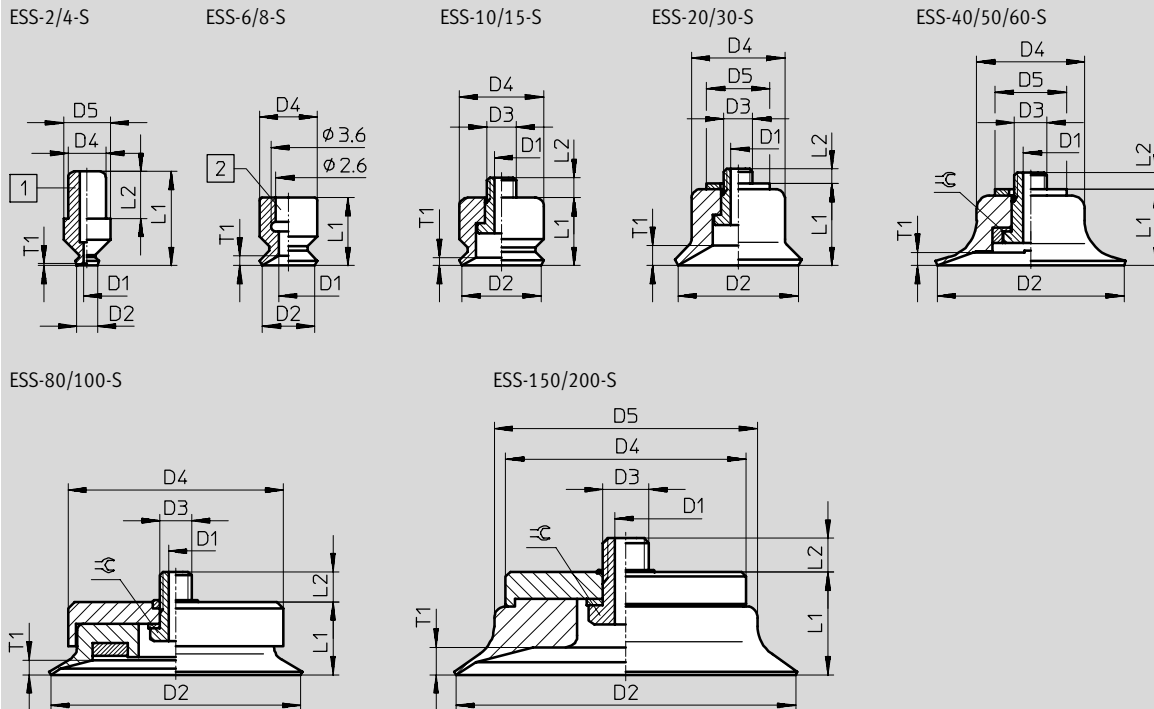

- 1 中心轴用于嵌入支座
- 2 孔, 用于在支座上滑动

型号 吸盘	真空吸盘	D1 ND	D2 ∅	D3	D4 ∅	D5 ∅	L1	L2	T1	≡C
ESS-2-S...	ESG-2-S...	∅ 0.6	2	-	3.2	4	8	4	0.2	-
ESS-4-S...	ESG-4-S...	∅ 1.2	4	-	3.2	4	8	4	0.6	-
ESS-6-S...	ESG-6-S...	∅ 2	6	-	6	-	7	-	1	-
ESS-8-S...	ESG-8-S...	∅ 2	8	-	6	-	5.5	-	1.1	-
ESS-10-S...	ESG-10-S...	≡C 2	10	M4x0.7	10	-	8	3	1	-
ESS-15-S...	ESG-15-S...	≡C 2	15	M4x0.7	11	-	9	3	2.4	-
ESS-20-S...	ESG-20-S...	≡C 3	20	M6x1	15	18	11.6	2.4	1.8	-
ESS-30-S...	ESG-30-S...	≡C 3	30	M6x1	17	18	12.6	3.4	2	-
ESS-40-S...	ESG-40-S...	≡C 3	40	M6x1	25	22	15.6	3.2	1.9	-
ESS-50-S...	ESG-50-S...	≡C 3	50	M6x1	30	22	16.6	3.2	1.6	-
ESS-60-S...	ESG-60-S...	∅ 6	60	M10x1.5	40	-	20.6	4.5	2.6	14
ESS-80-S...	ESG-80-S...	∅ 6	80	M10x1.5	68	-	23	9.4	4.7	14
ESS-100-S...	ESG-100-S...	∅ 6	100	M10x1.5	85	-	25	8.4	5.5	14
ESS-150-S...	ESG-150-S...	∅ 10	150	M20x2	105	115	45	13	12	27
ESS-200-S...	ESG-200-S...	∅ 10	200	M20x2	105	160	50	13	15	27

真空吸盘，带支座吸盘 ESS/吸盘 ESV，标准圆形

技术参数

FESTO

订货数据				
吸盘 Ø [mm]	ESS		ESV	
	订货号	型号	订货号	型号
氟化橡胶 F				
2	189267	ESS-2-SF ¹⁾	-	
4	189272	ESS-4-SF ¹⁾	-	
6	189277	ESS-6-SF ¹⁾	-	
8	189282	ESS-8-SF ¹⁾	-	
10	189287	ESS-10-SF ¹⁾	-	
15	189292	ESS-15-SF ¹⁾	-	
20	189297	ESS-20-SF ¹⁾	190982	ESV-20-SF
30	189302	ESS-30-SF ¹⁾	190987	ESV-30-SF
40	189307	ESS-40-SF ¹⁾	190992	ESV-40-SF
50	189312	ESS-50-SF ¹⁾	190997	ESV-50-SF
60	189317	ESS-60-SF ¹⁾	191002	ESV-60-SF
80	189321	ESS-80-SF ¹⁾	191006	ESV-80-SF
100	189325	ESS-100-SF ¹⁾	191010	ESV-100-SF
150	189329	ESS-150-SF ¹⁾	191014	ESV-150-SF
200	189333	ESS-200-SF ¹⁾	191018	ESV-200-SF
丁腈橡胶 N				
2	189264	ESS-2-SN ¹⁾	-	
4	189269	ESS-4-SN ¹⁾	-	
6	189274	ESS-6-SN ¹⁾	-	
8	189279	ESS-8-SN ¹⁾	-	
10	189284	ESS-10-SN ¹⁾	-	
15	189289	ESS-15-SN ¹⁾	-	
20	189294	ESS-20-SN ¹⁾	190979	ESV-20-SN
30	189299	ESS-30-SN ¹⁾	190984	ESV-30-SN
40	189304	ESS-40-SN ¹⁾	190989	ESV-40-SN
50	189309	ESS-50-SN ¹⁾	190994	ESV-50-SN
60	189314	ESS-60-SN ¹⁾	190999	ESV-60-SN
80	189318	ESS-80-SN ¹⁾	191003	ESV-80-SN
100	189322	ESS-100-SN ¹⁾	191007	ESV-100-SN
150	189326	ESS-150-SN ¹⁾	191011	ESV-150-SN
200	189330	ESS-200-SN ¹⁾	191015	ESV-200-SN
丁腈橡胶, 抗静电 NA				
2	189268	ESS-2-SNA ¹⁾	-	
4	189273	ESS-4-SNA ¹⁾	-	
6	189278	ESS-6-SNA ¹⁾	-	
8	189283	ESS-8-SNA ¹⁾	-	
10	189288	ESS-10-SNA ¹⁾	-	
15	189293	ESS-15-SNA ¹⁾	-	
20	189298	ESS-20-SNA ¹⁾	190983	ESV-20-SNA
30	189303	ESS-30-SNA ¹⁾	190988	ESV-30-SNA
40	189308	ESS-40-SNA ¹⁾	190993	ESV-40-SNA
50	189313	ESS-50-SNA ¹⁾	190998	ESV-50-SNA

1) 不含铜、聚四氟乙烯和硅

真空吸盘，带支座吸盘 ESS/吸盘 ESV，标准圆形

技术参数



订货数据			
吸盘 Ø [mm]	ESS		ESV
	订货号	型号	订货号 型号
硅胶 S			
2	189266	ESS-2-SS	-
4	189271	ESS-4-SS	-
6	189276	ESS-6-SS	-
8	189281	ESS-8-SS	-
10	189286	ESS-10-SS	-
15	189291	ESS-15-SS	-
20	189296	ESS-20-SS	190981 ESV-20-SS
30	189301	ESS-30-SS	190986 ESV-30-SS
40	189306	ESS-40-SS	190991 ESV-40-SS
50	189311	ESS-50-SS	190996 ESV-50-SS
60	189316	ESS-60-SS	191001 ESV-60-SS
80	189320	ESS-80-SS	191005 ESV-80-SS
100	189324	ESS-100-SS	191009 ESV-100-SS
150	189328	ESS-150-SS	191013 ESV-150-SS
200	189332	ESS-200-SS	191017 ESV-200-SS
聚氨酯 U			
2	189265	ESS-2-SU	-
4	189270	ESS-4-SU	-
6	189275	ESS-6-SU	-
8	189280	ESS-8-SU	-
10	189285	ESS-10-SU	-
15	189290	ESS-15-SU	-
20	189295	ESS-20-SU	190980 ESV-20-SU
30	189300	ESS-30-SU	190985 ESV-30-SU
40	189305	ESS-40-SU	190990 ESV-40-SU
50	189310	ESS-50-SU	190995 ESV-50-SU
60	189315	ESS-60-SU	191000 ESV-60-SU
80	189319	ESS-80-SU	191004 ESV-80-SU
100	189323	ESS-100-SU	191008 ESV-100-SU
150	189327	ESS-150-SU	191012 ESV-150-SU
200	189331	ESS-200-SU	191016 ESV-200-SU

真空吸盘，带支座吸盘 ESS/吸盘 ESV，深圆形

技术参数

ESS-...-E...
ESV-...-E...

- ⚡ - 温度范围
-30 ... +200 °C

功能

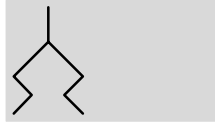

- ∅ - 直径
15 ... 100 mm



主要技术参数								
吸盘 ∅ [mm]	吸盘支座适用规格	安装螺纹	有效吸盘 ∅ [mm]	脱离力, -0.7 bar [N]	吸盘体积 ²⁾ [cm ³]	最小工件半径R ¹⁾ [mm]	重量	
							ESS [g]	ESV [g]
15	规格 3	M4x0.7	13.8	9.8	0.350	20	1.9	-
20	规格 4	M6x1	17.2	17	0.840	30	6.4	1.6
30			20.9	37.2	2.120	50	9.2	2.9
40			28.1	67.6	4.040	80	16.9	8
50			36.9	103.6	7.900	100	23.4	12.6
60	规格 5	M10x1.5	40.5	162.5	19.770	120	48	21
80			62.7	275	51.610	160	141	41
100			78.5	440.8	84.660	200	228	65

- 1) 待抓取工件最小圆弧半径
2) 抽空容积

测量值 F [N], pu = -0.7 bar; Ra = 7 μm				
吸盘 ∅ [mm]	ESS-...-EN	ESS-...-ES	ESS-...-EU	ESS-...-EF
15	9	10	15	14.5
20	14	13	16	15.5
30	24.5	21.5	41.5	18.5
40	53	28.5	46.5	22
50	115	42.5	62	60
60	130	63.5	134	62.5
80	216	107.5	136.5	148.5
100	351	150	352.5	254.5

真空吸盘，带支座吸盘 ESS/吸盘 ESV，深圆形

技术参数

FESTO

尺寸

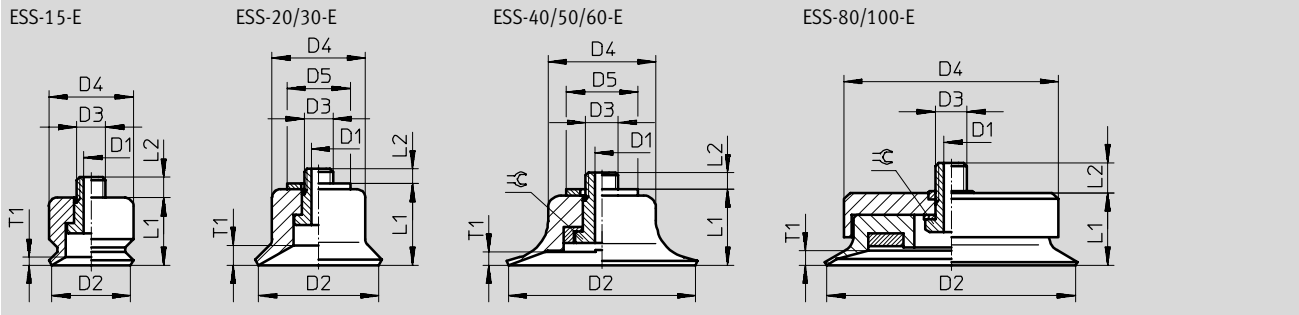

型号 吸盘	真空吸盘	D1 ND	D2 ∅	D3	D4 ∅	D5 ∅	L1	L2	T1	⌀
ESS-15-E...	ESG-15-E...	⌀ 2	15	M4x0.7	11	-	10	3	2.9	-
ESS-20-E...	ESG-20-E...	⌀ 3	20	M6x1	15	18	12.6	2.4	3	-
ESS-30-E...	ESG-30-E...	⌀ 3	30	M6x1	17	18	15.6	3.4	4.5	-
ESS-40-E...	ESG-40-E...	⌀ 3	40	M6x1	25	22	19.1	3.2	4.5	-
ESS-50-E...	ESG-50-E...	⌀ 3	50	M6x1	30	22	21.1	3.9	6.5	-
ESS-60-E...	ESG-60-E...	∅ 6	60	M10x1.5	40	-	27.6	5.4	9.5	14
ESS-80-E...	ESG-80-E...	∅ 6	80	M10x1.5	68	-	33	9.4	8.6	14
ESS-100-E...	ESG-100-E...	∅ 6	100	M10x1.5	85	-	33	8.4	10.7	14

真空吸盘，带支座吸盘 ESS/吸盘 ESV，深圆形

技术参数

FESTO

订货数据				
吸盘 Ø [mm]	ESS		ESV	
	订货号	型号	订货号	型号
氟化橡胶 F				
15	189337	ESS-15-EF ¹⁾	-	
20	189341	ESS-20-EF ¹⁾	191026	ESV-20-EF
30	189345	ESS-30-EF ¹⁾	191030	ESV-30-EF
40	189349	ESS-40-EF ¹⁾	191034	ESV-40-EF
50	189353	ESS-50-EF ¹⁾	191038	ESV-50-EF
60	189357	ESS-60-EF ¹⁾	191042	ESV-60-EF
80	189361	ESS-80-EF ¹⁾	191046	ESV-80-EF
100	189365	ESS-100-EF ¹⁾	191050	ESV-100-EF
丁腈橡胶 N				
15	189334	ESS-15-EN ¹⁾	-	
20	189338	ESS-20-EN ¹⁾	191023	ESV-20-EN
30	189342	ESS-30-EN ¹⁾	191027	ESV-30-EN
40	189346	ESS-40-EN ¹⁾	191031	ESV-40-EN
50	189350	ESS-50-EN ¹⁾	191035	ESV-50-EN
60	189354	ESS-60-EN ¹⁾	191039	ESV-60-EN
80	189358	ESS-80-EN ¹⁾	191043	ESV-80-EN
100	189362	ESS-100-EN ¹⁾	191047	ESV-100-EN
硅胶 S				
15	189336	ESS-15-ES	-	
20	189340	ESS-20-ES	191025	ESV-20-ES
30	189344	ESS-30-ES	191029	ESV-30-ES
40	189348	ESS-40-ES	191033	ESV-40-ES
50	189352	ESS-50-ES	191037	ESV-50-ES
60	189356	ESS-60-ES	191041	ESV-60-ES
80	189360	ESS-80-ES	191045	ESV-80-ES
100	189364	ESS-100-ES	191049	ESV-100-ES
聚氨酯 U				
15	189335	ESS-15-EU	-	
20	189339	ESS-20-EU	191024	ESV-20-EU
30	189343	ESS-30-EU	191028	ESV-30-EU
40	189347	ESS-40-EU	191032	ESV-40-EU
50	189351	ESS-50-EU	191036	ESV-50-EU
60	189355	ESS-60-EU	191040	ESV-60-EU
80	189359	ESS-80-EU	191044	ESV-80-EU
100	189363	ESS-100-EU	191048	ESV-100-EU

1) 不含铜、聚四氟乙烯和硅

真空吸盘，带支座吸盘 ESS/吸盘 ESV，波状圆形，1.5 圈褶

FESTO

技术参数

ESS-...-B...
ESV-...-B...

-  - 温度范围
-30 ... +180 °C

功能



-  - 直径
10 ... 80 mm



主要技术参数

吸盘 Ø [mm]	吸盘支座适用规格	安装螺纹	有效吸盘 Ø [mm]	脱离力, -0.7 bar [N]	吸盘体积 ²⁾ [cm ³]	工件最小半径 R ¹⁾ [mm]	最大高度补偿 H1 [mm]	重量	
								ESS [g]	ESV [g]
10	规格 3	M4x0.7	7.4	4.7	0.380	20	4	1.8	-
20	规格 4	M6x1	14.3	12.9	1.600	40	6	6.7	1.9
30			20.3	26.2	4.070	80	8	9.9	3.6
40			25.2	52.3	8.870	90	9.5	18.7	9.8
50			31.8	72.6	14.230	150	11	24.7	13.9
80	规格 5	M10x1.5	55	213.6	63.900	430	10	139	39

- 1) 待抓取工件最小圆弧半径
2) 抽空容积

最大高度补偿 H1

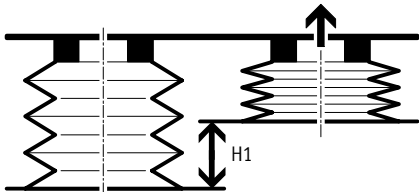

侧向力 F [N], pu = -0.7 bar; Ra = 7 μm

吸盘 Ø [mm]	ESS-...-BN	ESS-...-BS	ESS-...-BU
10	4.5	2.5	3
20	9.5	8	9.5
30	24.5	16	21.5
40	32.5	32.5	33
50	55.5	38	47
80	199.5	93	132.5

真空吸盘，带支座吸盘 ESS/吸盘 ESV，波状圆形，1.5 圈褶

技术参数



尺寸

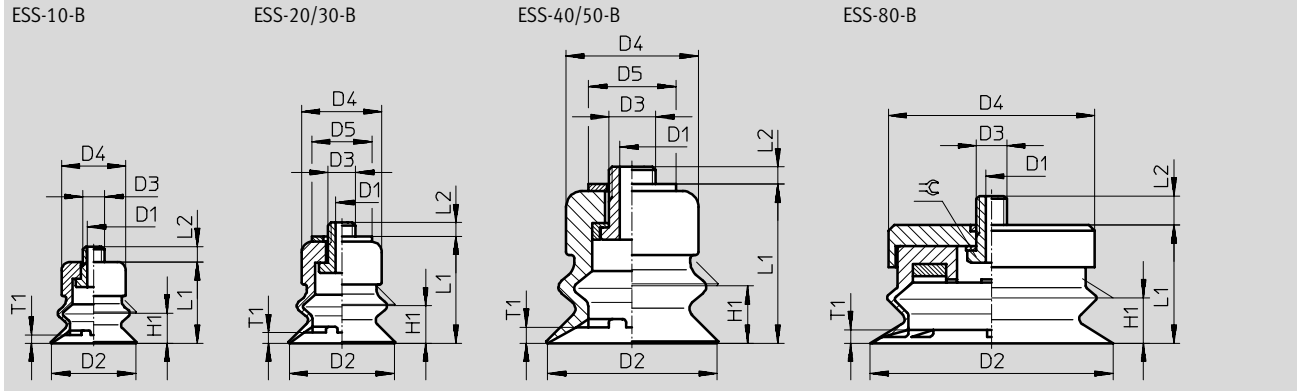

型号 吸盘	For Suction gripper	D1 ND	D2 ∅	D3	D4 ∅	D5 ∅	H1	L1	L2	T1	↳
ESS-10-B...	ESG-10-B...	≈ \varnothing 2	10	M4x0.7	10	-	4	16	3	1	-
ESS-20-B...	ESG-20-B...	≈ \varnothing 3	20	M6x1	15	18	6	20.6	2.4	2	-
ESS-30-B...	ESG-30-B...	≈ \varnothing 3	30	M6x1	17	18	8	24.6	3.4	2.5	-
ESS-40-B...	ESG-40-B...	≈ \varnothing 3	40	M6x1	25	22	9.5	31.6	3.2	4	-
ESS-50-B...	ESG-50-B...	≈ \varnothing 3	50	M6x1	30	22	11	33.6	3.2	4	-
ESS-80-B...	ESG-80-B...	∅ 6	80	M10x1.5	68	-	10	39	9.4	2	14

订货数据

吸盘 ∅ [mm]	ESS		ESV	
	订货号	型号	订货号	型号
丁腈橡胶 N				
10	189374	ESS-10-BN ¹⁾	-	-
20	189378	ESS-20-BN ¹⁾	191054	ESV-20-BN
30	189382	ESS-30-BN ¹⁾	191057	ESV-30-BN
40	189386	ESS-40-BN ¹⁾	191060	ESV-40-BN
50	189390	ESS-50-BN ¹⁾	191063	ESV-50-BN
80	189394	ESS-80-BN ¹⁾	191066	ESV-80-BN
硅胶 S				
10	189376	ESS-10-BS	-	-
20	189380	ESS-20-BS	191056	ESV-20-BS
30	189384	ESS-30-BS	191059	ESV-30-BS
40	189388	ESS-40-BS	191062	ESV-40-BS
50	189392	ESS-50-BS	191065	ESV-50-BS
80	189396	ESS-80-BS	191068	ESV-80-BS
聚氨酯 U				
10	189375	ESS-10-BU	-	-
20	189379	ESS-20-BU	191055	ESV-20-BU
30	189383	ESS-30-BU	191058	ESV-30-BU
40	189387	ESS-40-BU	191061	ESV-40-BU
50	189391	ESS-50-BU	191064	ESV-50-BU
80	189395	ESS-80-BU	191067	ESV-80-BU

1) 不含铜、聚四氟乙烯和硅

真空吸盘，带支座吸盘 ESS/吸盘 ESV，波状圆形，1.5 圈褶

FESTO

技术参数

ESS-...-BT-...
ESV-...-BT

-  - 温度范围
-10 ... +80 °C

功能

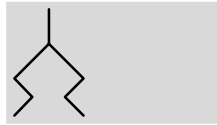

-  - 直径
40 ... 80 mm



主要技术参数							
吸盘 Ø [mm]	吸盘支座适用 规格	安装螺纹	脱离力, -0.7 bar [N]	工件最小半径 R ¹⁾ [mm]	体积 [cm ³]	重量	
						ESS [g]	ESV [g]
40	规格 4	M6x1	59	35	9.70	18	10.5
	规格 5	M10x1.5			9.71	19	
	-	G $\frac{1}{4}$ -I 内螺纹			10.00	19	
	-	G $\frac{1}{4}$ 外螺纹			9.73	20.5	
50	规格 4	M6x1	100	40	17.50	24	16.2
	规格 5	M10x1.5			17.51	25	
	-	G $\frac{1}{4}$ -I 内螺纹			17.80	25	
	-	G $\frac{1}{4}$ 外螺纹			17.53	26	
80	规格 5	M10x1.5	237	100	58.50	84.5	57.2
	-	G $\frac{1}{4}$ -I 内螺纹			58.50	87.5	
	-	G $\frac{1}{4}$ 外螺纹			58.50	85.5	

1) 待抓取工件最小圆弧半径

真空吸盘，带支座吸盘 ESS/吸盘 ESV，波状圆形，1.5 圈褶

技术参数



尺寸

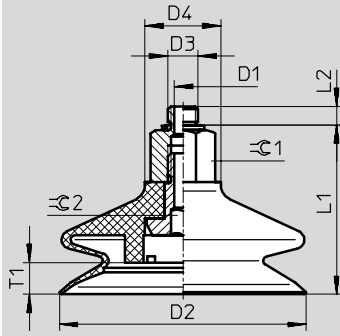

型号	D1 ∅ ND	D2 ∅	D3	D4 ∅	L1	L2	T1	⊘ 1	⊘ 2	
ESS-40-BT	2.5	40	M6	20	36	3.45	9	15	4	
ESS-40-BT-I			M10		36.3	6.2		17		
ESS-50-BT			G $\frac{1}{4}$		48.3	-				
ESS-50-BT-I			G $\frac{1}{4}$							
ESS-50-BT	2.5	50	M6	20	38.05	3.45	8	15	4	
ESS-50-BT-I			M10		38.3	6.2		17		
ESS-80-BT			G $\frac{1}{4}$		50.3	-				
ESS-80-BT-I			G $\frac{1}{4}$							
ESS-80-BT	2.5	80	M10	20	53.3	6.2	10.5	17	8	
ESS-80-BT-I			G $\frac{1}{4}$		60.8	-				
			G $\frac{1}{4}$							

订货数据

吸盘 ∅ [mm]	接口	ESS		ESV	
		订货号	型号	订货号	型号
40	M6	525989	ESS-40-BT-M6 ¹⁾	-	-
	M10	525990	ESS-40-BT-M10 ¹⁾	-	-
	G $\frac{1}{4}$ fe外螺纹	525991	ESS-40-BT-G $\frac{1}{4}$ -I ¹⁾	-	-
	G $\frac{1}{4}$	525992	ESS-40-BT-G $\frac{1}{4}$ ¹⁾	-	-
	-	-	-	526006	ESV-40-BT ¹⁾
50	M6	525993	ESS-50-BT-M6 ¹⁾	-	-
	M10	525994	ESS-50-BT-M10 ¹⁾	-	-
	G $\frac{1}{4}$ fe外螺纹	525995	ESS-50-BT-G $\frac{1}{4}$ -I ¹⁾	-	-
	G $\frac{1}{4}$	525996	ESS-50-BT-G $\frac{1}{4}$ ¹⁾	-	-
	-	-	-	526007	ESV-50-BT ¹⁾
80	M10	525997	ESS-80-BT-M10 ¹⁾	-	-
	G $\frac{1}{4}$ fe外螺纹	525998	ESS-80-BT-G $\frac{1}{4}$ -I ¹⁾	-	-
	G $\frac{1}{4}$	525999	ESS-80-BT-G $\frac{1}{4}$ ¹⁾	-	-
	-	-	-	526008	ESV-80-BT ¹⁾

1) 不含铜、聚四氟乙烯和硅

真空吸盘，带支座吸盘 ESS/吸盘 ESV，波状圆形，3.5 圈褶

FESTO

技术参数

ESS-...-C...
ESV-...-C...

-  - 温度范围
-30 ... +180 °C

功能

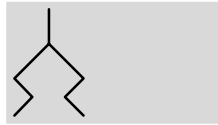

-  - 直径
10 ... 50 mm



主要技术参数

吸盘 Ø [mm]	吸盘支座适用规格	安装螺纹	有效吸盘 Ø [mm]	脱离力, -0.7 bar [N]	吸盘体积 ²⁾ [cm ³]	工件最小半径R ¹⁾ [mm]	最大高度补偿 H1 [mm]	重量	
								ESS [g]	ESV [g]
10	规格 3	M4x0.7	6.9	3.9	0.290	25	3.3	1.6	-
20	规格 4	M6x1	14.5	8.2	2.750	50	7	6.9	2.1
30			20.9	20.8	9.470	80	10.5	12.2	5.8
40			28.2	42.4	19.720	100	12.8	21.9	13
50			32.8	63.4	38.920	180	17.5	32.1	21.3

1) 待抓取工件最小圆弧半径

2) 抽空容积

最大高度补偿 H1

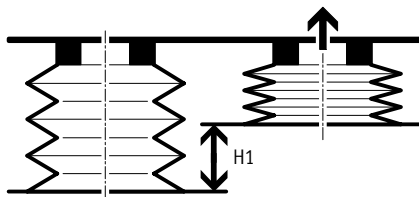

侧向力 F [N], pu = -0.7 bar; Ra = 7 μm

吸盘 Ø [mm]	ESS-...-CN	ESS-...-CS
10	1.5	1
20	6.5	7
30	11.5	11
40	47.5	13
50	49	45.5

真空吸盘，带支座吸盘 ESS/吸盘 ESV，波状圆形，3.5 圈褶

技术参数

尺寸

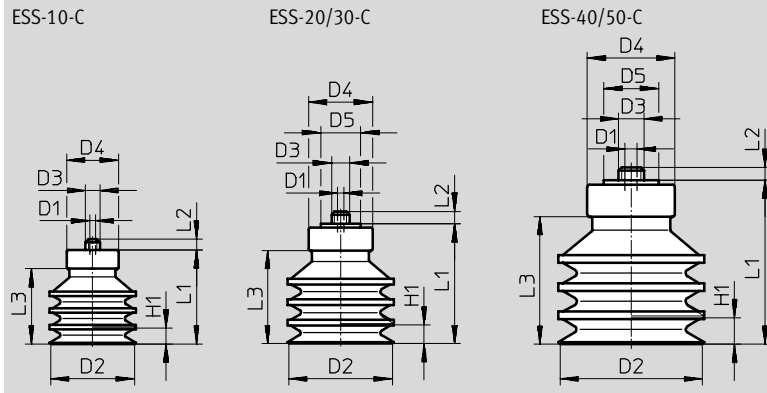

型号 吸盘	真空吸盘	D1 ≡ ND	D2 ∅	D3	D4 ∅	D5 ∅	H1	L1	L2	L3
ESS-10-C...	ESG-10-C...	2	10	M4x0.7	10	-	3.3	12.7	3	8.7
ESS-20-C...	ESG-20-C...	3	20	M6x1	15	18	7	23	2.4	16.4
ESS-30-C...	ESG-30-C...	3	30	M6x1	18	18	10.5	34.3	3.4	26.2
ESS-40-C...	ESG-40-C...	3	40	M6x1	25	22	12.8	39.6	3.2	31
ESS-50-C...	ESG-50-C...	3	50	M6x1	30	22	17.5	48	3.2	39.4

订货数据

吸盘 ∅ [mm]	ESS		ESV	
	订货号	型号	订货号	型号
丁腈橡胶 N				
10	189398	ESS-10-CN ¹⁾	-	-
20	189400	ESS-20-CN ¹⁾	191071	ESV-20-CN
30	189402	ESS-30-CN ¹⁾	191073	ESV-30-CN
40	189404	ESS-40-CN ¹⁾	191075	ESV-40-CN
50	189406	ESS-50-CN ¹⁾	191077	ESV-50-CN
硅胶 S				
10	189399	ESS-10-CS	-	-
20	189401	ESS-20-CS	191072	ESV-20-CS
30	189403	ESS-30-CS	191074	ESV-30-CS
40	189405	ESS-40-CS	191076	ESV-40-CS
50	189407	ESS-50-CS	191078	ESV-50-CS

1) 不含铜、聚四氟乙烯和硅

吸盘 ESS, 椭圆形

技术参数

FESTO

ESS...-0...

- ! - 温度范围
-10 ... +70 °C

功能



主要技术参数						
吸盘规格 [mm]	吸盘支座适用规格	安装螺纹	有效吸盘 Ø [mm]	脱离力, -0.7 bar [N]	吸盘体积 ¹⁾ [cm ³]	重量 [g]
4x10	规格 4	M6x1	0.29	2	0.064	2
4x20			0.57	3.4	0.112	2.5
6x10			0.35	2.9	0.106	2
6x20			0.74	5.9	0.196	2.5
8x20			0.89	8	0.256	2.5
8x30			1.36	10.9	0.376	3
10x30			2.23	15.2	0.350	2.9
15x45	规格 5	M10x1.5	4.84	32	1.570	23.8
20x60			9.12	62.8	3.690	30.8
25x75			14.67	92.5	6.700	46.8
30x90			21.83	134.4	10.170	55.3

1) 抽空容积

侧向力 F [N], pu = -0.7 bar, Ra = 7 µm		
吸盘规格 [mm]	水平	垂直
4x10	3.5	5
4x20	4.5	11
6x10	8.5	12
6x20	9	12.5
8x20	11	13
8x30	17	13.5
10x30	23	16
15x45	43	35
20x60	116	63
25x75	125.5	115
30x90	201	134.5

吸盘 ESS, 椭圆形

技术参数

尺寸

ESS-4x10 ... 10x30-0

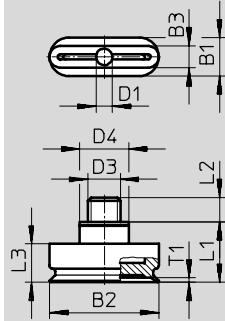

ESS-15x45 ... 30x90-0

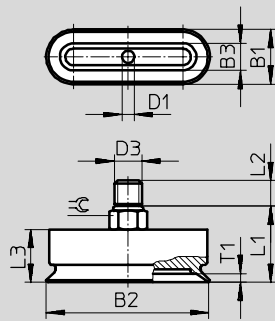

型号	真空吸盘	B1	B2	B3	D1 ∅ NW	D3	D4 ∅	L1	L2	L3	T1	⊖
ESS-4x10-0...	ESG-4x10-0...	7	10	4	2.5	M6x1	9	11.1	4.4	7	0.8	-
ESS-4x20-0...	ESG-4x20-0...	7	20	4	2.5	M6x1	9	11.1	4.4	7	0.8	-
ESS-6x10-0...	ESG-6x10-0...	7	10	6	2.5	M6x1	9	11.1	4.4	7	1	-
ESS-6x20-0...	ESG-6x20-0...	7	20	6	2.5	M6x1	9	11.1	4.4	7	1	-
ESS-8x20-0...	ESG-8x20-0...	7	20	8	2.5	M6x1	9	11.1	4.4	7	1	-
ESS-8x30-0...	ESG-8x30-0...	7	30	8	2.5	M6x1	9	11.1	4.4	7	1	-
ESS-10x30-0...	ESG-10x30-0...	10	30	7	2.5	M6x1	9	11.1	4.4	7	1.1	-
ESS-15x45-0...	ESG-15x45-0...	15	45	15	6	M10x1.5	-	25.5	8.5	18.5	2.5	12
ESS-20x60-0...	ESG-20x60-0...	20	60	20	6	M10x1.5	-	26.3	8.5	19.3	3.2	12
ESS-25x75-0...	ESG-25x75-0...	25	75	25	6	M10x1.5	-	28	8.5	21	3.7	12
ESS-30x90-0...	ESG-30x90-0...	30	90	30	6	M10x1.5	-	28.5	8.5	21.5	3.7	12

订货数据

吸盘规格

[mm]

ESS

订货号 型号

丁腈橡胶 N

4x10	189408	ESS-4X10-ON ¹⁾
4x20	189409	ESS-4X20-ON ¹⁾
6x10	189410	ESS-6X10-ON ¹⁾
6x20	189411	ESS-6X20-ON ¹⁾
8x20	189412	ESS-8X20-ON ¹⁾
8x30	189413	ESS-8X30-ON ¹⁾
10x30	189414	ESS-10X30-ON ¹⁾
15x45	189415	ESS-15X45-ON ¹⁾
20x60	189416	ESS-20X60-ON ¹⁾
25x75	189417	ESS-25X75-ON ¹⁾
30x90	189418	ESS-30X90-ON ¹⁾

1) 不含铜、聚四氟乙烯和硅

真空吸盘，带支座吸盘 ESS/吸盘 ESV，铃形

FESTO

ESS-...-GT-...
ESV-...-GT

- ! - 温度范围
-10 ... +80 °C

功能

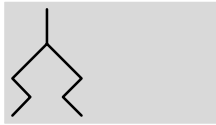

- Ø - 直径
30 ... 100 mm



主要技术参数								
吸盘 Ø [mm]	吸盘支座适用 规格	安装螺纹	脱离力, -0.7 bar [N]	工件最小半 R ¹⁾ [mm]	体积 [cm ³]	重量		
						ESS [g]	ESV [g]	
30	规格 4	M6x1	36	26	2.3	12	4.2	
	规格 5	M10x1.5				13		
	-	G ¹ / ₈ -I 内螺纹				14		
	-	G ¹ / ₈ 外螺纹				13		
40	规格 4	M6x1	64	35	5.1	14	5.7	
	规格 5	M10x1.5				15		
	-	G ¹ / ₄ -I 内螺纹				5.4		14.5
	-	G ¹ / ₄ 外螺纹				5.1		16
50	规格 4	M6x1	97	40	11.2	17	9.2	
	规格 5	M10x1.5				18		
	-	G ¹ / ₄ -I 内螺纹				11.5		18
	-	G ¹ / ₄ 外螺纹				11.2		21
60	规格 5	M10x1.5	134	75	12.3	20	10.7	
	-	G ¹ / ₄ -I 内螺纹				19.5		
	-	G ¹ / ₄ 外螺纹				21		
80	规格 5	M10x1.5	245	100	28.0	28	30.9	
	-	G ¹ / ₄ -I 内螺纹				61		
	-	G ¹ / ₄ 外螺纹				60		
100	规格 5	M10x1.5	375	135	53.2	86.5	58.9	
	-	G ¹ / ₄ -I 内螺纹				89.5		
	-	G ¹ / ₄ 外螺纹				87.5		

1) 待抓取工件最小圆弧半径

真空吸盘，带支座吸盘 ESS/吸盘 ESV，铃形

技术参数

尺寸

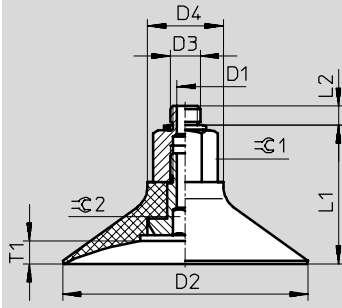

型号	D1 ∅ ND	D2 ∅	D3	D4 ∅	L1	L2	T1	∅ 1	∅ 2
ESS-30-GT	2.5	30	M6	20	27.55	3.45	3.5	15	4
ESS-30-GT-I			M10		27.8	6.2		17	
ESS-40-GT			G $\frac{1}{8}$		36.8	4.7		15	
ESS-40-GT-I	2.5	40	G $\frac{1}{8}$	20	29.55	3.45	5.5	15	4
ESS-50-GT			M6		29.8	6.2		17	
ESS-50-GT-I			M10		30.2	5.8		15	
ESS-60-GT	2.5	50	G $\frac{1}{4}$	20	32.05	3.45	8	15	4
ESS-60-GT-I			M6		32.3	6.2		17	
ESS-80-GT			M10		32.7	5.8		15	
ESS-80-GT-I	5.5	60	G $\frac{1}{4}$	20	44.7	-	6	17	4
ESS-100-GT			M10		34.3	6.2		17	
ESS-100-GT-I			G $\frac{1}{4}$		34.7	5.8		17	
ESS-30-GT	5.5	80	G $\frac{1}{4}$	25	43.3	6.2	7.5	22	8
ESS-40-GT			M10		47.8	6.2		22	
ESS-40-GT-I			G $\frac{1}{4}$		54.7	-		22	
ESS-50-GT	5.5	100	G $\frac{1}{4}$	25	47.8	6.2	9	22	8
ESS-60-GT			M10		48.2	5.8		22	
ESS-60-GT-I			G $\frac{1}{4}$		59.2	-		22	

真空吸盘，带支座吸盘 ESS/吸盘 ESV，铃形

技术参数

FESTO

订货数据					
吸盘 Ø [mm]	接口	ESS		ESV	
		订货号	型号	订货号	型号
30	M6	525968	ESS-30-GT-M6 ¹⁾	-	
	M10	525969	ESS-30-GT-M10 ¹⁾	-	
	G ¹ / ₈ 内螺纹	525970	ESS-30-GT-G ¹ / ₈ -I ¹⁾	-	
	G ¹ / ₈	525971	ESS-30-GT-G ¹ / ₈ ¹⁾	-	
	-	-	-	526000	ESV-30-GT ¹⁾
40	M6	525972	ESS-40-GT-M6 ¹⁾	-	
	M10	525973	ESS-40-GT-M10 ¹⁾	-	
	G ¹ / ₄ 内螺纹	525974	ESS-40-GT-G ¹ / ₄ -I ¹⁾	-	
	G ¹ / ₄	525975	ESS-40-GT-G ¹ / ₄ ¹⁾	-	
	-	-	-	526001	ESV-40-GT ¹⁾
50	M6	525976	ESS-50-GT-M6 ¹⁾	-	
	M10	525977	ESS-50-GT-M10 ¹⁾	-	
	G ¹ / ₄ 内螺纹	525978	ESS-50-GT-G ¹ / ₄ -I ¹⁾	-	
	G ¹ / ₄	525979	ESS-50-GT-G ¹ / ₄ ¹⁾	-	
	-	-	-	526002	ESV-50-GT ¹⁾
60	M10	525980	ESS-60-GT-M10 ¹⁾	-	
	G ¹ / ₄ 内螺纹	525981	ESS-60-GT-G ¹ / ₄ -I ¹⁾	-	
	G ¹ / ₄	525982	ESS-60-GT-G ¹ / ₄ ¹⁾	-	
	-	-	-	526003	ESV-60-GT ¹⁾
80	M10	525983	ESS-80-GT-M10 ¹⁾	-	
	G ¹ / ₄ 内螺纹	525984	ESS-80-GT-G ¹ / ₄ -I ¹⁾	-	
	G ¹ / ₄	525985	ESS-80-GT-G ¹ / ₄ ¹⁾	-	
	-	-	-	526004	ESV-80-GT ¹⁾
100	M10	525986	ESS-100-GT-M10 ¹⁾	-	
	G ¹ / ₄ 内螺纹	525987	ESS-100-GT-G ¹ / ₄ -I ¹⁾	-	
	G ¹ / ₄	525988	ESS-100-GT-G ¹ / ₄ ¹⁾	-	
	-	-	-	526005	ESV-100-GT ¹⁾

1) 不含铜、聚四氟乙烯和硅

吸盘 ESS和ESV

附件

FESTO

吸盘嵌件OASI

用于吸盘

吸盘 \varnothing 20 mm,

波状 3.5 圈褶

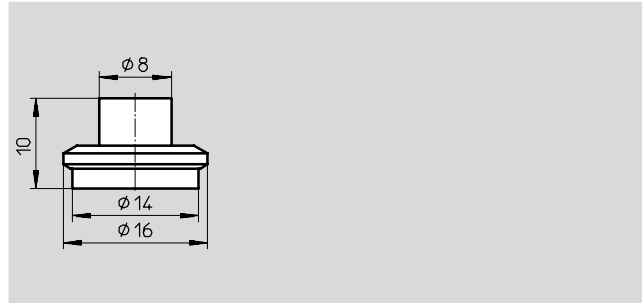

主要技术参数		
工作压力	[bar]	-0.95 ... 0
工作介质		大气空气
环境温度	[°C]	5 ... 50
喷射脉冲适用性	[bar]	≤0.3
安装方式		嵌入
安装位置		内耳轴
材料		
吸盘嵌件		聚乙烯
材料注意事项		符合RoHS规定

订货数据和重量		
	重量 [g]	订货号 型号
吸盘嵌件	0.6	1072015 OASI-20-E