

Angle seat valve VZXF, NPT

FESTO



Angle seat valve VZXF, NPT



Key features

Function

Angle seat valves are externally actuated valves. These valves are actuated by a direct supply of compressed air. In this process, the seat of the process valve is raised by means of a pneumatic actuator. In the normal position, the valve is closed by a spring. When the actuator is subjected to operating pressure, it raises the actuating piston and, at the same time, the valve disc too – the

valve opens. The valve seat is slanted at an angle of approx. 50° in relation to the medium flow. The direction of flow is determined by the design of the valve. Angle seat valves are used in applications in which absolute purity of the medium cannot be ensured, in which highly viscous media are to be controlled or in steam applications.

Design

-  Connecting thread
NPT½ ... NPT2
-  Flow rate Kv
3.3 ... 43 m³/h
- Gunmetal (red brass) variant
- Stainless steel casting variant
- Stainless steel casting variant with nickel-plated actuator head

General

- Angle seat valves are simple and sturdy and are thus perfectly suitable for almost all media with a viscosity of up to 600 mm²/s
- Angle seat valves control suitable gaseous and liquid media in rigid piping systems without the need for any pressure differential
- No pressure differential required between the inlet and outlet
- Low flow resistance
- Insensitive to steam or slightly contaminated media
- Long service life
- Low maintenance
- The valves have a high chemical and thermal resistance by virtue of their design
- The N/C function ensures that the valve is closed in the event of pressure loss in the control circuit
- Different designs of angle seat valves are available depending on the pressure of the medium
- There is a choice of two versions: “closing in the direction of medium flow” is used for gaseous media; “closing against the direction of media flow” is used for liquid media
- “Suitable for vacuum” is used for angle seat valves in packaging machines which need to generate a vacuum

Variants

VZXF-L-...-M-A-N112-350-H3B1-50-8

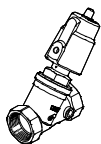

VZXF-L-...-M-A-N112-350-M1-V4V4T-50-7

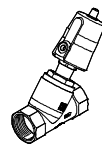

VZXF-L-...-M-A-N12-120-M1-H3B1-50-16

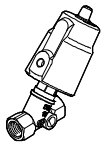

VZXF-L-...-M-B-N12-130-M1-V4V4T-50-40

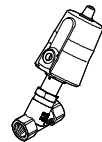

VZXF-F-L-...-M-B-N2-430-H3B1-50-3

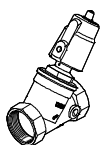



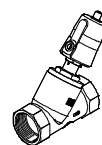

VZXF-F-L-...-M-B-N2-450-M1-V4V4T-50-3

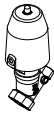

Angle seat valve VZXF, NPT

Product range overview

Version	Type	Process valve connection	Nominal size DN	Temperature of medium [°C]	Flow rate Kv [m³/h]	Process valve nominal pressure PN	→ Page/Internet
Gunmetal (red brass)							
	VZXF-L-...-H3B1-...	NPT½	15	-10 ... +80	3.5 ... 28	16	6
		NPT¾	20				
		NPT1	25				
		NPT1¼	32				
		NPT1½	40				
		NPT2	50				
Stainless steel casting							
	VZXF-L-...-V4V4T-...	NPT½	15	-40 ... +200	3.3 ... 43	40	9
		NPT¾	20				
		NPT1	25				
		NPT1¼	32				
		NPT1½	40				
		NPT2	50				
Stainless steel casting with nickel-plated actuator head							
	VZXF-L-...-V4B2T-...	NPT½	15	-40 ... +200	3.3 ... 34.5	40	13 
		NPT¾	20				
		NPT1	25				
		NPT1¼	32				
		NPT1½	40				
		NPT2	50				

Angle seat valve VZXF, NPT

Type codes

VZXF - L - M22C - M - A - N12 - 130 - M1 -

Type

VZXF	Angle seat valve, externally actuated
------	---------------------------------------

Type of directional control valve

L	In-line valve
---	---------------

Valve function

M22C	2/2-way valve, normally closed
------	--------------------------------

Reset method for monostable valves

M	Mechanical spring
---	-------------------

Media flow

A	Above valve seat for gaseous media
B	Below valve seat for gaseous and liquid media

Process valve connection

N12	Thread NPT1/2
N34	Thread NPT3/4
N1	Thread NPT1
N114	Thread NPT1 1/4
N112	Thread NPT1 1/2
N2	Thread NPT2

Nominal width

120	12 mm
130	13 mm
160	16 mm
180	18 mm
230	23 mm
240	24 mm
290	29 mm
310	31 mm
350	35 mm
430	43 mm
450	45 mm

Temperature range of medium

	Standard, -10 ... +80 °C
M1	-40 ... +200 °C

Angle seat valve VZXF, NPT

Type codes

		H3	B1		-	50	-	10
Housing material								
H3	Gunmetal (red brass)							
V4	Stainless steel							
Housing, actuator material								
AL	Aluminium							
AN	Nickel-plated aluminium							
B1	Brass							
B2	Nickel-plated brass							
V4	Stainless steel							
Sealing materials								
	Standard, NBR							
T	PTFE							
V	FPM							
Actuator size								
50	50 mm							
80	80 mm							
Medium pressure								
V	-0.9 ... 0 bar							
3	Max. 3 bar							
4	Max. 4 bar							
5	Max. 5 bar							
6	Max. 6 bar							
7	Max. 7 bar							
8	Max. 8 bar							
9	Max. 9 bar							
10	Max. 10 bar							
12	Max. 12 bar							
16	Max. 16 bar							
20	Max. 20 bar							
22	Max. 22 bar							
25	Max. 25 bar							
40	Max. 40 bar							

Angle seat valve VZXF, NPT

Technical data – Gunmetal (red brass), temperature of medium –10 ... +80 °C

FESTO

Function

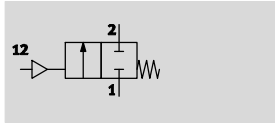

-  - Flow rate Kv
3.5 ... 28 m³/h

-  - Connecting thread
NPT¹/₂ ... NPT2



General technical data			
Process valve connection	NPT ¹ / ₂	NPT ³ / ₄	NPT1
Auxiliary pilot air port	G ¹ / ₈		
Nominal size DN	15	20	25
Nominal width [mm]	12	16	23
Valve function	2/2-way, closed, monostable		
Design	Poppet valve with spring return		
Type of mounting	In-line installation		
Mounting position	Any		
Direction of flow	Non-reversible		
Exhaust function	No flow control		
Sealing principle	Soft		
Reset method	Mechanical spring		
Type of actuation	Pneumatic		
Type of pilot control	With external control		
Operating medium	Compressed air to ISO 8573-1:2010 [7:4:4]		

Process valve connection	NPT ¹ / ₄	NPT ¹ / ₂	NPT2
Auxiliary pilot air port	G ¹ / ₈		
Nominal size DN	32	40	50
Nominal width [mm]	29	35	43
Valve function	2/2-way, closed, monostable		
Design	Poppet valve with spring return		
Type of mounting	In-line installation		
Mounting position	Any		
Direction of flow	Non-reversible		
Exhaust function	No flow control		
Sealing principle	Soft		
Reset method	Mechanical spring		
Type of actuation	Pneumatic		
Type of pilot control	With external control		
Operating medium	Compressed air to ISO 8573-1:2010 [7:4:4]		

Angle seat valve VZXF, NPT

FESTO

Technical data – Gunmetal (red brass), temperature of medium –10 ... +80 °C

Operating and environmental conditions			
Process valve connection	NPT $\frac{1}{2}$	NPT $\frac{3}{4}$	NPT1
Nominal pressure of process valve PN	16		
Medium	Filtered compressed air, grade of filtration 200 µm		
	Mineral oil-based hydraulic oil		
	Inert gases		
	Mineral oil		
	Neutral fluids		
	Water		
Max. viscosity	[mm ² /s]	600	
Ambient temperature	[°C]	–10 ... +60	
Temperature of medium	[°C]	–10 ... +80	
CE marking (see declaration of conformity)	–		

Operating and environmental conditions			
Process valve connection	NPT $\frac{1}{4}$	NPT $\frac{1}{2}$	NPT2
Nominal pressure of process valve PN	16		
Medium	Filtered compressed air, grade of filtration 200 µm		
	Mineral oil-based hydraulic oil		
	Inert gases		
	Mineral oil		
	Neutral fluids		
	Water		
Max. viscosity	[mm ² /s]	600	
Ambient temperature	[°C]	–10 ... +60	
Temperature of medium	[°C]	–10 ... +80	
CE marking (see declaration of conformity)	To EU Pressure Equipment Directive		

Materials		
Angle seat valves		Material number
① Housing	Gunmetal (red brass)	CC499K
② Actuator head	Brass	–
③ Stem seal	NBR	–
	Seat seal	PTFE
– Note on materials	Contains paint-wetting impairment substances, RoHS compliant	–

Angle seat valve VZXF, NPT

Technical data – Gunmetal (red brass), temperature of medium –10 ... +80 °C

Dimensions

Download CAD data → www.festo.com

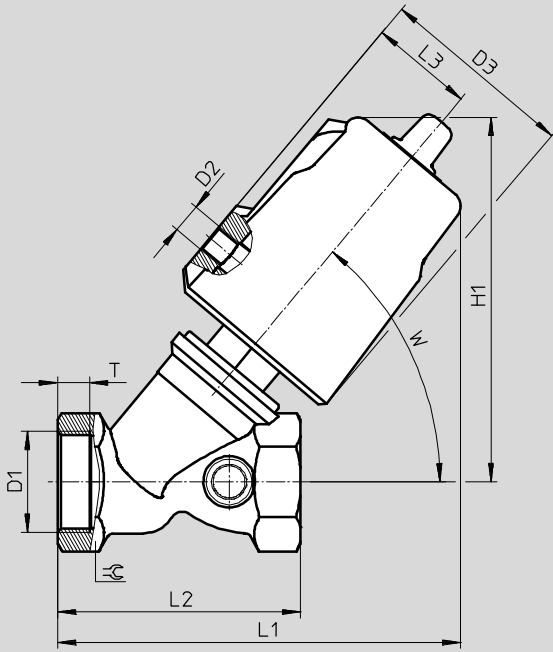

	D1	D2	D3 Ø	H1	L1	L2	L3	T	W	⊕
VZXF-L-...-N12-...-H3B1-50-...	NPT $\frac{1}{2}$	G $\frac{1}{8}$	62	112	123	66	34	8	50°	27
VZXF-L-...-N34-...-H3B1-50-...	NPT $\frac{3}{4}$			117	130	75		9		33
VZXF-L-...-N1-...-H3B1-50-...	NPT1			121	133	80		10.5		41
VZXF-L-...-N114-...-H3B1-50-...	NPT1 $\frac{1}{4}$			139	154	97		12.5		50
VZXF-L-...-N112-...-H3B1-50-...	NPT1 $\frac{1}{2}$			145	161	107		14.5		56
VZXF-L-...-N2-...-H3B1-50-...	NPT2			154	171	124		16.5		68

Ordering data – Angle seat valve VZXF

	Process valve connection	Flow rate Kv [m ³ /h]	Medium pressure [bar]	Corrosion resistance CRC ¹⁾	Product weight [g]	Part No.	Type
	NPT $\frac{1}{2}$	3.5	0 ... 16	1	1200	1002533	VZXF-L-M22C-M-A-N12-120-H3B1-50-16
		3.7				1002534	VZXF-L-M22C-M-B-N12-120-H3B1-50-16
	NPT $\frac{3}{4}$	6.7	0 ... 16		1300	1002535	VZXF-L-M22C-M-A-N34-160-H3B1-50-16
		5.2				1002536	VZXF-L-M22C-M-B-N34-160-H3B1-50-16
	NPT1	10.8	0 ... 16		1500	1002537	VZXF-L-M22C-M-A-N1-230-H3B1-50-16
		9.6				1002538	VZXF-L-M22C-M-B-N1-230-H3B1-50-10
	NPT1 $\frac{1}{4}$	19	0 ... 10		1900	1002539	VZXF-L-M22C-M-A-N114-290-H3B1-50-10
		6	0 ... 7			1002540	VZXF-L-M22C-M-B-N114-290-H3B1-50-7
	NPT1 $\frac{1}{2}$	23	0 ... 8		2300	1002541	VZXF-L-M22C-M-A-N112-350-H3B1-50-8
		16.5	0 ... 6			1002542	VZXF-L-M22C-M-B-N112-350-H3B1-50-6
	NPT2	28	0 ... 4		2800	1002543	VZXF-L-M22C-M-A-N2-430-H3B1-50-4
		23	0 ... 3			1002544	VZXF-L-M22C-M-B-N2-430-H3B1-50-3

1) Corrosion resistance class CRC 1 to Festo standard FN 940070

Low corrosion stress. For dry indoor applications or transport and storage protection. Also applies to parts behind covers, in the non-visible interior area, and parts which are covered in the application (e.g. drive trunnions).

Angle seat valve VZXF, NPT

Technical data – Stainless steel casting, temperature of medium –40 ... 200 °C

Function

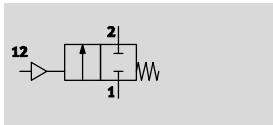

-  - Flow rate Kv
3.3 ... 43 m³/h

-  - Connecting thread
NPT1/2 ... NPT2



General technical data			
Process valve connection	NPT1/2	NPT3/4	NPT1
Auxiliary pilot air port	G1/8		
Nominal size DN	15	20	25
Nominal width [mm]	13	18	24
Valve function	2/2-way, closed, monostable		
Design	Poppet valve with spring return		
Type of mounting	In-line installation		
Mounting position	Any		
Direction of flow	Non-reversible		
Exhaust function	No flow control		
Sealing principle	Soft		
Reset method	Mechanical spring		
Type of actuation	Pneumatic		
Type of pilot control	Externally actuated		
Pilot medium	Compressed air to ISO 8573-1:2010 [7:4:4]		

Process valve connection	NPT1 1/4	NPT1 1/2	NPT2
Auxiliary pilot air port	G1/8		
Nominal size DN	32	40	50
Nominal width [mm]	31	35	45
Valve function	2/2-way, closed, monostable		
Design	Poppet valve with spring return		
Type of mounting	In-line installation		
Mounting position	Any		
Direction of flow	Non-reversible		
Exhaust function	No flow control		
Sealing principle	Soft		
Reset method	Mechanical spring		
Type of actuation	Pneumatic		
Type of pilot control	Externally actuated		
Pilot medium	Compressed air to ISO 8573-1:2010 [7:4:4]		

Angle seat valve VZXF, NPT

Technical data – Stainless steel casting, temperature of medium –40 ... +200 °C

Operating and environmental conditions			
Process valve connection	NPT $\frac{1}{2}$	NPT $\frac{3}{4}$	NPT1
Nominal pressure of process valve PN	40		
Medium	Filtered compressed air, grade of filtration 200 µm		
	Mineral oil-based hydraulic oil		
	Inert gases		
	Mineral oil		
	Neutral fluids		
	Water		
	Steam		
Max. viscosity	[mm ² /s]	600	
Ambient temperature	[°C]	–10 ... 60	
Temperature of medium	[°C]	–40 ... 200	
CE marking (see declaration of conformity)	–		

Process valve connection	NPT $1\frac{1}{4}$	NPT $1\frac{1}{2}$	NPT2
Nominal pressure of process valve PN	40		
Medium	Filtered compressed air, grade of filtration 200 µm		
	Mineral oil-based hydraulic oil		
	Inert gases		
	Mineral oil		
	Neutral fluids		
	Water		
	Steam		
Max. viscosity	[mm ² /s]	600	
Ambient temperature	[°C]	–10 ... 60	
Temperature of medium	[°C]	–40 ... 200	
CE marking (see declaration of conformity)	To EU Pressure Equipment Directive		

Materials		
Angle seat valves		Material number
1 Housing	Stainless steel casting	1.4408
2 Actuator head	Stainless steel	–
3 Stem seal	PTFE	–
	Seat seal	PTFE
– Note on materials	Contains paint-wetting impairment substances, RoHS compliant	–

Angle seat valve VZXF, NPT

Technical data – Stainless steel casting, temperature of medium –40 ... +200 °C

Dimensions

Download CAD data → www.festo.com

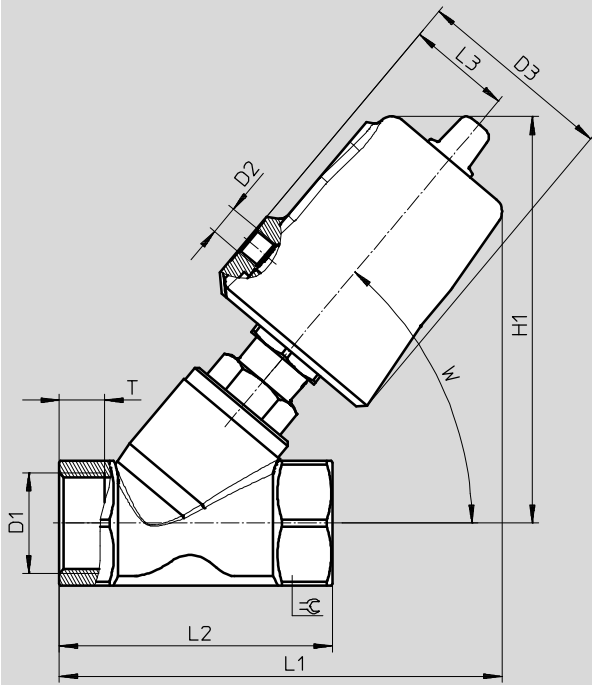

	D1	D2	D3 Ø	H1	L1	L2	L3	T	W	≡
VZXF-L-...-N12-...-V4V4T-50-...	NPT1/2	G1/8	62	129	135	65	34	12	50°	27
VZXF-L-...-N34-...-V4V4T-50-...	NPT3/4			130	138	75		13		32
VZXF-L-...-N1-...-V4V4T-50-...	NPT1			135	146	90	15	42		
VZXF-L-...-N1-...-V4V4T-80-...	NPT1		94	177	184	48	17	50		
VZXF-L-...-N114-...-V4V4T-50-...	NPT1 1/4		62	151	155	110				34
VZXF-L-...-N114-...-V4V4T-80-...	NPT1 1/4		94	183	194	48	19	55		
VZXF-L-...-N112-...-V4V4T-50-...	NPT1 1/2		62	155	174	120	34	21		70
VZXF-L-...-N112-...-V4V4T-80-...	NPT1 1/2		94	187	202	48				
VZXF-L-...-N2-...-V4V4T-50-...	NPT2		62	167	193	150	34	48		
VZXF-L-...-N2-...-V4V4T-80-...	NPT2		94	199	222					

Angle seat valve VZXF, NPT

FESTO

Technical data – Stainless steel casting, temperature of medium –40 ... +200 °C

Ordering data – Angle seat valve VZXF							
	Process valve connection	Flow rate Kv [m³/h]	Medium pressure [bar]	Corrosion resistance CRC ¹⁾	Product weight [g]	Part No.	Type
	NPT ¹ / ₂	3.8	0 ... 25	3	1300	1002545	VZXF-L-M22C-M-A-N12-130-M1-V4V4T-50-25
		3.3	0 ... 40			1002546	VZXF-L-M22C-M-B-N12-130-M1-V4V4T-50-40
	NPT ³ / ₄	7.5	0 ... 20		1400	1002547	VZXF-L-M22C-M-A-N34-180-M1-V4V4T-50-20
		6.5	0 ... 20			1002548	VZXF-L-M22C-M-B-N34-180-M1-V4V4T-50-20
	NPT1	12	0 ... 16		1600	1002549	VZXF-L-M22C-M-A-N1-240-M1-V4V4T-50-16
		11	0 ... 10			1002550	VZXF-L-M22C-M-B-N1-240-M1-V4V4T-50-10
		12.5	0 ... 40		3600	1002551	VZXF-L-M22C-M-A-N1-240-M1-V4V4T-80-40
		12	0 ... 22			1002552	VZXF-L-M22C-M-B-N1-240-M1-V4V4T-80-22
	NPT ¹ / ₄	18.5	0 ... 9		2200	1002553	VZXF-L-M22C-M-A-N114-310-M1-V4V4T-50-9
		10.7	0 ... 7			1002554	VZXF-L-M22C-M-B-N114-310-M1-V4V4T-50-7
		19	0 ... 25		3800	1002555	VZXF-L-M22C-M-A-N114-310-M1-V4V4T-80-25
		17.5	0 ... 10			1002556	VZXF-L-M22C-M-B-N114-310-M1-V4V4T-80-10
	NPT ¹ / ₂	25	0 ... 7		2500	1002557	VZXF-L-M22C-M-A-N112-350-M1-V4V4T-50-7
		17.5	0 ... 6			1002558	VZXF-L-M22C-M-B-N112-350-M1-V4V4T-50-6
		29	0 ... 20		4300	1002559	VZXF-L-M22C-M-A-N112-350-M1-V4V4T-80-20
		28	0 ... 8			1002560	VZXF-L-M22C-M-B-N112-350-M1-V4V4T-80-8
	NPT2	34.5	0 ... 4		3500	1002561	VZXF-L-M22C-M-A-N2-450-M1-V4V4T-50-4
		19.5	0 ... 3			1002562	VZXF-L-M22C-M-B-N2-450-M1-V4V4T-50-3
		43	0 ... 12		5400	1002563	VZXF-L-M22C-M-A-N2-450-M1-V4V4T-80-12
		39	0 ... 5			1002564	VZXF-L-M22C-M-B-N2-450-M1-V4V4T-80-5

1) Corrosion resistance class CRC 3 to Festo standard FN 940070
High corrosion stress. Outdoor exposure under moderate corrosive conditions. External visible parts with primarily functional requirements for the surface and which are in direct contact with a normal industrial environment.

Angle seat valve VZXF, NPT

Technical data – Stainless steel casting with nickel-plated actuator head

Function

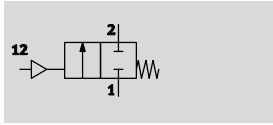

 Flow rate Kv
3.3 ... 34.5 m³/h

 NPT $\frac{1}{2}$... NPT2



General technical data			
Process valve connection	NPT $\frac{1}{2}$	NPT $\frac{3}{4}$	NPT1
Pneumatic connection	G $\frac{1}{8}$		
Nominal size DN	15	20	25
Nominal width [mm]	13	18	24
Valve function	2/2-way, closed, monostable		
Design	Poppet valve with spring return		
Type of mounting	In-line installation		
Mounting position	Any		
Direction of flow	Non-reversible		
Exhaust function	No flow control		
Sealing principle	Soft		
Reset method	Mechanical spring		
Type of actuation	Pneumatic		
Type of pilot control	Externally actuated		

Process valve connection	NPT $\frac{1}{4}$	NPT $\frac{1}{2}$	NPT2
Pneumatic connection	G $\frac{1}{8}$		
Nominal size DN	32	40	50
Nominal width [mm]	31	35	45
Valve function	2/2-way, closed, monostable		
Design	Poppet valve with spring return		
Type of mounting	In-line installation		
Mounting position	Any		
Direction of flow	Non-reversible		
Exhaust function	No flow control		
Sealing principle	Soft		
Reset method	Mechanical spring		
Type of actuation	Pneumatic		
Type of pilot control	Externally actuated		

Angle seat valve VZXF, NPT

Technical data – Stainless steel casting with nickel-plated actuator head

Operating and environmental conditions						
Process valve connection	NPT $\frac{1}{2}$		NPT $\frac{3}{4}$		NPT1	
Variant	...-M-A-...	...-M-B-...	...-M-A-...	...-M-B-...	...-M-A-...	...-M-B-...
Nominal pressure of process valve PN	40					
Operating pressure [bar]	6 ... 10					
Operating medium	Compressed air to ISO 8573-1:2010 [7:4:4]					
Medium	Vapour					
	Inert gases					
	Filtered compressed air, grade of filtration 200 μ m					
	–	Mineral oil-based hydraulic oil	–	Mineral oil-based hydraulic oil	–	Mineral oil-based hydraulic oil
	–	Mineral oil	–	Mineral oil	–	Mineral oil
	–	Neutral fluids	–	Neutral fluids	–	Neutral fluids
	–	Water	–	Water	–	Water
Max. viscosity [mm ² /s]	600					
Ambient temperature [°C]	–10 ... +60					
Temperature of medium [°C]	–40 ... +200					
CE marking (see declaration of conformity)	–					

Process valve connection	NPT $\frac{1}{4}$		NPT $\frac{1}{2}$		NPT2	
Variant	...-M-A-...	...-M-B-...	...-M-A-...	...-M-B-...	...-M-A-...	...-M-B-...
Nominal pressure of process valve PN	40					
Operating pressure [bar]	6 ... 10					
Operating medium	Compressed air to ISO 8573-1:2010 [7:4:4]					
Medium	Vapour					
	Inert gases					
	Filtered compressed air, grade of filtration 200 μ m					
	–	Mineral oil-based hydraulic oil	–	Mineral oil-based hydraulic oil	–	Mineral oil-based hydraulic oil
	–	Mineral oil	–	Mineral oil	–	Mineral oil
	–	Neutral fluids	–	Neutral fluids	–	Neutral fluids
	–	Water	–	Water	–	Water
Max. viscosity [mm ² /s]	600					
Ambient temperature [°C]	–10 ... +60					
Temperature of medium [°C]	–40 ... +200					
CE marking (see declaration of conformity)	To EU Pressure Equipment Directive					

Materials		
Angle seat valves		Material number
1 Housing	Stainless steel casting	1.4408
2 Actuator head	Nickel-plated brass	–
3 Stem seal	PTFE	–
Seat seal	PTFE	–
– Note on materials	Contains paint-wetting impairment substances, RoHS compliant	

Angle seat valve VZXF, NPT

Technical data – Stainless steel casting with nickel-plated actuator head

Dimensions

Download CAD data → www.festo.com

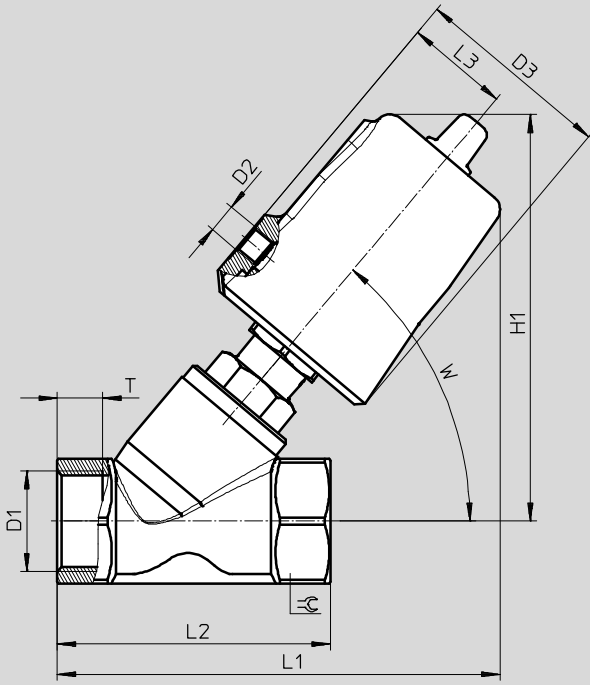

	D1	D2	D3 ∅	H1	L1	L2	L3	T	W	⊙
VZXF-L-...-N12-...-V4B2T-50-...	NPT1/2	G1/8	62	128	133	65	34	12	50°	27
VZXF-L-...-N34-...-V4B2T-50-...	NPT3/4			128	136.5	75		13		32
VZXF-L-...-N1-...-V4B2T-50-...	NPT1			133	145	90		15		41
VZXF-L-...-N114-...-V4B2T-50-...	NPT1 1/4			150	163.5	110		17		50
VZXF-L-...-N112-...-V4B2T-50-...	NPT1 1/2			153	172	120		19		55
VZXF-L-...-N2-...-V4B2T-50-...	NPT2			167	193	150		21		70

Ordering data – Angle seat valve VZXF

	Process valve connection	Flow rate Kv [m³/h]	Medium pressure [bar]	Corrosion resistance CRC ¹⁾	Product weight [g]	Part No.	Type
	NPT1/2	3.8	0 ... 40	2	1300	3539721	VZXF-L-M22C-M-A-N12-130-M1-V4B2T-50-40
		3.3				3539722	VZXF-L-M22C-M-B-N12-130-M1-V4B2T-50-40
	NPT3/4	7.5	0 ... 20		1400	3539746	VZXF-L-M22C-M-A-N34-180-M1-V4B2T-50-20
		6.5				3539747	VZXF-L-M22C-M-B-N34-180-M1-V4B2T-50-20
	NPT1	12	0 ... 16		1600	3539784	VZXF-L-M22C-M-A-N1-240-M1-V4B2T-50-16
		11				3539785	VZXF-L-M22C-M-B-N1-240-M1-V4B2T-50-10
	NPT1 1/4	18.5	0 ... 9		2200	3539817	VZXF-L-M22C-M-A-N114-310-M1-V4B2T-50-9
		10.7				3539818	VZXF-L-M22C-M-B-N114-310-M1-V4B2T-50-7
	NPT1 1/2	25	0 ... 7		2500	3539928	VZXF-L-M22C-M-A-N112-350-M1-V4B2T-50-7
		17.5				3539929	VZXF-L-M22C-M-B-N112-350-M1-V4B2T-50-6
	NPT2	34.5	0 ... 4		3500	3540143	VZXF-L-M22C-M-A-N2-450-M1-V4B2T-50-4
		19.5				3540144	VZXF-L-M22C-M-B-N2-450-M1-V4B2T-50-3

2) Corrosion resistance class CRC 2 to Festo standard FN 940070

Moderate corrosion stress. Indoor applications in which condensation may occur. External visible parts with primarily decorative requirements for the surface and which are in direct contact with the ambient atmosphere typical for industrial applications.

Product Range and Company Overview

A Complete Suite and Company Overview

Our experienced engineers provide complete support at every stage of your development process, including: conceptualization, analysis, engineering, design, assembly, documentation, validation, and production.



Custom Automation Components
Complete custom engineered solutions



Custom Control Cabinets
Comprehensive engineering support and on-site services

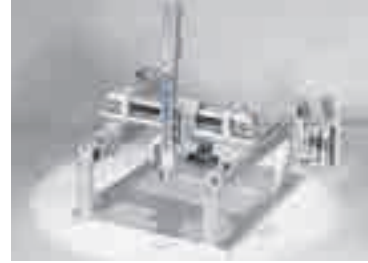

Complete Systems
Shipment, stocking and storage services

The Broadest Range of Automation Components

With a comprehensive line of more than 30,000 automation components, Festo is capable of solving the most complex automation requirements.



Electromechanical
Electromechanical actuators, motors, controllers & drivers



Pneumatics
Pneumatic linear and rotary actuators, valves, and air supply



PLCs and I/O Devices
PLC's, operator interfaces, sensors and I/O devices

Supporting Advanced Automation... As No One Else Can!

Festo is a leading global manufacturer of pneumatic and electromechanical systems, components and controls for industrial automation, with more than 16,000 employees in 60 national headquarters serving more than 180 countries. For more than 80 years, Festo has continuously elevated the state of manufacturing with innovations and optimized motion control solutions that deliver higher performing, more profitable automated manufacturing and processing equipment. Our dedication to the advancement of automation extends beyond technology to the education and development of current and future automation and robotics designers with simulation tools, teaching programs, and on-site services.

Quality Assurance, ISO 9001 and ISO 14001 Certifications

Festo Corporation is committed to supply all Festo products and services that will meet or exceed our customers' requirements in product quality, delivery, customer service and satisfaction.

To meet this commitment, we strive to ensure a consistent, integrated, and systematic approach to management that will meet or exceed the requirements of the ISO 9001 standard for Quality Management and the ISO 14001 standard for Environmental Management.



© Copyright 2013, Festo Corporation. While every effort is made to ensure that all dimensions and specifications are correct, Festo cannot guarantee that publications are completely free of any error, in particular typing or printing errors. Accordingly, Festo cannot be held responsible for the same. For Liability and Warranty conditions, refer to our "Terms and Conditions of Sale", available from your local Festo office. All rights reserved. No part of this publication may be reproduced, distributed, or transmitted in any form or by any means, electronic, mechanical, photocopying or otherwise, without the prior written permission of Festo. All technical data subject to change according to technical update.



Printed on recycled paper at New Horizon Graphic, Inc., FSC certified as an environmental friendly printing plant.

Festo North America

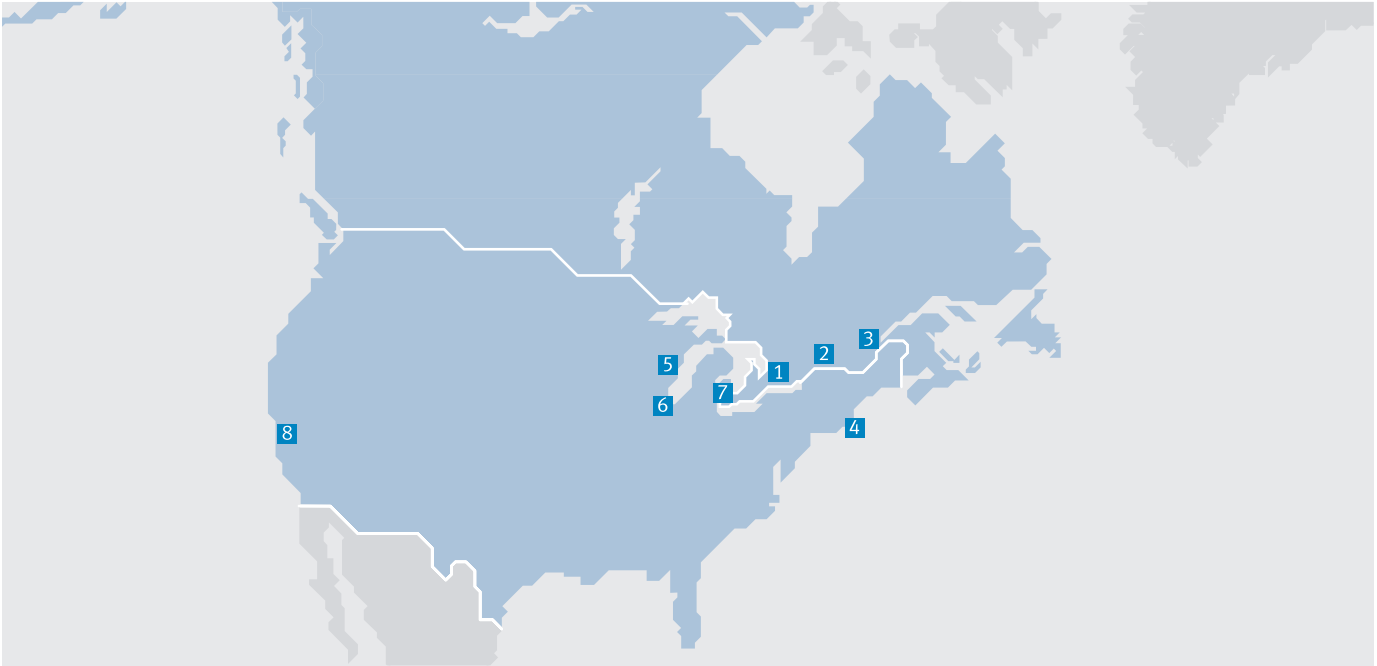

**1 Festo Canada
Headquarters
Festo Inc.**
5300 Explorer Drive
Mississauga, ON
L4W 5G4

2 Montréal
5600, Trans-Canada
Pointe-Claire, QC
H9R 1B6

3 Québec City
2930, rue Watt#117
Québec, QC
G1X 4G3



**4 Festo United States
Headquarters
Festo Corporation**
395 Moreland Road
Hauppauge, NY
11788

5 Appleton
North 922 Tower View Drive, Suite N
Greenville, WI
54942

7 Detroit
1441 West Long Lake Road
Troy, MI
48098

6 Chicago
85 W Algonquin - Suite 340
Arlington Heights, IL
60005

8 Silicon Valley
4935 Southfront Road, Suite F
Livermore, CA
94550

Festo Regional Contact Center

Canadian Customers

Commercial Support:
Tel: 1 877 GO FESTO (1 877 463 3786)
Fax: 1 877 FX FESTO (1 877 393 3786)
Email: festo.canada@ca.festo.com

Technical Support:
Tel: 1 866 GO FESTO (1 866 463 3786)
Fax: 1 877 FX FESTO (1 877 393 3786)
Email: technical.support@ca.festo.com

USA Customers

Commercial Support:
Tel: 1 800 99 FESTO (1 800 993 3786)
Fax: 1 800 96 FESTO (1 800 963 3786)
Email: customer.service@us.festo.com

Technical Support:
Tel: 1 866 GO FESTO (1 866 463 3786)
Fax: 1 800 96 FESTO (1 800 963 3786)
Email: product.support@us.festo.com