

Ball valve actuator units VZBA



Ball valve actuator units VZBA

Key features and product range overview



General	Design	Properties
<ul style="list-style-type: none"> Connecting thread Rp$\frac{1}{4}$... Rp4 Flow rate 7 ... 1,414 m³/h 	<ul style="list-style-type: none"> 2-way ball valve actuator units made from stainless steel with pipe thread¹⁾ or with weld-on ends 2-way ball valve actuator units made from stainless steel in compact design 3-way ball valve actuator units made from stainless steel Port pattern to NAMUR VDI/VDE 3845 	<ul style="list-style-type: none"> Combination of a pneumatic quarter turn actuator and a ball valve Flow is fully opened or closed in both directions Limit switch attachments for end-position sensing can be mounted directly on the unit

Valves with port pattern to NAMUR
→ Internet: namur

Limit switch attachments with port pattern to NAMUR
→ Internet: dapz

Design	Type	Quarter turn actuator	Nominal size DN	Process valve nominal pressure	→ Page/Internet
2-way ball valve actuator units, stainless steel					
	VZBA...-WW (with weld-on ends)	DAPS, double-acting	8 ... 100	PN 63	6
	VZBA...-WW (with weld-on ends)	DAPS, single-acting			
	VZBA...-GG (with connecting thread ¹⁾)	DAPS, double-acting			
	VZBA...-GG (with connecting thread ¹⁾)	DAPS, single-acting			
2-way ball valve actuator units in compact design, stainless steel					
	VZBC...-FF	DAPS, double-acting	15 ... 50	PN 40	14
			65 ... 100	PN 16	
	VZBC...-FF	DAPS, single-acting	15 ... 50	PN 40	
			65 ... 100	PN 16	
3-way ball valve actuator units, with L or T-shaped hole, stainless steel					
	VZBA...-GGG	DAPS, double-acting	8 ... 50	PN 63	20
	VZBA...-GGG	DAPS, single-acting			

1) Pipe thread to DIN EN 10226-1 (previously DIN 2999)

Ball valve actuator units VZBA

Peripherals overview

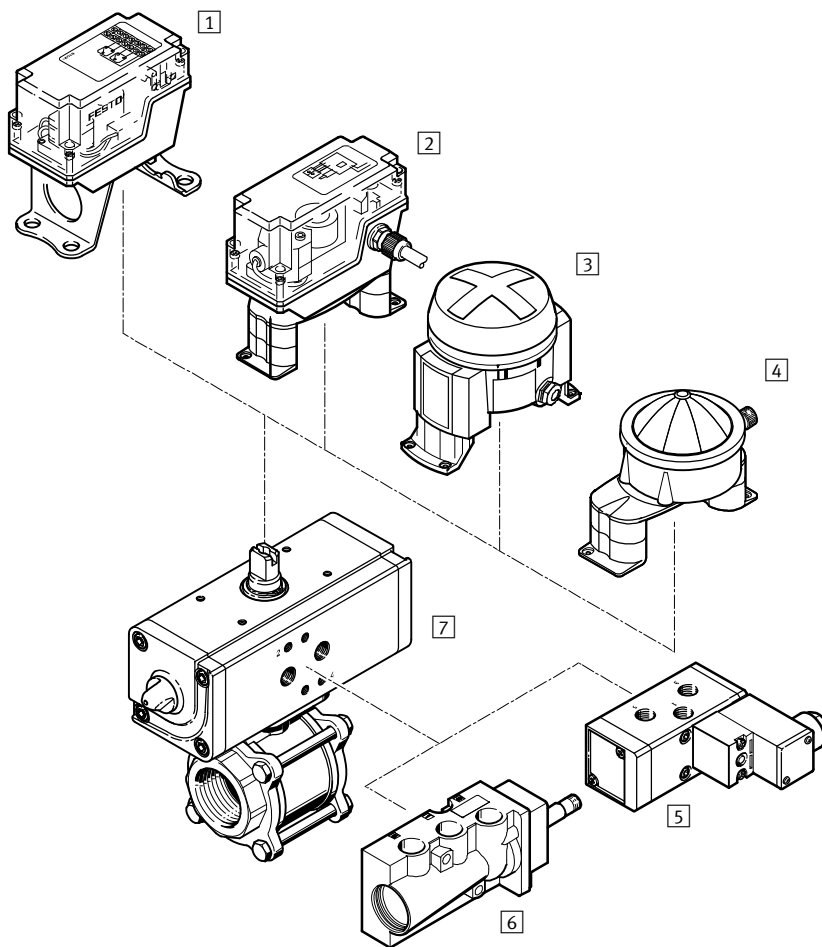

Mounting attachments and accessories			
	Brief description	→ Page/Internet	
1	Limit switch attachment QH-DR-E	Square design Pneumatic, electrical or inductive sensing	4481
2	Limit switch attachment DAPZ	Square design Electrical, electrical and explosion-proof or inductive sensing	4481
3	Limit switch attachment DAPZ	Round design, variant AR Electrical, inductive or inductive and explosion-proof sensing	25
4	Limit switch attachment DAPZ	Round design, variant RO	25
5	Solenoid valve MFH	Basic valve with pilot control valve for F solenoid coil	4482
	Solenoid valve MN1H	Basic valve with pilot control valve for N1 solenoid coil	4482
	Solenoid valve MGTBH	Basic valve with pilot control valve, solenoid coil and socket	4482
6	Solenoid valve NVF3	For F solenoid coil and explosion-proof F solenoid coil	4482
7	Ball valve actuator unit VZBA	Combination of quarter turn actuator and ball valve	6

Ball valve actuator units VZBA

Type codes

FESTO

VZBA - 1/4 - G G - 63 - T - 22 - F0304 -

Type	
VZBA	Ball valve

Size (nominal diameter DN)	
1/4	DN8
3/8	DN10
1/2	DN15
3/4	DN20
1	DN25
1 1/4	DN32
1 1/2	DN40
2	DN50
2 1/2	DN65
3	DN80
4	DN100

Connection type 1	
G	Pipe thread to DIN EN 10226-1 (previously DIN 2999)
W	Weld-on end

Connection type 2	
G	Pipe thread to DIN EN 10226-1 (previously DIN 2999)
W	Weld-on end

Process valve nominal pressure PN	
63	63 bar

Design	
T	In three pieces

Directional control function	
22	2/2-way

Flanged connection to ISO 5211	
F0304	2 pitch circle diameters of \varnothing 36 mm and \varnothing 42 mm
F0405	2 pitch circle diameters of \varnothing 42 mm and \varnothing 50 mm
F0507	2 pitch circle diameters of \varnothing 50 mm and \varnothing 70 mm
F07	1 pitch circle diameter of \varnothing 70 mm
F0710	2 pitch circle diameters of \varnothing 70 mm and \varnothing 102 mm
F10	1 pitch circle diameter of \varnothing 102 mm

Ball valve actuator units VZBA

Type codes

V4 V4 T - PS 15 - R - 90 - 4 - C

Housing material

V4	Stainless steel 1.4401/1.4404 (AISI 316L)/1.4408
----	---

Shut-off element material

V4	Stainless steel 1.4401/1.4404 (AISI 316L)/1.4408
----	---

Sealing material

T	Reinforced PTFE
---	-----------------

Actuator

PP	DAPS, double-acting
PS	DAPS, single-acting

Torque

15	15 Nm
30	30 Nm
53	53 Nm
60	60 Nm
90	90 Nm
106	106 Nm
120	120 Nm
180	180 Nm
240	240 Nm

Swivel direction

R	Right
---	-------

Nominal swivel angle

90	90°
----	-----

Spring index

-	Omitted for double-acting
1	Spring strength for connection pressure 2.8 bar
2	Spring strength for connection pressure 3.5 bar
3	Spring strength for connection pressure 4.2 bar
4	Spring strength for connection pressure 5.6 bar

End-position adjustment



C	Closed
---	--------

Ball valve actuator units VZBA, 2-way

Technical data

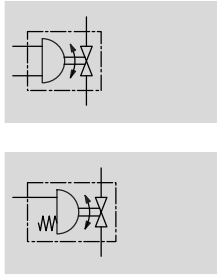
Function



-  Swivel angle
0 ... 90°
-  Flow rate
7 ... 1,414 m³/h
-  Connecting thread
Rp¹/₄ ... Rp₄



General technical data												
Nominal size DN	8	10	15	20	25	32	40	50	65	80	100	
Quarter turn actuator												
Type of mounting	In-line installation											
Mounting position	Any											
Swivel angle	[°]	90										
Closing direction	Right-closing											
Ball valve												
Design	2-way ball valve, quarter turn actuator											
Actuation type	Pneumatic											
Switching position display	Slot direction = flow direction											
Process valve nominal pressure PN ¹⁾	63											
Flow rate Kv	[m ³ /h]	7	10	19.4	45.6	71.5	105	170	275	507	905	1,414

Operating and environmental conditions	
Operating medium	Compressed air to ISO 8573-1:2010 [7:4:4]
Operating pressure	[bar] 6 ... 8.4
Ambient temperature	[°C] -10 ... +80
Temperature of medium ²⁾	[°C] -10 ... +200
Food industry approval	No
Medium	Compressed air to ISO 8573-1:2010 [:-:-] Inert gases Neutral fluids Water (no water vapour)
Note on operating/pilot medium	Lubricated operation possible (in which case lubricated operation will always be required)
Note on materials	Contains PWIS (paint-wetting impairment substances), RoHS-compliant
Corrosion resistance class CRC ³⁾	3

1) PN class to DIN EN 1333

2) As a function of operating pressure → 7

3) CRC3: Corrosion resistance class to Festo standard 940 070

Components with heavy corrosion exposure. Externally visible components in direct contact with normal industrial atmosphere or media such as solvents and cleaning agents, where the surface requirement is predominantly functional.

Ball valve actuator units VZBA, 2-way

Technical data

ATEX	
ATEX category for gas	II 2G
ATEX category for dust	II 2D
Max. surface temperature assembly	TX
Explosion group assembly	II C
Explosion-proof temperature rating	-10°C ≤ Ta ≤ +60°C

Materials	Information on materials	Material number
Housing	High-alloy stainless steel	1.4408
Ball		
Shaft	High-alloy stainless steel	1.4401
Seals	PTFE reinforced, PTFE	
Note on materials	RoHS-compliant, contains paint-wetting impairment substances	

Weight [g] – Double-acting			
Nominal size DN	Process valve connection		
8	Rp1/4	Weld-on ends	1,450
10	Rp3/8		1,450
15	Rp1/2		1,450
20	Rp3/4		1,900
25	Rp1		2,300
32	Rp1 1/4		3,800

Nominal size DN	Process valve connection		
40	Rp1 1/2	Weld-on ends	4,800
50	Rp2		6,600
65	Rp2 1/2		11,700
80	Rp3		18,200
100	Rp4		27,700

Weight [g] – Single-acting			
Nominal size DN	Process valve connection		
8	Rp1/4	Weld-on ends	2,000
10	Rp3/8		2,000
15	Rp1/2		2,000
20	Rp3/4		3,100
25	Rp1		3,500
32	Rp1 1/4		5,150

Nominal size DN	Process valve connection		
40	Rp1 1/2	Weld-on ends	6,100
50	Rp2		10,000
65	Rp2 1/2		16,300
80	Rp3		22,900
100	Rp4		33,500

The permissible medium pressure sinks as a function of the temperature of the medium

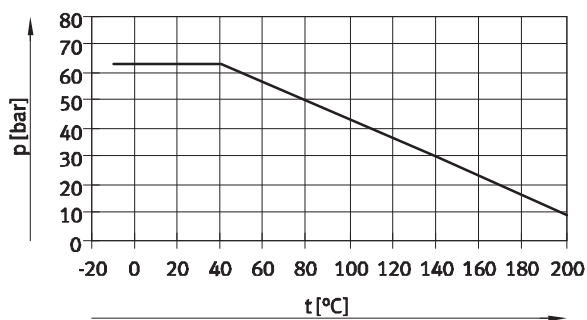

Ball valve actuator units VZBA, 2-way

Technical data

FESTO

Dimensions

Download CAD data → www.festo.com

DAPS – Double-acting

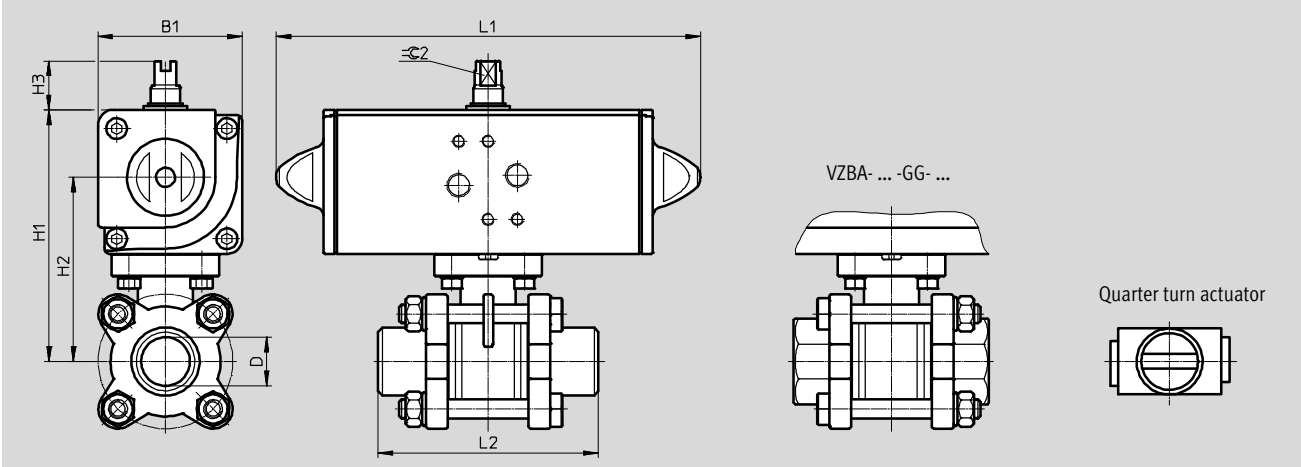

Type	B1	D ∅	H1	H2	H3	L1	L2	∠ 2
VZBA-1/4"-WW-63-T-22-F0304-V4V4T-PP15-R-90-C	52.2	10	92.2	68	20	159	70	8
VZBA-3/8"-WW-63-T-22-F0304-V4V4T-PP15-R-90-C	52.2	12	92.2	68	20	159	70	8
VZBA-1/2"-WW-63-T-22-F0304-V4V4T-PP15-R-90-C	52.2	16	92.2	68	20	159	75	8
VZBA-3/4"-WW-63-T-22-F0304-V4V4T-PP30-R-90-C	59.2	20	103.2	75.5	20	174	90	9
VZBA-1"-WW-63-T-22-F0405-V4V4T-PP30-R-90-C	59.2	25	111.2	83.5	20	174	100	9
VZBA-1 1/4"-WW-63-T-22-F0405-V4V4T-PP60-R-90-C	70.4	32	128.4	95.7	20	198	110	10
VZBA-1 1/2"-WW-63-T-22-F0507-V4V4T-PP60-R-90-C	70.4	38	138.4	105.7	20	198	125	10
VZBA-2"-WW-63-T-22-F0507-V4V4T-PP60-R-90-C	70.4	50	147.7	114.7	20	198	150	10
VZBA-2 1/2"-WW-63-T-22-F0710-V4V4T-PP106-R-90-C	83.3	65	181.3	142.8	20	237.1	190	12
VZBA-3"-WW-63-T-22-F0710-V4V4T-PP180-R-90-C	107.5	80	217.5	166.5	30	289.9	220	15
VZBA-4"-WW-63-T-22-F10-V4V4T-PP240-R-90-C	111.1	100	249.1	198.1	30	313.6	270	15

Type	B1	D ∅	H1	H2	H3	L1	L2	∠ 2
VZBA-1/4"-GG-63-T-22-F0304-V4V4T-PP15-R-90-C	52.2	10	99.2	68	20	159	65	8
VZBA-3/8"-GG-63-T-22-F0304-V4V4T-PP15-R-90-C	52.2	12	99.2	68	20	159	65	8
VZBA-1/2"-GG-63-T-22-F0304-V4V4T-PP15-R-90-C	52.2	16	99.2	68	20	159	75	8
VZBA-3/4"-GG-63-T-22-F0304-V4V4T-PP30-R-90-C	59.2	20	103.2	75.5	20	174	80	9
VZBA-1"-GG-63-T-22-F0405-V4V4T-PP30-R-90-C	59.2	25	111.2	83.5	20	174	90	9
VZBA-1 1/4"-GG-63-T-22-F0405-V4V4T-PP60-R-90-C	70.4	32	128.4	95.7	20	198	110	10
VZBA-1 1/2"-GG-63-T-22-F0507-V4V4T-PP60-R-90-C	70.4	38	138.4	105.7	20	198	120	10
VZBA-2"-GG-63-T-22-F0507-V4V4T-PP60-R-90-C	70.4	50	147.7	114.7	20	198	140	10
VZBA-2 1/2"-GG-63-T-22-F0710-V4V4T-PP106-R-90-C	83.3	65	181.3	142.8	20	237.1	185	12
VZBA-3"-GG-63-T-22-F0710-V4V4T-PP180-R-90-C	107.5	80	217.5	166.5	30	289.9	205	15
VZBA-4"-GG-63-T-22-F10-V4V4T-PP240-R-90-C	111.1	100	249.1	198.1	30	313.6	240	15

Ball valve actuator units VZBA, 2-way

Technical data

FESTO

Dimensions

Download CAD data → www.festo.com

DAPS – Single-acting

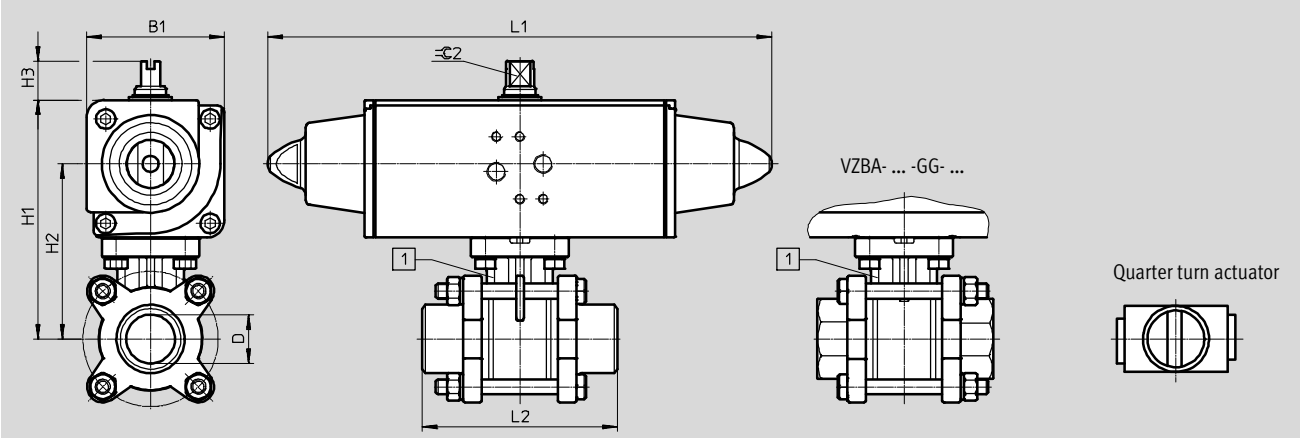

Type	B1	D ∅	H1	H2	H3	L1	L2	∅ 2
VZBA-1/4"-WW-63-T-22-F0304-V4V4T-PS15-R-90-4-C	59.2	10	99.2	71.5	20	233.3	70	9
VZBA-3/8"-WW-63-T-22-F0304-V4V4T-PS15-R-90-4-C	59.2	12	99.2	71.5	20	233.3	70	9
VZBA-1/2"-WW-63-T-22-F0304-V4V4T-PS15-R-90-4-C	59.2	16	99.2	71.5	20	233.3	75	9
VZBA-3/4"-WW-63-T-22-F0304-V4V4T-PS30-R-90-4-C	70.4	20	114.4	81.7	20	259	90	10
VZBA-1"-WW-63-T-22-F0405-V4V4T-PS30-R-90-4-C	70.4	25	122.4	89.7	20	259	100	10
VZBA-1 1/4"-WW-63-T-22-F0405-V4V4T-PS53-R-90-4-C	83.3	32	141.3	102.8	20	304.3	110	12
VZBA-1 1/2"-WW-63-T-22-F0507-V4V4T-PS53-R-90-4-C	83.3	38	151.3	112.8	20	304.3	125	12
VZBA-2"-WW-63-T-22-F0507-V4V4T-PS90-R-90-4-C	107.5	50	184.5	133.5	30	393.7	150	15
VZBA-2 1/2"-WW-63-T-22-F0710-V4V4T-PS120-R-90-4-C	111.1	65	209.1	158.1	30	409.6	190	15
VZBA-3"-WW-63-T-22-F0710-V4V4T-PS180-R-90-4-C	118	80	228	172	30	474	220	19
VZBA-4"-WW-63-T-22-F10-V4V4T-PS240-R-90-4-C	134.9	100	272.9	210.9	30	520.5	270	19

Type	B1	D ∅	H1	H2	H3	L1	L2	∅ 2
VZBA-1/4"-GG-63-T-22-F0304-V4V4T-PS15-R-90-4-C	59.2	10	99.2	71.5	20	233.3	65	9
VZBA-3/8"-GG-63-T-22-F0304-V4V4T-PS15-R-90-4-C	59.2	12	99.2	71.5	20	233.3	65	9
VZBA-1/2"-GG-63-T-22-F0304-V4V4T-PS15-R-90-4-C	59.2	16	99.2	71.5	20	233.3	75	9
VZBA-3/4"-GG-63-T-22-F0304-V4V4T-PS30-R-90-4-C	70.4	20	114.4	81.7	20	259	80	10
VZBA-1"-GG-63-T-22-F0405-V4V4T-PS30-R-90-4-C	70.4	25	122.4	89.7	20	259	90	10
VZBA-1 1/4"-GG-63-T-22-F0405-V4V4T-PS53-R-90-4-C	83.3	32	141.3	102.8	20	304.3	110	12
VZBA-1 1/2"-GG-63-T-22-F0507-V4V4T-PS53-R-90-4-C	83.3	38	151.3	112.8	20	304.3	120	12
VZBA-2"-GG-63-T-22-F0507-V4V4T-PS90-R-90-4-C	107.5	50	184.5	133.5	30	393.7	140	15
VZBA-2 1/2"-GG-63-T-22-F0710-V4V4T-PS120-R-90-4-C	111.1	65	209.1	158.1	30	409.6	185	15
VZBA-3"-GG-63-T-22-F0710-V4V4T-PS180-R-90-4-C	118	80	228	172	30	474	205	19
VZBA-4"-GG-63-T-22-F10-V4V4T-PS240-R-90-4-C	134.9	100	272.9	210.9	30	520.5	240	19

Ball valve actuator units VZBA, 2-way

Technical data

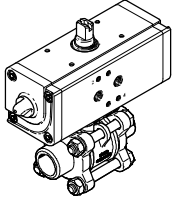
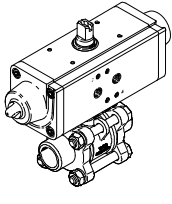
Ordering data – Ball valve actuator units with weld-on ends			
DAPS – Double-acting	Connection	Part No.	Type
	With weld-on ends	1810730	VZBA-1/4"-WW-63-T-22-F0304-V4V4T-PP15-R-90-C
		1810731	VZBA-3/8"-WW-63-T-22-F0304-V4V4T-PP15-R-90-C
		1810732	VZBA-1/2"-WW-63-T-22-F0304-V4V4T-PP15-R-90-C
		1810733	VZBA-3/4"-WW-63-T-22-F0304-V4V4T-PP30-R-90-C
		1810734	VZBA-1"-WW-63-T-22-F0405-V4V4T-PP30-R-90-C
		1810735	VZBA-1 1/4"-WW-63-T-22-F0405-V4V4T-PP60-R-90-C
		1810736	VZBA-1 1/2"-WW-63-T-22-F0507-V4V4T-PP60-R-90-C
		1810737	VZBA-2"-WW-63-T-22-F0507-V4V4T-PP60-R-90-C
		1810738	VZBA-2 1/2"-WW-63-T-22-F0710-V4V4T-PP106-R-90-C
		1810739	VZBA-3"-WW-63-T-22-F0710-V4V4T-PP180-R-90-C
		1810740	VZBA-4"-WW-63-T-22-F10-V4V4T-PP240-R-90-C
DAPS – Single-acting			
	With weld-on ends	1774103	VZBA-1/4"-WW-63-T-22-F0304-V4V4T-PS15-R-90-4-C
		1774104	VZBA-3/8"-WW-63-T-22-F0304-V4V4T-PS15-R-90-4-C
		1774105	VZBA-1/2"-WW-63-T-22-F0304-V4V4T-PS15-R-90-4-C
		1774106	VZBA-3/4"-WW-63-T-22-F0304-V4V4T-PS30-R-90-4-C
		1774107	VZBA-1"-WW-63-T-22-F0405-V4V4T-PS30-R-90-4-C
		1774108	VZBA-1 1/4"-WW-63-T-22-F0405-V4V4T-PS60-R-90-4-C
		1774109	VZBA-1 1/2"-WW-63-T-22-F0507-V4V4T-PS60-R-90-4-C
		1774110	VZBA-2"-WW-63-T-22-F0507-V4V4T-PS60-R-90-4-C
		1774111	VZBA-2 1/2"-WW-63-T-22-F0710-V4V4T-PS106-R-90-4-C
		1774112	VZBA-3"-WW-63-T-22-F0710-V4V4T-PS180-R-90-4-C
		1774113	VZBA-4"-WW-63-T-22-F10-V4V4T-PS240-R-90-4-C

Ball valve actuator units VZBA, 2-way

Technical data

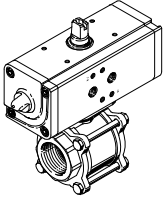
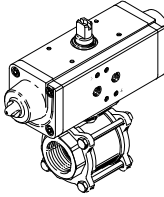
Ordering data – Ball valve actuator units with connecting thread			
DAPS – Double-acting	Connecting thread	Part No.	Type
	Rp $\frac{1}{4}$	1809651	VZBA-1/4"-GG-63-T-22-F0304-V4V4T-PP15-R-90-C
	Rp $\frac{3}{8}$	1809652	VZBA-3/8"-GG-63-T-22-F0304-V4V4T-PP15-R-90-C
	Rp $\frac{1}{2}$	1809653	VZBA-1/2"-GG-63-T-22-F0304-V4V4T-PP15-R-90-C
	Rp $\frac{3}{4}$	1809654	VZBA-3/4"-GG-63-T-22-F0304-V4V4T-PP30-R-90-C
	Rp1	1809655	VZBA-1"-GG-63-T-22-F0405-V4V4T-PP30-R-90-C
	Rp1 $\frac{1}{4}$	1809656	VZBA-1 1/4"-GG-63-T-22-F0405-V4V4T-PP60-R-90-C
	Rp1 $\frac{1}{2}$	1809657	VZBA-1 1/2"-GG-63-T-22-F0507-V4V4T-PP60-R-90-C
	Rp2	1809658	VZBA-2"-GG-63-T-22-F0507-V4V4T-PP60-R-90-C
	Rp2 $\frac{1}{2}$	1809659	VZBA-2 1/2"-GG-63-T-22-F0710-V4V4T-PP106-R-90-C
	Rp3	1809660	VZBA-3"-GG-63-T-22-F0710-V4V4T-PP180-R-90-C
	Rp4	1809661	VZBA-4"-GG-63-T-22-F10-V4V4T-PP240-R-90-C
DAPS – Single-acting			
	Rp $\frac{1}{4}$	1758069	VZBA-1/4"-GG-63-T-22-F0304-V4V4T-PS15-R-90-4-C
	Rp $\frac{3}{8}$	1758070	VZBA-3/8"-GG-63-T-22-F0304-V4V4T-PS15-R-90-4-C
	Rp $\frac{1}{2}$	1758071	VZBA-1/2"-GG-63-T-22-F0304-V4V4T-PS15-R-90-4-C
	Rp $\frac{3}{4}$	1758072	VZBA-3/4"-GG-63-T-22-F0304-V4V4T-PS30-R-90-4-C
	Rp1	1758073	VZBA-1"-GG-63-T-22-F0405-V4V4T-PS30-R-90-4-C
	Rp1 $\frac{1}{4}$	1758074	VZBA-1 1/4"-GG-63-T-22-F0405-V4V4T-PS53-R-90-4-C
	Rp1 $\frac{1}{2}$	1758075	VZBA-1 1/2"-GG-63-T-22-F0507-V4V4T-PS53-R-90-4-C
	Rp2	1758076	VZBA-2"-GG-63-T-22-F0507-V4V4T-PS90-R-90-4-C
	Rp2 $\frac{1}{2}$	1758077	VZBA-2 1/2"-GG-63-T-22-F0710-V4V4T-PS120-R-90-4-C
	Rp3	1758078	VZBA-3"-GG-63-T-22-F0710-V4V4T-PS180-R-90-4-C
	Rp4	1758079	VZBA-4"-GG-63-T-22-F10-V4V4T-PS240-R-90-4-C

Ball valve actuator units VZBC, 2-way, compact design

Type codes

VZBC - 15 - F F - 40 - 22 - F0304 - V4 V4 T -

Type

VZBC	Ball valve
------	------------

Size (nominal diameter DN)

15	DN15
20	DN20
25	DN25
32	DN32
40	DN40
50	DN50
65	DN65
80	DN80
100	DN100

Connection type 1

F	Flange to DIN EN 1092-1
---	-------------------------

Connection type 2

F	Flange to DIN EN 1092-1
---	-------------------------

Process valve nominal pressure PN

40	40 bar
16	16 bar

Directional control function

22	2/2-way
----	---------

Flanged connection to ISO 5211

F0304	2 pitch circle diameters of \varnothing 36 mm and \varnothing 42 mm
F0405	2 pitch circle diameters of \varnothing 42 mm and \varnothing 50 mm
F0507	2 pitch circle diameters of \varnothing 50 mm and \varnothing 70 mm
F07	1 pitch circle diameter of \varnothing 70 mm
F0710	2 pitch circle diameters of \varnothing 70 mm and \varnothing 102 mm

Housing material

V4	Stainless steel 1.4401/1.4404 (AISI 316L)/1.4408
----	--

Shut-off element material

V4	Stainless steel 1.4401/1.4404 (AISI 316L)/1.4408
----	--

Sealing material

T	Reinforced PTFE
---	-----------------

Ball valve actuator units VZBC, 2-way, compact design

Type codes

		PS	15	-	R	-	90	-	4	-	C
Actuator											
PP	DAPS, double-acting										
PS	DAPS, single-acting										
Torque											
15	15 Nm										
30	30 Nm										
53	53 Nm										
60	60 Nm										
90	90 Nm										
106	106 Nm										
120	120 Nm										
180	180 Nm										
240	240 Nm										
Swivel direction											
R	Right										
Nominal swivel angle											
90	90°										
Spring index											
-	Omitted for double-acting										
1	Spring strength for connection pressure 2.8 bar										
2	Spring strength for connection pressure 3.5 bar										
3	Spring strength for connection pressure 4.2 bar										
4	Spring strength for connection pressure 5.6 bar										
End-position adjustment											
C	Closed										



Ball valve actuator units VZBC, 2-way, compact design

FESTO

Technical data

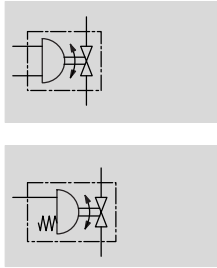
Function



-  Swivel angle
0 ... 90°
-  Flow rate
19.4 ... 1,414 m³/h
-  Connecting thread
Rp1/2 ... Rp4



General technical data									
Nominal size DN	15	20	25	32	40	50	65	80	100
Quarter turn actuator									
Type of mounting	In-line installation								
Mounting position	Any								
Swivel angle [°]	90								
Closing direction	Right-closing								
Ball valve									
Design	2-way ball valve								
Actuation type	Pneumatic								
Switching position display	Slot direction = flow direction								
Type of mounting	In-line installation								
Process valve nominal pressure PN ¹⁾	40						16		
Flow rate Kv [m ³ /h]	19.4	45.6	71.5	105	170	275	507	905	1,414

Operating and environmental conditions	
Operating medium	Compressed air to ISO 8573-1:2010 [7:4:4]
Operating pressure [bar]	6 ... 8.4
Ambient temperature [°C]	-10 ... +80
Temperature of medium ²⁾ [°C]	-10 ... +200
Food industry approval	No
Medium	Compressed air to ISO 8573-1:2010 [:-:-] Inert gases Neutral liquids Water (no water vapour)
Note on operating/pilot medium	Lubricated operation possible (in which case lubricated operation will always be required)
Note on materials	Contains PWIS (paint-wetting impairment substances), RoHS-compliant
Corrosion resistance class CRC ³⁾	3

1) PN class to DIN EN 1333

2) As a function of operating pressure → 15

3) CRC3: Corrosion resistance class to Festo standard 940 070

Components with heavy corrosion exposure. Externally visible components in direct contact with normal industrial atmosphere or media such as solvents and cleaning agents, where the surface requirement is predominantly functional.

ATEX	
ATEX category for gas	II 2G
ATEX category for dust	II 2D
Max. surface temperature assembly	TX
Explosion group assembly	IIC
Explosion-proof temperature rating	-10°C ≤ Ta ≤ +60°C

Ball valve actuator units VZBC, 2-way, compact design

Technical data

Materials	Information on materials	Material number
Housing	High-alloy stainless steel	1.4408
Ball		
Shaft	High-alloy stainless steel	1.4401
Seals	PTFE reinforced, PTFE	
Note on materials	RoHS-compliant, contains paint-wetting impairment substances	

The permissible medium pressure sinks as a function of the temperature of the medium

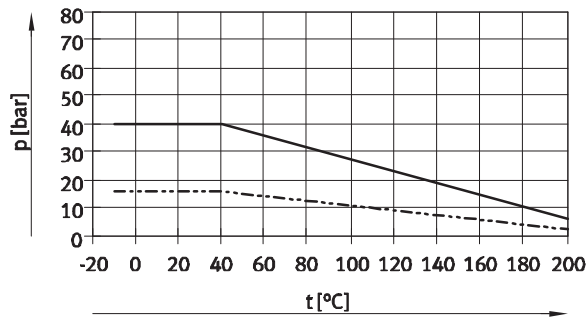

Dimensions

Download CAD data → www.festo.com

DAPS – Double-acting

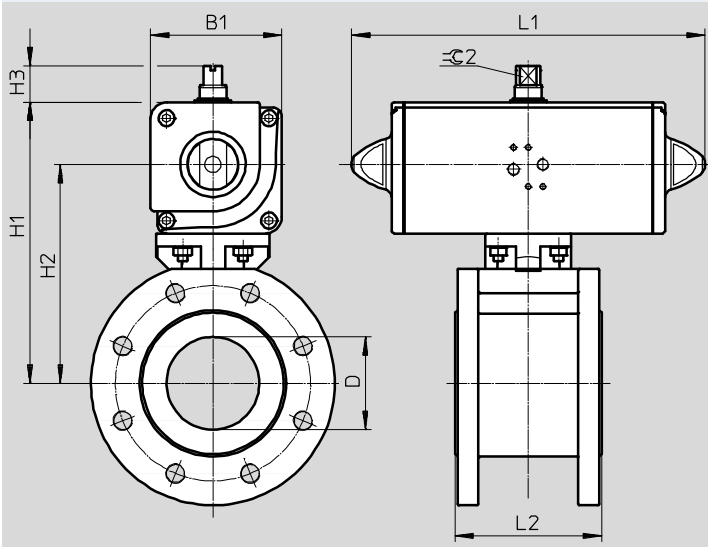

Type	B1	D ∅	H1	H2	H3	L1	L2	±0.2
VZBC-15-FF-40-22-F0304-V4V4T-PP15-R-90-C	52.2	15	112.2	88	20	159	40	8
VZBC-20-FF-40-22-F0304-V4V4T-PP30-R-90-C	59.2	20	123.5	95.8	20	174	44	9
VZBC-25-FF-40-22-F0405-V4V4T-PP30-R-90-C	59.2	25	123.8	96.1	20	174	53	9
VZBC-32-FF-40-22-F0405-V4V4T-PP60-R-90-C	70.4	32	139.4	106.7	20	198	58.4	10
VZBC-40-FF-40-22-F0507-V4V4T-PP60-R-90-C	70.4	38	146.7	114	20	198	62	10
VZBC-50-FF-40-22-F0507-V4V4T-PP106-R-90-C	83.3	50	168.8	130.3	20	237.1	78	12
VZBC-65-FF-16-22-F07-V4V4T-PP180-R-90-C	107.5	64	212.5	161.5	30	289.9	100	15
VZBC-80-FF-16-22-F07-V4V4T-PP180-R-90-C	107.5	76	229.5	178.5	30	289.9	120	15
VZBC-100-FF-16-22-F0710-V4V4T-PP240-R-90-C	111.1	96	243.1	192.1	30	313.6	152	15

Ball valve actuator units VZBC, 2-way, compact design

Technical data

Dimensions Download CAD data → www.festo.com

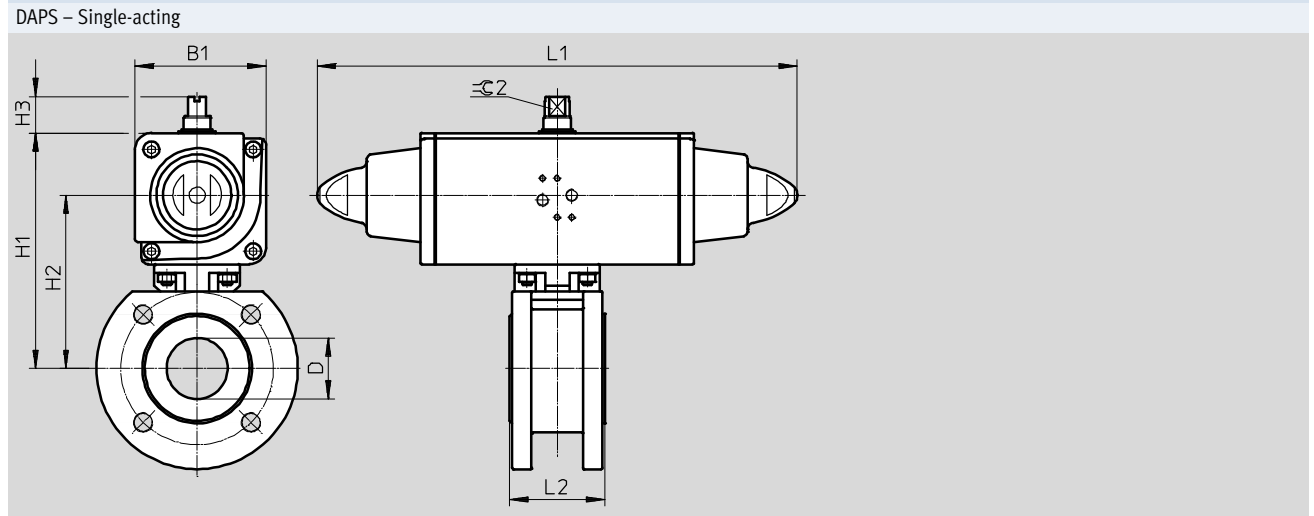

Type	B1	D Ø	H1	H2	H3	L1	L2	±0.2
VZBC-15-FF-40-22-F0304-V4V4T-PS15-R-90-4-C	59.2	15	119.2	91.5	20	233.3	40	9
VZBC-20-FF-40-22-F0304-V4V4T-PS30-R-90-4-C	70.4	20	134.7	102	20	259	44	10
VZBC-25-FF-40-22-F0405-V4V4T-PS30-R-90-4-C	70.4	25	135	102.3	20	259	53	10
VZBC-32-FF-40-22-F0405-V4V4T-PS53-R-90-4-C	83.3	32	152.3	113.8	20	304.3	58.4	12
VZBC-40-FF-40-22-F0507-V4V4T-PS53-R-90-4-C	83.3	38	159.6	121.1	20	304.3	62	12
VZBC-50-FF-40-22-F0507-V4V4T-PS90-R-90-4-C	107.5	50	193	142	30	393.7	78	15
VZBC-65-FF-16-22-F07-V4V4T-PS180-R-90-4-C	118	64	223	167	30	474	100	19
VZBC-80-FF-16-22-F07-V4V4T-PS180-R-90-4-C	118	76	241	185	30	474	120	19
VZBC-100-FF-16-22-F0710-V4V4T-PS240-R-90-4-C	134.9	96	266.9	204.9	30	520.5	152	19

Ball valve actuator units VZBC, 2-way, compact design

Technical data

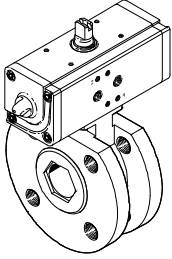
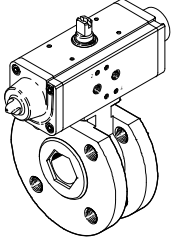
Ordering data – Ball valve actuator units in compact design made from stainless steel				
DAPS – Double-acting	Process valve connection	Weight [g]	Part No.	Type
	Ring housing with threaded flange	2,300	1913365	VZBC-15-FF-40-22-F0304-V4V4T-PP15-R-90-C
		3,200	1913367	VZBC-20-FF-40-22-F0304-V4V4T-PP30-R-90-C
		3,700	1913368	VZBC-25-FF-40-22-F0405-V4V4T-PP30-R-90-C
		5,700	1913369	VZBC-32-FF-40-22-F0405-V4V4T-PP60-R-90-C
		6,400	1913370	VZBC-40-FF-40-22-F0507-V4V4T-PP60-R-90-C
		8,600	1913371	VZBC-50-FF-40-22-F0507-V4V4T-PP106-R-90-C
		14,300	1913372	VZBC-65-FF-16-22-F07-V4V4T-PP180-R-90-C
		18,700	1913373	VZBC-80-FF-16-22-F07-V4V4T-PP180-R-90-C
		26,000	1913374	VZBC-100-FF-16-22-F0710-V4V4T-PP240-R-90-C
DAPS – Single-acting	Process valve connection	Weight [g]	Part No.	Type
	Ring housing with threaded flange	2,850	1915401	VZBC-15-FF-40-22-F0304-V4V4T-PS15-R-90-4-C
		4,350	1915402	VZBC-20-FF-40-22-F0304-V4V4T-PS30-R-90-4-C
		4,850	1915403	VZBC-25-FF-40-22-F0405-V4V4T-PS30-R-90-4-C
		7,000	1915404	VZBC-32-FF-40-22-F0405-V4V4T-PS53-R-90-4-C
		7,700	1915406	VZBC-40-FF-40-22-F0507-V4V4T-PS53-R-90-4-C
		11,800	1915407	VZBC-50-FF-40-22-F0507-V4V4T-PS90-R-90-4-C
		18,900	1915408	VZBC-65-FF-16-22-F07-V4V4T-PS180-R-90-4-C
		23,300	1915409	VZBC-80-FF-16-22-F07-V4V4T-PS180-R-90-4-C
		31,900	1915410	VZBC-100-FF-16-22-F0710-V4V4T-PS240-R-90-4-C

Ball valve actuator units VZBA, 3-way

Type codes

FESTO

VZBA - 2 - G G G - 63 - 32L - F0507 -

Type	
VZBA	Ball valve

Size (nominal diameter DN)	
1/4	DN8
3/8	DN10
1/2	DN15
3/4	DN20
1	DN25
1 1/4	DN32
1 1/2	DN40
2	DN50

Connection type 1	
G	Pipe thread to DIN EN 10226-1 (previously DIN 2999)

Connection type 2	
G	Pipe thread to DIN EN 10226-1 (previously DIN 2999)

Connection type 3	
G	Pipe thread to DIN EN 10226-1 (previously DIN 2999)

Process valve nominal pressure PN	
63	63 bar

Directional control function	
32T	3/2-way, T-shaped hole
32L	3/2-way, L-shaped hole

Flanged connection to ISO 5211	
F0304	2 pitch circle diameters of \varnothing 36 mm and \varnothing 42 mm
F0405	2 pitch circle diameters of \varnothing 42 mm and \varnothing 50 mm
F0507	2 pitch circle diameters of \varnothing 50 mm and \varnothing 70 mm

Ball valve actuator units VZBA, 3-way

Type codes

V4 V4 T - PS 80 - 90 - 5 - C

Housing material

V4	Stainless steel 1.4401/1.4404 (AISI 316L)/1.4408
----	---

Shut-off element material

V4	Stainless steel 1.4401/1.4404 (AISI 316L)/1.4408
----	---

Sealing material

T	Reinforced PTFE
---	-----------------

Actuator

PP	DAPS, double-acting
PS	DAPS, single-acting

Torque

30	30 Nm
53	53 Nm
60	60 Nm
90	90 Nm
106	106 Nm

Nominal swivel angle

90	90°
----	-----

Spring index

-	Omitted for double-acting
3	Spring strength for connection pressure 3 bar
4	Spring strength for connection pressure 4 bar
5	Spring strength for connection pressure 5 bar

End-position adjustment



C	Closed
---	--------

Ball valve actuator units VZBA, 3-way

Technical data

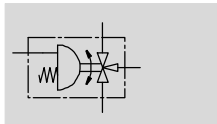
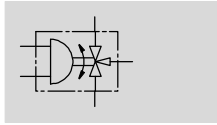
Function



-  Swivel angle
0 ... 90°
-  Flow rate
4.5 ... 100 m³/h
-  Connecting thread
Rp¹/₄ ... Rp₄



General technical data								
Nominal size DN	8	10	15	20	25	32	40	50
Quarter turn actuator								
Type of mounting	In-line installation							
Mounting position	Any							
Swivel angle	[°]	90						
Closing direction	Right-closing							
Ball valve								
Design	3-way ball valve with L-shaped hole, T-shaped hole							
Actuation type	Pneumatic							
Switching position display	Slot direction = flow direction							
Type of mounting	In-line installation							
Process valve nominal pressure PN ¹⁾	63							
Flow rate Kv	[m ³ /h]	→ Page 24						

Operating and environmental conditions	
Operating medium	Compressed air to ISO 8573-1:2010 [7:4:4]
Operating pressure [bar]	6 ... 8.4
Ambient temperature [°C]	-10 ... +80
Temperature of medium ²⁾ [°C]	-10 ... +200
Food industry approval	No
Medium	Compressed air to ISO 8573-1:2010 [:::]
	Inert gases
	Neutral fluids
	Water (no water vapour)
Note on operating/pilot medium	Lubricated operation possible (in which case lubricated operation will always be required)
Note on materials	Contains PWIS (paint-wetting impairment substances), RoHS-compliant
Corrosion resistance class CRC ³⁾	3

1) PN class to DIN EN 1333

2) As a function of operating pressure → 21

3) CRC3: Corrosion resistance class to Festo standard 940 070

Components with heavy corrosion exposure. Externally visible components in direct contact with normal industrial atmosphere or media such as solvents and cleaning agents, where the surface requirement is predominantly functional.

Ball valve actuator units VZBA, 3-way

Technical data

ATEX	
ATEX category for gas	II 2G
ATEX category for dust	II 2D
Max. surface temperature assembly	TX
Explosion group assembly	IIC
Explosion-proof temperature rating	-10°C ≤ Ta ≤ +60°C

Materials	Information on materials	Material number
Housing	High-alloy stainless steel	1.4408
Ball		
Shaft	High-alloy stainless steel	1.4401
Seals	PTFE reinforced, PTFE	
Note on materials	RoHS-compliant, contains paint-wetting impairment substances	

Weight [g]								
Process valve connection	Rp1/4	Rp3/8	Rp1/2	Rp3/4	Rp1	Rp1 1/4	Rp1 1/2	Rp2
Double-acting	1,750	1,750	1,750	2,050	2,650	4,750	5,750	9,800
Single-acting	2,950	2,950	2,950	3,250	3,850	6,070	10,812	12,900

The permissible medium pressure drops as a function of the temperature of the medium

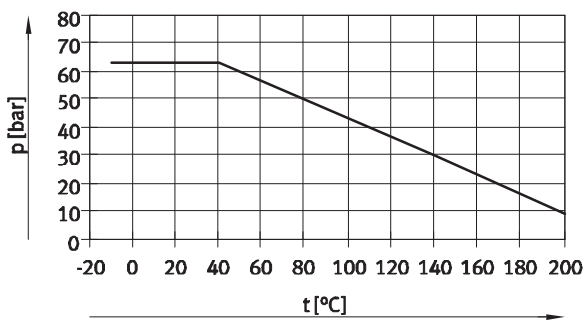

Ball valve actuator units VZBA, 3-way

Technical data

FESTO

Dimensions Download CAD data → www.festo.com

DAPS – Double-acting

L = L-hole
T = T-hole
Quarter turn actuator

1 Delivery condition

Type	B1	D ∅	H1	H2	H3	L1	L2	±0.2
VZBA-1/4"-GGG-63-32L-F0304-V4V4T-PP30-R-90-C	59.2	11.6	95.1	67.4	20	174	80	9
VZBA-1/4"-GGG-63-32T-F0304-V4V4T-PP30-R-90-C	59.2	11.6	95.1	67.4	20	174	80	9
VZBA-3/8"-GGG-63-32L-F0304-V4V4T-PP30-R-90-C	59.2	12.7	95.1	67.4	20	174	80	9
VZBA-3/8"-GGG-63-32T-F0304-V4V4T-PP30-R-90-C	59.2	12.7	95.1	67.4	20	174	80	9
VZBA-1/2"-GGG-63-32L-F0304-V4V4T-PP30-R-90-C	59.2	12.7	95.1	67.4	20	174	80	9
VZBA-1/2"-GGG-63-32T-F0304-V4V4T-PP30-R-90-C	59.2	12.7	95.1	67.4	20	174	80	9
VZBA-3/4"-GGG-63-32L-F0405-V4V4T-PP30-R-90-C	59.2	16	100.1	72.4	20	174	87.5	9
VZBA-3/4"-GGG-63-32T-F0405-V4V4T-PP30-R-90-C	59.2	16	100.1	72.4	20	174	87.5	9
VZBA-1"-GGG-63-32L-F0405-V4V4T-PP30-R-90-C	59.2	20	104.35	76.65	20	174	100	9
VZBA-1"-GGG-63-32T-F0405-V4V4T-PP30-R-90-C	59.2	20	104.35	76.65	20	174	100	9
VZBA-1 1/4"-GGG-63-32L-F0405-V4V4T-PP60-R-90-C	70.4	25.4	121.4	88.7	20	198	123	10
VZBA-1 1/4"-GGG-63-32T-F0405-V4V4T-PP60-R-90-C	70.4	25.4	121.4	88.7	20	198	123	10
VZBA-1 1/2"-GGG-63-32L-F0405-V4V4T-PP60-R-90-C	70.4	31.8	125.9	93.2	20	198	142.2	10
VZBA-1 1/2"-GGG-63-32T-F0405-V4V4T-PP60-R-90-C	70.4	31.8	125.9	93.2	20	198	142.2	10
VZBA-2"-GGG-63-32L-F0507-V4V4T-PP106-R-90-C	83.3	38.1	149.3	110.8	20	237.1	170.6	12
VZBA-2"-GGG-63-32T-F0507-V4V4T-PP106-R-90-C	83.3	38.1	149.3	110.8	20	237.1	170.6	12

Ball valve actuator units VZBA, 3-way

Technical data

Dimensions

Download CAD data → www.festo.com

DAPS – Single-acting

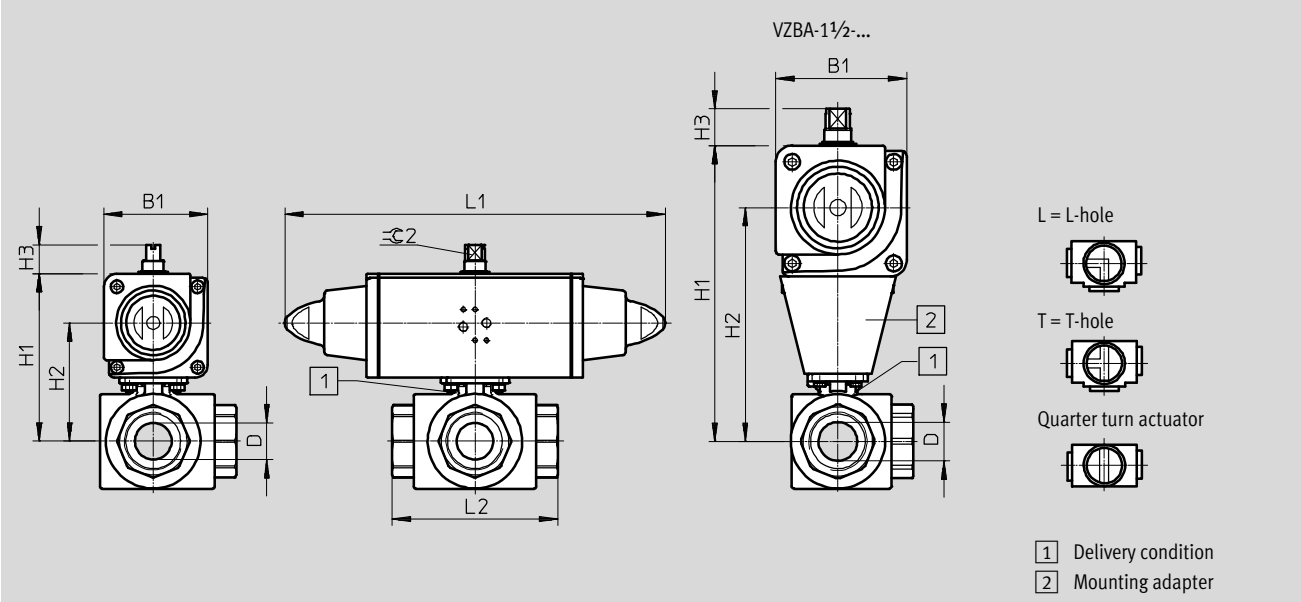

Type	B1	D ∅	H1	H2	H3	L1	L2	∅ 2
VZBA-1/4"-GGG-63-32L-F0304-V4V4T-PS30-R-90-4-C	70.4	11.6	106.3	73.6	20	259	80	10
VZBA-1/4"-GGG-63-32T-F0304-V4V4T-PS30-R-90-4-C	70.4	11.6	106.3	73.6	20	259	80	10
VZBA-3/8"-GGG-63-32L-F0304-V4V4T-PS30-R-90-4-C	70.4	12.7	106.3	73.6	20	259	80	10
VZBA-3/8"-GGG-63-32T-F0304-V4V4T-PS30-R-90-4-C	70.4	12.7	106.3	73.6	20	259	80	10
VZBA-1/2"-GGG-63-32L-F0304-V4V4T-PS30-R-90-4-C	70.4	12.7	106.3	73.6	20	259	80	10
VZBA-1/2"-GGG-63-32T-F0304-V4V4T-PS30-R-90-4-C	70.4	12.7	106.3	73.6	20	259	80	10
VZBA-3/4"-GGG-63-32L-F0405-V4V4T-PS30-R-90-4-C	70.4	16	111.3	78.6	20	259	87.5	10
VZBA-3/4"-GGG-63-32T-F0405-V4V4T-PS30-R-90-4-C	70.4	16	111.3	78.6	20	259	87.5	10
VZBA-1"-GGG-63-32L-F0405-V4V4T-PS30-R-90-4-C	70.4	20	115.55	82.85	20	259	100	10
VZBA-1"-GGG-63-32T-F0405-V4V4T-PS30-R-90-4-C	70.4	20	115.55	82.85	20	259	100	10
VZBA-1 1/4"-GGG-63-32L-F0405-V4V4T-PS53-R-90-4-C	83.3	25.4	134.3	95.8	20	304.3	123	12
VZBA-1 1/4"-GGG-63-32T-F0405-V4V4T-PS53-R-90-4-C	83.3	25.4	134.3	95.8	20	304.3	123	12
VZBA-1 1/2"-GGG-63-32L-F0405-V4V4T-PS90-R-90-4-C	107.5	31.8	243	192	30	393.7	142.2	15
VZBA-1 1/2"-GGG-63-32T-F0405-V4V4T-PS90-R-90-4-C	107.5	31.8	243	192	30	393.7	142.2	15
VZBA-2"-GGG-63-32L-F0507-V4V4T-PS90-R-90-4-C	107.5	38.1	173.5	122.5	30	393.7	170.6	15
VZBA-2"-GGG-63-32T-F0507-V4V4T-PS90-R-90-4-C	107.5	38.1	173.5	122.5	30	393.7	170.6	15

Ball valve actuator units VZBA, 3-way

Technical data

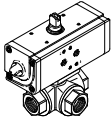
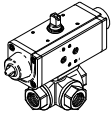
Ordering data – Ball valve actuator units made from stainless steel								
DAPS – Double-acting	Process valve connection	Hole	Flow rate Kv [m ³ /h] Type			Part No.	Type	
			L	T right-angled	T straight			
	Rp1/4	L	4.5	–	–	1914785	VZBA-1/4"-GGG-63-32L-F0304-V4V4T-PP30-R-90-C	
	Rp3/8		4.5	–	–	1914786	VZBA-3/8"-GGG-63-32L-F0304-V4V4T-PP30-R-90-C	
	Rp1/2		4.7	–	–	1914787	VZBA-1/2"-GGG-63-32L-F0304-V4V4T-PP30-R-90-C	
	Rp3/4		5.1	–	–	1914788	VZBA-3/4"-GGG-63-32L-F0405-V4V4T-PP30-R-90-C	
	Rp1		11.8	–	–	1914789	VZBA-1"-GGG-63-32L-F0405-V4V4T-PP30-R-90-C	
	Rp1 1/4		19.6	–	–	1914790	VZBA-1 1/4"-GGG-63-32L-F0405-V4V4T-PP60-R-90-C	
	Rp1 1/2		33.2	–	–	1914791	VZBA-1 1/2"-GGG-63-32L-F0405-V4V4T-PP60-R-90-C	
	Rp2		53.7	–	–	1914792	VZBA-2"-GGG-63-32L-F0507-V4V4T-PP106-R-90-C	
	Rp1/4		T	–	4.5	8	1915072	VZBA-1/4"-GGG-63-32T-F0304-V4V4T-PP30-R-90-C
	Rp3/8	–		4.5	8	1915073	VZBA-3/8"-GGG-63-32T-F0304-V4V4T-PP30-R-90-C	
	Rp1/2	–		4.8	8.3	1915074	VZBA-1/2"-GGG-63-32T-F0304-V4V4T-PP30-R-90-C	
	Rp3/4	–		4.8	8.3	1915075	VZBA-3/4"-GGG-63-32T-F0405-V4V4T-PP30-R-90-C	
	Rp1	–		10.9	22.4	1915076	VZBA-1"-GGG-63-32T-F0405-V4V4T-PP30-R-90-C	
	Rp1 1/4	–		18	36.5	1915077	VZBA-1 1/4"-GGG-63-32T-F0405-V4V4T-PP60-R-90-C	
	Rp1 1/2	–		30	62	1915078	VZBA-1 1/2"-GGG-63-32T-F0405-V4V4T-PP60-R-90-C	
	Rp2	–		48.8	100	1915079	VZBA-2"-GGG-63-32T-F0507-V4V4T-PP106-R-90-C	
	DAPS – Single-acting	Process valve connection	Hole	Flow rate Kv [m ³ /h] Type			Part No.	Type
				L	T right-angled	T straight		
	Rp1/4	L	4.5	–	–	1915543	VZBA-1/4"-GGG-63-32L-F0304-V4V4T-PS30-R-90-4-C	
	Rp3/8		4.5	–	–	1915544	VZBA-3/8"-GGG-63-32L-F0304-V4V4T-PS30-R-90-4-C	
	Rp1/2		4.7	–	–	1915545	VZBA-1/2"-GGG-63-32L-F0304-V4V4T-PS30-R-90-4-C	
	Rp3/4		5.1	–	–	1915546	VZBA-3/4"-GGG-63-32L-F0405-V4V4T-PS30-R-90-4-C	
	Rp1		11.8	–	–	1915547	VZBA-1"-GGG-63-32L-F0405-V4V4T-PS30-R-90-4-C	
	Rp1 1/4		19.6	–	–	1915548	VZBA-1 1/4"-GGG-63-32L-F0405-V4V4T-PS53-R-90-4-C	
	Rp1 1/2		33.2	–	–	1915549	VZBA-1 1/2"-GGG-63-32L-F0405-V4V4T-PS90-R-90-4-C	
	Rp2		53.7	–	–	1915550	VZBA-2"-GGG-63-32L-F0507-V4V4T-PS90-R-90-4-C	
	Rp1/4		T	–	4.5	8	1915744	VZBA-1/4"-GGG-63-32T-F0304-V4V4T-PS30-R-90-4-C
	Rp3/8	–		4.5	8	1915745	VZBA-3/8"-GGG-63-32T-F0304-V4V4T-PS30-R-90-4-C	
	Rp1/2	–		4.8	8.3	1915746	VZBA-1/2"-GGG-63-32T-F0304-V4V4T-PS30-R-90-4-C	
	Rp3/4	–		4.8	8.3	1915747	VZBA-3/4"-GGG-63-32T-F0405-V4V4T-PS30-R-90-4-C	
	Rp1	–		10.9	22.4	1915748	VZBA-1"-GGG-63-32T-F0405-V4V4T-PS30-R-90-4-C	
	Rp1 1/4	–		18	36.5	1915749	VZBA-1 1/4"-GGG-63-32T-F0405-V4V4T-PS53-R-90-4-C	
	Rp1 1/2	–		30	62	1915750	VZBA-1 1/2"-GGG-63-32T-F0405-V4V4T-PS90-R-90-4-C	
	Rp2	–		48.8	100	1915751	VZBA-2"-GGG-63-32T-F0507-V4V4T-PS90-R-90-4-C	



Ball valve actuator units VZBA

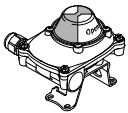
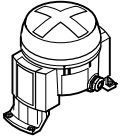
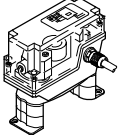

Accessories



Ordering data – Limit switch attachments (NAMUR)			Technical data → limit switch attachment	
	Sensing principle	Explosion-proof	Part No.	Type
Round design				
	Electrical	–	1152495	SRBF-CA3-YR90-MW-22A-C2M20
	Electrical	–	1152496	SRBF-CA4-YR90-MW-22A-C2M20
	Electrical	–	1152497	SRBF-CA5-YR90-MW-22A-C2M20
	Electrical	–	1152498	SRBF-CA6-YR90-MW-22A-C2M20
	Electrical	–	534 469	DAPZ-SB-M-250AC-DR-RO
	Inductive	–	534 471	DAPZ-SB-I-30DC-DR-RO
	Inductive	■	534 472	DAPZ-SB-I-25DC-R-RO
	Electrical	–	534 474	DAPZ-SB-M-250AC-DR-AR
	Inductive	–	534 475	DAPZ-SB-I-30DC-DR-AR
	Inductive	■	534 476	DAPZ-SB-I-25DC-EXDR-AR
Square design				
	Electrical	–	534 468	DAPZ-SB-M-250AC-DSM-RO
	Electrical	■	534 470	DAPZ-SB-M-250AC-EXS-RO
	Inductive	–	534 473	DAPZ-SB-I-30DC-DSAM-RO
	Electrical	–	164 854	QH-DR-E-S3-E-SW-B
	Inductive	–	164 853	QH-DR-E-SIEN-M12-NB-B
	Pneumatic	–	164 855	QH-DR-E-S3-PK-3-B-B

Ball valve actuator units VZBA

Accessories

Ordering data – Basic valves			
	Description	Part No.	Type
5/2-way valve, single solenoid			
	Can be changed to 3/2-way valve	547017	VSNB-FC-M52-M-G14-P2
	Cannot be changed to 3/2-way valve	547021	VSNB-F-M52-M-G14-P2
5/2-way valve, double solenoid			
	Cannot be changed to 3/2-way valve	547022	VSNB-F-B52-M-G14-P2

Ordering data – Solenoid valve			
	Description	Part No.	Type
5/2-way valve, single solenoid			
	Can be changed to 3/2-way valve	547026	VSNB-FC-M52-MH-G14-1A1
	Cannot be changed to 3/2-way valve	547028	VSNB-F-M52-MH-G14-1A1
5/2-way valve, double solenoid			
	Cannot be changed to 3/2-way valve	547029	VSNB-F-B52-H-G14-1A1

Ordering data – Solenoid valves Ex-ia			
	Description	Part No.	Type
5/2-way valve, single solenoid			
	–	547023	VSNB-F-M52-M-G14-1A1-Ex4A
		547019	VSNB-FC-M52-M-G14-1A1-Ex4A
5/2-way valve, double solenoid			
	–	547024	VSNB-F-B52-G14-1A1-Ex4A

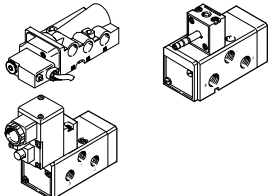
Ordering data – Solenoid valves (NAMUR)			Technical data → solenoid valve	
	Standard nominal flow rate	For coil type	Part No.	Type
	900	F solenoid coil	535 987	NVF3-MOH-5/2-K-1/4-Ex
		V solenoid coil	535 988	NVF3-MOH-5/2-K-1/4-IA-Ex
	1,000	F solenoid coil	183 973	MFH-5/2K-FR-NA
		N1 solenoid coil	183 974	MN1H-5/2K-FR-NA

Product Range and Company Overview

A Complete Suite and Company Overview

Our experienced engineers provide complete support at every stage of your development process, including: conceptualization, analysis, engineering, design, assembly, documentation, validation, and production.



Custom Automation Components
Complete custom engineered solutions



Custom Control Cabinets
Comprehensive engineering support and on-site services



Complete Systems
Shipment, stocking and storage services

The Broadest Range of Automation Components

With a comprehensive line of more than 30,000 automation components, Festo is capable of solving the most complex automation requirements.



Electromechanical
Electromechanical actuators, motors, controllers & drivers



Pneumatics
Pneumatic linear and rotary actuators, valves, and air supply



PLCs and I/O Devices
PLC's, operator interfaces, sensors and I/O devices

Supporting Advanced Automation... As No One Else Can!

Festo is a leading global manufacturer of pneumatic and electromechanical systems, components and controls for industrial automation, with more than 16,000 employees in 60 national headquarters serving more than 180 countries. For more than 80 years, Festo has continuously elevated the state of manufacturing with innovations and optimized motion control solutions that deliver higher performing, more profitable automated manufacturing and processing equipment. Our dedication to the advancement of automation extends beyond technology to the education and development of current and future automation and robotics designers with simulation tools, teaching programs, and on-site services.

Quality Assurance, ISO 9001 and ISO 14001 Certifications

Festo Corporation is committed to supply all Festo products and services that will meet or exceed our customers' requirements in product quality, delivery, customer service and satisfaction.

To meet this commitment, we strive to ensure a consistent, integrated, and systematic approach to management that will meet or exceed the requirements of the ISO 9001 standard for Quality Management and the ISO 14001 standard for Environmental Management.



© Copyright 2013, Festo Corporation. While every effort is made to ensure that all dimensions and specifications are correct, Festo cannot guarantee that publications are completely free of any error, in particular typing or printing errors. Accordingly, Festo cannot be held responsible for the same. For Liability and Warranty conditions, refer to our "Terms and Conditions of Sale", available from your local Festo office. All rights reserved. No part of this publication may be reproduced, distributed, or transmitted in any form or by any means, electronic, mechanical, photocopying or otherwise, without the prior written permission of Festo. All technical data subject to change according to technical update.



Printed on recycled paper at New Horizon Graphic, Inc., FSC certified as an environmental friendly printing plant.

Festo North America

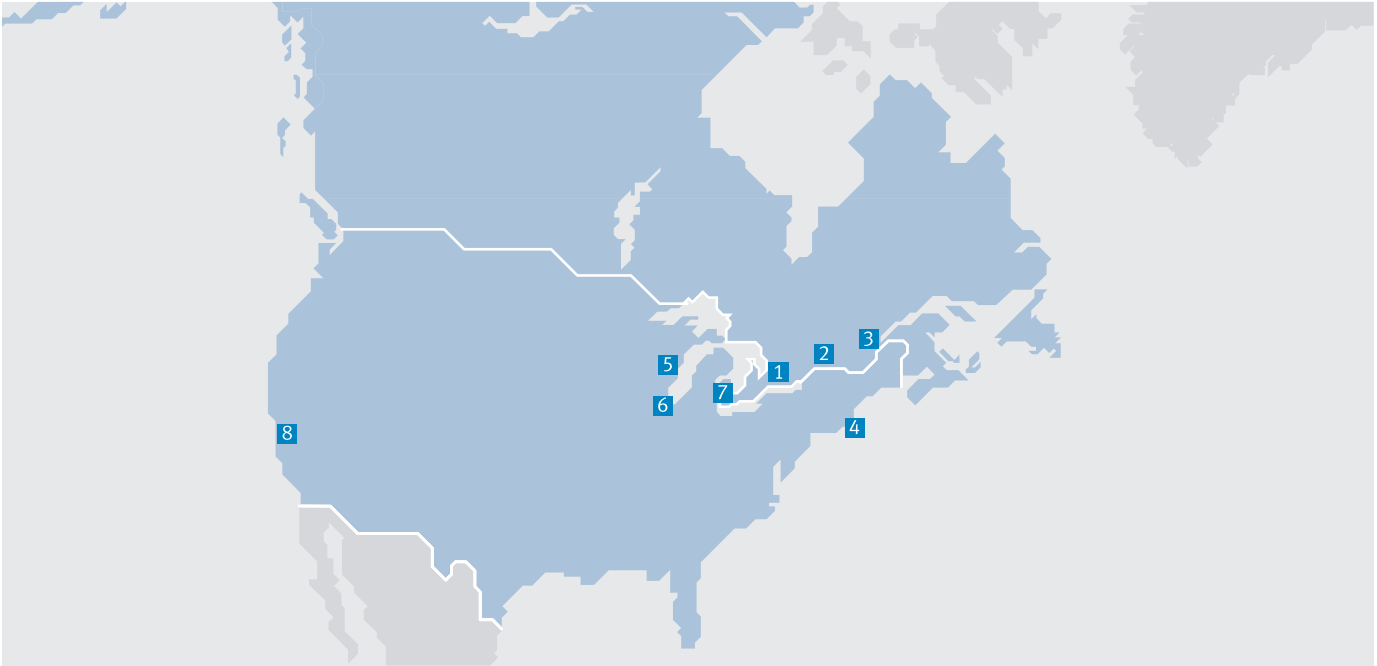

**1 Festo Canada
Headquarters
Festo Inc.**
5300 Explorer Drive
Mississauga, ON
L4W 5G4

2 Montréal
5600, Trans-Canada
Pointe-Claire, QC
H9R 1B6

3 Québec City
2930, rue Watt#117
Québec, QC
G1X 4G3



**4 Festo United States
Headquarters
Festo Corporation**
395 Moreland Road
Hauppauge, NY
11788

5 Appleton
North 922 Tower View Drive, Suite N
Greenville, WI
54942

7 Detroit
1441 West Long Lake Road
Troy, MI
48098

6 Chicago
85 W Algonquin - Suite 340
Arlington Heights, IL
60005

8 Silicon Valley
4935 Southfront Road, Suite F
Livermore, CA
94550

Festo Regional Contact Center

Canadian Customers

Commercial Support:
Tel: 1 877 GO FESTO (1 877 463 3786)
Fax: 1 877 FX FESTO (1 877 393 3786)
Email: festo.canada@ca.festo.com

Technical Support:

Tel: 1 866 GO FESTO (1 866 463 3786)
Fax: 1 877 FX FESTO (1 877 393 3786)
Email: technical.support@ca.festo.com

USA Customers

Commercial Support:
Tel: 1 800 99 FESTO (1 800 993 3786)
Fax: 1 800 96 FESTO (1 800 963 3786)
Email: customer.service@us.festo.com

Technical Support:

Tel: 1 866 GO FESTO (1 866 463 3786)
Fax: 1 800 96 FESTO (1 800 963 3786)
Email: product.support@us.festo.com