

Pneumatic valves VUWS/valve manifold VTUS, NPT



Pneumatic valves VUWS/valve manifold VTUS, NPT

Key features – Pneumatics

FESTO

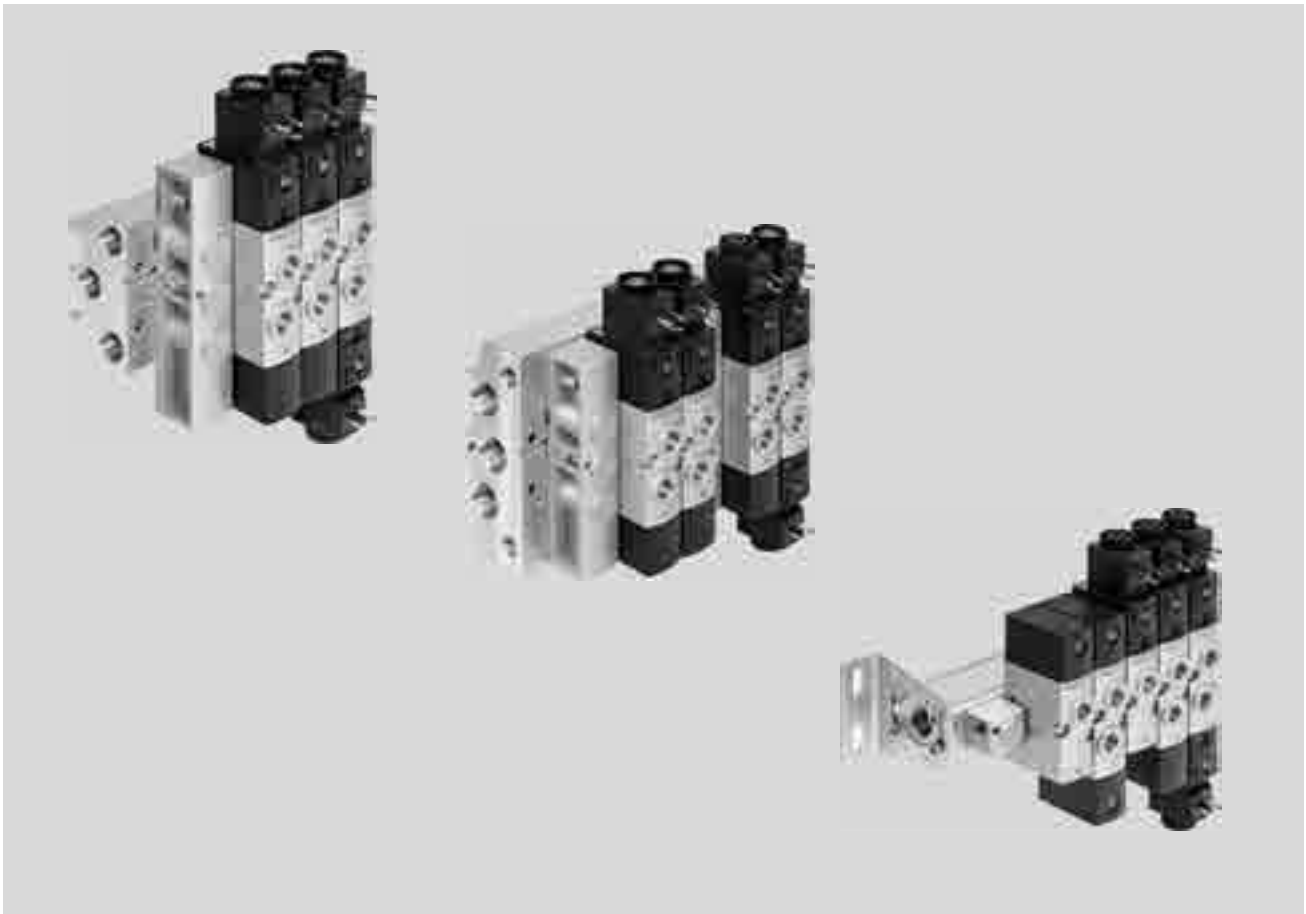

Innovative

- A reliable, heavy-duty valve with a long service life
- Flow rate up to 2300 l/min
- Low-cost universal valve with no performance limitations
- Wide range of valve functions
- Several sizes

Versatile

- In-line valves can be used as individual valves or manifold valves
- Variable pressure zones
- Wide range of mounting options

Reliable

- Ergonomic, reliable operation
- Durable thanks to tried and tested piston spools
- Reliable servicing thanks to valves that can be replaced quickly and easily

Easy to install

- Pre-assembled units on rails
- Individual valves assembled ready for installation
- Supply manifolds for mounting on both sides
- Secure mounting on wall or H-rail

Valve manifold selection

Configurator

The appropriate valve manifold VTUS can be chosen quickly and easily using the online catalogue. This includes a convenient configurator, making it much easier to order the right product.

The valve manifold is fully assembled according to your order specification and individually checked. This reduces assembly and installation time to a minimum.

Ordering system for valve manifold VTUS

➔ Internet: vtus

2D/3D CAD data

The CAD data for a configured valve manifold can be retrieved online using the configurator and downloaded.

Pneumatic valves VUWS/valve manifold VTUS, NPT

FESTO

Key features

Pneumatic valves VUWS

In-line valve VUWS as individual valve

Valve manifold VTUS

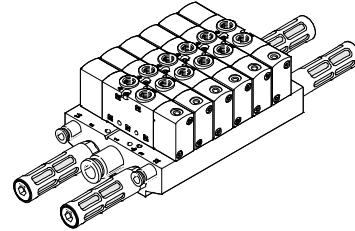
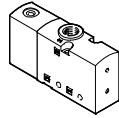
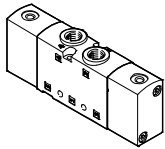

Equipment options

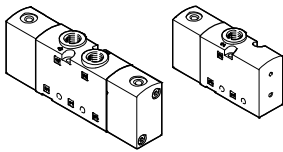

- Size 20 (21 mm)
- Size 25 (26.5 mm)
- Size 30 (31 mm)
- 3/2-, 5/2- and 5/3-way valves
- In-line valves

All valves are equipped with a piston spool and patented sealing system to facilitate efficient sealing, a broad pressure range and a long service life. Pneumatic valves VUWS have a sturdy design that enables them to be used in harsh environments.

Pneumatic valves VUWS are extremely well suited for controlling cylinders or compressed air networks for easy clamping and locking processes in semi-automatic assembly and manufacturing.

Valve functions

3/2-way valve, normal position open, monostable:

- Reset via pneumatic/mechanical spring
- Direction of flow reversible when reset is via mechanical spring
- Dual-pressure operation possible

3/2-way valve, normal position closed, monostable:

- Reset via pneumatic/mechanical spring
- Direction of flow reversible when reset is via mechanical spring
- Dual-pressure operation possible

5/2-way valve, monostable:

- Reset via pneumatic/mechanical spring
 - Direction of flow reversible when reset is via mechanical spring
- 5/2-way valve, bistable:
- Direction of flow reversible

5/3-way valve, mid-position exhausted, pressurised or closed:

- External pneumatic spring connection
- Direction of flow reversible
- Reset via mechanical spring

Key features

- A maximum of 16 valve positions can be configured in the standard version
- A maximum of 12 valve positions can be configured in the compact version

- Valve positions 2 ... 10 can be configured in increments of 1, valve positions 10 ... 16 in increments of 2
- Manifold block with a maximum of 10 valve positions

- Supply manifold with a maximum of 10 valve positions

- Creation of pressure zones (maximum 9 pressure zones in the case of a valve manifold with 16 valve positions)

Design

Valve replacement

Each valve is attached to the manifold block using two screws. The appropriate seal is mounted on the valve.

This means that the valves can be easily replaced.

Extension

Valve positions covered with blanking plates can be replaced with valves at a later date. The dimensions, mounting points and existing pneumatic installations remain unchanged.

Pneumatic valves VUWS/valve manifold VTUS, NPT

Key features

Standard manifold block

For 3/2-way valves

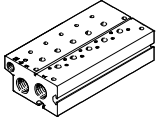

- Connection:
Size 20: 3/8 NPT
Size 25: 1/2 NPT
Size 30: 3/4 NPT
- Maximum 10 valve positions

For 5/2- and 5/3-way valves

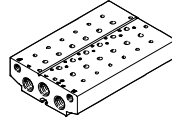

- Connection:
Size 20: 3/8 NPT
Size 25: 1/2 NPT
Size 30: 3/4 NPT
- Maximum 10 valve positions

Compact manifold block

For 3/2-way valves

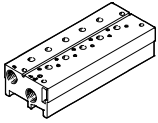

- Connection:
Size 20: 1/4 NPT
Size 25: 3/8 NPT
Size 30: 1/2 NPT
- Maximum 10 valve positions

For 5/2- and 5/3-way valves

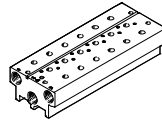

- Connection:
Size 20: 1/4 NPT
Size 25: 3/8 NPT
Size 30: 1/2 NPT
- Maximum 10 valve positions

Supply manifold

Mounting on both sides

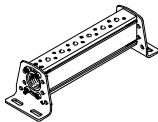

- Connection:
Size 20: 3/8 NPT
Size 25: 1/2 NPT
Size 30: 3/4 NPT
- Maximum 10 valve positions

Blanking plate for unused valve position

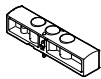

For covering unused valve positions

Supply plate

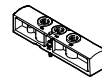

For additional air supply and exhaust via a valve position

Separator for pressure zones



For creating pressure zones
(maximum 9 pressure zones permitted)

Note

A filter must be installed upstream of the valves operated in vacuum mode. This prevents any foreign matter in

the intake air getting into the valve (e.g. when operating a suction cup).

Pneumatic valves VUWS/valve manifold VTUS, NPT

Key features – Pneumatics

FESTO

Creating pressure zones and separating exhaust air

Compressed air is supplied and exhausted via the manifold block/ supply manifold and via supply plates.

The position of the supply plates and duct separations can be freely selected with the VTUS.

A pressure zone is created by isolating the internal ducts between the valve positions by means of an appropriate separator.

The separator can be used in the following ducts:

- Duct 1
- Duct 3
- Duct 5

 Note

- Use a separator if the exhaust air pressures are high
- Use at least one supply plate/ supply for each pressure zone

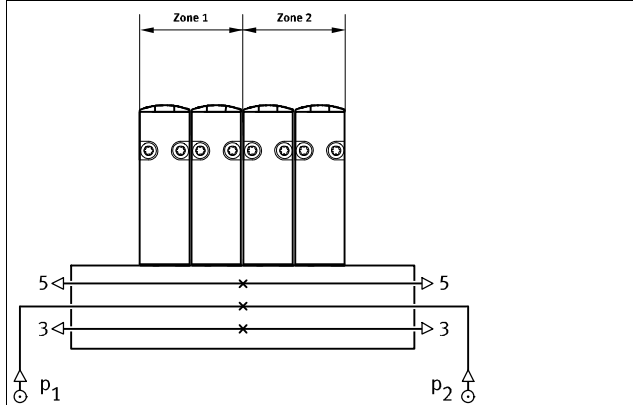
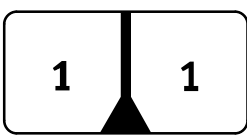
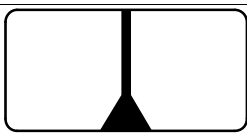
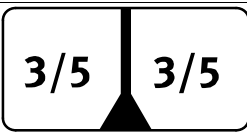
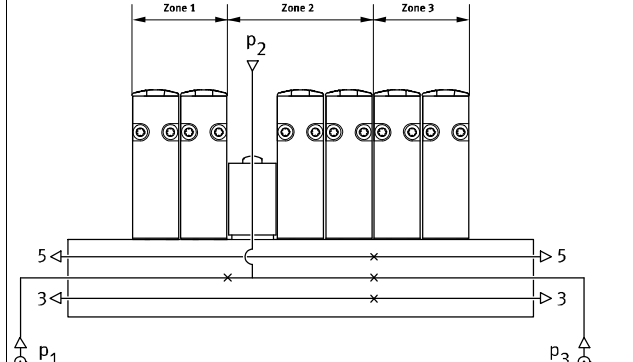
Duct separation	Description
	<p>The pressure zones can be freely configured with the VTUS. The following duct separations are possible:</p> <ul style="list-style-type: none"> • Duct 1 closed  • Duct 1/3/5 closed  • Duct 3/5 closed 
	<p>The number of pressure zones with the VTUS is limited by the number of valve positions on the manifold block/supply manifold. Note that each supply plate occupies one valve position. There must always be at least 2 valve positions between 2 separators. In the case of a maximum extension of 16 valve positions, a maximum of 9 pressure zones can be created.</p>

Pneumatic valves VUWS/valve manifold VTUS, NPT

Key features – Pneumatics

Standard nominal flow rate q_{nN} , with several valves n switched in parallel, size 20

For 3/2-way valves, valve manifold

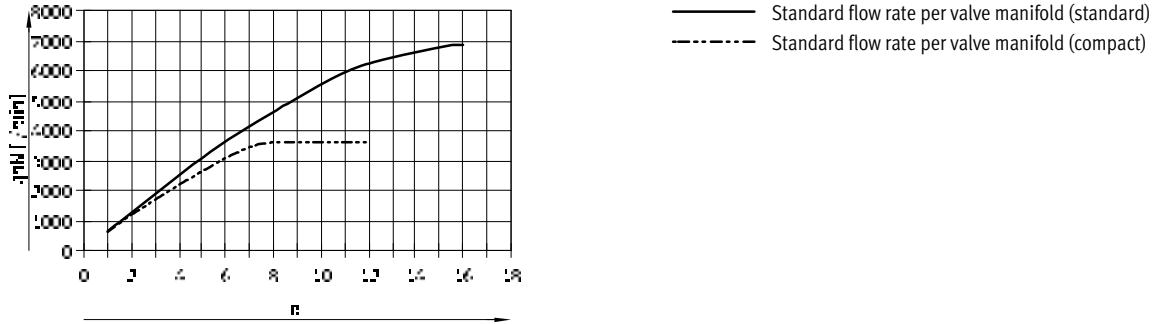

Standard nominal flow rate q_n , with several valves n switched in parallel, size 20

For 3/2-way valves, individual valve

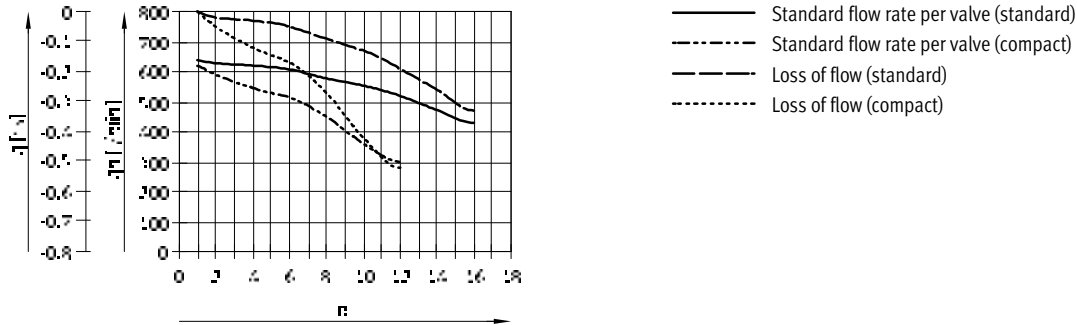

Standard nominal flow rate q_{nN} , with several valves n switched in parallel, size 20

For 5/2- and 5/3-way valves, valve manifold

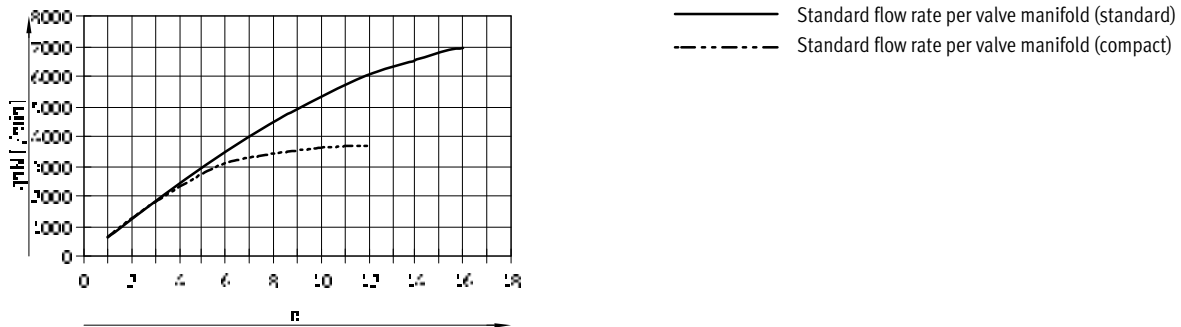

Standard nominal flow rate q_n , with several valves n switched in parallel, size 20

For 5/2- and 5/3-way valves, individual valve

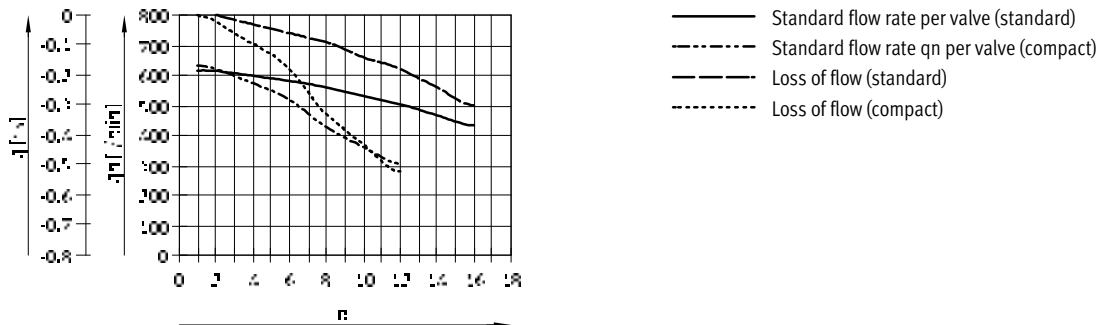

Pneumatic valves VUWS/valve manifold VTUS, NPT

Key features – Pneumatics

Standard nominal flow rate q_{nN} , with several valves n switched in parallel, size 25

For 3/2-way valves, valve manifold

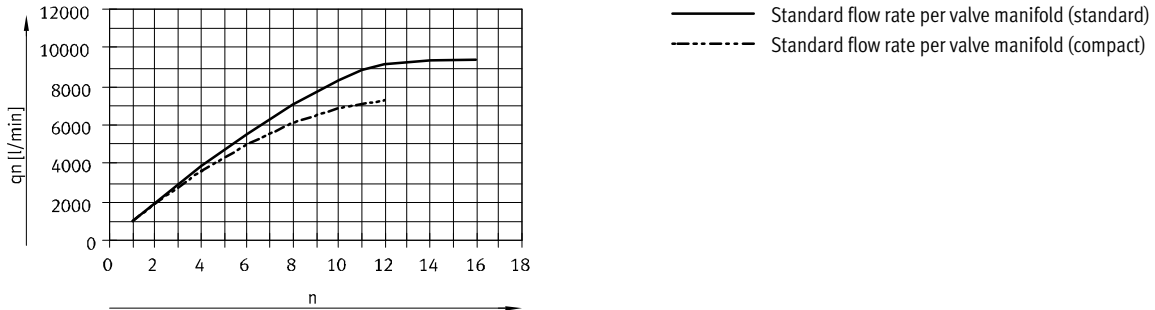

Standard nominal flow rate q_n , with several valves n switched in parallel, size 25

For 3/2-way valves, individual valve

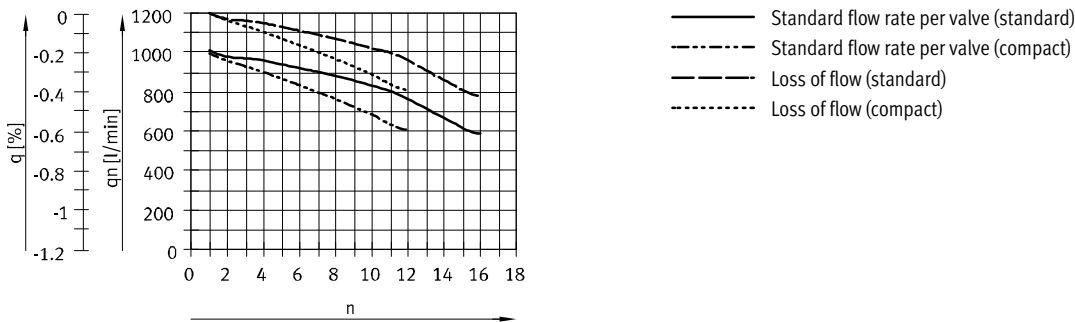

Standard nominal flow rate q_{nN} , with several valves n switched in parallel, size 25

For 5/2- and 5/3-way valves, valve manifold

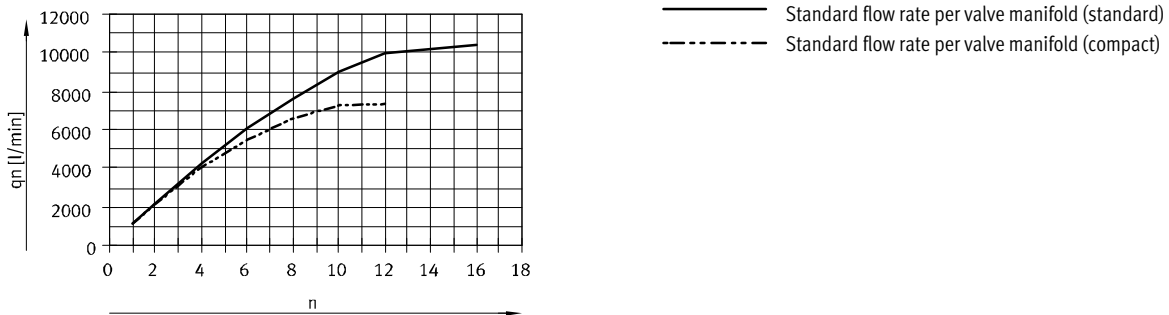

Standard nominal flow rate q_n , with several valves n switched in parallel, size 25

For 5/2- and 5/3-way valves, individual valve

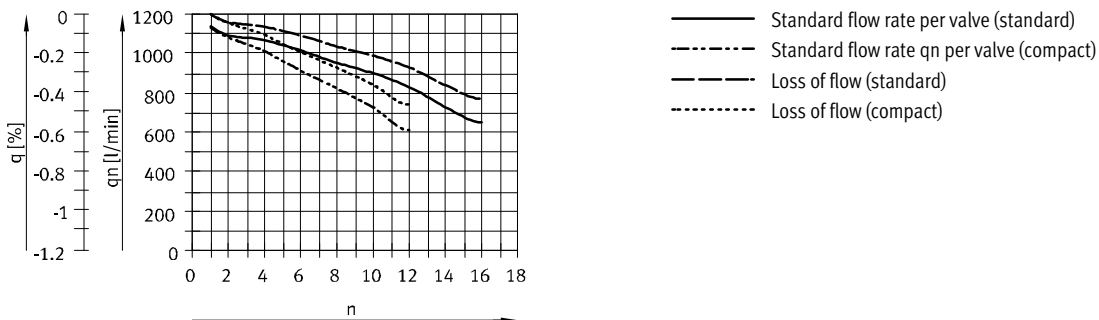

Pneumatic valves VUWS/valve manifold VTUS, NPT

Key features – Pneumatics

Standard nominal flow rate q_{nN} , with several valves n switched in parallel, size 30

For 3/2-way valves, valve manifold

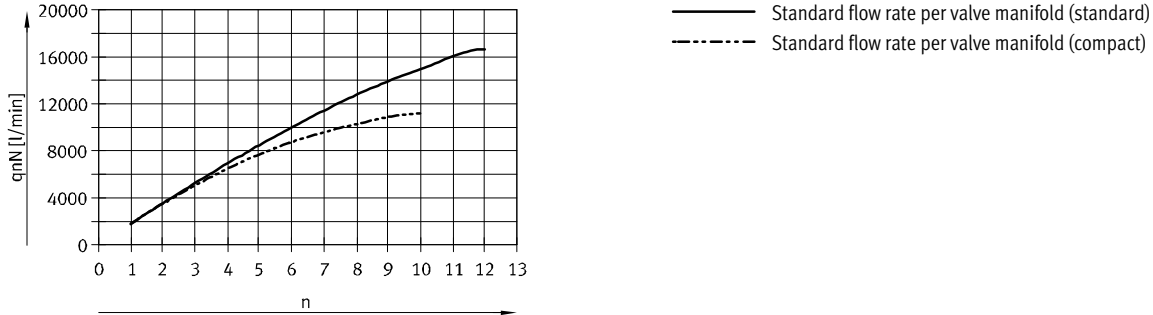

Standard nominal flow rate q_n , with several valves n switched in parallel, size 30

For 3/2-way valves, individual valve

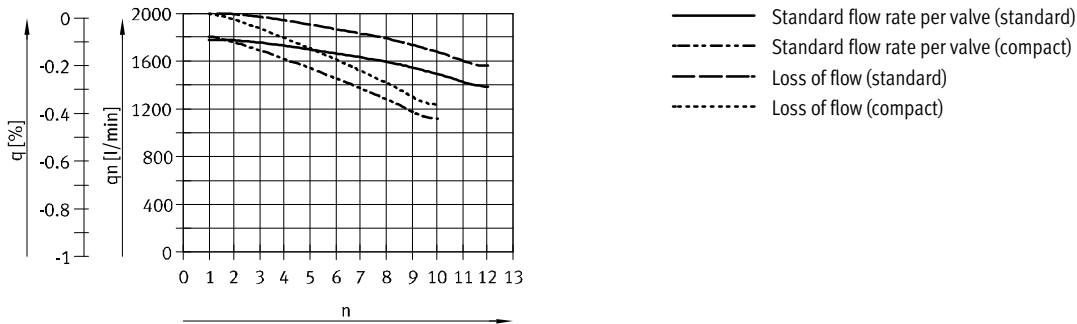

Standard nominal flow rate q_{nN} , with several valves n switched in parallel, size 30

For 5/2- and 5/3-way valves, valve manifold

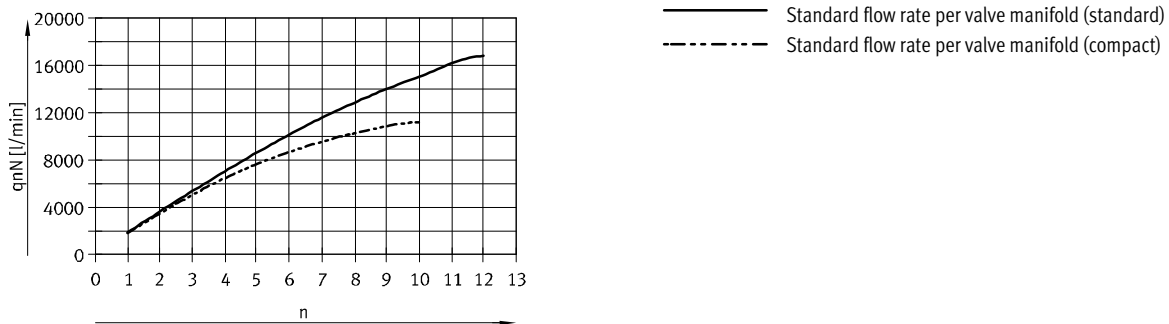

Standard nominal flow rate q_n , with several valves n switched in parallel, size 30

For 5/2- and 5/3-way valves, individual valve

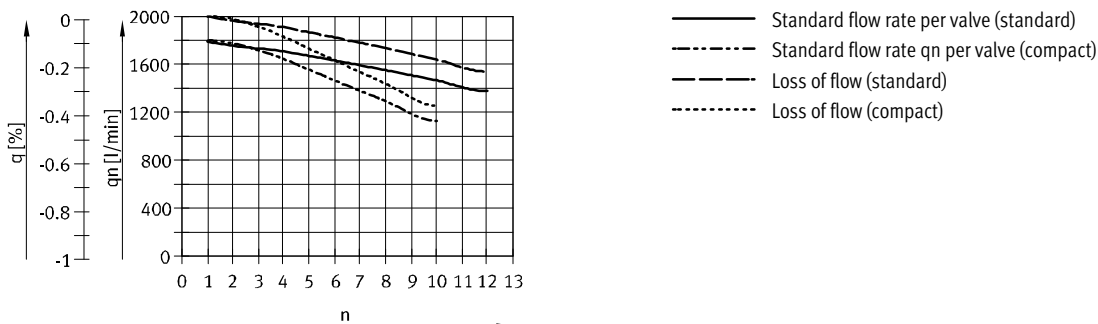

Pneumatic valves VUWS/valve manifold VTUS, NPT

Key features – Assembly

Mounting the valve manifold

- Sturdy manifold assembly owing to:
- Four through-holes for wall mounting
 - H-rail mounting

 Note

Use the thread M4 (M5 for size 30) provided on the manifold block for earthing the valve manifold.

Wall mounting

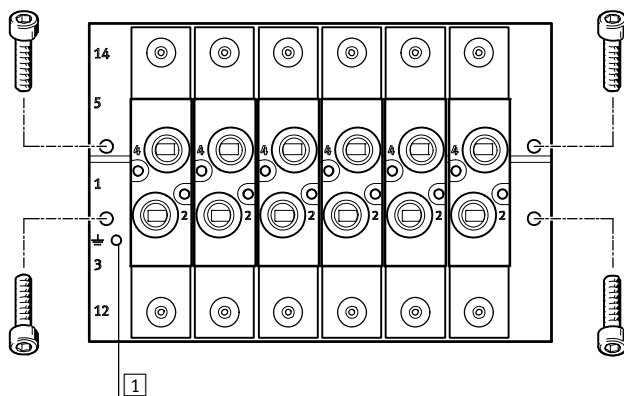

Sturdy wall mounting of the manifold block using four through-holes.

1 Earth terminal

H-rail mounting

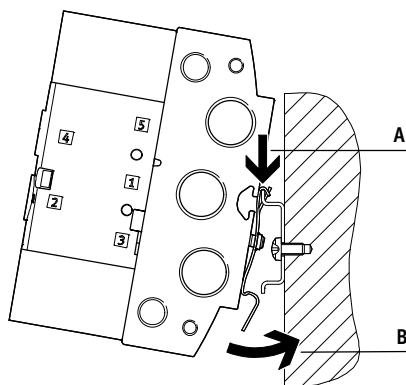

The H-rail mounting VAME-T-M... consists of two mounting clips. These are screwed to the manifold block on the left and right.

The prepared manifold block is then lowered onto the H-rail from above (arrow A) and clipped into the H-rail at the bottom (arrow B).

 Note

- Note the max. tightening torque of the screws for H-rail mounting.
- Only horizontal H-rail mounting is permissible.
- Mounting only possible on H-rail TH 35-... to EN 60715.
- Vibration/shock loads are not permissible with H-rail mounting.
- Further information on assembly → Assembly instructions for H-rail mounting VAME-T-M...

Pneumatic valves VUWS/valve manifold VTUS, NPT

Key features – Assembly

FESTO

Mounting individual valve VUWS

Wall mounting

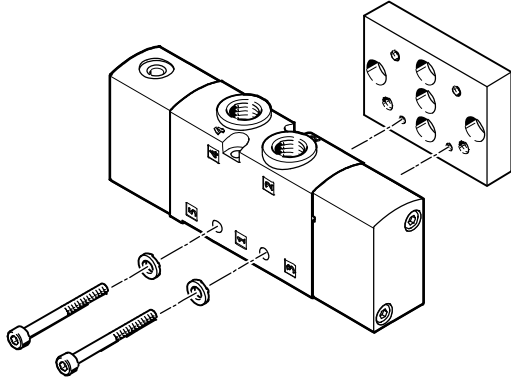

For mounting individual valves on a flat surface, e.g. aluminium profile systems.
The pneumatic valves are provided with two through-holes for attaching to the wall mounting VAME-B10-20-W.

The screw set required is included with the wall mounting VAME-B10-20-W.
The wall mounting VAME-B10-20-W can be used for sizes 20, 25 and 30.

Foot mounting

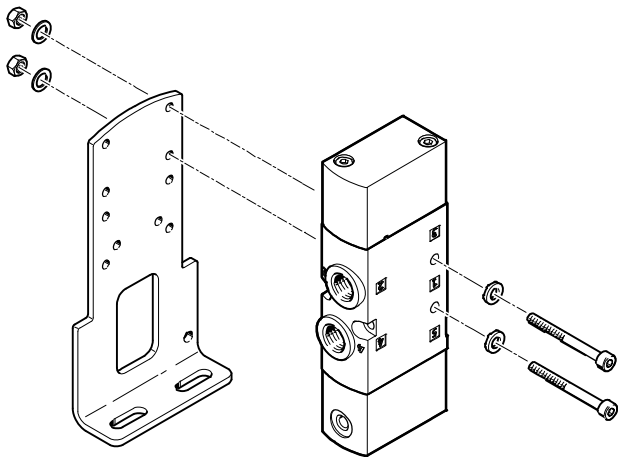

For mounting individual valves on a flat surface, e.g. aluminium profile systems.
The pneumatic valves are provided with two through-holes for attaching to the foot mounting VAME-B10-...-A.

The screw set required is included with the foot mounting VAME-B10-...-A.

 Note

Further mounting options for foot mounting VAME-B10-...
➔ Technical data – Pneumatic valves, dimensions

Pneumatic valves VUWS/valve manifold VTUS, NPT

FESTO

Product range overview

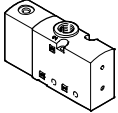
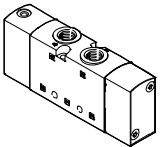
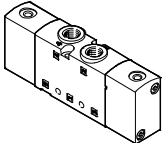
Design	Size	Working port	Order code for valves and flow rate [l/min]							→ Page/ Internet
			M32C	M32U	M52	B52	P53C	P53E	P53U	
3/2-way valve										
	20	1/8 NPT	700	700	-	-	-	-	-	37
	25	1/4 NPT	1000	1000	-	-	-	-	-	45
	30	3/8 NPT	2300	2300	-	-	-	-	-	53
5/2-way valve										
	20	1/8 NPT	-	-	700	700	-	-	-	37
	25	1/4 NPT	-	-	1300	1300	-	-	-	45
	30	3/8 NPT	-	-	2300	2300	-	-	-	53
5/3-way valve										
	20	1/8 NPT	-	-	-	-	700	600	600	37
	25	1/4 NPT	-	-	-	-	1200	1000	1000	45
	30	3/8 NPT	-	-	-	-	2000	1600	1600	53

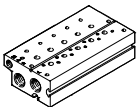
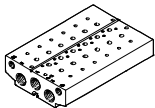
Design	Size	Description	→ Page/ Internet	
Manifold block for 3/2-way valves, standard				
	20	VABM-B10-20E-N38- ... -P3	Connection 3/8 NPT	61
	25	VABM-B10-25E-N12- ... -P3	Connection 1/2 NPT	71
	30	VABM-B10-30E-N34- ... -P3	Connection 3/4 NPT	81
Manifold block for 5/2- and 5/3-way valves, standard				
	20	VABM-B10-20E-N38- ...	Connection 3/8 NPT	61
	25	VABM-B10-25E-N12- ...	Connection 1/2 NPT	71
	30	VABM-B10-30E-N34- ...	Connection 3/4 NPT	81

Pneumatic valves VUWS/valve manifold VTUS, NPT

Product range overview

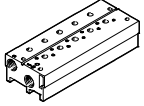
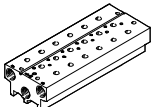
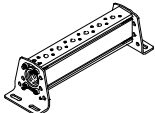
Design	Size	Description	→ Page/ Internet	
Manifold block for 3/2-way valves, compact				
	20	VABM-B10-20S-N14- ...-P3	Connection 1/4 NPT	61
	25	VABM-B10-25S-N38- ...-P3	Connection 3/8 NPT	71
	30	VABM-B10-30S-N12- ...-P3	Connection 1/2 NPT	81
Manifold block for 5/2- and 5/3-way valves, compact				
	20	VABM-B10-20S-N14- ...	Connection 1/4 NPT	61
	25	VABM-B10-25S-N38- ...	Connection 3/8 NPT	71
	30	VABM-B10-30S-N12- ...	Connection 1/2 NPT	81
Supply manifold, for mounting on both sides				
	20	VABM-B10-20-N38- ... -P53	Connection 3/8 NPT	61
	25	VABM-B10-25-N12- ... -P53	Connection 1/2 NPT	71
	30	VABM-B10-30-N34- ... -P53	Connection 3/4 NPT	81

Pneumatic valves VUWS, NPT

Valve function

FESTO

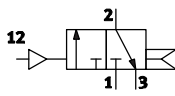
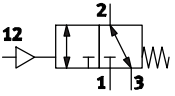
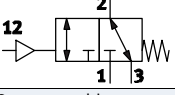
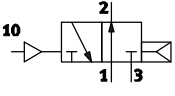
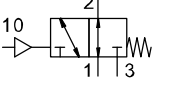
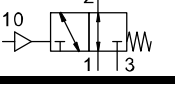
3/2-way valves			
Order code for valves	Circuit symbol	Size	Description
3/2-way valves, NC, monostable			
M32C-A		20 25 30	<ul style="list-style-type: none"> • Normally closed • Internal pneumatic spring supply • Direction of flow: not reversible • Reset: pneumatic spring
M32C-M		20	<ul style="list-style-type: none"> • Normally closed • Direction of flow: reversible • Reset: mechanical spring, supported internally by pneumatic spring
M32C-M		25 30	<ul style="list-style-type: none"> • Normally closed • Direction of flow: reversible • Reset: mechanical spring
3/2-way valve, NO, monostable			
M32U-A		20 25 30	<ul style="list-style-type: none"> • Normally open • Internal pneumatic spring supply • Direction of flow: not reversible • Reset: pneumatic spring
M32U-M		20	<ul style="list-style-type: none"> • Normally open • Direction of flow: reversible • Reset: mechanical spring, supported internally by pneumatic spring
M32U-M		25 30	<ul style="list-style-type: none"> • Normally open • Direction of flow: reversible • Reset: mechanical spring

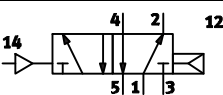
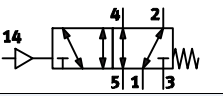
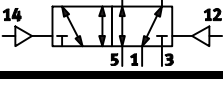
5/2-way valves			
Order code for valves	Circuit symbol	Size	Description
5/2-way valve, monostable			
M52-A		20 25 30	<ul style="list-style-type: none"> • Internal pneumatic spring supply • Direction of flow: not reversible • Reset: pneumatic spring
M52-M		20 25 30	<ul style="list-style-type: none"> • Direction of flow: reversible • Reset: mechanical spring
5/2-way valve, bistable			
B52		20 25 30	<ul style="list-style-type: none"> • Direction of flow: reversible

Pneumatic valves VUWS, NPT

Valve function

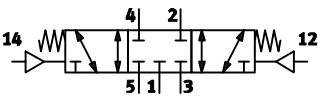
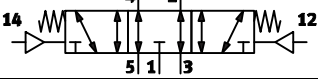
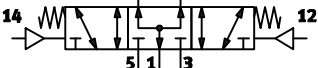
5/3-way valves			
Order code for valves	Circuit symbol	Size	Description
5/3-way valve, mid-position closed			
P53C		20 25 30	<ul style="list-style-type: none"> Direction of flow: reversible
5/3-way valve, mid-position exhausted			
P53E		20 25 30	<ul style="list-style-type: none"> Direction of flow: reversible
5/3-way valve, mid-position pressurised			
P53U		20 25 30	<ul style="list-style-type: none"> Direction of flow: reversible

Pneumatic valves VUWS/valve manifold VTUS, NPT

Peripherals overview

FESTO

Manifold block for 3/2-way valves

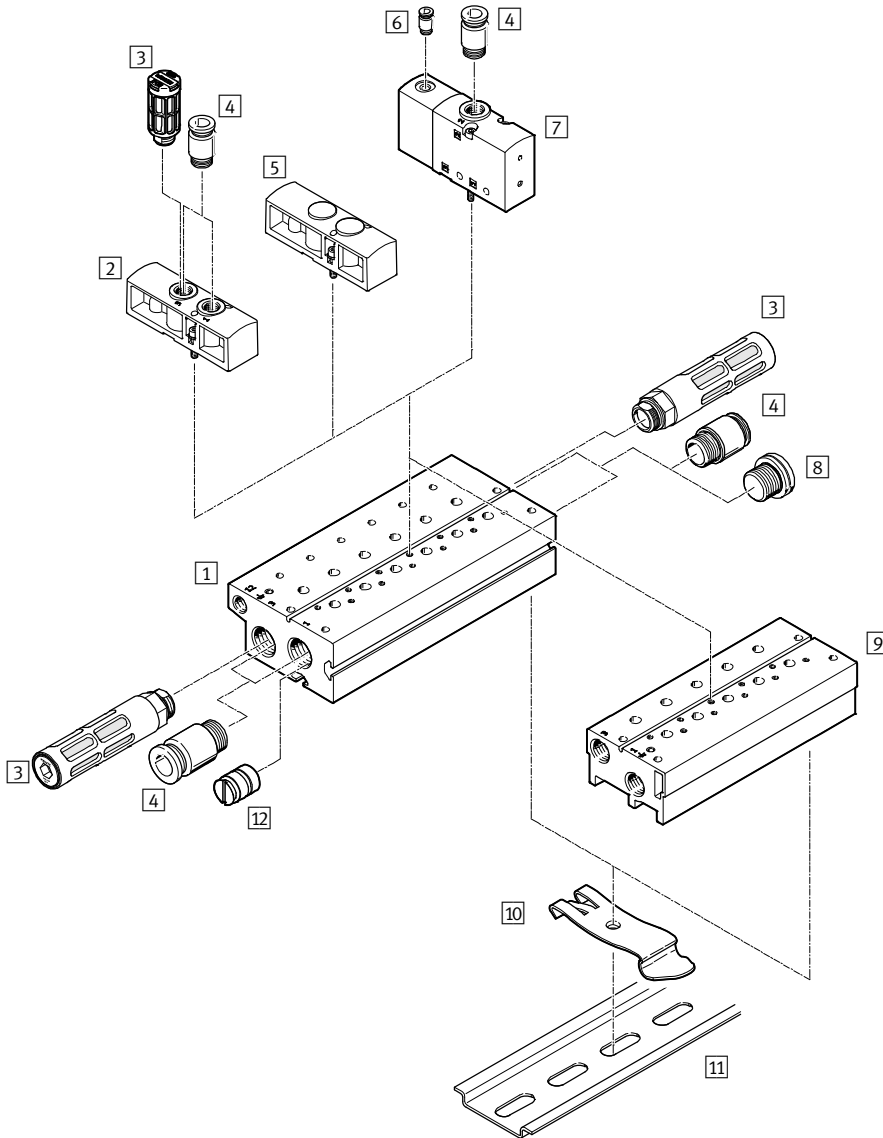

Accessories		
Description	Brief description	→ Page/Internet
1 Standard manifold block	For 3/2-way valves	61, 71, 81
2 Supply plate	For 3/2-way valves	62, 72, 82
3 Silencer	For exhaust ports (3)	64, 46, 84
4 Push-in fitting	For supply/exhaust ports (1, 3)	63, 54, 83
5 Blanking plate	VABB-B10-...	62, 72, 82
6 Push-in fitting	For pilot air port	63, 54, 83
7 Pneumatic valve	3/2-way valve	37, 45, 53
8 Blanking plug	For supply/exhaust ports (1, 3)	64, 74, 84
9 Compact manifold block	For 3/2-way valves	61, 71, 81
10 H-rail mounting	For mounting on standard H-rails	64, 74, 84
11 Standard H-rail	Mounting rail to EN 60715	-
12 Separator	For creating pressure zones (in duct 1 and/or 3)	64, 74, 84

Pneumatic valves VUWS/valve manifold VTUS, NPT

Peripherals overview

Manifold block for 5/2- and 5/3-way valves

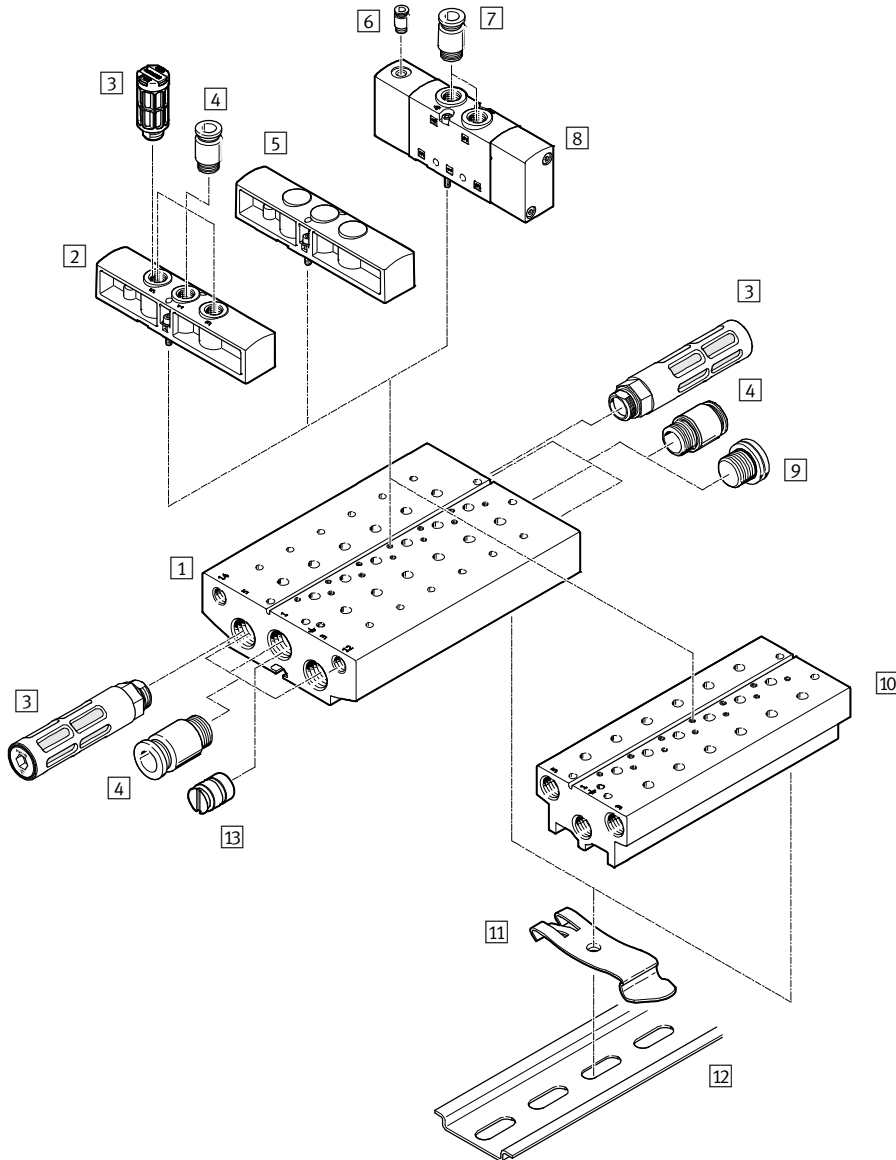

accessories			
Description	Brief description	→ Page/Internet	
1	Standard manifold block	For 5/2- and 5/3-way valves	61, 71, 81
2	Supply plate	For 5/2- and 5/3-way valves	62, 72, 82
3	Silencer	For exhaust ports (5 and/or 3)	64, 46, 84
4	Push-in fitting	For supply/exhaust ports (1, 3, 5)	63, 54, 83
5	Blanking plate	VABB-B10-...	62, 72, 82
6	Push-in fitting	For pilot air port	63, 54, 83
7	Push-in fitting	For working ports (2, 4)	63, 54, 83
8	Pneumatic valve	5/2-way, 5/3-way valve	37, 45, 53
9	Blanking plug	For supply/exhaust ports (1, 3, 5)	64, 74, 84
10	Compact manifold block	For 5/2- and 5/3-way valves	61, 71, 81
11	H-rail mounting	For mounting on standard H-rails	64, 74, 84
12	Standard H-rail	Mounting rail to EN 60715	-
13	Separator	For creating pressure zones (in ducts 1, 3, 5)	64, 74, 84

Pneumatic valves VUWS/valve manifold VTUS, NPT

Peripherals overview

Supply manifold for mounting on both sides

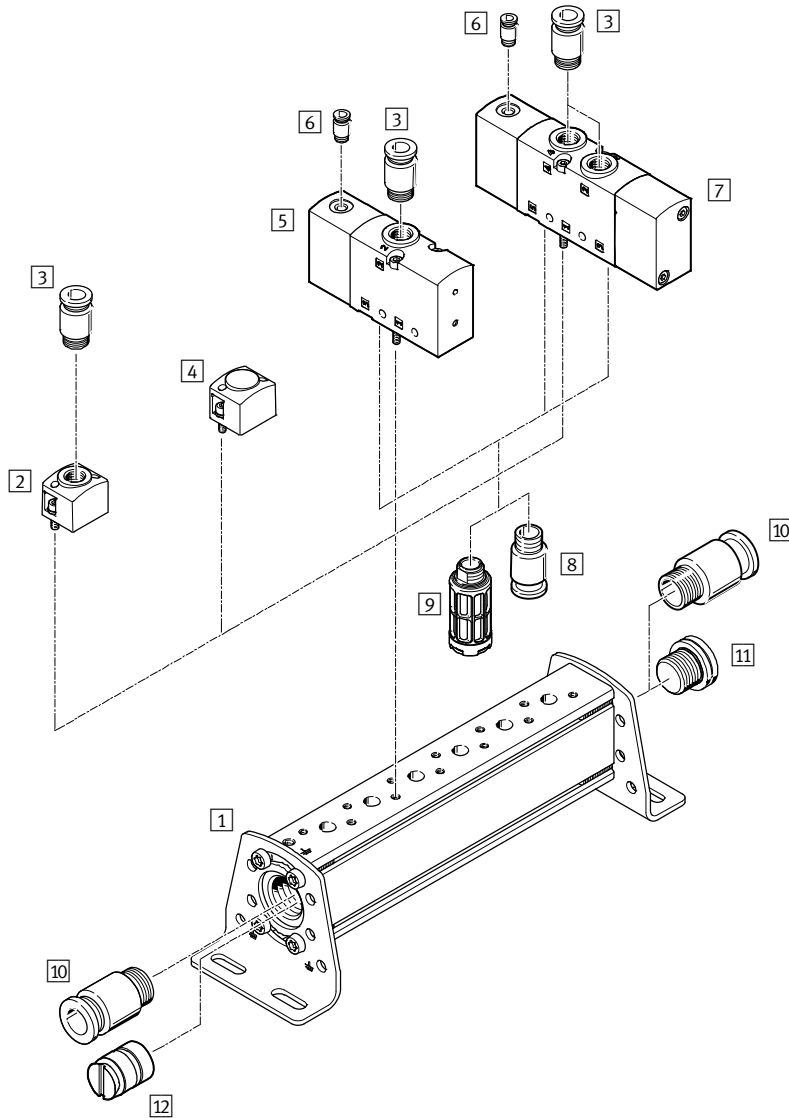

Description	Brief description	→ Page/Internet
1 Supply manifold	For mounting on both sides Mounting bracket can be adjusted through $\pm 30^\circ$	61, 71, 81
2 Supply plate	For supplying air (1) (VABF-B10-...-P1...)	62, 72, 82
3 Push-in fitting	For supplying air (1) for working ports (2, 4)	63, 54, 83
4 Blanking plate	VABB-B10-...	62, 72, 82
5 Pneumatic valve	3/2-way valve	37, 45, 53
6 Push-in fitting	For pilot air port	63, 54, 83
7 Pneumatic valve	5/2-way, 5/3-way valve	37, 45, 53
8 Push-in fitting	For exhaust ports (3, 5)	63, 54, 83
9 Silencer	For exhaust ports (3, 5)	64, 46, 84
10 Push-in fitting	For supplying air (1)	63, 54, 83
11 Blanking plug	For working port (duct 1)	64, 74, 84
12 Separator	For creating pressure zones (in duct 1)	64, 74, 84

Valve manifold VTUS, NPT

Technical data – Valve manifold

-  - Flow rate
Size 20:
Up to 700 l/min
Size 25:
Up to 1300 l/min
Size 30:
Up to 2300 l/min

-  - Valve width
Size 20: 21 mm
Size 25: 26.5 mm
Size 30: 31 mm



General technical data		
Valve manifold configuration		Fixed grid
Size 20	[mm]	21
Size 25	[mm]	26.5
Size 30	[mm]	31
Valve design		Piston spool
Type of reset		Pneumatic or mechanical spring
Pneumatic spring		Internal or external
Direction of flow		Reversible with restrictions
Suitability for vacuum		Yes
Type of pilot control		Direct
Sealing principle		Soft
Max. no. of valve positions		16 (a maximum of 18 valve positions with extension for standard manifold block)
Max. number of pressure zones		9
Exhaust air function		With flow control
Type of actuation		Pneumatic
Standard flow rate		
Size 20	[qnN]	600...700
Size 25	[qnN]	1000...1300
Size 30	[qnN]	1600...2300
Mounting position		Any
CRC ¹⁾		2 ¹⁾
Note on materials		RoHS compliant
Information on materials: seals		HNBR, NBR

1) Corrosion resistance class CRC 2 to Festo standard FN 940070
Moderate corrosion stress. Indoor applications in which condensation may occur. External visible parts with primarily decorative requirements for the surface and which are in direct contact with the ambient atmosphere typical for industrial applications.

Valve manifold VTUS, NPT

Technical data – Valve manifold

Operating and environmental conditions	
Operating medium	Compressed air to ISO 8573-1:2010 [7:4:4]
Pilot medium	Compressed air to ISO 8573-1:2010 [7:4:4]
Note on operating/pilot medium	Lubricated operation possible (in which case lubricated operation will always be required)
Operating pressure [bar]	-0.9 ... +10
Pilot pressure [bar]	1.5 ... 10
Ambient temperature [°C]	-10 ... +50
Temperature of medium [°C]	-10 ... +50
Storage temperature [°C]	-20 ... +60

Valve manifold VTUS, NPT

Technical data – Valve manifold

Dimensions

Download CAD data → www.festo.com

With 3/2-way valves, standard manifold rail

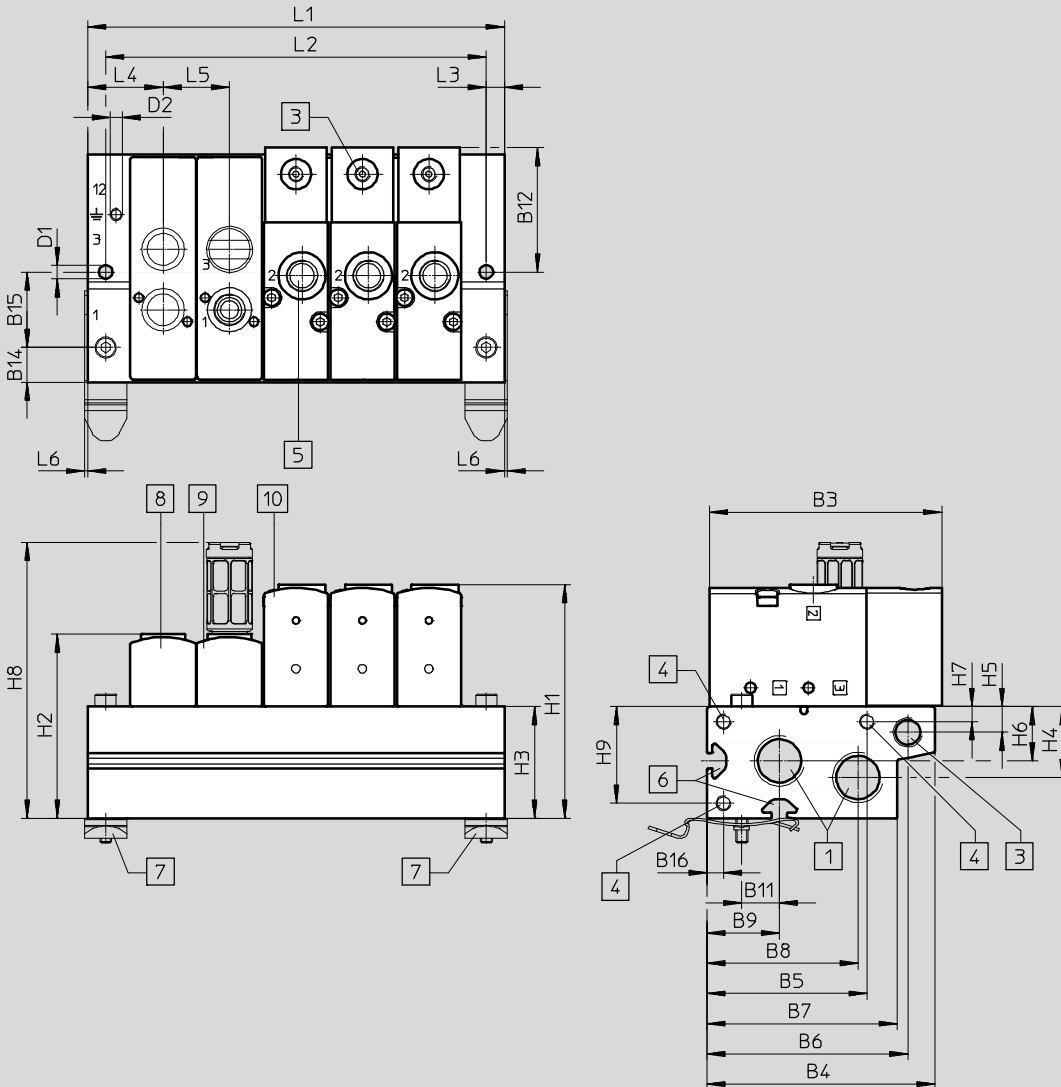

1 Ports 1 and 3 (at both ends):
3/8 NPT for VTUS 20,
1/2 NPT for VTUS 25,
3/4 NPT for VTUS 30

3 Port 12 on the manifold block
at both ends: 1/8 NPT
Port 10 and 12 on the valve:
UNF 10/32 for VTUS 20,
UNF 10/32 for VTUS 25,
1/8 NPT for VTUS 30

4 Thread for extension module:
M5x15.5 for VTUS 20, M5x18
for VTUS 25,
M5x18 for VTUS 30

5 Port 2:
1/8 NPT for VTUS 20,
1/4 NPT for VTUS 25,
3/4 NPT for VTUS 30

6 Profile slot IPM-05 system 5
7 H-rail mounting: VAME-T-M4
for VTUS 20, VAME-T-M5 for
VTUS 25, VAME-T-M6 for
VTUS 30

8 Blanking plate

9 Supply plate, ports 1 and 3:
G1/8 for VTUS 20
G1/4 for VTUS 25
G3/8 for VTUS 30

10 Pneumatic valve, monostable,
3/2

 Note

Port 12 on the manifold rail (number
3 in the dimensional drawing) is not

used when equipped with pneumatic
valves.

Valve manifold VTUS, NPT

Technical data – Valve manifold

Type	B3	B4	B5	B6	B7	B8	B9	B11	B12	B14	B15	B16
VTUS-20	77	75.5	53	66.5	63	50	24	12.5	41.2	11.5	25	5.5
VTUS-25	92	93	67.5	80.5	78	62	30	16	–	14	32	6
VTUS-30	109.2	108.2	79	93.2	94.7	75.7	36.2	19	55.5	17.2	38	6.5

Type	D1 Ø	D2	H1	H2	H3	H4	H5	H6	H7	H8	H9	L3	L4	L5	L6
VTUS-20	4.5	M4x6.5	77.4	61	37	23.5	8.5	18	5	91.4	32	6	25	22	1
VTUS-25	5.5	M4x9	95.5	71	45	25	9	22	5	123.4	39	6	29.8	27.5	1
VTUS-30	6.3	M5x11	118	91	61	35	9	28.5	6.5	170.1	54.5	7.2	34	32	–

Valve positions		2	3	4	5	6	7	8	9	10
VTUS-20	L1 [mm]	72	94	116	138	160	182	204	226	248
	L2 [mm]	60	82	104	126	148	170	192	214	236
VTUS-25	L1 [mm]	87	114.5	142	169.5	197	224.5	252	279.5	307
	L2 [mm]	75	102.5	130	157.5	185	212.5	240	267.5	295
VTUS-30	L1 [mm]	100	132	164	196	228	260	292	324	356
	L2 [mm]	85	117	149	181	213	245	277	309	341

Valve manifold VTUS, NPT

Technical data – Valve manifold

Dimensions – Valve manifold

Download CAD data → www.festo.com

With 3/2-way valves, compact manifold rail

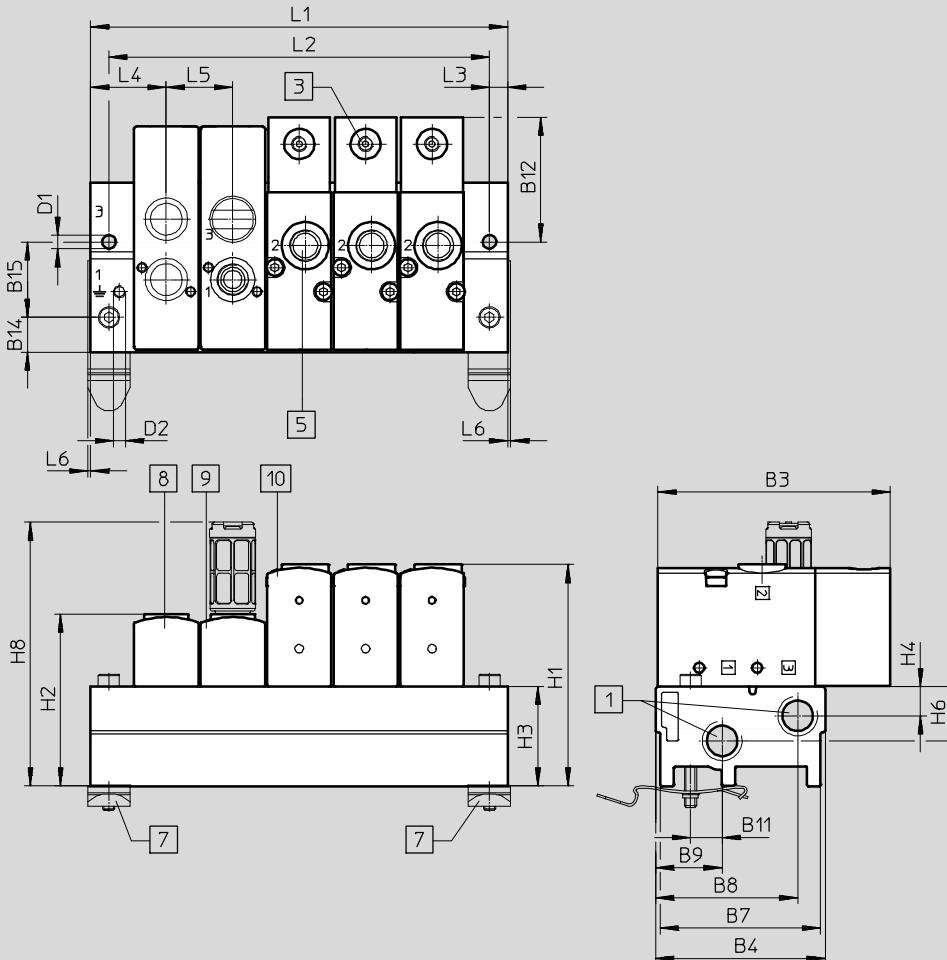

1 Ports 1 and 3 (at both ends):
1/4 NPT for VTUS 20,
3/8 NPT for VTUS 25,
1/2 NPT for VTUS 30

3 Port 10 and 12 on the valve:
UNF 10/32 for VTUS 20,
UNF 10/32 for VTUS 25,
1/8 NPT for VTUS 30

5 Port 2:
1/8 NPT for VTUS 20,
1/4 NPT for VTUS 25,
3/8 NPT for VTUS 30

7 H-rail mounting: VAME-T-M4
for VTUS 20, VAME-T-M5 for
VTUS 25, VAME-T-M6 for
VTUS 30

8 Blanking plate

9 Supply plate, ports 1 and 3:
G1/8 for VTUS 20
G1/4 for VTUS 25
G3/8 for VTUS 30

10 Pneumatic valve, monostable,
3/2

Valve manifold VTUS, NPT

Technical data – Valve manifold

Type	B3	B4	B7	B8	B9	B11	B12	B14	B15
VTUS-20	77	56.1	53.1	47	22	10.5	41.2	11.5	25
VTUS-25	92	70.3	67.3	58.8	30	16	47	14	32
VTUS-30	109.2	83	80	69.4	36	19	55.5	17	38

Type	D1 Ø	D2	H1	H2	H3	H4	H6	H8	L3	L4	L5	L6
VTUS-20	4.5	M4x6.5	73.4	57	33	9.7	18	87.4	6	25	22	1
VTUS-25	5.5	M4x9	84.5	60	34	13.5	20	112.4	6	29.8	27.5	1
VTUS-30	6.3	M5x11	99.5	72.5	42.5	17.5	26	151.6	7.5	38	32	–

Valve positions		2	3	4	5	6	7	8	9	10
VTUS-20	L1 [mm]	72	94	116	138	160	182	204	226	248
	L2 [mm]	60	82	104	126	148	170	192	214	236
VTUS-25	L1 [mm]	87	114.5	142	169.5	197	224.5	252	279.5	307
	L2 [mm]	75	102.5	130	157.5	185	212.5	240	267.5	295
VTUS-30	L1 [mm]	100	132	164	196	228	260	292	324	356
	L2 [mm]	85	117	149	181	213	245	277	309	341

Valve manifold VTUS, NPT

Technical data – Valve manifold

Dimensions – Valve manifold

Download CAD data → www.festo.com

With 5/2- and 5/3-way valves, standard manifold rail

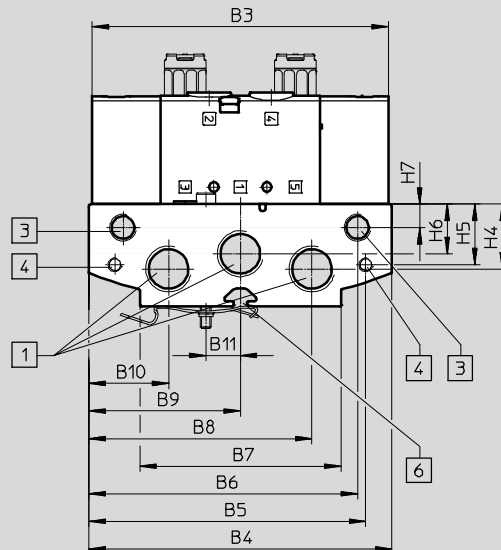
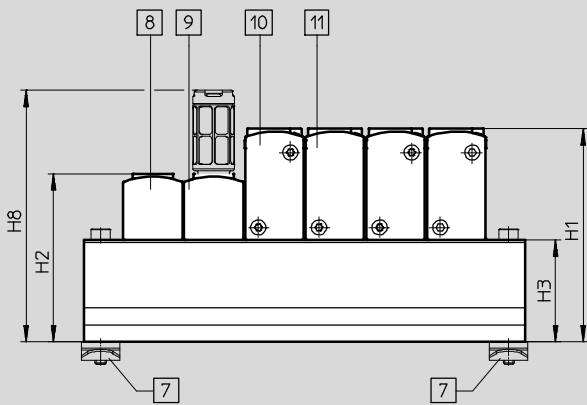
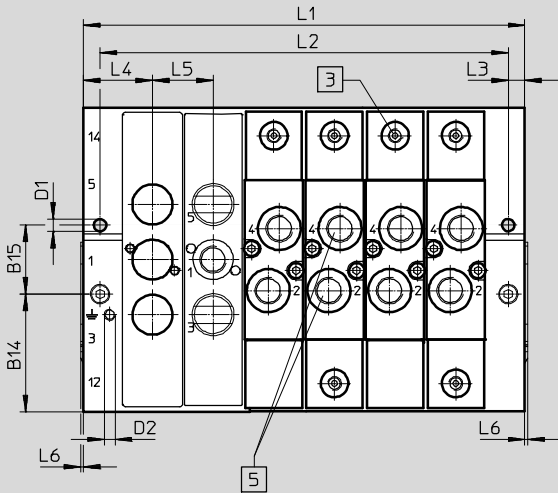

- | | | | |
|--|--|---|--|
| <p>1 Ports 1, 3 and 5 (at both ends):
3/8 NPT for VTUS 20,
1/2 NPT for VTUS 25,
3/4 NPT for VTUS 30</p> <p>3 Port 12 and 14 on the manifold
block at both ends: 1/8 NPT
Port 12 and 14 on the valve:
UNF 10/32 for VTUS 20,
UNF 10/32 for VTUS 25,
1/8 NPT for VTUS 30</p> | <p>4 Thread for extension module:
M5x15.5 for VTUS 20, M5x18
for VTUS 25,
M5x18 for VTUS 30</p> <p>5 Port 2 and 4: 1/8 NPT for
VTUS 20, 1/4 NPT for VTUS 25,
3/4 NPT for VTUS 30</p> | <p>6 Profile slot IPM-05, system 5</p> <p>7 H-rail mounting: VAME-T-M4
for VTUS 20, VAME-T-M5 for
VTUS 25, VAME-T-M6 for
VTUS 30</p> <p>8 Blanking plate</p> | <p>9 Supply plate, port 1, 3 and 5:
G1/8 for VTUS 20, G1/4 for
VTUS 25, G3/8 for VTUS 30</p> <p>10 Pneumatic valve, monostable,
5/2</p> <p>11 Pneumatic valve, bistable, 5/2,
5/3</p> |
|--|--|---|--|

Note

Port 12 on the manifold rail (number 3 in the dimensional drawing) is not used when equipped with pneumatic valves.

Valve manifold VTUS, NPT

Technical data – Valve manifold

Type	B3	B4	B5	B6	B7	B8	B9	B10	B11	B14	B15
VTUS-20	107.4	110	100.5	97.5	73	81	55	29	12.5	42.5	25
VTUS-25	126	126	119	113.5	80	95	63	31	16	47	32
VTUS-30	149	144	137	129	104	111.5	72	32.5	19	53	38

Type	D1 Ø	D2	H1	H2	H3	H4	H5	H6	H7	H8	L3	L4	L5	L6
VTUS-20	4.5	M4x6.5	77.4	61	37	23.5	22	18	8.5	91.4	6	25	22	1
VTUS-25	5.5	M4x9	95.5	71	45	25	22	22	9	123.4	6	29.8	27.5	1
VTUS-30	6.3	M5x11	118	91	61	35	22	28.5	9	170.1	7.5	34	32	–

Valve positions		2	3	4	5	6	7	8	9	10
VTUS-20	L1 [mm]	72	94	116	138	160	182	204	226	248
	L2 [mm]	60	82	104	126	148	170	192	214	236
VTUS-25	L1 [mm]	87	114.5	142	169.5	197	224.5	252	279.5	307
	L2 [mm]	75	102.5	130	157.5	185	212.5	240	267.5	295
VTUS-30	L1 [mm]	100	132	164	196	228	260	292	324	356
	L2 [mm]	85	117	149	181	213	245	277	309	341

Valve manifold VTUS, NPT

Technical data – Valve manifold

Dimensions – Valve manifold

Download CAD data → www.festo.com

With 5/2- and 5/3-way valves, compact manifold rail

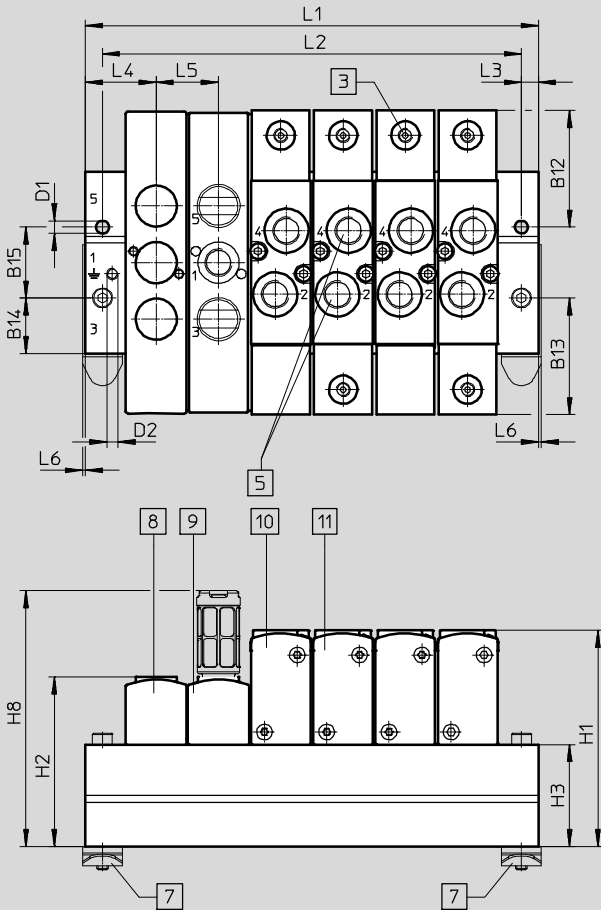

1 Ports 1, 3 and 5 (at both ends):
1/4 NPT for VTUS 20, 3/8 NPT
for VTUS 25, 1/2 NPT for
VTUS 30

3 Port 12 and 14 on the valve:
UNF 10/32 for VTUS 20,
UNF 10/32 for VTUS 25,
1/8 NPT for VTUS 30

5 Port 2 and 4: 1/8 NPT for
VTUS 20, 1/4 NPT for VTUS 25,
3/8 NPT for VTUS 30

7 H-rail mounting: VAME-T-M4
for VTUS 20, VAME-T-M5 for
VTUS 25, VAME-T-M6 for
VTUS 30

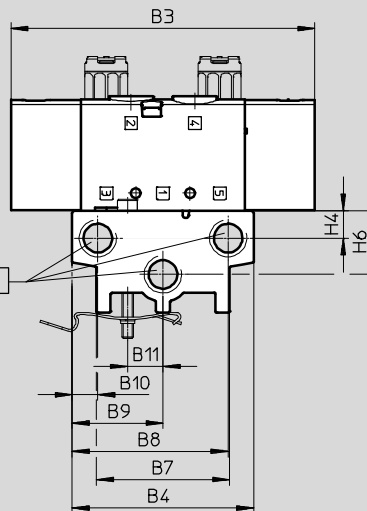

8 Blanking plate
9 Supply plate, ports 1, 3 and 5:
G1/8 for VTUS 20, G1/4 for
VTUS 25, G3/8 for VTUS 30

10 Pneumatic valve, monostable,
5/2

11 Pneumatic valve, bistable, 5/2,
5/3

Valve manifold VTUS, NPT

Technical data – Valve manifold

Type	B3	B4	B7	B8	B9	B10	B11	B12	B13	B14	B15
VTUS-20	107.4	64.2	47	55.1	32.1	9.1	12.5	41.2	41.2	19.6	25
VTUS-25	126	80.5	61.5	69	40.3	11.5	16	47	47	24.3	32
VTUS-30	149	94	77	80.4	47	13.6	19	55.5	55.5	28	38

Type	D1 Ø	D2	H1	H2	H3	H4	H6	H8	L3	L4	L5	L6
VTUS-20	4.5	M4x6.5	76.4	60	36	9.7	22.5	90.4	6	25	22	1
VTUS-25	5.5	M4x9	84.5	60	34	13.5	20	112.1	6	29.8	27.5	1
VTUS-30	6.3	M5x11	99.5	72.5	42.5	17.5	26	151.6	7.5	34	32	–

Valve positions		2	3	4	5	6	7	8	9	10
VTUS-20	L1 [mm]	72	94	116	138	160	182	204	226	248
	L2 [mm]	60	82	104	126	148	170	192	214	236
VTUS-25	L1 [mm]	87	114.5	142	169.5	197	224.5	252	279.5	307
	L2 [mm]	75	102.5	130	157.5	185	212.5	240	267.5	295
VTUS-30	L1 [mm]	100	132	164	196	228	260	292	324	356
	L2 [mm]	85	117	149	181	213	245	277	309	341

Valve manifold VTUS, NPT

Technical data – Valve manifold

Dimensions – Supply manifold

Download CAD data → www.festo.com

Mounting on both sides

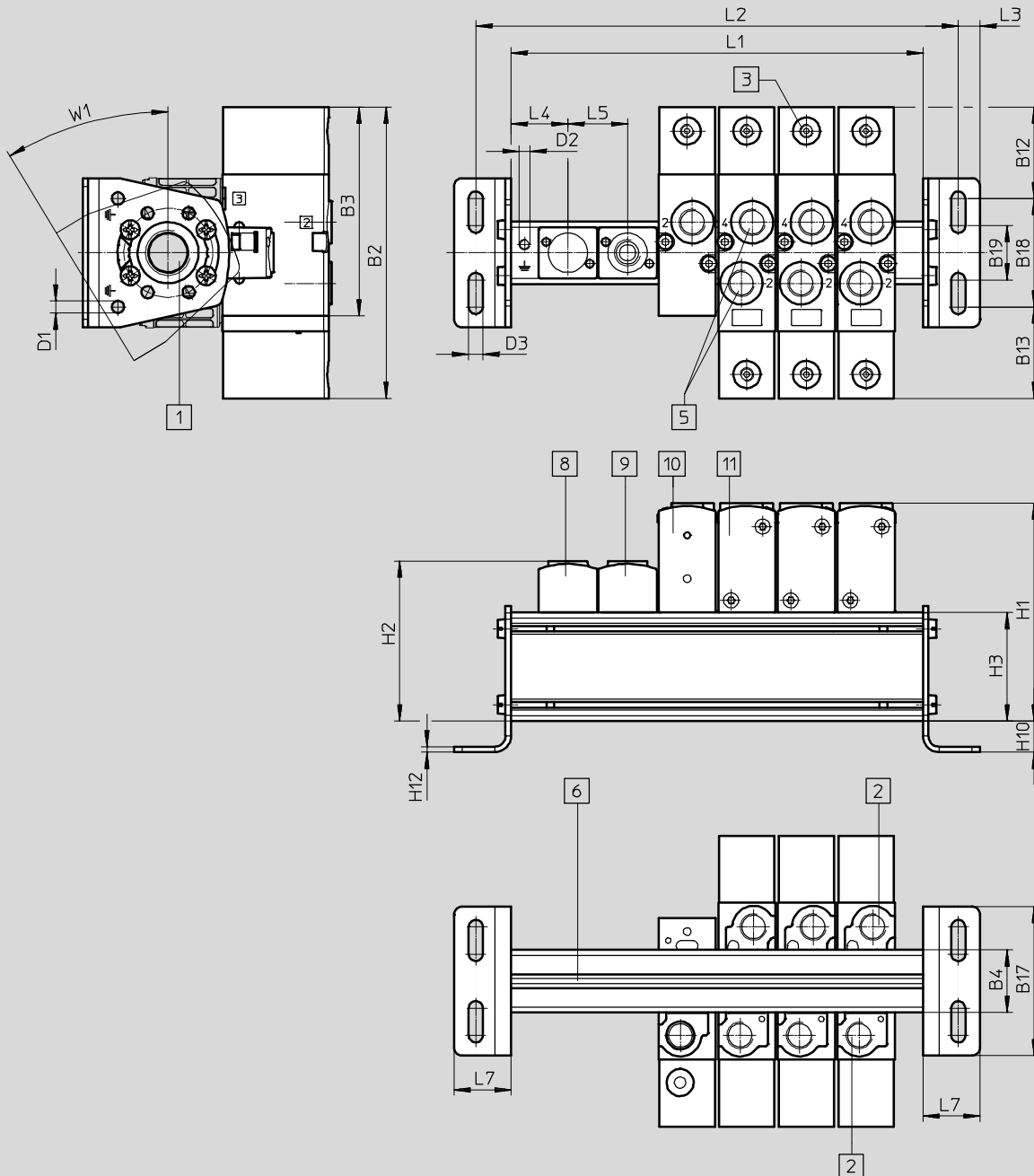

- 1 Port 1 (at both ends): 3/8 NPT for VTUS 20, 1/2 NPT for VTUS 25, 3/4 NPT for VTUS 30
- 2 Port 3 and 5: 1/8 NPT for VTUS 20, 1/4 NPT for VTUS 25, 3/8 NPT for VTUS 30

- 3 Port 12 and 14 on the valve: UNF 10/32 for VTUS 20, UNF 10/32 for VTUS 25, 1/8 NPT for VTUS 30
- 5 Port 2 and 4: 1/8 NPT for VTUS 20, 1/4 NPT for VTUS 25, 3/8 NPT for VTUS 30
- 6 Profile slot IPM-05 system 5

- 8 Blanking plate
- 9 Supply plate, port 1: G1/8 for VTUS 20, G1/4 for VTUS 25, G3/8 for VTUS 30
- 10 Pneumatic valve, monostable, 3/2
- 11 Pneumatic valve, bistable, 5/2, 5/3

- Note

Mounting bracket can be adjusted through $\pm 30^\circ$

Valve manifold VTUS, NPT

Technical data – Valve manifold

Type	B2	B3	B4	B12	B13	B17	B18	B19	H1	H2	H3
VTUS-20	107.4	77	23	33.7	33.7	55	40	20	80.4	59	40
VTUS-25	126	92	28.7	33	33	75	60	35	102.5	78	52
VTUS-30	149	109.2	34	42	42	85	65	35	122	95	65

Type	H10	H12	D1 Ø	D2	D3 Ø	L3	L4	L5	L7	W1
VTUS-20	11.5	2	4.5	M4x6.5	5.2	9	21	22	22	31.3°
VTUS-25	18	2	4.5	M4x9	6.6	8	29.8	27.5	24	30°
VTUS-30	17.5	2.5	5.5	M5x11	8.6	9	34	32	26	28°

Valve positions		2	3	4	5	6	7	8	9	10
VTUS-20	L1 [mm]	64	86	108	130	152	174	196	218	240
	L2 [mm]	90	112	134	156	178	200	222	244	266
VTUS-25	L1 [mm]	87	114.5	142	169.5	197	224.5	252	279.5	307
	L2 [mm]	119	156.5	174	201.5	229	256.5	284	311.5	339
VTUS-30	L1 [mm]	100	132	164	196	228	260	292	324	356
	L2 [mm]	134	166	198	230	262	294	326	358	390

Pneumatic valves VUWS, NPT

Order code – Pneumatic valves

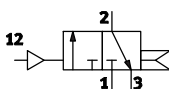
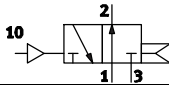
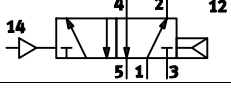
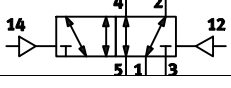
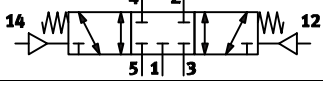
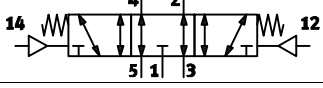
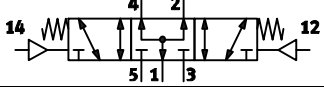
VUWS	-	L	-	-
Valve design				
In-line, individual valve		L		
Valve width				
21 mm			20	
26.5 mm			25	
31 mm			30	
Valve functions				
				M32C¹⁾
				M32U¹⁾
				M52¹⁾
				B52
				P53C
				P53U
				P53E

1) The circuit diagram is a symbolic representation. In the case of M32C, for example, the order code is possible only in combination with -A, -E, -M.

Exhaust	
-	Without fitting
QN	With fitting
U1	Silencer with metal housing
Pneumatic connection	
N18	Thread 1/8 NPT
N14	Thread 1/4 NPT
N38	Thread 3/8 NPT
T532	Push-in connector 5/32"
T14	Push-in connector 1/4"
T516	Push-in connector 5/16"
T38	Push-in connector 3/8"
T12	Push-in connector 1/2"
Type of reset	
-	None (for bistable valves)
A	Pneumatic spring
M	Mechanical spring

Pneumatic valves VUWS, NPT

Technical data – Pneumatic valves, size 20

-  - Flow rate
Up to 700 l/min

-  - Valve width
21 mm



General technical data							
Valve function	3/2		5/2		5/3		
Order code for valves	M32C	M32U	M52	B52	P53C	P53U	P53E
Valve width [mm]	21						
Design	Piston spool						
Pneumatic spring supply	Internal						
Type of pilot control	Direct						
Manual override (MO)	None						
Direction of flow	Reversible with restrictions (not reversible: identified by A in type code)						
Non-overlapping	Yes						
Sealing principle	Soft						
Type of mounting	Optionally via through-holes ¹⁾ or on manifold rail						
Standard nominal flow rate [qnN]	700		700		700	600	600
Through-holes (nominal width) [mm]	5.7		5.7		5.0	4.8	4.5
Product weight [g]	145		178/190 ²⁾	211	207	207	207
Type of actuation	Pneumatic						
Mounting position	Any						
Exhaust air function	With flow control						
Venting hole	Not ducted						
Pneumatic connection 1, 2, 4, 3, 5	1/8 NPT						
Pneumatic spring connection 12/14, 10	UNF 10/32						

1) If several valves are to be screwed together via the through-holes to form a block, a minimum distance of 0.3 mm must be ensured by placing spacer discs between them.

2) With external pneumatic spring: 190 g, with internal pneumatic spring or mechanical spring: 178 g

Technical data – 3/2-way valves					
Order code for valves	M32C			M32U	
Normal position	Closed			Open	
Stable positions	Monostable			Monostable	
Reset method	Pneumatic spring		Mechanical spring (supported internally by pneumatic spring)	Pneumatic spring	Mechanical spring (supported internally by pneumatic spring)
Switching times	On	7	10	7	10
	Off	15	28	15	28

Pneumatic valves VUWS, NPT

Technical data – Pneumatic valves, size 20

Technical data – 5/2-way valves				
Order code for valves	M52		B52	
Stable positions	Monostable			Bistable
Reset method	Pneumatic spring		Mechanical spring	–
Switching times	On	13	7	–
	Off	26	39	–
	Change-over	–	–	6

Technical data – 5/3-way valves				
Order code for valves	P53C		P53U	P53E
Stable positions	Monostable			
Reset method	Mechanical spring			
Switching times	On	10	10	10
	Off	44	43	46
	Change-over	26	21	21

Safety characteristics	
Note on forced checking procedure	Min. 1/week
Resistance to shocks	Shock test with severity level 2 to FN 942017-5 and EN 60068-2-27
Vibration resistance	Transport application test with severity level 2 to FN 942017-4 and EN 60068-2-6

Operating and environmental conditions					
Valve function	M32 ... A M32 ... M	M52-A	M52-M	B52	P53
Operating medium	Compressed air to ISO 8573-1:2010 [7:4:4]				
Pilot medium	Compressed air to ISO 8573-1:2010 [7:4:4]				
Note on operating/pilot medium	Lubricated operation possible (in which case lubricated operation will always be required)				
Operating pressure [bar]	2.5 ... 10	2.5 ... 10	–0.9 ... +10	–0.9 ... +10	–0.9 ... +10
Pilot pressure [bar]	2.5 ... 10	2.5 ... 10	2.5 ... 10	1.5 ... 10	2.5 ... 10
Ambient temperature [°C]	–10 ... +60				
Temperature of medium [°C]	–10 ... +60				
Corrosion resistance class CRC ¹⁾	2				

1) Corrosion resistance class CRC 2 to Festo standard FN 940070
Moderate corrosion stress. Indoor applications in which condensation may occur. External visible parts with primarily decorative requirements for the surface and which are in direct contact with the ambient atmosphere typical for industrial applications.

Information on materials	
Housing	Die-cast aluminium
Piston spool	Wrought aluminium alloy (P53 types: high-alloy stainless steel)
Seals	HNBR, NBR
Note on materials	RoHS compliant

Special features of pneumatic 3/2-way valves

Reset: mechanical spring

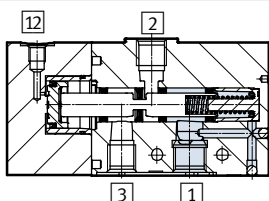

- Internal pneumatic spring
- Faster switch-off time
 - In the case of dual-pressure operation, the higher pressure must always be present at port 1
 - Pressure on port 2 not permitted

Pneumatic valves VUWS, NPT

Technical data – Pneumatic valves, size 20

Dimensions

Download CAD data → www.festo.com

3/2-way valve, normally closed/open

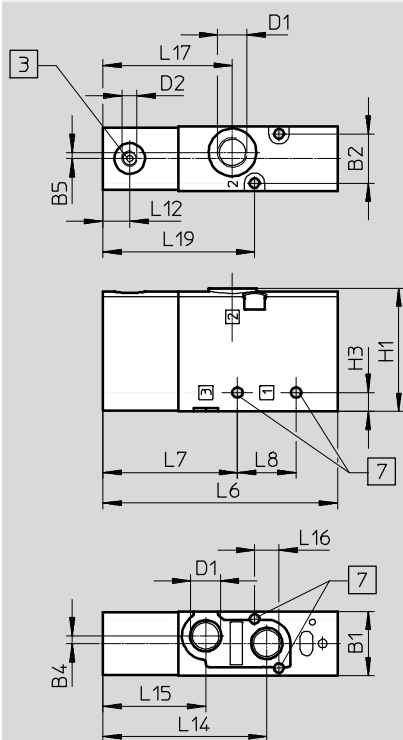

- 3 Port 10: for pilot air (...-M32U-...)
- Port 12: for pilot air (...-M32C-...)
- 7 For mounting screw M3

Type	B1	B2	B4	B5	D1	D2	H1	H3
VUWS-L20-M32C-...-N18	21.1	16.1	2.5	2	1/8 NPT	UNF 10/32	40.4	6.2
VUWS-L20-M32U-...-N18								

Type	L6	L7	L8	L10	L12	L14	L15	L16	L17	L19
VUWS-L20-M32C-...-N18	77	44.1	19.2	-	8.8	53.7	33.7	8	42.5	49.7
VUWS-L20-M32U-...-N18										

Pneumatic valves VUWS, NPT

Technical data – Pneumatic valves, size 20

Dimensions

Download CAD data → www.festo.com

5/2-way valve, monostable

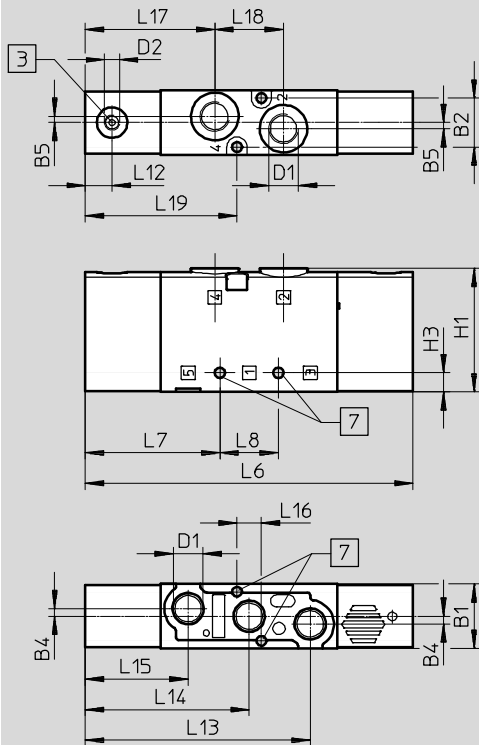

- 3 Port 14: for pilot air (-M52-A...)
- 7 For mounting screw M3

Type	B1	B2	B4	B5	D1	D2	D3	H1	H3
VUWS-L20-M52-...-N18	21.1	16.1	2.5	2	1/8 NPT	UNF 10/32	M5	40.4	6.2

Type	L6	L7	L8	L10	L12	L13	L14	L15	L16	L17	L18	L19
VUWS-L20-M52-...-N18	107.4	44.1	19.2	98.6	8.8	73.7	53.7	33.7	8	42.5	22.5	49.7

Pneumatic valves VUWS, NPT

Technical data – Pneumatic valves, size 20

Dimensions

Download CAD data → www.festo.com

5/2-way valve, bistable, 5/3-way valve

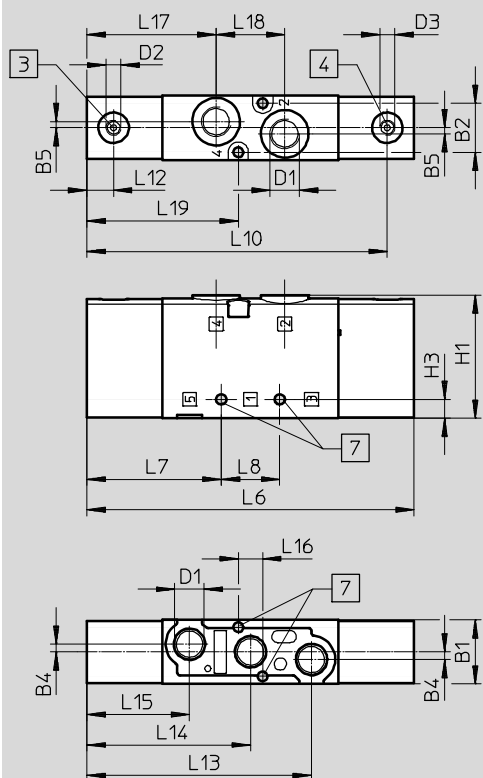

- 3 Port 14: for pilot air
- 4 Port 12: for pilot air
- 7 For mounting screw M3

Type	B1	B2	B4	B5	D1	D2	D3	H1	H3
VUWS-L20-P53...-M-N18	21.1	16.1	2.5	2	1/8 NPT	UNF 10/32	UNF 10/32	40.4	6.2
VUWS-L20-B52-N18									

Type	L6	L7	L8	L10	L12	L13	L14	L15	L16	L17	L18	L19
VUWS-L20-P53...-M-N18	107.4	44.1	19.2	98.6	8.8	73.7	53.7	33.7	8	42.5	22.5	49.7
VUWS-L20-B52-N18												

Pneumatic valves VUWS, NPT

Accessories – Pneumatic valves, size 20

Dimensions

Foot mounting

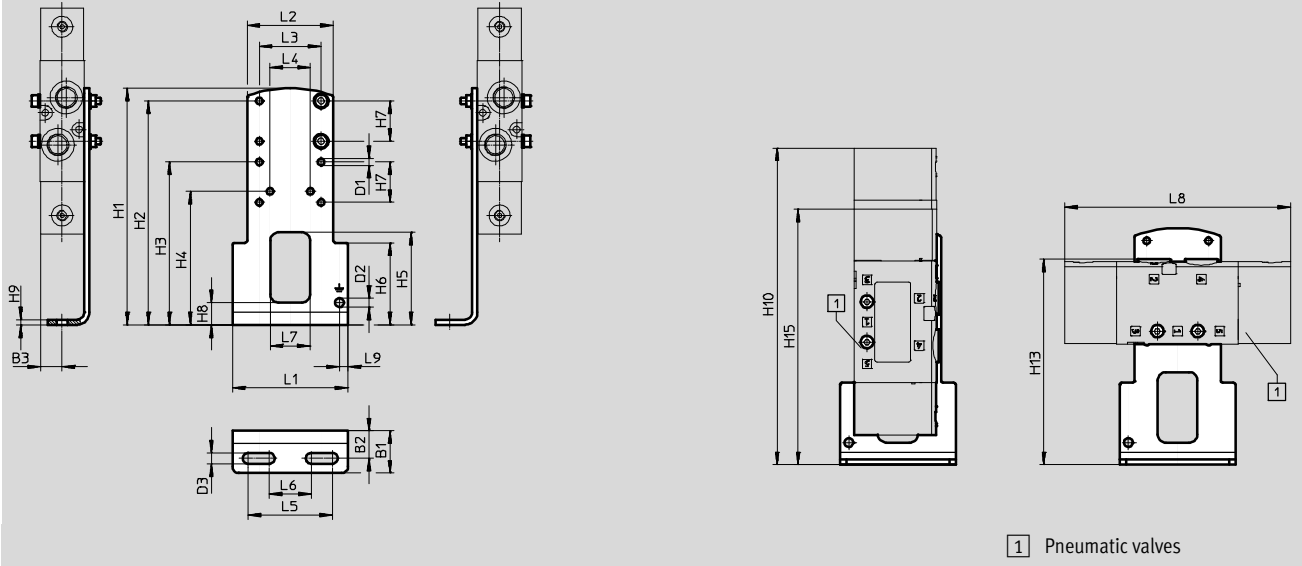

Type		B1	B2	B3	D1 Ø	D2 Ø	D3 Ø	H1	H2	H3	H4	H5	H6	H7	H8
VAME-B10-20-A	VUWS-L20-B52/P53	20	13.1	10.6	3.2	4.2	5.2	112.5	106.5	77.5	63.5	44	39	19.2	10.5
	VUWS-L20-M52														
	VUWS-L20-M32														

Type		H9	H10	H11	H12	L1	L2	L3	L4	L5	L6	L7	L8	L9
VAME-B10-20-A	VUWS-L20-B52/P53	2.5	150.6	97.7	121.6	55	41	29.4	19.2	40	20	19	107.4	4.1
	VUWS-L20-M52		150.6										107.4	
	VUWS-L20-M32		120.2										77	

Dimensions

Wall mounting

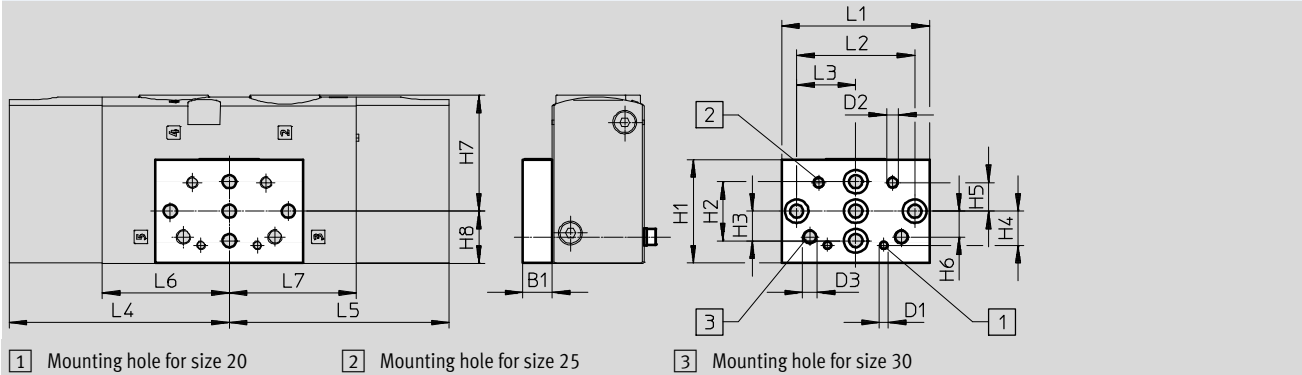

Type		B1	D1	D2	D3	H1	H2	H3	H4	H5	H6	H7	H8	L1	L2	L3	L4	L5	L6	L7	
VAME-B10-20-W	VUWS-L20-B52/P53	10	M3	M4	M5	35	20	10	11.5	9.7	8.7	22.7	17.7	50	40	20	53.7	53.7	28.9	28.9	
	VUWS-L20-M52																				
	VUWS-L20-M32																	-			23.3

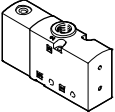
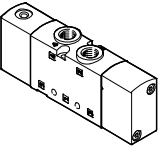
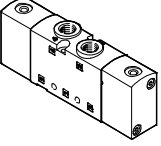

Pneumatic valves VUWS, NPT

Ordering data – Pneumatic valves, size 20



Ordering data – Pneumatic valves			
	Code	Valve function	Part No. Type
Pneumatic valves, threaded connection NPT			
	3/2-way valve, monostable, closed		
	M32C-A	Pneumatic spring return, internal pneumatic spring, direction of flow not reversible	575696 VUWS-L20-M32C-A-N18
	M32C-M	Mechanical spring return, supported by internal pneumatic spring, direction of flow reversible	575697 VUWS-L20-M32C-M-N18
	3/2-way valve, monostable, open		
	M32U-A	Pneumatic spring return, internal pneumatic spring, direction of flow not reversible	575700 VUWS-L20-M32U-A-N18
	M32U-M	Mechanical spring return, supported by internal pneumatic spring, direction of flow reversible	575701 VUWS-L20-M32U-M-N18
	5/2-way valve, monostable		
	M52-A	Pneumatic spring return, internal pneumatic spring, direction of flow not reversible	575703 VUWS-L20-M52-A-N18
	M52-M	Mechanical spring return, direction of flow reversible	575705 VUWS-L20-M52-M-N18
	5/2-way valve, bistable		
	B52	Direction of flow reversible	575707 VUWS-L20-B52-N18
	5/3-way valve		
	P53C	Closed, mechanical spring return, direction of flow reversible	575709 VUWS-L20-P53C-M-N18
	P53E	Exhausted, mechanical spring return, direction of flow reversible	575713 VUWS-L20-P53E-M-N18
	P53U	Pressurised, mechanical spring return, direction of flow reversible	575711 VUWS-L20-P53U-M-N18

Pneumatic valves VUWS, NPT

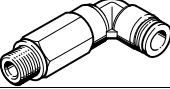
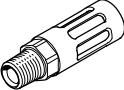
Accessories – Pneumatic valves, size 20

Ordering data					
	Description	Part No.	Type	PU ¹⁾	
Push-in fitting with internal hex					
	Connecting thread 10-32 UNF for tubing O.D.	5/32 "	572312	QBM-10-32-UNF-5/32-I-U	10
	Connecting thread 1/8 NPT for tubing O.D.	5/32 "	572317	QB-1/8-5/32-I-U	10
		1/4 "	572318	QB-1/8-1/4-I-U	10
		5/16 "	572319	QB-1/8-5/16-I-U	10
Angled push-in fitting with external hex					
	Connecting thread 1/8 NPT for tubing O.D.	5/32 "	533290	QBL-1/8-5/32-U	10
		1/4 "	533292	QBL-1/8-1/4-U	10
		5/16 "	533293	QBL-1/8-5/16-U	10
Angled push-in fitting, long, with external hex					
	Connecting thread 1/8 NPT for tubing O.D.	5/32 "	564668	QBLL-1/8-5/32-U	10
		1/4 "	564670	QBLL-1/8-1/4-U	10
		5/16 "	564671	QBLL-1/8-5/16-U	10
Silencer					
	With connecting thread NPT (metal design)	1/8 NPT	12638	U-1/8-B-NPT	1

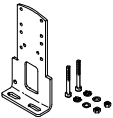
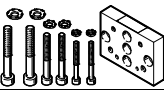
1) Packaging unit

Ordering data					
Description	Weight [g]	Part No.	Type		
Foot mounting					
	Set for mounting valves, comprising: <ul style="list-style-type: none"> • Mounting bracket and • Screw set for mounting 	97	576412	VAME-B10-20-A	
Wall mounting					
	Set for mounting valves for size 20, 25, 30, comprising: <ul style="list-style-type: none"> • Wall mounting and • Screw set for mounting 	53	576413	VAME-B10-20-W	
Set of spare parts					
	Set comprising: <ul style="list-style-type: none"> • Seals and • Screws 	10	8026203	VAME-B10-20-MK	

Pneumatic valves VUWS, NPT

Technical data – Pneumatic valves, size 25

-  - Flow rate
Up to 1300 l/min

-  - Valve width
26.5 mm



General technical data							
Valve function	3/2		5/2		5/3		
Order code for valves	M32C	M32U	M52	B52	P53C	P53U	P53E
Valve width [mm]	26.5						
Design	Piston spool						
Pneumatic spring supply	Internal						
Type of pilot control	Direct						
Manual override (MO)	None						
Direction of flow	Reversible with restrictions (not reversible: identified by A in type code)						
Non-overlapping	Yes						
Sealing principle	Soft						
Type of mounting	Optionally via through-holes ¹⁾ or on manifold rail						
Standard nominal flow rate [qnN]	1000	1000	1300	1300	1200	1000	1000
Through-holes (nominal width) [mm]	6.3	6.3	6.9	6.9	6.3	6.3	6.3
Product weight [g]	268	268	330/360 ²⁾	363	364	364	364
Type of actuation	Pneumatic						
Mounting position	Any						
Exhaust air function	With flow control						
Venting hole	Not ducted						
Pneumatic connection 1, 2, 4, 3, 5	1/4 NPT						
Pneumatic spring connection 12/14, 10	UNF 10/32						

1) If several valves are to be screwed together via the through-holes to form a block, a minimum distance of 0.3 mm must be ensured by placing spacer discs between them.

2) With external pneumatic spring: 360 g, with internal pneumatic spring or mechanical spring: 330 g

Technical data – 3/2-way valves				
Order code for valves	M32C		M32U	
Normal position	Closed		Open	
Stable positions	Monostable		Monostable	
Reset method	Pneumatic spring		Mechanical spring	
Switching times	On	10	10	10
	Off	25	43	43

Pneumatic valves VUWS, NPT

Technical data – Pneumatic valves, size 25

Technical data – 5/2-way valves				
Order code for valves		M52		B52
Stable positions		Monostable		Bistable
Reset method		Pneumatic spring	Mechanical spring	–
Switching times	On	15	10	–
	Off	32	42	–
	Change-over	–	–	10

Technical data – 5/3-way valves				
Order code for valves		P53C	P53U	P53E
Stable positions		Monostable		
Reset method		Mechanical spring		
Switching times	On	13	13	13
	Off	65	65	65
	Change-over	30	30	30

Safety characteristics	
Note on forced checking procedure	Min. 1/week
Resistance to shocks	Shock test with severity level 2 to FN 942017-5 and EN 60068-2-27
Vibration resistance	Transport application test with severity level 2 to FN 942017-4 and EN 60068-2-6

Operating and environmental conditions						
Valve function	M32 ... A	M32 ... M	M52-A	M52-M	B52	P53
Operating medium	Compressed air to ISO 8573-1:2010 [7:4:4]					
Pilot medium	Compressed air to ISO 8573-1:2010 [7:4:4]					
Note on operating/pilot medium	Lubricated operation possible (in which case lubricated operation will always be required)					
Operating pressure [bar]	2.5 ... 10	–0.9 ... +10	2.5 ... 10	–0.9 ... +10	–0.9 ... +10	–0.9 ... +10
Pilot pressure [bar]	2.5 ... 10	2.5 ... 10	2.5 ... 10	2.5 ... 10	1.5 ... 10	2.5 ... 10
Ambient temperature [°C]	–10 ... +60					
Temperature of medium [°C]	–10 ... +60					
Corrosion resistance class CRC ¹⁾	2					

1) Corrosion resistance class CRC 2 to Festo standard FN 940070
Moderate corrosion stress. Indoor applications in which condensation may occur. External visible parts with primarily decorative requirements for the surface and which are in direct contact with the ambient atmosphere typical for industrial applications.

Information on materials	
Housing	Die-cast aluminium
Piston spool	Wrought aluminium alloy
Seals	HNBR, NBR
Note on materials	RoHS compliant

Pneumatic valves VUWS, NPT

Technical data – Pneumatic valves, size 25

Dimensions

Download CAD data → www.festo.com

3/2-way valve, normally closed/open

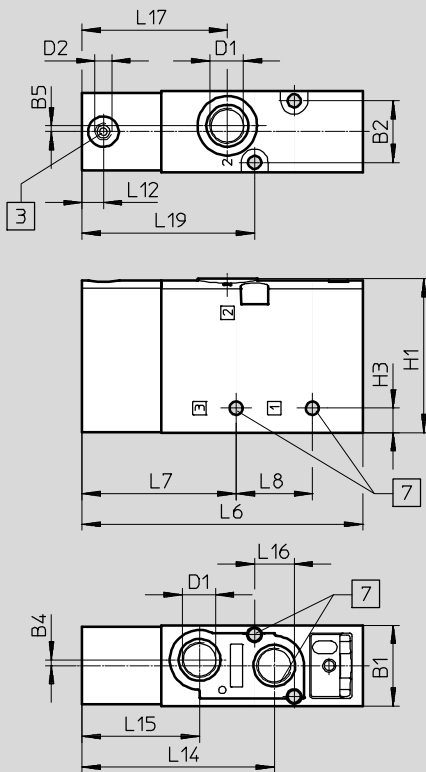

- 3 Port 10: for pilot air (...-M32U-...)
- Port 12: for pilot air (...-M32C-...)
- 7 For mounting screw M4

Type	B1	B2	B3	B4	B5	D1	D2	H1	H3
VUWS-L25-M32C-...-N14	26.5	20.2	1.9	1.9	1.9	1/4 NPT	UNF 10/32	50.5	8
VUWS-L25-M32U-...-N14									

Type	L6	L7	L8	L12	L14	L15	L16	L17	L19
VUWS-L25-M32C-...-N14	92	50.5	25	7	63	38.5	13	47.6	56.5
VUWS-L25-M32U-...-N14									

Pneumatic valves VUWS, NPT

Technical data – Pneumatic valves, size 25



Dimensions

Download CAD data → www.festo.com

5/2-way valve, monostable

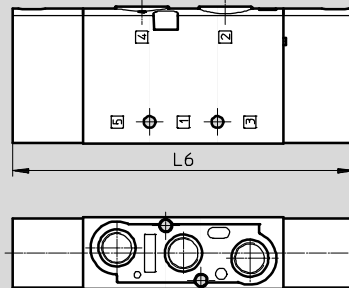
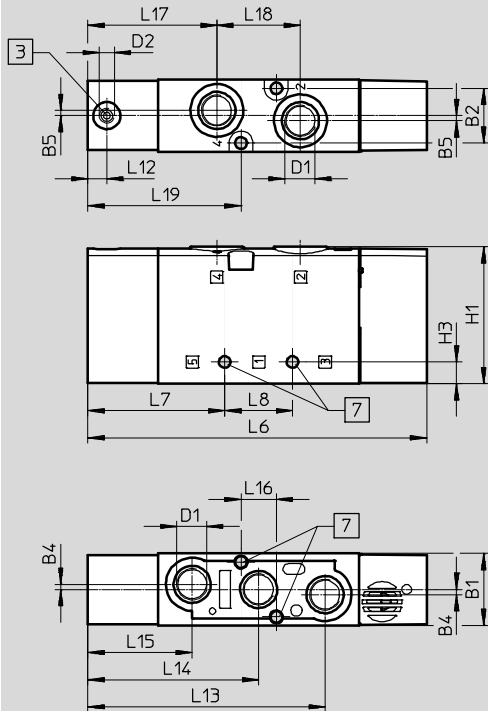

- 3 Port 14: for pilot air (-M52-A-...)
- 7 For mounting screw M4

Type	B1	B2	B4	B5	D1	D2	H1	H3
VUWS-L25-M52-...-N14	26.5	20.2	1.9	1.9	1/4 NPT	UNF 10/32	50.5	8

Type	L6	L7	L8	L12	L13	L14	L15	L16	L17	L18	L19
VUWS-L25-M52-...-N14	125	50.5	25	7	87.5	63	38.5	13	47.6	30.8	56.5

Pneumatic valves VUWS, NPT

Technical data – Pneumatic valves, size 25

Dimensions

Download CAD data → www.festo.com

5/2-way valve, bistable, 5/3-way valve

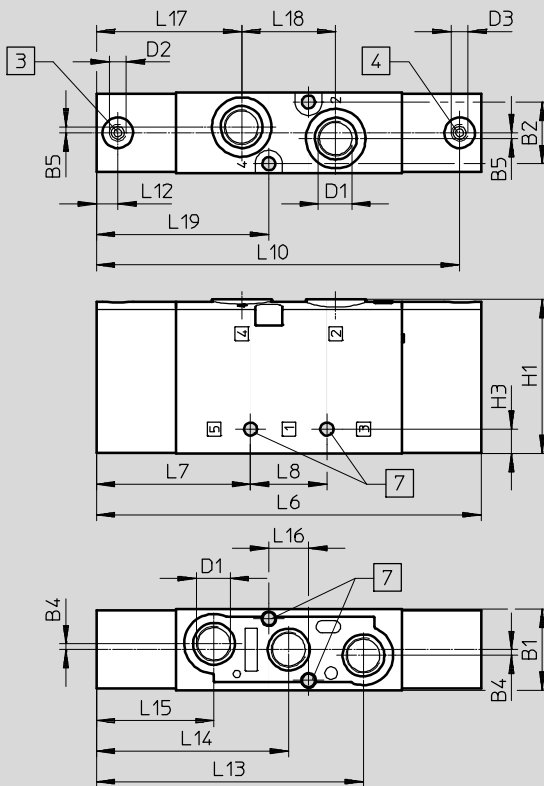

- 3 Port 14: for pilot air
- 4 Port 12: for pilot air
- 7 For mounting screw M4

Type	B1	B2	B4	B5	D1	D2	D3	H1	H3
VUWS-L25-P53...-M-N14	26.5	20.2	1.9	1.9	1/4 NPT	UNF 10/32	UNF 10/32	50.5	8
VUWS-L25-B52-N14									

Type	L6	L7	L8	L10	L12	L13	L14	L15	L16	L17	L18	L19
VUWS-L25-P53...-M-N14	126	50.5	25	119	7	87.5	63	38.5	13	47.6	30.8	56.5
VUWS-L25-B52-N14												

Pneumatic valves VUWS, NPT

Accessories – Pneumatic valves, size 25

Dimensions

Foot mounting

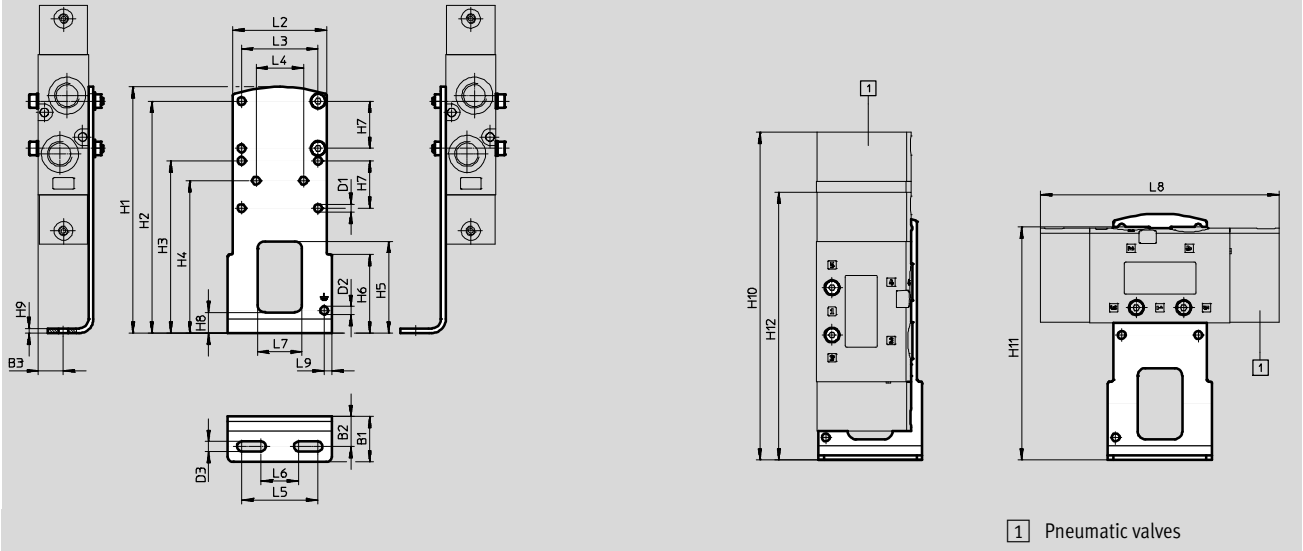

1 Pneumatic valves

Type		B1	B2	B3	D1 Ø	D2 Ø	D3 Ø	H1	H2	H3	H4	H5	H6	H7
VAME-B10-25-A	VUWS-L25-B52/P53	24	15.8	13.3	4.2	4.2	5.2	130	122.5	91	80.5	48.5	41.5	25
	VUWS-L25-M52													
	VUWS-L25-M32													

Type		H8	H9	H10	H11	H12	L1	L2	L3	L4	L5	L6	L7	L8	L9
VAME-B10-25-A	VUWS-L25-B52/P53	11	2.5	173	123	141.5	55	49.4	40.4	25	40	20	23.5	126	4.1
	VUWS-L25-M52			173										126	
	VUWS-L25-M32			139										92	

Dimensions

Wall mounting

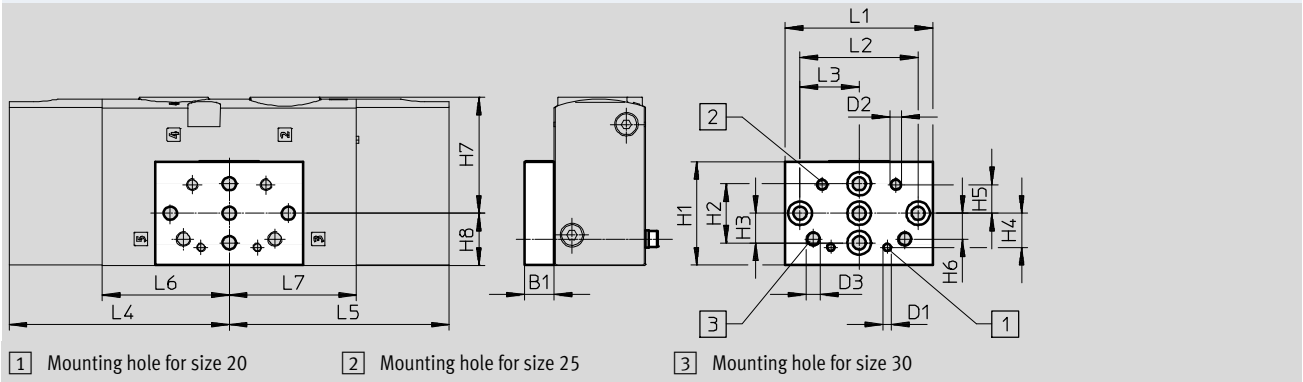

1 Mounting hole for size 20

2 Mounting hole for size 25

3 Mounting hole for size 30

Type		B1	D1	D2	D3	H1	H2	H3	H4	H5	H6	H7	H8	L1	L2	L3	L4	L5	L6	L7
VAME-B10-20-W	VUWS-L25-B52/P53	10	M3	M4	M5	35	20	10	11.5	9.7	8.7	32.8	17.7	50	40	20	63	63	37	37
	VUWS-L25-M52																	62		37
	VUWS-L25-M32																	-		29

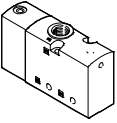
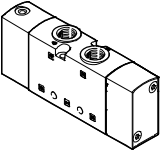
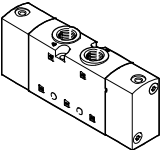

Pneumatic valves VUWS, NPT

Ordering data – Pneumatic valves, size 25

Ordering data – Pneumatic valves				
	Code	Valve function	Part No.	Type
Pneumatic valves				
	3/2-way valve, monostable, closed			
	M32C-A	Pneumatic spring return, internal pneumatic spring, direction of flow not reversible	575546	VUWS-L25-M32C-A-N14
	M32C-M	Mechanical spring return, internal pneumatic spring, direction of flow reversible	575547	VUWS-L25-M32C-M-N14
	3/2-way valve, monostable, open			
	M32U-A	Pneumatic spring return, internal pneumatic spring, direction of flow not reversible	575550	VUWS-L25-M32U-A-N14
	M32U-M	Mechanical spring return, internal pneumatic spring, direction of flow reversible	575551	VUWS-L25-M32U-M-N14
	5/2-way valve, monostable			
	M52-A	Pneumatic spring return, internal pneumatic spring, direction of flow not reversible	575553	VUWS-L25-M52-A-N14
	M52-M	Mechanical spring return, direction of flow reversible	575555	VUWS-L25-M52-M-N14
	5/2-way valve, bistable			
	B52	Direction of flow reversible	575557	VUWS-L25-B52-N14
	5/3-way valve			
	P53C	Closed, mechanical spring return, direction of flow reversible	575559	VUWS-L25-P53C-M-N14
	P53E	Exhausted, mechanical spring return, direction of flow reversible	575563	VUWS-L25-P53E-M-N14
	P53U	Pressurised, mechanical spring return, direction of flow reversible	575561	VUWS-L25-P53U-M-N14

Pneumatic valves VUWS, NPT

Accessories – Pneumatic valves, size 25

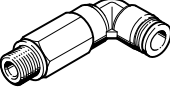
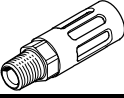
Ordering data					
	Description		Part No.	Type	PU ¹⁾
Push-in fitting with internal hex					
	Connecting thread 10-32 UNF for tubing O.D.	5/32 "	572312	QBM-10-32-UNF-5/32-I-U	10
	Connecting thread 1/4 NPT for tubing O.D.	1/4 "	572320	QB-1/4-1/4-I-U	10
		5/16 "	572321	QB-1/4-5/16-I-U	10
		3/8 "	572322	QB-1/4-3/8-I-U	10
Angled push-in fitting with external hex					
	Connecting thread 1/4 NPT for tubing O.D.	1/4 "	533295	QBL-1/4-1/4-U	10
		5/16 "	533296	QBL-1/4-5/16-U	10
		3/8 "	533297	QBL-1/4-3/8-U	5
Angled push-in fitting, long, with external hex					
	Connecting thread 1/4 NPT for tubing O.D.	1/4 "	564674	QBLL-1/4-1/4-U	10
		5/16 "	564675	QBLL-1/4-5/16-U	10
		3/8 "	564676	QBLL-1/4-3/8-U	5
Silencer					
	With connecting thread NPT (metal design)	1/4 NPT	12639	U-1/4-B-NPT	1

1) Packaging unit

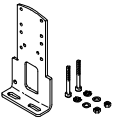
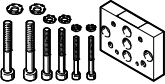
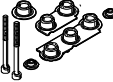
Ordering data				
Description		Weight [g]	Part No.	Type
Foot mounting				
	Set for mounting valves, comprising: <ul style="list-style-type: none"> • Mounting bracket and • Screw set for mounting 	130	2293485	VAME-B10-25-A
Wall mounting				
	Set for mounting valves for size 20, 25, 30, comprising: <ul style="list-style-type: none"> • Wall mounting and • Screw set for mounting 	53	576413	VAME-B10-20-W
Set of spare parts				
	Set comprising: <ul style="list-style-type: none"> • Seals and • Screws 	12	8035636	VAME-B10-25-MK

Pneumatic valves VUWS, NPT

Technical data – Pneumatic valves, size 30

 Flow rate
 Up to 2300 l/min

 Valve width
 31 mm



General technical data							
Valve function	3/2		5/2		5/3		
Order code for valves	M32C	M32U	M52	B52	P53C	P53U	P53E
Valve width [mm]	31						
Design	Piston spool						
Pneumatic spring supply	Internal or external						
Type of pilot control	Direct						
Manual override (MO)	None						
Direction of flow	Reversible with restrictions (not reversible: identified by A in type code)						
Sealing principle	Soft						
Type of mounting	Optionally via through-holes ¹⁾ or on manifold rail						
Standard nominal flow rate [qnN]	2300	2300	2300	2300	2000	1600	1600
Through-holes (nominal width) [mm]	9.4	9.4	9.4	9.4	8.9	8.1	8.1
Product weight [g]	394	394	487/546 ²⁾	545	542	542	542
Type of actuation	Pneumatic						
Mounting position	Any						
Exhaust air function	With flow control						
Venting hole	Not ducted						
Pneumatic connection 1, 2, 4, 3, 5	3/8 NPT						
Pilot air port 12/14, 10	1/8 NPT						

1) If several valves are to be screwed together via the through-holes to form a block, a minimum distance of 0.3 mm must be ensured by placing spacer discs between them.

2) With external pneumatic spring: 546 g, with internal pneumatic spring or mechanical spring: 487 g

Technical data – 3/2-way valves									
Order code for valves		M32C-A		M32C-M		M32U-A		M32U-M	
Normal position		Closed				Open			
Stable positions		Monostable				Monostable			
Reset method		Pneumatic spring		Mechanical spring		Pneumatic spring		Mechanical spring	
Switching times	On	19	16	19	16	19	16	19	16
	Off	36	73	37	73	37	73	37	73

Pneumatic valves VUWS, NPT

Technical data – Pneumatic valves, size 30

Technical data – 5/2-way valves				
Order code for valves		M52		B52
Stable positions		Monostable		Bistable
Reset method		Pneumatic spring	Mechanical spring	–
Switching times	On	24	17	–
	Off	59	77	–
	Change-over	–	–	13

Technical data – 5/3-way valves				
Order code for valves		P53C	P53U	P53E
Stable positions		Monostable		
Reset method		Mechanical spring		
Switching times	On	19	19	19
	Off	98	98	98
	Change-over	41	41	41

Safety characteristics	
Note on forced checking procedure	Min. 1/week
Resistance to shocks	Shock test with severity level 2 to FN 942017-5 and EN 60068-2-27
Vibration resistance	Transport application test with severity level 2 to FN 942017-4 and EN 60068-2-6

Operating and environmental conditions					
Valve function	M32	M52-A	M52-M	B52	P53
Operating medium	Compressed air to ISO 8573-1:2010 [7:4:4]				
Pilot medium	Compressed air to ISO 8573-1:2010 [7:4:4]				
Note on operating/pilot medium	Lubricated operation possible (in which case lubricated operation will always be required)				
Operating pressure [bar]	2.5 ... 10	2.5 ... 10	–0.9 ... +10	–0.9 ... +10	–0.9 ... +10
Pilot pressure [bar]	2.5 ... 10	2.5 ... 10	2.5 ... 10	1.5 ... 10	2.5 ... 10
Ambient temperature [°C]	–10 ... +60				
Temperature of medium [°C]	–10 ... +60				
Corrosion resistance class CRC ¹⁾	2				

- 1) Corrosion resistance class CRC 2 to Festo standard FN 940070
Moderate corrosion stress. Indoor applications in which condensation may occur. External visible parts with primarily decorative requirements for the surface and which are in direct contact with the ambient atmosphere typical for industrial applications.

Information on materials	
Housing	Die-cast aluminium
Piston spool	Wrought aluminium alloy
Seals	HNBR, NBR
Note on materials	RoHS compliant

Pneumatic valves VUWS, NPT

Technical data – Pneumatic valves, size 30

Dimensions

Download CAD data → www.festo.com

3/2-way valve, normally closed/open

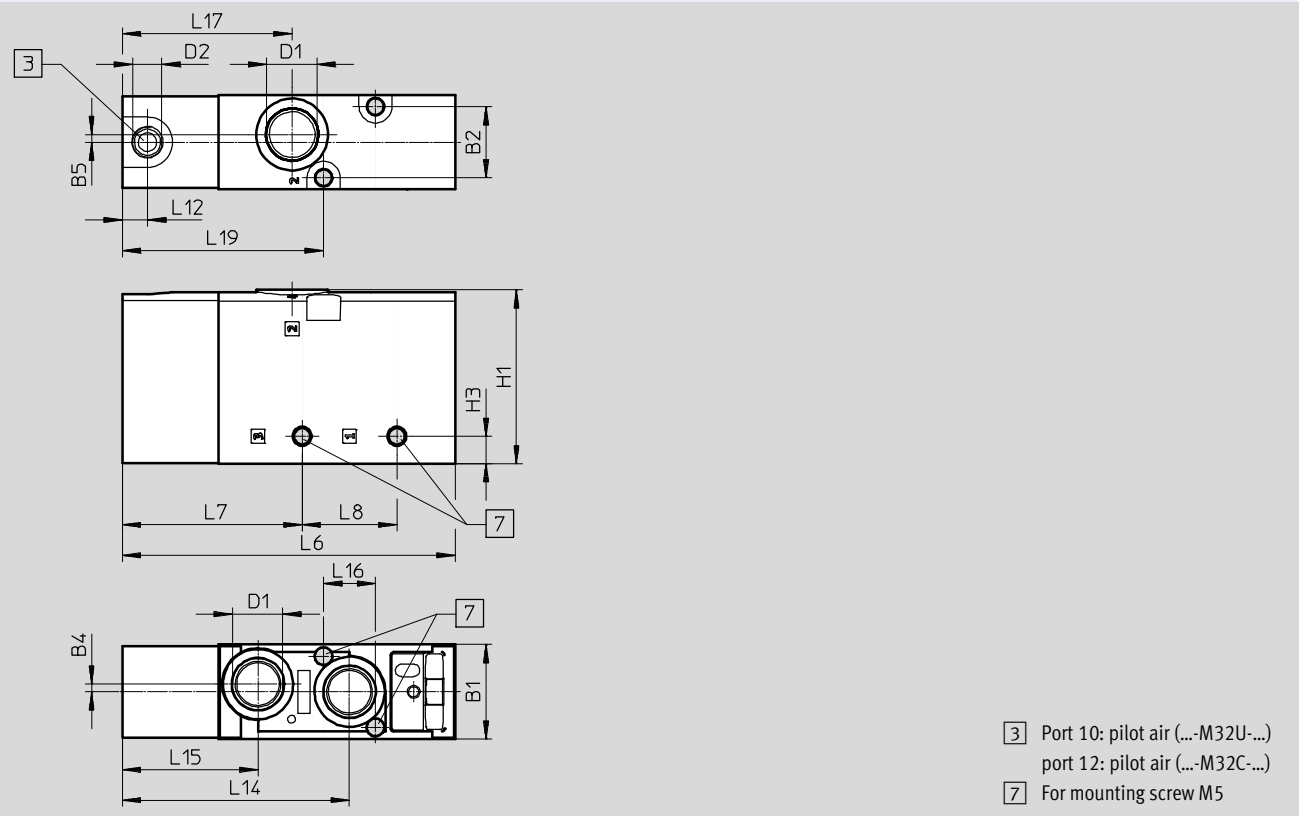

Type	B1	B2	B3	B4	B5	D1	D2	H1	H3
VUWS-L30-M32C-...-N38	31	23.3	2.5	2.5	2.5	3/8 NPT	1/8 NPT	57	9
VUWS-L30-M32U-...-N38									

Type	L6	L7	L8	L12	L14	L15	L16	L17	L19
VUWS-L30-M32C-...-N38	109.2	59	31	8.3	74.5	44.5	17	55.7	66
VUWS-L30-M32U-...-N38									

Pneumatic valves VUWS, NPT

Technical data – Pneumatic valves, size 30

Dimensions

Download CAD data → www.festo.com

5/2-way valve, monostable

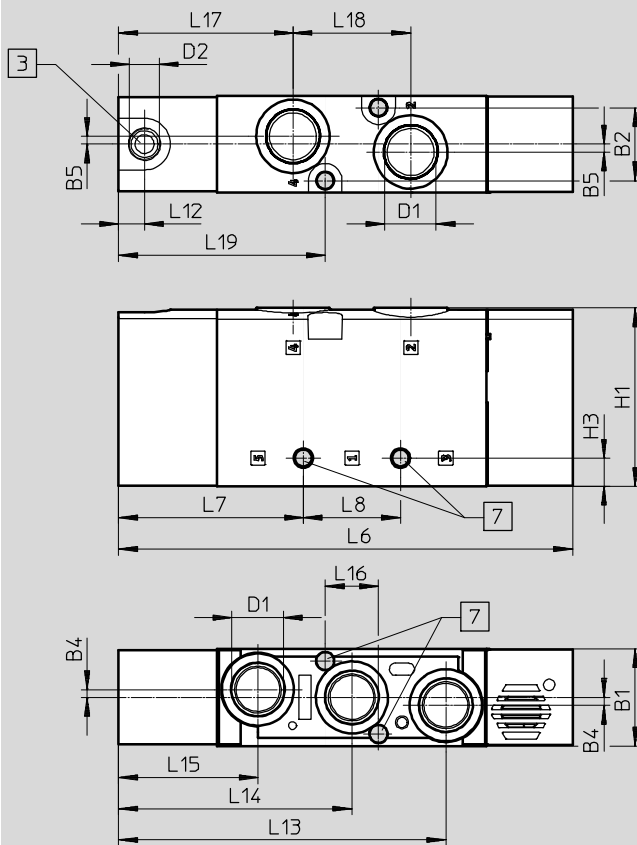

3 Port 14: pilot air (-M52-...) **7** For mounting screw M5

Type	B1	B2	B4	B5	D1	D2	H1	H3
VUWS-L30-M52-...-N38	31	23.3	2.5	2.5	3/8 NPT	1/8 NPT	57	9

Type	L6	L7	L8	L12	L13	L14	L15	L16	L17	L18	L19
VUWS-L30-M52-...-N38	145	59	31	8.3	104.5	74.5	44.5	17	55.7	37.6	66

Pneumatic valves VUWS, NPT

Technical data – Pneumatic valves, size 30

Dimensions

Download CAD data → www.festo.com

5/2-way valve, bistable, 5/3-way valve

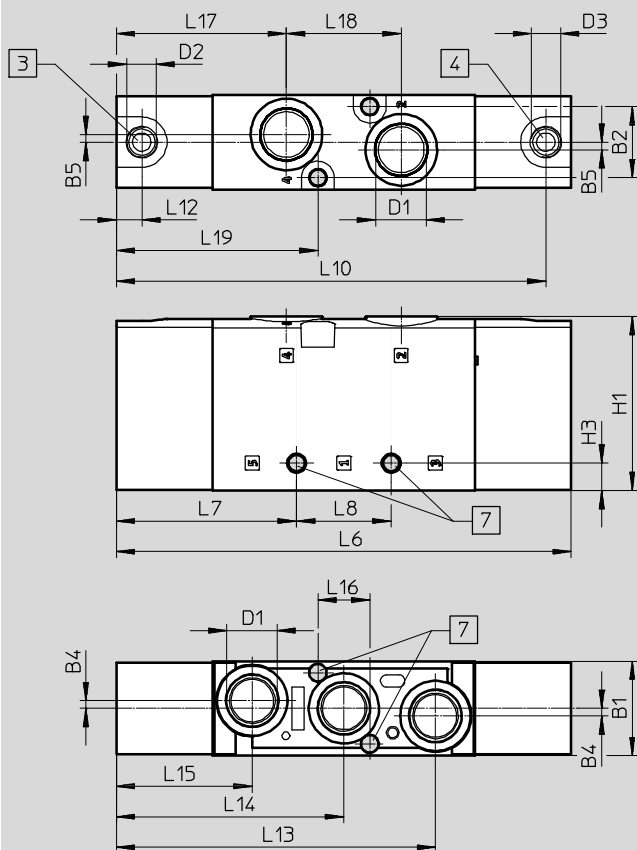

- 3 Port 14: pilot air
- 4 Port 12: pilot air
- 7 For mounting screw M5

Type	B1	B2	B4	B5	D1	D2	D3	H1	H3
VUWS-L30-P53...-M-N38	31	23.3	2.5	2.5	3/8 NPT	1/8 NPT	1/8 NPT	57	9
VUWS-L30-B52-N38									

Type	L6	L7	L8	L10	L12	L13	L14	L15	L16	L17	L18	L19
VUWS-L30-P53...-M-N38	149	59	31	140.7	8.3	104.5	74.5	44.5	17	55.7	37.6	66
VUWS-L30-B52-N38												

Pneumatic valves VUWS, NPT

Ordering data – Pneumatic valves, size 30

Dimensions

Foot mounting

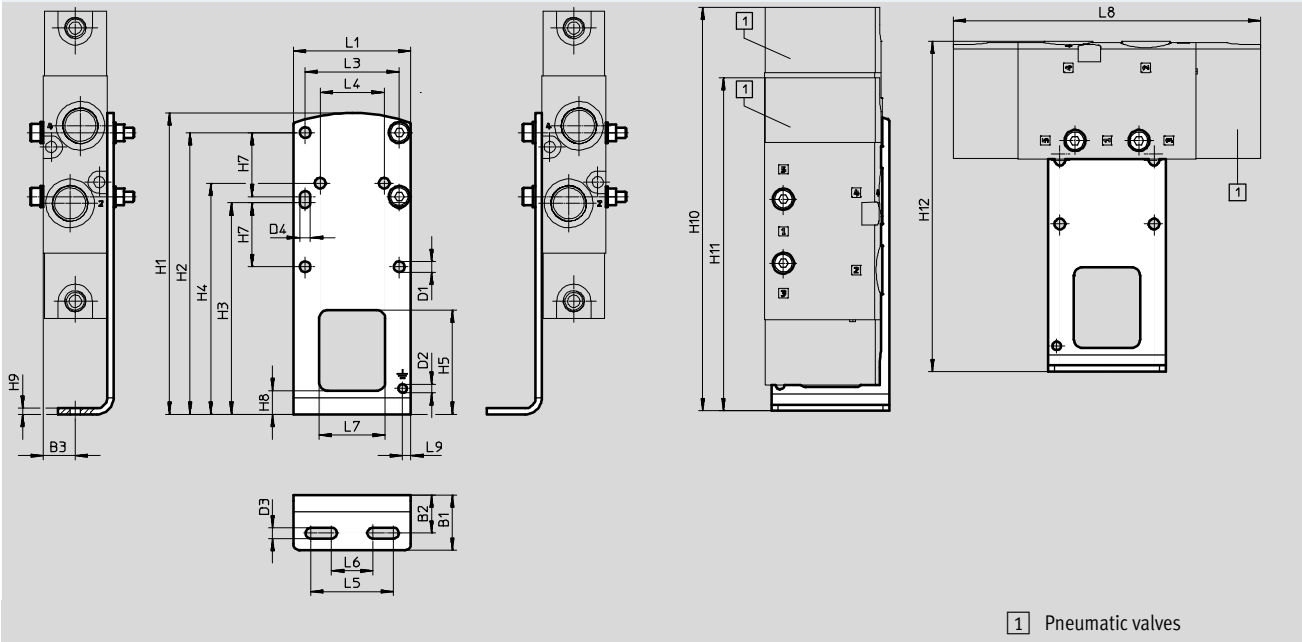

1 Pneumatic valves

Type		B1	B2	B3	D1 Ø	D2 Ø	D3 Ø	D4 Ø	H1	H2	H3	H4	H5	H7
VAME-B10-30-A	VUWS-L30-B52/P53	26.8	18.5	15.5	5.2	4.2	5.2	5.2	146	136.5	102.5	112	50.5	31
	VUWS-L30-M52													
	VUWS-L30-M32													

Type		H8	H9	H10	H11	H12	L1	L3	L4	L5	L6	L7	L8	L9
VAME-B10-30-A	VUWS-L30-B52/P53	11.5	3	195.5	161.5	160	57	45.6	31	40	20	32	149	4.1
	VUWS-L30-M52			195.5	161.5								149	
	VUWS-L30-M32			155.7	121.7								109.2	

Dimensions

Wall mounting

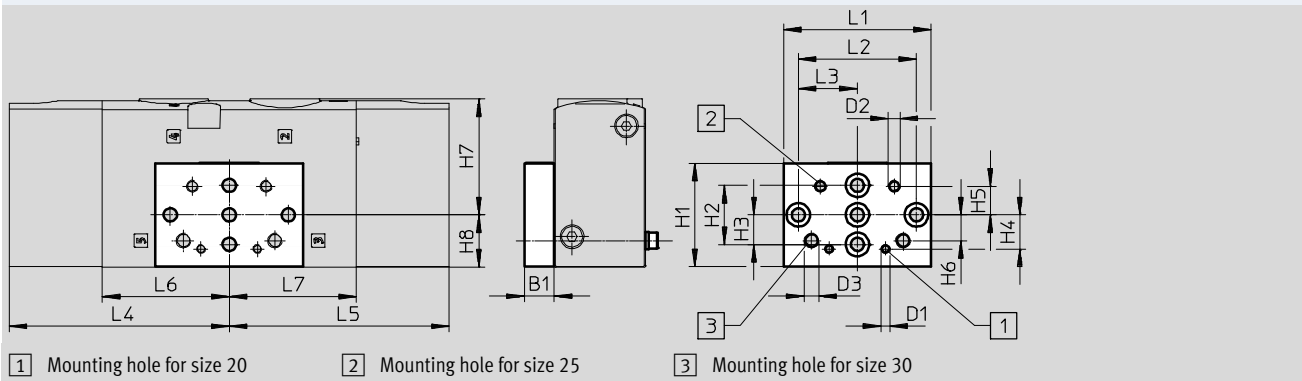

1 Mounting hole for size 20

2 Mounting hole for size 25

3 Mounting hole for size 30

Type		B1	D1	D2	D3	H1	H2	H3	H4	H5	H6	H7	H8	L1	L2	L3	L4	L5	L6	L7
VAME-B10-20-W	VUWS-L30-B52/P53	10	M3	M4	M5	35	20	10	11.5	9.7	8.7	39.3	17.7	50	40	20	74.5	74.5	43	43
	VUWS-L30-M52																70.5		43	
	VUWS-L30-M32																-		34.7	

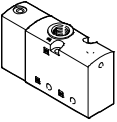
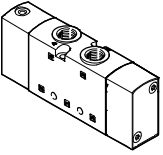
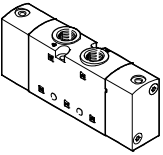

Pneumatic valves VUWS, NPT

Ordering data – Pneumatic valves, size 30



Ordering data – Pneumatic valves				
	Code	Valve function	Part No.	Type
Pneumatic valves				
	3/2-way valve, monostable, closed			
	M32C-A	Pneumatic spring return, internal pneumatic spring, direction of flow not reversible	575639	VUWS-L30-M32C-A-N38
	M32C-M	Mechanical spring return, direction of flow reversible	575640	VUWS-L30-M32C-M-N38
	3/2-way valve, monostable, open			
	M32U-A	Pneumatic spring return, internal pneumatic spring, direction of flow not reversible	575643	VUWS-L30-M32U-A-N38
	M32U-M	Mechanical spring return, direction of flow reversible	575644	VUWS-L30-M32U-M-N38
	5/2-way valve, monostable			
	M52-A	Pneumatic spring return, internal pneumatic spring, direction of flow not reversible	575646	VUWS-L30-M52-A-N38
	M52-M	Mechanical spring return, direction of flow reversible	575648	VUWS-L30-M52-M-N38
	5/2-way valve, bistable			
	B52	Direction of flow reversible	575650	VUWS-L30-B52-N38
	5/3-way valve			
	P53C	Closed, mechanical spring return, direction of flow reversible	575652	VUWS-L30-P53C-M-N38
	P53E	Exhausted, mechanical spring return, direction of flow reversible	575656	VUWS-L30-P53E-M-N38
	P53U	Pressurised, mechanical spring return, direction of flow reversible	575654	VUWS-L30-P53U-M-N38

Pneumatic valves VUWS, NPT

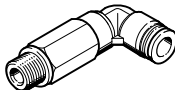
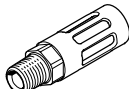
Accessories – Pneumatic valves, size 30

Ordering data					
	Description		Part No.	Type	PU ¹⁾
Push-in fitting with internal hex					
	Connecting thread 1/8 NPT for tubing O.D.	1/4 "	572318	QB-1/8-1/4-I-U	10
	Connecting thread 3/8 NPT for tubing O.D.	5/16 "	572323	QB-3/8-5/16-I-U	10
		3/8 "	572324	QB-3/8-3/8-I-U	10
		1/2 "	572325	QB-3/8-1/2-I-U	10
Angled push-in fitting with external hex					
	Connecting thread 3/8 NPT for tubing O.D.	5/16 "	533299	QBL-3/8-5/16-U	5
		3/8 "	533300	QBL-3/8-3/8-U	5
		1/2 "	533301	QBL-3/8-1/2-U	5
Angled push-in fitting, long, with external hex					
	Connecting thread 3/8 NPT for tubing O.D.	5/16 "	564679	QBLL-3/8-5/16-U	5
		3/8 "	564680	QBLL-3/8-3/8-U	5
		1/2 "	564681	QBLL-3/8-1/2-U	5
Silencer					
	With connecting thread NPT (metal design)	3/8 NPT	12740	U-3/8-B-NPT	1

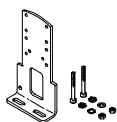
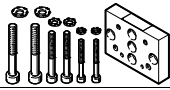
1) Packaging unit

Ordering data					
Description		Weight [g]	Part No.	Type	
Foot mounting					
	Set for mounting valves, comprising: <ul style="list-style-type: none"> • Mounting bracket and • Screw set for mounting 	–	8026337	VAME-B10-30-A	
Wall mounting					
	Set for mounting valves for size 20, 25, 30, comprising: <ul style="list-style-type: none"> • Wall mounting and • Screw set for mounting 	53	576413	VAME-B10-20-W	
Set of spare parts					
	Set comprising: <ul style="list-style-type: none"> • Seals and • Screws 	–	8035637	VAME-B10-30-MK	

Pneumatic valves VUWS/valve manifold VTUS, NPT

Order code – Manifold block

VABM	-	B10	-		-
Manifold assembly parts					
Manifold block		VABM			
Valve series					
VUWS		B10			
Valve width					
21 mm				20	
26.5 mm				25	
31 mm				30	
Connection type					
Supply manifold					-
Compact manifold block					S
Standard manifold block					E

	-		-		-	
Mounting						
	-					Standard mounting
Port for valve function						
	-					Manifold block for 5/2- and 5/3-way valves
		P3				Manifold block for 3/2-way valves
		P53				Supply manifold
Number of valve positions						
	2 ... 10					2 to 10
Pneumatic connections 1, 3, 5						
N14						1/4 NPT
N38						3/8 NPT
N12						1/2 NPT
N34						3/4 NPT

Manifold block VABM, NPT

Technical data – Manifold block, size 20

-  - Flow rate
Up to 700 l/min

-  - Valve width
21 mm



General technical data					
Valve function	Manifold block standard		Manifold block compact		Supply manifold on both sides
	3/2	5/2, 5/3	3/2	5/2, 5/3	3/2, 5/2, 5/3
Grid dimension [mm]	22				
Type of mounting	With through-hole				With mounting bracket
Max. number of valve positions	10	10	10		10
Port 1	3/8 NPT	3/8 NPT	1/4 NPT	1/4 NPT	3/8 NPT
Port 3	3/8 NPT	3/8 NPT	1/4 NPT	1/4 NPT	-
Port 5	-	3/8 NPT	-	1/4 NPT	-
Port 12	1/8 NPT	1/8 NPT	-	-	-
Port 14	-	1/8 NPT	-	-	-
CRC ¹⁾	2 ¹⁾				

1) Corrosion resistance class CRC 2 to Festo standard FN 940070
Moderate corrosion stress. Indoor applications in which condensation may occur. External visible parts with primarily decorative requirements for the surface and which are in direct contact with the ambient atmosphere typical for industrial applications.

Weight [g]									
Valve positions	2	3	4	5	6	7	8	9	10
Manifold block for 3/2-way valves, standard									
VABM-B10-20E-N38-...-P3	449	574	699	825	950	1075	1200	1326	1451
Manifold block for 5/2- and 5/3-way valves, standard									
VABM-B10-20E-N38-...	680	866	1053	1239	1425	1612	1798	1985	2171
Manifold block for 3/2-way valves, compact									
VABM-B10-20S-N14-...-P3	280	360	441	521	601	681	762	842	922
Manifold block for 5/2- and 5/3-way valves, compact									
VABM-B10-20S-N14-...	344	439	535	630	726	821	917	1012	1108
Supply manifold for mounting on both sides									
VABM-B10-20-N38-...-P53	226	268	310	352	395	437	479	521	563

Information on materials	
Materials	Wrought aluminium alloy
Note on materials	RoHS compliant

Manifold block VABM, NPT

Technical data – Manifold block, size 20

Dimensions

Manifold block for 3/2-way valves, standard

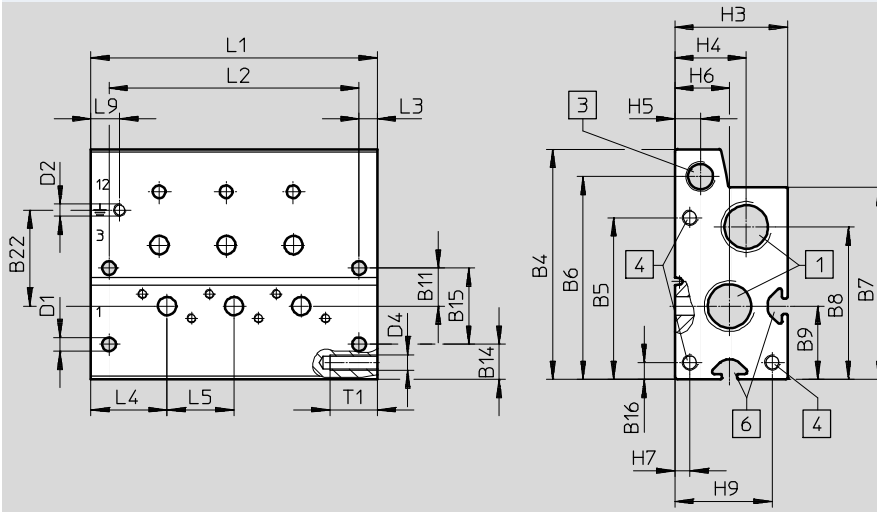

- 1 Ports 1 and 3 (at both ends): 3/8 NPT
- 3 Ports 12 (at both ends): 1/8 NPT
- 4 Thread M5x15.5 for extension module
- 6 Profile slot IPM-05, system 5

Type	B4	B5	B6	B7	B8	B9	B11	B14	B15	B16	B22
VABM-B10-20E-N38-...-P3	75.5	53	66.5	63	50	24	12.5	11.5	25	5.5	31.5

Type	D1 Ø	D2	D4	H3	H4	H5	H6	H7	H9	L3	L4	L5	L9	T1
VABM-B10-20E-N38-...-P3	4.5	M4x6.5	M5	37	23.5	8.5	18	5	32	6	25	22	9.5	15.5

Valve positions	2	3	4	5	6	7	8	9	10
L1 [mm]	72	94	116	138	160	182	204	226	248
L2 [mm]	60	82	104	126	148	170	192	214	236

Manifold block VABM, NPT

Technical data – Manifold block, size 20

Dimensions

Manifold block for 5/2- and 5/3-way valves, standard

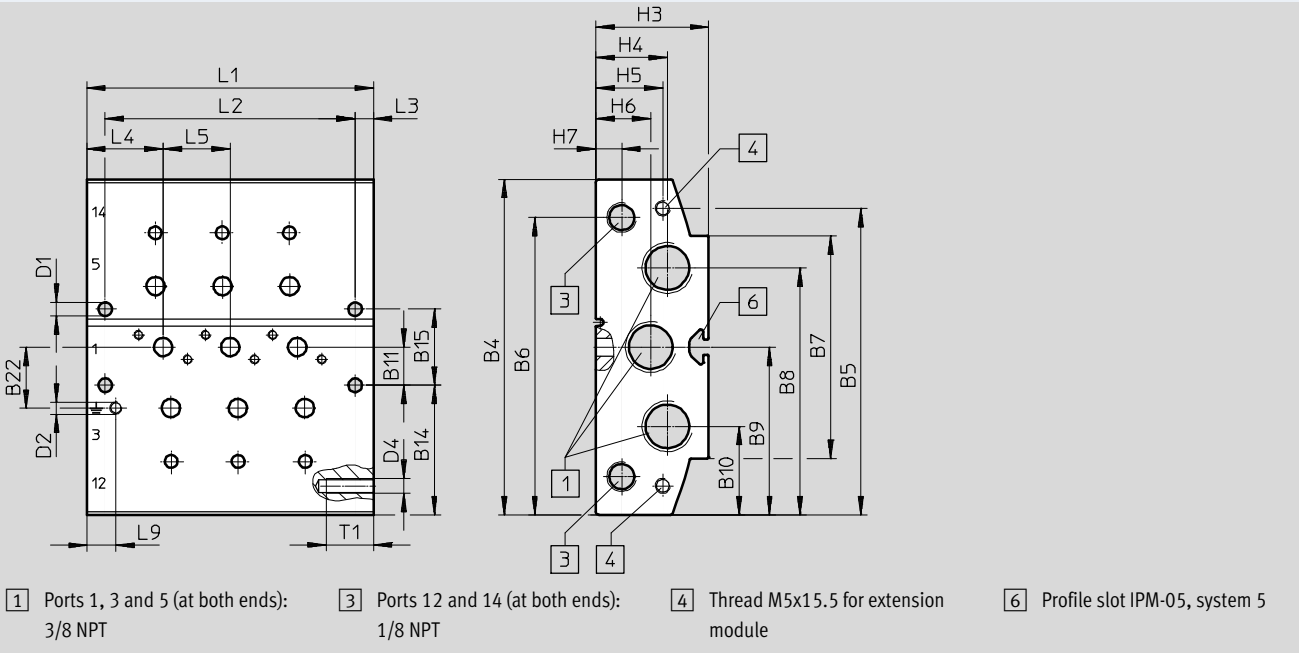

Type	B4	B5	B6	B7	B8	B9	B10	B11	B14	B15	B22
VABM-B10-20E-N38-...	110	100.5	97.5	73	81	55	29	12.5	42.5	25	20

Type	D1 Ø	D2	D4	H3	H4	H5	H6	H7	L3	L4	L5	L9	T1
VABM-B10-20E-N38-...	4.5	M4x6.5	M5	37	23.5	22	18	8.5	6	25	22	9.5	15.5

Valve positions	2	3	4	5	6	7	8	9	10
L1 [mm]	72	94	116	138	160	182	204	226	248
L2 [mm]	60	82	104	126	148	170	192	214	236

Manifold block VABM, NPT

Technical data – Manifold block, size 20

Dimensions

Manifold block for 3/2-way valves, compact

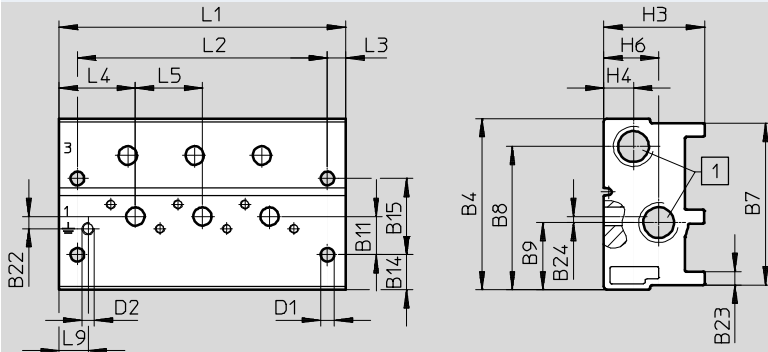

1 Ports 1 and 3 (at both ends):
1/4 NPT

Type	B4	B7	B8	B9	B11	B14	B15	B22	B23	B24
VABM-B10-20S-N14-...-P3	56.1	53.1	471	22	12.5	11.5	25	4	5	2

Type	D1 Ø	D2	H3	H4	H6	L3	L4	L5	L9
VABM-B10-20S-N14-...-P3	4.5	M4x6.5	33	9.7	18	6	25	22	9.5

Valve positions	2	3	4	5	6	7	8	9	10
L1 [mm]	72	94	116	138	160	182	204	226	248
L2 [mm]	60	82	104	126	148	170	192	214	236

Dimensions

Manifold block for 5/2- and 5/3-way valves, compact

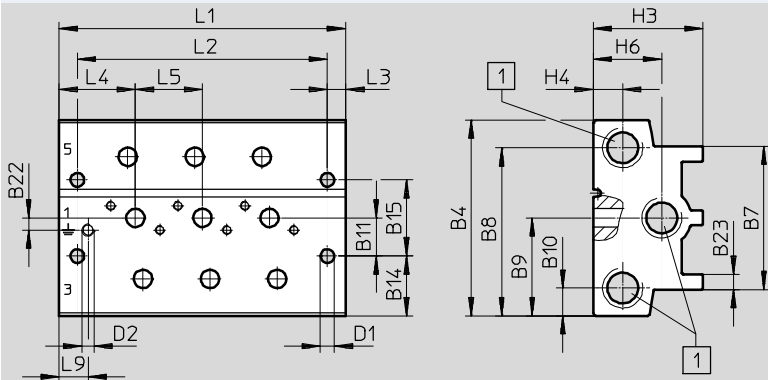

1 Ports 1, 3 and 5 (at both ends):
1/4 NPT

Type	B4	B7	B8	B9	B10	B11	B14	B15	B22	B23
VABM-B10-20S-N14-...	64.2	47	55.1	32.1	9.1	12.5	149.6	25	4	5

Type	D1 Ø	D2	H3	H4	H6	L3	L4	L5	L9
VABM-B10-20S-N14-...	4.5	M4x6.5	36	9.7	22.5	6	25	22	9.5

Valve positions	2	3	4	5	6	7	8	9	10
L1 [mm]	72	94	116	138	160	182	204	226	248
L2 [mm]	60	82	104	126	148	170	192	214	236

Manifold block VABM, NPT

Technical data – Manifold block, size 20

Dimensions

Supply manifold, mounting on both sides

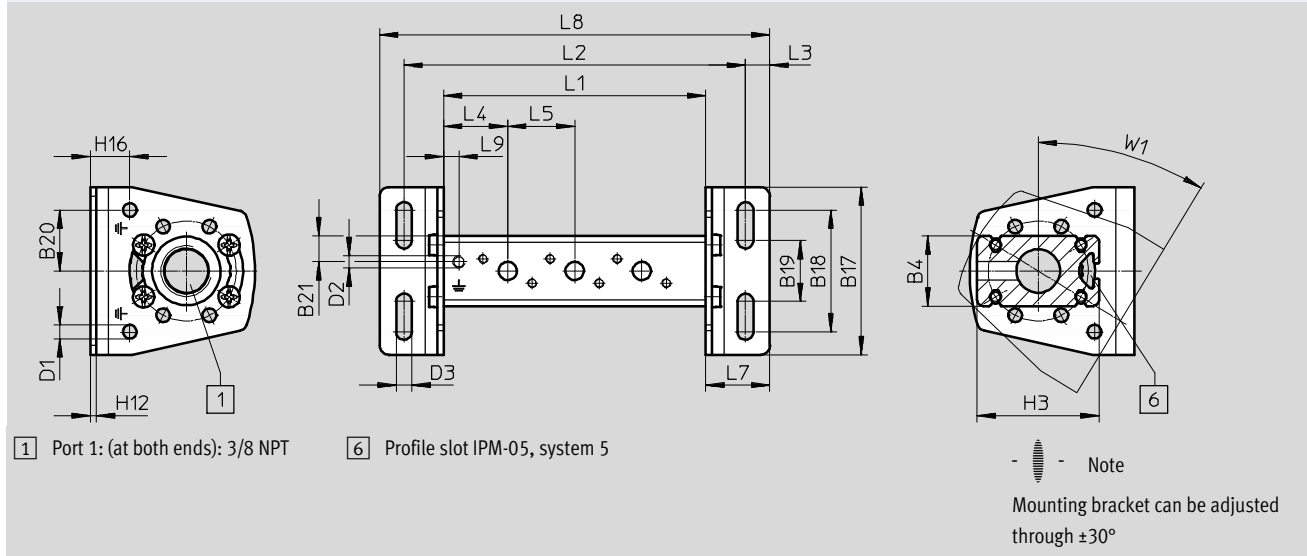









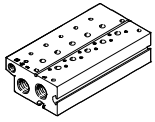

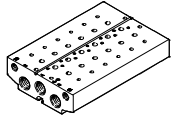
Type	B4	B17	B18	B19	B20	B21	D1 \varnothing	D2	D3 \varnothing	H3	H12	H16	L3	L4	L5	L7	L9	W1
VABM-B10-20-N38-...-P53	23	55	40	20	20	8.5	4.5	M4x6.5	5.2	40	2	13	9	21	22	22	5	31.3°

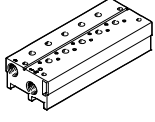
Valve positions	2	3	4	5	6	7	8	9	10
L1 [mm]	64	86	108	130	152	174	196	218	240
L2 [mm]	90	112	134	156	178	200	222	244	266
L8 [mm]	106	128	150	172	194	216	238	260	282

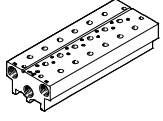
Manifold block VABM, NPT

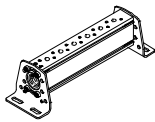



Ordering data – Manifold block, size 20

Ordering data			
Description	Valve positions	Part No.	Type
Standard manifold block			
 <p>For 3/2-way valves, incl. seals and screws for mounting valves</p> <p>-  - Note Blanking plugs for sealing the supply ports (1, 3 and 14) at one end are included in the scope of delivery.</p>	2	576453	VABM-B10-20E-N38-2-P3
	3	576454	VABM-B10-20E-N38-3-P3
	4	576455	VABM-B10-20E-N38-4-P3
	5	576456	VABM-B10-20E-N38-5-P3
	6	576457	VABM-B10-20E-N38-6-P3
	7	576458	VABM-B10-20E-N38-7-P3
	8	576459	VABM-B10-20E-N38-8-P3
	9	576460	VABM-B10-20E-N38-9-P3
	10	576461	VABM-B10-20E-N38-10-P3
	 <p>For 5/2- and 5/3-way valves, incl. seals and screws for valve assembly</p> <p>-  - Note Blanking plugs for sealing the supply ports (1, 3, 5, 12 and 14) at one end are included in the scope of delivery.</p>	2	576351
3		576352	VABM-B10-20E-N38-3
4		576353	VABM-B10-20E-N38-4
5		576354	VABM-B10-20E-N38-5
6		576355	VABM-B10-20E-N38-6
7		576356	VABM-B10-20E-N38-7
8		576357	VABM-B10-20E-N38-8
9		576358	VABM-B10-20E-N38-9
10		576359	VABM-B10-20E-N38-10
Compact manifold block			
 <p>For 3/2-way valves, incl. seals and screws for mounting valves</p> <p>-  - Note Blanking plugs for sealing the supply ports (1 and 3) at one end are included in the scope of delivery.</p>	2	576477	VABM-B10-20S-N14-2-P3
	3	576478	VABM-B10-20S-N14-3-P3
	4	576479	VABM-B10-20S-N14-4-P3
	5	576480	VABM-B10-20S-N14-5-P3
	6	576481	VABM-B10-20S-N14-6-P3
	7	576482	VABM-B10-20S-N14-7-P3
	8	576483	VABM-B10-20S-N14-8-P3
	9	576484	VABM-B10-20S-N14-9-P3
	10	576485	VABM-B10-20S-N14-10-P3
	 <p>For 5/2- and 5/3-way valves, incl. seals and screws for valve assembly</p> <p>-  - Note Blanking plugs for sealing the supply ports (1, 3 and 5) at one end are included in the scope of delivery.</p>	2	576429
3		576430	VABM-B10-20S-N14-3
4		576431	VABM-B10-20S-N14-4
5		576432	VABM-B10-20S-N14-5
6		576433	VABM-B10-20S-N14-6
7		576434	VABM-B10-20S-N14-7
8		576435	VABM-B10-20S-N14-8
9		576436	VABM-B10-20S-N14-9
10		576437	VABM-B10-20S-N14-10
Supply manifold			
 <p>For mounting on both sides, incl. seals and screws for mounting valves</p> <p>-  - Note Blanking plug for sealing the supply port (1) at one end included in the scope of delivery.</p>	2	576375	VABM-B10-20-N38-2-P53
	3	576376	VABM-B10-20-N38-3-P53
	4	576377	VABM-B10-20-N38-4-P53
	5	576378	VABM-B10-20-N38-5-P53
	6	576379	VABM-B10-20-N38-6-P53
	7	576380	VABM-B10-20-N38-7-P53
	8	576381	VABM-B10-20-N38-8-P53
	9	576382	VABM-B10-20-N38-9-P53
	10	576383	VABM-B10-20-N38-10-P53

Manifold block VABM, NPT

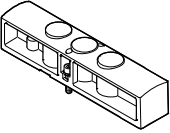
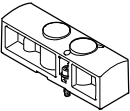
Accessories – Manifold block, size 20

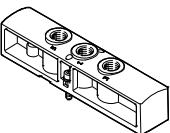
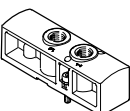

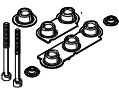
FESTO

Ordering data				
Description	Weight [g]	Part No.	Type	
Blanking plate				
	For valve position on manifold block for 5/2-, 5/3-way valves	78	576410	VABB-B10-20-E
	For valve position on manifold block for 3/2-way valves	56	576411	VABB-B10-20-E-P3
	For valve position on supply manifold	13	576409	VABB-B10-20-A
Supply plate				
	For valve position on manifold block for 5/2-, 5/3-way valves	78	576492	VABF-B10-20-P1A4-G18
	For valve position on manifold block for 3/2-way valves	56	576493	VABF-B10-20-P1A4-G18-P3
Supply plate				
	For valve position on supply manifold	13	576491	VABF-B10-20-P1-G18
Set of spare parts				
	Set comprising: <ul style="list-style-type: none"> • Seals and • Screws 	10	8026203	VAME-B10-20-MK



Manifold block VABM, NPT

Accessories – Manifold block, size 20

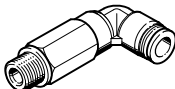
FESTO

Ordering data					
	Description of NPT thread		Part No.	Type	PU ¹⁾
Push-in fitting with internal hex					
	Connecting thread 1/8 NPT for tubing O.D.	5/32 "	572317	QB-1/8-5/32-I-U	10
		1/4 "	572318	QB-1/8-1/4-I-U	10
		5/16 "	572319	QB-1/8-5/16-I-U	10
	Connecting thread 1/4 NPT for tubing O.D.	5/16 "	572321	QB-1/4-5/16-I-U	10
		3/8 "	572322	QB-1/4-3/8-I-U	10
		1/2 "	567771	QB-1/4-1/2-U	10
	Connecting thread 3/8 NPT for tubing O.D.	5/16 "	572323	QB-3/8-5/16-I-U	10
		3/8 "	572324	QB-3/8-3/8-I-U	10
		1/2 "	572325	QB-3/8-1/2-I-U	10
Angled push-in fitting with external hex					
	Connecting thread 1/8 NPT for tubing O.D.	5/32 "	533290	QBL-1/8-5/32-U	10
		1/4 "	533292	QBL-1/8-1/4-U	10
		5/16 "	533293	QBL-1/8-5/16-U	10
	Connecting thread 1/4 NPT for tubing O.D.	5/16 "	533296	QBL-1/4-5/16-U	10
		3/8 "	533297	QBL-1/4-3/8-U	5
		1/2 "	567775	QBL-1/4-1/2-U	5
	Connecting thread 3/8 NPT for tubing O.D.	5/16 "	533299	QBL-3/8-5/16-U	5
		3/8 "	533300	QBL-3/8-3/8-U	5
		1/2 "	533301	QBL-3/8-1/2-U	5
Angled push-in fitting, long, with external hex					
	Connecting thread 1/8 NPT for tubing O.D.	5/32 "	564668	QBLL-1/8-5/32-U	10
		1/4 "	564670	QBLL-1/8-1/4-U	10
		5/16 "	564671	QBLL-1/8-5/16-U	10

1) Packaging unit

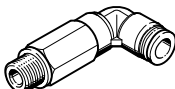
Ordering data					
	Description of G thread		Part No.	Type	PU ¹⁾
Push-in fitting with internal hex					
	Connecting thread G1/8 for tubing O.D.	4 mm	186106	QS-G1/8-4-I	10
			133008	QS-G1/8-4-I-100	100
		6 mm	186107	QS-G1/8-6-I	10
			133009	QS-G1/8-6-I-100	100
		8 mm	186109	QS-G1/8-8-I	10
			133010	QS-G1/8-8-I-100	100
Angled push-in fitting with external hex					
	Connecting thread G1/8 for tubing O.D.	4 mm	186116	QSL-G1/8-4	10
			132048	QSL-G1/8-4-100	100
		6 mm	186117	QSL-G1/8-6	10
			132049	QSL-G1/8-6-100	100
		8 mm	186119	QSL-G1/8-8	10
			132050	QSL-G1/8-8-50	50
Angled push-in fitting, long, with external hex					
	Connecting thread G1/8 for tubing O.D.	4 mm	186127	QSLL-G1/8-4	10
			133015	QSLL-G1/8-4-100	100
		6 mm	186128	QSLL-G1/8-6	10
			133016	QSLL-G1/8-6-100	100
		8 mm	186130	QSLL-G1/8-8	10
			133017	QSLL-G1/8-8-100	100

1) Packaging unit

Manifold block VABM, NPT

Accessories – Manifold block, size 20



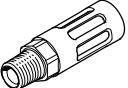

Ordering data					
	Description of NPT thread		Part No.	Type	PU ¹⁾
Silencer					
	With connecting thread NPT (metal design)	1/4 NPT	12639	U-1/4-B-NPT	1
		3/8 NPT	12740	U-3/8-B-NPT	1

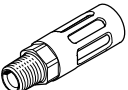
1) Packaging unit

Ordering data					
	Description of G thread		Part No.	Type	PU ¹⁾
Silencer					
	With connecting thread G (plastic design)	G1/8	2307	U-1/8	1
			534222	U-1/8-50	50
	With connecting thread G (metal design)	G1/8	6841	U-1/8-B	1

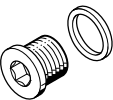
1) Packaging unit

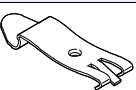
Ordering data					
	Description		Part No.	Type	PU ¹⁾
Blanking plug					
	With connecting thread NPT	1/8 NPT	173985	B-1/8-NPT	1
		1/4 NPT	174165	B-1/4-NPT	1
		3/8 NPT	174169	B-3/8-NPT	1
Separator					
	For creating pressure zones for port	G1/8	569995	VABD-8-B	1
		1/8 NPT			
		G1/4	569996	VABD-10-B	1
		1/4 NPT			
G3/8	574483	VABD-14-B	1		
3/8 NPT					
H-rail mounting					
	For size 20, for mounting on standard H-rails TH 35-7.5 or TH 35-15 to EN 60715		569998	VAME-T-M4	2

1) Packaging unit

Manifold block VABM, NPT

Technical data – Manifold block, size 25

-  - Flow rate
Up to 1300 l/min

-  - Valve width
26.5 mm



General technical data					
	Manifold block standard		Manifold block compact		Supply manifold on both sides
For valves	3/2	5/2, 5/3	3/2	5/2, 5/3	3/2, 5/2, 5/3
Grid dimension [mm]	27.5				
Type of mounting	With through-hole				With mounting bracket
Maximum number of valve positions	10	10	10	10	10
Port 1	1/2 NPT	1/2 NPT	3/8 NPT	3/8 NPT	1/2 NPT
Port 3	1/2 NPT	1/2 NPT	3/8 NPT	3/8 NPT	-
Port 5	-	1/2 NPT	-	3/8 NPT	-
Port 12	1/8 NPT	1/8 NPT	-	-	-
Port 14	-	1/8 NPT	-	-	-
CRC ¹⁾	2 ¹⁾				

1) Corrosion resistance class CRC 2 to Festo standard FN 940070
Moderate corrosion stress. Indoor applications in which condensation may occur. External visible parts with primarily decorative requirements for the surface and which are in direct contact with the ambient atmosphere typical for industrial applications.

Weight [g]									
Valve positions	2	3	4	5	6	7	8	9	10
Manifold block for 3/2-way valves, standard									
VABM-B10-25E-N12-...-P3	726	960	1194	1428	1662	1896	2130	2364	2598
Manifold block for 5/2- and 5/3-way valves, standard									
VABM-B10-25E-N12-...	927	1224	1521	1818	2115	2412	2709	3006	3303
Manifold block for 3/2-way valves, compact									
VABM-B10-25S-N38-...-P3	369	488	607	726	845	964	1083	1202	1321
Manifold block for 5/2- and 5/3-way valves, compact									
VABM-B10-25S-N38-...	438	579	720	861	1002	1143	1284	1425	1566
Supply manifold for mounting on both sides									
VABM-B10-25-N12-...-P53	258	340	422	504	586	668	750	832	914

Information on materials	
Materials	Wrought aluminium alloy
Note on materials	RoHS compliant

Manifold block VABM, NPT

Technical data – Manifold block, size 25

Dimensions

Manifold block for 3/2-way valves, standard

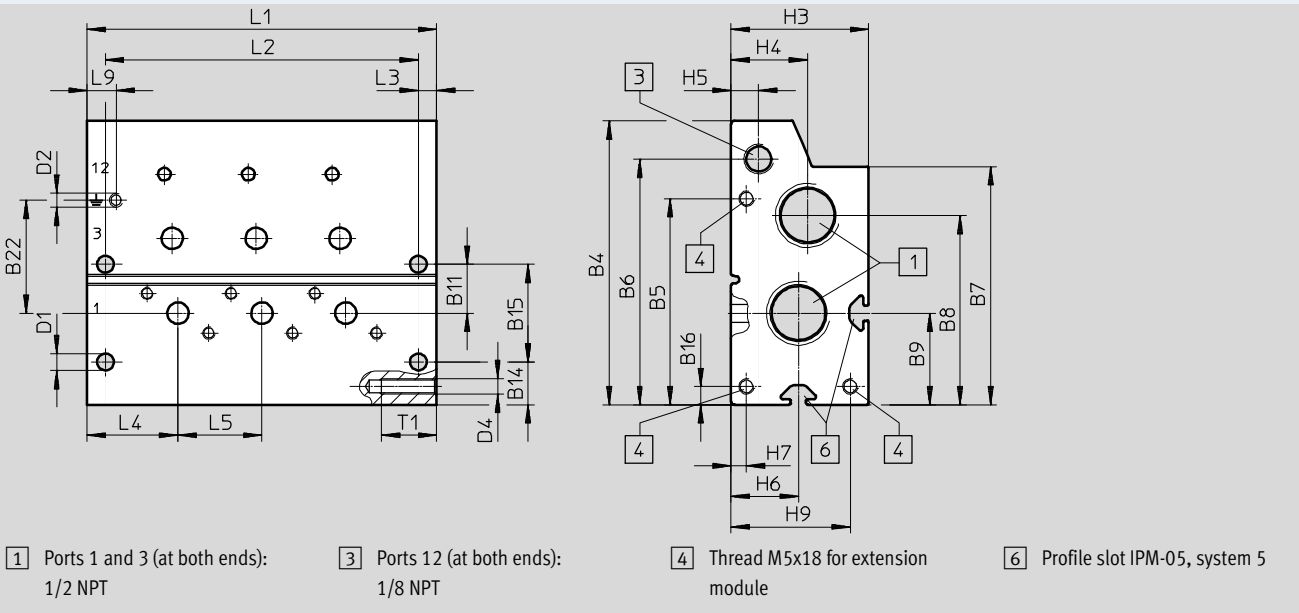

Type	B4	B5	B6	B7	B8	B9	B11	B14	B15	B16	B22
VABM-B10-25-E-N12-...-P3	93	67.5	80.5	78	62	30	16	14	32	6	37

Type	D1 Ø	D2	D4	H3	H4	H5	H6	H7	H9	L3	L4	L5	L9	T1
VABM-B10-25-E-N12-...-P3	5.5	M4x9	M5	45	25	9	22	5	39	6	29.8	27.5	9.5	18

Valve positions	2	3	4	5	6	7	8	9	10
L1 [mm]	87	114.5	142	169.5	197	224.5	252	279.5	307
L2 [mm]	75	102.5	130	157.5	185	212.5	240	267.5	295

Manifold block VABM, NPT

Technical data – Manifold block, size 25

Dimensions

Manifold block for 5/2- and 5/3-way valves, standard

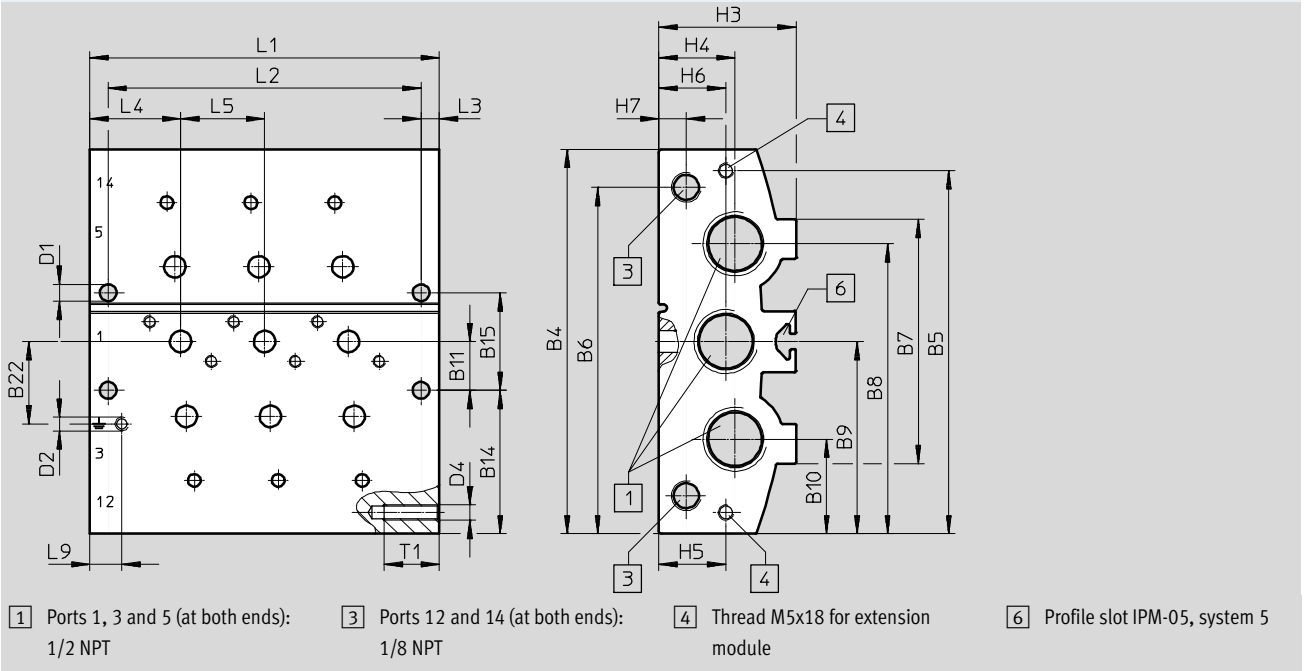

Type	B4	B5	B6	B7	B8	B9	B10	B11	B14	B15	B22
VABM-B10-25E-N12-...	126	119	113.5	80	95	63	31	16	47	32	27

Type	D1 Ø	D2	D4	H3	H4	H5	H6	H7	L3	L4	L5	L9	T1
VABM-B10-25E-N12-...	5.5	M4x9	M5	45	25	22	22	9	6	29.8	27.5	10.5	18

Valve positions	2	3	4	5	6	7	8	9	10
L1 [mm]	87	114.5	142	169.5	197	224.5	252	279.5	307
L2 [mm]	75	102.5	130	157.5	185	212.5	240	267.5	295

Manifold block VABM, NPT

Technical data – Manifold block, size 25

Dimensions

Manifold block for 3/2-way valves, compact

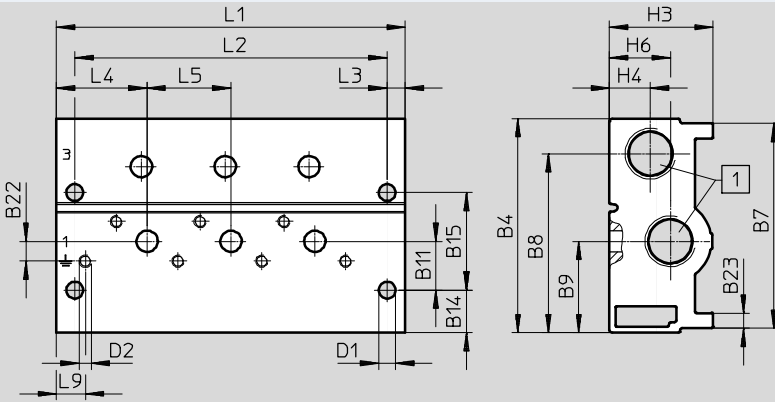

1 Ports 1 and 3 (at both ends):
3/8 NPT

Type	B4	B7	B8	B9	B11	B14	B15	B22	B23
VABM-B10-25S-N38-...-P3	70.3	67.3	58.8	30	16	14	32	6.5	5

Type	D1 Ø	D2	H3	H4	H6	L3	L4	L5	L9
VABM-B10-25S-N38-...-P3	5.5	M4x9	34	13.5	20	6	29.8	27.5	9.5

Valve positions	2	3	4	5	6	7	8	9	10
L1 [mm]	87	114.5	142	169.5	197	224.5	252	279.5	307
L2 [mm]	75	102.5	130	157.5	185	212.5	240	267.5	295

Manifold block VABM, NPT

Technical data – Manifold block, size 25

Dimensions

Manifold block for 5/2- and 5/3-way valves, compact

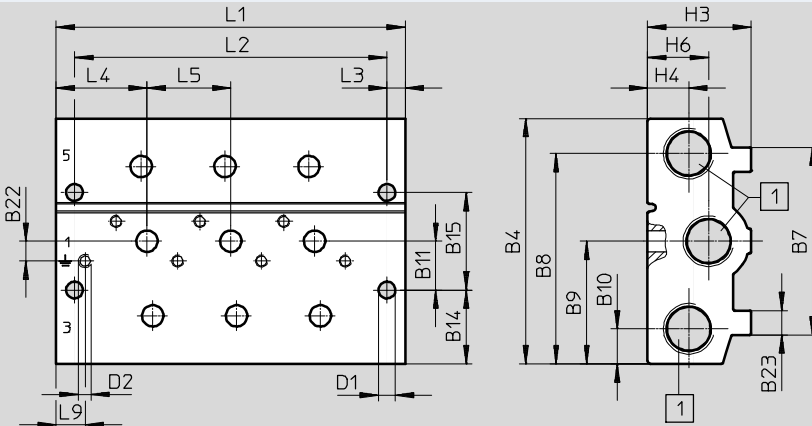

1 Ports 1, 3 and 5 (at both ends):
3/8 NPT

Type	B4	B7	B8	B9	B10	B11	B14	B15	B22	B23
VABM-B10-25S-N38-...	80.5	61.5	69	40.3	11.5	16	24.3	32	6.5	8

Type	D1 Ø	D2	H3	H4	H6	L3	L4	L5	L9
VABM-B10-25S-N38-...	5.5	M4x9	34	13.5	20	6	29.8	27.5	9.5

Valve positions	2	3	4	5	6	7	8	9	10
L1 [mm]	87	114.5	142	169.5	197	224.5	252	279.5	307
L2 [mm]	75	102.5	130	157.5	185	212.5	240	267.5	295

Manifold block VABM, NPT

Technical data – Manifold block, size 25

Dimensions

Supply manifold, mounting on both sides

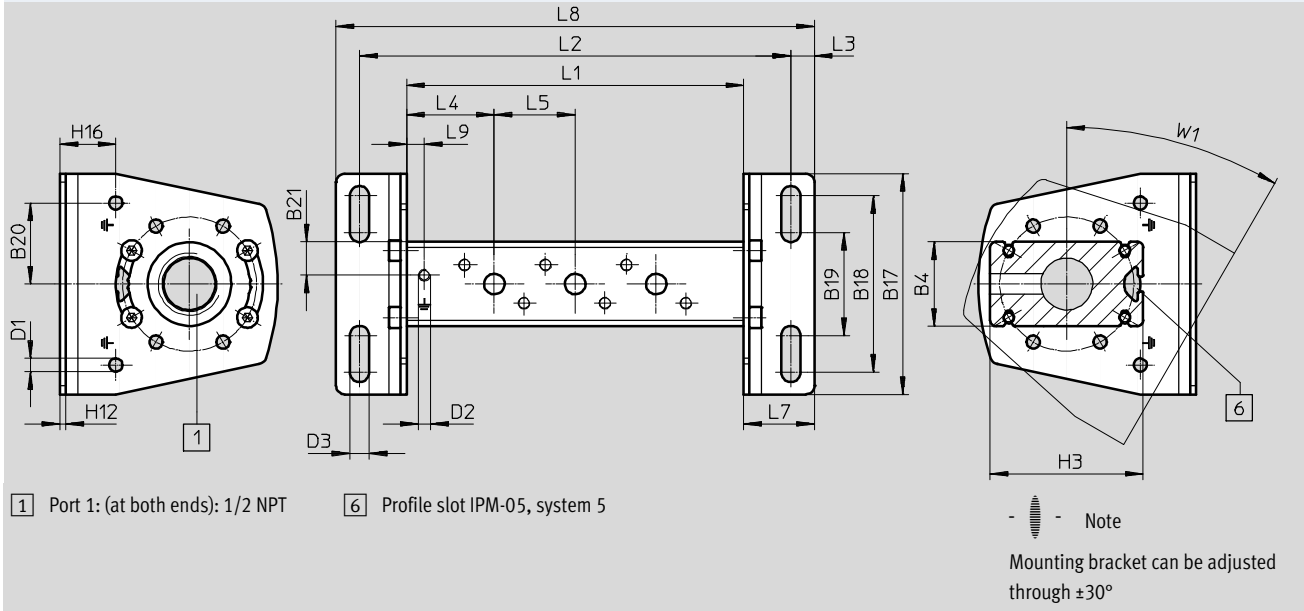









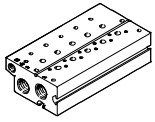

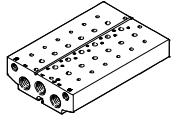
Type	B4	B17	B18	B19	B20	B21	D1 \varnothing	D2	D3 \varnothing	H3	H12	H16	L3	L4	L5	L7	L9	W1
VABM-B10-25-N12-...-P53	28.7	75	60	35	27.5	11.4	4.5	M4x9	6.6	52	2	19	8	29.8	27.5	24	6	30

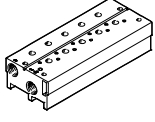
Valve positions	2	3	4	5	6	7	8	9	10
L1 [mm]	87	114.5	142	169.5	197	224.5	252	279.5	307
L2 [mm]	119	146.5	174	201.5	229	256.5	284	311.5	339
L8 [mm]	135	162.5	190	217.5	245	272.5	300	327.5	355

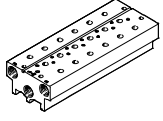

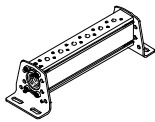

Manifold block VABM, NPT

Ordering data – Manifold block, size 25

Ordering data			
Description	Valve positions	Part No.	Type
Standard manifold block			
 <p>For 3/2-way valves, incl. seals and screws for mounting valves</p> <p>-  - Note Blanking plugs for sealing the supply ports (1, 3 and 14) at one end are included in the scope of delivery.</p>	2	8026288	VABM-B10-25E-N12-2-P3
	3	8026289	VABM-B10-25E-N12-3-P3
	4	8026290	VABM-B10-25E-N12-4-P3
	5	8026291	VABM-B10-25E-N12-5-P3
	6	8026292	VABM-B10-25E-N12-6-P3
	7	8026293	VABM-B10-25E-N12-7-P3
	8	8026294	VABM-B10-25E-N12-8-P3
	9	8026295	VABM-B10-25E-N12-9-P3
	10	8026296	VABM-B10-25E-N12-10-P3
	 <p>For 5/2- and 5/3-way valves, incl. seals and screws for valve assembly</p> <p>-  - Note Blanking plugs for sealing the supply ports (1, 3, 5, 12 and 14) at one end are included in the scope of delivery.</p>	2	8026252
3		8026253	VABM-B10-25E-N12-3
4		8026254	VABM-B10-25E-N12-4
5		8026255	VABM-B10-25E-N12-5
6		8026256	VABM-B10-25E-N12-6
7		8026257	VABM-B10-25E-N12-7
8		8026258	VABM-B10-25E-N12-8
9		8026259	VABM-B10-25E-N12-9
10		8026260	VABM-B10-25E-N12-10
Compact manifold block			
 <p>For 3/2-way valves, incl. seals and screws for mounting valves</p> <p>-  - Note Blanking plugs for sealing the supply ports (1 and 3) at one end are included in the scope of delivery.</p>	2	8026306	VABM-B10-25S-N38-2-P3
	3	8026307	VABM-B10-25S-N38-3-P3
	4	8026308	VABM-B10-25S-N38-4-P3
	5	8026309	VABM-B10-25S-N38-5-P3
	6	8026310	VABM-B10-25S-N38-6-P3
	7	8026311	VABM-B10-25S-N38-7-P3
	8	8026312	VABM-B10-25S-N38-8-P3
	9	8026313	VABM-B10-25S-N38-9-P3
	10	8026314	VABM-B10-25S-N38-10-P3
	 <p>For 5/2- and 5/3-way valves, incl. seals and screws for valve assembly</p> <p>-  - Note Blanking plugs for sealing the supply ports (1, 3 and 5) at one end are included in the scope of delivery.</p>	2	8026270
3		8026271	VABM-B10-25S-N38-3
4		8026272	VABM-B10-25S-N38-4
5		8026273	VABM-B10-25S-N38-5
6		8026274	VABM-B10-25S-N38-6
7		8026275	VABM-B10-25S-N38-7
8		8026276	VABM-B10-25S-N38-8
9		8026277	VABM-B10-25S-N38-9
10		8026278	VABM-B10-25S-N38-10
Supply manifold			
 <p>For mounting on both sides, incl. seals and screws for mounting valves</p> <p>-  - Note Blanking plug for sealing the supply port (1) at one end included in the scope of delivery.</p>	2	8026228	VABM-B10-25-N12-2-P53
	3	8026229	VABM-B10-25-N12-3-P53
	4	8026230	VABM-B10-25-N12-4-P53
	5	8026231	VABM-B10-25-N12-5-P53
	6	8026232	VABM-B10-25-N12-6-P53
	7	8026233	VABM-B10-25-N12-7-P53
	8	8026234	VABM-B10-25-N12-8-P53
	9	8026235	VABM-B10-25-N12-9-P53
	10	8026236	VABM-B10-25-N12-10-P53

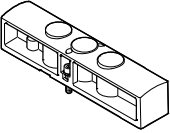
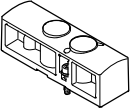
Manifold block VABM, NPT

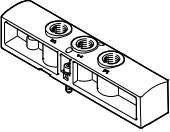
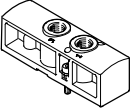

Accessories – Manifold block, size 25

Ordering data			
Description	Weight [g]	Part No.	Type
Blanking plate			
	For valve position on manifold block for 5/2-, 5/3-way valves	117	8026209 VABB-B10-25-E
	For valve position on manifold block for 3/2-way valves	84	8026210 VABB-B10-25-E-P3
	For valve position on supply manifold	28	8026208 VABB-B10-25-A
Supply plate			
	For valve position on manifold block for 5/2-, 5/3-way valves	110	8026318 VABF-B10-25-P1A4-G14
	For valve position on manifold block for 3/2-way valves	80	8026319 VABF-B10-25-P1A4-G14-P3
Supply plate			
	For valve position on supply manifold	26	8026317 VABF-B10-25-P1-G14
Set of spare parts			
	Set comprising: <ul style="list-style-type: none"> • Seals and • Screws 	12	8035636 VAME-B10-25-MK



Manifold block VABM, NPT

Accessories – Manifold block, size 25

FESTO

Ordering data					
	Description of NPT thread	Part No.	Type	PU ¹⁾	
Push-in fitting with internal hex					
	Connecting thread 1/8 NPT for tubing O.D.	1/4 "	572318	QB-1/8-1/4-I-U	10
	Connecting thread 3/8 NPT for tubing O.D.	5/16 "	572323	QB-3/8-5/16-I-U	10
		3/8 "	572324	QB-3/8-3/8-I-U	10
		1/2 "	572325	QB-3/8-1/2-I-U	10
	Connecting thread 1/2 NPT for tubing O.D.	1/2 "	572326	QB-1/2-1/2-I-U	10
Push-in fitting with external hex					
	Connecting thread 1/2 NPT for tubing O.D.	3/8 "	533283	QB-1/2-3/8-U	5
Angled push-in fitting with external hex					
	Connecting thread 3/8 NPT for tubing O.D.	5/16 "	533299	QBL-3/8-5/16-U	5
		3/8 "	533300	QBL-3/8-3/8-U	5
		1/2 "	533301	QBL-3/8-1/2-U	5
	Connecting thread 1/2 NPT for tubing O.D.	3/8 "	533302	QBL-1/2-3/8-U	5
		1/2 "	533303	QBL-1/2-1/2-U	5

1) Packaging unit

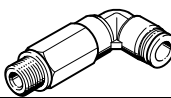
Ordering data					
	Description of G thread	Part No.	Type	PU ¹⁾	
Push-in fitting with internal hex					
	Connecting thread G1/4 for tubing O.D.	6 mm	186108	QS-G1/4-6-I	10
		8 mm	186110	QS-G1/4-8-I	10
		10 mm	186112	QS-G1/4-10-I	10
Angled push-in fitting with external hex					
	Connecting thread G1/4 for tubing O.D.	6 mm	186118	QSL-G1/4-6	10
			132051	QSL-G1/4-6-100	100
		8 mm	186120	QSL-G1/4-8	10
			132052	QSL-G1/4-8-50	50
		10 mm	186122	QSL-G1/4-10	10
			132053	QSL-G1/4-10-50	50
Angled push-in fitting, long, with external hex					
	Connecting thread G1/4 for tubing O.D.	6 mm	186129	QSLL-G1/4-6	10
		8 mm	186131	QSLL-G1/4-8	10
		10 mm	186133	QSLL-G1/4-10	10

1) Packaging unit

Manifold block VABM, NPT

Accessories – Manifold block, size 25

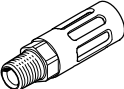

FESTO

Ordering data					
	Description of NPT thread		Part No.	Type	PU ¹⁾
Silencer					
	With connecting thread NPT (metal design)	3/8 NPT	12740	U-3/8-B-NPT	1
		1/2 NPT	12741	U-1/2-B-NPT	1

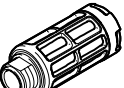
1) Packaging unit

Ordering data					
	Description of G thread		Part No.	Type	PU ¹⁾
Silencer					
	With connecting thread G (plastic design)	G1/4	2316	U-1/4	1
			534223	U-1/4-20	20

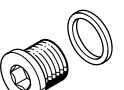
1) Packaging unit

Ordering data					
	Description		Part No.	Type	PU ¹⁾
Blanking plug					
	With connecting thread NPT	1/8 NPT	173985	B-1/8-NPT	1
		3/8 NPT	174169	B-3/8-NPT	1
		1/2 NPT	31785	B-1/2-NPT	1
Separator					
	For creating pressure zones for port	G1/8	569995	VABD-8-B	1
		1/8 NPT			
		G3/8	574483	VABD-14-B	1
		3/8 NPT			
		G1/2	8022483	VABD-17.5-B	1
		1/2 NPT			
H-rail mounting					
	For size 25, for mounting on standard H-rails TH 35-7.5 or TH 35-15 to EN 60715		2636436	VAME-T-M5	2

1) Packaging unit

Manifold block VABM, NPT

Technical data – Manifold block, size 30

 Flow rate
Up to 2300 l/min

 Valve width
31 mm



General technical data					
	Manifold block standard		Manifold block compact		Supply manifold on both sides
For valves	3/2	5/2, 5/3	3/2	5/2, 5/3	3/2, 5/2, 5/3
Grid dimension [mm]	32				
Type of mounting	With through-hole				With mounting bracket
Maximum number of valve positions	10	10	10	10	10
Port 1	3/4 NPT	3/4 NPT	1/2 NPT	1/2 NPT	3/4 NPT
Port 3	3/4 NPT	3/4 NPT	1/2 NPT	1/2 NPT	–
Port 5	–	3/4 NPT	–	1/2 NPT	–
Port 12	1/8 NPT	1/8 NPT	–	–	–
Port 14	–	1/8 NPT	–	–	–
CRC ¹⁾	2 ¹⁾				

1) Corrosion resistance class CRC 2 to Festo standard FN 940070
Moderate corrosion stress. Indoor applications in which condensation may occur. External visible parts with primarily decorative requirements for the surface and which are in direct contact with the ambient atmosphere typical for industrial applications.

Weight [g]									
Valve positions	2	3	4	5	6	7	8	9	10
Manifold block for 3/2-way valves, standard									
VABM-B10-30E-N34-...-P3	1411	1828	2245	2662	3079	3496	3913	4330	4747
Manifold block for 5/2- and 5/3-way valves, standard									
VABM-B10-30E-N34-...	1722	2213	2703	3194	3684	4175	4665	5156	5646
Manifold block for 3/2-way valves, compact									
VABM-B10-30S-N12-...-P3	652	872	1093	1313	1533	1753	1973	2193	2413
Manifold block for 5/2- and 5/3-way valves, compact									
VABM-B10-30S-N12-...	759	1013	1267	1522	1776	2030	2285	2539	2793
Supply manifold for mounting on both sides									
VABM-B10-30-N34-...-P53	818	977	1135	1293	1452	1610	1768	1927	2085

Information on materials	
Materials	Wrought aluminium alloy
Note on materials	RoHS compliant

Manifold block VABM, NPT

Technical data – Manifold block, size 30

Dimensions

Manifold block for 3/2-way valves, standard

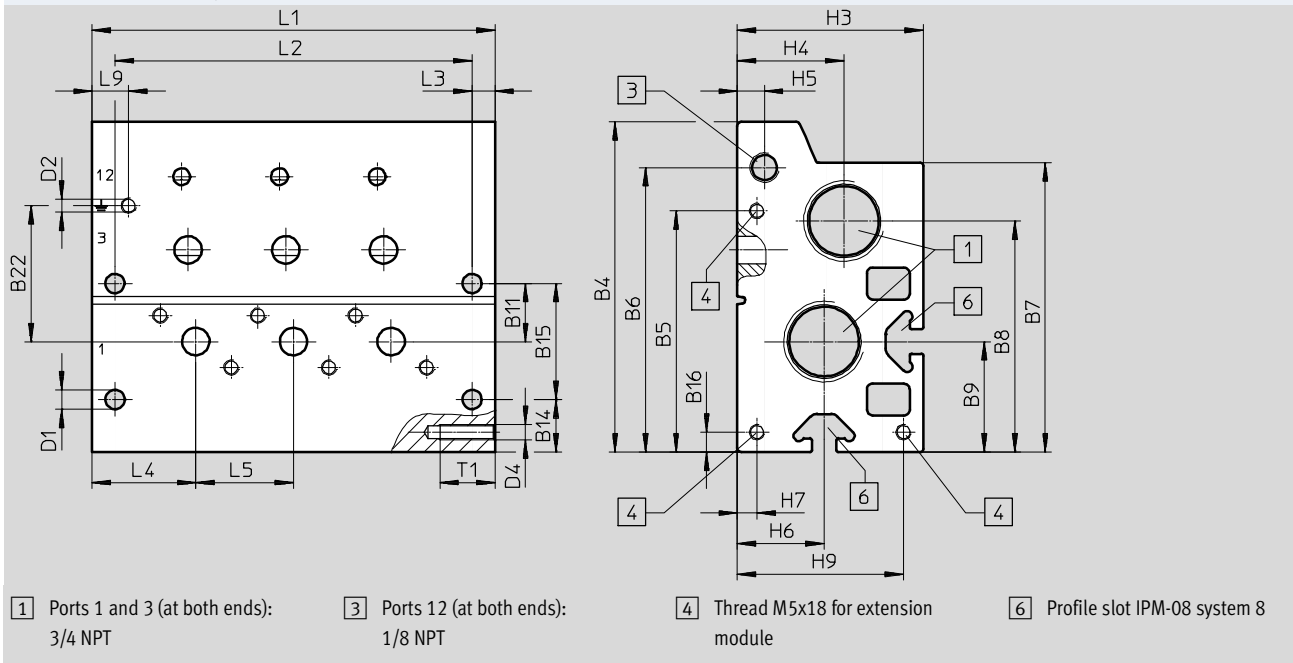

Type	B4	B5	B6	B7	B8	B9	B11	B14	B15	B16	B22
VABM-B10-30-E-N34-...-P3	108.2	79	93.2	94.7	75.7	36.2	19	17.2	38	6.5	44.5

Type	D1 Ø	D2	D4	H3	H4	H5	H6	H7	H9	L3	L4	L5	L9	T1
VABM-B10-30-E-N34-...-P3	6.3	M5x11	M5	61	35	9	28.5	6.5	54.5	7.5	34	32	12	18

Valve positions	2	3	4	5	6	7	8	9	10
L1 [mm]	100	132	164	196	228	260	292	324	356
L2 [mm]	85	117	149	181	213	245	277	309	341

Manifold block VABM, NPT

Technical data – Manifold block, size 30

Dimensions

Manifold block for 5/2- and 5/3-way valves, standard

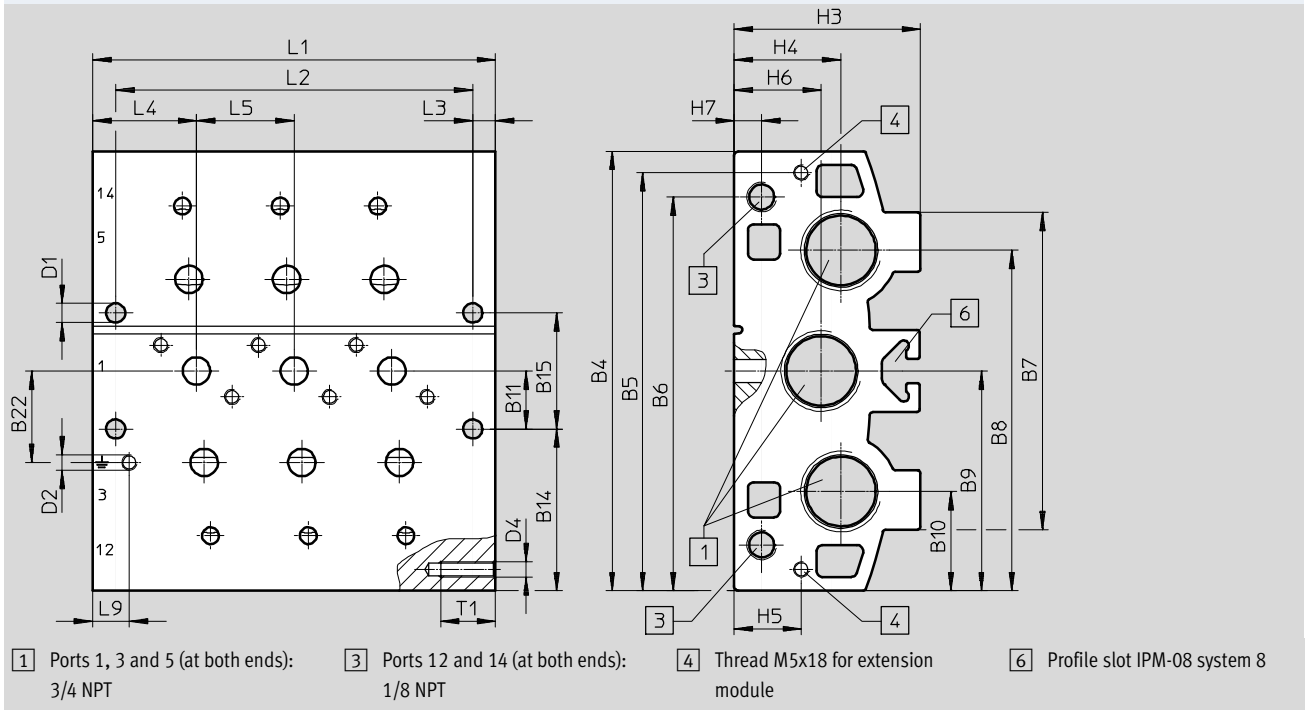

Type	B4	B5	B6	B7	B8	B9	B10	B11	B14	B15	B22
VABM-B10-30E-N34-...	144	137	129	104	111.5	72	32.5	19	53	38	30

Type	D1 Ø	D2	D4	H3	H4	H5	H6	H7	L3	L4	L5	L9	T1
VABM-B10-30E-N34-...	6.3	M5*11	M5	61	35	22	28.5	9	7.5	34	32	12	18

Valve positions	2	3	4	5	6	7	8	9	10
L1 [mm]	100	132	164	196	228	260	292	324	356
L2 [mm]	85	117	149	181	213	245	277	309	341

Manifold block VABM, NPT

Technical data – Manifold block, size 30

Dimensions

Manifold block for 3/2-way valves, compact

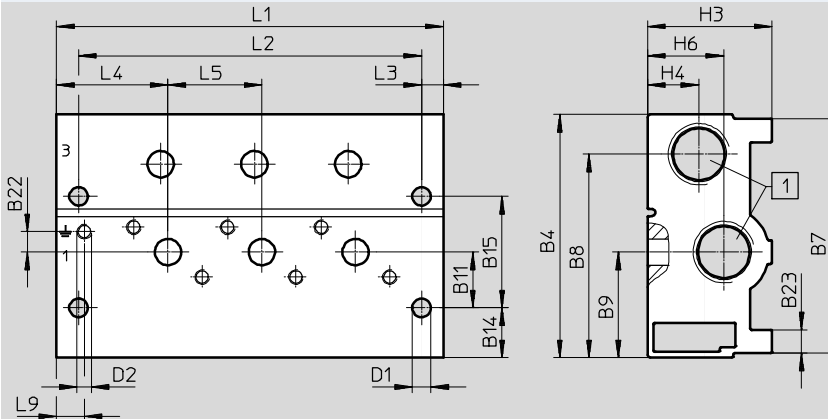

1 Ports 1 and 3 (at both ends):
1/2 NPT

Type	B4	B7	B8	B9	B11	B14	B15	B22	B23
VABM-B10-30S-N12-...-P3	83	80	69.4	36	19	17	38	7	8

Type	D1 Ø	D2	H3	H4	H6	L3	L4	L5	L9
VABM-B10-30S-N12-...-P3	6.3	M5x11	42.5	17.5	26	7.5	38	32	12

Valve positions	2	3	4	5	6	7	8	9	10
L1 [mm]	100	132	164	196	228	260	292	324	356
L2 [mm]	85	117	149	181	213	245	277	309	341

Manifold block VABM, NPT

Technical data – Manifold block, size 30

Dimensions

Manifold block for 5/2- and 5/3-way valves, compact

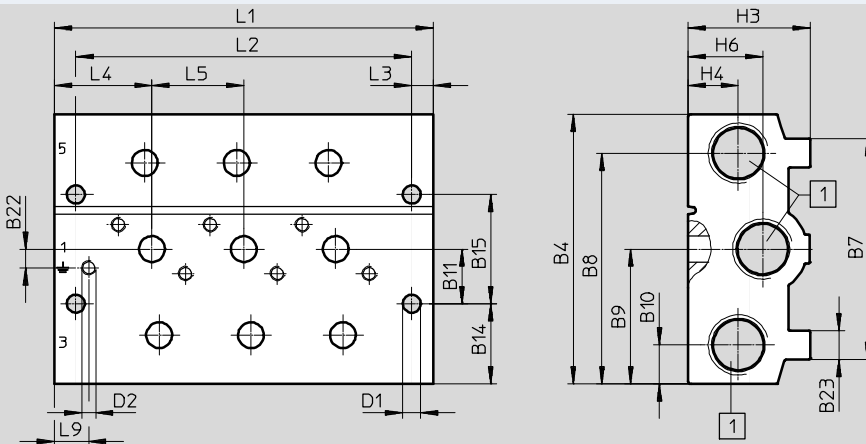

1 Ports 1, 3 and 5 (at both ends):
1/2 NPT

Type	B4	B7	B8	B9	B10	B11	B14	B15	B22	B23
VABM-B10-30S-N12-...	94	77	80.4	47	13.6	19	28	38	6.5	10

Type	D1 Ø	D2	H3	H4	H6	L3	L4	L5	L9
VABM-B10-30S-N12-...	6.3	M5x11	42.5	17.5	26	7.5	34	32	12

Valve positions	2	3	4	5	6	7	8	9	10
L1 [mm]	100	132	164	196	228	260	292	324	356
L2 [mm]	85	117	149	181	213	245	277	309	341

Manifold block VABM, NPT

Technical data – Manifold block, size 30

Dimensions

Supply manifold, mounting on both sides

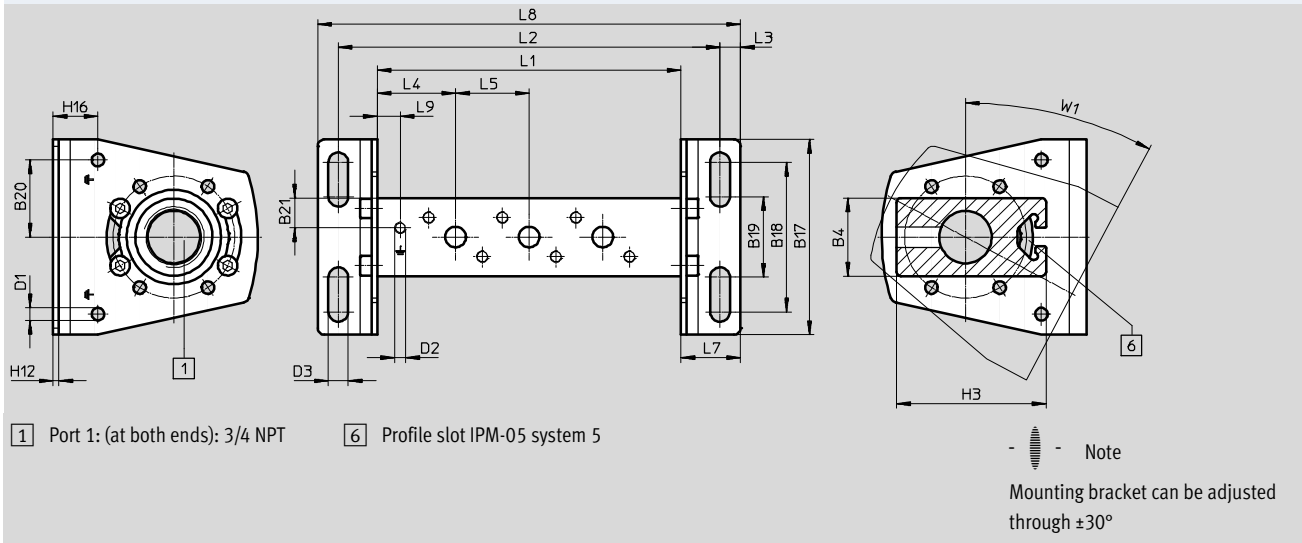









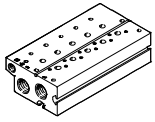

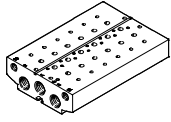
Type	B4	B17	B18	B19	B20	B21	D1 ∅	D2	D3 ∅	H3	H12	H16	L3	L4	L5	L7	L9	W1
VABM-B10-30-N34-...-P53	34	85	65	35	33.5	13	5.5	M5x11	8.6	65	2.5	19.5	9	34	32	26	10	28°

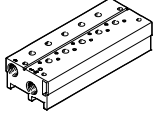
Valve positions	2	3	4	5	6	7	8	9	10
L1 [mm]	100	132	164	196	228	260	292	324	356
L2 [mm]	134	166	198	230	262	294	326	358	390
L8 [mm]	152	184	216	248	280	312	344	376	408

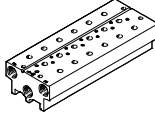

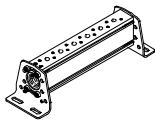

Manifold block VABM, NPT

Ordering data – Manifold block, size 30

Ordering data			
Description	Valve positions	Part No.	Type
Standard manifold block			
 <p>For 3/2-way valves, incl. seals and screws for mounting valves</p> <p>-  - Note Blanking plugs for sealing the supply ports (1, 3 and 14) at one end are included in the scope of delivery.</p>	2	8026404	VABM-B10-30E-N34-2-P3
	3	8026405	VABM-B10-30E-N34-3-P3
	4	8026406	VABM-B10-30E-N34-4-P3
	5	8026407	VABM-B10-30E-N34-5-P3
	6	8026408	VABM-B10-30E-N34-6-P3
	7	8026409	VABM-B10-30E-N34-7-P3
	8	8026410	VABM-B10-30E-N34-8-P3
	9	8026411	VABM-B10-30E-N34-9-P3
	10	8026412	VABM-B10-30E-N34-10-P3
	 <p>For 5/2- and 5/3-way valves, incl. seals and screws for valve assembly</p> <p>-  - Note Blanking plugs for sealing the supply ports (1, 3, 5, 12 and 14) at one end are included in the scope of delivery.</p>	2	8026368
3		8026369	VABM-B10-30E-N34-3
4		8026370	VABM-B10-30E-N34-4
5		8026371	VABM-B10-30E-N34-5
6		8026372	VABM-B10-30E-N34-6
7		8026373	VABM-B10-30E-N34-7
8		8026374	VABM-B10-30E-N34-8
9		8026375	VABM-B10-30E-N34-9
10		8026376	VABM-B10-30E-N34-10
Compact manifold block			
 <p>For 3/2-way valves, incl. seals and screws for mounting valves</p> <p>-  - Note Blanking plugs for sealing the supply ports (1 and 3) at one end are included in the scope of delivery.</p>	2	8026422	VABM-B10-30S-N12-2-P3
	3	8026423	VABM-B10-30S-N12-3-P3
	4	8026424	VABM-B10-30S-N12-4-P3
	5	8026425	VABM-B10-30S-N12-5-P3
	6	8026426	VABM-B10-30S-N12-6-P3
	7	8026427	VABM-B10-30S-N12-7-P3
	8	8026428	VABM-B10-30S-N12-8-P3
	9	8026429	VABM-B10-30S-N12-9-P3
	10	8026430	VABM-B10-30S-N12-10-P3
	 <p>For 5/2- and 5/3-way valves, incl. seals and screws for valve assembly</p> <p>-  - Note Blanking plugs for sealing the supply ports (1, 3 and 5) at one end are included in the scope of delivery.</p>	2	8026386
3		8026387	VABM-B10-30S-N12-3
4		8026388	VABM-B10-30S-N12-4
5		8026389	VABM-B10-30S-N12-5
6		8026390	VABM-B10-30S-N12-6
7		8026391	VABM-B10-30S-N12-7
8		8026392	VABM-B10-30S-N12-8
9		8026393	VABM-B10-30S-N12-9
10		8026394	VABM-B10-30S-N12-10
Supply manifold			
 <p>For mounting on both sides, incl. seals and screws for mounting valves</p> <p>-  - Note Blanking plug for sealing the supply port (1) at one end included in the scope of delivery.</p>	2	8026347	VABM-B10-30-N34-2-P53
	3	8026348	VABM-B10-30-N34-3-P53
	4	8026349	VABM-B10-30-N34-4-P53
	5	8026350	VABM-B10-30-N34-5-P53
	6	8026351	VABM-B10-30-N34-6-P53
	7	8026352	VABM-B10-30-N34-7-P53
	8	8026353	VABM-B10-30-N34-8-P53
	9	8026354	VABM-B10-30-N34-9-P53
	10	8026355	VABM-B10-30-N34-10-P53

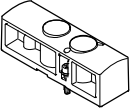
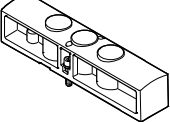

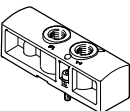
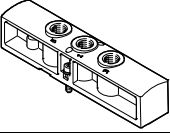

Manifold block VABM, NPT

Accessories – Manifold block, size 30

Ordering data			
Description	Weight [g]	Part No.	Type
Blanking plate			
 For valve position on manifold block for 3/2-way valves	128	8026336	VABB-B10-30-E-P3
 For valve position on manifold block for 5/2-, 5/3-way valves	179	8026335	VABB-B10-30-E
 For valve position on supply manifold	43	8026334	VABB-B10-30-A
Supply plate			
 For valve position on manifold block for 3/2-way valves	121	8026435	VABF-B10-30-P1A4-G38-P3
 For valve position on manifold block for 5/2-, 5/3-way valves	167	8026434	VABF-B10-30-P1A4-G38
Supply plate			
 For valve position on supply manifold	40	8026433	VABF-B10-30-P1-G38

Manifold block VABM, NPT

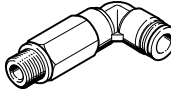
Accessories – Manifold block, size 30

Ordering data					
	Description of NPT thread	Part No.	Type	PU ¹⁾	
Push-in fitting with internal hex					
	Connecting thread 1/8 NPT for tubing O.D.	1/4 "	572318	QB-1/8-1/4-I-U	10
	Connecting thread 3/8 NPT for tubing O.D.	5/16 "	572323	QB-3/8-5/16-I-U	10
		3/8 "	572324	QB-3/8-3/8-I-U	10
		1/2 "	572325	QB-3/8-1/2-I-U	10
	Connecting thread 1/2 NPT for tubing O.D.	1/2 "	572326	QB-1/2-1/2-I-U	10
Push-in fitting with external hex					
	Connecting thread 1/2 NPT for tubing O.D.	3/8 "	533283	QB-1/2-3/8-U	5
Angled push-in fitting with external hex					
	Connecting thread 3/8 NPT for tubing O.D.	5/16 "	533299	QBL-3/8-5/16-U	5
		3/8 "	533300	QBL-3/8-3/8-U	5
		1/2 "	533301	QBL-3/8-1/2-U	5
	Connecting thread 1/2 NPT for tubing O.D.	3/8 "	533302	QBL-1/2-3/8-U	5
		1/2 "	533303	QBL-1/2-1/2-U	5
Angled push-in fitting, long, with external hex					
	Connecting thread 3/8 NPT for tubing O.D.	5/16 "	564679	QBLL-3/8-5/16-U	5
		3/8 "	564680	QBLL-3/8-3/8-U	5
		1/2 "	564681	QBLL-3/8-1/2-U	5
Barbed fitting with external hex					
	Connecting thread 3/4 NPT for tubing I.D. Aluminium design	19 mm	564848	N-3/4-P-19-NPT	1

1) Packaging unit

Ordering data					
	Description of G thread	Part No.	Type	PU ¹⁾	
Push-in fitting with internal hex					
	Connecting thread G3/8 for tubing O.D.	12 mm	186114	QS-G3/8-12-I	10

1) Packaging unit

Manifold block VABM, NPT

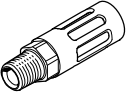

Accessories – Manifold block, size 30

Ordering data					
Description of NPT thread		Part No.	Type	PU ¹⁾	
Silencer					
	With connecting thread NPT (metal design)	3/8 NPT	12740	U-3/8-B-NPT	1
		1/2 NPT	12741	U-1/2-B-NPT	1
		3/4 NPT	566823	U-3/4-B-NPT	1

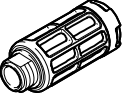
1) Packaging unit

Ordering data					
Description of G thread		Part No.	Type	PU ¹⁾	
Silencer					
	With connecting thread G (plastic design)	G3/8	6843	U-3/8-B	1

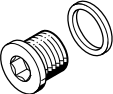
1) Packaging unit

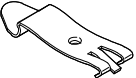
Ordering data					
Description		Part No.	Type	PU ¹⁾	
Blanking plug					
	With connecting thread NPT	1/8 NPT	173985	B-1/8-NPT	1
		1/2 NPT	31785	B-1/2-NPT	1
		3/4 NPT	31786	B-3/4-NPT	1
Separator					
	For creating pressure zones for port	G1/8	569995	VABD-8-B	1
		1/8 NPT			
		G1/2	8022483	VABD-17.5-B	1
		1/2 NPT			
		G3/4	8022484	VABD-22.7-B	1
		3/4 NPT			
H-rail mounting					
	For size 30, for mounting on standard H-rails TH 35-7.5 or TH 35-15 to EN 60715	3488412	VAME-T-M6	2	

1) Packaging unit

Product Range and Company Overview

A Complete Suite and Company Overview

Our experienced engineers provide complete support at every stage of your development process, including: conceptualization, analysis, engineering, design, assembly, documentation, validation, and production.



Custom Automation Components
Complete custom engineered solutions



Custom Control Cabinets
Comprehensive engineering support and on-site services



Complete Systems
Shipment, stocking and storage services

The Broadest Range of Automation Components

With a comprehensive line of more than 30,000 automation components, Festo is capable of solving the most complex automation requirements.



Electromechanical
Electromechanical actuators, motors, controllers & drivers



Pneumatics
Pneumatic linear and rotary actuators, valves, and air supply



PLCs and I/O Devices
PLC's, operator interfaces, sensors and I/O devices

Supporting Advanced Automation... As No One Else Can!

Festo is a leading global manufacturer of pneumatic and electromechanical systems, components and controls for industrial automation, with more than 16,000 employees in 60 national headquarters serving more than 180 countries. For more than 80 years, Festo has continuously elevated the state of manufacturing with innovations and optimized motion control solutions that deliver higher performing, more profitable automated manufacturing and processing equipment. Our dedication to the advancement of automation extends beyond technology to the education and development of current and future automation and robotics designers with simulation tools, teaching programs, and on-site services.

Quality Assurance, ISO 9001 and ISO 14001 Certifications

Festo Corporation is committed to supply all Festo products and services that will meet or exceed our customers' requirements in product quality, delivery, customer service and satisfaction.

To meet this commitment, we strive to ensure a consistent, integrated, and systematic approach to management that will meet or exceed the requirements of the ISO 9001 standard for Quality Management and the ISO 14001 standard for Environmental Management.



© Copyright 2013, Festo Corporation. While every effort is made to ensure that all dimensions and specifications are correct, Festo cannot guarantee that publications are completely free of any error, in particular typing or printing errors. Accordingly, Festo cannot be held responsible for the same. For Liability and Warranty conditions, refer to our "Terms and Conditions of Sale", available from your local Festo office. All rights reserved. No part of this publication may be reproduced, distributed, or transmitted in any form or by any means, electronic, mechanical, photocopying or otherwise, without the prior written permission of Festo. All technical data subject to change according to technical update.



Printed on recycled paper at New Horizon Graphic, Inc., FSC certified as an environmental friendly printing plant.

Festo North America

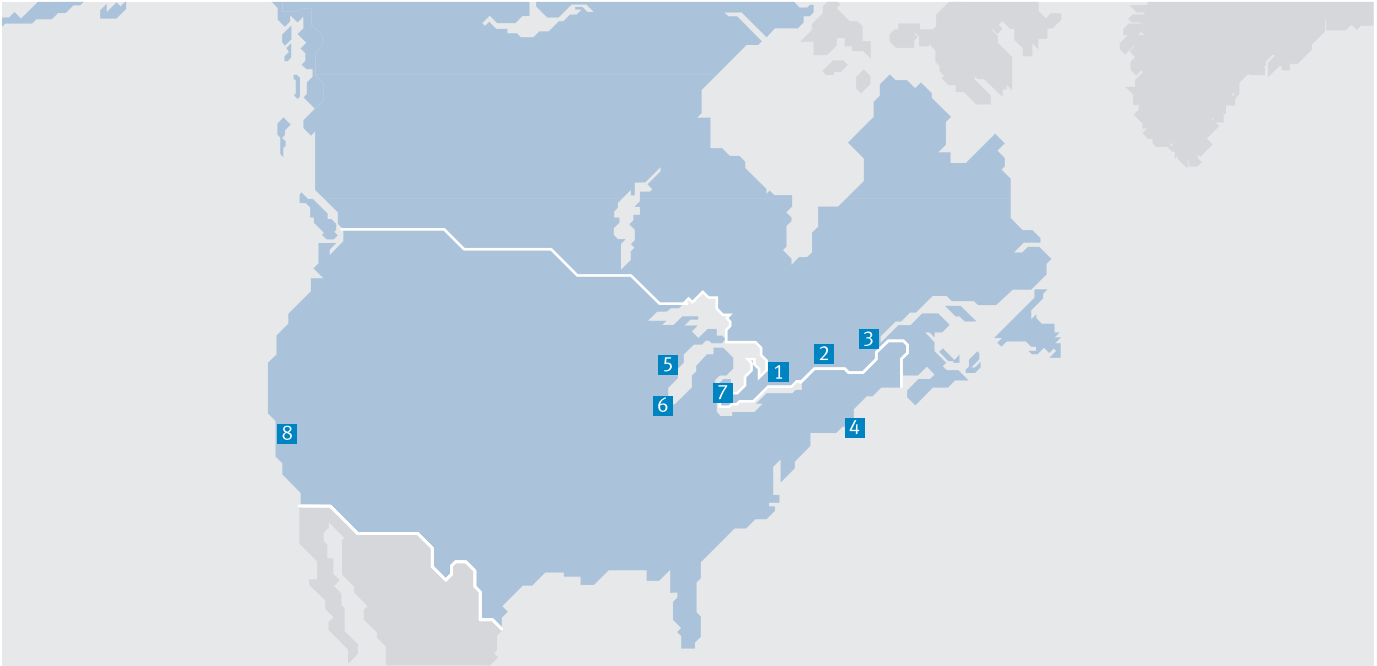

**1 Festo Canada
Headquarters
Festo Inc.**
5300 Explorer Drive
Mississauga, ON
L4W 5G4

2 Montréal
5600, Trans-Canada
Pointe-Claire, QC
H9R 1B6

3 Québec City
2930, rue Watt#117
Québec, QC
G1X 4G3



**4 Festo United States
Headquarters
Festo Corporation**
395 Moreland Road
Hauppauge, NY
11788

5 Appleton
North 922 Tower View Drive, Suite N
Greenville, WI
54942

7 Detroit
1441 West Long Lake Road
Troy, MI
48098

6 Chicago
85 W Algonquin - Suite 340
Arlington Heights, IL
60005

8 Silicon Valley
4935 Southfront Road, Suite F
Livermore, CA
94550

Festo Regional Contact Center

Canadian Customers

Commercial Support:
Tel: 1 877 GO FESTO (1 877 463 3786)
Fax: 1 877 FX FESTO (1 877 393 3786)
Email: festo.canada@ca.festo.com

Technical Support:
Tel: 1 866 GO FESTO (1 866 463 3786)
Fax: 1 877 FX FESTO (1 877 393 3786)
Email: technical.support@ca.festo.com

USA Customers

Commercial Support:
Tel: 1 800 99 FESTO (1 800 993 3786)
Fax: 1 800 96 FESTO (1 800 963 3786)
Email: customer.service@us.festo.com

Technical Support:
Tel: 1 866 GO FESTO (1 866 463 3786)
Fax: 1 800 96 FESTO (1 800 963 3786)
Email: product.support@us.festo.com