

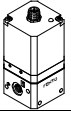

# Proportional pressure regulators VPPE



# Proportional pressure regulators VPPE

Product range overview

Function	Version	Pneumatic connection	Nominal size for pressurisation/exhaust [mm]	Pressure regulation range [bar]	Setpoint input		→ Page/Internet
					Voltage type 0 ... 10 V	Current type 4 ... 20 mA	
Proportional pressure regulator	<b>Without display</b>						
		G1/8	5/2.5	0.15 ... 6	■	-	6
	<b>With display</b>						
		G1/8	5/2.5	0.02 ... 2	■	■	10
0.06 ... 6							
0.1 ... 10							

# Proportional pressure regulators VPPE

Peripherals overview

FESTO

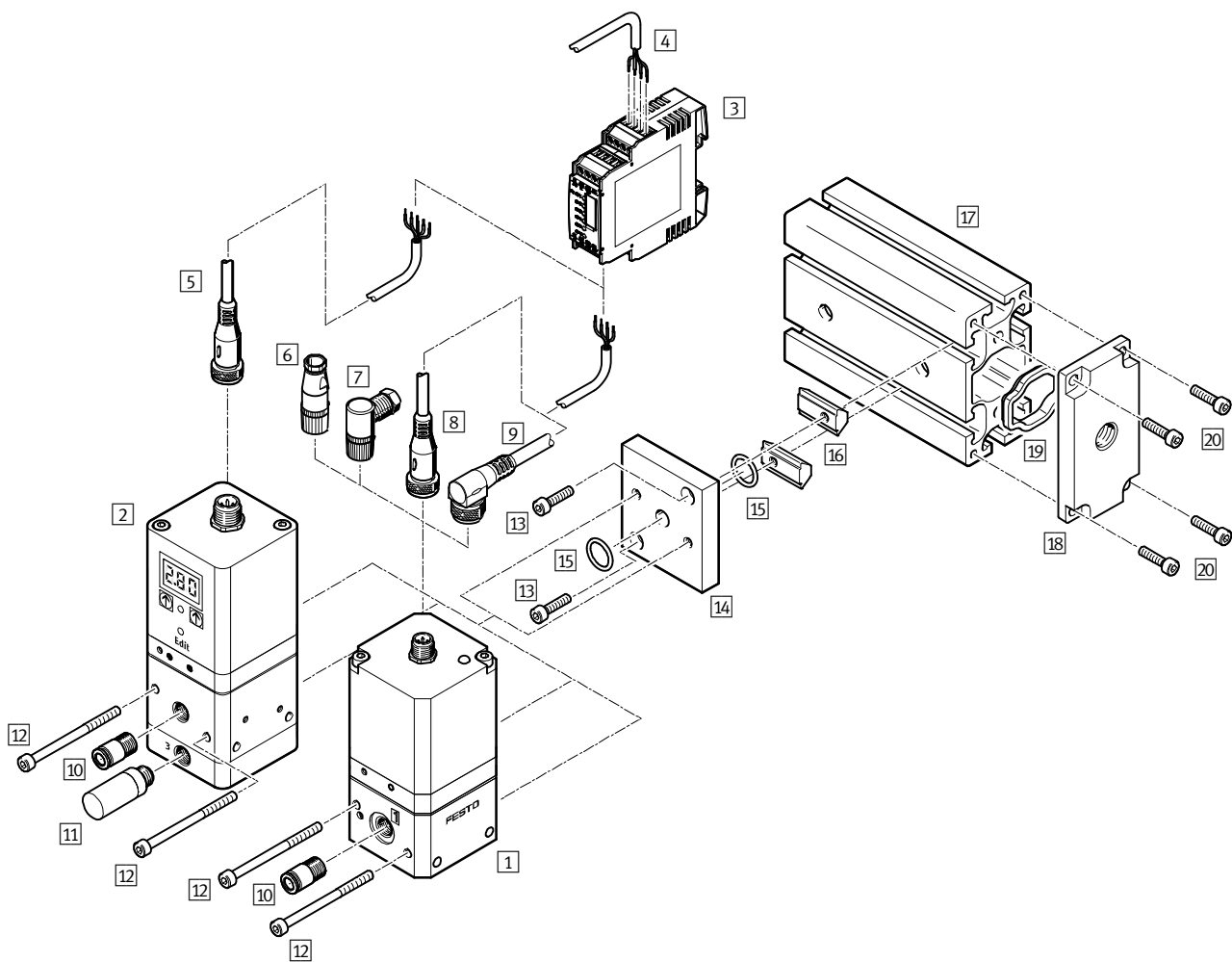

Accessories				
	Type	Brief description	→ Page/Internet	
1	Prop. pressure regulator	VPPE...	–	8
2	Prop. pressure regulator with display	VPPE ... E1	–	13
3	Setpoint module	MPZ	For generating 6+1 analogue voltage signals	8, 13
4	Digital input/output	–	For actuating the setpoint module	–
5	Connecting cable	SIM-M12-5GD-...-PU	With straight plug socket for actuating the VPPE...E1	13
6	Plug socket	SIE-GD	Straight plug socket for actuating the VPPE	8
7	Plug socket	SIE-WD-TR	Angled plug socket for actuating the VPPE	8
8	Connecting cable	SIM-M12-4GD-5PU	With straight plug socket for actuating the VPPE	8
9	Connecting cable	SIM-M12-4WD-5PU	With angled plug socket for actuating the VPPE	8
10	Push-in fitting	QS	For connecting compressed air tubing with standard O.D.	quick star
11	Silencer	U	For fitting in exhaust ports	u
12	Socket head screw M4x55	–	For screwing the VPPE to the mounting plate	15
13	Socket head screw M4x16	–	For screwing the mounting plate to the slot nut	15
14	Mounting plate (set)	VAME-P5-MK	For attaching the VPPE to the mounting rail (consists of mounting plate, slot nuts, screws and seals)	15
15	O-ring	–	For sealing	15
16	Slot nuts	–	For clamp fitting components on the mounting rail	15
17	Mounting rail	–	Standard mounting rail as central air supply	15
18	Compressed air supply plate (set)	VABF-P5-P3A3...	For supplying compressed air (consists of compressed air supply plate, screws and seal)	15
19	Seal	–	–	15
20	Socket head screw M5x12	–	For screwing a compressed air supply plate to the mounting rail	15

# Proportional pressure regulators VPPE

Peripherals overview – Additional power supply

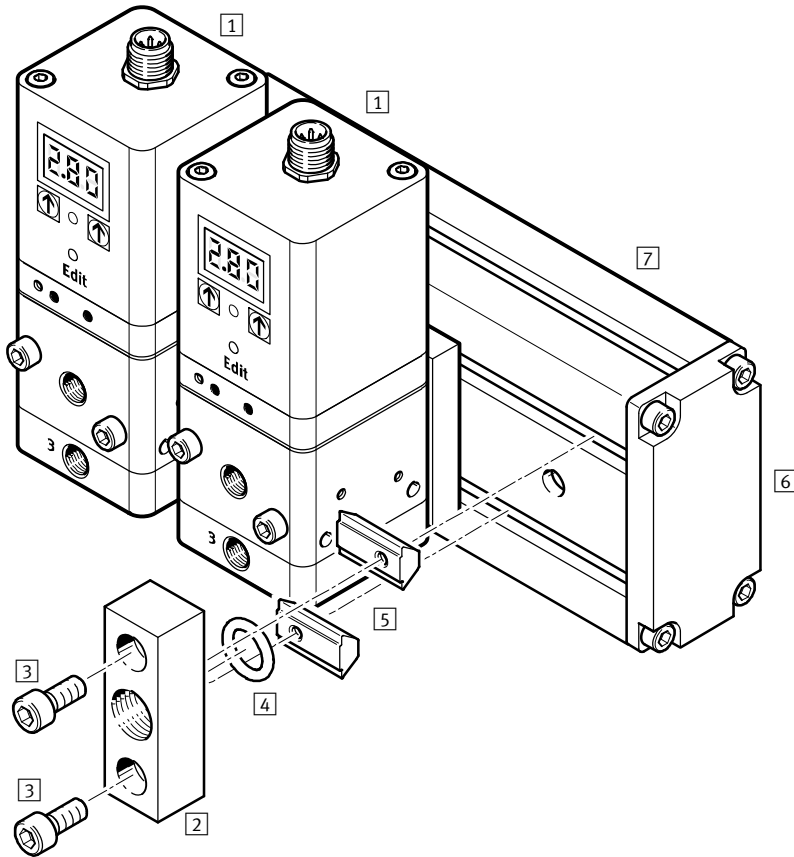

Accessories				
	Type	Brief description	→ Page/Internet	
1	Prop. pressure regulator with display	VPPE ... E1	–	13
2	Additional power supply module (set)	VABF-P5-P1A3...	For supplying compressed air (consists of compressed air supply plate, screws and seal)	15
3	Socket head screw M6x20	–	For screwing a compressed air supply plate to the slot nut	15
4	O-ring	–	For sealing	15
5	Slot nuts	–	For clamp fitting components on the mounting rail	15
6	End plate (set)	VABE-P5-C	For sealing the mounting rail (consists of an end plate, screws and seal)	15
7	Mounting rail	IPM-PN-08-40x80-AL	Standard mounting rail as central air supply	15

# Proportional pressure regulators VPPE without display

Type codes

VPPE		-	3	-	1/8	-	6	-	010
<b>Type</b>									
VPPE	Proportional pressure regulator with switching valve head								
<b>Valve function</b>									
3	3-way pressure regulator								
<b>Pneumatic connection</b>									
1/8	G1/8 female thread								
<b>Pressure regulation range</b>									
6	0.15 ... 6 bar								
<b>Analogue setpoint input</b>									
010	0 ... 10 V								

# Proportional pressure regulators VPPE without display

FESTO

Technical data

 Flow rate  
850 l/min

 Voltage  
21.6 ... 26.4 V DC

 Pressure regulation range  
0.15 ... 6 bar

Variants

- Setpoint input as analogue voltage signal 0 ... 10 V



General technical data			
Pneumatic connection 1 and 2		G $\frac{1}{8}$	
Design, valve function		Piloted piston regulator, 3-way proportional pressure regulator, closed	
Sealing principle		Soft	
Actuation type		Electric	
Type of control		Piloted via 2/2-way valves	
Type of mounting		Via through-hole	
Mounting position		Any, preferably vertical	
Nominal size	Pressurisation	[mm]	5
	Exhaust	[mm]	2.5
Standard nominal flow rate		[l/min]	→ Graph
Product weight		[g]	445

## Flow rate $q_n$ as a function of output pressure $p_2$

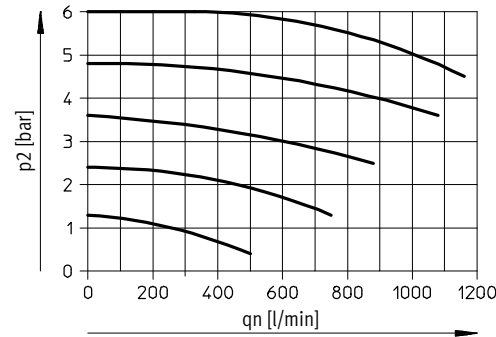

 Note

Output pressure is maintained unregulated if the power supply cable is interrupted.

Electrical data	
Electrical connection	Plug, round design, 4-pin, M12x1
Operating voltage range	[V DC] 21.6 ... 26.4
Power supply indicator	LED
Residual ripple	[%] 10
Max. electrical power consumption	[W] 3.6
Max. current consumption	[mA] 150
Setpoint input signal	[V DC] 0 ... 10
Switching time on/off	[ms] 550/1,300
Protection against short circuit/polarity reversal	For all electrical connections
Protection class	IP65

## M12x1 – Pin allocation for VPPE

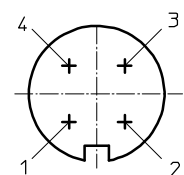

- 1 Supply  
21.6 ... 26.4 V DC
- 2 Setpoint value (-)
- 3 GND (-)
- 4 Setpoint value (+) 0 ... 10 V DC

## Circuit symbol

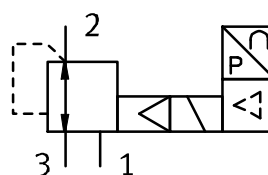

# Proportional pressure regulators VPPE without display

Technical data

Operating and environmental conditions	
Operating medium	Compressed air according to ISO 8573-1:2010 [7:4:4] Inert gases
Note on operating/pilot medium	Lubricated operation not possible
Supply pressure 1	[bar] 7 ... 8
Pressure regulation range	[bar] 0.15 ... 6
Max. pressure hysteresis	[bar] 0.15
Ambient temperature	[°C] 10 ... 50
Temperature of medium	[°C] 10 ... 50
Corrosion resistance class CRC <sup>1)</sup>	2
CE marking (see declaration of conformity)	In accordance with EU EMC Directive <sup>2)</sup>
Certification	RCM trademark
	c UL us - Listed (OL)

- 1) Corrosion resistance class 2 according to Festo standard 940 070  
Components subject to moderate corrosion stress. Externally visible parts with primarily decorative surface requirements which are in direct contact with a normal industrial environment or media such as coolants or lubricating agents.
- 2) For information about the applicability of the component see the manufacturer's EC declaration of conformity at: [www.festo.com/sp](http://www.festo.com/sp) → User documentation.  
If the component is subject to restrictions on usage in residential, office or commercial environments or small businesses, further measures to reduce the emitted interference may be necessary.

Information on materials	
Housing	Wrought aluminium alloy
Seals	Nitrile rubber



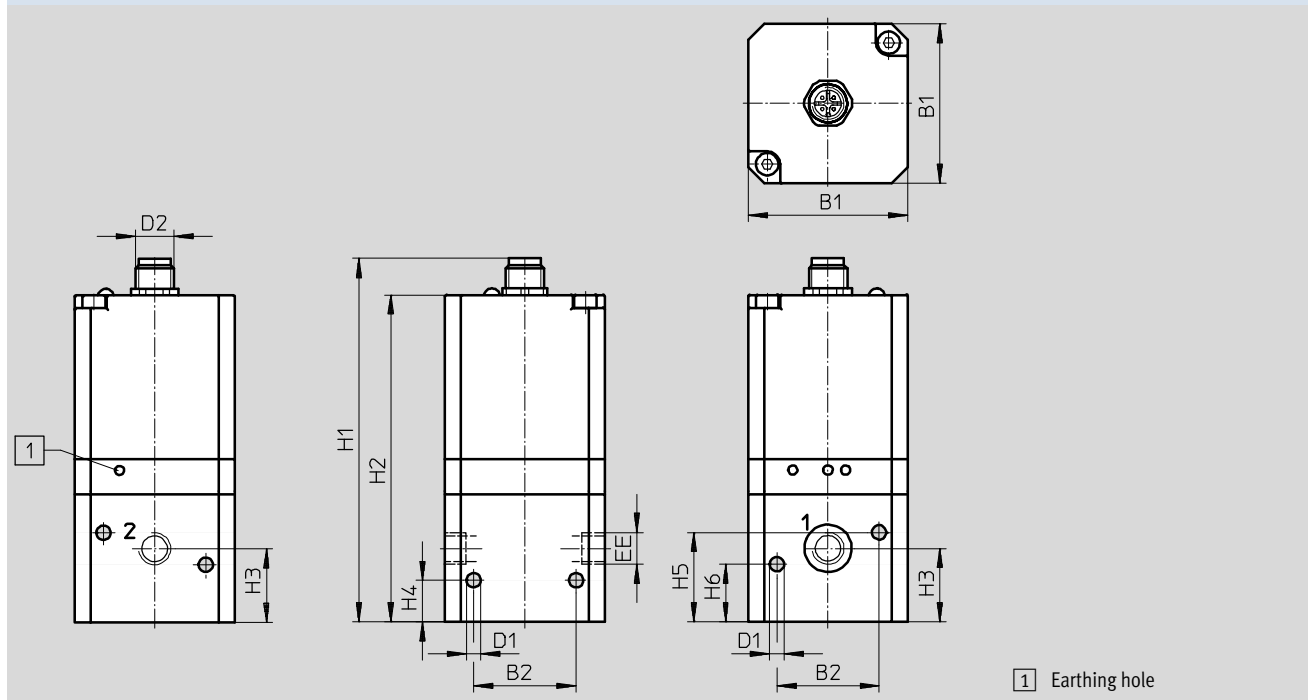

## Dimensions Download CAD data → [www.festo.com](http://www.festo.com)



Type	B1	B2	∅D1	D2	EE	H1	H2	H3	H4	H5	H6
VPPE-3-1/8-6-010	50	32	4.5	M12x1	G1/8	114	102	23	13	28	18

# Proportional pressure regulators VPPE without display

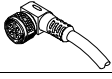
Ordering data

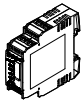
Ordering data		Part No.	Type
Proportional pressure regulator VPPE without display			
	<ul style="list-style-type: none"> <li>• Pressure regulation range: 0 ... 6 bar</li> <li>• Pneumatic connection: G<math>\frac{1}{8}</math></li> </ul>	<b>539639</b>	<b>VPPE-3-<math>\frac{1}{8}</math>-6-010</b>
Plug socket with cable <span style="float: right;">Technical data → Internet: nebu</span>			
	<ul style="list-style-type: none"> <li>• Straight socket, M12x1, 5-pin</li> <li>• Open end, 4-wire, cable length 5 m</li> </ul>	<b>164259</b>	<b>SIM-M12-4GD-5-PU</b>
	<ul style="list-style-type: none"> <li>• Angled socket, M12x1, 5-pin</li> <li>• Open end, 4-wire, cable length 5 m</li> </ul>	<b>164258</b>	<b>SIM-M12-4WD-5-PU</b>
Plug socket <span style="float: right;">Technical data → Internet: sie-gd</span>			
	Straight socket, M12x1, 4-pin	<b>18494</b>	<b>SIE-GD</b>
	Angled socket, M12x1, 4-pin	<b>12956</b>	<b>SIE-WD-TR</b>
Setpoint module <span style="float: right;">Technical data → Internet: mpz</span>			
	Setpoint module for generating 6 + 1 analogue voltage signals	<b>546224</b>	<b>MPZ-1-24DC-SGH-6-SW</b>



# Proportional pressure regulators VPPE with display



Type codes

VPPE – 3 – 1 – 1/8 – 6 – 010 – E1 T

Type	
VPPE	Proportional pressure regulator with switching valve head
Directional control function	
3	3-way pressure regulator
Valve function	
1	Normally closed
Pneumatic connection	
1/8	G1/8 female thread
Pressure regulation range	
2	0.02 ... 2 bar
6	0.06 ... 6 bar
10	0.1 ... 10 bar
Analogue setpoint input	
010	0 ... 10 V
420	4 ... 20 mA
Operator unit	
E1	Segmented LED display
Assembly	
–	In-line valve
T	Common supply manifold assembly (mounting rail)

# Proportional pressure regulators VPPE with display

Technical data

-  Flow rate  
310 ... 1,250 l/min
  -  Voltage  
21.6 ... 26.4 V DC
  -  Pressure regulation range  
0.02 ... 2 bar  
0.06 ... 6 bar  
0.1 ... 10 bar
- Variants
- Setpoint input as analogue voltage signal 0 ... 10 V
  - Setpoint input as analogue current signal 4 ... 20 mA
  - Assembly as in-line valve or on mounting rail
  - 3-digit LED display



General technical data			
Pneumatic connection 1, 2, 3		G <sup>1</sup> / <sub>8</sub>	
Design, valve function		Piloted diaphragm regulator, 3-way proportional pressure regulator	
Sealing principle		Soft	
Actuation type		Electric	
Reset method		Mechanical spring	
Type of control		Piloted via 2/2-way valves	
Type of mounting		Via through-hole	
Mounting position		Any, preferably vertical	
Nominal size	Pressurisation	[mm]	5
	Exhaust	[mm]	2.5
Standard nominal flow rate		[l/min]	→ Graphs
Product weight		[g]	390

## Flow rate qn as a function of output pressure p2

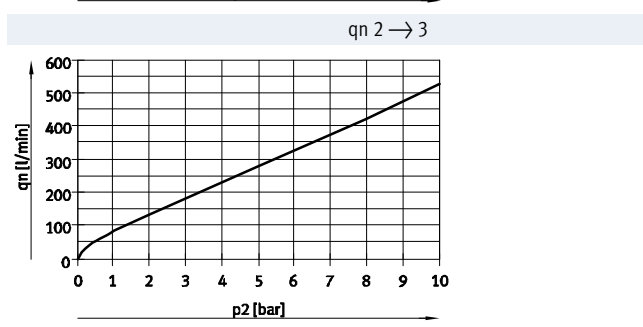
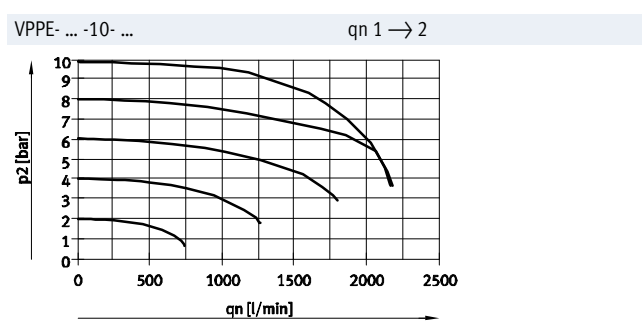
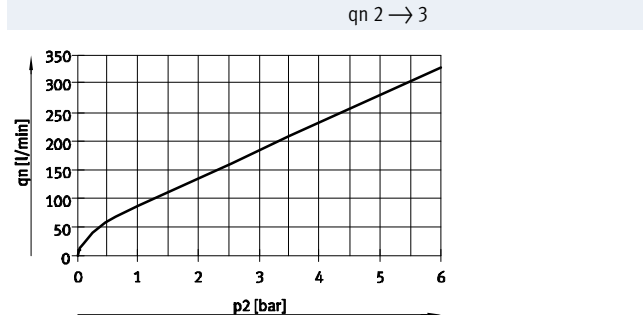
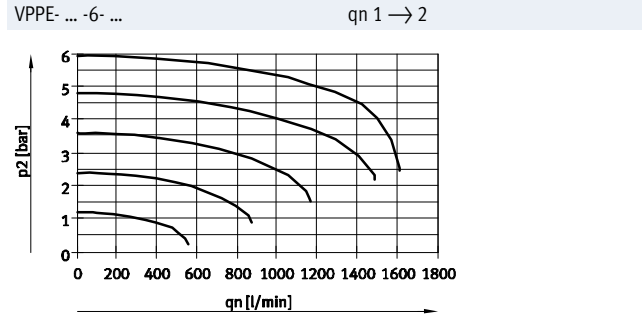
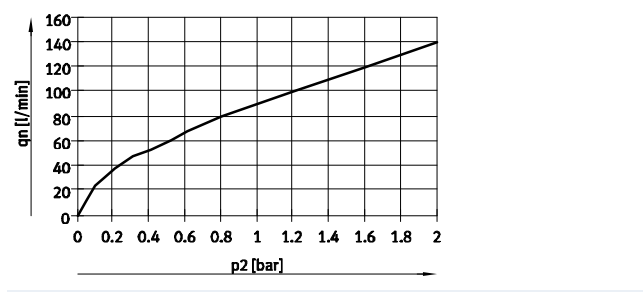
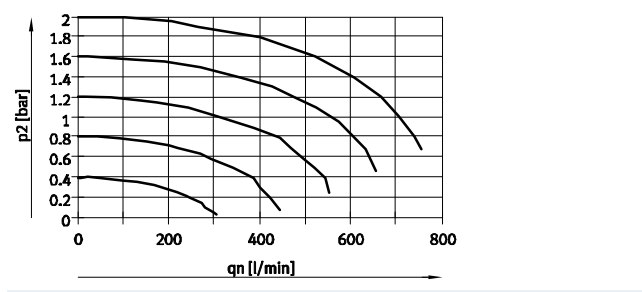

# Proportional pressure regulators VPPE with display

Technical data

Electrical data			
Electrical connection	Plug, round design, 5-pin, M12x1		
Operating voltage range	[V DC]	21.6 ... 26.4	
Power supply indicator	LED		
Residual ripple	[%]	10	
Max. electrical power consumption	[W]	4.2	
Analogue signal range	Voltage	[V DC]	0 ... 10
Output/input	Current	[mA]	4 ... 20
Protection against short circuit	For all electrical connections		
Switching output	PNP		
Protection against incorrect polarity	For all electrical connections		
Protection class	IP65		

Operating and environmental conditions				
Pressure regulation range	[bar]	0.02 ... 2	0.06 ... 6	0.1 ... 10
Operating medium	Compressed air according to ISO 8573-1:2010 [7:4:4] Inert gases			
Note on operating/pilot medium	Lubricated operation not possible			
Supply pressure 1 <sup>1)</sup>	[bar]	3 ... 4	6 ... 8	6 ... 11
Max. pressure hysteresis	[mbar]	20	30	50
FS (full scale) linearity error	[%]	± 1		
FS (full scale) repetition accuracy	[%]	0.5		
Temperature coefficient	[%/K]	0.04		
Duty cycle	[%]	100		
Ambient temperature	[°C]	0 ... 60		
Temperature of medium	[°C]	10 ... 50		
Corrosion resistance class	[CRC]	2 <sup>2)</sup>		
CE marking (see declaration of conformity)	To EU EMC Directive <sup>3)</sup>			
Certification	RCM trademark c UL us - Listed (OL)			

- 1) Supply pressure 1 should always be 1 bar greater than the maximum regulated output pressure.
- 2) Corrosion resistance class 2 according to Festo standard 940 070  
Components subject to moderate corrosion stress. Externally visible parts with primarily decorative surface requirements which are in direct contact with a normal industrial environment or media such as coolants or lubricating agents.
- 3) For information about the applicability of the component see the manufacturer's EC declaration of conformity at: [www.festo.com/sp](http://www.festo.com/sp) → User documentation.  
If the component is subject to restrictions on usage in residential, office or commercial environments or small businesses, further measures to reduce the emitted interference may be necessary.

## Pin allocation for VPPE with display, M12x1

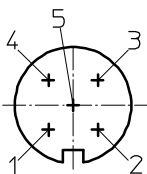

- 1 Supply  
21.6 ... 26.4 V DC
- 2 Setpoint value (-)
- 3 GND (-)
- 4 Setpoint value (+) 0 ... 10 V DC /  
4 ... 20 mA
- 5 Actual value output or switching  
output (can be chosen via the  
control panel)

## Circuit symbol

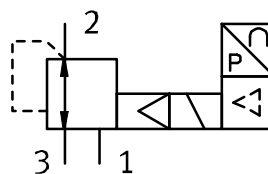

## Materials

Housing	Anodised wrought aluminium alloy
Note on materials	RoHS-compliant

-  - Note

Output pressure remains unregulated if the power supply cable is interrupted.

# Proportional pressure regulators VPPE with display

Technical data

**FESTO**

## Dimensions

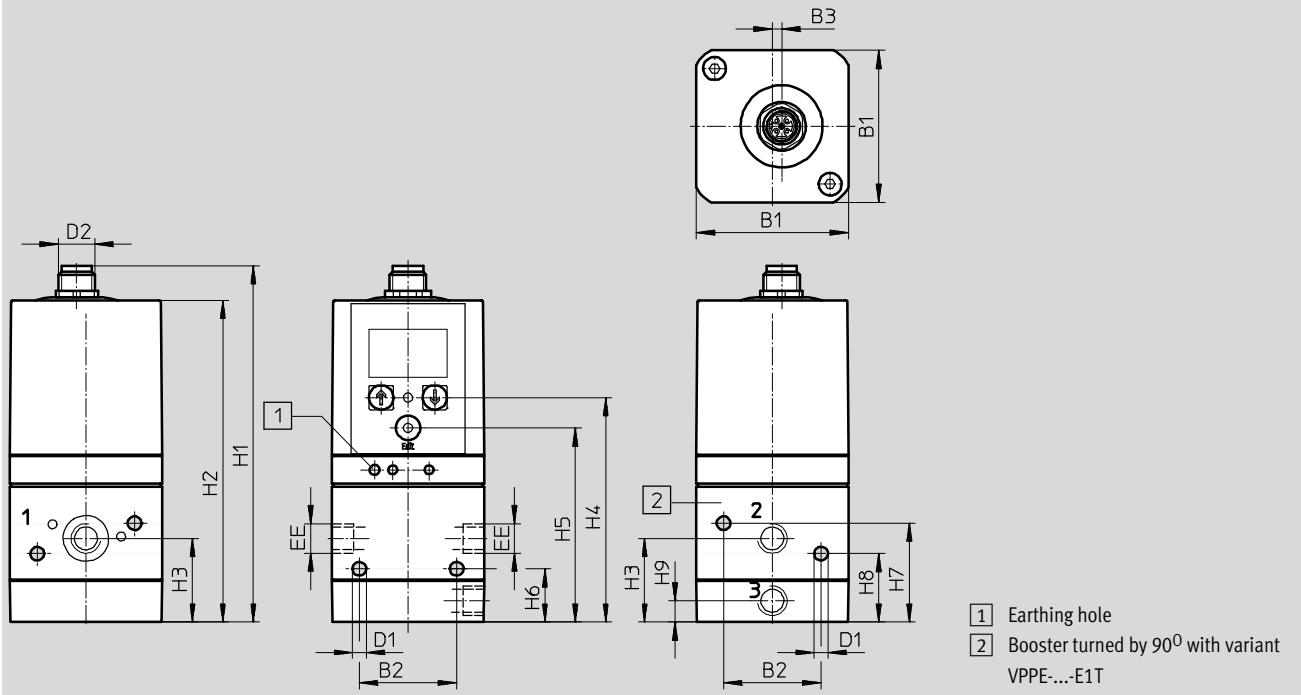

Download CAD data → [www.festo.com](http://www.festo.com)



Type	B1	B2	B3	∅ D1	D2	EE	H1	H2	H3	H4	H5	H6	H7	H8	H9
VPPE-3-1/8- ... E1 ...	50	32	3.1	4.5	M12x1	G1/8	117.2	105.8	27.5	73.8	63.8	17.5	32.5	22.5	7

# Proportional pressure regulators VPPE with display

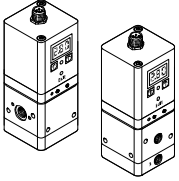
Ordering data

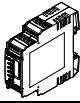
Ordering data			
	Description	Part No.	Type
<b>Proportional pressure regulator VPPE with display</b>			
	Voltage type 0 ... 10 V		
	Pressure regulation range 0.02 ... 2 bar	557771	VPPE-3-1-1/8-2-010-E1
		557777	VPPE-3-1-1/8-2-010-E1T
	Pressure regulation range 0.06 ... 6 bar	557772	VPPE-3-1-1/8-6-010-E1
		567539	VPPE-3-1-1/8-6-010-E1T
	Pressure regulation range 0.1 ... 10 bar	557773	VPPE-3-1-1/8-10-010-E1
		557778	VPPE-3-1-1/8-10-010-E1T
	Current type 4 ... 20 mA		
	Pressure regulation range 0.02 ... 2 bar	557774	VPPE-3-1-1/8-2-420-E1
		557779	VPPE-3-1-1/8-2-420-E1T
	Pressure regulation range 0.06 ... 6 bar	557775	VPPE-3-1-1/8-6-420-E1
		567540	VPPE-3-1-1/8-6-420-E1T
	Pressure regulation range 0.1 ... 10 bar	557776	VPPE-3-1-1/8-10-420-E1
		557780	VPPE-3-1-1/8-10-420-E1T
<b>Connecting cable</b> <span style="float: right;">Technical data → Internet: nebu</span>			
	<ul style="list-style-type: none"> <li>• Straight socket, M12x1, 5-pin</li> <li>• Open end, 5-wire</li> </ul>	2.5 m	175715 SIM-M12-5GD-2,5-PU
		5 m	175716 SIM-M12-5GD-5-PU
<b>Setpoint module</b> <span style="float: right;">Technical data → Internet: mpz</span>			
	Setpoint module for generating 6 + 1 analogue voltage signals	546224	MPZ-1-24DC-SGH-6-SW

# Mounting rail for proportional pressure regulators VPPE

Technical data



## General Design

Some selected types of the pressure regulator VPPE can be screwed to a mounting rail. This has the advantage that the mounting rail can be used to create a central compressed air supply.  
The air can be fed into the mounting rail:

- at one end or
- at both ends through end plates,
- using an intermediate air supply module (in applications where an increased air rate is required).

The holes for the mounting rail must be drilled according to the assembly instructions. The pressure regulators VPPE are screwed to the mounting rail using the mounting plate. The end

plates are screwed to the left and right end faces of the mounting rail. See the assembly instructions for further information:  
➔ Internet: vppe

## Compressed air supply on the mounting rail Recommendation for compressed air supply

When using the mounting rail as a central compressed air supply, make sure that the required compressed air supply is guaranteed. Bear in mind

that an intermediate air supply module needs a valve position. The intermediate air supply module takes up one VPPE valve position.

E.g. with tubing Ø 16 mm with simultaneous max. flow rate for all valves, the following applies:  
Compressed air supply – number of valves:

- At one end – max. 5 valves
- At both ends – max. 10 valves
- With intermediate air supply module – max. 5 valves per module

Note

- Intermediate air supply modules must always be centred on the mounting rail.
- Multiple intermediate air supply modules must be evenly distributed.

Note

Only the following types of proportional pressure regulators VPPE can be mounted on mounting rails using a mounting plate:

- Valve VPPE with LED display, VPPE-3-1/8-6-010
- Valve VPPE with display and top part rotated by 90° VPPE- ... -E1T

Further information on mounting proportional pressure regulators VPPE as well as intermediate air supply modules on mounting rails can be found in the assembly instructions:  
➔ Internet: vppe

## Mounting plate (set) materials

Plate	Wrought aluminium alloy
Seals	Nitrile rubber
Screws	Steel
Note on materials	RoHS-compliant
Corrosion resistance class	[CRC] 2 <sup>1)</sup>

1) Corrosion resistance class 2 according to Festo standard 940 070  
Components subject to moderate corrosion stress. Externally visible parts with primarily decorative surface requirements which are in direct contact with a normal industrial environment or media such as coolants or lubricating agents.

## Dimensions – Mounting plate Download CAD data ➔ [www.festo.com](http://www.festo.com)

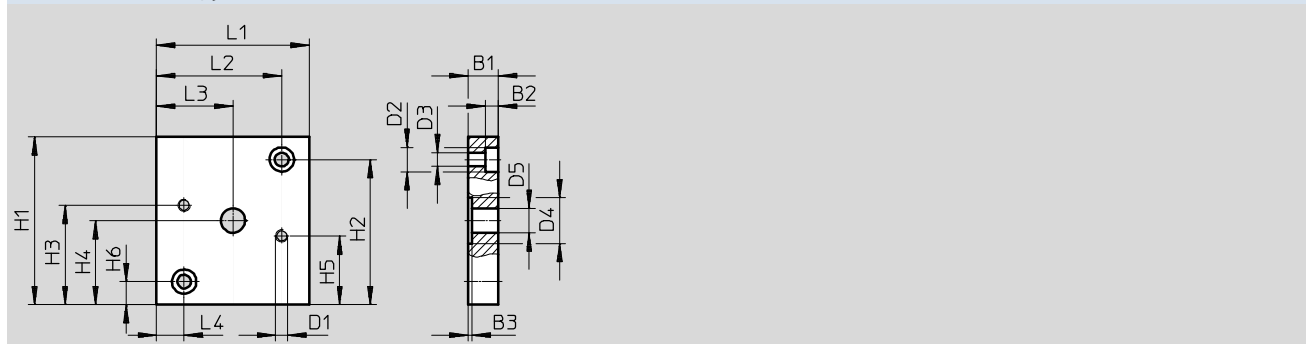

Type	B1	B2	B3	D1	∅D2	∅D3	∅D4	∅D5	H1	H2	H3	H4	H5	H6	L1	L2	L3	L4
VAME-P5-MK	10	4.6	1.3	M4	8	4.5	15	8	55	47.5	32.5	27.5	22.5	7.5	50	41	25	9

# Mounting rail for proportional pressure regulators VPPE

Ordering data

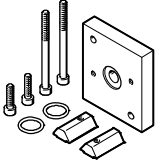
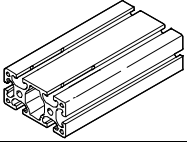
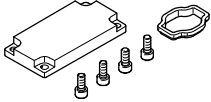
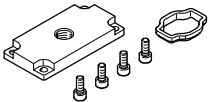
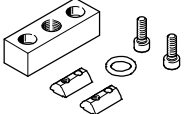
Ordering data		Part No.	Type
<b>Mounting plate set</b>			
	Set, consisting of: <ul style="list-style-type: none"> <li>• 1x mounting plate, weight: 110 g</li> <li>• 2x socket head screws M4X55</li> <li>• 2x socket head screws M4X16</li> <li>• 2x slot nuts</li> <li>• 2x O-rings</li> </ul>	<b>570966</b>	<b>VAME-P5-MK</b>
<b>Profile column (mounting rail)</b>			
	Made from aluminium, as central air supply, length: individually adaptable	<b>175964</b>	<b>HMBS-80/40- -</b>
<b>End plate set (closed)</b>			
	For sealing the mounting rail, consisting of: <ul style="list-style-type: none"> <li>• 1x plate</li> <li>• 1x seal</li> <li>• 4x socket head screws M5x12</li> </ul>	<b>8021858</b>	<b>VABE-P5-C</b>
<b>Compressed air supply plate set</b>			
	With connecting thread G $\frac{1}{4}$ , consisting of: <ul style="list-style-type: none"> <li>• 1x plate with connecting thread G<math>\frac{1}{4}</math></li> <li>• 1x seal</li> <li>• 4x socket head screws M5x12</li> </ul>	<b>8021859</b>	<b>VABF-P5-P3A3-G14</b>
	With connecting thread G $\frac{3}{8}$ , consisting of: <ul style="list-style-type: none"> <li>• 1x plate with connecting thread G<math>\frac{3}{8}</math></li> <li>• 1x seal</li> <li>• 4x socket head screws M5x12</li> </ul>	<b>8021860</b>	<b>VABF-P5-P3A3-G38</b>
	With connecting thread G $\frac{1}{2}$ , consisting of: <ul style="list-style-type: none"> <li>• 1x plate with connecting thread G<math>\frac{1}{2}</math></li> <li>• 1x seal</li> <li>• 4x socket head screws M5x12</li> </ul>	<b>8021861</b>	<b>VABF-P5-P3A3-G12</b>
<b>Additional power supply module set</b>			
	Connection G $\frac{1}{4}$ , consisting of: <ul style="list-style-type: none"> <li>• 1x plate with connecting thread G<math>\frac{1}{4}</math></li> <li>• 1x O-ring</li> <li>• 2x slot nuts</li> <li>• 2x socket head screws M6x20</li> </ul>	<b>8021862</b>	<b>VABF-P5-P1A3-G14</b>
	Connection G $\frac{3}{8}$ , consisting of: <ul style="list-style-type: none"> <li>• 1x plate with connecting thread G<math>\frac{3}{8}</math></li> <li>• 1x O-ring</li> <li>• 2x slot nuts</li> <li>• 2x socket head screws M6x20</li> </ul>	<b>8021863</b>	<b>VABF-P5-P1A3-G38</b>

## Product Range and Company Overview

### A Complete Suite and Company Overview

Our experienced engineers provide complete support at every stage of your development process, including: conceptualization, analysis, engineering, design, assembly, documentation, validation, and production.



**Custom Automation Components**  
Complete custom engineered solutions



**Custom Control Cabinets**  
Comprehensive engineering support and on-site services



**Complete Systems**  
Shipment, stocking and storage services

### The Broadest Range of Automation Components

With a comprehensive line of more than 30,000 automation components, Festo is capable of solving the most complex automation requirements.



**Electromechanical**  
Electromechanical actuators, motors, controllers & drivers



**Pneumatics**  
Pneumatic linear and rotary actuators, valves, and air supply



**PLCs and I/O Devices**  
PLC's, operator interfaces, sensors and I/O devices

### Supporting Advanced Automation... As No One Else Can!

Festo is a leading global manufacturer of pneumatic and electromechanical systems, components and controls for industrial automation, with more than 16,000 employees in 60 national headquarters serving more than 180 countries. For more than 80 years, Festo has continuously elevated the state of manufacturing with innovations and optimized motion control solutions that deliver higher performing, more profitable automated manufacturing and processing equipment. Our dedication to the advancement of automation extends beyond technology to the education and development of current and future automation and robotics designers with simulation tools, teaching programs, and on-site services.

### Quality Assurance, ISO 9001 and ISO 14001 Certifications

Festo Corporation is committed to supply all Festo products and services that will meet or exceed our customers' requirements in product quality, delivery, customer service and satisfaction.

To meet this commitment, we strive to ensure a consistent, integrated, and systematic approach to management that will meet or exceed the requirements of the ISO 9001 standard for Quality Management and the ISO 14001 standard for Environmental Management.



© Copyright 2013, Festo Corporation. While every effort is made to ensure that all dimensions and specifications are correct, Festo cannot guarantee that publications are completely free of any error, in particular typing or printing errors. Accordingly, Festo cannot be held responsible for the same. For Liability and Warranty conditions, refer to our "Terms and Conditions of Sale", available from your local Festo office. All rights reserved. No part of this publication may be reproduced, distributed, or transmitted in any form or by any means, electronic, mechanical, photocopying or otherwise, without the prior written permission of Festo. All technical data subject to change according to technical update.



Printed on recycled paper at New Horizon Graphic, Inc., FSC certified as an environmental friendly printing plant.



# Festo North America



**1 Festo Canada  
Headquarters  
Festo Inc.**  
5300 Explorer Drive  
Mississauga, ON  
L4W 5G4

**2 Montréal**  
5600, Trans-Canada  
Pointe-Claire, QC  
H9R 1B6

**3 Québec City**  
2930, rue Watt#117  
Québec, QC  
G1X 4G3



**4 Festo United States  
Headquarters  
Festo Corporation**  
395 Moreland Road  
Hauppauge, NY  
11788

**5 Appleton**  
North 922 Tower View Drive, Suite N  
Greenville, WI  
54942

**7 Detroit**  
1441 West Long Lake Road  
Troy, MI  
48098

**6 Chicago**  
85 W Algonquin - Suite 340  
Arlington Heights, IL  
60005

**8 Silicon Valley**  
4935 Southfront Road, Suite F  
Livermore, CA  
94550

## Festo Regional Contact Center

### Canadian Customers

Commercial Support:  
Tel: 1 877 GO FESTO (1 877 463 3786)  
Fax: 1 877 FX FESTO (1 877 393 3786)  
Email: festo.canada@ca.festo.com

### Technical Support:

Tel: 1 866 GO FESTO (1 866 463 3786)  
Fax: 1 877 FX FESTO (1 877 393 3786)  
Email: technical.support@ca.festo.com

### USA Customers

Commercial Support:  
Tel: 1 800 99 FESTO (1 800 993 3786)  
Fax: 1 800 96 FESTO (1 800 963 3786)  
Email: customer.service@us.festo.com

### Technical Support:

Tel: 1 866 GO FESTO (1 866 463 3786)  
Fax: 1 800 96 FESTO (1 800 963 3786)  
Email: product.support@us.festo.com