

Valve terminals VTSA/VTSA-F, NPT

FESTO

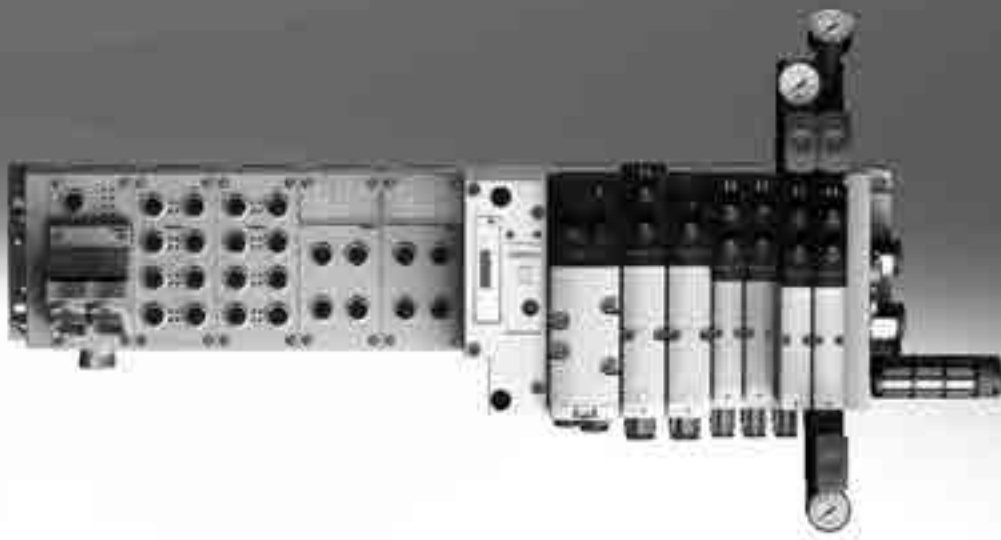

Valve terminals VTSA/VTSA-F, NPT

Key features

FESTO

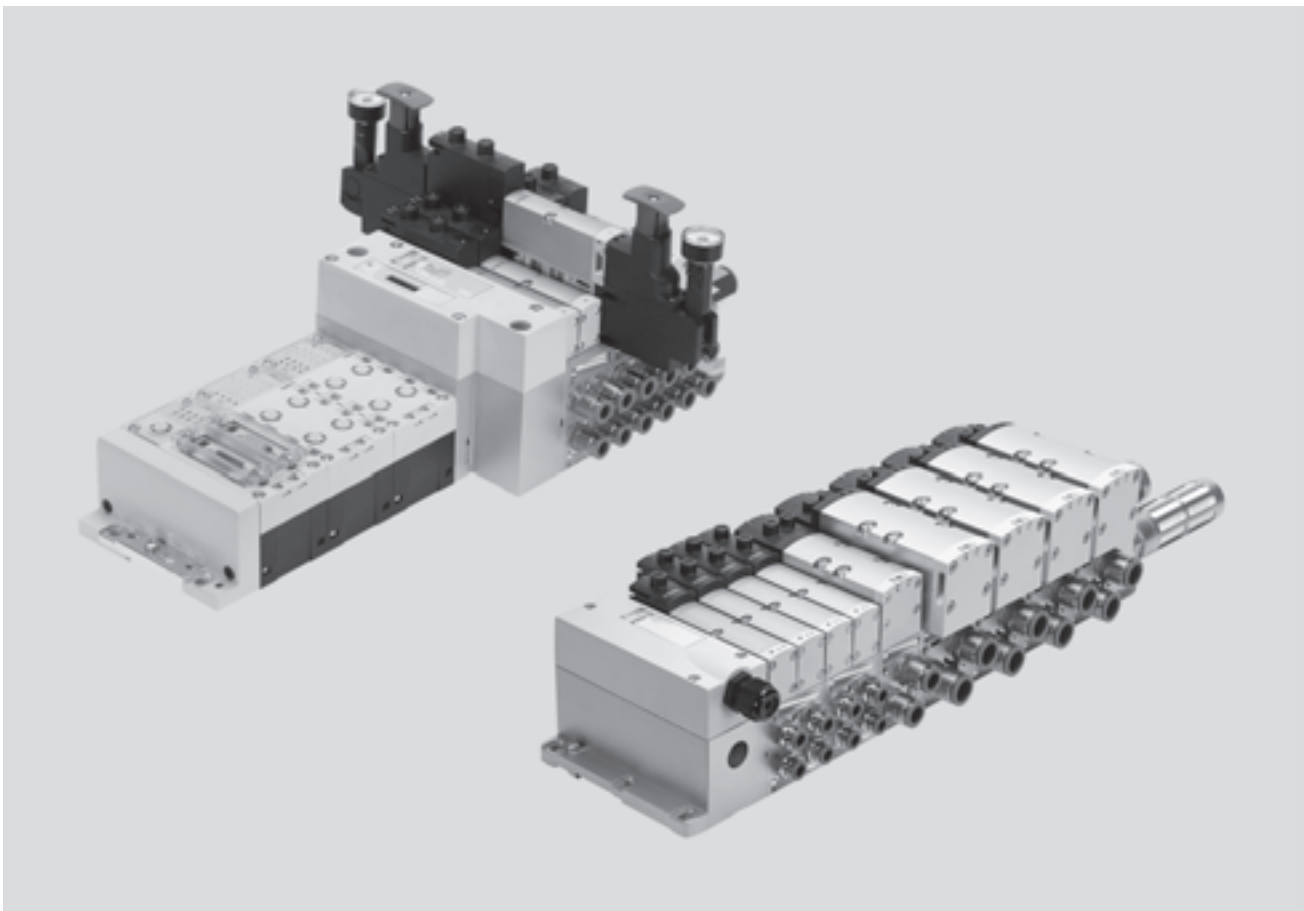

Innovative

- High-performance valves in sturdy metal housing
- Four valve sizes on one valve terminal
- Standardised from the multi-pin plug to the fieldbus connection and control block
- Dream team: fieldbus valve terminal suitable for electrical peripherals CPX. This means:
 - Forward-looking internal communication system for controlling the valves and CPX modules
 - Four valve sizes on one valve terminal without adapters
- Valve functions for integration in control architectures of higher categories to EN ISO 13849-1

Versatile

- Modular system offering a range of configuration options
- Expandable with up to 32 solenoid coils
- Conversions and extensions are possible at any time
- Manifold sub-bases can be extended using four screws, sturdy duct separation on metal support
- Integration of innovative function modules possible
- Supply plates enable a flexible air supply and variable pressure zones
- Reverse operation
- High pressure range
–0.9 ... 10 bar,
flow range 550 ... 4000 l/min
- Wide range of valve functions
- Valve supply: 24 V DC or 110 V AC

Reliable

- Sturdy and durable metal components
 - Valves
 - Manifold sub-bases
 - Seals
- Fast troubleshooting thanks to LEDs on the valves and diagnostics via fieldbus
- Reliable servicing thanks to valves that can be replaced quickly and easily
- Manual override either non-detenting, non-detenting/detenting or covered
- Durable thanks to tried-and-tested piston spool valves
- Large and durable labelling system
- 100% duty cycle

Easy to install

- Assembled and inspected unit, ready for installation
- Reduced outlay on selection, ordering, installation and commissioning
- Secure mounting on wall or H-rail

Note

The key features, valves and functions of width 65 mm are described separately in the chapter

"Adaptation to width 65 mm, ISO size 3 (technology type 04)"
→ Page 165.

Valve terminals VTSA/VTSA-F, NPT

Key features

Reduced downtimes:
 On-the-spot diagnostics via LEDs

Width 18 mm, 26 mm,
 42 mm and 52 mm can be com-
 bined on a single valve terminal
 without adapter

Pneumatic interface to CPX

Simple electrical connections
 – Fieldbus connection via CPX
 – Multi-pin plug connection with
 pre-assembled cable or terminal
 strip (Cage Clamp®)
 – Control block via CPX
 – AS-Interface
 – Individual connection

CPX diagnostic interface for hand-
 held devices (channel-oriented
 diagnostics down to the individual
 valve)

Quick mounting:
 Direct mounting using screws or
 H-rail

Safe:
 Valves, outputs and logic
 voltage can be switched off
 separately

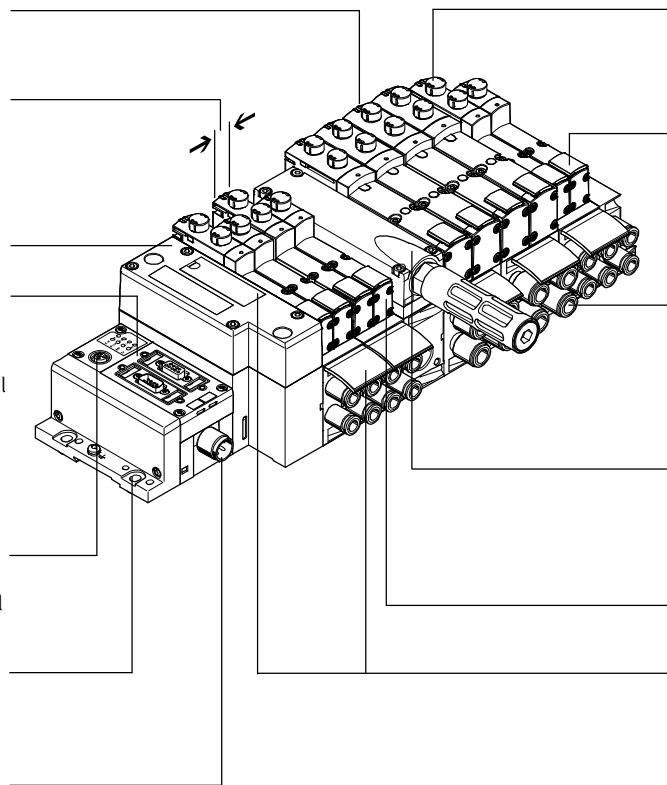

Reliable operation:
 Manual override, detenting,
 non-detenting/detenting or covered

Flexible:
 – 32 valve positions/32 solenoid coils
 – One valve series for a wide range of
 flow rates

Functional:
 Large ports, flow-optimised ducts,
 sturdy metal thread or pre-assembled
 QS connections

Modular:
 Air supply plates facilitate the creation of
 multiple pressure zones as well as
 numerous additional exhaust and supply
 ports
 Comprehensive range of valve functions

Practical:
 Large inscription labels

Equipment options

Valve functions

- 2x 2/2-way valve, single solenoid, pneumatic spring, normally closed
- 2x 3/2-way valve, single solenoid
 - Normally open
 - Normally open, reversible
 - Normally closed
 - Normally closed, reversible
- 2x 3/2-way valve, single solenoid
 - 1x normally open, 1x normally closed
 - 1x normally open, 1x normally closed, reversible
- 5/2-way solenoid valve
 - Single solenoid, pneumatic spring/mechanical spring
 - Double solenoid
 - Double solenoid with dominant signal
- 5/2-way solenoid valves for special functions, single solenoid
 - Mechanical spring
 - Switching position sensing via inductive sensors with PNP or NPN output
 - Protection against unexpected start-up to EN 1037
 - Reversing
- 5/3-way solenoid valve
 - Mid-position pressurised
 - Mid-position closed
 - Mid-position exhausted
- 5/3-way solenoid valve for special functions
 - Switching position 14 is retained (switching position 14 is retained in the event of an emergency-off application/power failure), there is no spring return on switching position 12
 - Only for valve terminal (plug-in)
 - Mid-position exhausted or mid-position 1→2, 4→5
 - Switching position 14 is retained
 - Pneumatic spring return
- 5/3-way solenoid valve for special functions
 - Switching position 12 is retained (switching position 12 is retained in the event of an emergency-off application/power failure), there is no spring return on switching position 14.
 - Only for valve terminal (plug-in)
 - Mid-position exhausted or mid-position 1→4, 2→3
 - Switching position 12 is retained
 - Pneumatic spring return
- Soft-start valve for slow and safe pressure build-up
 - High degree of safety
 - Sensor function provides feedback on switching operation

Note

The key features, valves and functions of width 65 mm are described separately in the chapter

“Adaptation to width 65 mm”, ISO size 3 (technology type 04)
 → Page 165.

Valve terminals VTSA/VTSA-F, NPT

Key features

FESTO

Special features			
Individual valve on individual sub-base up to width 52 mm		Valve terminal with fieldbus connection and electrical peripherals	
Plug-in <ul style="list-style-type: none"> Electrical connection via standardised 4-pin M12 plug or via 4-pin spring-loaded terminal for configuration by the user Available with internal/external pilot air supply 	Square plug or plug-in, with integrated piston position sensing <ul style="list-style-type: none"> Electrical connection to DIN EN 175301-803 type C (square plug) or For configuration by the user via 4-pin spring-loaded terminal or Cable with open end 	CPX terminal <ul style="list-style-type: none"> Max. 32 valve positions/ max. 32 solenoid coils Any compressed air supply Any number of pressure zones 	
Valve terminal with individual connection <ul style="list-style-type: none"> Max. 20 valve positions/ max. 20 solenoid coils Any compressed air supply Any number of pressure zones 	Valve terminal with multi-pin plug connection <ul style="list-style-type: none"> Max. 32 valve positions/ max. 32 solenoid coils Parallel modular valve linking Any compressed air supply Any number of pressure zones 	AS-Interface <ul style="list-style-type: none"> 1 to 8 valve positions/ max. 8 solenoid coils Soft-start valve for slow and safe pressure build-up 	Combinable <ul style="list-style-type: none"> Valve width 18 mm: flow rate of VTSA up to 550 l/min, VTSA-F up to 700 l/min Valve width 26 mm: flow rate of VTSA up to 1100 l/min, VTSA-F up to 1350 l/min Valve width 42 mm: flow rate of VTSA up to 1300 l/min, VTSA-F up to 1860 l/min Valve width 52 mm: flow rate up to 2900 l/min Widths 18 mm, 26 mm, 42 mm, 52 mm and 65 mm can be combined on a single valve terminal (using an adapter)
 Note <ul style="list-style-type: none"> Valve terminal VTSA complies with ISO 15407-2 in width 18 and 26 mm and With ISO 5599-2 in size 42 and 52 mm 			

Valve terminal configurator			→ Internet: www.festo.com
A valve terminal configurator is available to help you select a suitable VTSA/VTSA-F valve terminal. This makes it much easier to order the right product.	The valve terminals are fully assembled according to your order specification and are individually checked. This reduces assembly and installation time to a minimum.	Order a valve terminal VTSA using the order code: Ordering system for VTSA → Internet: vtsa Ordering system for CPX → Internet: cpx	Order a valve terminal VTSA-F using the order code: Ordering system for VTSA-F → Internet: vtsa-f Ordering system for CPX → Internet: cpx

Valve terminals VTSA/VTSA-F, NPT

Key features

FESTO

Individual pneumatic connection

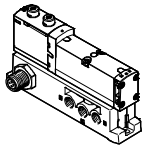

Valves on individual sub-bases up to width 52 mm can be used for actuators further away from the valve terminal.

The electrical connection is established either via a standardised 4-pin M12 plug, 24 V DC (EN 61076-2-101), 4-pin spring-loaded terminal or a

cable with open end, 24 V DC or 110 V AC, which are configured by the user.

Valve terminal with individual electrical connection

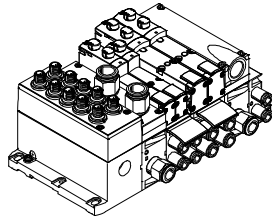

Control signals from the controller to the valve terminal are transmitted via an individual connecting cable.

The valve terminal can be equipped with max. 20 valves and max. 20 solenoid coils.

The electrical connection is established via a 5-pin M12 plug, 24 V DC.

Valve terminal with multi-pin plug connection

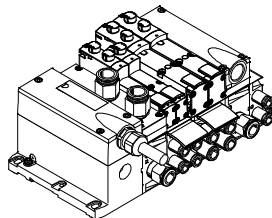

Control signals from the controller to the valve terminal are transmitted via a pre-assembled multi-wire cable or a multi-pin plug connection assembled by the user (spring-loaded terminal), which substantially reduces installation time.

The valve terminal can be equipped with max. 32 valves and max. 32 solenoid coils.

Versions

- Multi-pin plug connection with terminal strip (spring-loaded terminal), 24 V DC or 110 V AC
- Pre-assembled connecting cable, 24 V DC
- Sub-D plug connector for assembly by the user, 37-pin
- Round plug connector M23, 19-pin, 24 V DC

AS-Interface connection

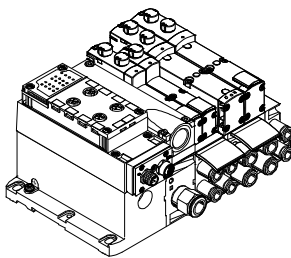

A special feature of the AS-Interface is the simultaneous transmission of data and supply power via a two-wire cable. The encoded cable profile prevents connection with incorrect polarity. The valve terminal with AS-Interface is available in the following versions:

- With one to eight modular valve positions (max. 8 solenoid coils). This corresponds to 1 to 8 VSVA valves.
- With all available valve functions. The connection technology used for the inputs can be selected as with

CPX: M8, M12, quick connection, Sub-D, spring-loaded terminal (terminals to IP20).

Additional information

➔ Internet: as-interface



The valve terminal VTSA/VTSA-F with AS-Interface connection is based on the same electrical interlinking module as the valve terminal with multi-pin plug connection. This means it is possible to convert a valve terminal with multi-pin plug connection using

an AS-Interface module (➔ 125). The technical specifications of the AS-Interface system must be observed in this case.

➔ Page 58

➔ Internet: as-interface

Valve terminals VTSA/VTSA-F, NPT

Key features

Valve terminal with fieldbus connection from the CPX system

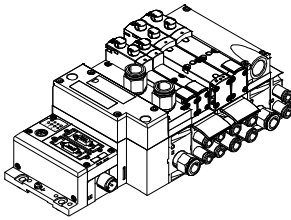

An integrated fieldbus node manages the communication connection with a higher-order PLC. This enables a space-saving pneumatic and electronic solution.

Valve terminals with fieldbus interfaces from the CPX system can be configured with up to 16 manifold sub-bases. With 2 solenoid coils per connection, up to 32 solenoid coils can thus be actuated.

Versions

- PROFIBUS
- INTERBUS
- DeviceNet
- CANopen
- CC-Link
- EtherNet/IP
- EtherCAT
- Modbus TCP
- PROFINET
- POWERLINK
- Sercos III

➔ Internet: cpx

Valve terminal with control block connection from the CPX system

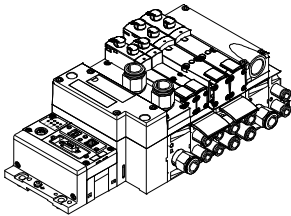

A controller integrated in the Festo valve terminal enables the construction of stand-alone control units with protection to IP65 without a control cabinet thanks to two different operating modes.

In the slave operating mode, these valve terminals can be used for intelligent preprocessing and are therefore ideal modules for designs using decentralised intelligence.

In the master operating mode, terminal groups can be designed with many options and functions that can autonomously control a medium-sized machine/system.

➔ Internet: cpx

CP string extension from the CPX system

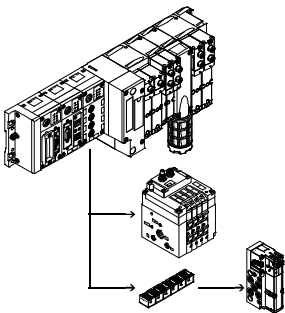

The optional CP string extension enables additional valve terminals and I/O modules to be connected to the fieldbus node of the CPX terminal on up to 4 CP strings. Different input and output modules as well as CPV-SC, CPV and CPA valve terminals can be connected.

The maximum length of the CP string extension is 10 metres, which means that the extension modules can be mounted directly on-site. All the required electrical signals are transmitted via the CP cable, which in turn means that no further installation is needed on the extension module.

One CP string offers:

- 32 input signals
- 32 output signals for output modules 24 V DC or solenoid coils
- Logic and sensor supply for the input modules
- Load voltage supply for the valve terminals
- Logic supply for the output module

➔ Internet: ctec

Valve terminals VTSA/VTSA-F, NPT

Key features – Valves

FESTO

Solenoid valve with switching position sensing, width 18 mm, 26 mm

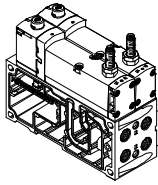

The 5/2-way single solenoid valve with spring return in width 26 mm features switching position sensing. The normal position of the piston spool valve is monitored.

Designed as a plug-in or individual connection valve with pilot valves to ISO 15218 and square plug type C. This valve is not a safety device in accordance with the Machinery Directive 2006/42/EC.

It is suitable for use in safety-related parts of control systems to EN ISO 13849-1.

→ Page 128

Control block with safety function, width 26 mm

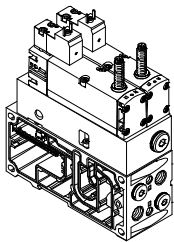

5/2-way solenoid valve
These valves are used for special applications, for example for:

- Protecting against unexpected start-up
- Safe reversing
- Drives in manually loaded devices

This control block is suitable for use as a press safety valve to EN 962.

This valve is a safety device in accordance with the Machinery Directive 2006/42/EC.

→ Page 138

Pilot air switching valve, width 18 mm, 26 mm

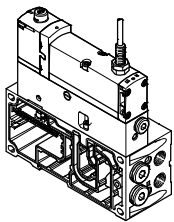

The pilot air switching valve is a combination of a 5/2-way solenoid valve with switching position sensing and the intermediate plate VABF-S4-...-S. It enables the pilot air supply to be verifiably switched on and off (sensor function) from duct 1 to 14 for the

entire pressure zone or valve terminal. The piston position sensing feature is realised by means of an inductive PNP proximity sensor with cable and push-in connector in the size M12x1 to EN 61076-2-104.

This valve is not a safety device in

accordance with the Machinery Directive 2006/42/EC. It is suitable for use in safety-related parts of control systems to EN ISO 13849-1.

→ Page 144



Note

The pilot air switching valve can only be operated on the valve terminal VTSA/VTSA-F in combination with a right-hand end plate for external

pilot air type VABE-S6-1RZ- Port 14 on the right-hand end plate must be sealed for this.

Soft-start valve, module width 43 mm

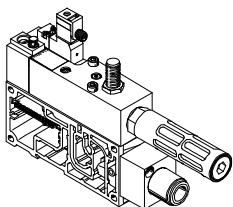

The soft-start valve is separately electrically actuated, independently of the multi-pin plug, AS-Interface or field-bus connection, via a 4-pin plug to ISO 15407-1 or optionally via an M12 adapter.

The valve can optionally be ordered with a sensor that monitors switching

of the soft-start valve. The soft-start valve can supply the valve terminal or one or more pressure zones with supply air.

The pressure build-up for each pressure zone is optimised for the application directly at the valve terminal by

setting the switch-over pressure and the filling time.

A maximum of 5 soft-start valves can be integrated on one valve terminal in this way.

→ Page 152

Valve terminals VTSA/VTSA-F, NPT

Key features – Valves

Vacuum block, module width 53 mm

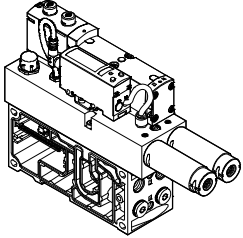

5/3-way solenoid valve, with switching position 12 retained. The vacuum block is screwed to a manifold sub-base for 2 valve positions, width 26 mm, and integrated into the valve terminal VTSA/VTSA-F. The vacuum block is supplied with

electricity and the vacuum is sensed via a standardised 4-pin M12 plug. The vacuum block is used in conjunction with a suction gripper to receive, hold and place components. Placing is realised by means of an adjustable ejector pulse. The vacuum block is

equipped with an air-saving function. In the absence of electric or pneumatic supply, the valve reverts to switching position 12 "create vacuum".

→ Page 159

5/3-way solenoid valve for special functions

For holding, blocking a movement (mechanically)

5/3-way solenoid valve for special functions; port 2 is pressurised, port 4 vented. Switching position 14 is retained (code SA).

5/3-way solenoid valve for special functions; port 2 is pressurised, port 4 vented. Switching position 12 is retained (code SE).

Possible applications:

- Using lifting cylinders
- Using rotary cylinders

Possible applications:

- Using lifting cylinders
- Using rotary cylinders

For pressureless switching, self-latching loop, pneumatic operation

5/3-way solenoid valve for special functions (3 phases). Mid-position is exhausted. Switching position 14 is retained.

5/3-way solenoid valve for special functions (3 phases). Mid-position is exhausted. Switching position 12 is retained.

Possible applications:

- Pneumatic manual clamps for devices (inserting stations)

Possible applications:

- Pneumatic manual clamps for devices (inserting stations)

Valve terminals VTSA/VTSA-F, NPT

Peripherals

FESTO

Modular pneumatic peripherals

The modular design of the valve terminal VTSA/VTSA-F enables maximum flexibility right from the planning stage and offers maximum ease of service in operation.

The system consists of manifold sub-bases and valves. The manifold sub-bases are screwed together and thus form the support system for the valves.

Inside the manifold sub-bases are the ducts for supplying compressed air to and exhausting from the valve terminal as well as the working ports for the pneumatic cylinders for each valve.

Each manifold sub-base is connected to the next using four screws. Individual valve terminal sections can be isolated and further blocks easily inserted by loosening these screws. This ensures that the valve terminal can be rapidly and reliably extended.

Basic system modularity

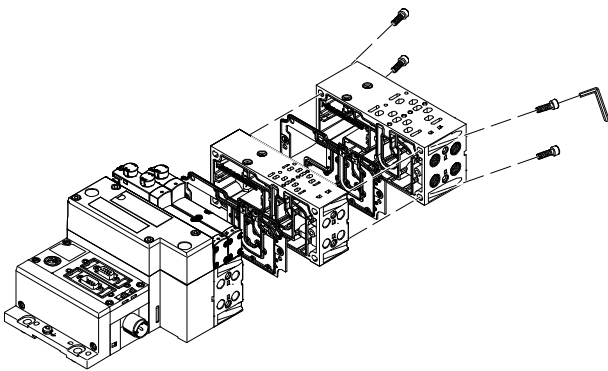

Valve modularity

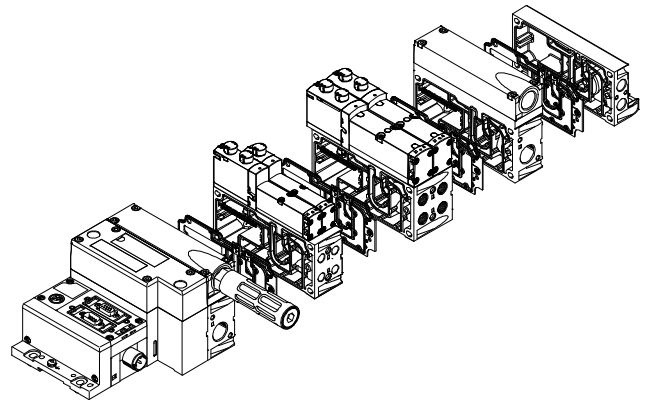

Vertical stacking modularity

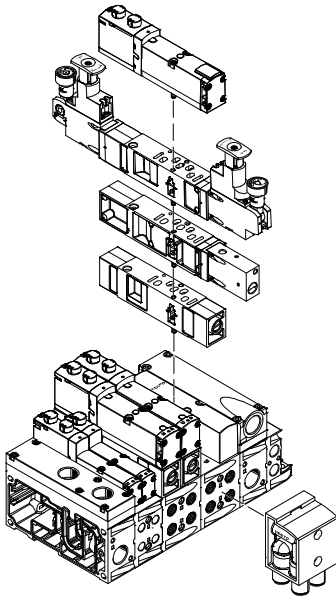

Note

See also "Adaptation to width 65 mm, ISO size 3

(technology type 04)"
→ page 165

Valve terminals VTSA/VTSA-F, NPT

Peripherals

Modular electrical peripherals

The manner in which the valves are actuated differs according to whether you are using a multi-pin terminal or fieldbus terminal.

The VTSA/VTSA-F with CPX interface is based on the internal bus system of the CPX and uses this communication system for all solenoid coils and a range of electrical input and output functions.

Parallel linking enables the following:

- Transmission of switching information
- Compact design
- Position-based diagnostics
- Separate voltage supply for valves
- Flexible conversion without address shifting
- Option of CP interface
- CPX-FEC as stand-alone controller with access via Ethernet and web server
- Transmission of status, parameter and diagnostic data

→ Internet: cpx

VTSA/VTSA-F with electrical peripherals CPX

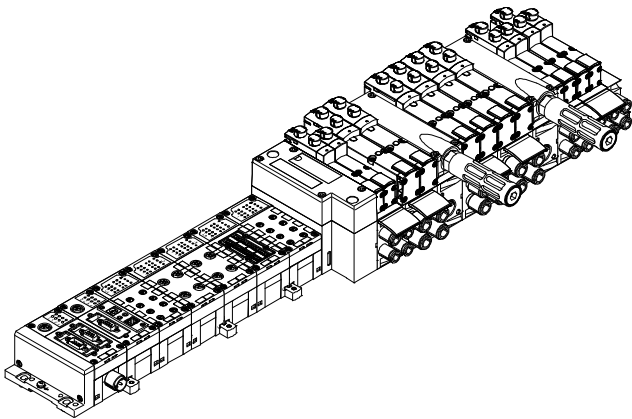

Modularity with electrical peripherals CPX

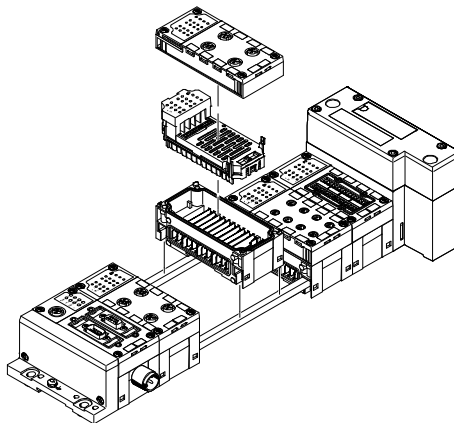

CPX terminal in metal design

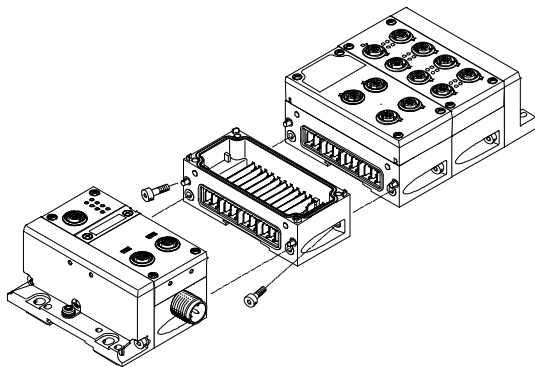

The CPX modules in metal design are mechanically connected to one another using an angled fitting. The CPX terminal can thus be expanded at any time.

- - Note

The CPX connection blocks are also available in a metal design. This means a complete solution in a sturdy metal design can be selected for applications of the valve terminal VTSA/VTSA-F in welding environments.

Valve terminals VTSA/VTSA-F, NPT

Peripherals – Pneumatic components

Individual sub-base, width 18 mm, ISO 15407-2

Order code: Individual sub-bases can be equipped with any valve.

- Using individual part numbers

Width 18 mm with spring-loaded terminal or cable (open end)

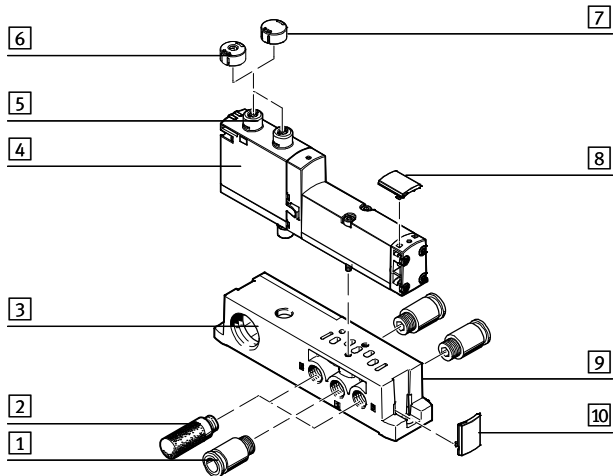

	Brief description	→ Page/Internet	
1	Fitting	1/8 NPT for air/exhaust ports (1, 3, 5) and working ports (2, 4)	194
2	Silencer	U-1/8-B-NPT for exhaust ports (3, 5)	194
3	Electrical connection	Spring-loaded terminal, cable (open end)	-
4	Valve VSVA	Width 18 mm	90
5	Manual override	Non-detenting/detenting, per solenoid coil	-
6	Cover cap, coded	For non-detenting manual override (limited function)	124
7	Cover cap, covered	MO covered by cover cap – operation of MO prevented	124
8	Inscription label holder	For valves	127
9	Individual sub-base	For valve VSVA	193
10	Inscription label holder	For manifold block	127

Valve terminals VTSA/VTSA-F, NPT

Peripherals – Pneumatic components

Individual sub-base, width 26 mm, ISO 15407-2

With spring-loaded terminal or cable (open end)

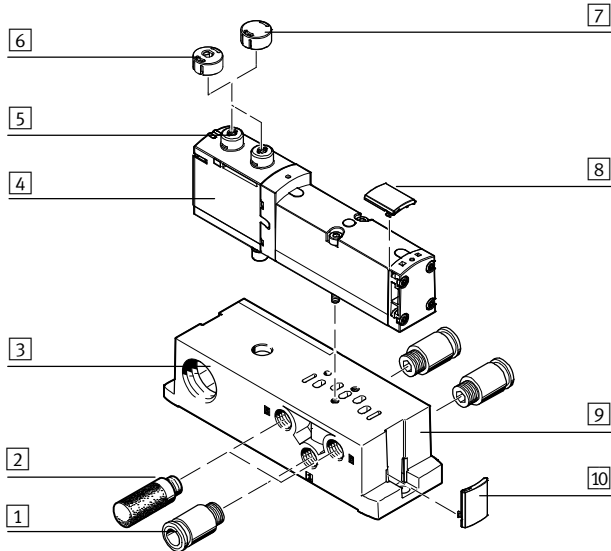

	Brief description	→ Page/Internet
1	Fitting	¼" NPT for air/exhaust ports (1, 3, 5) and working ports (2, 4)
2	Silencer	U-¼-B-NPT for exhaust ports (3, 5)
3	Electrical connection	Spring-loaded terminal, cable (open end)
4	Valve VSVA	Width 26 mm
5	Manual override	Non-detenting/detenting, per solenoid coil
6	Cover cap, coded	For non-detenting manual override (limited function)
7	Cover cap, covered	MO covered by cover cap – operation of MO prevented
8	Inscription label holder	For valves
9	Individual sub-base	For valve VSVA
10	Inscription label holder	For manifold block

Valve terminals VTSA/VTSA-F, NPT

Peripherals – Pneumatic components

Individual sub-base, width 42 mm, ISO 5599-2

With spring-loaded terminal or cable (open end)

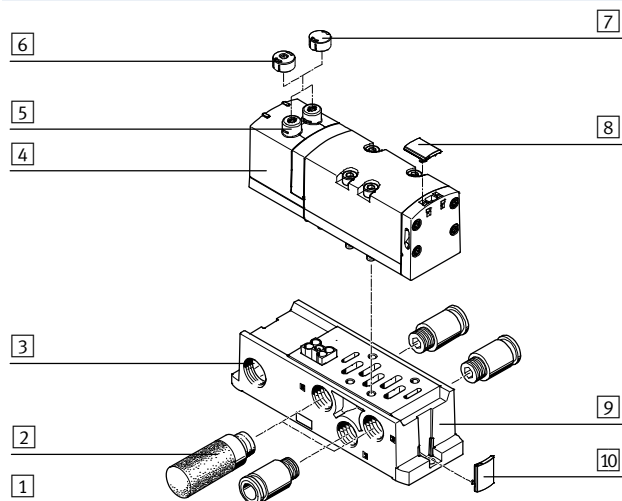

	Brief description	→ Page/Internet
1	Fitting	3/8" NPT for air/exhaust ports (1, 3, 5) and working ports (2, 4)
2	Silencer	U-3/8-B-NPT for exhaust ports (3, 5)
3	Electrical connection	Spring-loaded terminal, cable (open end)
4	Valve VSVA	Width 42 mm
5	Manual override	Non-detenting/detenting, per solenoid coil
6	Cover cap, coded	For non-detenting manual override (limited function)
7	Cover cap, covered	MO covered by cover cap – operation of MO prevented
8	Inscription label holder	For valves
9	Individual sub-base	For valve VSVA
10	Inscription label holder	For manifold block

Valve terminals VTSA/VTSA-F, NPT

Peripherals – Pneumatic components

Individual sub-base, width 52 mm, ISO 5599-2
With spring-loaded terminal or cable (open end)

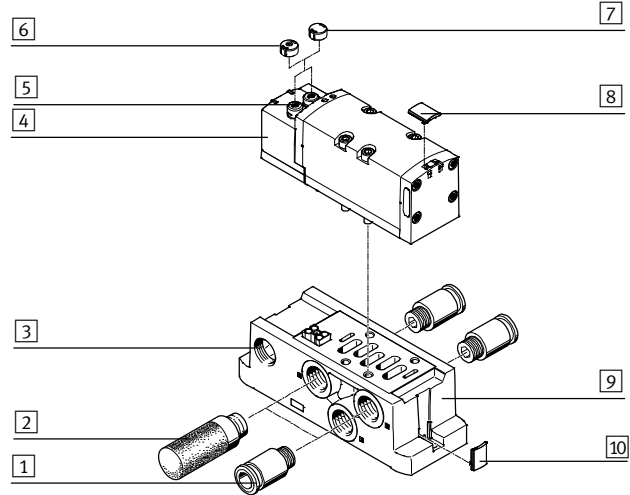

	Brief description	→ Page/Internet
1	Fitting	1/2" NPT for air/exhaust ports (1, 3, 5) and working ports (2, 4)
2	Silencer	U-1/2-B-NPT for exhaust ports (3, 5)
3	Electrical connection	Spring-loaded terminal, cable (open end)
4	Valve VSVA	Width 52 mm
5	Manual override	Non-detenting/detenting, per solenoid coil
6	Cover cap, coded	For non-detenting manual override (limited function)
7	Cover cap, covered	MO covered by cover cap – operation of MO prevented
8	Inscription label holder	For valves
9	Individual sub-base	For valve VSVA
10	Inscription label holder	For manifold block

Valve terminals VTSA/VTSA-F, NPT

Peripherals – Pneumatic components

Valve terminal pneumatics

The manifold sub-bases for valves with a width of 18 or 26 mm are either prepared for

- 2 single solenoid valves or
- 2 double solenoid valves

The manifold sub-bases for valves with a width of 42 or 52 mm are suitable for

- 1 single solenoid valve or
- 1 double solenoid valve.

- Double solenoid valve positions can be equipped with any valve or a blanking plate.

- Single solenoid valve positions can only be equipped with single solenoid valves or a blanking plate.

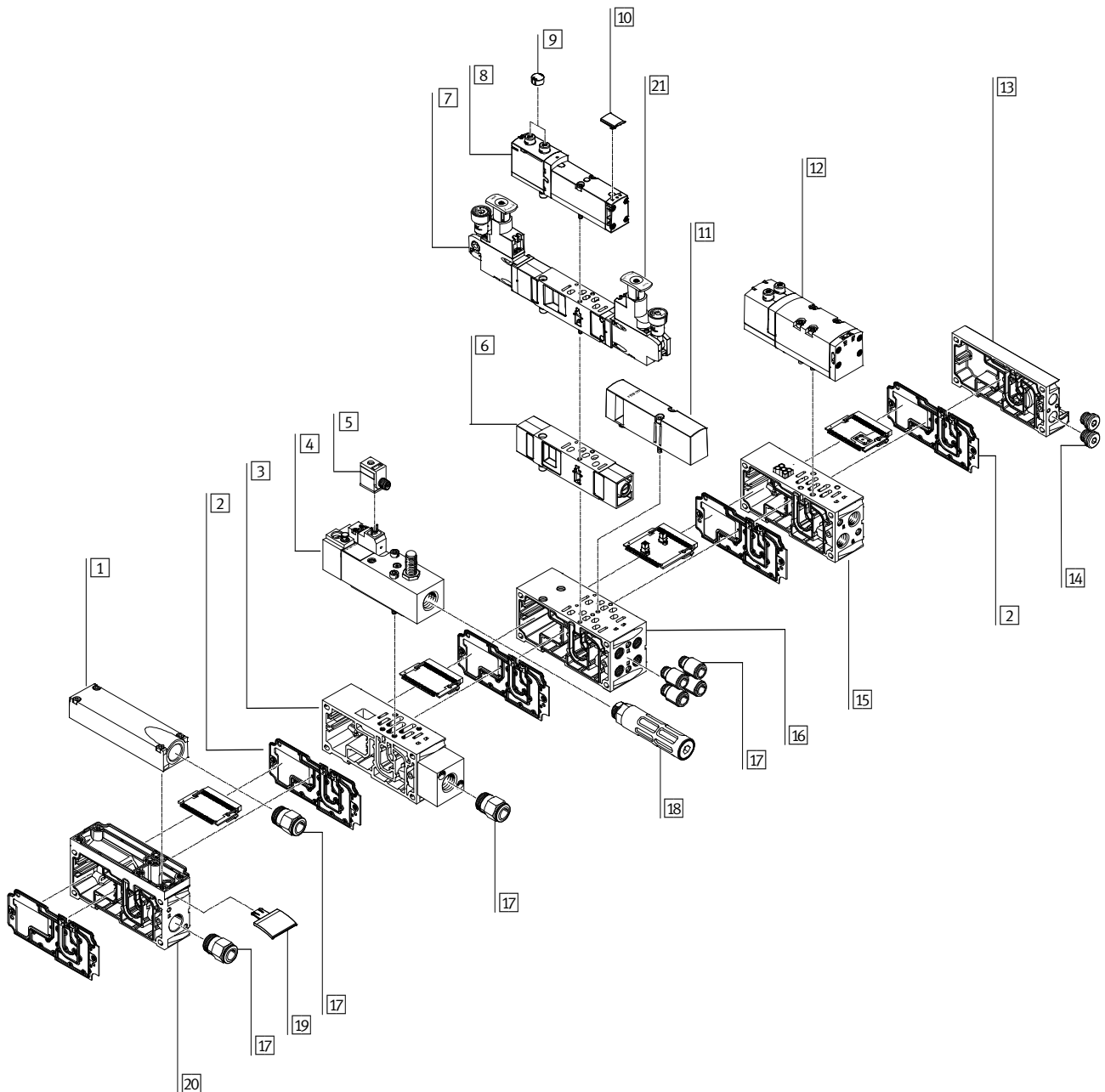

Valve terminals VTSA/VTSA-F, NPT

Peripherals – Pneumatic components

Valve terminal pneumatics		
	Brief description	→ Page/Internet
1	Exhaust port cover	For ducted exhaust air (ports 3 and 5 combined)
2	Duct separation/seal	–
3	Manifold sub-base	For soft-start valve
4	Soft-start valve	For slow and safe pressure build-up
5	Plug socket	–
6	Flow control plate	–
7	Pressure regulator plate	–
8	Valve	Width 18 mm or 26 mm
9	Cover cap	For manual override, non-detenting, covered
10	Inscription label holder	For valve
11	Blanking plate	For unused valve position (vacant position)
12	Valve	Width 42 mm or 52 mm
13	End plate with pilot air selector	–
14	Blanking plug	–
15	Manifold sub-base VTSA	For valves with a width of 42 mm or 52 mm
15	Manifold sub-base VTSA-F	For valves with a width of 42 mm or 52 mm
16	Manifold sub-base VTSA	For valves with a width of 18 mm or 26 mm
16	Manifold sub-base VTSA-F	For valves with a width of 18 mm or 26 mm
17	Fittings	–
18	Silencer	–
19	Inscription label holder	For manifold sub-base, sub-base, 90° connection plate
20	Supply plate	–
21	Control element	Regulator knobs in different versions

Valve terminals VTSA/VTSA-F, NPT

Peripherals – Pneumatic components

Valve terminal widths

Order code for VTSA:

- 44E-... for the electrical components
- 44P-... for the pneumatic components

Order code for VTSA-F:

- 45E-... for the electrical components
- 45P-... for the pneumatic components

Regardless of the type of actuation (e.g. multi-pin plug, fieldbus, etc.), valve terminals VTSA/VTSA-F in the widths

- 18 mm
- 26 mm
- 42 mm
- 52 mm

can be combined without adapters.

This enables a flow range of 400 l/min to 2,900 l/min in the case of VTSA and 700 l/min to 2,900 l/min in the case of VTSA-F

to be covered on one valve terminal. A wide range of valve functions and vertical stacking components are available for all widths.

Valves with a width of 65 mm can be mixed with other widths. However, these are only configured after the adapter plate VABA and are thus always at the end of the valve terminal configuration.

See "Adaptation to width 65 mm, ISO size 3 (technology type 04)"

→ page 165

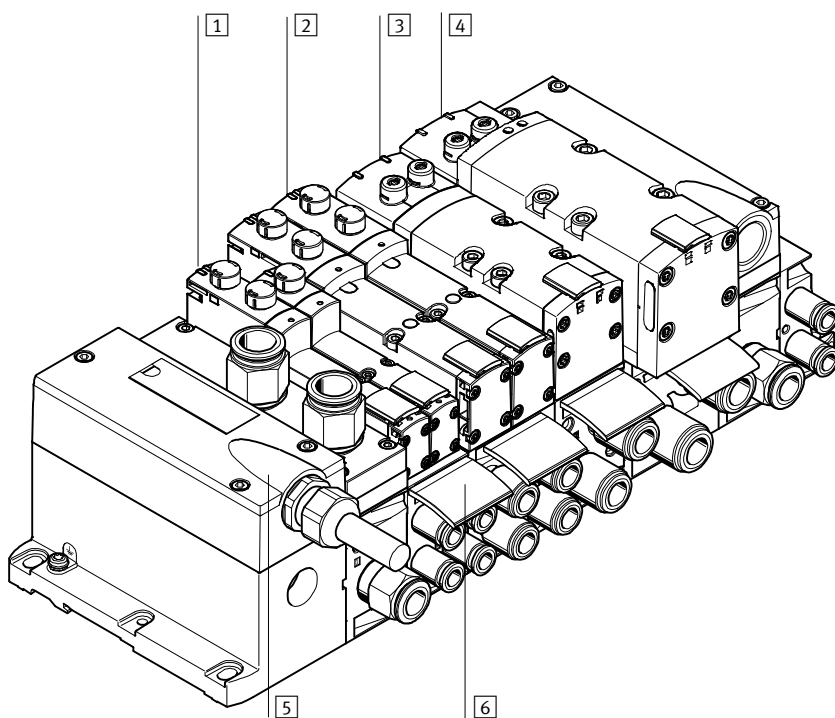

	Brief description	→ Page/Internet	
1	Valve	Width 18 mm	118
2	Valve	Width 26 mm	118
3	Valve	Width 42 mm	118
4	Valve	Width 52 mm	118
5	Multi-pin plug connection	Via multi-pin cable, 24 V DC	125
6	Inscription labels	For manifold sub-base, sub-base, 90° connection plate	127

Valve terminals VTSA/VTSA-F, NPT

Peripherals – Electrical components

Valve terminal with individual electrical connection

Order code for VTSA:

- 44E-... for the electrical components
- 44P-... for the pneumatic components

Order code for VTSA-F:

- 45E-... for the electrical components
- 45P-... for the pneumatic components

Valve terminals VTSA/VTSA-F with individual electrical connection can be expanded with up to 20 valves with max. 20 solenoid coils.

The manifold sub-bases for valves with a width of 18 or 26 mm are either prepared for

- 2 single solenoid valves or
- 2 double solenoid valves

and the manifold sub-bases for valves with a width of 42, 52 and 65 mm are prepared for

- 1 single solenoid valve or
- 1 double solenoid valve.

- Double solenoid valve positions can be equipped with any valve or a blanking plate.
- Single solenoid valve positions can only be equipped with single solenoid valves or a blanking plate.
- The electrical connection is established via a 5-pin M12 plug (24 V DC).

- Valves with a width of 65 mm cannot be mixed with other widths – these are always at the end of the valve terminal configuration. See "Adaptation to width 65 mm, ISO size 3 (technology type 04)"

→ Page 165

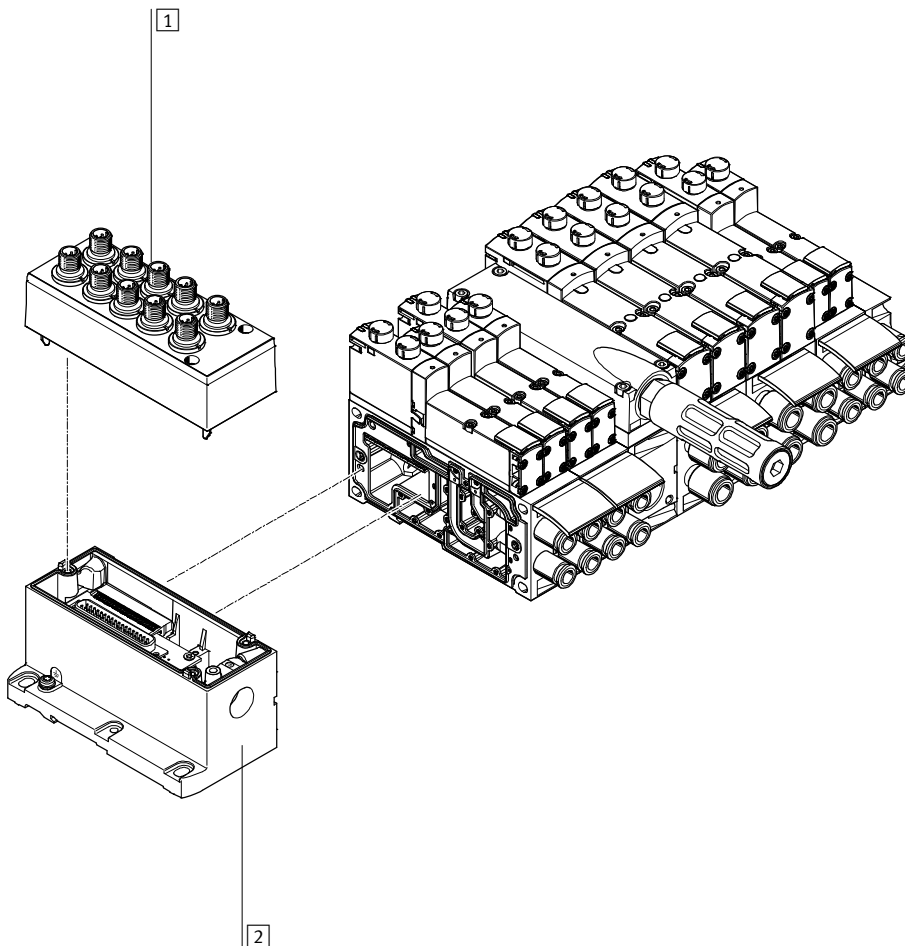

	Brief description	→ Page/Internet
1	Cover For individual connection	125
2	Multi-pin plug connection Individual connection with M12, 10-way or 6-way (including cover)	125

Valve terminals VTSA/VTSA-F, NPT

Peripherals – Electrical components

Valve terminal with electrical multi-pin plug connection

Order code for VTSA:

- 44E-... for the electrical components
- 44P-... for the pneumatic components

Order code for VTSA-F:

- 45E-... for the electrical components
- 45P-... for the pneumatic components

Valve terminals VTSA/VTSA-F with electrical multi-pin plug connection can be expanded with up to 32 valves with max. 32 solenoid coils. The manifold sub-bases for valves with a width of 18 or 26 mm are prepared for

- 2 single solenoid valves or
- 2 double solenoid valves

and the manifold sub-bases for valves with a width of 42, 52 and 65 mm are prepared for

- 1 single solenoid valve or
- 1 double solenoid valve.

- Double solenoid valve positions can be equipped with any valve or a blanking plate.
- Single solenoid valve positions can only be equipped with single solenoid valves or a blanking plate.
- The following multi-pin plug connections to IP65 are available:
 - 37-pin Sub-D connection (24 V DC): the connecting cable can be ordered in lengths of 2.5 m, 5 m and 10 m for max. 8, 22 or 32 solenoid coils respectively.

- Terminal strip (24 V DC or 110 V AC) 19-pin round connector (24 V DC)
- Valves with a width of 65 mm cannot be mixed with other widths – these are always at the end of the valve terminal configuration. See "Adaptation to width 65 mm, ISO size 3 (technology type 04)"

→ Page 165

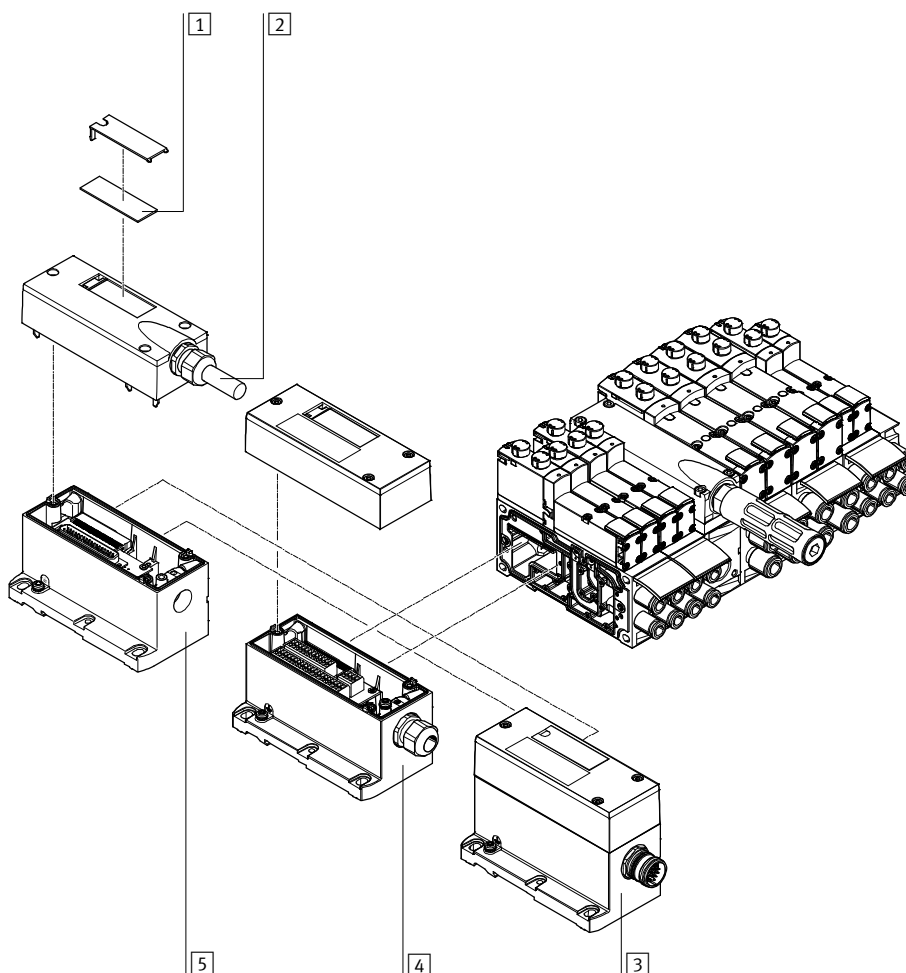

	Brief description	→ Page/Internet	
1	Inscription labels	Large, for multi-pin plug connection	–
2	Multi-pin cable	–	126
3	Multi-pin plug connection	Via M23 round plug connection, 24 V DC	125
4	Multi-pin plug connection	Via terminal strip (Cage Clamp®), 24 V DC or 110 V AC	125
5	Multi-pin plug connection	Via multi-pin cable, 24 V DC	125

Valve terminals VTSA/VTSA-F, NPT

Peripherals – Electrical components

Valve terminal with AS-Interface connection

Order code for VTSA:

- 52E... for the electrical components
- 44P... for the pneumatic components

Order code for VTSA-F:

- 52E... for the electrical components
- 45P... for the pneumatic components

Valve terminals VTSA/VTSA-F with AS-Interface connection can be expanded with up to 8 valves with max. 8 solenoid coils.

The manifold sub-bases for valves with a width of 18 or 26 mm are either prepared for

- 2 single solenoid valves or
- 2 double solenoid valves

and the manifold sub-bases for valves with a width of 42, 52 and 65 mm are prepared for

- 1 single solenoid valve or
- 1 double solenoid valve.

- Double solenoid valve positions can be equipped with any valve or a blanking plate.

- Single solenoid valve positions can only be equipped with single solenoid valves or a blanking plate.

- Valves with a width of 65 mm cannot be mixed with other widths – these are always at the end of the valve terminal configuration. See "Adaptation to width 65 mm, ISO size 3 (technology type 04)"

→ Page 165

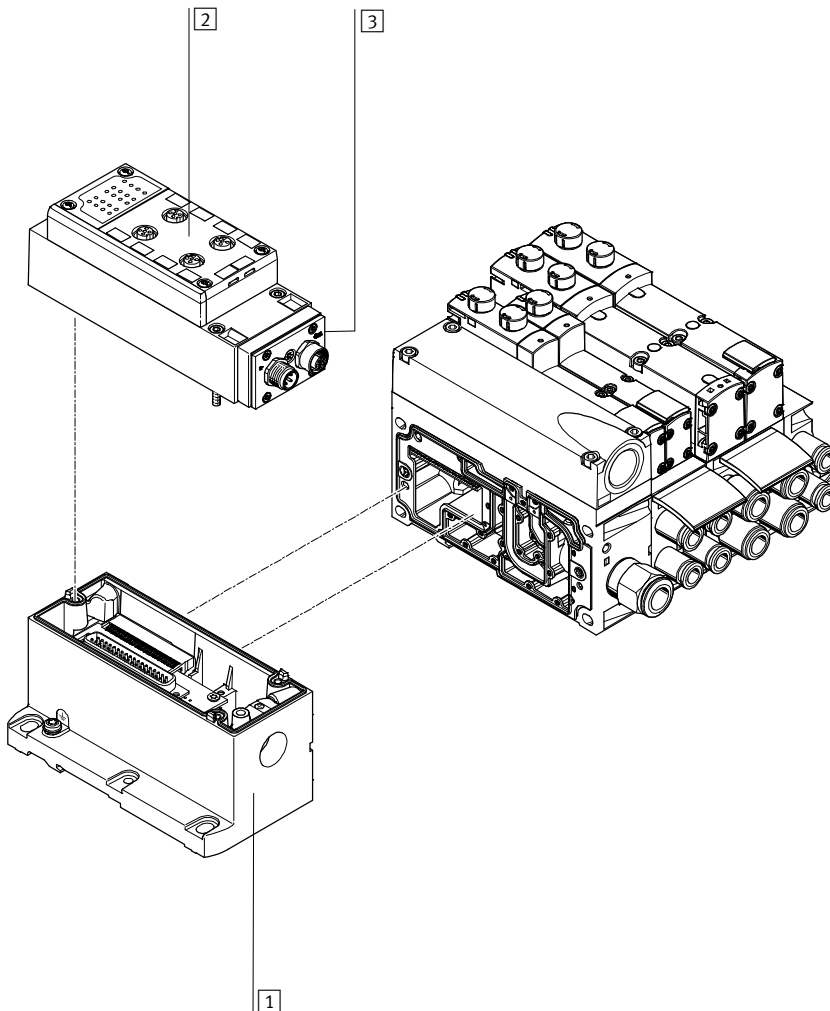

	Brief description	→ Page/Internet
1	Multi-pin plug connection	Can be ordered together with the AS-Interface module as an electrical connection for AS-Interface
2	Manifold block for AS-Interface	125
3	AS-Interface module	126

Valve terminals VTSA/VTSA-F, NPT

Peripherals – Electrical components

Valve terminal with fieldbus connection, control block (electrical peripherals CPX)

Order code:

- 50E-... for the electrical peripherals, plastic manifold module
- 51E-... for the electrical peripherals, metal manifold module
- 53E-... for the electrical peripherals, for control cabinet installation

For VTSA:

- 44P-... for the pneumatic components

For VTSA-F:

- 45P-... for the pneumatic components

Valve terminals VTSA/VTSA-F with fieldbus interface can be expanded with up to 32 valves with max. 32 solenoid coils.

The manifold sub-bases for valves with a width of 18 or 26 mm are either prepared for

- 2 single solenoid valves or
 - 2 double solenoid valves
- and the manifold sub-bases for valves with a width of 42, 52 and 65 mm are prepared for
- 1 single solenoid valve or
 - 1 double solenoid valve.

- Double solenoid valve positions can be equipped with any valve or a blanking plate.
- Single solenoid valve positions can only be equipped with single solenoid valves or a blanking plate.

Each valve position can be equipped with any valve or a blanking plate. The rules for CPX apply to the equipment that can be used in combination with the electrical peripherals CPX.

In general:

- Max. 10 electrical modules
- Digital inputs/outputs
- Analogue inputs/outputs

- Parameterisation of inputs and outputs
- Integrated convenient diagnostic system
- Preventive maintenance concepts

- Valves with a width of 65 mm cannot be mixed with other widths – these are always at the end of the valve terminal configuration. See "Adaptation to width 65 mm, ISO size 3 (technology type 04)"

→ Page 165

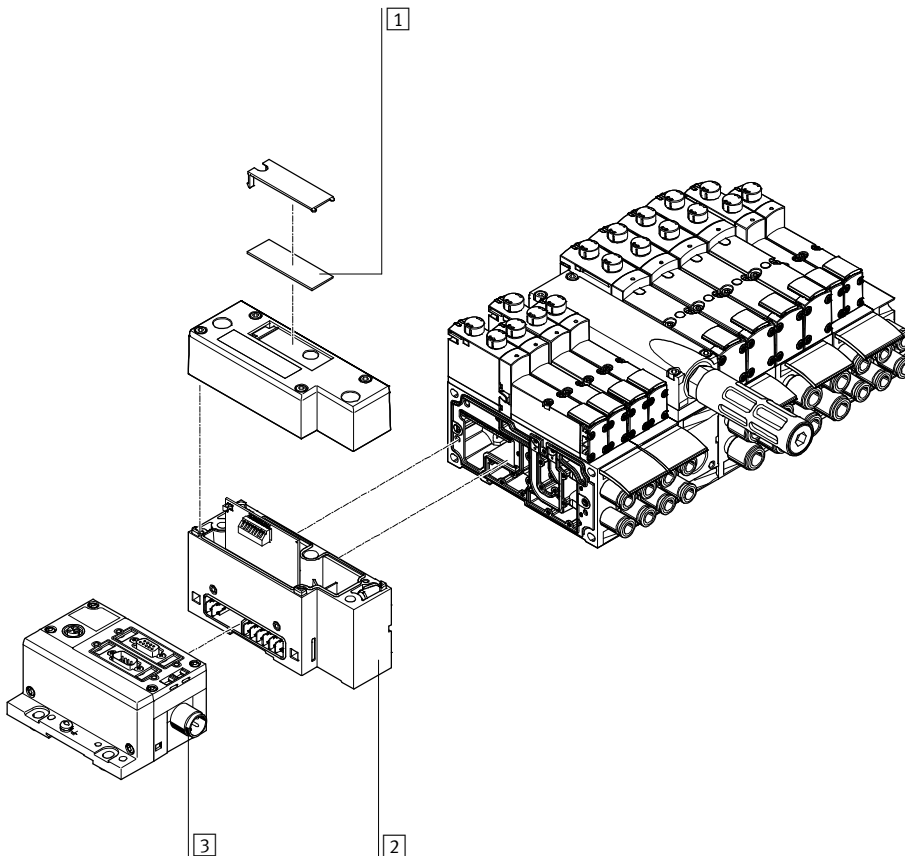

	Brief description	→ Page/Internet
1	Inscription labels	Large, for pneumatic interface CPX
2	Pneumatic interface	–
3	Fieldbus interface	–

Valve terminals VTSA/VTSA-F, NPT

Peripherals – Electrical components

Valve terminal with fieldbus/multi-pin plug connection and individually electrically actuated valve

In applications with specific emergency off conditions, it may be necessary to switch one or more valves separately from the valve terminal controller. Standard valves (VSVA) with individual electrical connection (round or square plug) are mounted

on the valve terminal to this end. In order for protection class IP65 to be achieved, the functionless opening in the sub-base for the electrical connection must be sealed. A sealing cap is available for the 18 mm and 26 mm widths.

With manifold or individual sub-bases, valves with width 42 mm and 52 mm must be used with a seal to comply with the IP protection class (see → page 124). For central control of the valve terminal via a multi-pin plug or fieldbus

connection, the valve position occupied in this way acts like a vacant position, i.e. the assigned address in the fieldbus node or the corresponding connection in the multi-pin plug connection is occupied.

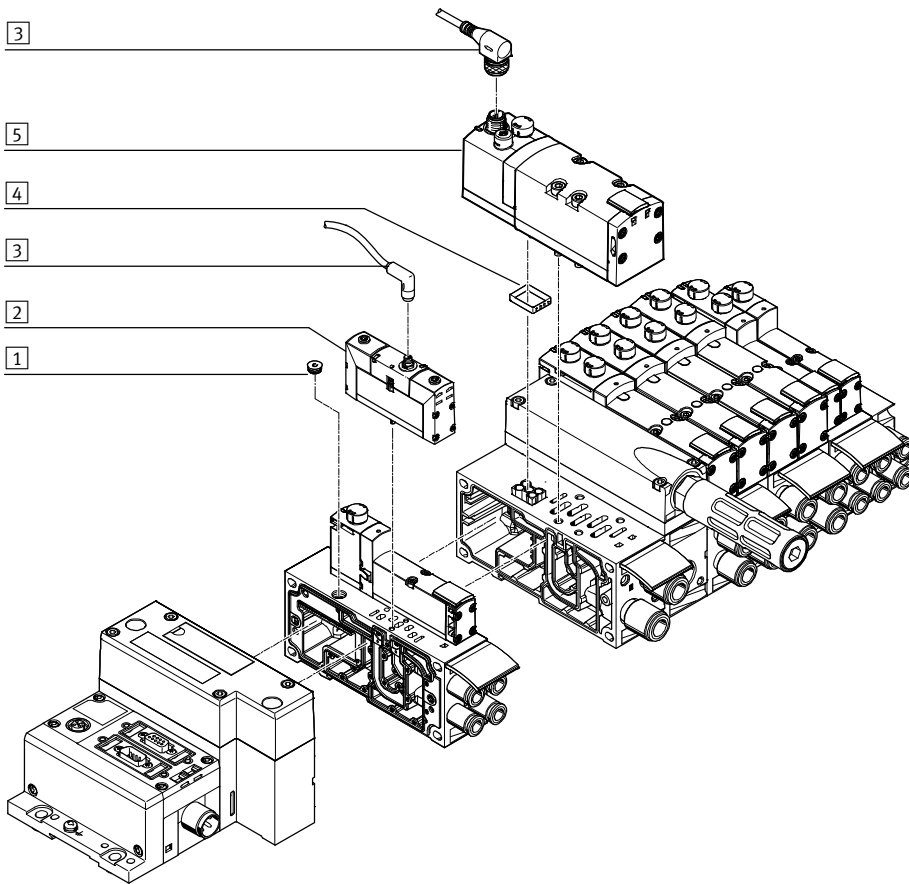

	Brief description	→ Page/Internet	
1	Sealing cap	For sealing the electrical connection on the sub-base	124
2	Valve	Width 18 mm or width 26 mm	valves vsva
3	Connecting cable	–	valves vsva
4	Seal	For ensuring the IP protection class (with width 42 mm and 52 mm)	124
5	Valve	Width 42 mm or width 52 mm	valves vsva

 Note

Standard valves VSVA can be used for valve terminal allocation. A vacant position must be provided for this in the valve terminal configurator.

The corresponding standard valve VSVA can be ordered on the Internet at:
→ vsva

Valve terminals VTSA/VTSA-F, NPT

Key features – Pneumatic components

Manifold sub-base

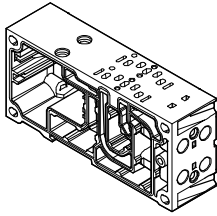

VTSA/VTSA-F is based on a modular system which consists of manifold sub-bases and valves. The VTSA-F manifold sub-bases are designed to optimise flow. Manifold sub-bases are available for valve widths 18 mm and 26 mm in a double grid, i.e. two valves per manifold sub-base. For valves with a width of 42 mm or 52 mm, there are manifold sub-bases with one valve per sub-base. The manifold sub-base contains a duct

seal and an electrical interlinking module. They can be freely mixed within a valve terminal. The manifold sub-bases are screwed together and thus form the support system for the valves. Inside the manifold sub-bases are the ducts for supplying compressed air to and exhausting from the valve terminal as well as the working ports for the pneumatic cylinders for each valve. Each manifold sub-

base is connected to the next using four screws. Individual valve terminal sections can be isolated and further manifold sub-bases inserted by loosening these screws. This ensures that the valve terminal can be rapidly and reliably extended.

See also "Adaptation to width 65 mm, ISO size 3 (technology type 04)"
 → Page 165

Port patterns on the manifold sub-base for one valve position

Width 18 mm

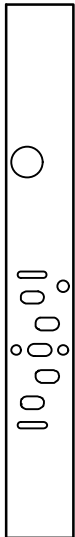

Width 26 mm

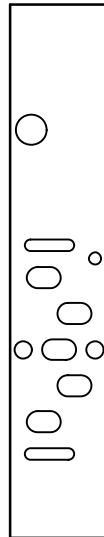

Width 42 mm

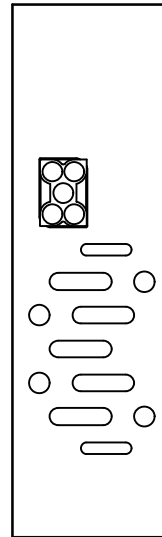

Width 52 mm

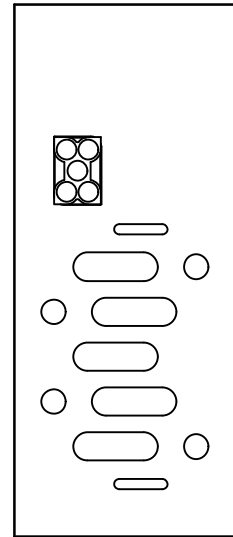

-  - Note

The illustrations shown depict a schematic representation of the pneumatic ISO port patterns.

The port patterns on the valve terminal VTSA-F do not correspond to the ISO standard.

Valve terminals VTSA/VTSA-F, NPT

Key features – Pneumatic components

FESTO

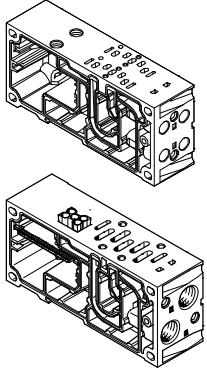
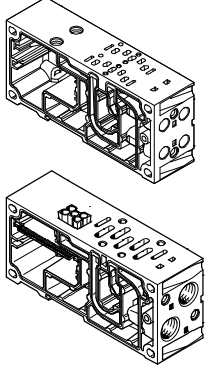
Manifold sub-base variants with QS fitting, valve terminal VTSA									
Code		Type	Width				No. of valve positions (solenoid coils) ¹⁾	Working ports (2, 4)	
			18 mm	26 mm	42 mm	52 mm		Code M large	Code N small
Manifold sub-base for double solenoid valves									
A		VABV-S4-2S-N18-2T2	■	-	-	-	2 (4)	QB-1/8-5/16-U	-
AK								-	QB-1/8-1/4-U
B		VABV-S4-1S-N14-2T2	-	■	-	-	2 (4)	QB-1/4-3/8-U	-
BK								-	QB-1/4-5/16-U
C		VABV-S2-1S-N38-T2	-	-	■	-	1 (2)	QB-3/8-1/2-U	-
CK								-	QB-3/8-3/8-U
D		VABV-S2-2S-N12-T2	-	-	-	■	1 (2)	QB-1/2-1/2-U	-
DK								-	-
Manifold sub-base for single solenoid valves									
E		VABV-S4-2S-N18-2T1	■	-	-	-	2 (2)	QB-1/8-5/16-U	-
EK								-	QB-1/8-1/4-U
F		VABV-S4-1S-N14-2T1	-	■	-	-	2 (2)	QB-1/4-3/8-U	-
FK								-	QB-1/4-5/16-U
G		VABV-S2-1S-N38-T1	-	-	■	-	1 (1)	QB-3/8-1/2-U	-
GK								-	QB-3/8-3/8-U
H		VABV-S2-2S-N12-T1	-	-	-	■	1 (1)	QB-1/2-1/2-U	-
HK								-	-

1) Value in brackets is max. number of solenoid coils that can be controlled

Valve terminals VTSA/VTSA-F, NPT

Key features – Pneumatic components



Manifold sub-base variants with QS fitting, valve terminal VTSA-F									
Code	Image	Type	Width				No. of valve positions (solenoid coils) ¹⁾	Working ports (2, 4)	
			18 mm	26 mm	42 mm	52 mm		Code M large	Code N small
Manifold sub-base for double solenoid valves									
A		VABV-S4-2HS-N18-2T2	■	-	-	-	2 (4)	QB-1/8-5/16-U	-
AK								-	QB-1/8-1/4-U
B		VABV-S4-1HS-N14-2T2	-	■	-	-	2 (4)	QB-1/4-3/8-U	-
BK								-	QB-1/4-5/16-U
C		VABV-S2-1S-N38-T2	-	-	■	-	1 (2)	QB-3/8-1/2-U	-
CK								-	QB-3/8-3/8-U
D	VABV-S2-2S-N12-T2	-	-	-	■	1 (2)	QB-1/2-1/2-U	-	
DK							-	-	
Manifold sub-base for single solenoid valves									
E		VABV-S4-2HS-N18-2T1	■	-	-	-	2 (2)	QB-1/8-5/16-U	-
EK								-	QB-1/8-1/4-U
F		VABV-S4-1HS-N14-2T1	-	■	-	-	2 (2)	QB-1/4-3/8-U	-
FK								-	QB-1/4-5/16-U
G		VABV-S2-1S-N38-T1	-	-	■	-	1 (1)	QB-3/8-1/2-U	-
GK								-	QB-3/8-3/8-U
H	VABV-S2-2S-N12-T1	-	-	-	■	1 (1)	QB-1/2-1/2-U	-	
HK							-	-	

1) Value in brackets is max. number of solenoid coils that can be controlled

90° connection plate for working ports 2 and 4 with NPT thread									
Code	Image	Type	Width				Ports	Working ports (2, 4) on the 90° connection plate	
			18 mm	26 mm	42 mm	52 mm			
P		VABF-S4-...-A2G2-N...	■	-	-	-	2 and 4	1/8" NPT	
			-	■	-	-		1/4" NPT	
			-	-	■	-		3/8" NPT	
			-	-	-	■		1/2" NPT	

Valve terminals VTSA/VTSA-F, NPT

Key features – Pneumatic components

Sub-base valve

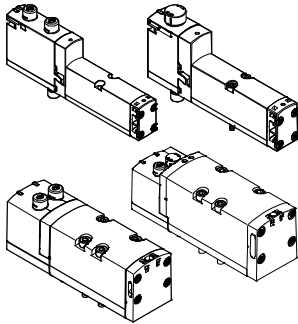

All valves are fitted with piston spool and patented sealing system, which ensures efficient sealing, a broad operating pressure range and long service life.

Sub-base valves can be quickly replaced since the tubing connections remain on the manifold sub-base.

Irrespective of the valve function there are sub-base valves with one solenoid coil (single solenoid) or with two solenoid coils for double solenoid or double valve functions.

Reverse/vacuum operation

Select reverse operation (code Z) if you wish to operate an actuator (cylinder) with different pressures for

the forward and return stroke. Please note that the valves must then be operated via a separate pressure zone.

The reversible 3/2-way solenoid valves are also suitable for vacuum operation.

Reverse operation is only possible in pressure zones with external pilot air supply.

Note

- If a pressure zone is in reverse operation, supply air is connected to port 3/5 and exhausting takes place at port 1 at all valve positions in this pressure zone.
- Reversible pressure regulators cannot be selected when a pressure zone is in reverse operation.

- With reversible pressure regulators, only the valve at this position is in reverse operation.
- When using 5/3-way valves in reverse operation, the mid-position function switches from exhausted to pressurised and vice versa.

Blanking plate

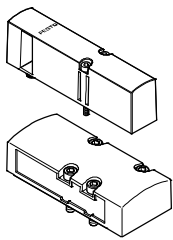

Plate without valve function for reserving valve positions on a valve terminal.

Valve and blanking plates are attached to the manifold sub-base using screws.

Design

Valve replacement

The valves are attached to the metal manifold sub-base using two or four screws, which means that they can be

easily replaced. The mechanical robustness of the manifold sub-base guarantees efficient long-term sealing.

Extension

Vacant positions can be fitted with valves at a later date. The dimensions, mounting points and existing pneumatic installations remain unchanged during this process.

For more information and technical data on expansion, refer to the user documentation:

➔ Internet: P.BE-VTSA-44

Valve terminals VTSA/VTSA-F, NPT

Key features – Pneumatic components

Valve function							
Terminal code	Circuit symbol	Valve code	Width				Description
			18 mm	26 mm	42 mm	52 mm	
VC		T22C	■	■	■	■	2x 2/2-way valve, single solenoid <ul style="list-style-type: none"> • Normally closed • Pneumatic spring return
VV		T22CV	■	■	■	-	2x 2/2-way valve, single solenoid <ul style="list-style-type: none"> • Reverse operation • Normally closed • Pneumatic spring return • Vacuum operation possible at 3 and 5
N		T32U	■	■	■	■	2x 3/2-way valve, single solenoid <ul style="list-style-type: none"> • Normally open • Pneumatic spring return • Operating pressure > 3 bar
K		T32C	■	■	■	■	2x 3/2-way valve, single solenoid <ul style="list-style-type: none"> • Normally closed • Pneumatic spring return • Operating pressure > 3 bar
H		T32H	■	■	■	■	2x 3/2-way valve, single solenoid <ul style="list-style-type: none"> • Normal position <ul style="list-style-type: none"> - 1x closed - 1x open • Pneumatic spring return • Operating pressure > 3 bar
P		T32F	■	■	■	■	2x 3/2-way valve, single solenoid <ul style="list-style-type: none"> • Reverse operation only • Normally open • Pneumatic spring return
Q		T32N	■	■	■	■	2x 3/2-way valve, single solenoid <ul style="list-style-type: none"> • Reverse operation only • Normally closed • Pneumatic spring return
R		T32W	■	■	■	■	2x 3/2-way valve, single solenoid <ul style="list-style-type: none"> • Reverse operation only • Normal position <ul style="list-style-type: none"> - 1x closed - 1x open • Pneumatic spring return

Note
 A filter must be installed upstream of valves operated in vacuum mode. This prevents any foreign matter in the intake air getting into the valve (e.g. when operating a suction cup).

Valve terminals VTSA/VTSA-F, NPT

Key features – Pneumatic components

Valve function							
Terminal code	Circuit symbol	Valve code	Width				Description
			18 mm	26 mm	42 mm	52 mm	
M		M52-A	■	■	■	■	5/2-way valve, single solenoid • Reverse operation • Pneumatic spring return
O		M52-M	■	■	■	■	5/2-way valve, single solenoid • Reverse operation • Mechanical spring return
J		B52	■	■	■	■	5/2-way valve, double solenoid
D		D52	■	■	■	■	5/2-way valve, double solenoid • Dominant signal at port 14 on the control side
SO SQ SS		M52-M	-	■	-	-	5/2-way valve ²⁾ , single solenoid, as plug-in or via pilot valve with pneumatic interface to ISO 15218 See also special valve function in the separate chapter "Solenoid valve with switching position sensing" ➔ page 134
SP SN		T52-M	-	■	-	-	2x 5/2-way valve, single solenoid, with switching position sensing, pneumatically linked via two channels as special valve function "control block with safety function" ➔ page 146
B		P53U	■	■	■	■	5/3-way solenoid valve • Mid-position pressurised ¹⁾ • Mechanical spring return
G		P53C	■	■	■	■	5/3-way solenoid valve • Mid-position closed ¹⁾ • Mechanical spring return
E		P53E	■	■	■	■	5/3-way solenoid valve • Mid-position exhausted ¹⁾ • Mechanical spring return

- 1) If neither solenoid coil is energised, the valve moves to its mid-position by means of a mechanical spring. If the two coils are permanently energised one after the other, the valve remains in the switching position of the coil that was activated first.
- 2) The symbol represents a valve with a proximity sensor with a switching output signal, in the illustration an N/O contact. In accordance with ISO 1219-1, this symbol applies to both N/O contacts and N/C contacts. The switching element function of all sensors used here is an N/C contact.

Valve terminals VTSA/VTSA-F, NPT

Key features – Pneumatic components

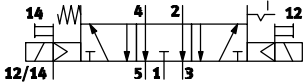
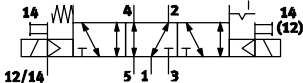
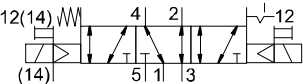
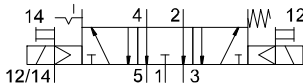
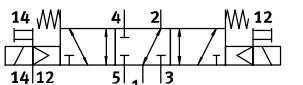
Valve function							
Terminal code	Circuit symbol	Valve code	Width				Description
			18 mm	26 mm	42 mm	52 mm	
SA		P53ED	-	■	-	-	5/3-way solenoid valve, for special functions through default position in switching position 14 <ul style="list-style-type: none"> • Pressureless switching, self-latching loop, pneumatic operation • Mid-position exhausted, switching position 14 is retained • Mechanical spring return
SB		P53AD	-	■	-	-	5/3-way solenoid valve, for special functions through default position in switching position 14 <ul style="list-style-type: none"> • Holding, blocking a movement (mechanically) • Mid-position: port 2 pressurised, port 4 exhausted, switching position 14 is retained • Mechanical spring return
SD		P53BD	■	-	-	-	5/3-way solenoid valve, for special functions through default position in switching position 14 <ul style="list-style-type: none"> • Holding, blocking a movement (mechanically) • Mid-position: port 4 pressurised, port 2 exhausted, switching position 14 is retained • Mechanical spring return
SE		P53EP	-	■	-	-	5/3-way solenoid valve, for special functions through default position in switching position 12 <ul style="list-style-type: none"> • Pressureless switching, self-latching loop, pneumatic operation • Mid-position exhausted, switching position 12 is retained • Mechanical spring return
VG		P53F	-	-	■	■	5/3-way solenoid valve <ul style="list-style-type: none"> • Positioning • Mid-position: port 2 pressurised, port 4 closed¹⁾ • Mechanical spring return
VB	-	-	-	■	-	-	Vacuum generator with ejector pulse and adjustable air saving function (plate for 2 valve positions, sensor SDE3 with display and M12 connection)
L	-	-	■	■	■	■	For valve terminal only: Blanking plate for vacant valve position

1) If neither solenoid coil is energised, the valve moves to its mid-position by means of a mechanical spring. If the two coils are permanently energised one after the other, the valve remains in the switching position of the coil that was activated first.

Valve terminals VTSA/VTSA-F, NPT

Key features – Pneumatic components

Vertical stacking

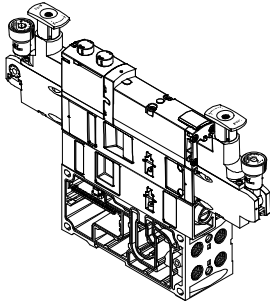

Additional function units can be added to each valve position between the sub-base (manifold sub-base) and the valve. These functions are known as vertical stacking modules and

enable special functioning or control of an individual valve position. Combinations of several valve sizes on one valve terminal are possible.

 Note
Certain combinations are not recommended due to the design of the individual vertical stacking components.

Vertical stacking components

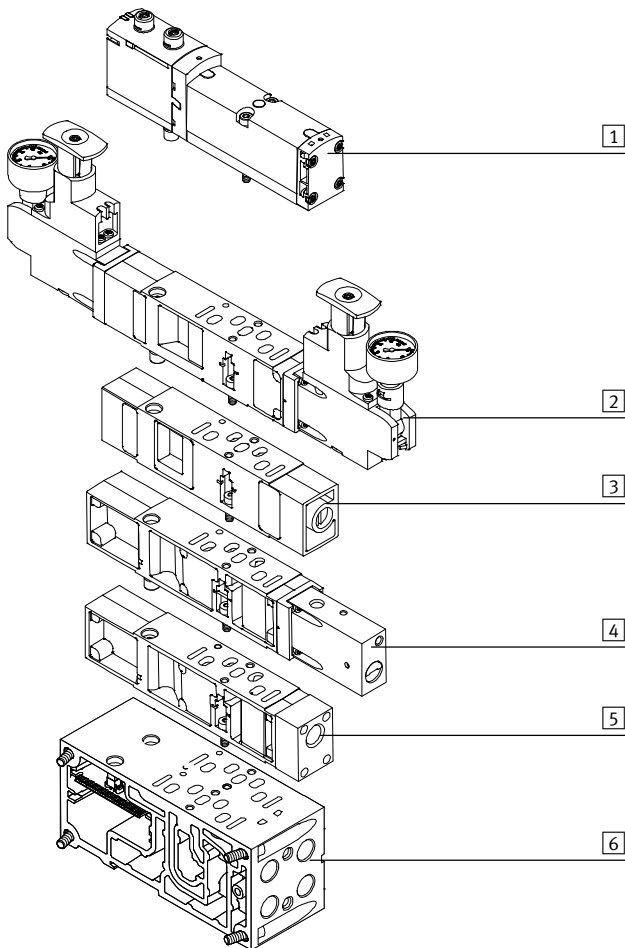

The following component sequence is recommended for valve positions with vertical stacking:

- 1 Valve VSVA
- 2 Pressure regulator plate
- 3 Flow control plate
- 4 Vertical pressure shut-off plate
- 5 Vertical supply plate
- 6 Manifold sub-base

Valve terminals VTSA/VTSA-F, NPT

Key features – Pneumatic components

Vertical stacking

Pressure regulator plate

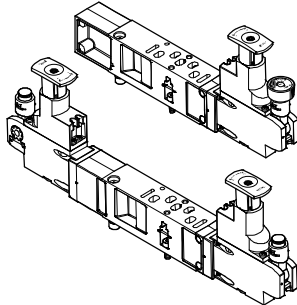

An adjustable pressure regulator can be installed between the sub-base (manifold sub-base) and the valve in order to control the force of the triggered actuator.

This pressure regulator maintains an essentially constant output pressure (secondary side) independent of pressure fluctuations (primary side) and air consumption. Also suitable for valves with symmetrical coil layout.

Standard version:

- Standard port pattern to ISO 15407-2 or ISO 5599-2
- For supply pressure up to 6 bar or up to 10 bar
- Without pressure gauge (optional)
- Regulator knob with 3 positions (locked, reference position, free running)

-  - Note

With the A, B and AB pressure regulators VABF-S...-1-..., the control pressure should not be less than 2 bar.

Use the reversible A, B or AB pressure regulators for control pressures less than 2 bar.

-  - Note

Please note for repeat orders of pressure regulators in sizes 42 mm and 52 mm:
The part number imprinted on the regulator plate refers only to the standard equipment.

When reordering pressure regulators with additional features, such as a lockable rotary knob, extended design, etc., only use the VABF configurator.

➔ Internet: vabf-s2

Valve terminals VTSA/VTSA-F, NPT

Key features – Pneumatic components

Vertical stacking

Energy efficiency through dual-pressure operation or through operation with reversible pressure regulators

Energy conservation starts right from compressed air generation. It is possible to achieve an energy saving of up to 10% per 1 bar drop in pressure. Therefore, wherever possible reduce the pressure to the minimum required.

To save additional energy, you can operate valves in dual-pressure mode in a separate pressure zone.

To do this, the valves used must be operated in reverse mode, i.e. with reversed direction of flow (see also note on → page 86). In dual-pressure operation, the valves are then supplied with pressure separately via ducts 3 and 5. The air is vented via duct 1.

Requirements for dual-pressure operation:

- Exhaust ducts 3 and 5 in the pressure zone are completely separate.
- Valves are used that can be operated in reverse mode.

Advantages of dual-pressure operation:

It is possible to save energy if different pressures can be applied to one valve. The advantages are:

- Saves energy because the return stroke can be carried out using reduced force, e.g. 3 bar instead of 6 bar.
- Just one valve is required, as in the case of vacuum application with ejector pulse for example (e.g. duct 3 for vacuum switching, duct 5 for the ejector pulse).
- A reduction in compressed air consumption of up to 50% is possible if two different pressures can be applied to the valve (return stroke uses reduced pressure).

Advantages of reversible operation:

If compressed air is applied to the pressure regulator upstream of the valve (circuit diagram 2), exhausting is directly via the solenoid valve.

This has the following advantages:

- Increased exhaust capacity, venting is up to 50% quicker
- Lower wear on the pressure regulator
- Very finely adjustable, perfect for very low operating pressures
- No quick exhaust valves are required.
- Fast cycle times
- The pressure regulator can be adjusted independently of the valve position because operating pressure is permanently present at the pressure regulator.

Dual-pressure operation with standard controller

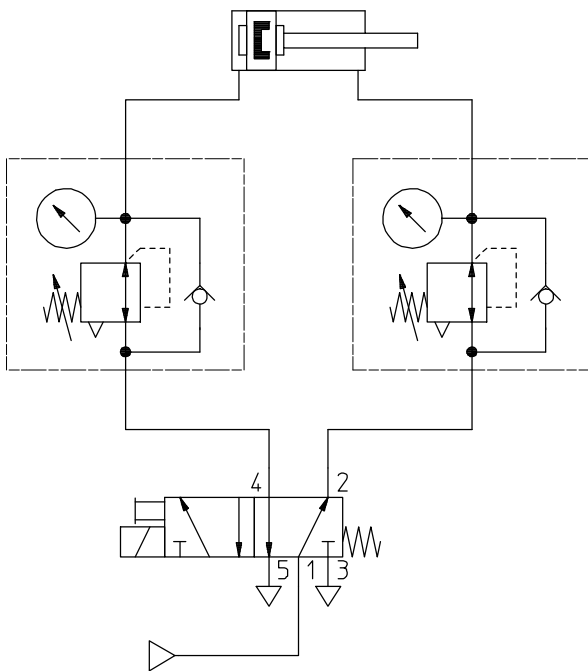

Circuit diagram 1:
Pressure is regulated downstream of the valve

Dual-pressure operation with reversible controller

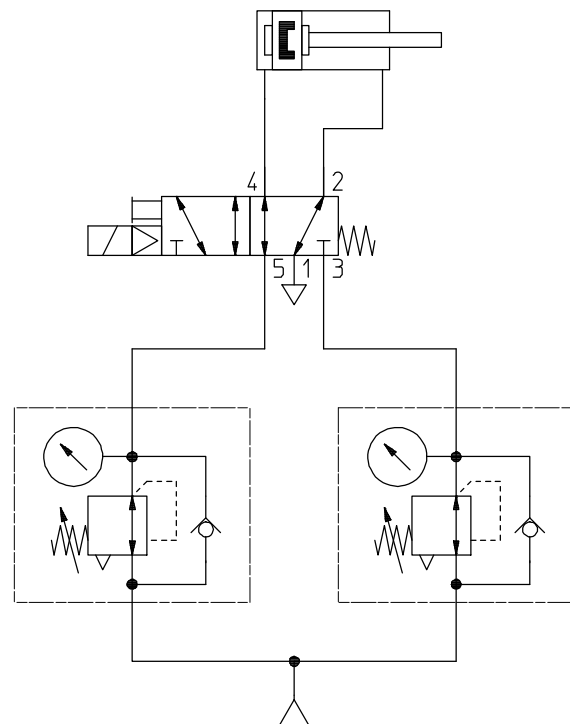

Circuit diagram 2:
Pressure is regulated upstream of the valve

Valve terminals VTSA/VTSA-F, NPT

Key features – Pneumatic components

Vertical stacking

Mode of operation of the pressure regulator plate (P regulator) for port 1; code: ZA, ZAY, ZF, ZFY

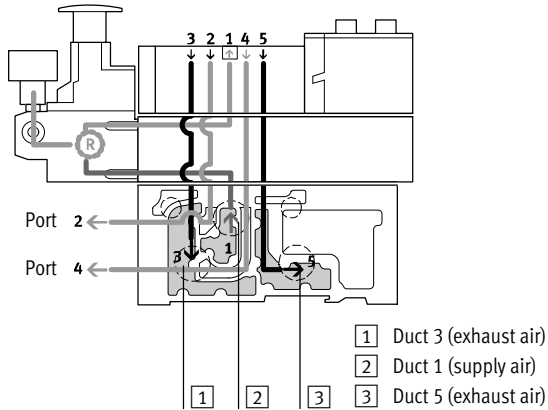

This pressure regulator regulates the pressure upstream of the valve in duct 1. Ducts 2 and 4 thus have the same regulated pressure.

During venting, the exhaust flow in the valve is from duct 2 to duct 3 and from duct 4 to duct 5.

Advantages

- The pressure regulator is not affected by venting, since the pressure is regulated upstream of the valve.
- The pressure regulator can always be adjusted, since the pressure from the valve terminal is always present.

Application examples

- An equal working pressure is required at working ports 2 and 4. (e.g. 3 bar)
- A lower working pressure (e.g. 8 bar) is required.

Mode of operation of the pressure regulator plate (AB regulator) for ports 2 and 4; code: ZD, ZDY, ZI, ZIY

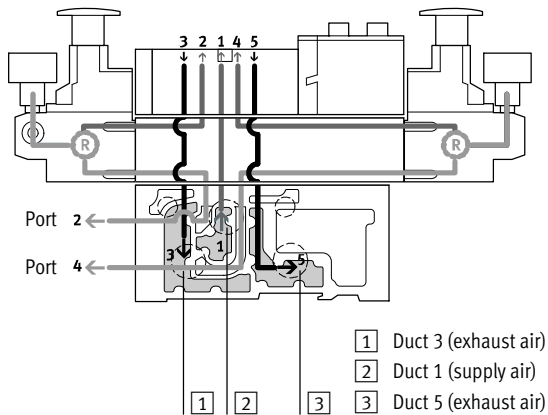

This pressure regulator regulates the pressure in ducts 2 and 4 after the pressure medium flows through the valve. During venting, the exhaust flow in the valve is from duct 2 to duct 3 and from duct 4 to duct 5 via the pressure regulator.

Example with the following switching position:
The air flows from duct 1 of the manifold sub-base via the valve to duct 2, it is then regulated and made available at port 2 of the manifold sub-base. At the same time, venting takes place via duct 4 of the manifold sub-base, via the regulator and via the valve into duct 5 of the manifold sub-base.

Restrictions

- The pressure regulator cannot be adjusted in the exhaust position. For example, the pressure regulator for duct 4 cannot be adjusted when the valve is pressurised in the switching position from duct 1 to duct 2 and exhausted from duct 4 to duct 5.

Application examples

- Two different working pressures are required at ports 2 and 4 instead of the valve terminal operating pressure.

Valve terminals VTSA/VTSA-F, NPT

Key features – Pneumatic components

FESTO

Vertical stacking

Mode of operation of the pressure regulator plate (AB regulator, reversible) for ports 2 and 4, reversible; code: ZE, ZEY, ZJ, ZJY

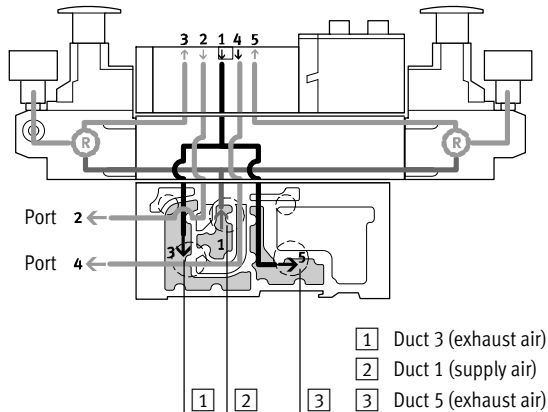

With this pressure regulator, the air (duct 1) is split and routed directly to both pressure regulators. In each case the regulated air is present in ducts 3 and 5 on the valve. The valve is thus operated in reverse mode.

This means:

- Duct 3 routes the working pressure to port 2
- Duct 5 routes the working pressure to port 4

Example with the following switching position:

The air in duct 1 is split between ducts 3 and 5 in the regulator and flows from here to the valve. In the valve, the air is routed to port 2 of the manifold sub-base. The exhaust air is simultaneously routed via duct 4 of the manifold sub-base and via the valve to regulator duct 1, where it is split between ducts 3 and 5 and then discharged via the manifold sub-base.

Application examples

- Two different pressures are required in ducts 2 and 4 instead of the valve terminal's operating pressure.
- Quick exhausting is required.
- The pressure regulator must always be adjustable.

Note

- Reversible pressure regulator plates should only be combined with valves that can be operated in reverse mode.
- Valves in valve positions with vertical pressure shut-off plates are operated with internal pilot air, even when the valve terminal is operated with external pilot air supply.
- The following combination of reversible valve terminals with vertical stacking components is not permitted:
 - Reversible pressure regulator plates
 - Flow control plates
 - Vertical pressure shut-off plates
 - Vertical supply plates

Advantages

- Fast cycle times
- 50% higher exhaust flow rate, as air is not exhausted via the pressure regulator. The load on the pressure regulator is also reduced.
- No quick exhaust valves are required.
- Operating pressure is always present at the pressure regulator, as the pressure is regulated upstream of the valve, i.e. the regulator can always be adjusted.

Disadvantages

- 2x 3/2-way solenoid valves (code N, K, H) cannot be used, as pressure is present at ports 3 and 5.
- No practical combination with a flow control plate possible.

Valve terminals VTSA/VTSA-F, NPT

Key features – Pneumatic components

Vertical stacking – Pressure regulator plate, variants ¹⁾									
Code	Type	Width				Output pressure		Description	
		18 mm	26 mm	42 mm	52 mm	6 bar	10 bar		
Pressure regulator plate for port 1 (P regulator)									
ZA		VABF-S...-R1C2-C-10	■	■	■	■	–	■	Regulates the operating pressure in duct 1 upstream of the solenoid directional control valve
ZAY ²⁾		VABF-S...-R1C2-C-10E	■	■	■	■	–	■	
ZF		VABF-S...-R1C2-C-6	■	■	■	■	■	–	
ZFY ²⁾		VABF-S...-R1C2-C-6E	■	■	■	■	■	–	
Pressure regulator plate for port 2 (B regulator)									
ZC		VABF-S...-R2C2-C-10	■	■	■	■	–	■	Regulates the operating pressure in duct 2 downstream of the solenoid directional control valve
ZCY ²⁾		VABF-S...-R2C2-C-10E	■	■	■	■	–	■	
ZH		VABF-S...-R2C2-C-6	■	■	■	■	■	–	
ZHY ²⁾		VABF-S...-R2C2-C-6E	■	■	■	■	■	–	
Pressure regulator plate for port 4 (A regulator)									
ZB ²⁾		VABF-S...-R3C2-C-10	■	■	■	■	–	■	Regulates the operating pressure in duct 4 downstream of the solenoid directional control valve
ZG ²⁾		VABF-S...-R3C2-C-6	■	■	■	■	■	–	
Pressure regulator plate for ports 2 and 4 (AB regulator)									
ZD		VABF-S...-R4C2-C-10	■	■	■	■	–	■	Regulates the working pressure in ducts 2 and 4 downstream of the solenoid directional control valve
ZDY ²⁾		VABF-S...-R4C2-C-10E	■	■	■	■	–	■	
ZI		VABF-S...-R4C2-C-6	■	■	■	■	■	–	- Note These pressure regulator plates cannot be combined with reversible 2x 3/2-way solenoid valves (code P, Q, R).
ZIY ²⁾		VABF-S...-R4C2-C-6E	■	■	■	■	■	–	

1) Width variants 42 mm and 52 mm (ISO 5599-2, ISO 1 and ISO 2) can be selected via the pressure regulator configurator VABF-S2

2) Also suitable for valves with symmetrical coil layout

Valve terminals VTSA/VTSA-F, NPT

Key features – Pneumatic components

Vertical stacking – Pressure regulator plate, reversible, variants ¹⁾									
Code		Type	Width				Output pressure		Description
			18 mm	26 mm	42 mm	52 mm	6 bar	10 bar	
Pressure regulator plate for port 2, reversible (B regulator)									
ZL		VABF-S...-R6C2-C-10	■	■	■	■	–	■	Reversible pressure regulator for port 2
ZLY ²⁾		VABF-S...-R6C2-C-10E	■	■	■	■	–	■	
ZN		VABF-S...-R6C2-C-6	■	■	■	■	■	–	
ZNY ²⁾		VABF-S...-R6C2-C-6E	■	■	■	■	■	–	
Pressure regulator plate for port 4, reversible (A regulator)									
ZK ²⁾		VABF-S...-R7C2-C-10	■	■	■	■	–	■	Reversible pressure regulator for port 4
ZM ²⁾		VABF-S...-R7C2-C-6	■	■	■	■	■	–	
Pressure regulator plate for ports 2 and 4, reversible (AB regulator)									
ZE		VABF-S...-R5C2-C-10	■	■	■	■	–	■	<ul style="list-style-type: none"> • Reversible pressure regulator for ports 2 and 4 • Pressure regulation upstream of the solenoid directional control valve • Routes the operating pressure from duct 1 to ducts 3 and 5 • Routes the exhaust air from duct 1 to ducts 3 and 5
ZEY ²⁾		VABF-S...-R5C2-C-10E	■	■	■	■	–	■	
ZJ		VABF-S...-R5C2-C-6	■	■	■	■	■	–	
ZJY ²⁾		VABF-S...-R5C2-C-6E	■	■	■	■	■	–	

1) Width variants 42 mm and 52 mm (ISO 5599-2, ISO 1 and ISO 2) can be selected via the pressure regulator configurator VABF-S2

2) Also suitable for valves with symmetrical coil layout

Valve terminals VTSA/VTSA-F, NPT

Key features – Pneumatic components

Vertical stacking – Pressure regulator plate type codes

		VABF	-	S2	-	1	R1	C2	-	C	-	6	L1	E
Valve series														
VABF	Regulator plate													
Allocation														
S2	ISO 5599-2 ¹⁾													
S4	ISO 15407-2													
Valve size														
1	26 mm (ISO 15407-2, size 01)													
2	18 mm (ISO 15407-2, size 02)													
1	42 mm (ISO 5599-2, size ISO 1)													
2	52 mm (ISO 5599-2, size ISO 2)													
Function plate														
R1	Pressure regulator, port 1													
R2	Pressure regulator, port 2													
R3	Pressure regulator, port 4													
R4	Pressure regulator, ports 2 and 4													
R5	Pressure regulator, ports 2 and 4, reversible													
R6	Pressure regulator, port 2, reversible													
R7	Pressure regulator, port 4, reversible													
Pressure indicator														
C2	Sealed													
C3	Pressure gauge [bar] ¹⁾													
C4	Pressure gauge [MPa] ¹⁾													
C6	Pressure gauge [psi] ¹⁾													
Pneumatic connection														
C	Sealed													
Pressure range														
6	6 bar													
10	10 bar													
Control element²⁾														
-	Short (standard button)													
L1	Long													
L2	Long, lockable													
K2	Short, lockable													
K3	With integrated lock													
Optional														
E	Extended design ¹⁾													

1) These functions are available via the pressure regulator configurator VABF-S2 for width 42 mm and 52 mm (ISO 5599-2, ISO 1 and ISO 2) only
Alternatively they can be selected for all four sizes in the valve terminal configurator or via their own order numbers in the chapter Accessories on page 123

2) All variants are only possible with VABF-S2

Valve terminals VTSA/VTSA-F, NPT

Key features – Pneumatic components



Vertical stacking

Flow control plate

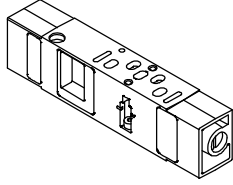

The flow control plate is equipped with two flow control valves on which the exhaust air flow rate at exhaust ports 3 or 5 can be adjusted. This enables the movement of the drive to be

initiated and the desired speed to be set on the valve terminal using the manual override. Ducts 3 and 5 can be adjusted independently of each other.



Note

On reversible valve terminals, the air flow is controlled in ducts 3 and 5 upstream of the valve.

Code	Type	Width				Description
		18 mm	26 mm	42 mm	52 mm	
X	VABF-S4...F1B1-C	■	■	■	■	<ul style="list-style-type: none"> Restricts the exhaust air downstream of the valve in ducts 3 and 5

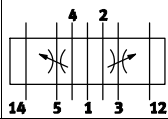

Vertical pressure shut-off plate

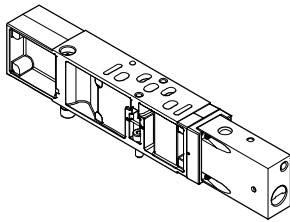

The vertical pressure shut-off plate is equipped with a switch via which the compressed air supply can be shut off. This enables a solenoid directional control valve or subsequent vertical stacking plate to be replaced without switching off the overall air supply. If the control chain has a redundant connection, the cycle can continue in

the case of a cyclical control system. Following activation of the shut-off, the exhaust air/return air from the actuated valve is discharged. This takes place via an M5 threaded connection or via duct 3 in the case of width 18 and 26 mm, and via duct 3 in the case of width 42 and 52 mm.



Note

The operating pressure of the valve terminal must lie within the range of the required pilot pressure (i.e. min. 3 bar). When using the end plate with pilot air selector, only the switching position with the code W and U can be used.

Code	Type	Width				Description
		18 mm	26 mm	42 mm	52 mm	
ZT	VABF-S4...L1D1-C	■	■	-	-	<ul style="list-style-type: none"> 3/2-way solenoid valve for shutting off the operating pressure at the valve position Blocks ducts 1 and 14 for the valve position
	VABF-S2...L1D1-C	-	-	■	■	<ul style="list-style-type: none"> Supplies the valve position with internal pilot air Pressure separation at the valve assembly

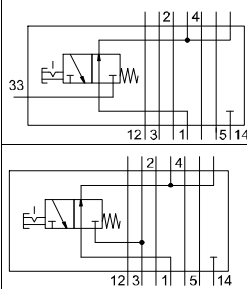

Note

The vertical pressure shut-off plates VABF... are provided only in combination with VSVA-...T1L solenoid valves from Festo. In the vertical

pressure shut-off plate only ducts 1 and 14, and not duct 12, are blocked.

Valve terminals VTSA/VTSA-F, NPT

Key features – Pneumatic components

Vertical supply plate

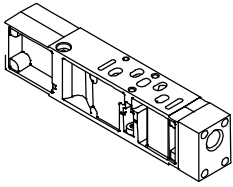

This plate enables a valve to be supplied with individual operating pressure independently of the operating pressure of the valve terminal.

As additional pressure supply for a valve. To supply an additional pressure zone.

Code	Diagram	Type	Width				Description
			26 mm	18 mm	42 mm	52 mm	
ZU		VABF-S-...P1A3-...	■	■	■	■	<ul style="list-style-type: none"> Plate with port 11 for supplying individual operating pressure to a valve position, duct 1
ZV		VABF-S-...P1A14-...	■	■	■	■	<ul style="list-style-type: none"> Plate with port 11 for supplying individual operating pressure to a valve position, ducts 1 and 14

Valve terminals VTSA/VTSA-F, NPT

Key features – Pneumatic components



Compressed air supply and exhausting

Right-hand end plate, internal pilot air supply

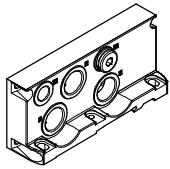

- Code V

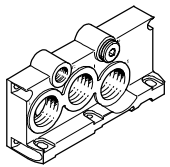

- Code V1, V3

Right-hand end plate, external pilot air supply

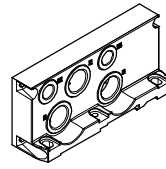

- Code X

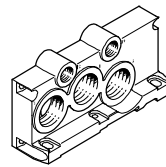

- Code X1, X3

Right-hand end plate, size ISO 3, internal pilot air supply

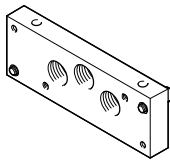

- Code V2, for width 65 mm

Right-hand end plate, size ISO 3, external pilot air supply

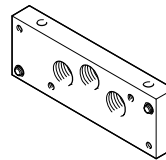

- Code X2, for width 65 mm

Right-hand end plate with pilot air selector

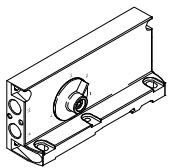

- Code Z, Y, W, U
- Code Z: selector position 1, external pilot air supply
- Code Y: selector position 2, internal pilot air supply

- Code W: selector position 3, external pilot air supply (ducted)

- Code U: selector position 4, internal pilot air supply (ducted)

The valve terminal VTSA/VTSA-F can be supplied with compressed air at one or more points. This is a reliable way of ensuring that all functional components will always offer good performance, even with large-scale

extensions. The valve terminal is generally supplied via supply plates (max. 16 per valve terminal) and/or via the right-hand end plate. When using valves with a width of 65 mm, the compressed air can also be

supplied and exhausted using the adapter plate VABA-.... Venting is via silencers or ports for ducted exhaust air on the supply plates and/or on the right-hand end plate.

Note
Compressed air supply and exhausting for size ISO 3 is described in a separate chapter on adaptation to width 65 mm (internal/external pilot air is regulated via MUH plate (solenoid valve)).

Supply plates, exhaust port 3/5 separated

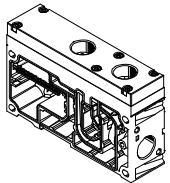

- Code K

Supply plates, exhaust port 3/5 common

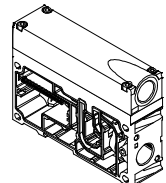

- Code L

Valve terminals VTSA/VTSA-F, NPT

Key features – Pneumatic components

Additional compressed air supply/duct separation

Additional supply plates can be used to ensure the compressed air supply for larger valve terminals or to create additional pressure zones.

These can be selected at any point upstream or downstream of the manifold sub-bases.

Supply plates contain the ports:

- Compressed air supply (1)
- Exhaust port (3/5) common or separated

Depending on your order, the exhaust air ducts are either ducted or exhausted via silencers.

VTSA/VTSA-F with ducted exhaust air:

With ducted exhaust air, venting can be via a supply plate or a right-hand end plate (code V or X).

If duct separation is required, there are three different options:

- Duct separation 1, 3, 5: code S
- Duct separation 1: code T
- Duct separation 3, 5: code R

If a combination of duct separation (S, T or R) and one or two supply plates is required, the following variants can be selected:

- Supply plate with duct separation on the left-hand side: code SU, TU, RU
- Supply plate with duct separation on the right-hand side: code US, UT, UR
- 2 supply plates with intermediate duct separation: code USU, UTU, URU

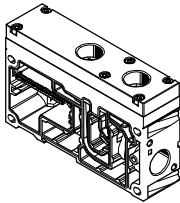
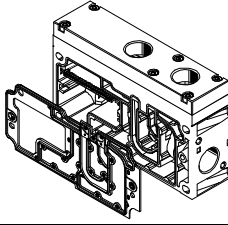
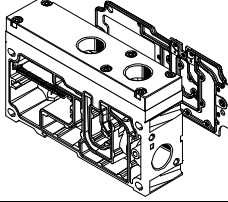
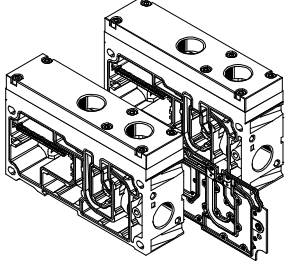
Supply plates							
Code	Image	Type	Width				Description
			18 mm	26 mm	42 mm	52 mm	
U		<ul style="list-style-type: none"> • Exhaust port 3/5 common VABF-S6-10-P1A7-G12 • Exhaust port 3/5 separated VABF-S6-10-P1A6-G12 	■	■	■	■	Supply plate without duct separation (no R, S or T selected)
SU TU RU			■	■	■	■	Supply plate with duct separation on left, if R, S or T selected
US UT UR			■	■	■	■	Supply plate with duct separation on right, if R, S or T selected
USU UTU URU			■	■	■	■	2 supply plates with duct separation in centre, if R, S or T selected

Valve terminals VTSA/VTSA-F, NPT

Key features – Pneumatic components

Right-hand end plate

Right-hand end plates with different port sizes are available depending on the air rate required.

With the following right-hand end plates, the outlet direction of the ports is aligned with the horizontal stacking direction.

Right-hand end plates with pilot air supply/pilot exhaust air

- Internal pilot air supply: code V, V1, V2 and V3 (ducts 1 and 14 are connected)
- External pilot air supply: code X, X1, X2 and X3, as well as XP1, XP2, XP3 and XS

For end plates with pilot air selector, the outlet direction of the ports is to the front of the valve terminal. This means that all the ports on the valve terminal can be combined in one outlet direction.

The special feature of the end plates with pilot air selector is the selector switch itself, which has four settings for different pilot air supply/pilot exhaust air.

End plates with pilot air selector switch set at the factory for:

- External pilot air supply: selector position 1 (code Z)
- Internal pilot air supply: selector position 2 (code Y)
- External pilot air supply, ducted pilot exhaust air: selector position 3 (code W)
- Internal pilot air supply, ducted pilot exhaust air: selector position 4 (code U)

 Note

- The end plate with pilot air selector must be used in combination with an air supply plate.
- The reversible 3/2-way solenoid valves (code P, Q, R) must only be operated in selector position 1 or 2.
- Ducted pilot exhaust air via port 12 is only possible with rotated seals on the valve.

Right-hand end plate, variants

Code	Blanking plug in duct	Pilot air supply	Ducted pilot exhaust air ¹⁾ Position of seal on solenoid valve ("ISO" is visible)	Connecting thread	
				1, 3, 5	12, 14
V	14	Internal	–	1/2" NPT	1/4" NPT
V1	14		–	3/4" NPT	1/4" NPT
V2	14		–	1" NPT	1/8" NPT
V3	14		■	3/4" NPT	1/4" NPT
X	–	External	–	1/2" NPT	1/4" NPT
X1	–		–	3/4" NPT	1/4" NPT
X2	–		–	1" NPT	1/8" NPT
X3	–		■	3/4" NPT	1/4" NPT
XP1 ²⁾	1	External, via soft-start valve ("gradual pressure build-up")	–	1/2" NPT	1/4" NPT
XP2 ³⁾	1, 14		–	1/2" NPT	1/4" NPT
XP3 ³⁾	1, 3, 5, 14		–	1/2" NPT	1/4" NPT
XS ⁴⁾	14	External, via pilot air switching valve ("switchable pilot air")	–	1/2" NPT	1/4" NPT

1) Pilot exhaust air is ducted on the end plate via port duct 12 and vented (done by turning the seal on the solenoid valve to position "ISO")

2) Not possible in combination with soft-start valve code PQ, PP, PO (with internal pilot air supply)

3) Not possible in combination with soft-start valve code PN, PM, PK (with external pilot air supply)

4) Only possible in combination with pilot air switching valve code SS with intermediate plate code ZO

Right-hand end plate with pilot air selector

Code	Pilot air supply	Selector position	Ducted pilot exhaust air ¹⁾ Position of seal on solenoid valve ("ISO" is visible)	Connecting thread 12, 14
Z	External	1	–	1/4" NPT
Y	Internal	2	–	1/4" NPT
W	External (ducted)	3	■	1/4" NPT
U	Internal (ducted)	4	■	1/4" NPT

1) Pilot exhaust air is ducted on the end plate via port duct 12 and vented (done by turning the seal on the solenoid valve to position "ISO")

Valve terminals VTSA/VTSA-F, NPT

Key features – Pneumatic components

Handling of the seals with ducted/unducted pilot exhaust air

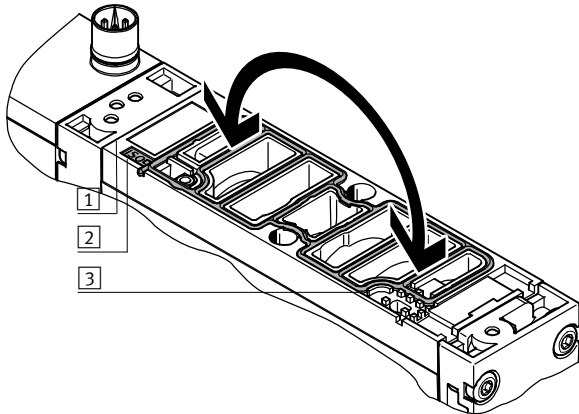

Unducted pilot exhaust air:

- The seal is visible in the inspection window on control side 14.
- The "ISO" mark is visible on the designation label on the seal surface.

Ducted pilot exhaust air:

- The seal is visible in the inspection window on control side 12.
- The "ISO" mark is visible on the designation label on the seal surface.

- 1 Designation label
- 2 Inspection window on control side 14 ("ISO" is visible)
- 3 Inspection window on control side 12 ("ISO" is visible)

Pilot air supply

The port for the pneumatic supply is located on the supply plates or the right-hand end plate.

The ports differ for the following types of pilot air supply:

- Internal
- External



If a gradual pressure build-up is required in the system by means of a soft-start valve, then external pilot

air should be selected whereby the pilot pressure is already applied at the point of switch-on.

Internal pilot air supply

Internal pilot air supply can be selected if the working pressure is between 3 and 10 bar.

In this case the pilot air supply is branched from the compressed air supply 1 using an internal connection. Port 14 on the right-hand end plate should be sealed with a blanking plug.

External pilot air supply

If the supply pressure is less than 3 bar, you must operate your valve terminal VTSA/VTSA-F using external pilot air supply.

The pilot air supply is then supplied via port 14 on the right-hand end plate. This is the case even if the valve terminal is operated with different pressure zones.



When using valves with a width of 65 mm, ISO size 3, the internal/external pilot air supply for the valves with a width of 18 ... 52 mm is provided via the adapter plate

VABA-....
The external pilot air supply for the valves with a width of 65 mm is provided via the right-hand end plate IEPR

Valve terminals VTSA/VTSA-F, NPT

Key features – Pneumatic components

FESTO

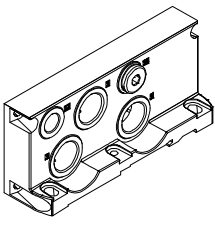
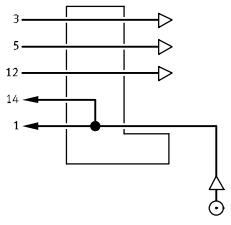
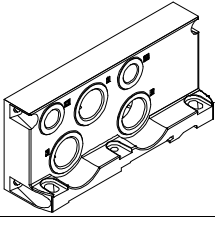
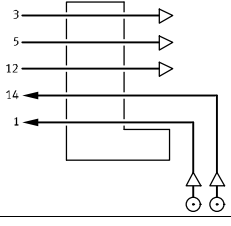
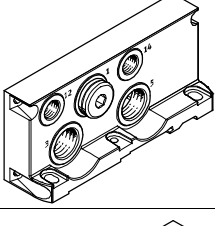
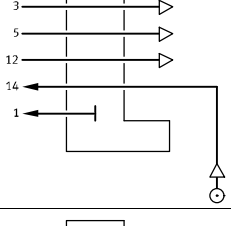
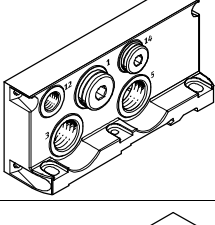
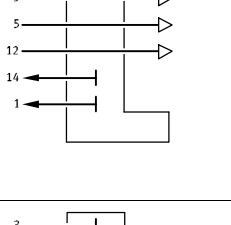
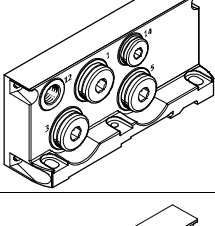
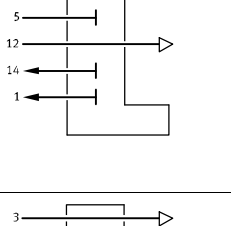
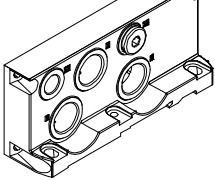
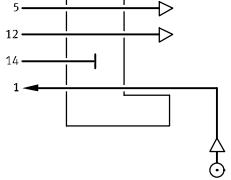
Right-hand end plate			
Code	Type of compressed air supply and pilot air supply	Description	
Right-hand end plate (symbolic representation)			
V V1 V3 V2 (ISO3)			<p>Internal pilot air supply</p> <ul style="list-style-type: none"> Pilot air supply is branched internally from port 1 Port 14 is sealed Exhaust air via ports 3 and 5 For operating pressure in the range 3 ... 10 bar Pilot exhaust air via port 12¹⁾ V1 cannot be selected in combination with a soft-start valve in the last pressure zone
X X1 X3 X2 (ISO3)			<p>External pilot air supply</p> <ul style="list-style-type: none"> Pilot air supply between 2 and 10 bar is connected at port 14 Exhaust air via ports 3 and 5 For operating pressure in the range -0.9 ... 10 bar (suitable for vacuum) Pilot exhaust air via port 12¹⁾ X1 cannot be selected in combination with a soft-start valve in the last pressure zone
XP1			<p>External pilot air supply, pressure supply via soft-start valve²⁾</p> <ul style="list-style-type: none"> Port 1 is sealed with a blanking plug Exhaust air via ports 3 and 5 Pilot exhaust air via port 12¹⁾
XP2			<p>External pilot air supply, pressure supply via soft-start valve²⁾</p> <ul style="list-style-type: none"> Internal pilot air supply 14 via soft-start valve Ports 1 and 14 are sealed Exhaust air via ports 3 and 5 Pilot exhaust air via port 12¹⁾
XP3			<p>External pilot air supply, pressure supply via soft-start valve²⁾</p> <ul style="list-style-type: none"> Internal pilot air supply 14 via soft-start valve Ports 1, 3, 5 and 14 are sealed Pilot exhaust air via port 12¹⁾
XS			<p>External pilot air supply via pilot air switching valve³⁾</p> <ul style="list-style-type: none"> Internal pilot air supply 14 via pilot air switching valve Port 14 is sealed Exhaust air via ports 3 and 5 Pilot exhaust air via port 12¹⁾

- 1) Ducted pilot exhaust air is only possible with rotated seals on the valve
- 2) Application with XP1, XP2, XP3 and soft-start valve in combination with valves of width 52 mm: please note the maximum flow rate of the soft-start valve in this pressure zone
- 3) Application with XS and pilot air switching valve in combination with intermediate plate

-  - Note

The key features, valves and functions of width 65 mm are described separately in the chapter "Adaptation to width 65 mm, ISO size 3 (technology type 04)" → Page 165.

Valve terminals VTSA/VTSA-F, NPT

Key features – Pneumatic components

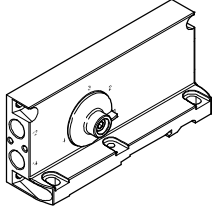
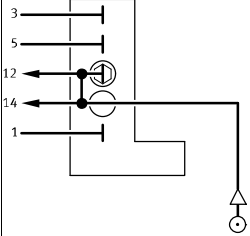
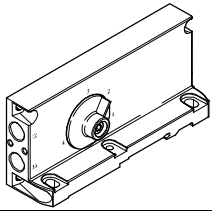
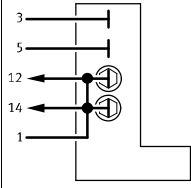
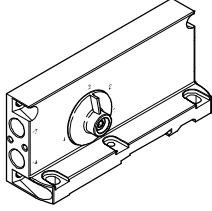
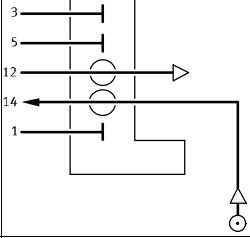
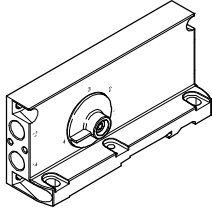
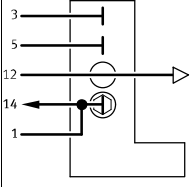
Right-hand end plate		
Code ¹⁾	Type of compressed air supply and pilot air supply	Description
End plate with pilot air selector		
Z (1)	 	<p>External pilot air supply</p> <ul style="list-style-type: none"> • Pilot air supply is connected at port 14 • Port 12 is sealed with a blanking plug • Ports 12 and 14 are internally connected • Pilot exhaust air unducted via valve housing
Y (2)	 	<p>Internal pilot air supply</p> <ul style="list-style-type: none"> • Pilot air supply is branched internally from port 1 • Ports 1, 12 and 14 are internally connected • Ports 12 and 14 are sealed with blanking plugs • Pilot exhaust air unducted via valve housing
W (3)	 	<p>External pilot air supply, ducted pilot exhaust air</p> <ul style="list-style-type: none"> • Pilot air supply is connected at port 14 • Pilot exhaust air via port 12²⁾ • Cannot be selected in combination with a soft-start valve in the last pressure zone
U (4)	 	<p>Internal pilot air supply, ducted pilot exhaust air</p> <ul style="list-style-type: none"> • Pilot air supply is branched internally from port 1 • Ports 1 and 14 are internally connected • Port 14 is sealed with a blanking plug • Pilot exhaust air via port 12²⁾ • Cannot be selected in combination with a soft-start valve in the last pressure zone

1) Selector setting in brackets

2) Ducted pilot exhaust air is only possible with rotated seals on the valve (pilot exhaust air 82/84 including venting air for valves)

-  - Note
 The reversible 3/2-way solenoid valves (code P, Q, R) must only be operated in selector position 1 or 2.

Valve terminals VTSA/VTSA-F, NPT

Key features – Pneumatic components



Configuration of all pneumatic connections with NPT thread						
Code			Port (duct)	Name	Code M Push-in connector, large	Code N Push-in connector, small
Right-hand end plate						
V			1	Push-in fitting	QS-1/2-5/8-U	QB-1/2-1/2-U
			3 and 5	Silencer or Push-in fitting	U-1/2-B-NPT or QS-1/2-5/8-U	U-1/2-B-NPT or QB-1/2-1/2-U
			12	Silencer or Push-in fitting	U-1/4-B-NPT or QB-1/4-3/8-U	U-1/4-B-NPT or QB-1/4-5/16-U
			14	Plug	B-1/4-NPT	B-1/4-NPT
X			1	Push-in fitting	QS-1/2-5/8-U	QB-1/2-1/2-U
			3 and 5	Silencer or Push-in fitting	U-1/2-B-NPT or QS-1/2-5/8-U	U-1/2-B-NPT or QB-1/2-1/2-U
			12	Silencer or Push-in fitting	U-1/4-B-NPT or QB-1/4-3/8-U	U-1/4-B-NPT or QB-1/4-5/16-U
			14	Push-in fitting	QB-1/4-3/8-U	QB-1/4-5/16-U
V1 V3			1	Female hose connector	N-3/4-P-19-NPT ¹⁾	–
			3 and 5	Silencer or Female hose connector	U-3/4-B-NPT ¹⁾ or N-3/4-P-19-NPT ¹⁾	–
			12	Silencer or Push-in fitting	U-1/4-B-NPT or QB-1/4-1/2-U	U-1/4-B-NPT or QB-1/4-3/8-U
			14	Plug	B-1/4-NPT	B-1/4-NPT
X1 X3			1	Female hose connector	N-3/4-P-19-NPT ¹⁾	–
			3 and 5	Silencer or Female hose connector	U-3/4-B-NPT or N-3/4-P-19-NPT ¹⁾	–
			12	Silencer or Push-in fitting	U-1/4-B-NPT or QB-1/4-1/2-U	U-1/4-B-NPT or QB-1/4-3/8-U
			14	Push-in fitting	QB-1/4-1/2-U	QB-1/4-3/8-U

1) For tubing with I.D. 19 mm. Use tubing clips to DIN 3017



Note

The key features, valves and functions of width 65 mm are described separately in the chapter "Adaptation to width

65 mm, ISO size 3 (technology type 04)"
→ page 165.

Valve terminals VTSA/VTSA-F, NPT

Key features – Pneumatic components

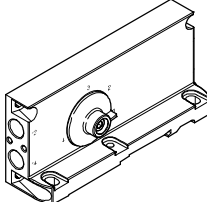
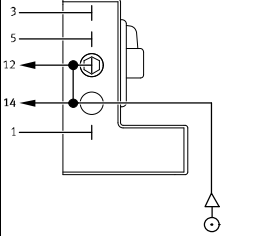
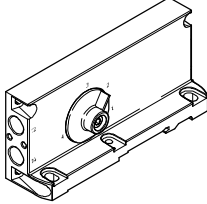
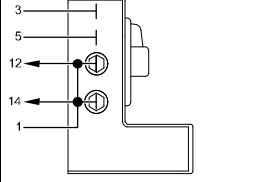
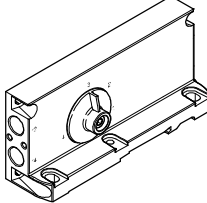
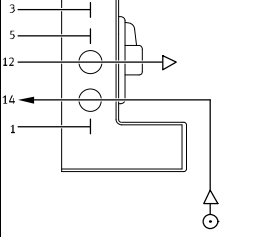
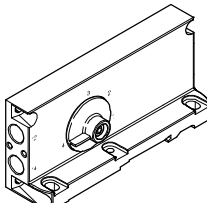
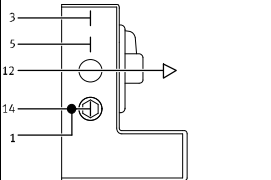
Configuration of all pneumatic connections with NPT thread						
Code ¹⁾		Port	Name	Code M Push-in con- nector, large	Code N Push-in con- nector, small	
End plate with pilot air selector						
Z (1)			12	Blanking plug	B-1/4-NPT	B-1/4-NPT
			14	Push-in fitting	QB-1/4-3/8-U	QB-1/4-5/16-U
Y (2)			12	Blanking plug	B-1/4-NPT	B-1/4-NPT
			14	Blanking plug	B-1/4-NPT	B-1/4-NPT
W (3)			12	Silencer or Push-in fitting	U-1/4-B-NPT or QB-1/4-3/8-U	U-1/4-B-NPT or QB-1/4-5/16-U
			14	Push-in fitting	QB-1/4-3/8-U	QB-1/4-5/16-U
U (4)			12	Silencer or Push-in fitting	U-1/4-B-NPT or QB-1/4-3/8-U	U-1/4-B-NPT or QB-1/4-5/16-U
			14	Blanking plug	B-1/4-NPT	B-1/4-NPT

1) Selector setting in brackets

Valve terminals VTSA/VTSA-F, NPT

Key features – Pneumatic components



Creating pressure zones and separating exhaust air

The valve terminal VTSA/VTSA-F offers a number of options for creating pressure zones if different working pressures are required. Pressure zones are created by isolating the internal supply ducts between the manifold sub-bases by means of appropriate duct separation.

Compressed air is supplied and exhausted via a supply plate. The position of the supply plates and duct separations can be freely selected for VTSA/VTSA-F.

Duct separations are integrated ex-works as per your order. Duct separations can be distinguished by their coding, even when the valve terminal is assembled.

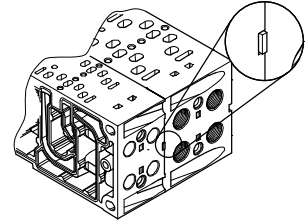

Creating pressure zones							
Code	Separating seal		Width				Description
	Illustrated examples	Coding	18 mm	26 mm	42 mm	52 mm	
T			■	■	■	■	Duct 1 separated
S			■	■	■	■	Ducts 1, 3 and 5 separated
R			■	■	■	■	Ducts 3 and 5 separated

Examples: Compressed air supply and pilot air supply, right-hand end plate

Internal pilot air supply, silencer/ducted exhaust air

Right-hand end plate: code V and V1

The adjacent diagram shows an example of the configuration and connection of the compressed air supply with internal pilot air supply. Port 14 on the right-hand end plate is tightly sealed. At exhaust port 3/5 the air is discharged via the silencer. Duct separations can optionally be used to create pressure zones.

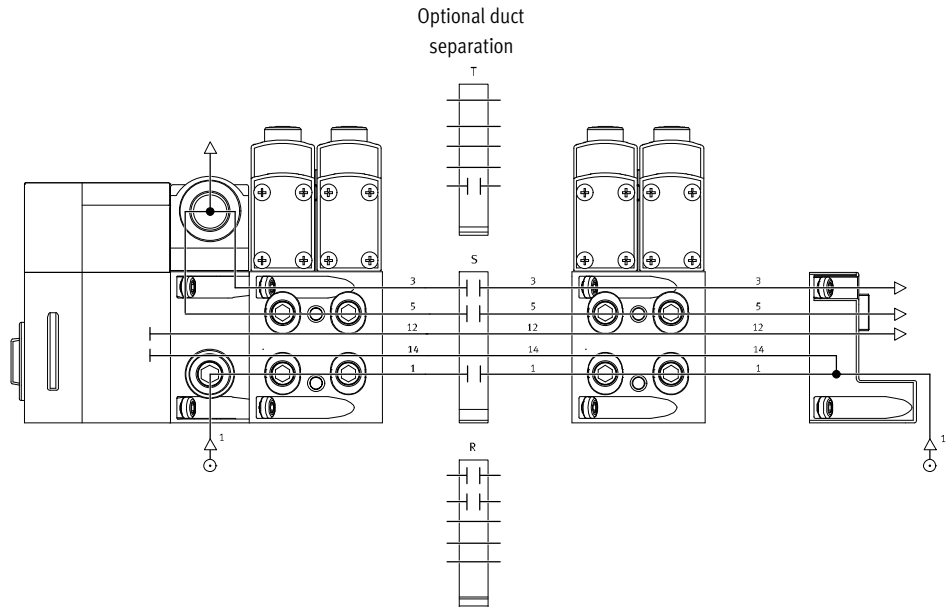

Valve terminals VTSA/VTSA-F, NPT

Key features – Pneumatic components – Compressed air supply and pressure zones, examples

Examples: Compressed air supply and pilot air supply, right-hand end plate

External pilot air supply, silencer/ducted exhaust air

Right-hand end plate: code X and X1

The adjacent diagram shows an example of the configuration and connection of the compressed air supply with external pilot air supply. Port 14 on the right-hand end plate is equipped with a fitting for this. The air is exhausted via the silencer at exhaust port 3/5. Duct separations can optionally be used to create pressure zones.

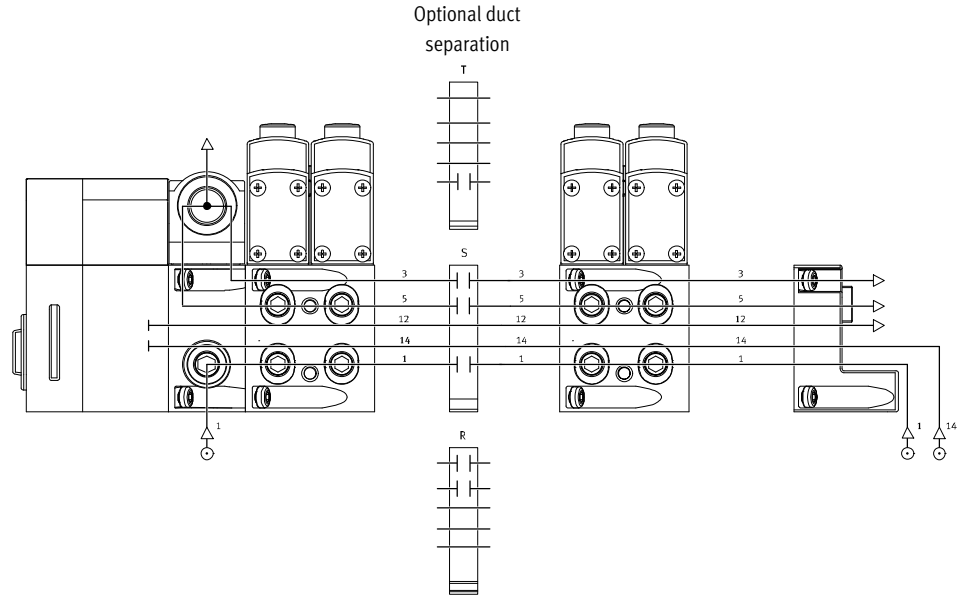

Examples: Compressed air supply and pilot air supply via end plate with pilot air selector

Internal pilot air supply, ducted exhaust air/silencer

Right-hand end plate: code U

The adjacent diagram shows an example of the configuration and connection of the compressed air supply with internal pilot air supply. Port 14 on the right-hand end plate is tightly sealed. At exhaust port 3/5 the air is ducted or discharged via the silencer. The selector switch on the pilot air selector is in position 4. Duct separations can optionally be used to create pressure zones.

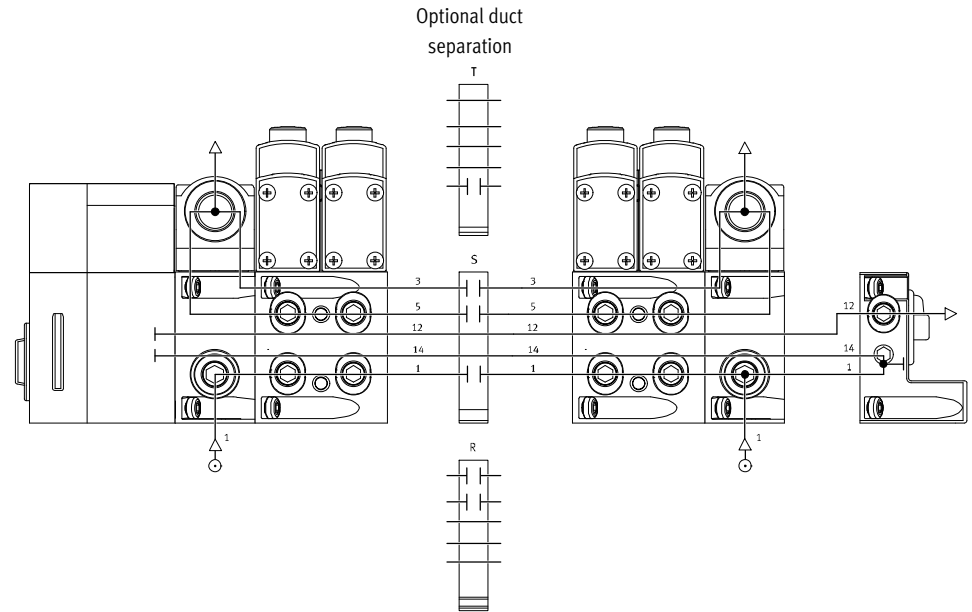

Valve terminals VTSA/VTSA-F, NPT

Key features – Pneumatic components – Compressed air supply and pressure zones, examples



Examples: Compressed air supply and pilot air supply via end plate with pilot air selector

External pilot air supply, ducted exhaust air/silencer

Right-hand end plate: code Z

The adjacent diagram shows an example of the configuration and connection of the compressed air supply with external pilot air supply. Port 14 on the right-hand end plate is equipped with a fitting for this. Port 12 is sealed with a blanking plug since it is internally connected with port 14. At exhaust port 3/5 the air is ducted or discharged via the silencer. The selector switch on the pilot air selector is in position 1. Duct separations can optionally be used to create pressure zones.

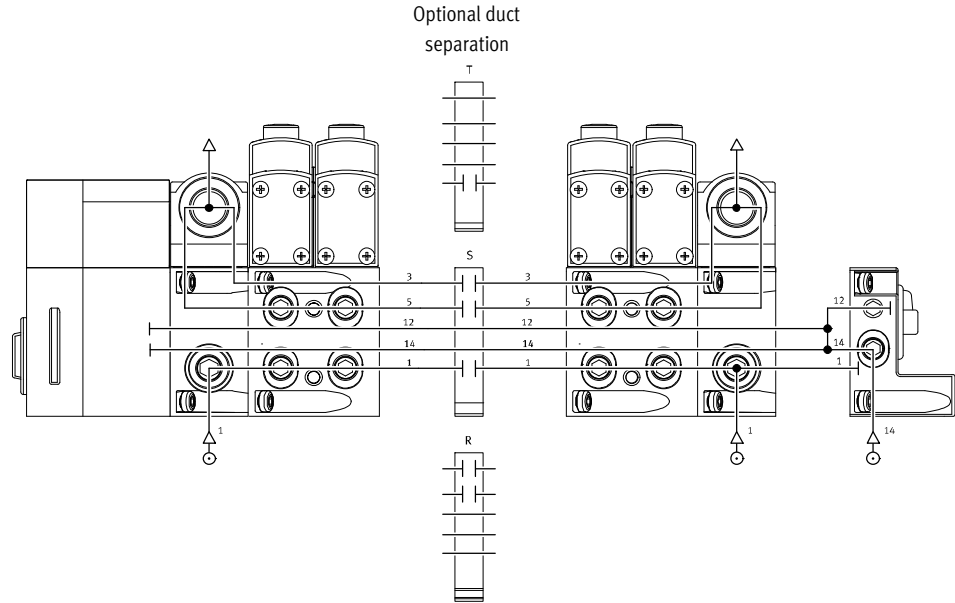

Examples: Creating pressure zones

VTSA/VTSA-F with CPX terminal

With the VTSA/VTSA-F, up to 16 pressure zones can be created (up to 32 pressure zones if only size 1, ISO 5599-2, is fitted). The diagram shows an example of the configuration and connection of three pressure zones using duct separations – with internal pilot air supply.

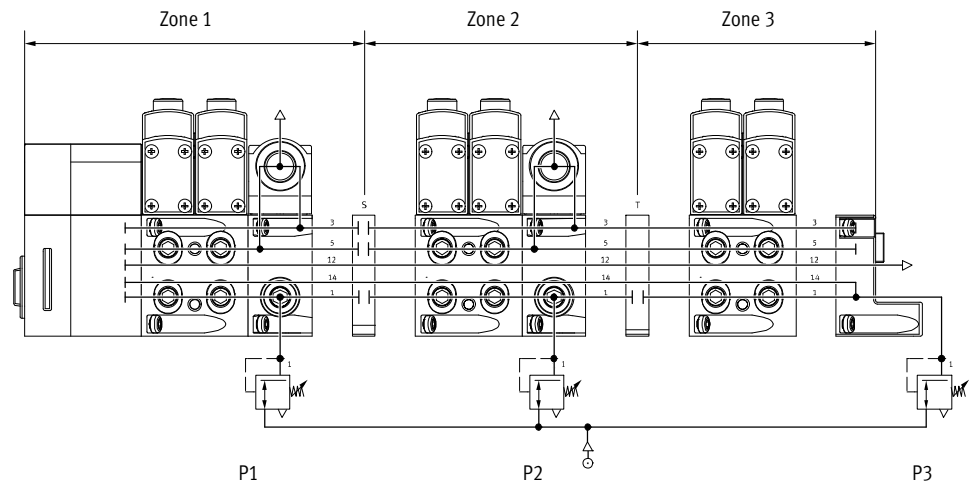

-  - Note
 Examples with pressure zones and soft-start valve are described separately in the chapter "Soft-start valve" → page 155.

Valve terminals VTSA/VTSA-F, NPT

Key features – Assembly

Valve terminal assembly

Sturdy valve terminal assembly thanks to:

- Through-holes for wall mounting
- Additional mounting brackets
- H-rail mounting (horizontal permitted mounting position)

 Note

Further information on installing the valve terminal, arranged by valve terminal configuration, can be found

on the catalogue DVD or online.

➔ Internet: 2D/3D CAD

➔ www.festo.com/sp

Wall mounting, general

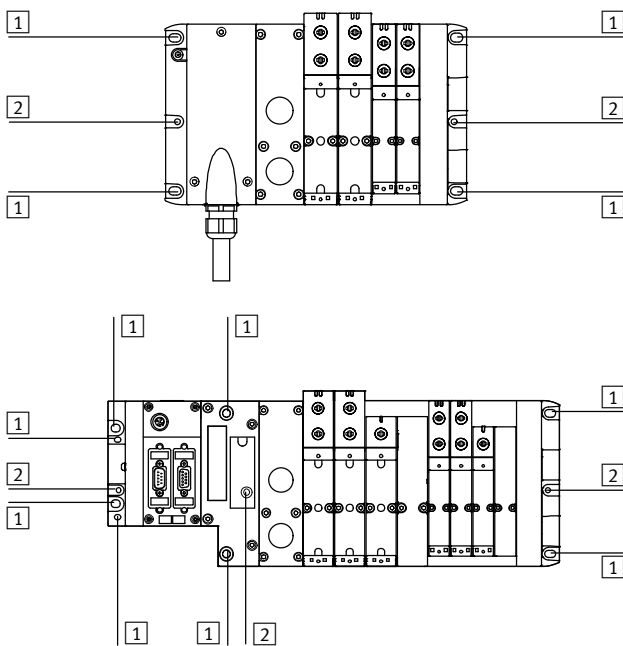

1 Hole for M6 screw

2 Hole for H-rail mounting

The valve terminal VTSA/VTSA-F is screwed onto the mounting surface using M6 screws. The mounting holes are located at the following points:

- Multi-pin plug (4 pieces):
2 each on the multi-pin connection block and the right-hand end plate
- Fieldbus, CPX (6 pieces):
2 each on the left-hand (CPX) and right-hand (VTSA/VTSA-F) end plate and the pneumatic interface.

Mounting brackets can be mounted on pneumatic supply plates and manifold sub-bases.

If using CPX components, see:

➔ Internet: cpx

 Note

Wall mounting of the VTSA/VTSA-F with more than five pneumatic modules.

Note the following information to avoid damage to the valve terminal:

- Additionally use mounting brackets of the type VAME-S6-W-M46
- Mount these at each fourth plate (manifold sub-base, supply plate or exhaust plate), counting from left to right, starting after the pneumatic interface.
- No mounting bracket is required next to the right-hand end plate.
- Make sure to use the pre-assembled mounting brackets when mounting factory pre-assembled valve terminals on a wall.

Wall mounting with CPX polymer interface

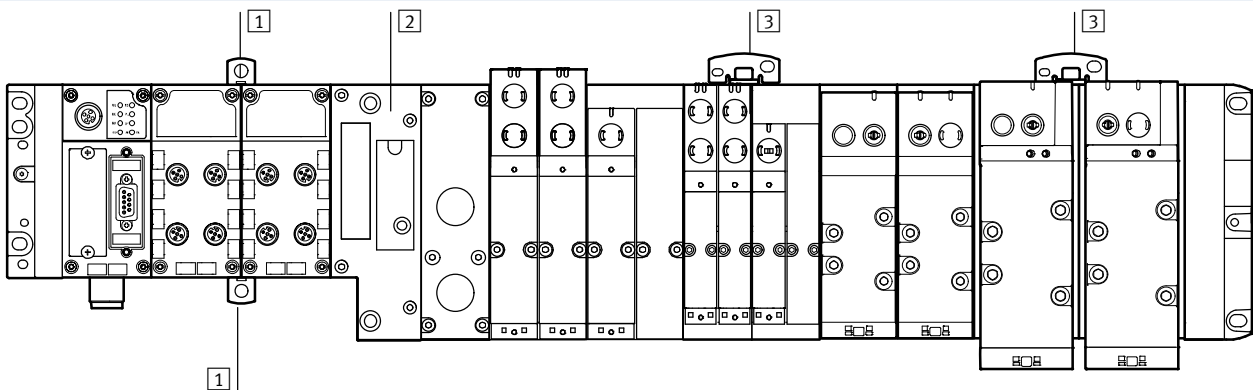

1 Additional wall mounting for polymer CPX terminal

2 Pneumatic interface

3 Additional wall mounting for VTSA/VTSA-F (with hole

for M5 and M6 screw)

In the case of CPX terminals in polymer design with 4 and more interlinking blocks, additional wall mountings of the type CPX-BG-RW must be used

approx. every 100 ... 150 mm. These mountings are clipped in at the top and bottom between the CPX modules.

In the case of the VTSA/VTSA-F, mounting brackets must be mounted on the wall as instructed above.

Brackets of the type VAME-S6-W-M46 must be used as an additional wall mounting.

Valve terminals VTSA/VTSA-F, NPT

Key features – Assembly

FESTO

Wall mounting with CPX metal interface

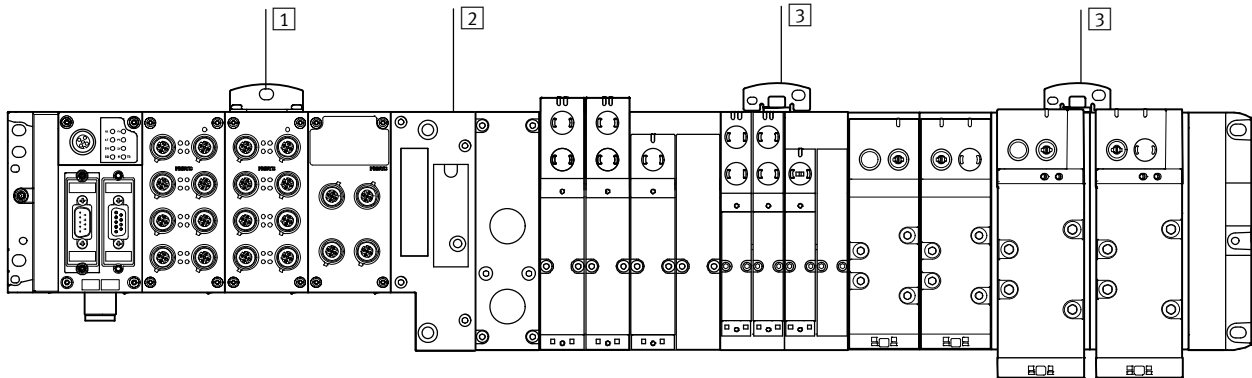

1 Additional wall mounting for metal CPX terminal

2 Pneumatic interface

3 Additional wall mounting for VTSA/VTSA-F (with hole

for M5 and M6 screw)

In the case of CPX terminals in metal design with 4 and more interlinking blocks, additional wall mountings of the type CPX-M-BG-RW must be used

approx. every 100 ... 150 mm. These wall mountings are screwed in at the top on the corresponding CPX module.

In the case of the VTSA/VTSA-F, mounting brackets must be mounted on the wall as instructed above. Brackets of the type VAME-S6-W-M46 must be used as an additional wall mounting.

Mounting on support system with CPX metal interface

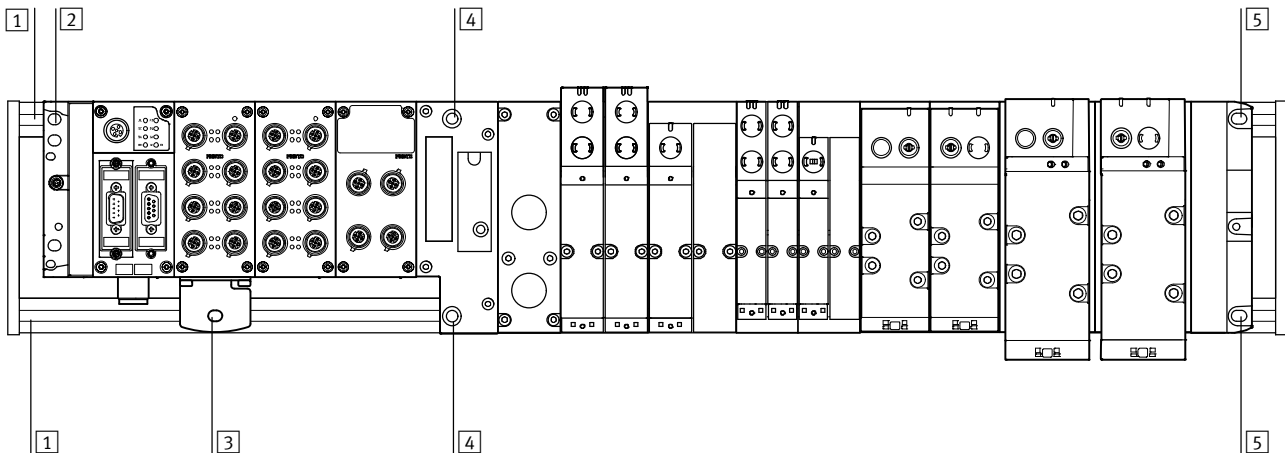

1 Support system (DIN mounting rail)

2 Upper mounting for CPX metal, left-hand end plate on DIN mounting rail

3 Lower mounting for CPX metal on DIN mounting rail with mounting bracket CPX-M-BG-VT-2X

4 Mounting for pneumatic interface on DIN mounting rail

5 Mounting for right-hand end plate on DIN mounting rail

If a terminal CPX (metal version) with VTSA pneumatics is mounted on DIN mounting rails, it may be necessary to have one or more mounting brackets on the CPX side to compensate for the length. Length compensation is made

possible by special mounting brackets CPX-M-BG-VT-2X. The mounting bracket connects the terminal CPX (metal version) to the DIN mounting rail.

Note

- Only CPX modules (metal version) with VTSA/VTSA-F modules of width 18 ... 52 mm may be used.
- The number of mounting brackets required depends on the number of CPX modules installed and whether any system feeds are

present. Further information about assembling the valve terminal can be found in the assembly instructions in the Festo Support portal.
→ Internet: 2D/3D CAD
→ www.festo.com/sp

Valve terminals VTSA/VTSA-F, NPT

Key features – Assembly

H-rail mounting

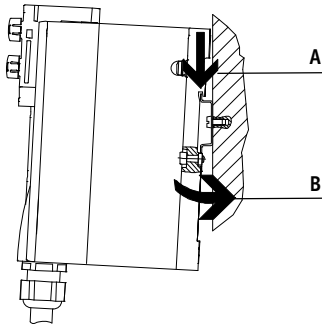

The valve terminal VTSA/VTSA-F is hooked onto the H-rail (see arrow A). It is then swivelled onto the H-rail and secured in place with the clamping component (see arrow B).

For H-rail mounting of the valve terminal you will need the following VTSA/VTSA-F mounting kit:

- CPX-CPA-BG-NRH

This enables the valve terminal to be mounted on an H-rail to EN 60715.

 Note

- Wall mounting is recommended if more than one vertical stacking element or a long valve terminal design is required.
- Vibration/shock loads are not permissible with H-rail mounting.
- Only horizontal mounting position are permissible with H-rail mounting.

Individual valve mounting

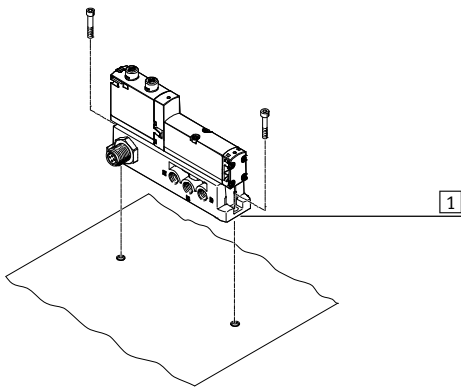

1 Vertical mounting holes

The individual sub-base for wall mounting is designed for integration into a system or machine. It is mounted vertically.

Valve terminals VTSA/VTSA-F, NPT

Key features – Display and operation

Display and operation

Each solenoid coil is allocated an LED which indicates its switching status.

- Indicator 12 shows the switching status of the pilot control for output 2
- Indicator 14 shows the switching status of the pilot control for output 4

Manual override (MO):

The manual override enables the valve to be switched when not electrically actuated or when de-energised.

The valve is switched by pushing the manual override. The set switching status can also be locked by turning the manual override.

Alternatives:

- The cover cap (code N) limits the function of the manual override, preventing it from being locked. The valve can then be actuated with non-detenting operation only.
- The cover cap (code V) can be used to secure the manual override against accidental actuation.



Note

Special valve variants with pre-assembled cover caps for the manual

override are available for valve terminal VTSA/VTSA-F.

Pneumatic connection and control elements

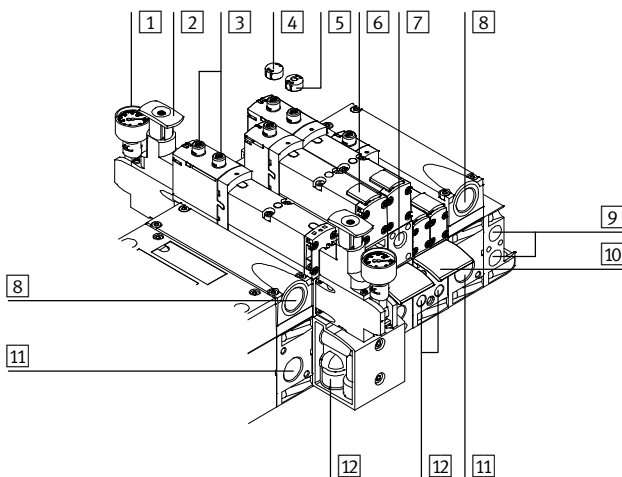

- 1 Pressure gauge (optional)
- 2 Adjusting knob for optional pressure regulator plate
- 3 Manual override (for each pilot solenoid coil, non-detenting or non-detenting/detenting)
- 4 Optional cover cap for manual override (prevents usage of manual override)
- 5 Optional cover cap for manual override with non-detenting function
- 6 Inscription label holder for valve
- 7 Adjusting screw of optional flow control plate
- 8 Exhaust ports "Valves" (3/5)
- 9 Pilot ports 12 and 14 for supplying external pilot air
- 10 Inscription label holder for sub-base
- 11 Supply port 1 (operating pressure)
- 12 Working ports 2 and 4, for each valve position



Note

A manually operated valve (manual override) cannot be reset electrically. Conversely, an electrically actuated valve cannot be reset using the mechanical manual override.

Electrical connection and display components

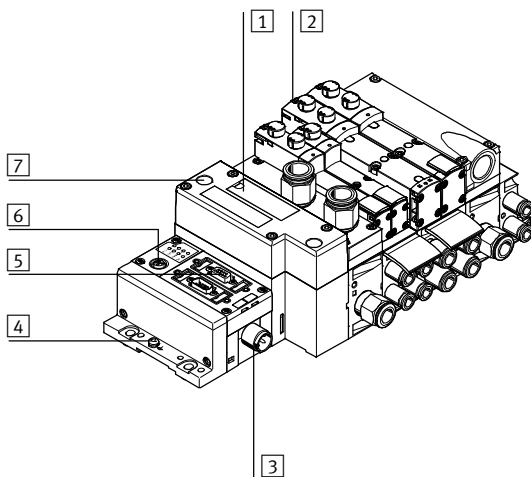

- 1 Inscription area and cover for H-rail mounting
- 2 Yellow LEDs: signal status display for pilot solenoid coils
- 3 Power supply connection
- 4 Earth terminal
- 5 Fieldbus connection (bus-specific)
- 6 Service interface for handheld unit, etc.
- 7 Red LED: common error display for valves

Valve terminals VTSA/VTSA-F, NPT

Key features – Display and operation

Manual override (MO) – Function

MO with automatic reset (non-detenting)

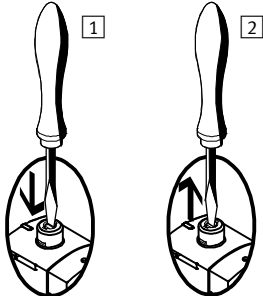

- 1 Press in the stem of the manual override using a pointed object or screwdriver.
The valve is in switching position.
- 2 Remove the pointed object or screwdriver.
The spring force pushes the stem of the manual override back.
The valve returns to its initial position (not with double solenoid valve code J).

MO with detent (covered)

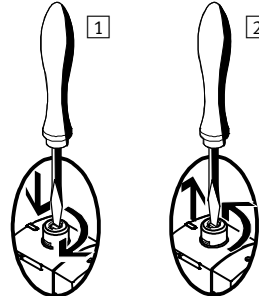

- 1 Press in the stem of the manual override using a pointed object or screwdriver until the valve switches and then turn the stem clockwise by 90° until the stop is reached.
The valve remains in switching position.
- 2 Turn the stem anti-clockwise by 90° until the stop is reached and then remove the pointed object or screwdriver. The spring force pushes the stem of the manual override back. The valve returns to its initial position (not with double solenoid valve code J and D).

Cover caps for manual override

Cover cap for MO, with automatic return (non-detenting)

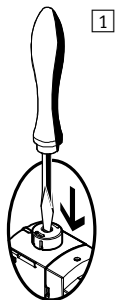

- 1 Limited function, non-detenting: push in stem of MO cap using a pointed object or screwdriver.
The valve is in switching position.

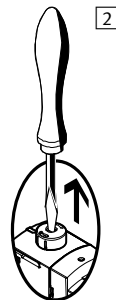

- 2 Remove the pointed object or screwdriver.
The spring force pushes the stem of the manual override back.
The valve returns to its initial position (not with double solenoid valve code J or D).

Cover cap for MO, covered

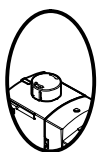

By covering the cover cap, the MO can be secured against accidental actuation.





Note
Cover caps for the manual override can be ordered separately as accessories.

There are also VSVA valve variants with pre-assembled cover caps.

Valve terminals VTSA/VTSA-F, NPT

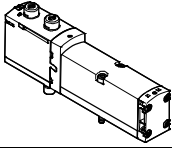
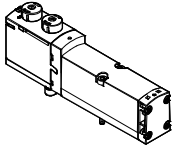
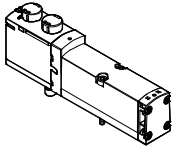
Key features – Display and operation

Overview of valve variants and MO caps				
Illustration	Terminal code	Description	Manual override	Valve code identification on rating plate sticker ¹⁾
VSVA solenoid valve without cover cap				
	R	Without cover cap on MO	Non-detenting, detenting	... -MZD- ...
VSVA solenoid valve with pre-assembled cover cap on MO				
	C	MO with non-detenting operation only due to coded cover cap	Non-detenting	... -MZH- ...
	D	MO covered by cover cap – operation of MO prevented	Covered	... -MZ- ...
Cover caps for MO				
	N	MO with non-detenting operation only due to coded cover cap	Non-detenting	Not identified in valve code
	V	MO covered by cover cap – operation of MO prevented	Covered	Not identified in valve code

1) As an example here, the part code for a 5/2-way valve, single solenoid, reset by mechanical spring is used (e.g.: VSVA-B-M52-MZTR-A2-1T1L)

Valve terminals VTSA/VTSA-F, NPT

Key features – Electrical components

Identification system

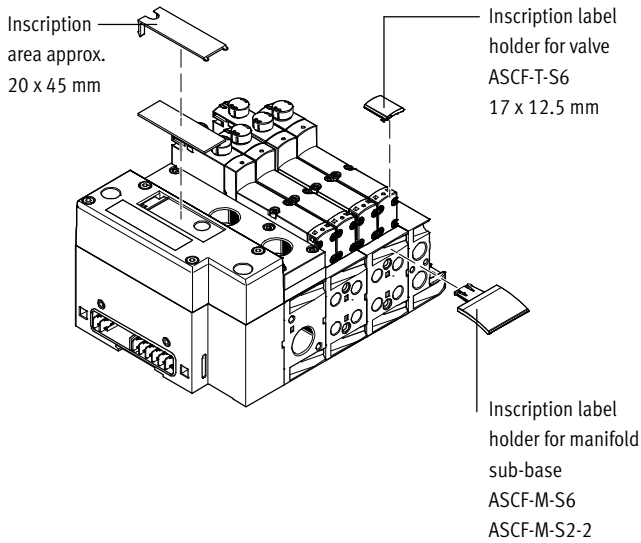

Inscription label holders can be applied to the valves and manifold sub-bases to identify them. These inscription label holders can be ordered by entering the code B or T in the order code for accessories.

Scope of delivery: inscription label holder including inscription label. The following inscription labels can be used as spares:

- Inscription label holder for valve type ASCF-T-S6: Part No. 540888

- Inscription label holder for manifold sub-base type ASCF-M-S6: Part No. 540889
 - Inscription label holder for manifold sub-base (for valve width 52 mm) Type ASCF-M-S2-2 Part No. 562577
- Large inscription labels can be attached to the pneumatic interface as an alternative or in addition to the smaller labels.

Protective circuit

Each VSVA solenoid coil is provided with a spark arresting protective circuit and protected against polarity reversal.

The 24 V DC version of width 52 mm additionally features integrated holding current reduction.

24 V DC version (width 18 to 42 mm)

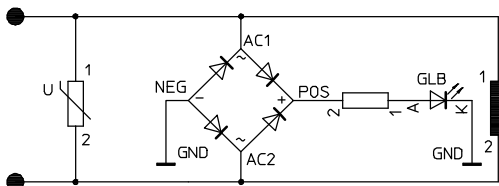

110 V AC version (width 18 to 52 mm)

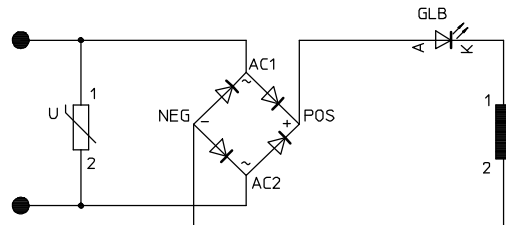

24 V DC version (width 52 mm)

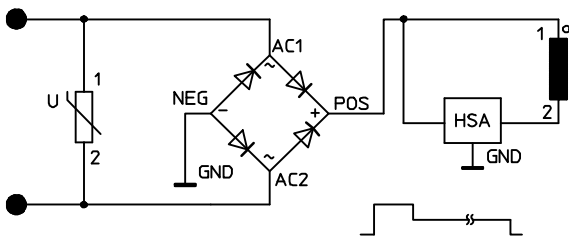

Individual valve

Valves can also be used on individual sub-bases if actuators are further away from the valve terminal.

- Electrical connection M12, 4-pin 24 V DC
- 4-pin clamped terminal connection for configuration by the user 24 V DC or 110 V AC
- Cable (open end) for configuration by the user 24 V DC or 110 V AC

Individual electrical connection

A maximum of 20 solenoid coils can be actuated. 2 solenoid coils per valve can be addressed.

Individual electrical connection:

- M12
- 6-way or 10-way
- 5-pin
- 24 V DC

Valve terminals VTSA/VTSA-F, NPT

Key features – Electrical components

Electrical multi-pin plug connection

The following multi-pin plug connection variants are offered for the valve terminal VTSA/VTSA-F:

- Sub-D multi-pin plug connection (37-pin for 24 V DC): this valve terminal can be equipped with 1 ... 16 valve positions (with double solenoid valves) or with 1 ... 32 valve positions (with single solenoid valves). A maximum of 32 solenoid coils can be actuated.
- Terminal box (terminal strip for 24 V DC or 110 V AC): this valve terminal can be equipped with 1 ... 16 valve positions (with double solenoid valves), or with 1 ... 32 valve positions (with single solenoid valves). A maximum of 32 solenoid coils can be actuated.
- Multi-pin node (round plug connector): electrical multi-pin plug connection with round plug connector, 19-pin to CNOMO E03.62.530.N, connecting thread M23 for 24 V DC. The valve terminal can be fitted with max. 16 solenoid coils.

The valves are switched by means of positive or negative logic (PNP or NPN). Mixed operation is not permitted.

Each pin on the multi-pin plug (Sub-D) or terminal box (terminal strip) can actuate exactly one solenoid coil. When using the maximum configurable number of 32 valve positions, 32 valves can be addressed, each with a single solenoid coil. With 16 or fewer valve positions, 2 solenoid coils per valve can be addressed.

The valves are switched by means of positive or negative logic (PNP or NPN). Mixed operation is not permitted.



Note

Use the following 37-pin connecting cables from Festo to connect the valve terminal VTSA/VTSA-F with Sub-D multi-pin plug connection:

- NEBV-S1W37-...-LE10 for max. 8 solenoid coils
- NEBV-S1W37-...-LE26 for max. 22 solenoid coils
- NEBV-S1W37-...-LE37 for max. 32 solenoid coils
- NECV-S1W37 plug connector for self-assembly

AS-Interface connection

Valve terminals VTSA/VTSA-F with AS-Interface connection can be extended with up to 8 valves with max. 8 solenoid coils.

The valve terminal with AS-Interface connection is based on the same

electrical interlinking module as the valve terminal with multi-pin plug connection.

This means it is possible to convert a valve terminal with multi-pin plug connection using an AS-Interface

module.

The technical specifications of the AS-Interface system must be observed in this case.



Note

AS-i module VAEM-S6-S-FAS-4-4E. Always operate the AS-i module with additional power supply if 4 solenoid coils (width 52 mm) are simultaneously supplied with current. More information can be found at:
 → Internet: as-interface

Fieldbus connection/control block

All functions and features of the electrical peripherals CPX are permitted in connection with the CPX interface.

This means:

- The valves and electrical outputs are supplied via the operating voltage connection CPX
- The valves are supplied and switched off independently via a separate port on the CPX



Note

More information can be found at:
 → Internet: cpx

Valve terminals VTSA/VTSA-F, NPT

Key features – Electrical components

Rules for addressing

Address allocation

Address allocation does not depend on whether single or double solenoid valves are fitted.

Addresses are allocated in ascending order without gaps, from left to right.

Single solenoid valve

A valve position for actuating one solenoid coil (VABV...T1) occupies one address.

Double solenoid valve

A valve position for actuating two solenoid coils (VABV...T2) occupies two addresses. The following assignment applies in this case:

- Coil 14: lower-value address
- Coil 12: higher-value address

Pin allocation – Multi-pin plug, Sub-D socket, 24 V DC; electrical connection code MP1

	Pin ²⁾	Address/coil	Wire colour ¹⁾		Pin ²⁾	Address/coil	Wire colour ¹⁾
	1	0	WH		17	16	WH PK
	2	1	BN		18	17	PK BN
	3	2	GN		19	18	WH BU
	4	3	YE		20	19	BN BU
	5	4	GY		21	20	WH RD
	6	5	PK		22	21	BN RD
	7	6	BU		23	22	GY GN
	8	7	RD		24	23	YE GY
	9	8	GY PK		25	24	PK GN
	10	9	RD BU		26	25	YE PK
	11	10	WH GN		27	26	GN BU
	12	11	BN GN		28	27	YE BU
	13	12	WH YE		29	28	GN RD
	14	13	YE BN		30	29	YE RD
	15	14	WH GY		31	30	GN BK
	16	15	GY BN		32	31	GY BU
<p> Note</p> <p>The drawing shows a plan view of the Sub-D plug socket on the connecting cable NEBV-S1W37-....</p>	Conductor						
	33	0 V ³⁾	YE BK		35	0 V ³⁾	BN BK
	34	0 V ³⁾	WH BK		36	0 V ³⁾	BK
	Earthing						
37	FE	VT		-	-	-	

1) To IEC 757

2) Pin 9 ... 35: not assigned with connecting cable NEBV-S1-W37-...-LE10

Pin 23 ... 33: not assigned with connecting cable NEBV-S1-W37-...-LE26

Pin 24 ... 33: not assigned with connecting cable NEBV-S1-W37-...-LE27

3) 0 V for positive switching control signals; connect 24 V for negative switching control signals; mixed operation is not permitted.

Valve terminals VTSA/VTSA-F, NPT

Key features – Electrical components



Dimensions

Download CAD data → www.festo.com

Connecting cable NEBV-S1W37-...

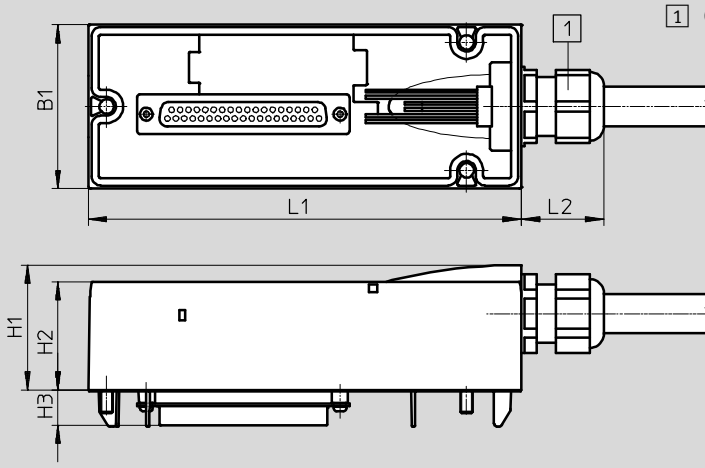

1 Cable connector M20x1.5

The wire colours refer to the following pre-assembled connecting cables from Festo:

- NEBV-S1W37-...-LE10 for valve terminal with max. 8 solenoid coils
- NEBV-S1W37-...-LE26 for valve terminal with max. 22 solenoid coils
- NEBV-S1W37-...-LE37 for valve terminal with max. 32 solenoid coils

Type	B1	H1	H2	H3	L1	L2
NEBV-S1W37	54	41	36	11.6	142	27

Pin allocation – Multi-pin plug, Sub-D plug, 24 V DC, connecting cable; electrical connection code MP1

	Casing	Length [m]	Cable composition [mm ²]	Cable diameter [mm]	Part No.	Type
	Polyurethane	2.5	10 x 0.34	7.7	539240	NEBV-S1W37-E2.5-LE10
		5			539241	NEBV-S1W37-E5-LE10
		10			539242	NEBV-S1W37-E10-LE10
		2.5	26 x 0.34	11.5	539243	NEBV-S1W37-E2.5-LE26
		5			539244	NEBV-S1W37-E5-LE26
		10			539245	NEBV-S1W37-E10-LE26
		2.5	37 x 0.34	13	539246	NEBV-S1W37-K2.5-LE37
		5			539247	NEBV-S1W37-K5-LE37
		10			539248	NEBV-S1W37-K10-LE37
	Polyvinyl chloride Cable properties (standard)	2.5	10 x 0.34	7.7	543271	NEBV-S1W37-KM-2.5-LE10
		5			543272	NEBV-S1W37-KM-5-LE10
		10			543273	NEBV-S1W37-KM-10-LE10
		2.5	27 x 0.34	11.5	543274	NEBV-S1W37-KM-2.5-LE27
		5			543275	NEBV-S1W37-KM-5-LE27
		10			543276	NEBV-S1W37-KM-10-LE27
2.5		37 x 0.34	13	543277	NEBV-S1W37-KM-2.5-LE37	
5				543278	NEBV-S1W37-KM-5-LE37	
10				543279	NEBV-S1W37-KM-10-LE37	

Valve terminals VTSA/VTSA-F, NPT

Key features – Electrical components



Pin allocation – Multi-pin, terminal strip (Cage Clamp®), 24 V DC and 110 V AC; electrical connection code T (based on standard: EN 61984)					
	Terminal	Coil/address		Terminal	Coil/address
<p>Each solenoid coil must be assigned to a specific terminal on the terminal strip in order for the valves to be actuated.</p>	1	0		17	16
	2	1		18	17
	3	2		19	18
	4	3		20	19
	5	4		21	20
	6	5		22	21
	7	6		23	22
	8	7		24	23
	9	8		25	24
	10	9		26	25
	11	10		27	26
	12	11		28	27
	13	12		29	28
	14	13		30	29
	15	14		31	30
	16	15		32	31
<p> Note</p> <p>The drawing shows a plan view of the multi-pin terminal strip (Cage Clamp®).</p>	Conductor				
	33	0 V		35	0 V
	34	0 V		36	0 V

Pin allocation – Multi-pin, round plug connector, 24 V DC; electrical connection code MP4					
	Address	Pin ¹⁾		Address	Pin ¹⁾
	0	15		8	17
	1	7		9	9
	2	5		10	2
	3	4		11	13
	4	16		12	11
	5	8		13	10
	6	3		14	1
	7	14		15	18

Pin allocation – Multi-pin plug, round plug connector, 24 V DC; electrical connection – CNOMO assignment					
	Pin	Valve position/ solenoid coil		Pin	Valve position/ solenoid coil
	1	8/14		10	7/12
	2	6/14		11	7/14
	3	4/14		12	FE
	4	2/12		13	6/12
	5	2/14		14	4/12
	6	0 V ¹⁾		15	1/14
	7	1/12		16	3/14
	8	3/12		17	5/14
	9	5/12		18	8/12
			19	Unused	

1) Pin 6: 0 V for positive switching control signals; connect 24 V for negative switching control signals; mixed operation is not permitted.
 Pin 12: earth
 Pin 19: unused

Valve terminals VTSA/VTSA-F, NPT

Key features – Electrical components

Electrical connection, individual valve 24 V DC or 110 V AC up to width 52 mm

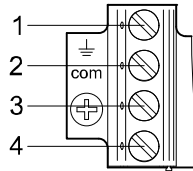
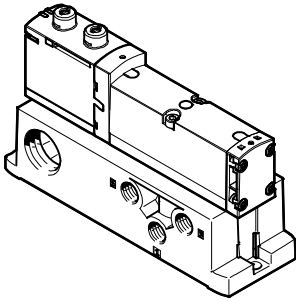

Pin allocation for assembly by the user

With positive logic:

Pin1 – Unused (with 110 V AC connection for earthing)

Pin2 – U_B for coil 12

Pin3 – 0 V for coil 12 and 14

Pin4 – U_B for coil 14

With negative logic:

Pin1 – Unused

Pin2 – 0 V for coil 12

Pin3 – U_B for coil 12 and 14

Pin4 – 0 V for coil 14

Individual electrical connection, 6-way or 10-way, 24 V DC, code MP2/MP3 for valve terminal up to width 52 mm

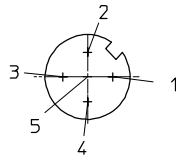
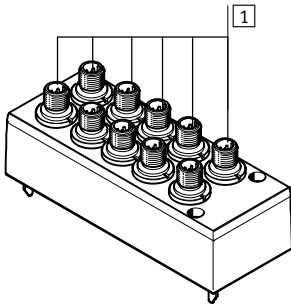

1 Connector plug M12x1, 5-pin

Pin allocation M12

With positive logic:

Pin1 – Unused

Pin2 – U_B for coil 12

Pin3 – 0 V for coil 12 and 14

Pin4 – U_B for coil 14

Pin5 – Functional earth

Pin allocation M12

With negative logic:

Pin1 – Unused

Pin2 – 0 V for coil 12

Pin3 – U_B for coil 12 and 14

Pin4 – 0 V for coil 14

Pin5 – Functional earth

 Note

Mixed operation of positive switching (PNP) and negative switching (NPN) control signals is not permitted.

Valve terminals VTSA/VTSA-F, NPT

Instructions for use

FESTO

System equipment

Operate system equipment with unlubricated compressed air if possible. Festo valves and cylinders are designed so that, if used as intended, they will not require additional lubrication and will still achieve a long service life.

The quality of compressed air downstream of the compressor must correspond to that of unlubricated compressed air. If possible, do not operate all of your system equipment with lubricated compressed air. The lubricators should, where possible, always be installed directly upstream of the actuator used.

Incorrect additional oil and too high an oil content in the compressed air reduce the service life of the valve terminal.

Use Festo special oil OFSW-32 or the alternatives listed in the Festo catalogue (as specified in DIN 51524 HLP32; basic oil viscosity 32 CST at 40 °C).

Bio-oils

When using bio-oils (oils which are based on synthetic or native esters, e.g. rapeseed oil methyl ester), the maximum residual oil content of 0.1 mg/m³ must not be exceeded (see ISO 8573-1:2010 Class 2).

Mineral oils

When using mineral oils (e.g. HLP oils to DIN 51524, parts 1 to 3) or similar oils based on poly-alpha-olefins (PAO), the maximum residual oil content of 5 mg/m³ must not be exceeded (see ISO 8573-1:2010 Class 4). A higher residual oil content irrespective of the compressor oil cannot be permitted, as the basic lubricant would be flushed out over time.

Valve terminals VTSA/VTSA-F, NPT

Technical data – Valve terminal

FESTO

-  Valve width to ISO 15407-2
 - 18 mm
 - 26 mm
- to ISO 5599-2
 - 42 mm (ISO 1)
 - 52 mm (ISO 2)

-  Voltage
 - 24 V DC
 - 110 V AC

-  Flow rate¹⁾
 - Width 18 mm: up to 550 (700) l/min
 - Width 26 mm: up to 1100 (1350) l/min
 - Width 42 mm: up to 1300 (1860) l/min
 - Width 52 mm: up to 2900 l/min

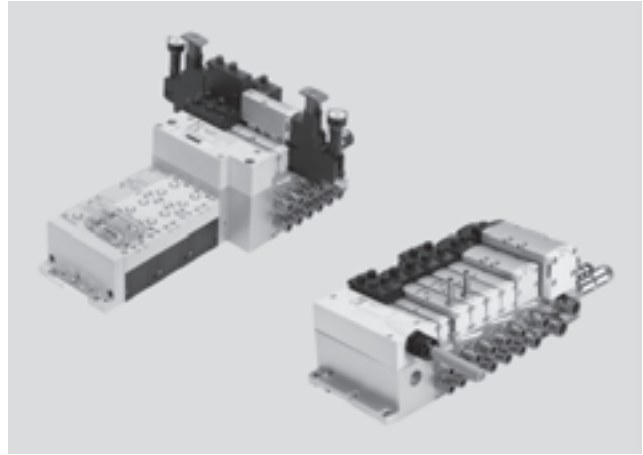

1) Flow rates in brackets apply to VTSA-F

General technical data		
Terminal type VTSA/VTSA-F	VTSA is the standard type, VTSA-F is the type with optimised flow rate	
Valve sizes	Widths 18 mm, 26 mm, 42 mm, 52 mm, extendable with adapter to 65 mm	
Actuation type	Electrical	
Electrical actuation	With multi-pin plug: multi-pin	
	With fieldbus: integrated controller, fieldbus, Industrial Ethernet	
Type of control	Piloted	
Exhaust function, with flow control	Via flow control plate	
Type of mounting	Wall mounting	
	On H-rail to EN 60715	
Mounting position	Any	
Manual override	Detenting, non-detenting, covered	
Suitable for vacuum	Yes	
Valve terminal design	Modular, valve sizes can be mixed	
Max. no. of valve positions	32 ¹⁾	
Pneumatic connections – NPT thread		
Pneumatic port	Via manifold sub-base	
Supply port	1	Dependent on the end plate or air supply plate used (and adapter plate when using ISO size 3 valves)
Exhaust port	3/5	Dependent on the end plate or air supply plate used (and adapter plate when using ISO size 3 valves)
Working ports	2/4	Depending on the connection type selected
External pilot air supply port	14	Dependent on the end plate used (and adapter plate when using ISO size 3 valves)
Pilot exhaust air port	12	Dependent on the end plate used (and adapter plate when using ISO size 3 valves)

1) Dependent on the electrical interface and the manifold sub-bases used

-  Note: This product conforms to ISO 1179-1 and to ISO 228-1

Valve terminals VTSA/VTSA-F, NPT

Technical data – Valve terminal

Standard nominal flow rate of valve/valve terminal [l/min], 24 V DC, 110 V AC							
Valve function (with valve code)	Terminal code	Width 18 mm			Width 26 mm		
		Valve	Valve on valve terminal VTSA	Valve on valve terminal VTSA-F	Valve	Valve on valve terminal VTSA	Valve on valve terminal VTSA-F
5/2-way, double solenoid (B52)	J	750	550	700	1400	1100	1350
5/2-way, double solenoid with dominant signal (D52)	D	750	550	700	1400	1100	1350
5/2-way, single solenoid, pneum. spring (M52-A)	M	750	550	700	1400	1100	1350
5/2-way single solenoid, mech. spring (M52-M)	O	750	550	700	1400	1100	1350
5/3-way, closed (P53C)	G	700	450	650	1400 ¹⁾ 700 ²⁾	1000 ¹⁾ 700 ²⁾	1350 ¹⁾ 700 ²⁾
5/3-way, exhausted (P53E)	E	700 ¹⁾ 330 ²⁾	450 ¹⁾ 330 ²⁾	480 ¹⁾ 330 ²⁾	1400 ¹⁾ 700 ²⁾	1000 ¹⁾ 700 ²⁾	1350 ¹⁾ 700 ²⁾
5/3-way, pressurised (P53U)	B	700 ¹⁾ 330 ²⁾	450 ¹⁾ 330 ²⁾	480 ¹⁾ 330 ²⁾	1400 ¹⁾ 700 ²⁾	1000 ¹⁾ 700 ²⁾	1350 ¹⁾ 700 ²⁾
5/3-way vented, switching position 14 detenting, switching position 14 detenting (P53ED) ³⁾	SA	–	–	–	1400 ¹⁾ 700 ²⁾	1000 ¹⁾ 700 ²⁾	1350 ¹⁾ 700 ²⁾
5/3-way, exhausted, switching position 12 detenting (P53EP) ³⁾	SE	–	–	–	1400 ¹⁾ 700 ²⁾	1000 ¹⁾ 700 ²⁾	1350 ¹⁾ 700 ²⁾
5/3-way, port 2 pressurised, 4 exhausted, switching position 14 detenting (P53AD) ³⁾	SB	–	–	–	700 ¹⁾ 700 ²⁾	700 ¹⁾ 700 ²⁾	700 ¹⁾ 700 ²⁾
5/3-way, port 4 pressurised, 2 exhausted, switching position 14 detenting (P53BD) ³⁾	SD	–	370	430	–	–	–
2x3/2-way, single solenoid, closed (T32C)	K	600	400	550	1250	900	1150
2x3/2-way, single solenoid, open (T32U)	N	600	400	550	1250	900	1150
2x3/2-way, single solenoid, open/closed (T32H)	H	600	400	550	1250	900	1150
2x3/2-way, single solenoid, closed (T32N)	Q	600	400	550	1250	900	1150
2x3/2-way, single solenoid, open (T32F)	P	600	400	550	1250	900	1150
2x3/2-way, single solenoid, open/closed (T32W)	R	600	400	550	1250	900	1150
2x2/2-way, single solenoid, closed (T22C)	VC	700	500	650	1350	1000	1300
2x2/2-way, single solenoid, closed (T22CV)	VV	700	500	650	1350	1000	1300

1) Switching position

2) Mid-position

3) The valve functions P53ED, P53EP, P53AD and P53BD are only available in the 24 V DC version. Values only apply to 24 V DC.

Valve terminals VTSA/VTSA-F, NPT

Technical data – Valve terminal

Standard nominal flow rate of valve/valve terminal [l/min], 24 V DC, 110 V AC							
Valve function (with valve code)	Terminal code	Width 42 mm			Width 52 mm		
		Valve	Valve on valve terminal VTSA	Valve on valve terminal VTSA-F	Valve	Valve on valve terminal VTSA	Valve on valve terminal VTSA-F
5/2-way, double solenoid (B52)	J	2000	1300	1860	4000	2900	2900
5/2-way, double solenoid with dominant signal (D52)	D	2000	1300	1860	4000	2900	2900
5/2-way, single solenoid, pneum. spring (M52-A)	M	2000	1300	1860	4000	2900	2900
5/2-way single solenoid, mech. spring (M52-M)	O	2000	1300	1860	4000	2900	2900
5/3-way, closed (P53C)	G	1900 ¹⁾ 950 ²⁾	1200 ¹⁾ 800 ²⁾	1690 ¹⁾ 830 ²⁾	3600 ¹⁾ 1700 ²⁾	2800 ¹⁾ 1700 ²⁾	2800 ¹⁾ 1700 ²⁾
5/3-way, exhausted (P53E)	E	1900 ¹⁾ 950 ²⁾	1200 ¹⁾ 800 ²⁾	1690 ¹⁾ 830 ²⁾	3600 ¹⁾ 1700 ²⁾	2800 ¹⁾ 1700 ²⁾	2800 ¹⁾ 1700 ²⁾
5/3-way, pressurised (P53U)	B	1900 ¹⁾ 950 ²⁾	1200 ¹⁾ 800 ²⁾	1690 ¹⁾ 830 ²⁾	3600 ¹⁾ 1700 ²⁾	2800 ¹⁾ 1700 ²⁾	2800 ¹⁾ 1700 ²⁾
5/3-way, pressurised 1 to 2, 4 to 5 closed (P53F) ³⁾	VG	1700 ¹⁾ 700 ²⁾	1400 ¹⁾ 800 ²⁾	1700 ¹⁾ 700 ²⁾	3000 ¹⁾ 900 ²⁾	2300 ¹⁾ 900 ²⁾	2300 ¹⁾ 900 ²⁾
2x3/2-way, single solenoid, closed (T32C)	K	1600	1200	1300	3000	2400	2400
2x3/2-way, single solenoid, open (T32U)	N	1600	1200	1300	3000	2400	2400
2x3/2-way, single solenoid, open/closed (T32H)	H	1600	1200	1300	3000	2400	2400
2x3/2-way, single solenoid, closed (T32N)	Q	1600	1200	1300	3000	2400	2400
2x3/2-way, single solenoid, open (T32F)	P	1600	1200	1300	3000	2400	2400
2x3/2-way, single solenoid, open/closed (T32W)	R	1600	1200	1300	3000	2400	2400
2x2/2-way, single solenoid, closed (T22C)	VC	1600	1400	1500	4000	2800	2800
2x2/2-way, single solenoid, closed (T22CV)	VV	1600	1400	1500	–	–	–

1) Switching position

2) Mid-position

3) The valve function P53F is only available in the 24 V DC version. Values only apply to 24 V DC.

Valve terminals VTSA/VTSA-F, NPT

Technical data – Valve terminal

Flow rate q_n as a function of output pressure p_2 with pressure regulator plates (P regulator plate) for port 1

6 bar

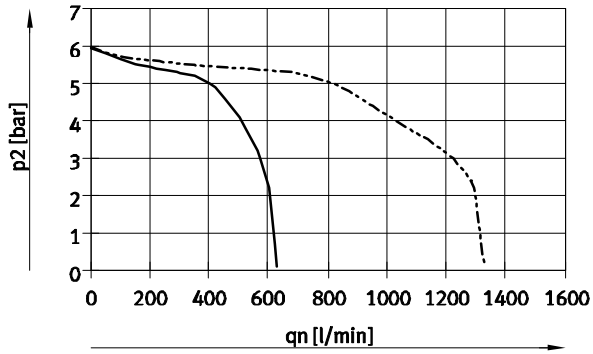

— Width 18 mm
- - - Width 26 mm

10 bar

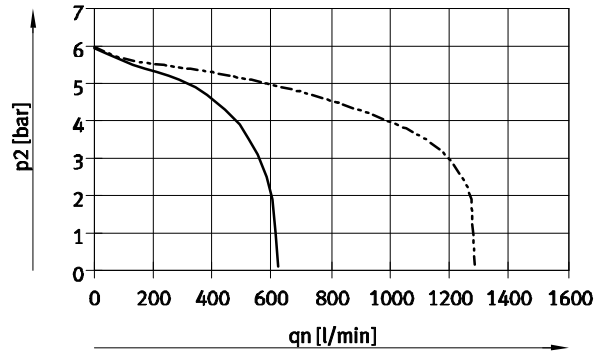

— Width 18 mm
- - - Width 26 mm

Supply pressure 10 bar, set control pressure 6 bar

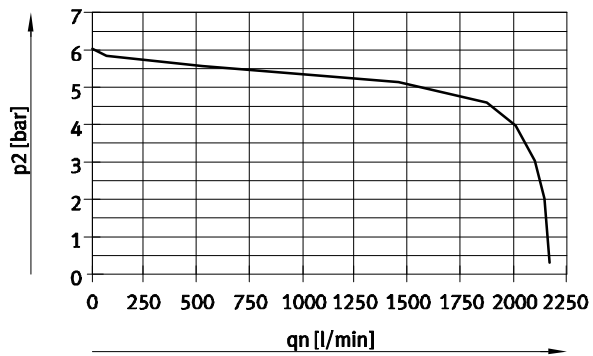

Width 42 mm (ISO 1)

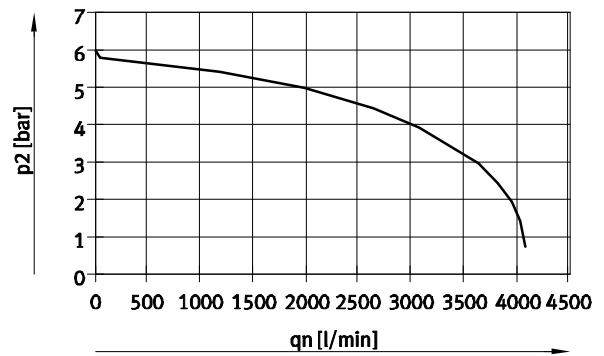

Width 52 mm (ISO 2)

Valve terminals VTSA/VTSA-F, NPT

Technical data – Valve terminal

Flow rate q_n as a function of output pressure p_2 with pressure regulator plates (AB regulator plates) for port 2, 4 or ports 4/2

6 bar

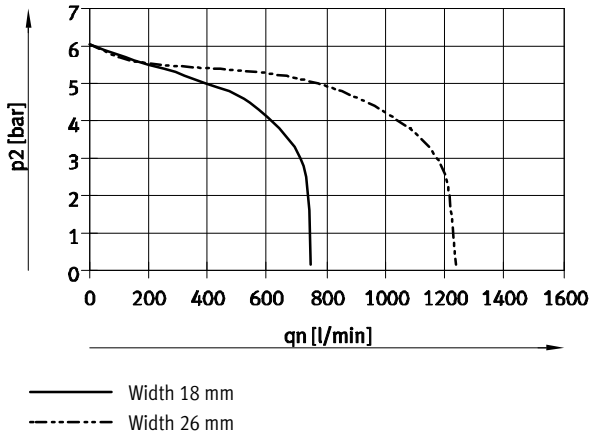

10 bar

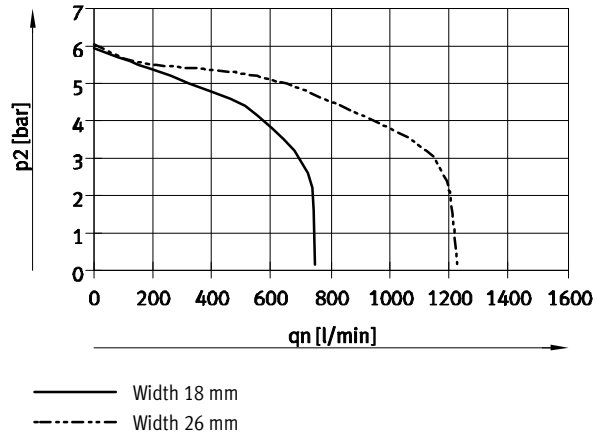

Supply pressure 10 bar, set regulator pressure 6 bar

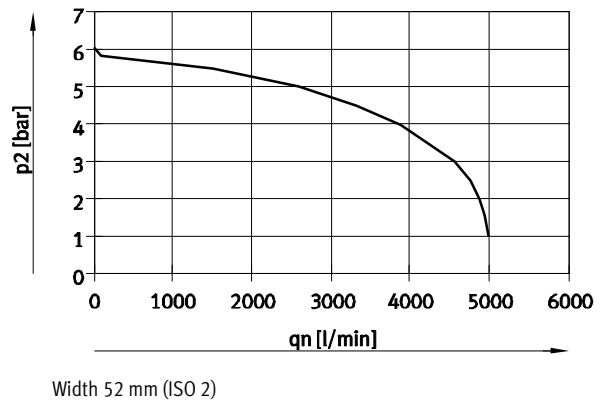
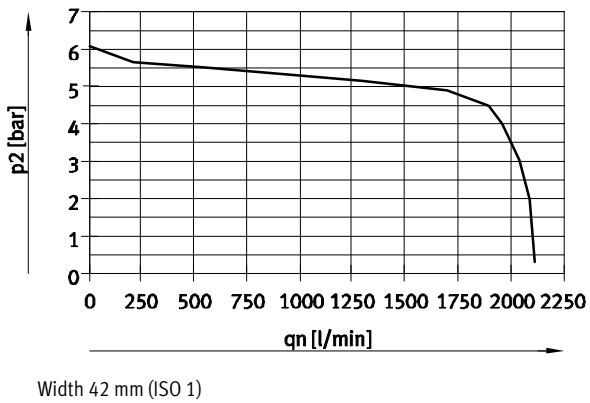

Valve terminals VTSA/VTSA-F, NPT

Technical data – Valve terminal

Flow rate q_n as a function of output pressure p_2 with pressure regulator plates (AB regulator plates, rev.) for ports 4/2, reversible

6 bar

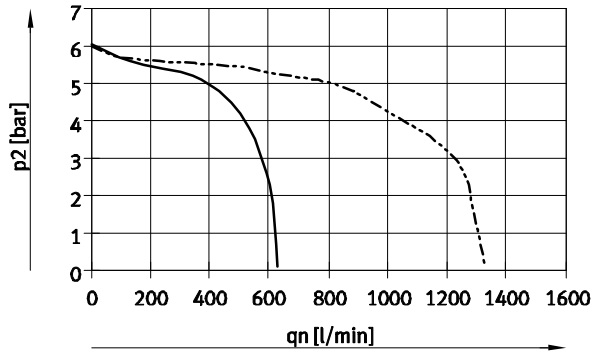

— Width 18 mm
- - - Width 26 mm

10 bar

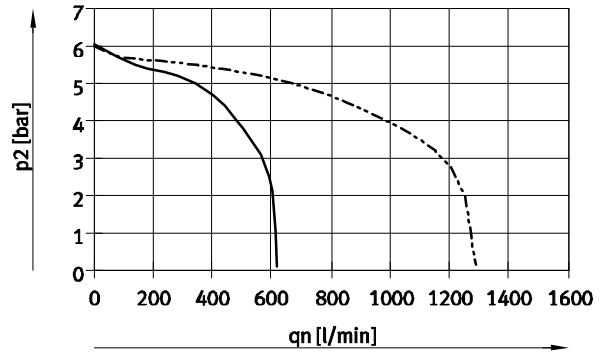

— Width 18 mm
- - - Width 26 mm

Supply pressure 10 bar, set regulator pressure 6 bar

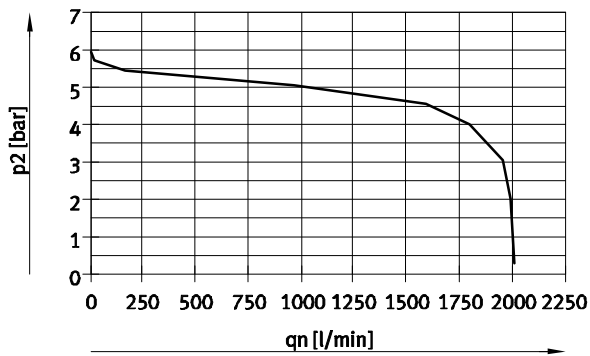

Width 42 mm (ISO 1)

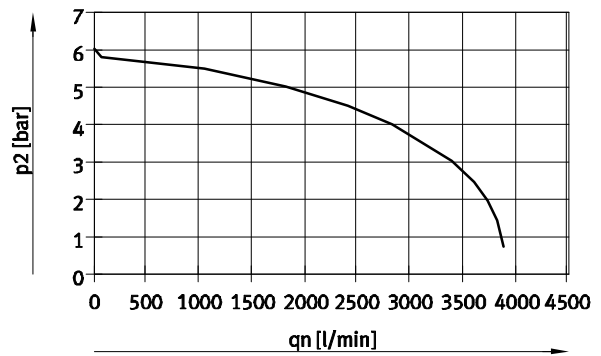

Width 52 mm (ISO 2)

Valve terminals VTSA/VTSA-F, NPT

Technical data – Valve terminal

Flow rate q_N as a function of flow control

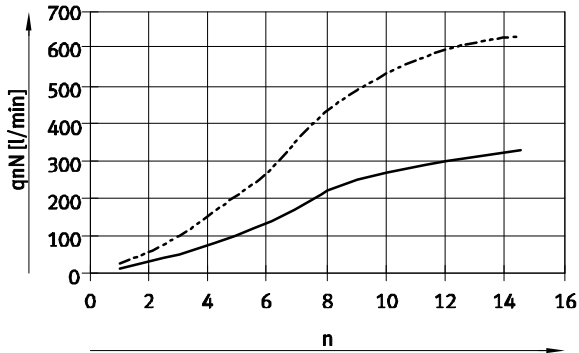

— Width 18 mm
 - - - Width 26 mm

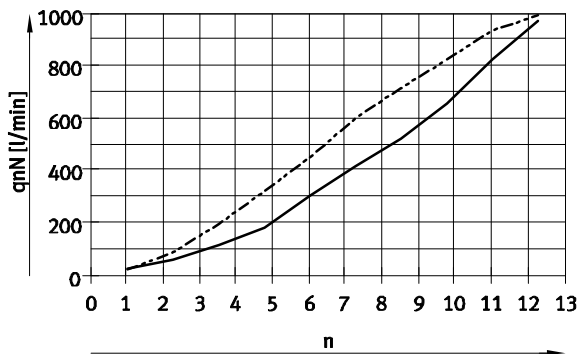

Width 42 mm (ISO 1)

— Flow control screw from 2 \rightarrow 3
 - - - Flow control screw from 4 \rightarrow 5
 n Revolutions of the adjusting screw

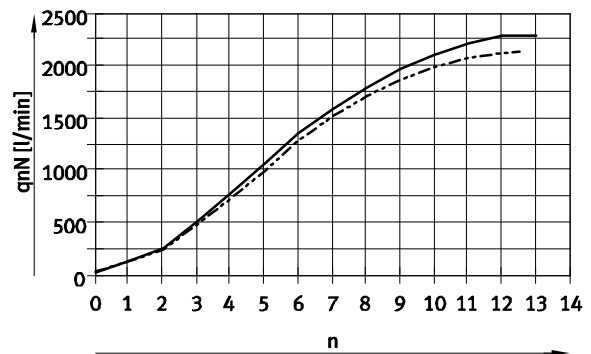

Width 52 mm (ISO 2)

— Flow control screw from 2 \rightarrow 3
 - - - Flow control screw from 4 \rightarrow 5
 n Revolutions of the adjusting screw

Pilot pressure $p_{12/14}$ as a function of operating pressure p_1

For 3/2-way solenoid valves

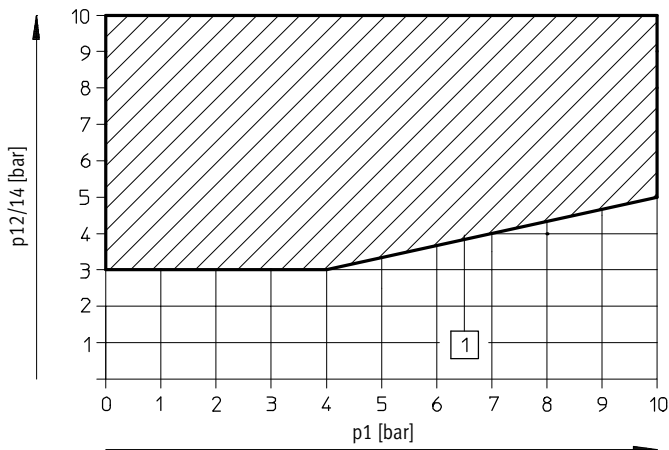

1 Operating range for valves with external pilot air supply

Valve terminals VTSA/VTSA-F, NPT

Technical data – Valve terminal

Standard nominal flow rate of vertical stacking [l/min]				
Width	18 mm	26 mm	42 mm	52 mm
Flow control plate				
VABF-S4-2-F1B1-C	See characteristic curve	–	–	–
VABF-S4-1-F1B1-C	–	See characteristic curve	–	–
VABF-S2-1-F1B1-C	–	–	1100	–
VABF-S2-2-F1B1-C	–	–	–	See characteristic curve
Vertical supply plate				
VABF-S4-2-P1A ... -G18	430	–	–	–
VABF-S4-1-P1A ... -G14	–	900	–	–
VABF-S2-1-P1A ... -G38	–	–	1300	–
VABF-S2-2-P1A ... -G12	–	–	–	2800
Vertical pressure shut-off plate				
VABF-S4-2-L1D1-C	400	–	–	–
VABF-S4-1-L1D1-C	–	800	–	–
VABF-S2-1-L1D1-M5	–	–	1200	–
VABF-S2-2-L1D1-C	–	–	–	1950

Operating and environmental conditions	
Operating medium	Compressed air to ISO 8573-1:2010 [7:4:4]
Pilot medium	Compressed air to ISO 8573-1:2010 [7:4:4]
Notes about the operating/pilot medium	Lubricated operation possible (in which case lubricated operation will always be required)
Operating pressure for valve terminal, pilot air supply ³⁾ [bar]	
• External	–0.9 ... +10
• Internal	3 ... 10
Pilot pressure [bar]	3 ... 10
Noise level LpA [dB(A)]	85
Ambient temperature [°C]	–5 ... +50
Temperature of medium [°C]	–5 ... +50
Storage temperature [°C]	–20 ... +60
Relative humidity [%]	90
Approval certificate	BIA C-Tick c UL us – Recognized (OL) (24 V DC only) CSA (OL) ⁴⁾
CE marking (see declaration of conformity)	In accordance with EU Low Voltage Directive (only VTSA/VTSA-F-MP, only 110 V AC) In accordance with EU EMC Directive ¹⁾ In accordance with EU Explosion Protection Directive (ATEX, EX1E ²⁾)
ATEX category for gas	II 3G (EX1E ²⁾)
Explosion ignition protection type for gas	Ex nA IIC T3 X Gc (EX1E ²⁾)
Explosion-proof ambient temperature [°C]	–5 ... +50 (EX1E ²⁾)

- 1) For information about the applicability of the component see the manufacturer's EC declaration of conformity at: www.festo.com/sp → User documentation.
If the component is subject to restrictions on usage in residential, office or commercial environments or small businesses, further measures to reduce the emitted interference may be necessary.
- 2) EX1E approval certificate is only valid for: VTSA/VTSA-F-MP, VTSA/VTSA-F-FB
- 3) Solenoid valves with code VC (2/2-way type ... T22C), N (3/2-way type ... T32U), K (3/2-way type ... T32C), H (3/2-way type ... T32H) must not be operated with vacuum; operating pressure is 3 ... 10 bar here
- 4) Approval certificate is valid for VTSA/VTSA-F-MP, VTSA/VTSA-F-FB

Valve terminals VTSA/VTSA-F, NPT

Technical data – Valve terminal

Electrical data – Individual electrical connection		
Load voltage supply for valves (U_{val})		
Operating voltage	[V DC]	24 ±10%
Max. residual current at 24 V DC	[A]	10
Duty cycle		100%
Protection class		IP65, NEMA 4 (for all types of signal transmission in assembled state)

Electrical data – Multi-pin plug connection		
Load voltage supply for valves (U_{val})		
Operating voltage	[V DC]	24 ±10%
	[V AC]	110 ±10% (50 ... 60 Hz)
Max. residual current	[A]	6
Acceptable current load at 40 °C	[A]	1
Surge resistance	[kV]	1.5
Degree of contamination		3
Duty cycle		100%
Protection class		IP65, NEMA 4 (for all types of signal transmission in assembled state)

Electrical data – With CPX terminal		
Power supply for electronics ($U_{EL/SEN}$)		
Operating voltage	[V DC]	24 ±10%
Max. intrinsic current consumption at 24 V DC	[mA]	20
Duty cycle		100%
Load voltage supply for valves (U_{val})		
Operating voltage	[V DC]	24 ±10%
Diagnostic message undervoltage U_{OFF} , load voltage outside function range	[V]	21.6 ... 21.5
Protection class		IP65, NEMA 4 (for all types of signal transmission in assembled state)

Materials	
Manifold sub-base	Die-cast aluminium
Valve	Die-cast aluminium, PA
Seals	FPM, NBR, HNBR
Supply plate	Die-cast aluminium
Right-hand end plate	Die-cast aluminium
Pneumatic interface for CPX	Die-cast aluminium
Flow control plate	Die-cast aluminium
Pressure regulator plate	Die-cast aluminium, PA
Multi-pin connection block	Die-cast aluminium
Cover for the pneumatic interface and multi-pin plug connection	PA
Note on materials	RoHS-compliant

Valve terminals VTSA/VTSA-F, NPT

Technical data – Valve terminal

Product weight				
Approx. weight	[g]			
Width	18 mm	26 mm	42 mm	52 mm
Multi-pin node with Sub-D or terminal strip ¹⁾	550			
Multi-pin node with M12 individual connection	760			
Pneumatic interface CPX ¹⁾	1470			
Electrical connection for AS-Interface	300			
AS-Interface module	850			
Supply plate ²⁾				
• Exhaust plate with 3 and 5 common	617			
• Exhaust port cover with 3 and 5 separated	597			
Right-hand end plate ³⁾				
– With threaded connections	339			336
– Selector	281			–
Manifold sub-base ⁴⁾	447	634	340	815
90° connection plate ³⁾	170	230	176	359
Pressure regulator plate				
for port 1 (P)	350	402	640	1190
for port 4 or 2 (A or B)	367	448	640	1230
for ports 4 and 2 (A/B)	611	692	920	1990
Flow control plate	228	320	220	565
Vertical supply plate ³⁾	140	191	340	605
Vertical pressure shut-off plate	209	273	600	1030
Valves → Solenoid valves, widths				
Blanking plate	34	73	68	146

1) With sheet metal seal, printed circuit board

2) With sheet metal seal and electrical interlinking module

3) With screws

4) With sheet metal seal, electrical interlinking module, inscription label holder, 4 screws

Valve terminals VTSA/VTSA-F, NPT

Technical data – Valve terminal



Dimensions

Download CAD data → www.festo.com

Valve terminal with individual electrical connection

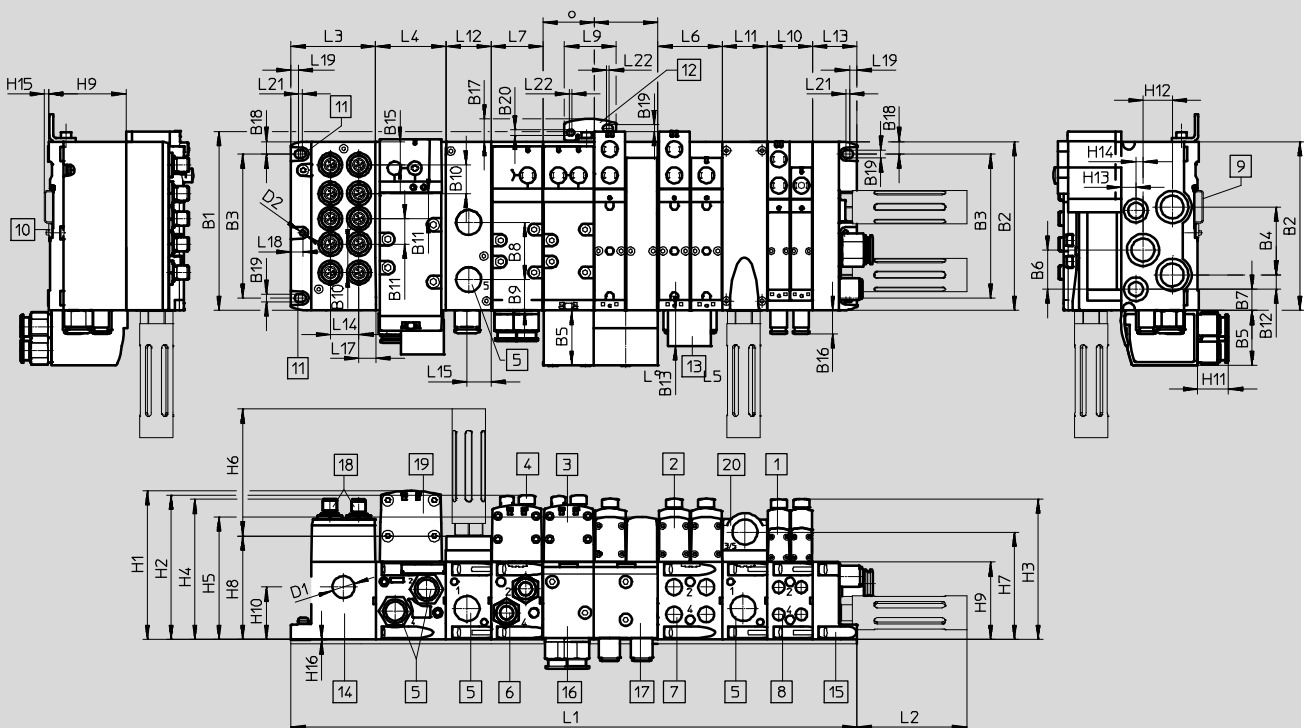

- | | | | |
|--------------------------------|--------------------------------|---|---|
| 1 Solenoid valve, width 18 mm | 7 Threaded connection 1/4" NPT | 16 90° connection plate 43 mm, 3/8" NPT | n02 Number of manifold sub-bases 38 mm |
| 2 Solenoid valve, width 26 mm | 8 Threaded connection 1/8" NPT | 17 90° connection plate 54 mm, 1/4" NPT | n01 Number of manifold sub-bases 54 mm |
| 3 Solenoid valve, width 42 mm | 9 H-rail | 18 M12 plug, 5-pin (6-way or 10-way) | n1 Number of manifold sub-bases 43 mm |
| 4 Cover cap/manual override | 10 H-rail mounting | 19 Solenoid valve, width 52 mm | n2 Number of manifold sub-bases 59 mm |
| 5 Threaded connection 1/2" NPT | 11 Mounting hole | 20 Supply plate | n Number of supply plates (only with end plate with pilot air selector) |
| 6 Threaded connection 3/8" NPT | 12 Additional mounting bracket | | |
| | 13 Inscription label holder | | |
| | 14 Individual connection | | |
| | 15 End plate | | |

Dim.	B1	B2	B3	B4	B5	B6	B7	B8	B9	B10	B11	B12	B13	B14	B15	B16	B17	B18	B19	B20
[mm]	150.5	142	121	57	46	33	18	48	26	24	21.3	12	29.6	23	19.6	19.5	19	10.5	6.6	4.5

Dim.	L2	L3	L4	L5	L6	L7	L8	L9	L10	L11	L12	L13	L14	L15	L16	L17	L18	L19
[mm]	92.4	71.3	n2x59	n01x54	54	n1x43	43	43.5	n02x38	nx38	38	37.3	24	20.5	20	14.1	9.8	6.3

Dim.	L20	L21	L22	D1Ø	D2Ø	H1	H2	H3	H4	H5	H6	H7	H8	H9	H10	H11	H12	H13	H14	H15	H16
[mm]	5.5	3	2	18.5	4.5	125	121.3	118.2	118	103	107.8	90.3	87	65	44	25.7	24.5	12	6	3.5	0.5

Width	L1
18 mm	71.3 + n02 x 38 + n x 38 + 37.3
26 mm	71.3 + n01 x 54 + n x 38 + 37.3
42 mm	71.3 + n1 x 43 + n x 38 + 37.3
52 mm	71.3 + n2 x 59 + n x 38 + 37.3
Mixture of 18 mm, 26 mm, 42 mm and 52 mm	71.3 + n02 x 38 + n01 x 54 + n1 x 43 + n2x59 + n x 38 + 37.3

– Note: This product conforms to ISO 1179-1 and to ISO 228-1

Valve terminals VTSA/VTSA-F, NPT

Technical data – Valve terminal

Dimensions

Download CAD data → www.festo.com

Valve terminal with multi-pin plug connection

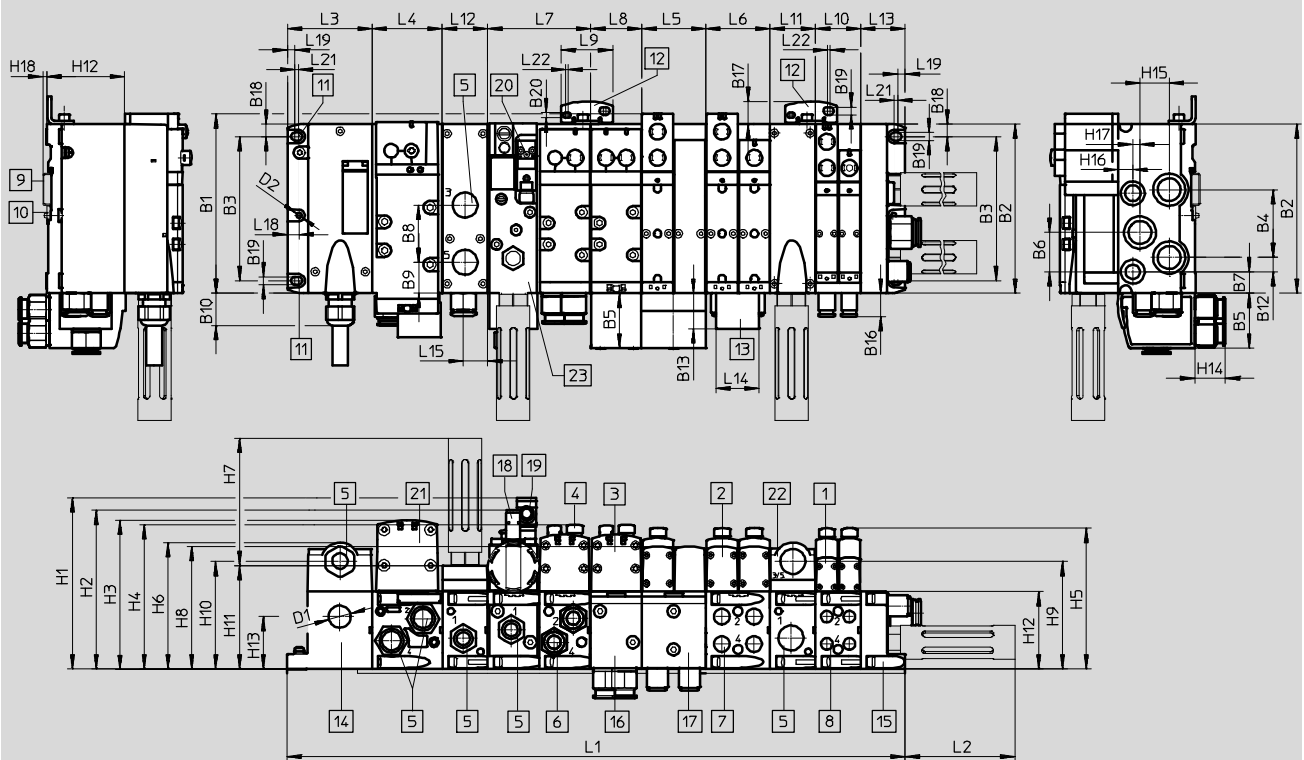

- | | | | |
|--------------------------------|---|---|---|
| 1 Solenoid valve, width 18 mm | 9 H-rail | 17 90° connection plate 54 mm, 1/4" NPT | n02 Number of manifold sub-bases 38 mm |
| 2 Solenoid valve, width 26 mm | 10 H-rail mounting | 18 Proximity sensor M12x1 | n01 Number of manifold sub-bases 54 mm |
| 3 Solenoid valve, width 42 mm | 11 Mounting hole | 19 Plug socket M12x1 | n1 Number of manifold sub-bases 43 mm |
| 4 Cover cap/manual override | 12 Additional mounting bracket | 20 Electrical connection to DIN EN 175301-803, type C | N2 Number of manifold sub-bases 59 mm |
| 5 Threaded connection 1/2" NPT | 13 Inscription label holder | 21 Solenoid valve, width 52 mm | n Number of supply plates (only with end plate with pilot air selector) |
| 6 Threaded connection 3/8" NPT | 14 Multi-pin plug connection | 22 Supply plate | |
| 7 Threaded connection 1/4" NPT | 15 End plate | 23 Soft-start valve | |
| 8 Threaded connection 1/8" NPT | 16 90° connection plate 43 mm, 3/8" NPT | | |

Dim.	B1	B2	B3	B4	B5	B6	B7	B8	B9	B10	B11	B12	B13	B14	B16	B17	B18	B19	B20
[mm]	150.5	142	121	57	46	33	18	48	26	27	2	12	29.6	23	19.5	19	10.5	6.6	4.5

Dim.	L2	L3	L4	L5	L6	L7	L8	L9	L10	L11	L12	L13	L14	L15	L16	L18	L19	L20	L21
[mm]	92.4	71.3	n2x59	n01x54	54	n1x43	43	43.5	n02x38	nx38	38	37.3	36	20.5	20	9.8	6.3	5.5	3

Dim.	L22	D1Ø	D2Ø	H1	H2	H3	H4	H5	H6	H7	H8	H9	H10	H11	H12	H13	H14	H15	H16	H17	H18
[mm]	2	18.5	4.5	143.9	133.3	125	121.3	118.2	106.3	107.8	103	90.3	90.3	87	65	44	25.7	24.5	12	6	3.5

Width	L1
18 mm	71.3 + n02 x 38 + n x 38 + 37.3
26 mm	71.3 + n01 x 54 + n x 38 + 37.3
42 mm	71.3 + n1 x 43 + n x 38 + 37.3
52 mm	71.3 + n2 x 59 + n x 38 + 37.3
Mixture of 18 mm, 26 mm, 42 mm and 52 mm	71.3 + n02 x 38 + n01 x 54 + n1 x 43 + n2 x 59 + n x 38 + 37.3

Note: This product conforms to ISO 1179-1 and to ISO 1228-1

Valve terminals VTSA/VTSA-F, NPT

Technical data – Valve terminal

Dimensions

Download CAD data → www.festo.com

Multi-pin, terminal strip (CageClamp®), VABE-S6-1LF-C-M1-C...

Multi-pin, round plug connector, VABE-S6-1LF-C-M1-R...

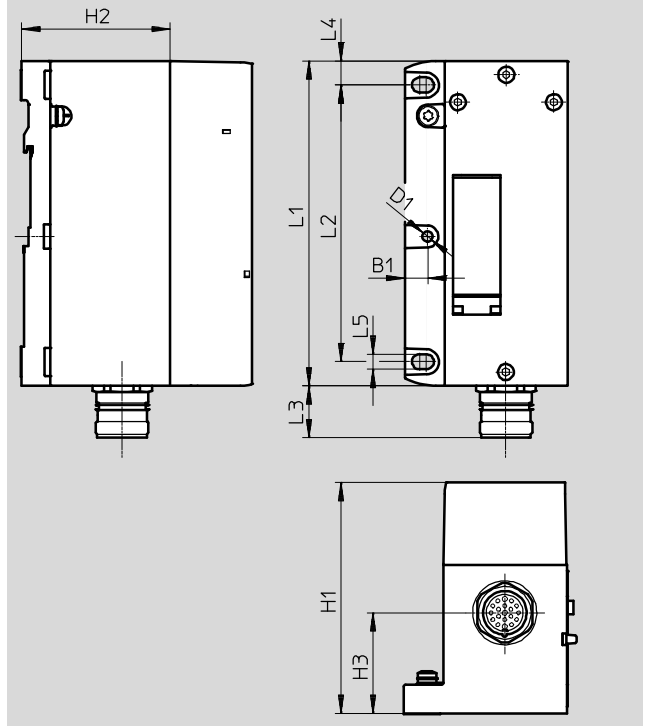
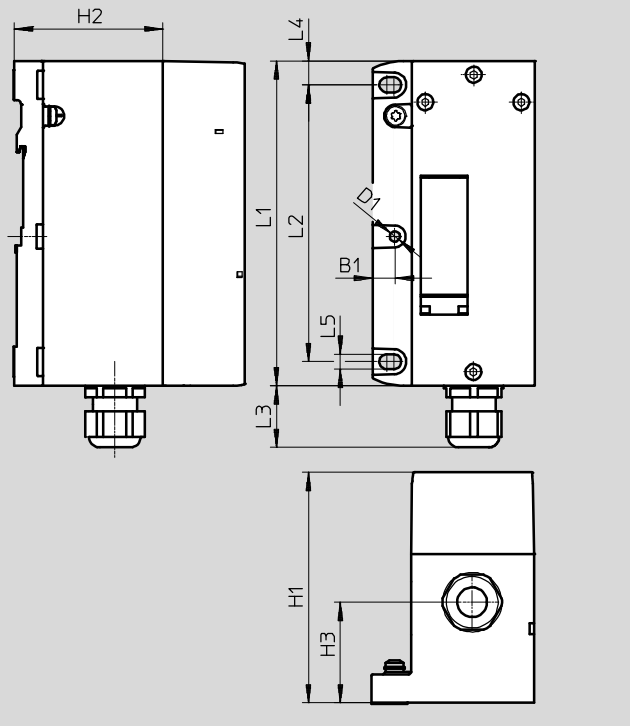

Type	H1	H2	H3	D1Ø	L1	L2	L3	L4	L5	B1
VABE-S6-1LF-C-M1-C...	106.1	65	44	4.5	142	121	27	10.5	6.6	9.8
VABE-S6-1LF-C-M1-R...	101	65	44	4.5	142	121	23	10.5	6.6	9.8

Valve terminals VTSA/VTSA-F, NPT

Technical data – Valve terminal

Dimensions

Download CAD data → www.festo.com

Valve terminal with AS-Interface connection

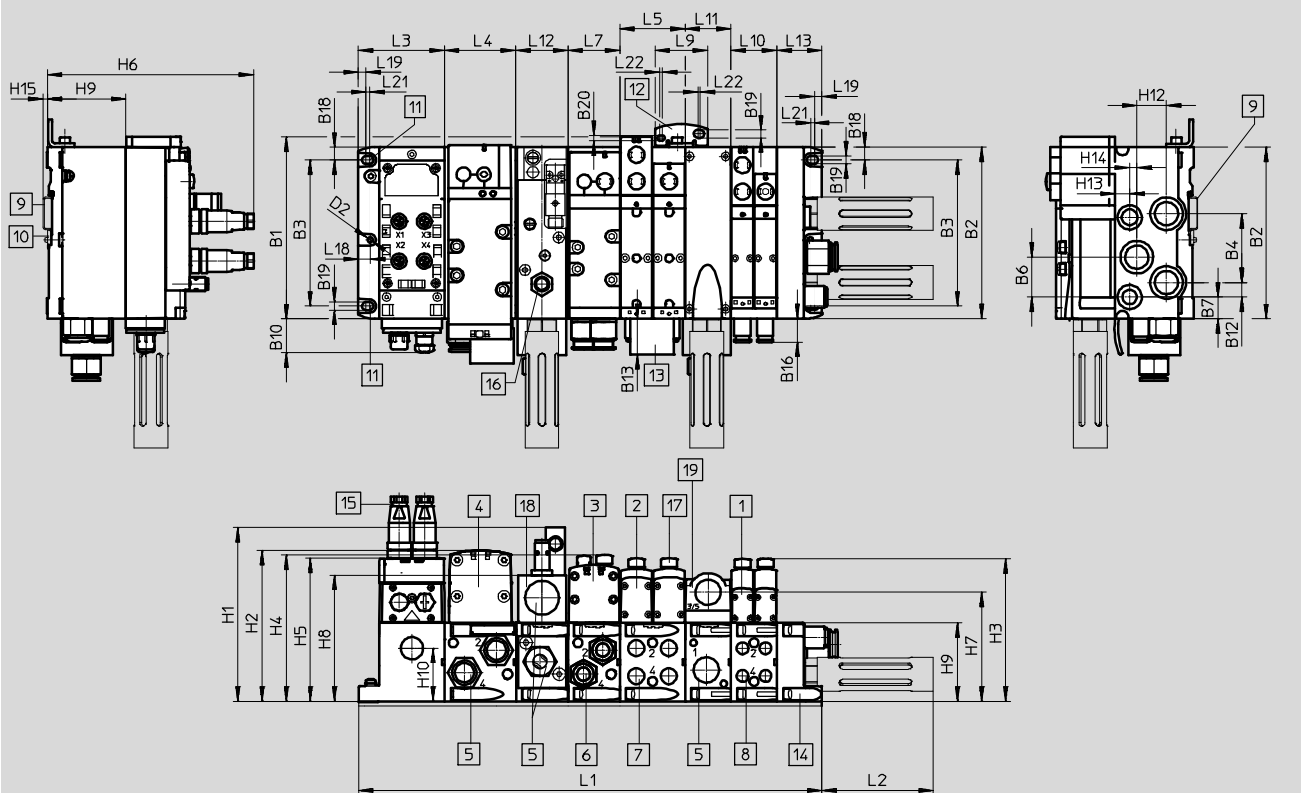

- | | | | |
|--------------------------------|--------------------------------|----------------------------------|--|
| 1 Solenoid valve, width 18 mm | 7 Threaded connection 1/4" NPT | 16 Proximity sensor M12x1 | n02 Number of manifold sub-bases 38 mm |
| 2 Solenoid valve, width 26 mm | 8 Threaded connection 1/8" NPT | 17 Cover cap/manual override | n01 Number of manifold sub-bases 54 mm |
| 3 Solenoid valve, width 42 mm | 9 H-rail | 18 Soft-start valve, width 43 mm | n1 Number of manifold sub-bases 43 mm |
| 4 Solenoid valve, width 52 mm | 10 H-rail mounting | 19 Supply plate | n2 Number of manifold sub-bases 59 mm |
| 5 Threaded connection 1/2" NPT | 11 Mounting hole | | n Number of supply plates |
| 6 Threaded connection 3/8" NPT | 12 Additional mounting bracket | | |
| | 13 Inscription label | | |
| | 14 End plate | | |
| | 15 Plug M12 | | |

Dim.	B1	B2	B3	B4	B6	B7	B10	B12	B13	B14	B16	B18	B19	B20
[mm]	150.5	142	121	57	33	18	28	12	29.6	23	19.5	10.5	6.6	4.5

Dim.	L2	L3	L4	L5	L7	L9	L10	L11	L12	L13	L16	L18	L19	L20	L21
[mm]	92.4	71.3	n2x59	n01x54	n1x43	43.5	n02x38	nx38	43	37.3	20	9.8	6.3	5.5	3

Dim.	L22	D2Ø	H1	H2	H3	H4	H5	H6	H7	H8	H9	H10	H12	H13	H14	H15
[mm]	2	4.5	143.9	125	118.2	121.3	118.6	171	90.3	104.5	65	44	24.5	12	6	3.5

Width	L1
18 mm	71.3 + n02 x 38 + n x 38 + 37.3
26 mm	71.3 + n01 x 54 + n x 38 + 37.3
42 mm	71.3 + n1 x 43 + n x 38 + 37.3
52 mm	71.3 + n2 x 59 + n x 38 + 37.3
Mixture of 18 mm, 26 mm, 42 mm and 52 mm	71.3 + n02 x 38 + n01 x 54 + n1 x 43 + n2 x 59 + n x 38 + 37.3

Valve terminals VTSA/VTSA-F, NPT

Technical data – Valve terminal



Dimensions

Download CAD data → www.festo.com

Valve terminal with fieldbus connection

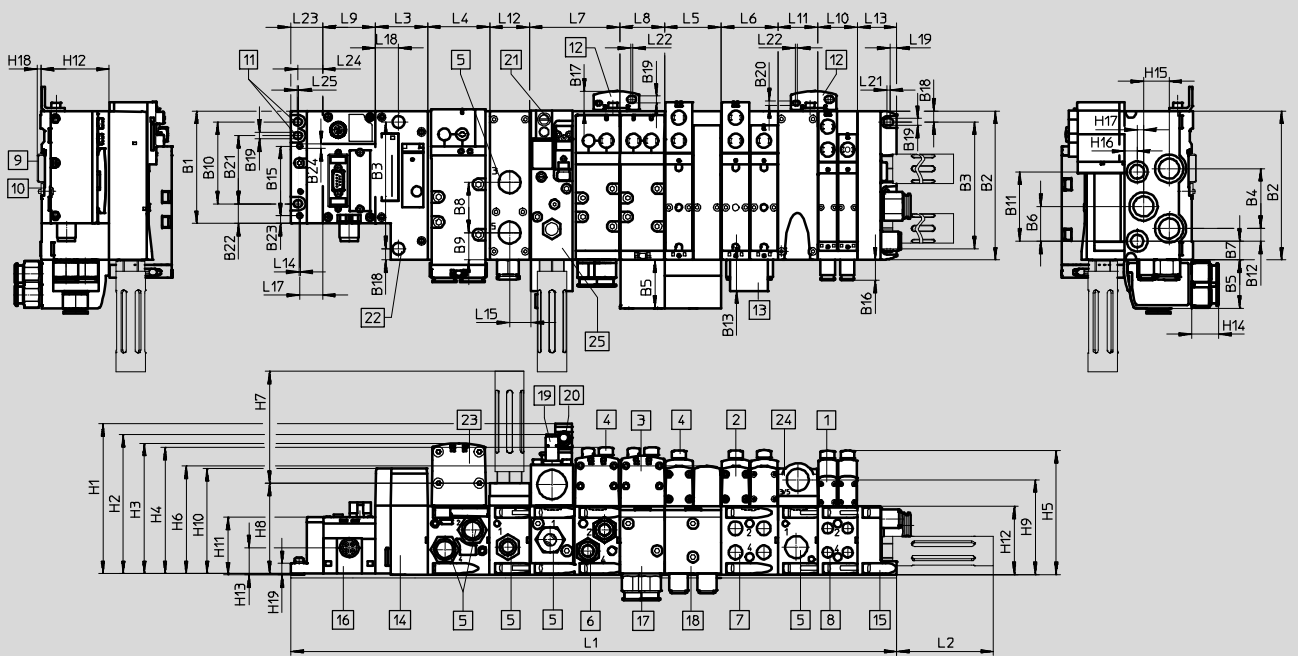

- | | | | |
|--------------------------------|---|---|---|
| 1 Solenoid valve, width 18 mm | 10 H-rail mounting | 19 Proximity sensor M12x1 | n02 Number of manifold sub-bases 38 mm |
| 2 Solenoid valve, width 26 mm | 11 Mounting hole | 20 Plug socket M12x1 | n01 Number of manifold sub-bases 54 mm |
| 3 Solenoid valve, width 42 mm | 12 Additional mounting bracket | 21 Electrical connection to DIN EN 175301-803, type C | n1 Number of manifold sub-bases 43 mm |
| 4 Cover cap/manual override | 13 Inscription label holder | 22 Hole for additional mounting, diameter 6.4 2x | n2 Number of manifold sub-bases 59 mm |
| 5 Threaded connection 1/2" NPT | 14 Pneumatic interface CPX | 23 Solenoid valve, width 52 mm | n Number of supply plates (only with end plate with pilot air selector) |
| 6 Threaded connection 3/8" NPT | 15 End plate | 24 Supply plate | m Number of CPX modules |
| 7 Threaded connection 1/4" NPT | 16 CPX module/fieldbus node | 25 Soft-start valve | |
| 8 Threaded connection 1/8" NPT | 17 90° connection plate 43 mm, 3/8" NPT | | |
| 9 H-rail | 18 90° connection plate 54 mm, 1/4" NPT | | |

Dim.	B1	B2	B3	B4	B5	B6	B7	B8	B9	B10	B11	B12	B13	B14	B16	B18	B19	B20	B21	B22	B23	B24
[mm]	107.3	142	121	57	46	33	18	48	26	78	66	12	29.6	23	19.5	10.5	6.6	4.5	65	18.9	7.5	4.4

Dim.	L2	L3	L4	L5	L6	L7	L8	L9	L10	L11	L12	L13	L14	L15	L16	L17	L18	L19	L20	L21	L22
[mm]	92.4	50	n2x59	n01x54	54	n1x43	43	mx201	n02x38	nx38	38	37.3	1	20.5	20	22	22	6.3	5.5	3	2

Dim.	L23	L24	L25	H1	H2	H3	H4	H5	H6	H7	H8	H9	H10	H11	H12	H13	H14	H15	H16	H17	H18	H19
[mm]	30.4	23.7	1.5	143.9	133.3	125	121.3	118.2	103	106.8	87	90.3	101.4	55.1	65	25.8	25.7	24.5	12	6	3.5	10.8

Width	L1
18 mm	30.4 + m x 50.1 + 50 + n02 x 38 + n x 38 + 37.3
26 mm	30.4 + m x 50.1 + 50 + n01 x 54 + n x 38 + 37.3
42 mm	30.4 + m x 50.1 + 50 + n1 x 43 + n x 38 + 37.3
52 mm	30.4 + m x 50.1 + 50 + n2 x 59 + n x 38 + 37.3
Mixture of 18 mm, 26 mm, 42 mm and 52 mm	30.4 + m x 50.1 + 50 + n02 x 38 + n01 x 54 + n1 x 43 + n2x59 + n x 38 + 37.3

• Note: This product conforms to ISO 1179-1 and to ISO 228-1

Valve terminals VTSA/VTSA-F, NPT

Technical data – Valve terminal

Dimensions

Download CAD data → www.festo.com

Vertical stacking components, width 18 mm

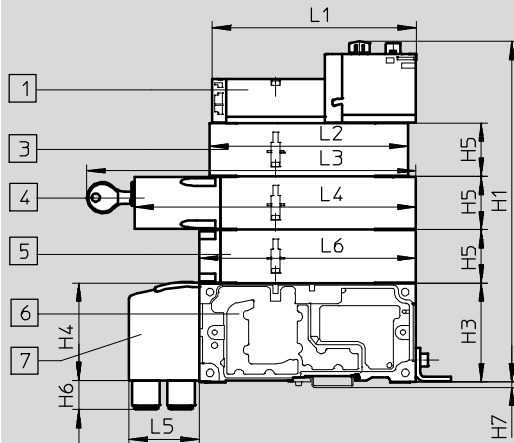

- 1 Solenoid valve with two solenoid coils, width 18 mm
- 3 Flow control plate
- 4 Vertical pressure shut-off plate
- 5 Vertical supply plate
- 6 Manifold sub-base
- 7 90° connection plate

Dim.	L1	L2	L3	L4	L5	L6	H1	H3	H4	H5	H6	H7
[mm]	133.8	130	184.1	203.7	46	142	224	65	64	35	19	3.5

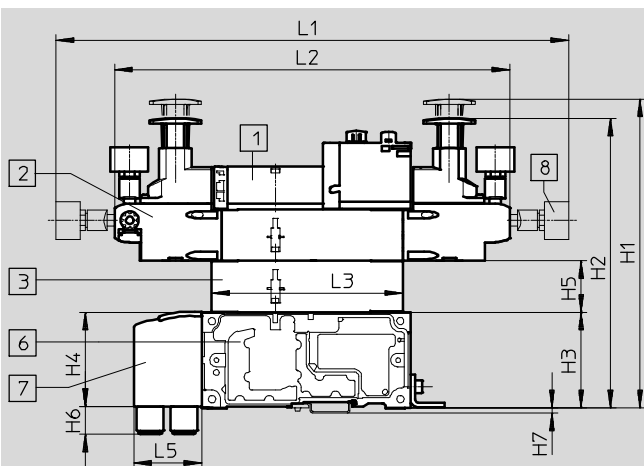

- 1 Solenoid valve with two solenoid coils, width 18 mm
- 2 Pressure regulator plate
- 3 Flow control plate
- 6 Manifold sub-base
- 7 90° connection plate
- 8 Pressure gauge, freely positionable

Dim.	L1	L2	L3	L5	H1	H2	H3	H4	H5	H6	H7
[mm]	348.2	268.6	130	46	210	197	65	64	35	19	3.5

Vertical stacking components, width 18 mm, with the pressure regulator plate also suitable for valves with symmetrical coil layout

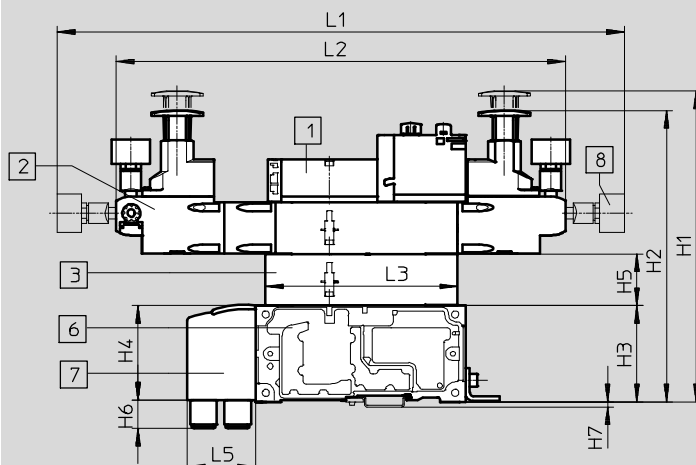

- 1 Solenoid valve with two solenoid coils, width 18 mm
- 2 Pressure regulator plate
- 3 Flow control plate
- 6 Manifold sub-base
- 7 90° connection plate
- 8 Pressure gauge, freely positionable

Dim.	L1	L2	L3	L5	H1	H2	H3	H4	H5	H6	H7
[mm]	383.2	303.6	130	46	210	197	65	64	35	19	3.5

Valve terminals VTSA/VTSA-F, NPT

Technical data – Valve terminal

Dimensions

Download CAD data → www.festo.com

Vertical stacking components, width 26 mm

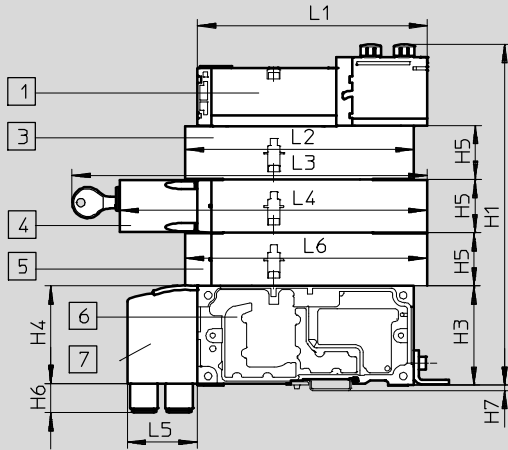

- 1 Solenoid valve with two solenoid coils, width 26 mm
- 3 Flow control plate
- 4 Vertical pressure shut-off plate
- 5 Vertical supply plate
- 6 Manifold sub-base
- 7 90° connection plate

Dim.	L1	L2	L3	L4	L5	L6	H1	H3	H4	H5	H6	H7
[mm]	150.8	150	221	201.4	46	158.5	224	65	64	35	19	3.5

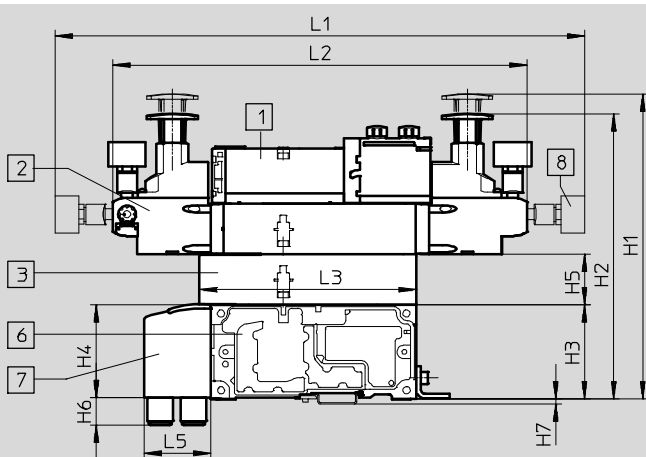

- 1 Solenoid valve with two solenoid coils, width 26 mm
- 2 Pressure regulator plate
- 3 Flow control plate
- 6 Manifold sub-base
- 7 90° connection plate
- 8 Pressure gauge, freely positionable

Dim.	L1	L2	L3	L5	H1	H2	H3	H4	H5	H6	H7
[mm]	365.7	286.1	150	46	210	197	65	64	35	19	3.5

Vertical stacking components, width 26 mm, with the pressure regulator plate also suitable for valves with symmetrical coil layout

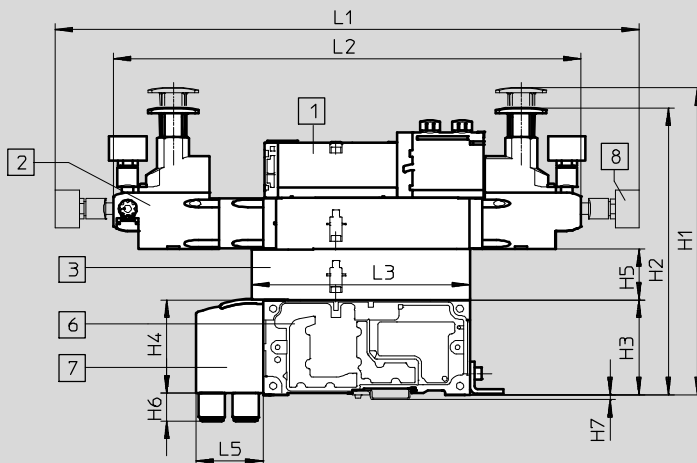

- 1 Solenoid valve with two solenoid coils, width 26 mm
- 2 Pressure regulator plate
- 3 Flow control plate
- 6 Manifold sub-base
- 7 90° connection plate
- 8 Pressure gauge, freely positionable

Dim.	L1	L2	L3	L5	H1	H2	H3	H4	H5	H6	H7
[mm]	400.7	321.1	150	46	210	197	65	64	35	19	3.5

Valve terminals VTSA/VTSA-F, NPT

Technical data – Valve terminal

Dimensions

Download CAD data → www.festo.com

Vertical stacking components, width 42 mm

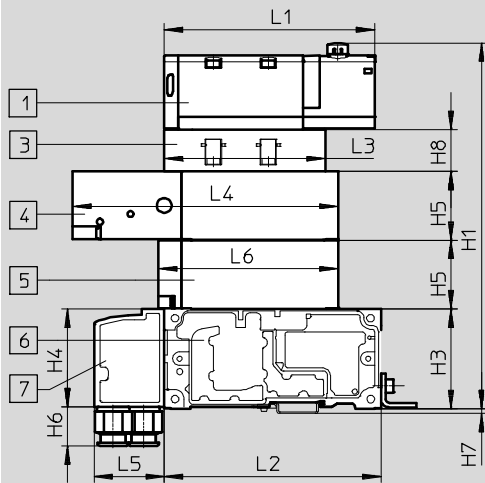

- 1 Solenoid valve
- 3 Flow control plate
- 4 Vertical pressure shut-off plate
- 5 Vertical supply plate
- 6 Manifold sub-base
- 7 90° connection plate

Dim.	L1	L2	L3	L4	L5	L6	H1	H3	H4	H5	H6	H7	H8
[mm]	137.8	142	105.3	173.8	46	117.6	236	65	64	45.3	25.7	3.5	28

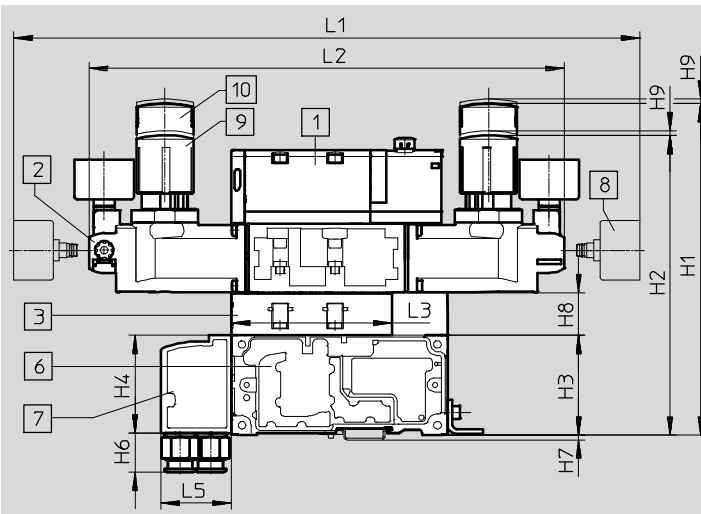

- 1 Solenoid valve
- 2 Pressure regulator plate
- 3 Flow control plate
- 6 Manifold sub-base
- 7 90° connection plate
- 8 Pressure gauge, freely positionable
- 9 Standard rotary knob
- 10 Lockable rotary knob

Dim.	L1	L2	L3	L5	H1	H2	H3	H4	H6	H7	H8	H9
[mm]	410.3	311.6	105.3	46	220.7	196.1	65	64	25.7	3.5	28	3

 Note

Pressure regulator plates for valves with symmetrical coil layout with widths of 42 mm and 52 mm can

only be ordered via the pressure regulator configurator VABF-S2.
→ Internet: vabf-s2

Valve terminals VTSA/VTSA-F, NPT

Technical data – Valve terminal

Dimensions

Download CAD data → www.festo.com

Vertical stacking components, width 52 mm

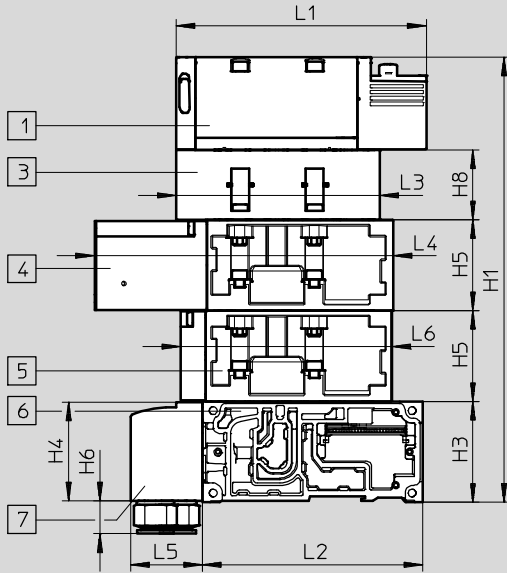

- 1 Solenoid valve
- 3 Flow control plate
- 4 Vertical pressure shut-off plate
- 5 Vertical supply plate
- 6 Manifold sub-base
- 7 90° connection plate

Dim.	L1	L2	L3	L4	L5	L6	H1	H3	H4	H5	H6	H8
[mm]	160.7	142	131	191.2	46	136	287.4	65	63.5	58.7	21.2	45

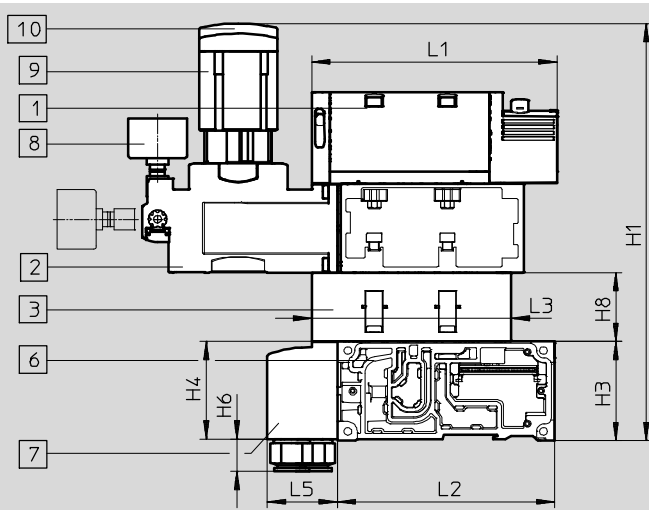

- 1 Solenoid valve
- 2 Pressure regulator plate
- 3 Flow control plate
- 6 Manifold sub-base
- 7 90° connection plate
- 8 Pressure gauge, freely positionable
- 9 Standard rotary knob
- 10 Lockable rotary knob

Dim.	L1	L2	L3	L5	H1	H3	H4	H6	H8
[mm]	160.7	142	131	46	278	32.5	63.5	21.2	22.5

-  - Note

Pressure regulator plates for valves with symmetrical coil layout with widths of 42 mm and 52 mm can

only be ordered via the pressure regulator configurator VABF-S2.
→ Internet: vabf-s2

Valve terminals VTSA/VTSA-F, NPT

Technical data – Valve terminal

Dimensions

Download CAD data → www.festo.com

Supply plate with silencer

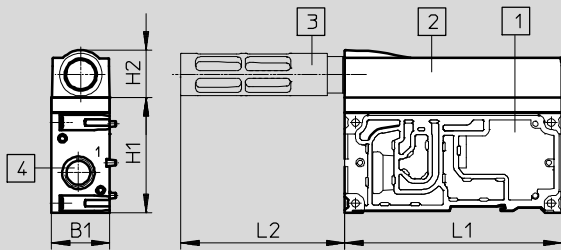

- 1 Supply plate
- 2 Exhaust port cover
- 3 Silencer U-1/2-B-NPT
- 4 Threaded connection 1/2" NPT

Dim.	L1	L2	H1	H2	B1
[mm]	142	107.5	75	31.5	38

Right-hand end plate, VABE-S6-1R...

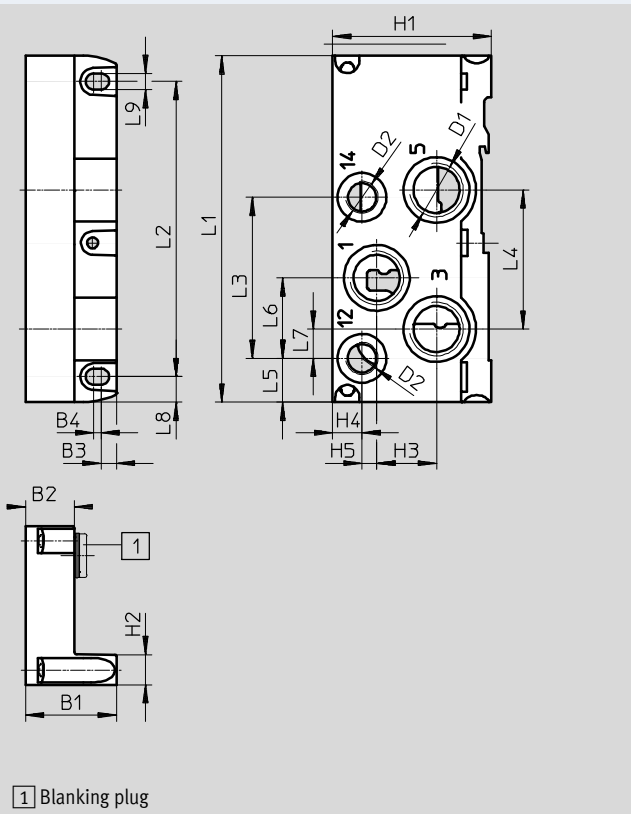

Right-hand end plate, VABE-S6-2R...

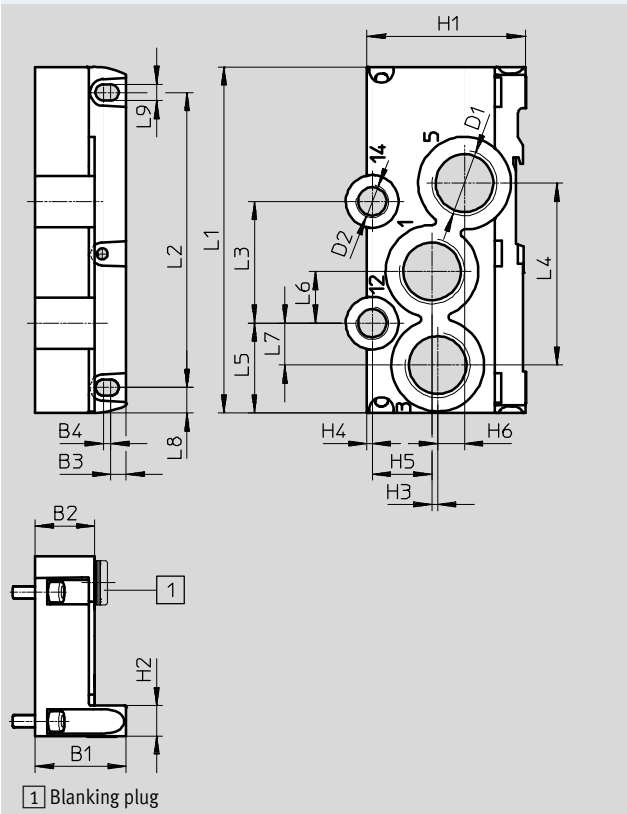

Type	L1	L2	L3	L4	L5	L6	L7	L8	L9	D1	D2	H1	H2	H3	H4	H5	H6	B1	B2	B3	B4	With ¹⁾
VABE-S6-1R-N12	142	121	66	57	18	33	12	10.5	6.6	1/2"	1/4"	65	12.5	24.5	12	6	-	37.3	22	6.3	3	1
VABE-S6-1RZ-N12										NPT	NPT											-
VABE-S6-2R-N34	142	121	49.9	74.6	36.9	21.2	17.2	10.5	6.6	3/4"	3/4"	65	12.5	2.3	2.2	24.5	11	37.3	24.5	6.3	3	1
VABE-S6-2RZ-N34										NPT	NPT											-

1) With blanking plug = internal pilot air supply, - without blanking plug = external pilot air supply

• Note: This product conforms to ISO 1179-1 and to ISO 228-1

Valve terminals VTSA/VTSA-F, NPT

Technical data – Valve terminal

Dimensions

Download CAD data → www.festo.com

Right-hand end plate with pilot air selector, VABE-S6-1RZ-N-B1

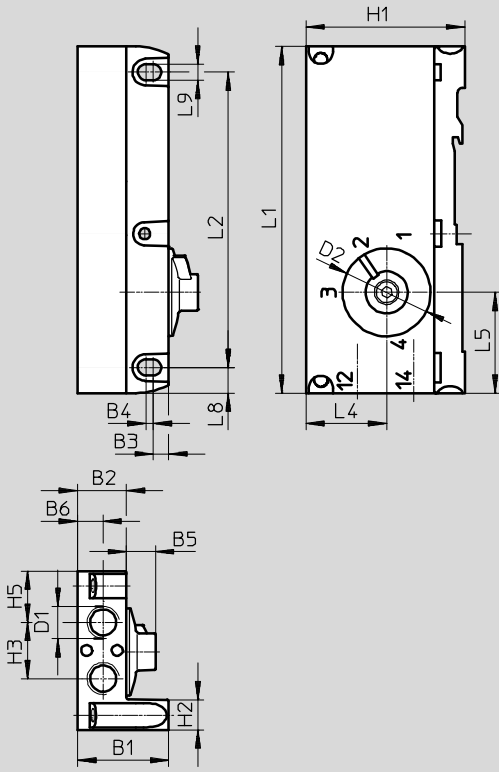

Type	L1	L2	L5	L8	L9	D1	D2	H1	H2	H3	H4	H5	B1	B2	B3	B4	B5	B6
VABE-S6-1RZ-N-B1	142	121	41.3	10.5	6.6	1/4" NPT	37	65.4	12.5	23	33	21	37.3	20	6.3	3	12	10.5

• Note: This product conforms to ISO 1179-1 and to ISO 228-1

Valve terminals VTSA/VTSA-F, NPT

Technical data – Solenoid valves VSVA

FESTO

-  - Valve width to ISO 15407-2
- 18 mm
 - 26 mm
- to ISO 5599-2
- 42 mm (ISO 1)
 - 52 mm (ISO 2)

-  - Voltage
- 24 V DC
 - 110 V AC

-  - Flow rate¹⁾
- Width 18 mm: up to 550 (700) l/min
 - Width 26 mm: up to 1100 (1350) l/min
 - Width 42 mm: up to 1300 (1860) l/min
 - Width 52 mm: up to 2900 l/min

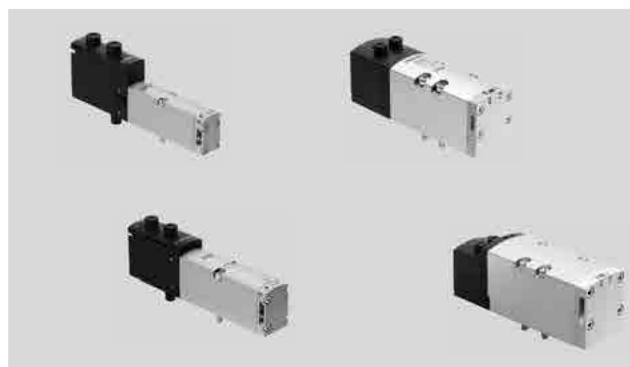

1) Flow rates in brackets apply to VTSA-F

General technical data - Solenoid valves		
Design	Piston spool valve	
Sealing principle	Soft	
Type of reset	Mechanical or pneumatic, depending on type used	
Actuation type	Electrical	
Electrical connection	Plug to ISO 15407-2, 2-pin (single solenoid types) or 4-pin (double solenoid and 5/3-way types)	
Type of control	Piloted	
Protection class to EN 60529	IP65, NEMA 4 (for all types of signal transmission in assembled state)	
Exhaust function, with flow control	Via individual sub-base, via flow control plate (not with valve type T22)	
Type of mounting	On manifold sub-base, on individual sub-base	
Mounting position	Any	
Manual override	Detenting, non-detenting, covered	
Switching status display	LED (except types with switching status display sensor, and part nos.: 560727 and 560728)	
Switching status display sensor	Yellow LED	
Duty cycle [%]	100	
Degree of contamination	3	
Surge resistance [kV]	2.5	
Nominal operating voltage	[V DC]	24 (dependent on valve type)
	[V AC]	110 (dependent on valve type)
Permissible voltage fluctuations [%]	±10	
Pneumatic connections		
Supply port	1	Via the manifold sub-base of the valve terminal or via individual sub-base
Exhaust port	3/5	
Working ports	2/4	
Pilot air supply	12/14	
Pilot exhaust air port	82/84	Either ducted or unducted

Valve terminals VTSA/VTSA-F, NPT

Technical data – Solenoid valves

Pneumatic characteristic data										
Terminal code	VC	VV	N	C	H	P	Q	R	M	O
Valve code	T22C	T22CV	T32U	T32C	T32H	T32F	T32N	T32W	M52-A	M52-M
Direction of flow										
Any	-	■	-	-	-	-	-	-	■	■
Reversible only	-	-	-	-	-	■	■	■	-	-
Non-reversible	■	-	■	■	■	-	-	-	-	-
Reset method										
Pneumatic spring	■	■	■	■	■	■	■	■	■	-
Mechanical spring	-	-	-	-	-	-	-	-	-	■

Pneumatic characteristic data										
Terminal code	J	D	B	G	E	SA	SB	SD	SE	VG
Valve code	B52	D52	P53U	P53C	P53E	P53ED	P53AD	P53BD	P53EP	P53F
Direction of flow										
Any	■	■	■	■	■	-	■	-	-	■
Reversible only	-	-	-	-	-	-	-	-	-	-
Non-reversible	-	-	-	-	-	■	-	■	■	-
Reset method										
Pneumatic spring	-	-	-	-	-	-	-	-	-	-
Mechanical spring	-	-	■	■	■	■	■	■	■	■

Direction of flow of solenoid valves

- | | | |
|--|---|---|
| <p>Solenoid valves with reversible only flow direction</p> <ul style="list-style-type: none"> • These valves must only be operated on pressure zones with reversible supply (3 and 5 with supply pressure 1 as exhaust air) or on a reversible pressure regulator. If necessary create pressure separation zones with duct separation. • Reversible 3/2-way solenoid valves do not permit the special function "ducted pilot exhaust air" | <p>Solenoid valves with any flow direction</p> <ul style="list-style-type: none"> • Ports 12 and 14 on the end plate variants must be supplied with the same pressure • Right-hand end plate with pilot air selector: can be realised via position 1 or 2 • Right-hand end plate with threaded connections: 12 and 14 must be supplied with the same pressure level | <ul style="list-style-type: none"> • Valves with any flow direction such as the 5/2-way solenoid valve, code M, for example, are suitable for vacuum operation (standard valves such as the 2x 2/2-way solenoid valve with code VC, for example, may not be used for vacuum operation). • An exception is the 2x 2/2-way solenoid valve with code VV (T22CV), which only allows vacuum operation at ports 3 and 5. The solenoid valve with code VV (T22CV) cannot be combined with other valve functions; a separate pressure zone is required. |
|--|---|---|

Valve terminals VTSA/VTSA-F, NPT

Technical data – Solenoid valves

FESTO

Operating and environmental conditions		
Operating medium		Compressed air to ISO 8573-1:2010 [7:4:4]
Pilot medium		Compressed air to ISO 8573-1:2010 [7:4:4]
Notes about the operating/pilot medium		Lubricated operation possible (in which case lubricated operation will always be required)
Operating pressure, pilot air supply ²⁾	[bar]	-0.9 ... +10 (valves with any flow direction and reversible valves)
		3 ... 10 (non-reversible valves)
Pilot pressure	[bar]	3 ... 10
Pilot air supply		External
		Internal via valve terminal
Ambient temperature	[°C]	-5 ... +50
Approval certificate		BIA (for characteristic SP and/or SN only)
	24 V DC	C-Tick (only size 52 mm and solenoid valve with sensor (position sensing))
		c UL us – Recognized (OL)
		CSA (OL)
CE marking (see declaration of conformity)	110 V AC	In accordance with EU Low Voltage Directive (only VTSA/VTSA-F-MP)
	24 V DC	In accordance with EU EMC Directive ¹⁾

1) For information about the applicability of the component see the manufacturer's EC declaration of conformity at: www.festo.com/sp → User documentation.

If the component is subject to restrictions on usage in residential, office or commercial environments or small businesses, further measures to reduce the emitted interference may be necessary.

2) Solenoid valves with code VC (2/2-way type ... T22C), N (3/2-way type ... T32U), K (3/2-way type ... T32C), H (3/2-way type ... T32H) must not be operated with vacuum; operating pressure is 3 ... 10 bar here

Valve terminals VTSA/VTSA-F, NPT

Type code – Solenoid valves VSVA

VSVA – B – T 22 CV – A Z D

Valve series

VSVA	Standard valves to ISO 15407-1/-2
------	-----------------------------------

Valve type

B	Sub-base valve
---	----------------

Valve function

M	Single solenoid
B	Double solenoid
D	Double solenoid with dominant signal at 14
P	Single solenoid, mid-position
T	2 single solenoid valves in one housing

Connections/switching positions

22	2/2-way valve
32	3/2-way valve
52	5/2-way valve
53	5/3-way valve

Normal position

AD	Port 2 pressurised, port 4 exhausted, switching position 14 detenting, 12 mechanical spring
BD	Port 4 pressurised, port 2 exhausted, switching position 14 detenting, 12 mechanical spring
C	Closed
CV	Closed, vacuum operation possible at 3 and 5
N	Code T with 2x closed, reverse operation
U	Open
F	Code T with 2x open, reverse operation
E	Exhausting
ED	Exhausting, switching position 14 detenting, 12 mechanical spring
EP	Exhausting, switching position 12 detenting, 14 mechanical spring
H	Code T with 1x open, 1x closed
W	Code T with 1x open, 1x closed, reverse operation
	Double solenoid valve

Type of reset

A	Pneumatic spring
M	Mechanical spring
	Double solenoid valve

Pilot air supply

Z	External
	Internal

Manual override

D	Non-detenting/detenting
H	Non-detenting (as valve variant)
	Covered (as valve variant)

Valve terminals VTSA/VTSA-F, NPT

Type code – Solenoid valves VSVA

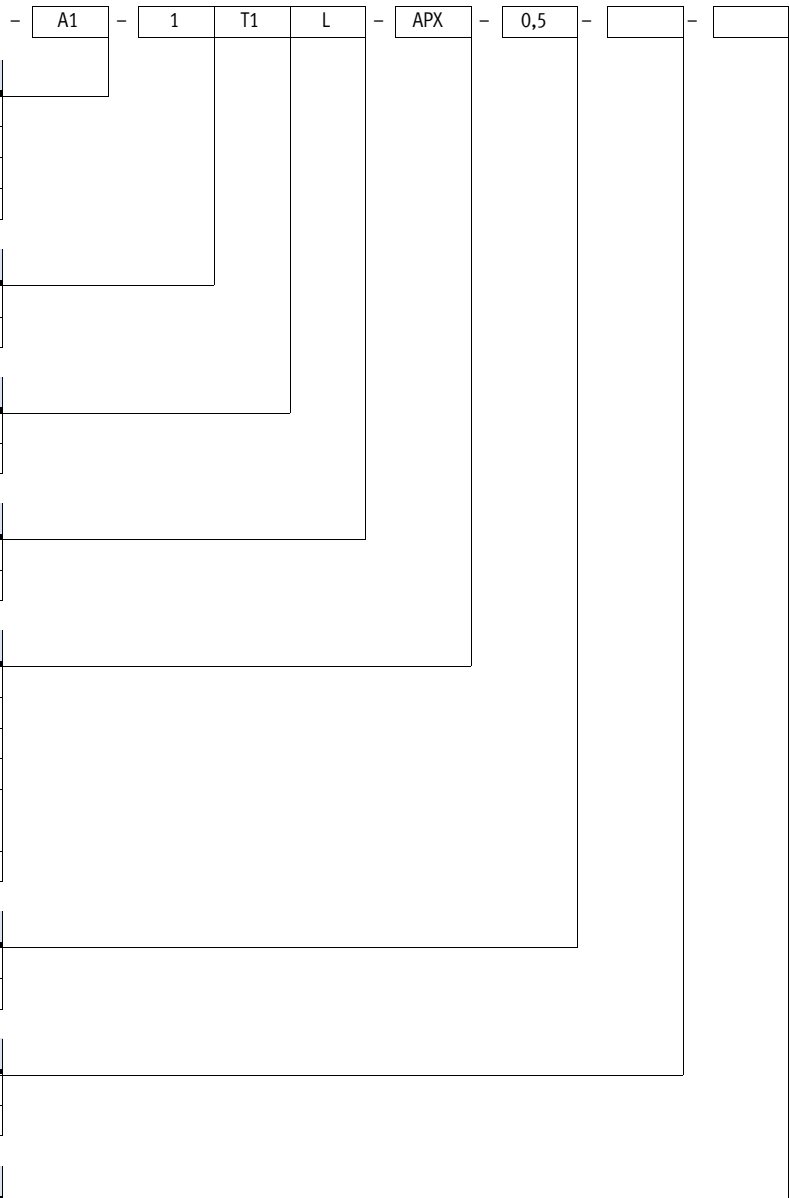

Standard

A1	ISO size 01, width 26 mm
A2	ISO size 02, width 18 mm
D1	ISO size 1, width 42 mm
D2	ISO size 2, width 52 mm

Operating voltage

1	24 V DC
2A	110 V AC

Electrical connection

T1	Plug-in (via valve terminal)
T2	PIN with separate loads (for Interlock)

Signal status display

L	LED (integrated)
	Without LED

Sensor characteristic

ANC	NPN with cable
ANP	NPN with plug connector M8
APC	PNP with cable
APP	PNP with plug connector M8
APX	PNP with connecting cable and plug connector M12
	Without sensor

Cable length

0,5	0.5 m
	2.5 m

EU certification

EX1E	II 3G installation in housing
	None

Component for EU certification

C	Compatible component
	Non-compatible component

Valve terminals VTSA/VTSA-F, NPT

Technical data – Solenoid valve, width 18 mm

FESTO

J - Valve width
to ISO 15407-2
18 mm

Q - Flow rate
Valve width 18 mm:
VTSA up to 550 l/min
VTSA-F up to 700 l/min

L - Voltage
24 V DC
110 V AC



Safety characteristics - Valve, width 18 mm		
Conforms to standard		EN 13849-1/2
Note on forced switch on/off		Min. 1/week
CE marking (see declaration of conformity)	110 V AC 24 V DC	To EU Low Voltage Directive In accordance with EU EMC Directive ¹⁾ (only solenoid valves with sensor)
Shock resistance		Shock test with severity level 2, to EN 60068-2-27
Vibration resistance		Transport application test with severity level 2, to EN 60068-2-6

1) For information about the applicability of the component see the manufacturer's EC declaration of conformity at: www.festo.com/sp → User documentation.
If the component is subject to restrictions on usage in residential, office or commercial environments or small businesses, further measures to reduce the emitted interference may be necessary.

Safety characteristics - Valve width 18 mm, 24 V DC			
Valve function (with valve code)	Terminal code	Test pulses	
		Max. positive test pulse with 0 signal [µs]	Max. negative test pulse with 1 signal [µs]
5/2-way, double solenoid (B52)	J	1500	800
5/2-way, double solenoid with dominant signal (D52)	D	1700	1200
5/2-way, single solenoid (M52-A)	M	1500	800
5/2-way, single solenoid (M52-M)	O	1500	800
5/3-way, closed (P53C)	G	1500	800
5/3-way, exhausted (P53E)	E	1500	800
5/3-way, pressurised (P53U)	B	1500	800
5/3-way, port 4 pressurised, port 2 exhausted, switching position 14 detenting (P53BD)	SD	1500	800
2x3/2-way, single solenoid, closed (T32C)	K	1700	1200
2x3/2-way, single solenoid, open (T32U)	N	1700	1200
2x3/2-way, single solenoid, open/closed (T32H)	H	1700	1200
2x3/2-way, single solenoid, closed (T32N)	Q	1700	1200
2x3/2-way, single solenoid, open (T32F)	P	1700	1200
2x3/2-way, single solenoid, open/closed (T32W)	R	1700	1200
2x2/2-way, single solenoid, closed (T22C)	VC	1700	1200
2x2/2-way, single solenoid, closed (T22CV)	VV	1700	1200

Valve terminals VTSA/VTSA-F, NPT

Technical data – Solenoid valve, width 18 mm

Technical data - Valve, width 18 mm							
Valve function (with valve code)	Terminal code	Flow direction			Type of reset		Weight [g]
		Any	Reversible only	Non-reversible	Pneumatic spring	Mechanical spring	
5/2-way, double solenoid (B52)	J	■	–	–	–	–	172
5/2-way, double solenoid with dominant signal (D52)	D	■	–	–	–	–	172
5/2-way, single solenoid (M52-A)	M	■	–	–	■	–	163
5/2-way, single solenoid (M52-M)	O	■	–	–	–	■	163
5/3-way, closed ¹⁾ (P53C)	G	■	–	–	–	■	191
5/3-way, exhausted ¹⁾ (P53E)	E	■	–	–	–	■	191
5/3-way, pressurised ¹⁾ (P53U)	B	■	–	–	–	■	191
5/3-way, port 4 pressurised, port 2 exhausted, switching position 14 detenting (P53BD)	SD	–	–	■	–	■	172
2x3/2-way, single solenoid, closed (T32C)	K	–	–	■	■	–	190
2x3/2-way, single solenoid, open (T32U)	N	–	–	■	■	–	190
2x3/2-way, single solenoid, open/closed (T32H)	H	–	–	■	■	–	190
2x3/2-way, single solenoid, closed (T32N)	Q	–	■	–	■	–	190
2x3/2-way, single solenoid, open (T32F)	P	–	■	–	■	–	190
2x3/2-way, single solenoid, open/closed (T32W)	R	–	■	–	■	–	190
2x2/2-way, single solenoid, closed (T22C)	VC	–	–	■	■	–	190
2x2/2-way, single solenoid, closed (T22CV)	VV	■	–	–	■	–	190

- 1) If neither solenoid coil is energised, the valve assumes its mid-position by means of spring force.
If both solenoid coils are energised at the same time, the valve remains in the previously assumed switching position.

Standard nominal flow rate - Valve/valve terminal [l/min], width 18 mm					
Valve function (with valve code)	Terminal code	Flow rate			
		Valve	Valve on valve terminal VTSA	Valve on valve terminal VTSA-F	Valve on individual sub-base
5/2-way, double solenoid (B52)	J	750	550	700	600
5/2-way, double solenoid with dominant signal (D52)	D	750	550	700	600
5/2-way, single solenoid (M52-A)	M	750	550	700	600
5/2-way, single solenoid (M52-M)	O	750	550	700	600
5/3-way, closed (P53C)	G	700	450	650	550
5/3-way, exhausted (P53E)	E	700 ¹⁾ 330 ²⁾	450 ¹⁾ 330 ²⁾	480 ¹⁾ 330 ²⁾	500 ¹⁾ 330 ²⁾
5/3-way, pressurised (P53U)	B	700 ¹⁾ 330 ²⁾	450 ¹⁾ 330 ²⁾	480 ¹⁾ 330 ²⁾	500 ¹⁾ 330 ²⁾
2x3/2-way, single solenoid, closed (T32C)	SD	600	400	550	500
5/3-way, port 4 pressurised, port 2 exhausted, switching position 14 detenting (P53BD)	K	–	370	430	400
2x3/2-way, single solenoid, open (T32U)	N	600	400	550	500
2x3/2-way, single solenoid, open/closed (T32H)	H	600	400	550	500
2x3/2-way, single solenoid, closed (T32N)	Q	600	400	550	500
2x3/2-way, single solenoid, open (T32F)	P	600	400	550	500
2x3/2-way, single solenoid, open/closed (T32W)	R	600	400	550	500
2x2/2-way, single solenoid, closed (T22C)	VC	700	500	650	500
2x2/2-way, single solenoid, closed (T22CV)	VV	700	500	650	500

- 1) Switching position
2) Mid-position

Valve terminals VTSA/VTSA-F, NPT

Technical data – Solenoid valve, width 18 mm

Valve switching times in [ms], width 18 mm, nominal operating voltage 24 V DC/110 V AC				
Valve function (with valve code)	Terminal code	On	Off	Changeover
5/2-way, double solenoid (B52)	J	–	–	11
5/2-way, double solenoid with dominant signal (D52)	D	–	–	13
5/2-way, single solenoid (M52-A)	M	22	28	–
5/2-way, single solenoid (M52-M)	O	12	38	–
5/3-way, closed (P53C)	G	15	44	–
5/3-way, exhausted (P53E)	E	15	44	–
5/3-way, pressurised (P53U)	B	15	44	–
5/3-way, port 4 pressurised, port 2 exhausted, switching position 14 detenting (P53BD)	SD	9/12 ¹⁾	28	–
2x3/2-way, single solenoid, closed (T32C)	K	12	30	–
2x3/2-way, single solenoid, open (T32U)	N	12	30	–
2x3/2-way, single solenoid, open/closed (T32H)	H	12	30	–
2x3/2-way, single solenoid, closed (T32N)	Q	25	12	–
2x3/2-way, single solenoid, open (T32F)	P	25	12	–
2x3/2-way, single solenoid, open/closed (T32W)	R	25	12	–
2x2/2-way, single solenoid, closed (T22C)	VC	12	30	–
2x2/2-way, single solenoid, closed (T22CV)	VV	12	30	–

1) Valve function (P53BD) 9 ms for control side 14, 12 ms for control side 12

Coil characteristics, width 18 mm			
Valve function (with valve code)	Terminal code	Coil characteristics at 24 V DC in [W]	Coil characteristics at 110/120 V AC in [VA]
5/2-way, double solenoid (B52)	J	1.6	1.6
5/2-way, double solenoid with dominant signal (D52)	D	1.3	1.0
5/2-way, single solenoid (M52-A)	M	1.6	1.6
5/2-way, single solenoid (M52-M)	O	1.6	1.6
5/3-way, closed (P53C)	G	1.6	1.6
5/3-way, exhausted (P53E)	E	1.6	1.6
5/3-way, pressurised (P53U)	B	1.6	1.6
5/3-way, port 4 pressurised, port 2 exhausted, switching position 14 detenting (P53BD)	SD	1.6	–
2x3/2-way, single solenoid, closed (T32C)	K	1.3	1.0
2x3/2-way, single solenoid, open (T32U)	N	1.3	1.0
2x3/2-way, single solenoid, open/closed (T32H)	H	1.3	1.0
2x3/2-way, single solenoid, closed (T32N)	Q	1.3	1.0
2x3/2-way, single solenoid, open (T32F)	P	1.3	1.0
2x3/2-way, single solenoid, open/closed (T32W)	R	1.3	1.0
2x2/2-way, single solenoid, closed (T22C)	VC	1.3	1.0
2x2/2-way, single solenoid, closed (T22CV)	VV	1.3	1.0

Materials	
Housing	Die-cast aluminium, PA
Seals	FPM, NBR, HNBR
Screws	Galvanised steel
Note on materials	RoHS-compliant

Valve terminals VTSA/VTSA-F, NPT

Ordering data – Solenoid valve 24 V DC

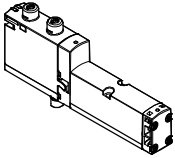
Ordering data – VSVA solenoid valve, MO non-detenting/detenting (D)						
	Terminal code	Valve function	Valve code	Width	Part No.	Type
Solenoid valves, 24 V DC						
	VC	2x 2/2-way valve, single solenoid, normally closed, pneumatic spring return	T22C	18 mm	561155	VSVA-B-T22C-AZD-A2-1T1L
	VV	2x 2/2-way valve, single solenoid, normally closed, pneumatic spring return, vacuum operation possible at 3 and 5	T22CV	18 mm	561159	VSVA-B-T22CV-AZD-A2-1T1L
	N	2x 3/2-way solenoid valve, single solenoid, normally open	T32U	18 mm	539178	VSVA-B-T32U-AZD-A2-1T1L
	K	2x 3/2-way solenoid valve, single solenoid, normally closed	T32C	18 mm	539176	VSVA-B-T32C-AZD-A2-1T1L
	H	2x 3/2-way solenoid valve, single solenoid, 1x normally open, 1x normally closed	T32H	18 mm	539180	VSVA-B-T32H-AZD-A2-1T1L
	P	2x 3/2-way solenoid valve, single solenoid, reverse operation, normally open	T32F	18 mm	539179	VSVA-B-T32F-AZD-A2-1T1L
	Q	2x 3/2-way solenoid valve, single solenoid, reverse operation, normally closed	T32N	18 mm	539177	VSVA-B-T32N-AZD-A2-1T1L
	R	2x 3/2-way solenoid valve, single solenoid, reverse operation, 1x normally open, 1x normally closed	T32W	18 mm	539181	VSVA-B-T32W-AZD-A2-1T1L
	M	5/2-way solenoid valve, single solenoid, pneumatic spring return	M52-A	18 mm	539184	VSVA-B-M52-AZD-A2-1T1L
	O	5/2-way solenoid valve, single solenoid, mechanical spring return	M52-M	18 mm	539185	VSVA-B-M52-MZD-A2-1T1L
	J	5/2-way solenoid valve, double solenoid	B52	18 mm	539182	VSVA-B-B52-ZD-A2-1T1L
	D	5/2-way solenoid valve, double solenoid, with dominant signal	D52	18 mm	539183	VSVA-B-D52-ZD-A2-1T1L
	B	5/3-way solenoid valve, mid-position pressurised	P53U	18 mm	539186	VSVA-B-P53U-ZD-A2-1T1L
	G	5/3-way solenoid valve, mid-position closed	P53C	18 mm	539188	VSVA-B-P53C-ZD-A2-1T1L
	E	5/3-way solenoid valve, mid-position exhausted	P53E	18 mm	539187	VSVA-B-P53E-ZD-A2-1T1L
SD	5/3-way solenoid valve, mid-position, port 4 pressurised, port 2 exhausted, switching position 14 detenting, 12 mechanical spring	P53BD	18 mm	8031817	VSVA-B-P53BD-ZD-A2-1T1L	

Valve terminals VTSA/VTSA-F, NPT

Ordering data – Solenoid valve 24 V DC

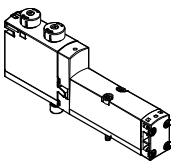
Ordering data – VSVA solenoid valve with cover cap for MO, non-detenting (H)						
	Terminal code	Valve function	Valve code	Width	Part No.	Type
Solenoid valves, 24 V DC						
	VC	2x 2/2-way valve, single solenoid, normally closed, pneumatic spring return	T22C	18 mm	8033475	VSVA-B-T22C-AZH-A2-1T1L
	VV	2x 2/2-way valve, single solenoid, normally closed, pneumatic spring return, vacuum operation possible at 3 and 5	T22CV	18 mm	8033476	VSVA-B-T22CV-AZH-A2-1T1L
	N	2x 3/2-way valve, single solenoid, normally open	T32U	18 mm	8033464	VSVA-B-T32U-AZH-A2-1T1L
	K	2x 3/2-way valve, single solenoid, normally closed	T32C	18 mm	8033462	VSVA-B-T32C-AZH-A2-1T1L
	H	2x 3/2-way valve, single solenoid, 1x normally open, 1x normally closed	T32H	18 mm	8033466	VSVA-B-T32H-AZH-A2-1T1L
	P	2x 3/2-way valve, single solenoid, reverse operation, normally open	T32F	18 mm	8033465	VSVA-B-T32F-AZH-A2-1T1L
	Q	2x 3/2-way valve, single solenoid, reverse operation, normally closed	T32N	18 mm	8033463	VSVA-B-T32N-AZH-A2-1T1L
	R	2x 3/2-way valve, single solenoid, reverse operation, 1x normally open, 1x normally closed	T32W	18 mm	8033467	VSVA-B-T32W-AZH-A2-1T1L
	M	5/2-way valve, single solenoid, pneumatic spring return	M52-A	18 mm	8033470	VSVA-B-M52-AZH-A2-1T1L
	O	5/2-way valve, single solenoid, mechanical spring return	M52-M	18 mm	8033471	VSVA-B-M52-MZH-A2-1T1L
	J	5/2-way valve, double solenoid	B52	18 mm	8033468	VSVA-B-B52-ZH-A2-1T1L
	D	5/2-way valve, double solenoid, dominant	D52	18 mm	8033469	VSVA-B-D52-ZH-A2-1T1L
	B	5/3-way solenoid valve, mid-position pressurised	P53U	18 mm	8033472	VSVA-B-P53U-ZH-A2-1T1L
	G	5/3-way solenoid valve, mid-position closed	P53C	18 mm	8033474	VSVA-B-P53C-ZH-A2-1T1L
	E	5/3-way solenoid valve, mid-position exhausted	P53E	18 mm	8033473	VSVA-B-P53E-ZH-A2-1T1L

Valve terminals VTSA/VTSA-F, NPT

Ordering data – Solenoid valve 24 V DC

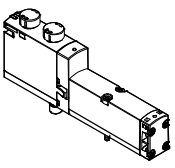
Ordering data – VSVA solenoid valve with cover cap for MO, covered						
	Terminal code	Valve function	Valve code	Width	Part No.	Type
Solenoid valves, 24 V DC						
	VC	2x 2/2-way valve, single solenoid, normally closed, pneumatic spring return	T22C	18 mm	8033493	VSVA-B-T22C-AZ-A2-1T1L
	VV	2x 2/2-way valve, single solenoid, normally closed, pneumatic spring return, vacuum operation possible at 3 and 5	T22CV	18 mm	8033494	VSVA-B-T22CV-AZ-A2-1T1L
	N	2x 3/2-way valve, single solenoid, normally open	T32U	18 mm	8033482	VSVA-B-T32U-AZ-A2-1T1L
	K	2x 3/2-way valve, single solenoid, normally closed	T32C	18 mm	8033480	VSVA-B-T32C-AZ-A2-1T1L
	H	2x 3/2-way valve, single solenoid, 1x normally open, 1x normally closed	T32H	18 mm	8033484	VSVA-B-T32H-AZ-A2-1T1L
	P	2x 3/2-way valve, single solenoid, reverse operation, normally open	T32F	18 mm	8033483	VSVA-B-T32F-AZ-A2-1T1L
	Q	2x 3/2-way valve, single solenoid, reverse operation, normally closed	T32N	18 mm	8033481	VSVA-B-T32N-AZ-A2-1T1L
	R	2x 3/2-way valve, single solenoid, reverse operation, 1x normally open, 1x normally closed	T32W	18 mm	8033485	VSVA-B-T32W-AZ-A2-1T1L
	M	5/2-way valve, single solenoid, pneumatic spring return	M52-A	18 mm	8033488	VSVA-B-M52-AZ-A2-1T1L
	O	5/2-way valve, single solenoid, mechanical spring return	M52-M	18 mm	8033489	VSVA-B-M52-MZ-A2-1T1L
	J	5/2-way valve, double solenoid	B52	18 mm	8033486	VSVA-B-B52-Z-A2-1T1L
	D	5/2-way valve, double solenoid, dominant	D52	18 mm	8033487	VSVA-B-D52-Z-A2-1T1L
	B	5/3-way solenoid valve, mid-position pressurised	P53U	18 mm	8033490	VSVA-B-P53U-Z-A2-1T1L
	G	5/3-way solenoid valve, mid-position closed	P53C	18 mm	8033492	VSVA-B-P53C-Z-A2-1T1L
E	5/3-way solenoid valve, mid-position exhausted	P53E	18 mm	8033491	VSVA-B-P53E-Z-A2-1T1L	

Valve terminals VTSA/VTSA-F, NPT

Ordering data – Solenoid valve 110/120 V AC

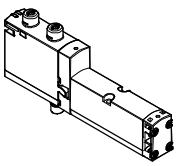
Ordering data – VSVA solenoid valve, MO non-detenting/detenting (D)						
	Terminal code	Valve function	Valve code	Width	Part No.	Type
Solenoid valves, 110/120 V AC						
	VC	2x 2/2-way valve, single solenoid, normally closed, pneumatic spring return	T22C	18 mm	561156	VSVA-B-T22C-AZD-A2-2AT1L
	VV	2x 2/2-way valve, single solenoid, normally closed, pneumatic spring return, vacuum operation possible at 3 and 5	T22CV	18 mm	561160	VSVA-B-T22CV-AZD-A2-2AT1L
	N	2x 3/2-way solenoid valve, single solenoid, normally open	T32U	18 mm	539165	VSVA-B-T32U-AZD-A2-2AT1L
	K	2x 3/2-way solenoid valve, single solenoid, normally closed	T32C	18 mm	539163	VSVA-B-T32C-AZD-A2-2AT1L
	H	2x 3/2-way solenoid valve, single solenoid, 1x normally open, 1x normally closed	T32H	18 mm	539167	VSVA-B-T32H-AZD-A2-2AT1L
	P	2x 3/2-way solenoid valve, single solenoid, reverse operation, normally open	T32F	18 mm	539166	VSVA-B-T32F-AZD-A2-2AT1L
	Q	2x 3/2-way solenoid valve, single solenoid, reverse operation, normally closed	T32N	18 mm	539164	VSVA-B-T32N-AZD-A2-2AT1L
	R	2x 3/2-way solenoid valve, single solenoid, reverse operation, 1x normally open, 1x normally closed	T32W	18 mm	539168	VSVA-B-T32W-AZD-A2-2AT1L
	M	5/2-way solenoid valve, single solenoid, pneumatic spring return	M52-A	18 mm	539171	VSVA-B-M52-AZD-A2-2AT1L
	O	5/2-way solenoid valve, single solenoid, mechanical spring return	M52-M	18 mm	539172	VSVA-B-M52-MZD-A2-2AT1L
	J	5/2-way solenoid valve, double solenoid	B52	18 mm	539169	VSVA-B-B52-ZD-A2-2AT1L
	D	5/2-way solenoid valve, double solenoid, with dominant signal	D52	18 mm	539170	VSVA-B-D52-ZD-A2-2AT1L
	B	5/3-way solenoid valve, mid-position pressurised	P53U	18 mm	539173	VSVA-B-P53U-ZD-A2-2AT1L
	G	5/3-way solenoid valve, mid-position closed	P53C	18 mm	539175	VSVA-B-P53C-ZD-A2-2AT1L
	E	5/3-way solenoid valve, mid-position exhausted	P53E	18 mm	539174	VSVA-B-P53E-ZD-A2-2AT1L

Valve terminals VTSA/VTSA-F, NPT

Technical data – Solenoid valve, width 26 mm

FESTO

-  - Valve width
to ISO 15407-2
26 mm

-  - Flow rate
Valve width 26 mm:
VTSA up to 1100 l/min
VTSA-F up to 1350 l/min

-  - Voltage
24 V DC
110 V AC



Safety characteristics - Valve, width 26 mm

Conforms to standard	EN 13849-1/2
Note on forced switch on/off	Min. 1/week
CE marking (see declaration of conformity)	110 V AC 24 V DC
	To EU Low Voltage Directive In accordance with EU EMC Directive ¹⁾ (only solenoid valves with sensor)
Shock resistance	Shock test with severity level 2, to EN 60068-2-27
Vibration resistance	Transport application test with severity level 2, to EN 60068-2-6

1) For information about the applicability of the component see the manufacturer's EC declaration of conformity at: www.festo.com/sp → User documentation.
If the component is subject to restrictions on usage in residential, office or commercial environments or small businesses, further measures to reduce the emitted interference may be necessary.

Safety characteristics - Valve, width 26 mm, 24 V DC

Valve function (with valve code)	Terminal code	Test pulses	
		Max. positive test pulse with 0 signal [µs]	Max. negative test pulse with 1 signal [µs]
5/2-way, double solenoid (B52)	J	1200	800
5/2-way, double solenoid with dominant signal (D52)	D	1500	1200
5/2-way, single solenoid (M52-A)	M	1200	800
5/2-way, single solenoid (M52-M)	O	1200	800
5/3-way, closed (P53C)	G	1200	800
5/3-way, exhausted (P53E)	E	1200	800
5/3-way, pressurised (P53U)	B	1200	800
5/3-way, exhausted, switching position 14 detenting (P53ED)	SA	1200	1100
5/3-way, exhausted, switching position 12 detenting (P53EP)	SE	1200	1000
5/3-way, port 2 pressurised, 4 exhausted, switching position 14 detenting (P53AD)	SB	1200	1100
2x3/2-way, single solenoid, closed (T32C)	K	1500	1200
2x3/2-way, single solenoid, open (T32U)	N	1500	1200
2x3/2-way, single solenoid, open/closed (T32H)	H	1500	1200
2x3/2-way, single solenoid, closed (T32N)	Q	1500	1200
2x3/2-way, single solenoid, open (T32F)	P	1500	1200
2x3/2-way, single solenoid, open/closed (T32W)	R	1500	1200
2x2/2-way, single solenoid, closed (T22C)	VC	1500	1200
2x2/2-way, single solenoid, closed (T22CV)	VV	1500	1200

Valve terminals VTSA/VTSA-F, NPT

Technical data – Solenoid valve, width 26 mm

Technical data - Valve, width 26 mm							
Valve function (with valve code)	Terminal code	Flow direction			Type of reset		Weight [g]
		Any	Reversible only	Non-reversible	Pneumatic spring	Mechanical spring	
5/2-way, double solenoid (B52)	J	■	–	–	–	–	276
5/2-way, double solenoid with dominant signal (D52)	D	■	–	–	–	–	276
5/2-way, single solenoid (M52-A)	M	■	–	–	■	–	293
5/2-way, single solenoid (M52-M)	O	■	–	–	–	■	293
5/3-way, closed ¹⁾ (P53C)	G	■	–	–	–	■	320
5/3-way, exhausted ¹⁾ (P53E)	E	■	–	–	–	■	320
5/3-way, pressurised ¹⁾ (P53U)	B	■	–	–	–	■	320
5/3-way, exhausted, switching position 14 detenting (P53ED)	SA	–	–	■	–	■	291
5/3-way, exhausted, switching position 12 detenting (P53EP)	SE	–	–	■	–	■	291
5/3-way, port 2 pressurised, 4 exhausted, switching position 14 detenting (P53AD)	SB	■	–	–	–	■	301
2x3/2-way, single solenoid, closed (T32C)	K	–	–	■	■	–	335
2x3/2-way, single solenoid, open (T32U)	N	–	–	■	■	–	335
2x3/2-way, single solenoid, open/closed (T32H)	H	–	–	■	■	–	335
2x3/2-way, single solenoid, closed (T32N)	Q	–	■	–	■	–	335
2x3/2-way, single solenoid, open (T32F)	P	–	■	–	■	–	335
2x3/2-way, single solenoid, open/closed (T32W)	R	–	■	–	■	–	335
2x2/2-way, single solenoid, closed (T22C)	VC	–	–	■	■	–	335
2x2/2-way, single solenoid, closed (T22CV)	VV	■	–	–	■	–	335

- 1) If neither solenoid coil is energised, the valve assumes its mid-position by means of spring force.
If both solenoid coils are energised at the same time, the valve remains in the previously assumed switching position.

Standard nominal flow rate - Valve/valve terminal [l/min], width 26 mm					
Valve function (with valve code)	Terminal code	Flow rate			
		Valve	Valve on valve terminal VTSA	Valve on valve terminal VTSA-F	Valve on individual sub-base
5/2-way, double solenoid (B52)	J	1400	1100	1350	1200
5/2-way, double solenoid with dominant signal (D52)	D	1400	1100	1350	1200
5/2-way, single solenoid (M52-A)	M	1400	1100	1350	1200
5/2-way, single solenoid (M52-M)	O	1400	1100	1350	1200
5/3-way, closed (P53C)	G	1400 ¹⁾ 700 ²⁾	1000 ¹⁾ 700 ²⁾	1350 ¹⁾ 700 ²⁾	1200 ¹⁾ 700 ²⁾
5/3-way, exhausted (P53E)	E	1400 ¹⁾ 700 ²⁾	1000 ¹⁾ 700 ²⁾	1350 ¹⁾ 700 ²⁾	1200 ¹⁾ 700 ²⁾
5/3-way, pressurised (P53U)	B	1400 ¹⁾ 700 ²⁾	1000 ¹⁾ 700 ²⁾	1350 ¹⁾ 700 ²⁾	1200 ¹⁾ 700 ²⁾
5/3-way, exhausted, switching position 14 detenting (P53ED)	SA	1400 ¹⁾ 700 ²⁾	1000 ¹⁾ 700 ²⁾	1350 ¹⁾ 700 ²⁾	1200 ¹⁾ 700 ²⁾
5/3-way, exhausted, switching position 12 detenting (P53EP)	SE	1400 ¹⁾ 700 ²⁾	1000 ¹⁾ 700 ²⁾	1350 ¹⁾ 700 ²⁾	1200 ¹⁾ 700 ²⁾
5/3-way, port 2 pressurised, 4 exhausted, switching position 14 detenting (P53AD)	SB	700 ¹⁾ 700 ²⁾	700 ¹⁾ 700 ²⁾	700 ¹⁾ 700 ²⁾	700 ¹⁾ 700 ²⁾
2x3/2-way, single solenoid, closed (T32C)	K	1250	900	1150	1100
2x3/2-way, single solenoid, open (T32U)	N	1250	900	1150	1100
2x3/2-way, single solenoid, open/closed (T32H)	H	1250	900	1150	1100
2x3/2-way, single solenoid, closed (T32N)	Q	1250	900	1150	1100
2x3/2-way, single solenoid, open (T32F)	P	1250	900	1150	1100
2x3/2-way, single solenoid, open/closed (T32W)	R	1250	900	1150	1100
2x2/2-way, single solenoid, closed (T22C)	VC	1350	1000	1300	1100
2x2/2-way, single solenoid, closed (T22CV)	VV	1350	1000	1300	1100

- 1) Switching position
2) Mid-position

Valve terminals VTSA/VTSA-F, NPT

Technical data – Solenoid valve, width 26 mm

Valve switching times in [ms], width 26 mm, nominal operating voltage 24 V DC/110 V AC				
Valve function (with valve code)	Terminal code	On	Off	Changeover
5/2-way, double solenoid (B52)	J	–	–	18
5/2-way, double solenoid with dominant signal (D52)	D	–	–	21
5/2-way, single solenoid (M52-A)	M	25	45	–
5/2-way, single solenoid (M52-M)	O	20	65	–
5/3-way, closed (P53C)	G	22	65	–
5/3-way, exhausted (P53E)	E	22	65	–
5/3-way, pressurised (P53U)	B	22	65	–
5/3-way, exhausted, switching position 14 detenting (P53ED)	SA	9/22 ¹⁾	49 ³⁾	33
5/3-way, exhausted, switching position 12 detenting (P53EP)	SE	–	–	–
5/3-way, port 2 pressurised, 4 exhausted, switching position 14 detenting (P53AD)	SB	9/19 ²⁾	36 ³⁾	32
2x3/2-way, single solenoid, closed (T32C)	K	20	38	–
2x3/2-way, single solenoid, open (T32U)	N	20	38	–
2x3/2-way, single solenoid, open/closed (T32H)	H	20	38	–
2x3/2-way, single solenoid, closed (T32N)	Q	32	30	–
2x3/2-way, single solenoid, open (T32F)	P	32	30	–
2x3/2-way, single solenoid, open/closed (T32W)	R	32	30	–
2x2/2-way, single solenoid, closed (T22C)	VC	20	38	–
2x2/2-way, single solenoid, closed (T22CV)	VV	20	38	–

1) Valve function (P53ED) switching time 22 ms for control side 12, 9 ms for control side 14

2) Valve function (P53AD) switching time 19 ms for control side 12, 9 ms for control side 14

3) For control side 12

Coil characteristics, width 26 mm			
Valve function (with valve code)	Terminal code	Coil characteristics at 24 V DC in [W]	Coil characteristics at 110/120 V AC in [VA]
5/2-way, double solenoid (B52)	J	1.6	1.6
5/2-way, double solenoid with dominant signal (D52)	D	1.3	1.0
5/2-way, single solenoid (M52-A)	M	1.6	1.6
5/2-way, single solenoid (M52-M)	O	1.6	1.6
5/3-way, closed (P53C)	G	1.6	1.6
5/3-way, exhausted (P53E)	E	1.6	1.6
5/3-way, pressurised (P53U)	B	1.6	1.6
5/3-way, exhausted, switching position 14 detenting (P53ED)	SA	1.6	1.6
5/3-way, exhausted, switching position 12 detenting (P53EP)	SE	1.6	–
5/3-way, port 2 pressurised, 4 exhausted, switching position 14 detenting (P53AD)	SB	1.6	1.6
2x3/2-way, single solenoid, closed (T32C)	K	1.3	1.0
2x3/2-way, single solenoid, open (T32U)	N	1.3	1.0
2x3/2-way, single solenoid, open/closed (T32H)	H	1.3	1.0
2x3/2-way, single solenoid, closed (T32N)	Q	1.3	1.0
2x3/2-way, single solenoid, open (T32F)	P	1.3	1.0
2x3/2-way, single solenoid, open/closed (T32W)	R	1.3	1.0
2x2/2-way, single solenoid, closed (T22C)	VC	1.3	1.0
2x2/2-way, single solenoid, closed (T22CV)	VV	1.3	1.0

Materials	
Housing	Die-cast aluminium, PA
Seals	FPM, NBR, HNBR
Screws	Galvanised steel
Note on materials	RoHS-compliant

Valve terminals VTSA/VTSA-F, NPT

Ordering data – Solenoid valve 24 V DC

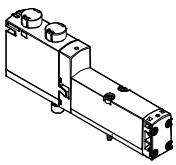
Ordering data – VSVA solenoid valve, MO non-detenting/detenting (D)						
	Terminal code	Valve function	Valve code	Width	Part No.	Type
Solenoid valves, 24 V DC						
	VC	2x 2/2-way valve, single solenoid, normally closed, pneumatic spring return	T22C	26 mm	561149	VSVA-B-T22C-AZD-A1-1T1L
	VV	2x 2/2-way valve, single solenoid, normally closed, pneumatic spring return, vacuum operation possible at 3 and 5	T22CV	26 mm	561153	VSVA-B-T22CV-AZD-A1-1T1L
	N	2x 3/2-way valve, single solenoid, normally open	T32U	26 mm	539152	VSVA-B-T32U-AZD-A1-1T1L
	K	2x 3/2-way valve, single solenoid, normally closed	T32C	26 mm	539150	VSVA-B-T32C-AZD-A1-1T1L
	H	2x 3/2-way valve, single solenoid, 1x normally open, 1x normally closed	T32H	26 mm	539154	VSVA-B-T32H-AZD-A1-1T1L
	P	2x 3/2-way valve, single solenoid, reverse operation, normally open	T32F	26 mm	539153	VSVA-B-T32F-AZD-A1-1T1L
	Q	2x 3/2-way valve, single solenoid, reverse operation, normally closed	T32N	26 mm	539151	VSVA-B-T32N-AZD-A1-1T1L
	R	2x 3/2-way valve, single solenoid, reverse operation, 1x normally open, 1x normally closed	T32W	26 mm	539155	VSVA-B-T32W-AZD-A1-1T1L
	M	5/2-way valve, single solenoid, pneumatic spring return	M52-A	26 mm	539158	VSVA-B-M52-AZD-A1-1T1L
	O	5/2-way valve, single solenoid, mechanical spring return	M52-M	26 mm	539159	VSVA-B-M52-MZD-A1-1T1L
	J	5/2-way valve, double solenoid	B52	26 mm	539156	VSVA-B-B52-ZD-A1-1T1L
	D	5/2-way valve, double solenoid, with dominant signal	D52	26 mm	539157	VSVA-B-D52-ZD-A1-1T1L
	B	5/3-way valve, mid-position pressurised	P53U	26 mm	539160	VSVA-B-P53U-ZD-A1-1T1L
	G	5/3-way valve, mid-position closed	P53C	26 mm	539162	VSVA-B-P53C-ZD-A1-1T1L
	E	5/3-way valve, mid-position exhausted	P53E	26 mm	539161	VSVA-B-P53E-ZD-A1-1T1L
	SA	5/3-way valve, mid-position exhausted, switching position 14 detenting, mechanical spring return	P53ED	26 mm	560727	VSVA-B-P53ED-ZD-A1-1T1L
	SE	5/3-way valve, mid-position exhausted, switching position 12 detenting, mechanical spring return	P53EP	26 mm	8026638	VSVA-B-P53EP-ZD-A1-1T1L
	SB	5/3-way solenoid valve, mid-position 1x exhausted from 4 to 5, 1x pressurised from 1 to 2, switching position 14 detenting, same function in both switching positions: pressurised from 1 to 4 and exhausted from 2 to 3, mechanical spring return	P53AD	26 mm	560728	VSVA-B-P53AD-ZD-A1-1T1L

Valve terminals VTSA/VTSA-F, NPT

Ordering data – Solenoid valve 24 V DC

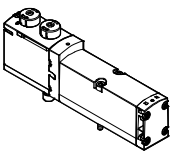
Ordering data – VSVA solenoid valve with cover cap for MO, non-detenting (H)						
	Terminal code	Valve function	Valve code	Width	Part No.	Type
Solenoid valves, 24 V DC						
	VC	2x 2/2-way valve, single solenoid, normally closed, pneumatic spring return	T22C	26 mm	8033055	VSVA-B-T22C-AZH-A1-1T1L
	VV	2x 2/2-way valve, single solenoid, normally closed, pneumatic spring return, vacuum operation possible at 3 and 5	T22CV	26 mm	8033056	VSVA-B-T22CV-AZH-A1-1T1L
	N	2x 3/2-way valve, single solenoid, normally open	T32U	26 mm	8033038	VSVA-B-T32U-AZH-A1-1T1L
	K	2x 3/2-way valve, single solenoid, normally closed	T32C	26 mm	8033036	VSVA-B-T32C-AZH-A1-1T1L
	H	2x 3/2-way valve, single solenoid, 1x normally open, 1x normally closed	T32H	26 mm	8033040	VSVA-B-T32H-AZH-A1-1T1L
	P	2x 3/2-way valve, single solenoid, reverse operation, normally open	T32F	26 mm	8033039	VSVA-B-T32F-AZH-A1-1T1L
	Q	2x 3/2-way valve, single solenoid, reverse operation, normally closed	T32N	26 mm	8033037	VSVA-B-T32N-AZH-A1-1T1L
	R	2x 3/2-way valve, single solenoid, reverse operation, 1x normally open, 1x normally closed	T32W	26 mm	8033041	VSVA-B-T32W-AZH-A1-1T1L
	M	5/2-way valve, single solenoid, pneumatic spring return	M52-A	26 mm	8033044	VSVA-B-M52-AZH-A1-1T1L
	O	5/2-way valve, single solenoid, mechanical spring return	M52-M	26 mm	8033045	VSVA-B-M52-MZH-A1-1T1L
	J	5/2-way valve, double solenoid	B52	26 mm	8033042	VSVA-B-B52-ZH-A1-1T1L
	D	5/2-way valve, double solenoid, dominant	D52	26 mm	8033043	VSVA-B-D52-ZH-A1-1T1L
	B	5/3-way solenoid valve, mid-position pressurised	P53U	26 mm	8033046	VSVA-B-P53U-ZH-A1-1T1L
	G	5/3-way solenoid valve, mid-position closed	P53C	26 mm	8033048	VSVA-B-P53C-ZH-A1-1T1L
	E	5/3-way solenoid valve, mid-position exhausted	P53E	26 mm	8033047	VSVA-B-P53E-ZH-A1-1T1L
	SA	5/3-way solenoid valve, mid-position exhausted, switching position 14 detenting, mechanical spring return	P53ED	26 mm	8033051	VSVA-B-P53ED-ZH-A1-1T1L
	SE	5/3-way solenoid valve, mid-position exhausted, switching position 12 detenting, mechanical spring return	P53EP	26 mm	8033058	VSVA-B-P53EP-ZH-A1-1T1L
SB	5/3-way solenoid valve, mid-position 1x exhausted from 4 to 5, 1x pressurised from 1 to 2, switching position 14 detenting, same function in both switching positions: pressurised from 1 to 4 and exhausted from 2 to 3, mechanical spring return	P53AD	26 mm	8033052	VSVA-B-P53AD-ZH-A1-1T1L	

Valve terminals VTSA/VTSA-F, NPT

Ordering data – Solenoid valve 24 V DC

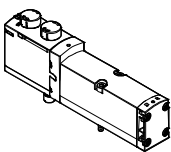
Ordering data – VSVA solenoid valve with cover cap for MO, covered						
	Terminal code	Valve function	Valve code	Width	Part No.	Type
Solenoid valves, 24 V DC						
	VC	2x 2/2-way valve, single solenoid, normally closed, pneumatic spring return	T22C	26 mm	8033078	VSVA-B-T22C-AZ-A1-1T1L
	VV	2x 2/2-way valve, single solenoid, normally closed, pneumatic spring return, vacuum operation possible at 3 and 5	T22CV	26 mm	8033079	VSVA-B-T22CV-AZ-A1-1T1L
	N	2x 3/2-way valve, single solenoid, normally open	T32U	26 mm	8033061	VSVA-B-T32U-AZ-A1-1T1L
	K	2x 3/2-way valve, single solenoid, normally closed	T32C	26 mm	8033059	VSVA-B-T32C-AZ-A1-1T1L
	H	2x 3/2-way valve, single solenoid, 1x normally open, 1x normally closed	T32H	26 mm	8033063	VSVA-B-T32H-AZ-A1-1T1L
	P	2x 3/2-way valve, single solenoid, reverse operation, normally open	T32F	26 mm	8033062	VSVA-B-T32F-AZ-A1-1T1L
	Q	2x 3/2-way valve, single solenoid, reverse operation, normally closed	T32N	26 mm	8033060	VSVA-B-T32N-AZ-A1-1T1L
	R	2x 3/2-way valve, single solenoid, reverse operation, 1x normally open, 1x normally closed	T32W	26 mm	8033064	VSVA-B-T32W-AZ-A1-1T1L
	M	5/2-way valve, single solenoid, pneumatic spring return	M52-A	26 mm	8033067	VSVA-B-M52-AZ-A1-1T1L
	O	5/2-way valve, single solenoid, mechanical spring return	M52-M	26 mm	8033068	VSVA-B-M52-MZ-A1-1T1L
	J	5/2-way valve, double solenoid	B52	26 mm	8033065	VSVA-B-B52-Z-A1-1T1L
	D	5/2-way valve, double solenoid, dominant	D52	26 mm	8033066	VSVA-B-D52-Z-A1-1T1L
	B	5/3-way solenoid valve, mid-position pressurised	P53U	26 mm	8033069	VSVA-B-P53U-Z-A1-1T1L
	G	5/3-way solenoid valve, mid-position closed	P53C	26 mm	8033071	VSVA-B-P53C-Z-A1-1T1L
	E	5/3-way solenoid valve, mid-position exhausted	P53E	26 mm	8033070	VSVA-B-P53E-Z-A1-1T1L
	SA	5/3-way solenoid valve, mid-position exhausted, switching position 14 detenting, mechanical spring return	P53ED	26 mm	8033074	VSVA-B-P53ED-Z-A1-1T1L
	SE	5/3-way solenoid valve, mid-position exhausted, switching position 12 detenting, mechanical spring return	P53EP	26 mm	8033081	VSVA-B-P53EP-Z-A1-1T1L
SB	5/3-way solenoid valve, mid-position 1x exhausted from 4 to 5, 1x pressurised from 1 to 2, switching position 14 detenting, same function in both switching positions: pressurised from 1 to 4 and exhausted from 2 to 3, mechanical spring return	P53AD	26 mm	8033075	VSVA-B-P53AD-Z-A1-1T1L	

Valve terminals VTSA/VTSA-F, NPT

Ordering data – Solenoid valve 110/120 V AC

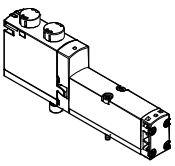
Ordering data – VSVA solenoid valve, MO non-detenting/detenting (D)						
	Terminal code	Valve function	Valve code	Width	Part No.	Type
Solenoid valves, 110/120 V AC						
	VC	2x 2/2-way valve, single solenoid, normally closed, pneumatic spring return	T22C	26 mm	561150	VSVA-B-T22C-AZD-A1-2AT1L
	VV	2x 2/2-way valve, single solenoid, normally closed, pneumatic spring return, vacuum operation possible at 3 and 5	T22CV	26 mm	561154	VSVA-B-T22CV-AZD-A1-2AT1L
	N	2x 3/2-way valve, single solenoid, normally open	T32U	26 mm	539139	VSVA-B-T32U-AZD-A1-2AT1L
	K	2x 3/2-way valve, single solenoid, normally closed	T32C	26 mm	539137	VSVA-B-T32C-AZD-A1-2AT1L
	H	2x 3/2-way valve, single solenoid, 1x normally open, 1x normally closed	T32H	26 mm	539141	VSVA-B-T32H-AZD-A1-2AT1L
	P	2x 3/2-way valve, single solenoid, reverse operation, normally open	T32F	26 mm	539140	VSVA-B-T32F-AZD-A1-2AT1L
	Q	2x 3/2-way valve, single solenoid, reverse operation, normally closed	T32N	26 mm	539138	VSVA-B-T32N-AZD-A1-2AT1L
	R	2x 3/2-way valve, single solenoid, reverse operation, 1x normally open, 1x normally closed	T32W	26 mm	539142	VSVA-B-T32W-AZD-A1-2AT1L
	M	5/2-way valve, single solenoid, pneumatic spring return	M52-A	26 mm	539145	VSVA-B-M52-AZD-A1-2AT1L
	O	5/2-way valve, single solenoid, mechanical spring return	M52-M	26 mm	539146	VSVA-B-M52-MZD-A1-2AT1L
	J	5/2-way valve, double solenoid	B52	26 mm	539143	VSVA-B-B52-ZD-A1-2AT1L
	D	5/2-way valve, double solenoid, with dominant signal	D52	26 mm	539144	VSVA-B-D52-ZD-A1-2AT1L
	B	5/3-way valve, mid-position pressurised	P53U	26 mm	539147	VSVA-B-P53U-ZD-A1-2AT1L
	G	5/3-way valve, mid-position closed	P53C	26 mm	539149	VSVA-B-P53C-ZD-A1-2AT1L
	E	5/3-way valve, mid-position exhausted	P53E	26 mm	539148	VSVA-B-P53E-ZD-A1-2AT1L

Valve terminals VTSA/VTSA-F, NPT

Technical data – Solenoid valve, width 42 mm



- - Valve width to ISO 5599-2
42 mm (ISO 1)

- - Flow rate
Valve width 42 mm:
VTSA up to 1300 l/min
VTSA-F up to 1860 l/min

- - Voltage
24 V DC
110 V AC



Safety characteristics - Valve, width 42 mm	
Conforms to standard	EN 13849-1/2
Note on forced switch on/off	Min. 1/week
CE marking (see 110 V AC declaration of conformity)	To EU Low Voltage Directive
Shock resistance	Shock test with severity level 2, to EN 60068-2-27
Vibration resistance	Transport application test with severity level 2, to EN 60068-2-6

Safety characteristics - Valve, width 42 mm, 24 V DC			
Valve function (with valve code)	Terminal code	Test pulses	
		Max. positive test pulse with 0 signal [µs]	Max. negative test pulse with 1 signal [µs]
5/2-way, double solenoid (B52)	J	1400	900
5/2-way, double solenoid with dominant signal (D52)	D	1600	1100
5/2-way, single solenoid (M52-A)	M	1400	900
5/2-way, single solenoid (M52-M)	O	1400	900
5/3-way, closed (P53C)	G	1400	900
5/3-way, exhausted (P53E)	E	1400	900
5/3-way, pressurised (P53U)	B	1400	900
5/3-way, pressurised 1 to 2, 4 to 5 closed (P53F)	VG	–	–
2x3/2-way, single solenoid, closed (T32C)	K	1600	1100
2x3/2-way, single solenoid, open (T32U)	N	1600	1100
2x3/2-way, single solenoid, open/closed (T32H)	H	1600	1100
2x3/2-way, single solenoid, closed (T32N)	Q	1600	1100
2x3/2-way, single solenoid, open (T32F)	P	1600	1100
2x3/2-way, single solenoid, open/closed (T32W)	R	1600	1100
2x2/2-way, single solenoid, closed (T22C)	VC	1600	1100
2x2/2-way, single solenoid, closed (T22CV)	VV	1600	1100

Valve terminals VTSA/VTSA-F, NPT

Technical data – Solenoid valve, width 42 mm

Valve technical data, width 42 mm							
Valve function (with valve code)	Terminal code	Flow direction			Type of reset		Weight [g]
		Any	Reversible only	Non-reversible	Pneumatic spring	Mechanical spring	
5/2-way, double solenoid (B52)	J	■	–	–	–	–	439
5/2-way, double solenoid with dominant signal (D52)	D	■	–	–	–	–	439
5/2-way, single solenoid (M52-A)	M	■	–	–	■	–	426
5/2-way, single solenoid (M52-M)	O	■	–	–	–	■	426
5/3-way, closed ¹⁾ (P53C)	G	■	–	–	–	■	456
5/3-way, exhausted ¹⁾ (P53E)	E	■	–	–	–	■	456
5/3-way, pressurised ¹⁾ (P53U)	B	■	–	–	–	■	456
5/3-way, pressurised 1 to 2, 4 to 5 closed (P53F)	VG	■	–	–	–	–	456
2x3/2-way, single solenoid, closed (T32C)	K	–	–	■	■	–	442
2x3/2-way, single solenoid, open (T32U)	N	–	–	■	■	–	442
2x3/2-way, single solenoid, open/closed (T32H)	H	–	–	■	■	–	442
2x3/2-way, single solenoid, closed (T32N)	Q	–	■	–	■	–	442
2x3/2-way, single solenoid, open (T32F)	P	–	■	–	■	–	442
2x3/2-way, single solenoid, open/closed (T32W)	R	–	■	–	■	–	442
2x2/2-way, single solenoid, closed (T22C)	VC	–	–	■	■	–	442
2x2/2-way, single solenoid, closed (T22CV)	VV	■	–	–	■	–	442

- 1) If neither solenoid coil is energised, the valve assumes its mid-position by means of spring force.
If both solenoid coils are energised at the same time, the valve remains in the previously assumed switching position.

Standard nominal flow rate - Valve/valve terminal [l/min], width 42 mm					
Valve function (with valve code)	Terminal code	Flow rate			
		Valve	Valve on valve terminal VTSA	Valve on valve terminal VTSA-F	Valve on individual sub-base
5/2-way, double solenoid (B52)	J	2000	1300	1860	1500
5/2-way, double solenoid with dominant signal (D52)	D	2000	1300	1860	1500
5/2-way, single solenoid (M52-A)	M	2000	1300	1860	1500
5/2-way, single solenoid (M52-M)	O	2000	1300	1860	1500
5/3-way, closed (P53C)	G	1900 ¹⁾ 950 ²⁾	1200 ¹⁾ 800 ²⁾	1690 ¹⁾ 830 ²⁾	1400 ¹⁾ 800 ²⁾
5/3-way, exhausted (P53E)	E	1900 ¹⁾ 950 ²⁾	1200 ¹⁾ 800 ²⁾	1690 ¹⁾ 830 ²⁾	1400 ¹⁾ 800 ²⁾
5/3-way, pressurised (P53U)	B	1900 ¹⁾ 950 ²⁾	1200 ¹⁾ 800 ²⁾	1690 ¹⁾ 830 ²⁾	1400 ¹⁾ 800 ²⁾
5/3-way, pressurised 1 to 2, 4 to 5 closed (P53F)	VG	1700 ¹⁾ 700 ²⁾	1400 ¹⁾ 800 ²⁾	1700 ¹⁾ 700 ²⁾	1400 ¹⁾ 700 ²⁾
2x3/2-way, single solenoid, closed (T32C)	K	1600	1200	1300	1200
2x3/2-way, single solenoid, open (T32U)	N	1600	1200	1300	1200
2x3/2-way, single solenoid, open/closed (T32H)	H	1600	1200	1300	1200
2x3/2-way, single solenoid, closed (T32N)	Q	1600	1200	1300	1200
2x3/2-way, single solenoid, open (T32F)	P	1600	1200	1300	1200
2x3/2-way, single solenoid, open/closed (T32W)	R	1600	1200	1300	1200
2x2/2-way, single solenoid, closed (T22C)	VC	1600	1400	1500	1400
2x2/2-way, single solenoid, closed (T22CV)	VV	1600	1400	1500	1400

- 1) Switching position
2) Mid-position

Valve terminals VTSA/VTSA-F, NPT

FESTO

Technical data – Solenoid valve, width 42 mm

Valve switching times in [ms], width 42 mm, nominal operating voltage 24 V DC/110 V AC							
Valve function (with valve code)	Terminal code	24 V DC			110 V AC		
		On	Off	Changeover	On	Off	
5/2-way, double solenoid (B52)	J	–	–	16	–	–	16
5/2-way, double solenoid with dominant signal (D52)	D	–	–	19	–	–	19
5/2-way, single solenoid (M52-A)	M	27	45	–	20	55	–
5/2-way, single solenoid (M52-M)	O	22	60	–	20	55	–
5/3-way, closed (P53C)	G	22	65	38	22	68	41
5/3-way, exhausted (P53E)	E	22	65	38	22	68	41
5/3-way, pressurised (P53U)	B	22	65	38	22	68	41
5/3-way, pressurised 1 to 2, 4 to 5 closed (P53F)	VG	22	65	38	–	–	–
2x3/2-way, single solenoid, closed (T32C)	K	20	38	–	22	46	–
2x3/2-way, single solenoid, open (T32U)	N	20	38	–	22	46	–
2x3/2-way, single solenoid, open/closed (T32H)	H	20	38	–	22	46	–
2x3/2-way, single solenoid, closed (T32N)	Q	34	28	–	34	38	–
2x3/2-way, single solenoid, open (T32F)	P	34	28	–	34	38	–
2x3/2-way, single solenoid, open/closed (T32W)	R	34	28	–	34	38	–
2x2/2-way, single solenoid, closed (T22C)	VC	20	38	–	22	46	–
2x2/2-way, single solenoid, closed (T22CV)	VV	20	38	–	22	46	–

Coil characteristics for width 42 mm			
Valve function (with valve code)	Terminal code	Coil characteristics at 24 V DC in [W]	Coil characteristics at 110/120 V AC in [VA]
5/2-way, double solenoid (B52)	J	1.6	1.6
5/2-way, double solenoid with dominant signal (D52)	D	1.3	1.0
5/2-way, single solenoid (M52-A)	M	1.6	1.6
5/2-way, single solenoid (M52-M)	O	1.6	1.6
5/3-way, closed (P53C)	G	1.6	1.6
5/3-way, exhausted (P53E)	E	1.6	1.6
5/3-way, pressurised (P53U)	B	1.6	1.6
5/3-way, pressurised 1 to 2, 4 to 5 closed (P53F)	VG	1.6	–
2x3/2-way, single solenoid, closed (T32C)	K	1.3	1.0
2x3/2-way, single solenoid, open (T32U)	N	1.3	1.0
2x3/2-way, single solenoid, open/closed (T32H)	H	1.3	1.0
2x3/2-way, single solenoid, closed (T32N)	Q	1.3	1.0
2x3/2-way, single solenoid, open (T32F)	P	1.3	1.0
2x3/2-way, single solenoid, open/closed (T32W)	R	1.3	1.0
2x2/2-way, single solenoid, closed (T22C)	VC	1.3	1.0
2x2/2-way, single solenoid, closed (T22CV)	VV	1.3	1.0

Materials	
Housing	Die-cast aluminium, PA
Seals	FPM, NBR, HNBR
Screws	Galvanised steel
Note on materials	RoHS-compliant

Valve terminals VTSA/VTSA-F, NPT

Ordering data – Solenoid valve 24 V DC

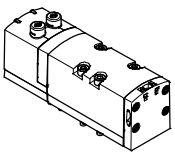
Ordering data – VSVA solenoid valve, MO non-detenting/detenting (D)						
	Terminal code	Valve function	Valve code	Width	Part No.	Type
Solenoid valves, 24 V DC						
	VC	2x 2/2-way valve, single solenoid, normally closed, pneumatic spring return	T22C	42 mm	561340	VSVA-B-T22C-AZD-D1-1T1L
	VV	2x 2/2-way valve, single solenoid, normally closed, pneumatic spring return, vacuum operation possible at 3 and 5	T22CV	42 mm	561344	VSVA-B-T22CV-AZD-D1-1T1L
	N	2x 3/2-way valve, single solenoid, normally open	T32U	42 mm	543692	VSVA-B-T32U-AZD-D1-1T1L
	K	2x 3/2-way valve, single solenoid, normally closed	T32C	42 mm	543690	VSVA-B-T32C-AZD-D1-1T1L
	H	2x 3/2-way valve, single solenoid, 1x normally open, 1x normally closed	T32H	42 mm	543694	VSVA-B-T32H-AZD-D1-1T1L
	P	2x 3/2-way valve, single solenoid, reverse operation, normally open	T32F	42 mm	543693	VSVA-B-T32F-AZD-D1-1T1L
	Q	2x 3/2-way valve, single solenoid, reverse operation, normally closed	T32N	42 mm	543691	VSVA-B-T32N-AZD-D1-1T1L
	R	2x 3/2-way valve, single solenoid, reverse operation, 1x normally open, 1x normally closed	T32W	42 mm	543695	VSVA-B-T32W-AZD-D1-1T1L
	M	5/2-way valve, single solenoid, pneumatic spring return	M52-A	42 mm	543698	VSVA-B-M52-AZD-D1-1T1L
	O	5/2-way valve, single solenoid, mechanical spring return	M52-M	42 mm	543699	VSVA-B-M52-MZD-D1-1T1L
	J	5/2-way valve, double solenoid	B52	42 mm	543696	VSVA-B-B52-ZD-D1-1T1L
	D	5/2-way valve, double solenoid, with dominant signal	D52	42 mm	543697	VSVA-B-D52-ZD-D1-1T1L
	B	5/3-way solenoid valve, mid-position pressurised	P53U	42 mm	543700	VSVA-B-P53U-ZD-D1-1T1L
	G	5/3-way valve, mid-position closed	P53C	42 mm	543702	VSVA-B-P53C-ZD-D1-1T1L
	E	5/3-way valve, mid-position exhausted	P53E	42 mm	543701	VSVA-B-P53E-ZD-D1-1T1L
	VG	5/3-way solenoid valve, mid-position pressurised 1 to 2, 4 to 5 closed	P53F	42 mm	8000464	VSVA-B-P53F-ZD-D1-1T1L

Valve terminals VTSA/VTSA-F, NPT

Ordering data – Solenoid valve 24 V DC

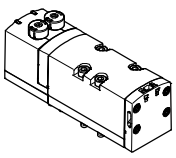
Ordering data – VSVA solenoid valve with cover cap for MO, non-detenting (H)						
	Terminal code	Valve function	Valve code	Width	Part No.	Type
Solenoid valves, 24 V DC						
	VC	2x 2/2-way valve, single solenoid, normally closed, pneumatic spring return	T22C	42 mm	8034812	VSVA-B-T22C-AZH-D1-1T1L
	VV	2x 2/2-way valve, single solenoid, normally closed, pneumatic spring return, vacuum operation possible at 3 and 5	T22CV	42 mm	8034813	VSVA-B-T22CV-AZH-D1-1T1L
	N	2x 3/2-way valve, single solenoid, normally open	T32U	42 mm	8034801	VSVA-B-T32U-AZH-D1-1T1L
	K	2x 3/2-way valve, single solenoid, normally closed	T32C	42 mm	8034799	VSVA-B-T32C-AZH-D1-1T1L
	H	2x 3/2-way valve, single solenoid, 1x normally open, 1x normally closed	T32H	42 mm	8034803	VSVA-B-T32H-AZH-D1-1T1L
	P	2x 3/2-way valve, single solenoid, reverse operation, normally open	T32F	42 mm	8034802	VSVA-B-T32F-AZH-D1-1T1L
	Q	2x 3/2-way valve, single solenoid, reverse operation, normally closed	T32N	42 mm	8034800	VSVA-B-T32N-AZH-D1-1T1L
	R	2x 3/2-way valve, single solenoid, reverse operation, 1x normally open, 1x normally closed	T32W	42 mm	8034804	VSVA-B-T32W-AZH-D1-1T1L
	M	5/2-way valve, single solenoid, pneumatic spring return	M52-A	42 mm	8034807	VSVA-B-M52-AZH-D1-1T1L
	O	5/2-way valve, single solenoid, mechanical spring return	M52-M	42 mm	8034808	VSVA-B-M52-MZH-D1-1T1L
	J	5/2-way valve, double solenoid	B52	42 mm	8034805	VSVA-B-B52-ZH-D1-1T1L
	D	5/2-way valve, double solenoid, dominant	D52	42 mm	8034806	VSVA-B-D52-ZH-D1-1T1L
	B	5/3-way solenoid valve, mid-position pressurised	P53U	42 mm	8034809	VSVA-B-P53U-ZH-D1-1T1L
	G	5/3-way solenoid valve, mid-position closed	P53C	42 mm	8034811	VSVA-B-P53C-ZH-D1-1T1L
	E	5/3-way solenoid valve, mid-position exhausted	P53E	42 mm	8034810	VSVA-B-P53E-ZH-D1-1T1L
	VG	5/3-way solenoid valve, mid-position pressurised 1 to 2, 4 to 5 closed	P53F	42 mm	8034814	VSVA-B-P53F-ZH-D1-1T1L

Valve terminals VTSA/VTSA-F, NPT

Ordering data – Solenoid valve 24 V DC

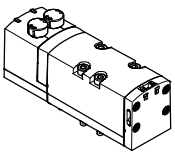
Ordering data – VSVA solenoid valve with cover cap for MO, covered						
	Terminal code	Valve function	Valve code	Width	Part No.	Type
Solenoid valves, 24 V DC						
	VC	2x 2/2-way valve, single solenoid, normally closed, pneumatic spring return	T22C	42 mm	8034843	VSVA-B-T22C-AZ-D1-1T1L
	VV	2x 2/2-way valve, single solenoid, normally closed, pneumatic spring return, vacuum operation possible at 3 and 5	T22CV	42 mm	8034844	VSVA-B-T22CV-AZ-D1-1T1L
	N	2x 3/2-way valve, single solenoid, normally open	T32U	42 mm	8034832	VSVA-B-T32U-AZ-D1-1T1L
	K	2x 3/2-way valve, single solenoid, normally closed	T32C	42 mm	8034830	VSVA-B-T32C-AZ-D1-1T1L
	H	2x 3/2-way valve, single solenoid, 1x normally open, 1x normally closed	T32H	42 mm	8034834	VSVA-B-T32H-AZ-D1-1T1L
	P	2x 3/2-way valve, single solenoid, reverse operation, normally open	T32F	42 mm	8034833	VSVA-B-T32F-AZ-D1-1T1L
	Q	2x 3/2-way valve, single solenoid, reverse operation, normally closed	T32N	42 mm	8034831	VSVA-B-T32N-AZ-D1-1T1L
	R	2x 3/2-way valve, single solenoid, reverse operation, 1x normally open, 1x normally closed	T32W	42 mm	8034835	VSVA-B-T32W-AZ-D1-1T1L
	M	5/2-way valve, single solenoid, pneumatic spring return	M52-A	42 mm	8034838	VSVA-B-M52-AZ-D1-1T1L
	O	5/2-way valve, single solenoid, mechanical spring return	M52-M	42 mm	8034839	VSVA-B-M52-MZ-D1-1T1L
	J	5/2-way valve, double solenoid	B52	42 mm	8034836	VSVA-B-B52-Z-D1-1T1L
	D	5/2-way valve, double solenoid, dominant	D52	42 mm	8034837	VSVA-B-D52-Z-D1-1T1L
	B	5/3-way solenoid valve, mid-position pressurised	P53U	42 mm	8034840	VSVA-B-P53U-Z-D1-1T1L
	G	5/3-way solenoid valve, mid-position closed	P53C	42 mm	8034842	VSVA-B-P53C-Z-D1-1T1L
	E	5/3-way solenoid valve, mid-position exhausted	P53E	42 mm	8034841	VSVA-B-P53E-Z-D1-1T1L
	VG	5/3-way solenoid valve, mid-position pressurised 1 to 2, 4 to 5 closed	P53F	42 mm	8034845	VSVA-B-P53F-Z-D1-1T1L

Valve terminals VTSA/VTSA-F, NPT

Ordering data – Solenoid valve 110/120 V AC

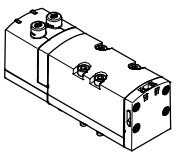
Ordering data – VSVA solenoid valve, MO non-detenting/detenting (D)						
	Terminal code	Valve function	Valve code	Width	Part No.	Type
Solenoid valves, 110/120 V AC						
	VC	2x 2/2-way valve, single solenoid, normally closed, pneumatic spring return	T22C	42 mm	561341	VSVA-B-T22C-AZD-D1-2AT1L
	VV	2x 2/2-way valve, single solenoid, normally closed, pneumatic spring return, vacuum operation possible at 3 and 5	T22CV	42 mm	561345	VSVA-B-T22CV-AZD-D1-2AT1L
	N	2x 3/2-way valve, single solenoid, normally open	T32U	42 mm	543679	VSVA-B-T32U-AZD-D1-2AT1L
	K	2x 3/2-way valve, single solenoid, normally closed	T32C	42 mm	543677	VSVA-B-T32C-AZD-D1-2AT1L
	H	2x 3/2-way valve, single solenoid, 1x normally open, 1x normally closed	T32H	42 mm	543681	VSVA-B-T32H-AZD-D1-2AT1L
	P	2x 3/2-way valve, single solenoid, reverse operation, normally open	T32F	42 mm	543680	VSVA-B-T32F-AZD-D1-2AT1L
	Q	2x 3/2-way valve, single solenoid, reverse operation, normally closed	T32N	42 mm	543678	VSVA-B-T32N-AZD-D1-2AT1L
	R	2x 3/2-way valve, single solenoid, reverse operation, 1x normally open, 1x normally closed	T32W	42 mm	543682	VSVA-B-T32W-AZD-D1-2AT1L
	M	5/2-way valve, single solenoid, pneumatic spring return	M52-A	42 mm	543685	VSVA-B-M52-AZD-D1-2AT1L
	O	5/2-way valve, single solenoid, mechanical spring return	M52-M	42 mm	543686	VSVA-B-M52-MZD-D1-2AT1L
	J	5/2-way valve, double solenoid	B52	42 mm	543683	VSVA-B-B52-ZD-D1-2AT1L
	D	5/2-way valve, double solenoid, with dominant signal	D52	42 mm	543684	VSVA-B-D52-ZD-D1-2AT1L
	B	5/3-way solenoid valve, mid-position pressurised	P53U	42 mm	543687	VSVA-B-P53U-ZD-D1-2AT1L
	G	5/3-way valve, mid-position closed	P53C	42 mm	543689	VSVA-B-P53C-ZD-D1-2AT1L
	E	5/3-way valve, mid-position exhausted	P53E	42 mm	543688	VSVA-B-P53E-ZD-D1-2AT1L

Valve terminals VTSA/VTSA-F, NPT

Technical data – Solenoid valve, width 52 mm

-  - Valve width
to ISO 5599-2
52 mm (ISO 2)

-  - Flow rate
Valve width 52 mm:
VTSA up to 2900 l/min
VTSA-F up to 2900 l/min

-  - Voltage
24 V DC
110 V AC



Safety characteristics - Valve, width 52 mm

Conforms to standard	EN 13849-1/2
Note on forced switch on/off	Min. 1/week
CE marking (see declaration of conformity)	110 V AC 24 V DC To EU Low Voltage Directive In accordance with EU EMC Directive ¹⁾
Shock resistance	Shock test with severity level 2, to EN 60068-2-27
Vibration resistance	Transport application test with severity level 2, to EN 60068-2-6

1) For information about the applicability of the component see the manufacturer's EC declaration of conformity at: www.festo.com/sp → User documentation.
If the component is subject to restrictions on usage in residential, office or commercial environments or small businesses, further measures to reduce the emitted interference may be necessary.

Safety characteristics - Valve, width 52 mm, 24 V DC

Valve function (with valve code)	Terminal code	Test pulses	
		Max. positive test pulse with 0 signal [µs]	Max. negative test pulse with 1 signal [µs]
5/2-way, double solenoid (B52)	J	1000	1500
5/2-way, double solenoid with dominant signal (D52)	D	1000	1500
5/2-way, single solenoid (M52-A)	M	1000	1500
5/2-way, single solenoid (M52-M)	O	1000	1500
5/3-way, closed (P53C)	G	1000	1500
5/3-way, exhausted (P53E)	E	1000	1500
5/3-way, pressurised (P53U)	B	1000	1500
5/3-way, pressurised 1 to 2, 4 to 5 closed (P53F)	VG	–	–
2x3/2-way, single solenoid, closed (T32C)	K	1000	1500
2x3/2-way, single solenoid, open (T32U)	N	1000	1500
2x3/2-way, single solenoid, open/closed (T32H)	H	1000	1500
2x3/2-way, single solenoid, closed (T32N)	Q	1000	1500
2x3/2-way, single solenoid, open (T32F)	P	1000	1500
2x3/2-way, single solenoid, open/closed (T32W)	R	1000	1500
2x2/2-way, single solenoid, closed (T22C)	VC	1000	1500

Valve terminals VTSA/VTSA-F, NPT

Technical data – Solenoid valve, width 52 mm

Technical data - Valve, width 52 mm							
Valve function (with valve code)	Terminal code	Flow direction			Type of reset		Weight [g]
		Any	Reversible only	Non-reversible	Pneumatic spring	Mechanical spring	
5/2-way, double solenoid (B52)	J	■	–	–	–	–	732
5/2-way, double solenoid with dominant signal (D52)	D	■	–	–	–	–	732
5/2-way, single solenoid (M52-A)	M	■	–	–	■	–	702
5/2-way, single solenoid (M52-M)	O	■	–	–	–	■	702
5/3-way, closed ¹⁾ (P53C)	G	■	–	–	–	■	780
5/3-way, exhausted ¹⁾ (P53E)	E	■	–	–	–	■	780
5/3-way, pressurised ¹⁾ (P53U)	B	■	–	–	–	■	780
5/3-way, pressurised 1 to 2, 4 to 5 closed (P53F)	VG	■	–	–	–	–	780
2x3/2-way, single solenoid, closed (T32C)	K	–	–	■	■	–	740
2x3/2-way, single solenoid, open (T32U)	N	–	–	■	■	–	740
2x3/2-way, single solenoid, open/closed (T32H)	H	–	–	■	■	–	740
2x3/2-way, single solenoid, closed (T32N)	Q	–	■	–	■	–	740
2x3/2-way, single solenoid, open (T32F)	P	–	■	–	■	–	740
2x3/2-way, single solenoid, open/closed (T32W)	R	–	■	–	■	–	740
2x2/2-way, single solenoid, closed (T22C)	VC	–	–	■	■	–	740

- 1) If neither solenoid coil is energised, the valve assumes its mid-position by means of spring force.
If both solenoid coils are energised at the same time, the valve remains in the previously assumed switching position.

Standard nominal flow rate - Valve/valve terminal [l/min], width 52 mm					
Valve function (with valve code)	Terminal code	Flow rate			
		Valve	Valve on valve terminal VTSA	Valve on valve terminal VTSA-F	Valve on individual sub-base
5/2-way, double solenoid (B52)	J	4000	2900	2900	3400
5/2-way, double solenoid with dominant signal (D52)	D	4000	2900	2900	3400
5/2-way, single solenoid (M52-A)	M	4000	2900	2900	3400
5/2-way, single solenoid (M52-M)	O	4000	2900	2900	3400
5/3-way, closed (P53C)	G	3600 ¹⁾ 1700 ²⁾	2800 ¹⁾ 1700 ²⁾	2800 ¹⁾ 1700 ²⁾	3200 ¹⁾ 1700 ²⁾
5/3-way, exhausted (P53E)	E	3600 ¹⁾ 1700 ²⁾	2800 ¹⁾ 1700 ²⁾	2800 ¹⁾ 1700 ²⁾	3200 ¹⁾ 1700 ²⁾
5/3-way, pressurised (P53U)	B	3600 ¹⁾ 1700 ²⁾	2800 ¹⁾ 1700 ²⁾	2800 ¹⁾ 1700 ²⁾	3200 ¹⁾ 1700 ²⁾
5/3-way, pressurised 1 to 2, 4 to 5 closed (P53F)	VG	3000 ¹⁾ 900 ²⁾	2300 ¹⁾ 900 ²⁾	2300 ¹⁾ 900 ²⁾	2600 ¹⁾ 900 ²⁾
2x3/2-way, single solenoid, closed (T32C)	K	3000	2400	2400	2600
2x3/2-way, single solenoid, open (T32U)	N	3000	2400	2400	2600
2x3/2-way, single solenoid, open/closed (T32H)	H	3000	2400	2400	2600
2x3/2-way, single solenoid, closed (T32N)	Q	3000	2400	2400	2600
2x3/2-way, single solenoid, open (T32F)	P	3000	2400	2400	2600
2x3/2-way, single solenoid, open/closed (T32W)	R	3000	2400	2400	2600
2x2/2-way, single solenoid, closed (T22C)	VC	4000	2800	2800	3400

- 1) Switching position
2) Mid-position

Valve terminals VTSA/VTSA-F, NPT

Technical data – Solenoid valve, width 52 mm

Valve switching times in [ms], width 52 mm, nominal operating voltage 24 V DC/110 V AC							
Valve function (with valve code)	Terminal code	24 V DC			110 V AC		
		On	Off	Changeover	On	Off	Changeover
5/2-way, double solenoid (B52)	J	–	–	18	–	–	35
5/2-way, double solenoid with dominant signal (D52)	D	–	–	18	–	–	42
5/2-way, single solenoid (M52-A)	M	40	45	–	70	90	–
5/2-way, single solenoid (M52-M)	O	20	60	–	25	110	–
5/3-way, closed (P53C)	G	23	60	38	30	100	60
5/3-way, exhausted (P53E)	E	23	60	38	30	100	60
5/3-way, pressurised (P53U)	B	23	60	38	30	100	60
5/3-way, pressurised 1 to 2, 4 to 5 closed (P53F)	VG	23	60	38	–	–	–
2x3/2-way, single solenoid, closed (T32C)	K	20	35	–	35	70	–
2x3/2-way, single solenoid, open (T32U)	N	20	35	–	35	70	–
2x3/2-way, single solenoid, open/closed (T32H)	H	20	35	–	35	70	–
2x3/2-way, single solenoid, closed (T32N)	Q	20	35	–	50	65	–
2x3/2-way, single solenoid, open (T32F)	P	20	35	–	50	65	–
2x3/2-way, single solenoid, open/closed (T32W)	R	20	35	–	50	65	–
2x2/2-way, single solenoid, closed (T22C)	VC	14	35	–	35	70	–

Coil characteristics, width 52 mm			
Valve function (with valve code)	Terminal code	Coil characteristics at 24 V DC in [W]	Coil characteristics at 110/120 V AC in [VA]
5/2-way, double solenoid (B52)	J	4.6	1.6
5/2-way, double solenoid with dominant signal (D52)	D	4.6	1.0
5/2-way, single solenoid (M52-A)	M	4.6	1.6
5/2-way, single solenoid (M52-M)	O	4.6	1.6
5/3-way, closed (P53C)	G	4.6	1.6
5/3-way, exhausted (P53E)	E	4.6	1.6
5/3-way, pressurised (P53U)	B	4.6	1.6
5/3-way, pressurised 1 to 2, 4 to 5 closed (P53F)	VG	4.6	–
2x3/2-way, single solenoid, closed (T32C)	K	4.6	1.0
2x3/2-way, single solenoid, open (T32U)	N	4.6	1.0
2x3/2-way, single solenoid, open/closed (T32H)	H	4.6	1.0
2x3/2-way, single solenoid, closed (T32N)	Q	4.6	1.0
2x3/2-way, single solenoid, open (T32F)	P	4.6	1.0
2x3/2-way, single solenoid, open/closed (T32W)	R	4.6	1.0
2x2/2-way, single solenoid, closed (T22C)	VC	4.6	1.0

Maximum current consumption per solenoid coil, width 52 mm		
At nominal voltage 24 V DC (valves with holding current reduction)		
Nominal pick-up current	[mA]	165
Nominal current following current reduction	[mA]	35
Time until current reduction	[ms]	30

Materials	
Housing	Die-cast aluminium, PA
Seals	HNBR, NBR, HNBR
Screws in	Galvanised steel
Note on materials	RoHS-compliant

Valve terminals VTSA/VTSA-F, NPT

Ordering data – Solenoid valve 24 V DC

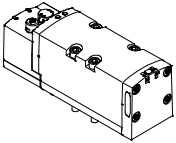
Ordering data – VSVA solenoid valve, MO non-detenting/detenting (D)						
	Terminal code	Valve function	Valve code	Width	Part No.	Type
Solenoid valves, 24 V DC						
	VC	2x 2/2-way valve, single solenoid, normally closed, pneumatic spring return	T22C	52 mm	560831	VSVA-B-T22C-AZD-D2-1T1L
	N	2x 3/2-way valve, single solenoid, normally open	T32U	52 mm	560827	VSVA-B-T32U-AZD-D2-1T1L
	K	2x 3/2-way valve, single solenoid, normally closed	T32C	52 mm	560825	VSVA-B-T32C-AZD-D2-1T1L
	H	2x 3/2-way valve, single solenoid, 1x normally open, 1x normally closed	T32H	52 mm	560829	VSVA-B-T32H-AZD-D2-1T1L
	P	2x 3/2-way valve, single solenoid, reverse operation, normally open	T32F	52 mm	560828	VSVA-B-T32F-AZD-D2-1T1L
	Q	2x 3/2-way valve, single solenoid, reverse operation, normally closed	T32N	52 mm	560826	VSVA-B-T32N-AZD-D2-1T1L
	R	2x 3/2-way valve, single solenoid, reverse operation, 1x normally open, 1x normally closed	T32W	52 mm	560830	VSVA-B-T32W-AZD-D2-1T1L
	M	5/2-way valve, single solenoid, pneumatic spring return	M52-A	52 mm	560820	VSVA-B-M52-AZD-D2-1T1L
	O	5/2-way valve, single solenoid, mechanical spring return	M52-M	52 mm	560821	VSVA-B-M52-MZD-D2-1T1L
	J	5/2-way valve, double solenoid	B52	52 mm	560818	VSVA-B-B52-ZD-D2-1T1L
	D	5/2-way valve, double solenoid, with dominant signal	D52	52 mm	560819	VSVA-B-D52-ZD-D2-1T1L
	B	5/3-way solenoid valve, mid-position pressurised	P53U	52 mm	560822	VSVA-B-P53U-ZD-D2-1T1L
	G	5/3-way valve, mid-position closed	P53C	52 mm	560824	VSVA-B-P53C-ZD-D2-1T1L
	E	5/3-way valve, mid-position exhausted	P53E	52 mm	560823	VSVA-B-P53E-ZD-D2-1T1L
	VG	5/3-way solenoid valve, mid-position pressurised 1 to 2, 4 to 5 closed	P53F	52 mm	8000465	VSVA-B-P53F-ZD-D2-1T1L

Valve terminals VTSA/VTSA-F, NPT

Ordering data – Solenoid valve 24 V DC

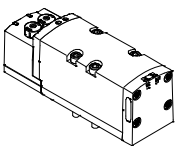
Ordering data – VSVA solenoid valve with cover cap for MO, non-detenting (H)						
	Terminal code	Valve function	Valve code	Width	Part No.	Type
Solenoid valves, 24 V DC						
	VC	2x 2/2-way valve, single solenoid, normally closed, pneumatic spring return	T22C	52 mm	8034982	VSVA-B-T22C-AZH-D2-1T1L
	N	2x 3/2-way valve, single solenoid, normally open	T32U	52 mm	8034978	VSVA-B-T32U-AZH-D2-1T1L
	K	2x 3/2-way valve, single solenoid, normally closed	T32C	52 mm	8034976	VSVA-B-T32C-AZH-D2-1T1L
	H	2x 3/2-way valve, single solenoid, 1x normally open, 1x normally closed	T32H	52 mm	8034980	VSVA-B-T32H-AZH-D2-1T1LL
	P	2x 3/2-way valve, single solenoid, reverse operation, normally open	T32F	52 mm	8034979	VSVA-B-T32F-AZH-D2-1T1L
	Q	2x 3/2-way valve, single solenoid, reverse operation, normally closed	T32N	52 mm	8034977	VSVA-B-T32N-AZH-D2-1T1L
	R	2x 3/2-way valve, single solenoid, reverse operation, 1x normally open, 1x normally closed	T32W	52 mm	8034981	VSVA-B-T32W-AZH-D2-1T1L
	M	5/2-way valve, single solenoid, pneumatic spring return	M52-A	52 mm	8034971	VSVA-B-M52-AZH-D2-1T1L
	O	5/2-way valve, single solenoid, mechanical spring return	M52-M	52 mm	8034972	VSVA-B-M52-MZH-D2-1T1L
	J	5/2-way valve, double solenoid	B52	52 mm	8034969	VSVA-B-B52-ZH-D2-1T1L
	D	5/2-way valve, double solenoid, dominant	D52	52 mm	8034970	VSVA-B-D52-ZH-D2-1T1L
	B	5/3-way solenoid valve, mid-position pressurised	P53U	52 mm	8034973	VSVA-B-P53U-ZH-D2-1T1L
	G	5/3-way solenoid valve, mid-position closed	P53C	52 mm	8034975	VSVA-B-P53C-ZH-D2-1T1L
	E	5/3-way solenoid valve, mid-position exhausted	P53E	52 mm	8034974	VSVA-B-P53E-ZH-D2-1T1L
	VG	5/3-way solenoid valve, mid-position pressurised 1 to 2, 4 to 5 closed	P53F	52 mm	8034983	VSVA-B-P53F-ZH-D2-1T1L

Valve terminals VTSA/VTSA-F, NPT

Ordering data – Solenoid valve 24 V DC

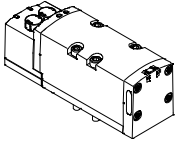
Ordering data – VSVA solenoid valve with cover cap for MO, covered						
	Terminal code	Valve function	Valve code	Width	Part No.	Type
Solenoid valves, 24 V DC						
	VC	2x 2/2-way valve, single solenoid, normally closed, pneumatic spring return	T22C	52 mm	8034997	VSVA-B-T22C-AZ-D2-1T1L
	N	2x 3/2-way valve, single solenoid, normally open	T32U	52 mm	8034993	VSVA-B-T32U-AZ-D2-1T1L
	K	2x 3/2-way valve, single solenoid, normally closed	T32C	52 mm	8034991	VSVA-B-T32C-AZ-D2-1T1L
	H	2x 3/2-way valve, single solenoid, 1x normally open, 1x normally closed	T32H	52 mm	8034995	VSVA-B-T32H-AZ-D2-1T1L
	P	2x 3/2-way valve, single solenoid, reverse operation, normally open	T32F	52 mm	8034994	VSVA-B-T32F-AZ-D2-1T1L
	Q	2x 3/2-way valve, single solenoid, reverse operation, normally closed	T32N	52 mm	8034992	VSVA-B-T32N-AZ-D2-1T1L
	R	2x 3/2-way valve, single solenoid, reverse operation, 1x normally open, 1x normally closed	T32W	52 mm	8034996	VSVA-B-T32W-AZ-D2-1T1L
	M	5/2-way valve, single solenoid, pneumatic spring return	M52-A	52 mm	8034986	VSVA-B-M52-AZ-D2-1T1L
	O	5/2-way valve, single solenoid, mechanical spring return	M52-M	52 mm	8034987	VSVA-B-M52-MZ-D2-1T1L
	J	5/2-way valve, double solenoid	B52	52 mm	8034984	VSVA-B-B52-Z-D2-1T1L
	D	5/2-way valve, double solenoid, dominant	D52	52 mm	8034985	VSVA-B-D52-Z-D2-1T1L
	B	5/3-way solenoid valve, mid-position pressurised	P53U	52 mm	8034988	VSVA-B-P53U-Z-D2-1T1L
	G	5/3-way solenoid valve, mid-position closed	P53C	52 mm	8034990	VSVA-B-P53C-Z-D2-1T1L
	E	5/3-way solenoid valve, mid-position exhausted	P53E	52 mm	8034989	VSVA-B-P53E-Z-D2-1T1L
	VG	5/3-way solenoid valve, mid-position pressurised 1 to 2, 4 to 5 closed	P53F	52 mm	8034998	VSVA-B-P53F-Z-D2-1T1L

Valve terminals VTSA/VTSA-F, NPT

FESTO

Ordering data – Solenoid valve 110/120 V AC

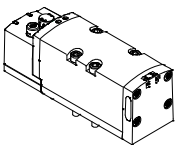
Ordering data – VSVA solenoid valve, MO non-detenting/detenting (D)						
	Terminal code	Valve function	Valve code	Width	Part No.	Type
Solenoid valves, 110/120 V AC						
	VC	2x 2/2-way valve, single solenoid, normally closed, pneumatic spring return	T22C	52 mm	560812	VSVA-B-T22C-AZD-D2-2AT1L
	N	2x 3/2-way valve, single solenoid, normally open	T32U	52 mm	560808	VSVA-B-T32U-AZD-D2-2AT1L
	K	2x 3/2-way valve, single solenoid, normally closed	T32C	52 mm	560806	VSVA-B-T32C-AZD-D2-2AT1L
	H	2x 3/2-way valve, single solenoid, 1x normally open, 1x normally closed	T32H	52 mm	560810	VSVA-B-T32H-AZD-D2-2AT1L
	P	2x 3/2-way valve, single solenoid, reverse operation, normally open	T32F	52 mm	560809	VSVA-B-T32F-AZD-D2-2AT1L
	Q	2x 3/2-way valve, single solenoid, reverse operation, normally closed	T32N	52 mm	560807	VSVA-B-T32N-AZD-D2-2AT1L
	R	2x 3/2-way valve, single solenoid, reverse operation, 1x normally open, 1x normally closed	T32W	52 mm	560811	VSVA-B-T32W-AZD-D2-2AT1L
	M	5/2-way valve, single solenoid, pneumatic spring return	M52-A	52 mm	560801	VSVA-B-M52-AZD-D2-2AT1L
	O	5/2-way valve, single solenoid, mechanical spring return	M52-M	52 mm	560802	VSVA-B-M52-MZD-D2-2AT1L
	J	5/2-way valve, double solenoid	B52	52 mm	560799	VSVA-B-B52-ZD-D2-2AT1L
	D	5/2-way valve, double solenoid, with dominant signal	D52	52 mm	560800	VSVA-B-D52-ZD-D2-2AT1L
	B	5/3-way solenoid valve, mid-position pressurised	P53U	52 mm	560803	VSVA-B-P53U-ZD-D2-2AT1L
	G	5/3-way valve, mid-position closed	P53C	52 mm	560805	VSVA-B-P53C-ZD-D2-2AT1L
E	5/3-way valve, mid-position exhausted	P53E	52 mm	560804	VSVA-B-P53E-ZD-D2-2AT1L	

Valve terminals VTSA/VTSA-F, NPT



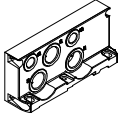
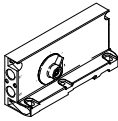
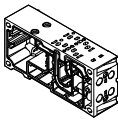
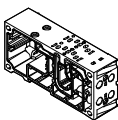

Accessories – Pneumatic components

Ordering data					
	Code	Description	Width	Part No.	Type
Right-hand end plate					
	V	With supply air/exhaust air, internal pilot air supply, 1/2" NPT		539235	VABE-S6-1R-N12
	V1	With supply air/exhaust air, internal pilot air supply, 3/4" NPT		560838	VABE-S6-2R-N34
	X	With supply air/exhaust air, external pilot air supply, 1/2" NPT		539237	VABE-S6-1RZ-N12
	X1	With supply air/exhaust air, external pilot air supply, 3/4" NPT		560840	VABE-S6-2RZ-N34
End plate with pilot air selector					
	Y ¹⁾	Internal pilot air supply		539239	VABE-S6-1RZ-N-B1
	U ¹⁾	Internal pilot air supply, ducted pilot exhaust air			
	Z ¹⁾	External pilot air supply			
	W ¹⁾	External pilot air supply, ducted pilot exhaust air			
Manifold sub-base, port pattern to ISO 15407-2 and ISO 5599-2					
	A	2 valve positions, 4 addresses, for double solenoid valves	18 mm	539223	VABV-S4-2S-N18-2T2
	B	2 valve positions, 4 addresses, for double solenoid valves	26 mm	539219	VABV-S4-1S-N14-2T2
	C	1 valve position, 2 addresses, for double solenoid valves	42 mm	542460	VABV-S2-1S-N38-T2
	D	1 valve position, 2 addresses, for double solenoid valves	52 mm	560843	VABV-S2-2S-N12-T2
	E	2 valve positions, 2 addresses, for single solenoid valves	18 mm	539225	VABV-S4-2S-N18-2T1
	F	2 valve positions, 2 addresses, for single solenoid valves	26 mm	539221	VABV-S4-1S-N14-2T1
	G	1 valve position, 1 address, for single solenoid valves	42 mm	542461	VABV-S2-1S-N38-T1
	H	1 valve position, 1 address, for single solenoid valves	52 mm	560844	VABV-S2-2S-N12-T1
Manifold sub-base VTSA-F, optimised for flow rate					
	A	2 valve positions, 4 addresses, for double solenoid valves	18 mm	546217	VABV-S4-2HS-N18-2T2
	B	2 valve positions, 4 addresses, for double solenoid valves	26 mm	546213	VABV-S4-1HS-N14-2T2
	C	1 valve position, 2 addresses, for double solenoid valves	42 mm	546221	VABV-S2-1HS-N38-T2
	E	2 valve positions, 2 addresses, for single solenoid valves	18 mm	546216	VABV-S4-2HS-N18-2T1
	F	2 valve positions, 2 addresses, for single solenoid valves	26 mm	546212	VABV-S4-1HS-N14-2T1
	G	1 valve position, 1 address, for single solenoid valves	42 mm	546220	VABV-S2-1HS-N38-T1

1) Code letter within the order code for a valve terminal configuration.

Valve terminals VTSA/VTSA-F, NPT

Accessories – Pneumatic components

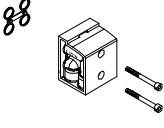
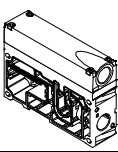
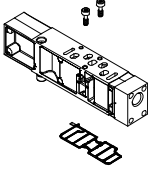
Ordering data					
	Code	Description	Width	Part No.	Type
Separator plate					
	S	Duct separation 1, 3, 5		539228	VABD-S6-1-P3-C
	T	Duct separation 1		539227	VABD-S6-1-P1-C
	R	Duct separation 3, 5		539229	VABD-S6-1-P2-C
Seal					
	-	Between manifold sub-bases		668436	VABD-S6-1-C
90° connection plate					
	P	Outlet at bottom, connecting thread 1/8" NPT	18 mm	539720	VABF-S4-2-A2G2-N18
		Outlet at bottom, connecting thread 1/4" NPT	26 mm	539722	VABF-S4-1-A2G2-N14
		Outlet at bottom, connecting thread 3/8" NPT	42 mm	546098	VABF-S2-1-A1G2-N38
		Outlet at bottom, connecting thread 1/2" NPT	52 mm	555703	VABF-S2-2-A1G2-N12
Supply plate					
	L	With exhaust plate, 3/5 common, 1/2" NPT		539233	VABF-S6-1-P1A7-N12
	K	With exhaust port cover, 3/5 separated, 1/2" NPT		539232	VABF-S6-1-P1A6-N12
Vertical supply plate (operating pressure 0.9...10 bar)					
	ZU	Connecting thread 1/8" NPT Individual compressed air supply, duct 1	18 mm	540174	VABF-S4-2-P1A3-N18
		Connecting thread 1/4" NPT Individual compressed air supply, duct 1	26 mm	540172	VABF-S4-1-P1A3-N14
		Connecting thread 3/8" NPT Individual compressed air supply, duct 1	42 mm	546094	VABF-S2-1-P1A3-N38
		Connecting thread 1/2" NPT Individual compressed air supply, duct 1	52 mm	555787	VABF-S2-2-P1A3-N12
		Connecting thread 1/8" NPT Individual compressed air supply, ducts 1 and 14	18 mm	8000694	VABF-S4-2-P1A14-N18
	ZV	Connecting thread 1/4" NPT Individual compressed air supply, ducts 1 and 14	26 mm	8000690	VABF-S4-2-P1A14-N14
		Connecting thread 3/8" NPT Individual compressed air supply, ducts 1 and 14	42 mm	8000540	VABF-S2-1-P1A14-N38
		Connecting thread 1/2" NPT Individual compressed air supply, ducts 1 and 14	52 mm	8000550	VABF-S2-2-P1A14-N12

Valve terminals VTSA/VTSA-F, NPT

FESTO

Accessories – Pneumatic components

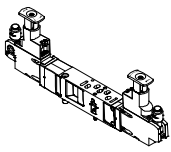
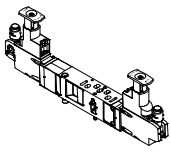
Ordering data						
	Code	Pressure regulation for port	Pressure regulation range [bar]	Width	Part No.	Type
Regulator plate, width 18 mm						
	ZA	1	0.5...10	18 mm	540153	VABF-S4-2-R1C2-C-10
	ZF	1	0.5...6	18 mm	540151	VABF-S4-2-R1C2-C-6
	ZC	2	2...10	18 mm	540161	VABF-S4-2-R2C2-C-10
	ZH	2	2...6	18 mm	540159	VABF-S4-2-R2C2-C-6
	ZB	4	2...10	18 mm	540157	VABF-S4-2-R3C2-C-10
	ZG	4	2...6	18 mm	540155	VABF-S4-2-R3C2-C-6
	ZD	2 and 4	2...10	18 mm	540165	VABF-S4-2-R4C2-C-10
	ZI	2 and 4	2...6	18 mm	540163	VABF-S4-2-R4C2-C-6
	ZE	2 and 4, reversible	0.5...10	18 mm	540169	VABF-S4-2-R5C2-C-10
	ZJ	2 and 4, reversible	0.5...6	18 mm	540167	VABF-S4-2-R5C2-C-6
	ZL	2, reversible	0.5...10	18 mm	546252	VABF-S4-2-R6C2-C-10
	ZN	2, reversible	0.5...6	18 mm	546248	VABF-S4-2-R6C2-C-6
	ZK	4, reversible	0.5...10	18 mm	546254	VABF-S4-2-R7C2-C-10
	ZM	4, reversible	0.5...6	18 mm	546250	VABF-S4-2-R7C2-C-6
Regulator plate, width 26 mm						
	ZA	1	0.5...10	26 mm	540154	VABF-S4-1-R1C2-C-10
	ZF	1	0.5...6	26 mm	540152	VABF-S4-1-R1C2-C-6
	ZC	2	2...10	26 mm	540162	VABF-S4-1-R2C2-C-10
	ZH	2	2...6	26 mm	540160	VABF-S4-1-R2C2-C-6
	ZB	4	2...10	26 mm	540158	VABF-S4-1-R3C2-C-10
	ZG	4	2...6	26 mm	540156	VABF-S4-1-R3C2-C-6
	ZD	2 and 4	2...10	26 mm	540166	VABF-S4-1-R4C2-C-10
	ZI	2 and 4	2...6	26 mm	540164	VABF-S4-1-R4C2-C-6
	ZE	2 and 4, reversible	0.5...10	26 mm	540170	VABF-S4-1-R5C2-C-10
	ZJ	2 and 4, reversible	0.5...6	26 mm	540168	VABF-S4-1-R5C2-C-6
	ZL	2, reversible	0.5...10	26 mm	546251	VABF-S4-1-R6C2-C-10
	ZN	2, reversible	0.5...6	26 mm	546247	VABF-S4-1-R6C2-C-6
	ZK	4, reversible	0.5...10	26 mm	546253	VABF-S4-1-R7C2-C-10
	ZM	4, reversible	0.5...6	26 mm	546249	VABF-S4-1-R7C2-C-6

Valve terminals VTSA/VTSA-F, NPT

Accessories – Pneumatic components

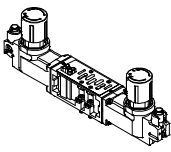
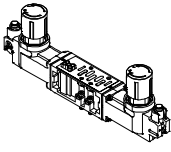
Ordering data						
	Code	Pressure regulation for port	Pressure regulation range [bar]	Width	Part No.	Type
Regulator plate, width 42 mm						
	ZA	1	0.5...10	42 mm	546084	VABF-S2-1-R1C2-C-10
	ZF	1	0.5...6	42 mm	546083	VABF-S2-1-R1C2-C-6
	ZC	2	1.0...10	42 mm	546088	VABF-S2-1-R2C2-C-10
	ZH	2	1.0...6	42 mm	546087	VABF-S2-1-R2C2-C-6
	ZB	4	1.0...10	42 mm	546086	VABF-S2-1-R3C2-C-10
	ZG	4	0.5...6	42 mm	546085	VABF-S2-1-R3C2-C-6
	ZD	2 and 4	1.0...10	42 mm	546090	VABF-S2-1-R4C2-C-10
	ZI	2 and 4	1.0...6	42 mm	546089	VABF-S2-1-R4C2-C-6
	ZE	2 and 4, reversible	0.5...10	42 mm	546092	VABF-S2-1-R5C2-C-10
	ZJ	2 and 4, reversible	0.5...6	42 mm	546091	VABF-S2-1-R5C2-C-6
	ZL	2, reversible	0.5...10	42 mm	546832	VABF-S2-1-R6C2-C-10
	ZN	2, reversible	0.5...6	42 mm	546831	VABF-S2-1-R6C2-C-6
	ZK	4, reversible	0.5...10	42 mm	546834	VABF-S2-1-R7C2-C-10
	ZM	4, reversible	0,5...6	42 mm	546833	VABF-S2-1-R7C2-C-6
Regulator plate, width 52 mm						
	ZA	1	0.5...10	52 mm	555772	VABF-S2-2-R1C2-C-10
	ZF	1	0.5...6	52 mm	555771	VABF-S2-2-R1C2-C-6
	ZC	2	1.0...10	52 mm	555774	VABF-S2-2-R2C2-C-10
	ZH	2	1.0...6	52 mm	555773	VABF-S2-2-R2C2-C-6
	ZB	4	1.0...10	52 mm	555776	VABF-S2-2-R3C2-C-10
	ZG	4	1.0...6	52 mm	555775	VABF-S2-2-R3C2-C-6
	ZD	2 and 4	1.0...10	52 mm	555778	VABF-S2-2-R4C2-C-10
	ZI	2 and 4	1.0...6	52 mm	555777	VABF-S2-2-R4C2-C-6
	ZE	2 and 4, reversible	0.5...10	52 mm	555780	VABF-S2-2-R5C2-C-10
	ZJ	2 and 4, reversible	0.5...6	52 mm	555779	VABF-S2-2-R5C2-C-6
	ZL	2, reversible	0.5...10	52 mm	555782	VABF-S2-2-R6C2-C-10
	ZN	2, reversible	0.5...6	52 mm	555781	VABF-S2-2-R6C2-C-6
	ZK	4, reversible	0.5...10	52 mm	555784	VABF-S2-2-R7C2-C-10
	ZM	4, reversible	0.5...6	52 mm	555783	VABF-S2-2-R7C2-C-6

Valve terminals VTSA/VTSA-F, NPT

Accessories – Pneumatic components

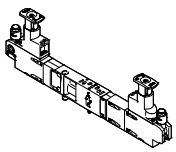
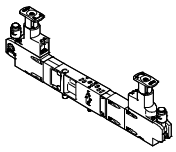
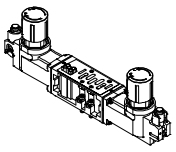
Ordering data						
	Code	Pressure regulation for port	Pressure regulation range [bar]	Width	Part No.	Type
Regulator plate for valves with symmetrical coil layout, width 18 mm						
	ZAY	1	0.5...10	18 mm	560756	VABF-S4-2-R1C2-C-10E
	ZFY	1	0.5...6	18 mm	560758	VABF-S4-2-R1C2-C-6E
	ZCY	2	2...10	18 mm	560763	VABF-S4-2-R2C2-C-10E
	ZHY	2	2...6	18 mm	560765	VABF-S4-2-R2C2-C-6E
	ZDY	2 and 4	2...10	18 mm	560767	VABF-S4-2-R4C2-C-10E
	ZIY	2 and 4	2...6	18 mm	560769	VABF-S4-2-R4C2-C-6E
	ZEY	2 and 4, reversible	0.5...10	18 mm	560771	VABF-S4-2-R5C2-C-10E
	ZJY	2 and 4, reversible	0.5...6	18 mm	560773	VABF-S4-2-R5C2-C-6E
	ZLY	2, reversible	0.5...10	18 mm	560775	VABF-S4-2-R6C2-C-10E
	ZNY	2, reversible	0.5...6	18 mm	560777	VABF-S4-2-R6C2-C-6E
Regulator plate for valves with symmetrical coil layout, width 26 mm						
	ZAY	1	0.5...10	26 mm	560757	VABF-S4-1-R1C2-C-10E
	ZFY	1	0.5...6	26 mm	549876	VABF-S4-1-R1C2-C-6E
	ZCY	2	2...10	26 mm	560764	VABF-S4-1-R2C2-C-10E
	ZHY	2	2...6	26 mm	560766	VABF-S4-1-R2C2-C-6E
	ZDY	2 and 4	2...10	26 mm	560768	VABF-S4-1-R4C2-C-10E
	ZIY	2 and 4	2...6	26 mm	560770	VABF-S4-1-R4C2-C-6E
	ZEY	2 and 4, reversible	0.5...10	26 mm	560772	VABF-S4-1-R5C2-C-10E
	ZJY	2 and 4, reversible	0.5...6	26 mm	560774	VABF-S4-1-R5C2-C-6E
	ZLY	2, reversible	0.5...10	26 mm	560776	VABF-S4-1-R6C2-C-10E
	ZNY	2, reversible	0.5...6	26 mm	560778	VABF-S4-1-R6C2-C-6E
Regulator plate for valves with symmetrical coil layout, width 42 mm ¹⁾						
	ZAY	1	0.5...10	42 mm	–	VABF-S2-1-R1C2-C-10E
	ZFY	1	0.5...6	42 mm	–	VABF-S2-1-R1C2-C-6E
	ZCY	2	0.5...10	42 mm	–	VABF-S2-1-R2C2-C-10E
	ZHY	2	0.5...6	42 mm	–	VABF-S2-1-R2C2-C-6E
	ZBY	4	0.5...10	42 mm	–	VABF-S2-1-R3C2-C-10E
	ZGY	4	0.5...6	42 mm	–	VABF-S2-1-R3C2-C-6E
	ZDY	2 and 4	0.5...10	42 mm	–	VABF-S2-1-R4C2-C-10E
	ZIY	2 and 4	0.5...6	42 mm	–	VABF-S2-1-R4C2-C-6E
	ZEY	2 and 4, reversible	0.5...10	42 mm	–	VABF-S2-1-R5C2-C-10E
	ZJY	2 and 4, reversible	0.5...6	42 mm	–	VABF-S2-1-R5C2-C-6E
	ZLY	2, reversible	0.5...10	42 mm	–	VABF-S2-1-R6C2-C-10E
	ZNY	2, reversible	0.5...6	42 mm	–	VABF-S2-1-R6C2-C-6E
	ZKY	4, reversible	0.5...10	42 mm	–	VABF-S2-1-R7C2-C-10E
	ZMY	4, reversible	0.5...6	42 mm	–	VABF-S2-1-R7C2-C-6E

1) These functions are available via the pressure regulator configurator VABF-S2 for width 42 mm and 52 mm (ISO 5599-2, ISO 1 and ISO 2) only.

Valve terminals VTSA/VTSA-F, NPT

Accessories – Pneumatic components

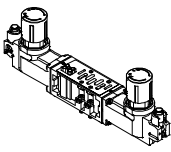
Ordering data						
	Code	Pressure regulation for port	Pressure regulation range [bar]	Width	Part No.	Type
Regulator plate for valves with symmetrical coil layout, width 52 mm ¹⁾						
	ZAY	1	0.5...10	52 mm	–	VABF-S2-2-R1C2-C-10E
	ZFY	1	0.5...6	52 mm	–	VABF-S2-2-R1C2-C-6E
	ZCY	2	0.5...10	52 mm	–	VABF-S2-2-R2C2-C-10E
	ZHY	2	0.5...6	52 mm	–	VABF-S2-2-R2C2-C-6E
	ZBY	4	0.5...10	52 mm	–	VABF-S2-2-R3C2-C-10E
	ZGY	4	0.5...6	52 mm	–	VABF-S2-2-R3C2-C-6E
	ZDY	2 and 4	0.5...10	52 mm	–	VABF-S2-2-R4C2-C-10E
	ZIY	2 and 4	0.5...6	52 mm	–	VABF-S2-2-R4C2-C-6E
	ZEY	2 and 4, reversible	0.5...10	52 mm	–	VABF-S2-2-R5C2-C-10E
	ZJY	2 and 4, reversible	0.5...6	52 mm	–	VABF-S2-2-R5C2-C-6E
	ZLY	2, reversible	0.5...10	52 mm	–	VABF-S2-2-R6C2-C-10E
	ZNY	2, reversible	0.5...6	52 mm	–	VABF-S2-2-R6C2-C-6E
	ZKY	4, reversible	0.5...10	52 mm	–	VABF-S2-2-R7C2-C-10E
	ZMY	4, reversible	0.5...6	52 mm	–	VABF-S2-2-R7C2-C-6E







1) These functions are available via the pressure regulator configurator VABF-S2 for width 42 mm and 52 mm (ISO 5599-2, ISO 1 and ISO 2) only.

Ordering data									
	Code	Description	Width	Part No.	Type				
Pressure gauge									
	T	With cartridge connection for regulator, 10 bar, scale bar/psi, display range 0...16 bar/0...240 psi, for regulator plate code ZA, ZB, ZC, ZD, ZE, ZK, ZL	18 mm	543487	PAGN-26-16-P10				
			26 mm						
			42 mm				548010	PAGN-40-16-P10	
			52 mm						
	U	With cartridge connection for regulator, 6 bar, scale bar/psi, display range 0...10 bar/0...145 psi, for regulator plate code ZF, ZG, ZH, ZI, ZJ, ZM, ZN	18 mm	543488	PAGN-26-10-P10				
			26 mm						
			42 mm				548009	PAGN-40-10-P10	
			52 mm						
	WT	With cartridge connection for regulator, 10 bar, scale MPa, display range 0...16 bar/0...1.6 MPa, for regulator plate code ZA, ZB, ZC, ZD, ZE, ZK, ZL	18 mm	563735	PAGN-26-1.6M-P10				
			26 mm						
			42 mm				563737	PAGN-40-1.6M-P10	
			52 mm						
	WU	With cartridge connection for regulator, 6 bar, scale MPa, display range 0...16 bar/0...1 MPa, for regulator plate code ZF, ZG, ZH, ZI, ZJ, ZM, ZN	18 mm	563736	PAGN-26-1M-P10				
			26 mm						
42 mm			563738				PAGN-40-1M-P10		
52 mm									
VT	With cartridge connection for regulator, 10 bar, scale psi/bar, display range 0...16 bar/0...232 psi, for regulator plate code ZA, ZB, ZC, ZD, ZE, ZK, ZL	18 mm	563731	PAGN-26-232P-P10					
		26 mm							
		42 mm				563733	PAGN-40-232P-P10		
		52 mm							
PS	With cartridge connection for regulator, 6 bar, scale psi/bar, display range 0...10 bar/0...145 psi, for regulator plate code ZF, ZG, ZH, ZI, ZJ, ZM, ZN	18 mm	563732	PAGN-26-145P-P10					
		26 mm							
		42 mm				563734	PAGN-40-145P-P10		
		52 mm							

Valve terminals VTSA/VTSA-F, NPT

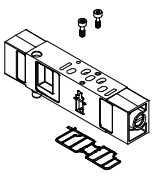
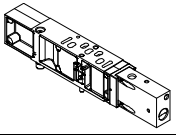
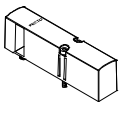

FESTO

Accessories – Pneumatic components

Ordering data				
	Code	Description	Part No.	Type
Cartridge for regulator plate				
	–	For tubing O.D. 4 mm	1 piece	172972 QSP10-4
	–	Adapter for pressure gauge (allows products with threaded connection G1/8 to be attached to the cartridge connection)	6 pieces	565811 QSP10-G1/8
Flow control plate				
	X	Controls the flow of exhaust air downstream of the valve to ducts 3 and 5	18 mm	540176 VABF-S4-2-F1B1-C
			26 mm	540175 VABF-S4-1-F1B1-C
			42 mm	546095 VABF-S2-1-F1B1-C
			52 mm	555789 VABF-S2-2-F1B1-C
Vertical pressure shut-off plate				
	ZT	2/2-way solenoid valve for shutting off the operating pressure at the valve position Pressure separation can be shut off on the mounted valve	18 mm	542884 VABF-S4-2-L1D1-C
			26 mm	542885 VABF-S4-1-L1D1-C
			42 mm	546096 VABF-S2-1-L1D1-C
			52 mm	555791 VABF-S2-2-L1D1-C
Cover				
	L	Blanking plate for vacant position	18 mm	539213 VABB-S4-2-WT
			26 mm	539212 VABB-S4-1-WT
			42 mm	543186 VABB-S2-1-WT
			52 mm	560845 VABB-S2-2-WT
	N	Cover cap for manual override, non-detenting	10 pieces	541010 VAMC-S6-CH
	V	Cover cap for manual override, covered	10 pieces	541011 VAMC-S6-CS
	–	End cap for electrical interlinking module (with individual connection), size 18 mm and 26 mm	10 pieces	547713 VABD-S4-E-C
	–	Seal (with individual connection), size 42 mm and 52 mm	2 pieces	571343 VABD-S2-1-S-C

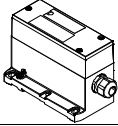

Valve terminals VTSA/VTSA-F, NPT

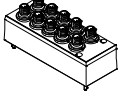
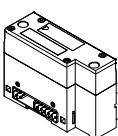
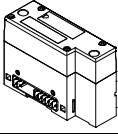
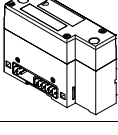
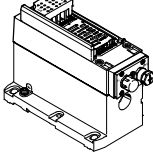
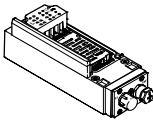
Accessories – Electrical components

Ordering data				
	Code	Description	Part No.	Type
Multi-pin node				
	T	Terminal strip, 36-pin	543412	VABE-S6-1LF-C-M1-C36M
	MP1	Sub-D plug, 37-pin	543414	VABE-S6-1LT-C-M1-S37
	MP4	Round plug, 19-pin	543415	VABE-S6-1LF-C-M1-R19
Individual electrical connection				
	-MP2	Multi-pin node with individual connection M12, 6-way	549046	VABE-S6-LT-C-S6-R5
	-MP3	Multi-pin node with individual connection M12, 10-way	549047	VABE-S6-LT-C-S10-R5
	-	Cover for individual connection M12, 6-way	549048	VAEM-S6-C-S6-R5
	-	Cover for individual connection M12, 10-way	549049	VAEM-S6-C-S10-R5
Pneumatic interface				
	-	For electrical terminal CPX in plastic design	543416	VABA-S6-1-X1
	-	For electrical terminal CPX in metal design	550663	VABA-S6-1-X2
	-	For electrical terminal CPX in metal design, with changed diagnostic function	573613	VABA-S6-1-X2-D
Electrical interface for AS-Interface				
	-	4 inputs/4 outputs	549042	VABE-S6-1LF-C-A4-E
	-	8 inputs/8 outputs	549043	VABE-S6-1LF-C-A8-E
AS-Interface module				
	-	4 inputs/4 outputs	549044	VAEM-S6-S-FAS-4-4E
	-	8 inputs/8 outputs	549045	VAEM-S6-S-FAS-8-8E



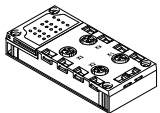

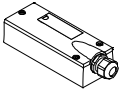
Valve terminals VTSA/VTSA-F, NPT

Accessories – Electrical components

Ordering data						
	Code	Description	Part No.	Type		
Connection block for AS-Interface						
	X	4x M12, 5-pin, double, socket	195704	CPX-AB-4-M12x2-5POL		
	GW	4x M12, 5-pin, socket, metal thread	541254	CPX-AB-4-M12x2-5POL-R		
	R	8x M8, 3-pin, socket	195706	CPX-AB-8-M8-3POL		
	J	8x spring-loaded terminal, Cage Clamp®, 4-pin	195708	CPX-AB-8-KL-4POL		
	H	4xHarax®, 4-pin, socket	525636	CPX-AB-4-HAR-4POL		
	B	Sub-D, 25-pin, socket	525676	CPX-AB-1-SUB-BU-25POL		
Connecting cable with Sub-D plug socket (polyurethane, IP65)						
	GA	Connecting cable for max. 8 solenoid coils, 10-pin	2.5 m	539240	NEBV-S1W37-E-2.5-LE10	
	GB		5 m	539241	NEBV-S1W37-E-5-LE10	
	GC		10 m	539242	NEBV-S1W37-E-10-LE10	
	GD	Connecting cable for max. 22 solenoid coils, 26-pin	2.5 m	539243	NEBV-S1W37-E-2.5-LE26	
	GE		5 m	539244	NEBV-S1W37-E-5-LE26	
	GF		10 m	539245	NEBV-S1W37-E-10-LE26	
	GG	Connecting cable for max. 32 solenoid coils, 37-pin	2.5 m	539246	NEBV-S1W37-K-2.5-LE37	
	GH		5 m	539247	NEBV-S1W37-K-5-LE37	
	GI		10 m	539248	NEBV-S1W37-K-10-LE37	
Connecting cable with Sub-D plug socket (polyvinyl chloride, IP65)						
	GK	Connecting cable for max. 8 solenoid coils, 10-pin	2.5 m	543271	NEBV-S1W37-KM-2.5-LE10	
	GL		Cable properties (standard)	5 m	543272	NEBV-S1W37-KM-5-LE10
	GM			10 m	543273	NEBV-S1W37-KM-10-LE10
	GN	Connecting cable for max. 23 solenoid coils, 27-pin	2.5 m	543274	NEBV-S1W37-KM-2.5-LE27	
	GO		Cable properties (standard)	5 m	543275	NEBV-S1W37-KM-5-LE27
	GP			10 m	543276	NEBV-S1W37-KM-10-LE27
	GQ	Connecting cable for max. 32 solenoid coils, 37-pin	2.5 m	543277	NEBV-S1W37-KM-2.5-LE37	
	GR		Cable properties (standard)	5 m	543278	NEBV-S1W37-KM-5-LE37
	GS			10 m	543279	NEBV-S1W37-KM-10-LE37
Cover for multi-pin plug						
	-	For user configuration	545974	NECV-S1W37		

Valve terminals VTSA/VTSA-F, NPT

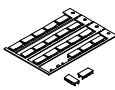
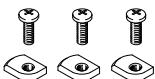
Accessories – General

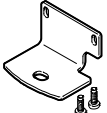
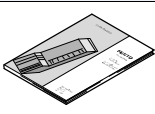



Ordering data					
	Code	Description	Part No.	Type	
Inscription label holder/inscription labels					
	B	Clip-on inscription label holder for valve cap	5 pieces	540888	ASCF-T-S6
	T	Inscription label holder for manifold blocks	5 pieces	540889	ASCF-M-S6
	TD	Inscription label holder for manifold blocks, size 52 mm	5 pieces	562577	ASCF-M-S2-2
	–	Inscription label (20 labels in frames)	20 pieces	18182	IBS-9x20
	–	Inscription label for pressure zone separation	3x4 pieces	8003303	ASLR-L-S6-2016
		<ul style="list-style-type: none"> • 4 inscription labels, duct 1/3/5 blocked • 4 inscription labels, duct 1 blocked • 4 inscription labels, duct 3/5 blocked 			
H-rail mounting					
	–	VTSA/VTSA-F	3 pieces	526032	CPX-CPA-BG-NRH
Wall mounting					
	–	Mounting bracket with mounting hole for screw M5	5 pieces	539214	VAME-S6-10-W
	U	Mounting bracket with mounting hole for screw M4 and mounting hole for screw M6	1 piece	567038	VAME-S6-W-M46
	AW	Mounting bracket for length compensation on the CPX side when mounting using support system Set comprising 1 angle bracket and 2 screws	1 piece	2721419	CPX-M-BG-VT-2X
User documentation					
	D	User documentation for valve terminal VTSA/VTSA-F	German	538922	P.BE-VTSA-44-DE
	E		English	538923	P.BE-VTSA-44-EN
	S		Spanish	538924	P.BE-VTSA-44-ES
	F		French	538925	P.BE-VTSA-44-FR
	I		Italian	538926	P.BE-VTSA-44-IT
	V		Swedish	538927	P.BE-VTSA-44-SV
Pneumatic connection accessories					
<p>A selection of possible fittings, blanking plugs, silencers and other pneumatic accessories can be found in the chapter Accessories → page 194 or on the Internet via the individual search terms:</p> <p>Internet → connection technology, silencer, blanking plug</p>					

Valve terminals VTSA/VTSA-F, NPT

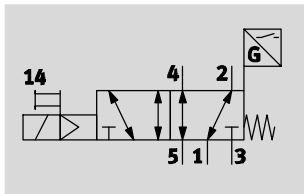
Technical data – Solenoid valve with switching position sensing

Function¹⁾



-  - Flow rate
Up to 1100 l/min
-  - Valve width
18 mm
26 mm
-  - Voltage
24 V DC
-  - Operating pressure
3 ... 10 bar

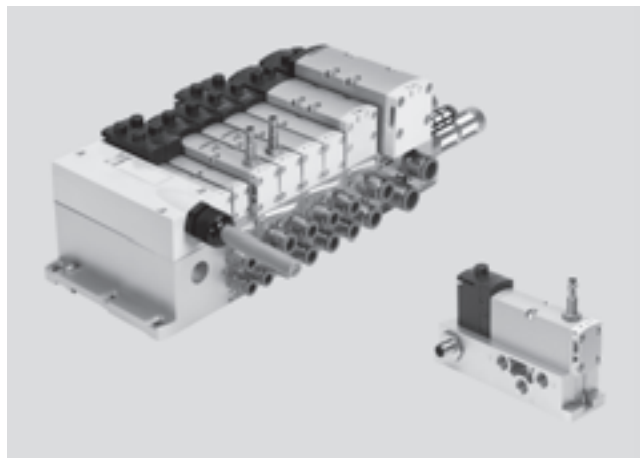

ISO valves with switching position sensing for safety-related pneumatic components

Function

The single solenoid 5/2-way valve with spring return in width 18 mm and 26 mm features valve diagnostics. Designed as a plug-in or individual connection valve with pilot valves to ISO 15218 and square plug type C. The normal position of the

piston spool is monitored by the inductive sensor. This valve is not a safety device in accordance with the Machinery Directive 2006/42/EC. When used in higher categories, the sensor signal from the valve must be evaluated by the control

system. This valve is suitable for use in safety-related parts of control systems to EN ISO 13849-1. The control block has been developed and manufactured in accordance with the basic

and proven safety principles of EN ISO 13849-2. This valve is designed for installation in machines and automation systems and must only be used in industrial applications (high-demand mode).

Decentralised individual connection variant

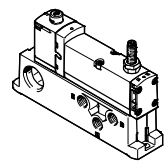

Valve on individual sub-base (square plug or plug-in), with integrated piston position sensing.

The electrical connection is established either via a standardised 4-pin M12 plug 24 V DC (ISO 15407-2), a 4-pin spring-loaded terminal or a cable (open end) 24 V DC/110 V AC,

which are configured by the user. The individual sub-base can be supplied with internal or external pilot air depending on the version.

Variant for valve terminal VTSA/VTSA-F

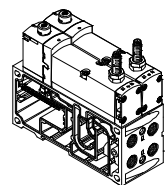

The valves with integrated piston position sensing in plug-in design for valve terminal VTSA/VTSA-F can be used regardless of the type of electrical actuation (individual, multi-pin plug or fieldbus/control block connection).

Pilot air supply:
The valve terminal can be supplied with internal or external pilot air via the various end plate variants.

-  - Note
Valves in plug-in design always get their pilot air from duct 14 in the manifold sub-base.

1) The circuit symbol represents a valve with a proximity sensor with switching output signal with an N/O contact. In accordance with ISO 1219-1, this symbol applies to both N/O contacts and N/C contacts. The switching element function of the sensors used here is designed as an N/C contact.

-  - Note
Pilot exhaust air port 12 vents directly at the valve, without a connection. If the customer requests a "turned seal", exhaust air is vented at the end plates of the valve terminal, which does not conform to the ISO standard.

Valve terminals VTSA/VTSA-F, NPT

Data sheet – Solenoid valve with switching position sensing

Safety characteristics	
Conforms to standard	EN 13849-1/2
Note on forced switch on/off	Min. 1/week
CE marking (see declaration of conformity)	In accordance with EU EMC Directive ¹⁾
Shock resistance	Shock test with severity level 2, to EN 60068-2-27
Vibration resistance	Transport application test with severity level 2, to EN 60068-2-6

- 1) For information about the applicability of the component see the manufacturer's EC declaration of conformity at: www.festo.com/sp → User documentation.
If the component is subject to restrictions on usage in residential, office or commercial environments or small businesses, further measures to reduce the emitted interference may be necessary.

Safety characteristics		
Valve function 5/2-way, single solenoid	Test pulses	
	Max. positive test pulse with 0 signal [μ s]	Max. negative test pulse with 1 signal [μ s]
VSVA-B-M52-MZD- ...	1200	1100
VSVA-B-M52-MZ- ...	1000	800

General technical data			
Valve	VSVA-B-M52-MZD-A2-1T1L-...	VSVA-B-M52-MZD-A1-1T1L-...	VSVA-B-M52-MZ-A1-1C1-...
Width	18 mm	26 mm	26 mm
Conforms to	ISO 15407-2		ISO 15407-1
Design	Piston spool valve		
Sealing principle	Soft		
Actuation type	Electric		
Type of control	Piloted		
Exhaust function, with flow control	Via individual sub-base, via flow control plate		
Lubrication	Life-time lubrication		
Type of mounting	Via through-hole, on manifold sub-base		
Mounting position	Any		
Manual override	Covered		
Individual sub-base			→185
Valve terminal			→64

Standard nominal flow rate [l/min]				
Valve function	Flow rate			
	Valve	Valve on valve terminal VTSA	Valve on valve terminal VTSA-F	Valve on individual sub-base
VSVA-B-M52-MZ-A1-1C1-ANC	1400	1100	–	1100
VSVA-B-M52-MZ-A1-1C1-ANP	1400	1100	–	1100
VSVA-B-M52-MZ-A1-1C1-APC	1400	1100	–	1100
VSVA-B-M52-MZ-A1-1C1-APP	1400	1100	–	1100
VSVA-B-M52-MZD-A1-1T1L-ANC	1400	1100	1350	1200
VSVA-B-M52-MZD-A1-1T1L-ANP	1400	1100	1350	1200
VSVA-B-M52-MZD-A1-1T1L-APC	1400	1100	1350	1200
VSVA-B-M52-MZD-A1-1T1L-APP	1400	1100	1350	1200
VSVA-B-M52-MZD-A1-1T1L-APX-0.5	1400	1100	1350	1200
VSVA-B-M52-MZD-A2-1T1L-ANP	750	550	700	600
VSVA-B-M52-MZD-A2-1T1L-APP	750	550	700	600
VSVA-B-M52-MZD-A2-1T1L-APX-0.5	750	550	700	600

Valve terminals VTSA/VTSA-F, NPT

Technical data – Solenoid valve with switching position sensing

Valve switching times [ms]				
Valve		VSVA-B-M52-MZD-A2-1T1L-...	VSVA-B-M52-MZD-A1-1T1L-...	VSVA-B-M52-MZ-A1-1C1-...
Width		18 mm	26 mm	26 mm
Valve switching times	On	12	20	21
	Off	38	54	41
Sensor switching times	On	32	60	60
	Off	9	11	11

Electrical data – Valve				
Valve		VSVA-B-M52-MZD-A2-1T1L-...	VSVA-B-M52-MZD-A1-1T1L-...	VSVA-B-M52-MZ-A1-1C1-...
Width		18 mm	26 mm	26 mm
Electrical connection		4-pin plug to ISO 15407-2		Plug to EN 175301-803, type C, without protective conductor
Nominal operating voltage	[V DC]	24		
Permissible voltage fluctuations	[%]	±10		-15/+10
Surge resistance	[kV]	2.5		
Degree of contamination		3		
Power consumption	[W]	1.6		1.8
Switching position sensing		Normal position via sensor		
Duty cycle	[%]	100		
Protection class to EN 60529		IP65, NEMA 4 (for all types of signal transmission in assembled state)		

Electrical data – Sensor	
Electrical connection	Cable, 3-wire
	Plug M8x1, 3-pin
Cable length	[m] 2.5
Switching output	PNP or NPN
Switching element function	N/C contact
Switching status display	Yellow LED
Operating voltage range	[V DC] 10 ... 30
Residual ripple	[%] ±10
Sensor idle current	[mA] ≤10
Max. output current	[mA] 200
Voltage drop	[V] ≤2
Max. switching frequency	[Hz] 5,000
Protection against short circuit	Pulsed
Protection against polarity reversal for sensor	For all electrical connections
Measuring principle	Inductive
Switching position sensing	Valve normal position via sensor

Valve terminals VTSA/VTSA-F, NPT

Technical data – Solenoid valve with switching position sensing

Operating and environmental conditions	
Operating medium	Compressed air to ISO 8573-1:2010 [7:4:4]
Notes about the operating/ pilot medium	Lubricated operation possible (in which case lubricated operation will always be required)
Operating pressure [bar]	-0.9 ... 10
Operating pressure for valve terminal with internal pilot air supply [bar]	3 ... 10
Pilot pressure [bar]	3 ... 10
Ambient temperature [°C]	-5 ... +50
Temperature of medium [°C]	-5 ... +50
Note on materials	RoHS-compliant
Noise level LpA [dB(A)]	85
CE marking (see declaration of conformity)	To EU EMC Directive ¹⁾
Fire protection classification to UL 94	HB
Approval certificate	c UL us – Recognized (OL), only for valve function (M52-MZD)
	C-Tick
	CSA (OL), only for valve function (M52-MZD)

- 1) For information about the applicability of the component see the manufacturer's EC declaration of conformity at: www.festo.com/sp → User documentation.
If the component is subject to restrictions on usage in residential, office or commercial environments or small businesses, further measures to reduce the emitted interference may be necessary.

Materials	
Sub-base/manifold sub-base	Die-cast aluminium
Valve	Die-cast aluminium, reinforced polyamide
Seals	Nitrile rubber, elastomer (support made of steel)
Screws	Galvanised steel
Sensor housing	High-alloy stainless steel
Sensor cable sheath	Polyurethane

Product weight		
Width	18 mm	26 mm
5/2-way solenoid valve type		
VSVA-B-M52-MZD-A2-1T1L-APX-0,5	157 g	–
VSVA-B-M52-MZD-A2-1T1L-APP	140 g	–
VSVA-B-M52-MZD-A2-1T1L-ANP	140 g	–
VSVA-B-M52-MZD-A1-1T1L-APC	–	307 g
VSVA-B-M52-MZD-A1-1T1L-APP	–	264 g
VSVA-B-M52-MZ-A1-1C1-APC	–	332 g
VSVA-B-M52-MZ-A1-1C1-APP	–	289 g
VSVA-B-M52-MZD-A1-1T1L-ANC	–	307 g
VSVA-B-M52-MZD-A1-1T1L-ANP	–	264 g
VSVA-B-M52-MZ-A1-1C1-ANC	–	332 g
VSVA-B-M52-MZ-A1-1C1-ANP	–	289 g
VSVA-B-M52-MZD-A1-1T1L-APX-0,5	–	281 g
Individual connection		
Individual sub-base	–	302 g

Valve terminals VTSA/VTSA-F, NPT

Technical data – Solenoid valve with switching position sensing

Dimensions

Download CAD data → www.festo.com

Solenoid valve with sensor, width 26 mm

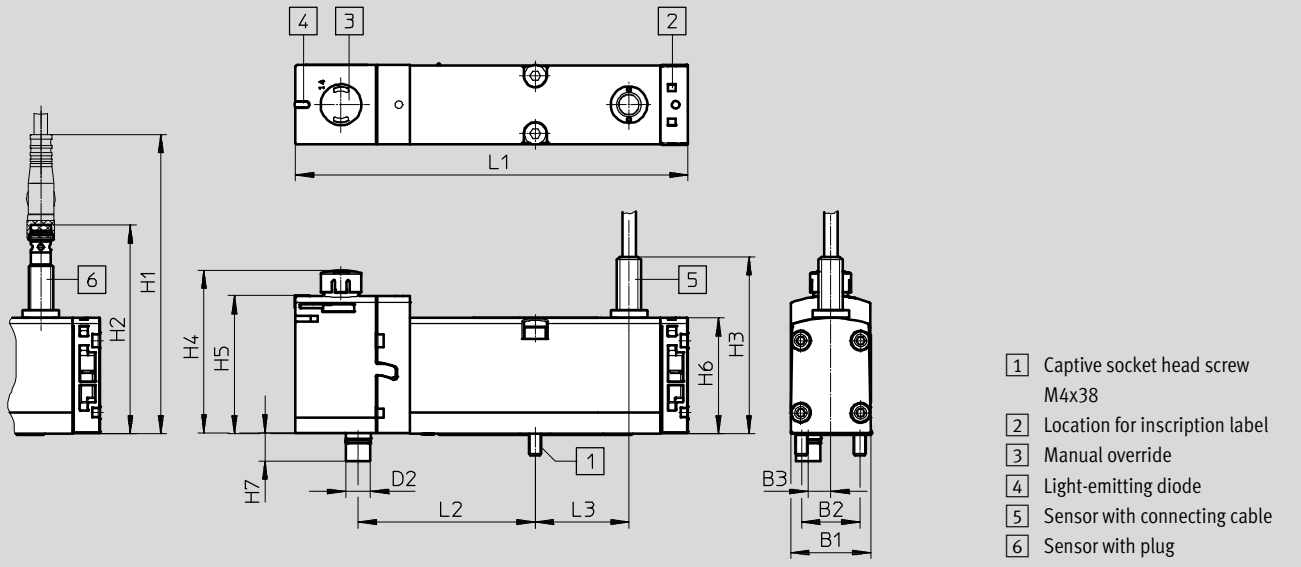

- 1 Captive socket head screw
M4x38
- 2 Location for inscription label
- 3 Manual override
- 4 Light-emitting diode
- 5 Sensor with connecting cable
- 6 Sensor with plug

Type	B1	B2	B3	D2	L1	L2	L3
VSVA-B-M52-MZD-A1-1T1L-...	26.2	19	7.4	8	128.9	58	30.7
VSVA-B-M52-MZD-A1-1T1L-APX-0.5							

Type	H1	H2	H3	H4	H5	H6	H7
VSVA-B-M52-MZD-A1-1T1L-...	98	68.2	58	52.5	45.3	38	9.2
VSVA-B-M52-MZD-A1-1T1L-APX-0.5							

Valve terminals VTSA/VTSA-F, NPT

Technical data – Solenoid valve with switching position sensing

Dimensions

Download CAD data → www.festo.com

Solenoid valve with sensor, with plug type C, width 26 mm

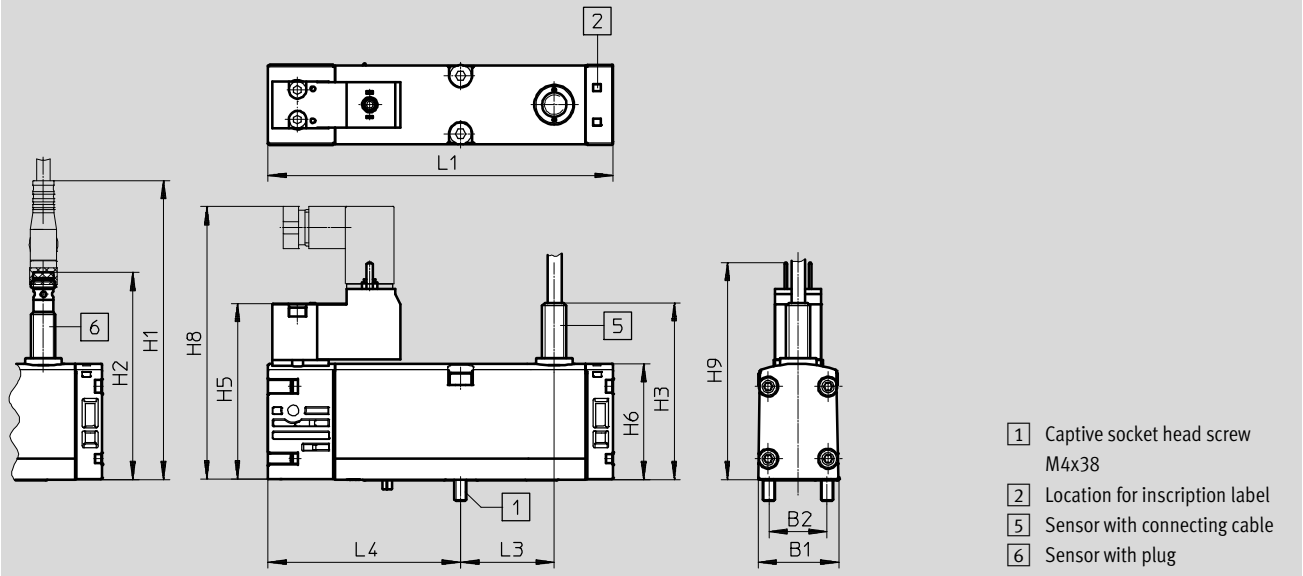

Type	B1	B2	L1	L3	L4
VSVA-B-M52-MZ-A1-1C1-...	26.2	19	113.1	30.7	63.1

Type	H1	H2	H3	H5	H6	H8	H9
VSVA-B-M52-MZ-A1-1C1-...	98	68.2	58	57.8	38	89.6	71.2

Valve terminals VTSA/VTSA-F, NPT

Ordering data – Solenoid valve with switching position sensing

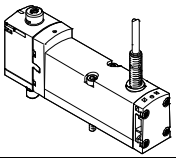
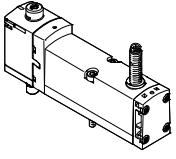
Ordering data – VSVA solenoid valve, MO non-detenting/detenting (D)					
	Code	Valve function	Width	Part No.	Type
5/2-way solenoid valve, 24 V DC, plug-in design for valve terminal VTSA/VTSA-F with proximity sensor					
	–	5/2-way valve, single solenoid, mechanical spring return, inductive sensor with PNP output and cable, 3-wire, 2.5 m	26 mm	560723	VSVA-B-M52-MZD-A1-1T1L-APC
	–	5/2-way valve, single solenoid, mechanical spring return, inductive sensor with NPN output and cable, 3-wire, 2.5 m	26 mm	560742	VSVA-B-M52-MZD-A1-1T1L-ANC
	SS	5/2-way valve, single solenoid, mechanical spring return, inductive sensor with PNP output with 0.5 m connecting cable and 4-pin sensor push-in connector M12x1	18 mm	573201	VSVA-B-M52-MZD-A2-1T1L-APX-0,5
			26 mm	570850	VSVA-B-M52-MZD-A1-1T1L-APX-0,5
	SO	5/2-way valve, single solenoid, mechanical spring return, inductive sensor with PNP output and 3-pin sensor push-in connector M8x1	18 mm	573202	VSVA-B-M52-MZD-A2-1T1L-APP
			26 mm	560724	VSVA-B-M52-MZD-A1-1T1L-APP
	SQ	5/2-way valve, single solenoid, mechanical spring return, inductive sensor with NPN output and 3-pin sensor push-in connector M8x1	18 mm	573203	VSVA-B-M52-MZD-A2-1T1L-ANP
			26 mm	560743	VSVA-B-M52-MZD-A1-1T1L-ANP

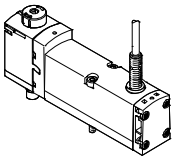
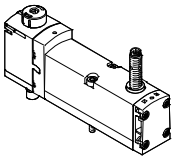
Ordering data – VSVA solenoid valve with cover cap for MO, non-detenting (H)					
	Code	Valve function	Width	Part No.	Type
5/2-way solenoid valve, 24 V DC, plug-in design for valve terminal VTSA/VTSA-F with proximity sensor					
	–	5/2-way valve, single solenoid, mechanical spring return, inductive sensor with PNP output and cable, 3-wire, 2.5 m	26 mm	8033049	VSVA-B-M52-MZH-A1-1T1L-APC
	–	5/2-way valve, single solenoid, mechanical spring return, inductive sensor with NPN output and cable, 3-wire, 2.5 m	26 mm	8033053	VSVA-B-M52-MZH-A1-1T1L-ANC
	SS	5/2-way valve, single solenoid, mechanical spring return, inductive sensor with PNP output with 0.5 m connecting cable and 4-pin sensor push-in connector M12x1	18 mm	8033477	VSVA-B-M52-MZH-A2-1T1L-APX-0.5
			26 mm	8033057	VSVA-B-M52-MZH-A1-1T1L-APX-0.5
	SO	5/2-way valve, single solenoid, mechanical spring return, inductive sensor with PNP output and 3-pin sensor push-in connector M8x1	18 mm	8033478	VSVA-B-M52-MZH-A2-1T1L-APP
			26 mm	8033050	VSVA-B-M52-MZH-A1-1T1L-APP
	SQ	5/2-way valve, single solenoid, mechanical spring return, inductive sensor with NPN output and 3-pin sensor push-in connector M8x1	18 mm	8033479	VSVA-B-M52-MZH-A2-1T1L-ANP
			26 mm	8033054	VSVA-B-M52-MZH-A1-1T1L-ANP

Valve terminals VTSA/VTSA-F, NPT

Ordering data – Solenoid valve with switching position sensing

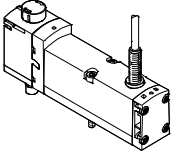
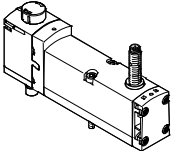
Ordering data – VSVA solenoid valve with cover cap for MO, covered					
	Code	Valve function	Width	Part No.	Type
5/2-way solenoid valve, 24 V DC, plug-in design for valve terminal VTSA/VTSA-F with proximity sensor					
	–	5/2-way valve, single solenoid, mechanical spring return, inductive sensor with PNP output and cable, 3-wire, 2.5 m	26 mm	8033072	VSVA-B-M52-MZ-A1-1T1L-APC
	–	5/2-way valve, single solenoid, mechanical spring return, inductive sensor with NPN output and cable, 3-wire, 2.5 m	26 mm	8033076	VSVA-B-M52-MZ-A1-1T1L-ANC
	SS	5/2-way valve, single solenoid, mechanical spring return, inductive sensor with PNP output with 0.5 m connecting cable and 4-pin sensor push-in connector M12x1	18 mm	8033495	VSVA-B-M52-MZ-A2-1T1L-APX-0.5
			26 mm	8033080	VSVA-B-M52-MZ-A1-1T1L-APX-0.5
	SO	5/2-way valve, single solenoid, mechanical spring return, inductive sensor with PNP output and 3-pin sensor push-in connector M8x1	18 mm	8033496	VSVA-B-M52-MZ-A2-1T1L-APP
			26 mm	8033073	VSVA-B-M52-MZ-A1-1T1L-APP
	SQ	5/2-way valve, single solenoid, mechanical spring return, inductive sensor with NPN output and 3-pin sensor push-in connector M8x1	18 mm	8033497	VSVA-B-M52-MZ-A2-1T1L-ANP
			26 mm	8033077	VSVA-B-M52-MZ-A1-1T1L-ANP

Valve terminals VTSA/VTSA-F, NPT

FESTO

Ordering data – Solenoid valve with switching position sensing

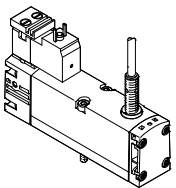
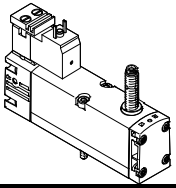
Ordering data					
	Code	Valve function	Width	Part No.	Type
Solenoid valves, 24 V DC, with pneumatic interface to ISO 15218 for individual sub-base					
	-	5/2-way valve, single solenoid, mechanical spring return, with switching position sensing via inductive sensor with PNP output and cable, 3-wire	26 mm	560725	VSVA-B-M52-MZ-A1-1C1-APC
	-	5/2-way valve, single solenoid, mechanical spring return, with switching position sensing via inductive sensor with NPN output and cable, 3-wire	26 mm	560744	VSVA-B-M52-MZ-A1-1C1-ANC
	-	5/2-way valve, single solenoid, mechanical spring return, with switching position sensing via inductive sensor with PNP output and 3-pin sensor push-in connector M8x1	26 mm	560726	VSVA-B-M52-MZ-A1-1C1-APP
	-	5/2-way valve, single solenoid, mechanical spring return, with switching position sensing via inductive sensor with NPN output and 3-pin sensor push-in connector M8x1	26 mm	560745	VSVA-B-M52-MZ-A1-1C1-ANP



-  - Note

- The sensors contained in the valves must not be replaced by the customer. Incorrect assembly can result in malfunctions or damage to the valve. Return the module to Festo for repair in the event of a fault.
- Valves with switching position sensing from the series VSVA-B-M52-... can only be ordered individually. If these are used on a valve terminal, appropriate vacant positions must be provided for them. Exceptions are the two valves with ident. code SO and SQ.

Valve terminals VTSA/VTSA-F, NPT



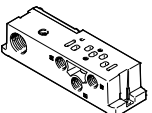

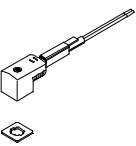
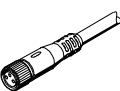
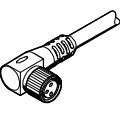
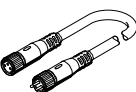
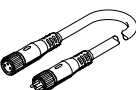
Accessories – Solenoid valve with switching position sensing

FESTO

Ordering data							
	Code	Description		Part No.	Type		
Individual sub-base, port pattern to ISO 15407-2, electrical connection via cable terminals							
	-	Threaded connection, internal pilot air supply, lateral connections	1/8" NPT	18 mm	541068	VABS-S4-2S-N18-B-K2	
			1/4" NPT	26 mm	541066	VABS-S4-1S-N14-B-K2	
	-	Threaded connection, external pilot air supply, lateral connections	1/8" NPT	18 mm	539724	VABS-S4-2S-N18-K2	
			1/4" NPT	26 mm	539726	VABS-S4-1S-N14-K2	
Plug socket for electrical connection of individual valves, type C							
	-	<ul style="list-style-type: none"> Angled socket, type C, 3-pin Straight plug, PG7 230 V AC 			151687	MSSD-EB	
						539712	MSSD-EB-M12
Illuminating seal for plug pattern EN 175301-803, type C							
	-	For plug socket MSSD, 12 ... 24 V DC			151717	MEB-LD-12-24DC	
Connecting cable for electrical connection of individual valves, type C							
	GG	<ul style="list-style-type: none"> Angled socket, type C, 3-pin, with LED Open end, 3-wire 24 V DC, PVC 		2.5 m	151688	KMEB-1-24-2,5-LED	
	GH			5 m	151689	KMEB-1-24-5-LED	
	GJ			10 m	193457	KMEB-1-24-10-LED	
Connecting cable for electrical connection of sensors for switching position sensing							
	GM	<ul style="list-style-type: none"> Straight socket, M8x1, 3-pin Open end, 3-wire 		2.5 m	541333	NEBU-M8G3-K-2,5-LE3	
	GN			5 m	541334	NEBU-M8G3-K-5-LE3	
	GO	<ul style="list-style-type: none"> Angled socket, M8x1, 3-pin Open end, 3-wire 		2.5 m	541338	NEBU-M8W3-K-2,5-LE3	
	GP			5 m	541341	NEBU-M8W3-K-5-LE3	
	-		<ul style="list-style-type: none"> Angled socket, rotatable, M8x1, 3-pin Open end, 3-wire 		2.5 m	8001660	NEBU-M8R3-K-2.5-LE3
	-		<ul style="list-style-type: none"> Angled socket, rotatable, M8x1, 3-pin Open end, 3-wire 		5 m	8001661	NEBU-M8R3-K-5-LE3
	GQ	<ul style="list-style-type: none"> Straight socket, M8x1, 3-pin Straight plug, M8x1, 4-pin 		2.5 m	554037	NEBU-M8G3-K-2,5-M8G4	
	-	Modular system for connecting cables		-	-	NEBU-... → Internet: nebu	
Pneumatic connection accessories							
A selection of possible fittings, blanking plugs, silencers and other pneumatic accessories can be found in the chapter Accessories → page 194 or on the Internet via the individual search terms: Internet → connection technology, silencer, blanking plug							

Valve terminals VTSA/VTSA-F, NPT

Technical data – Control block with safety function

-  - Flow rate on valve terminal: 830 l/min
-  - Solenoid valve width 26 mm
-  - Voltage 24 V DC
-  - Operating pressure 3 ... 10 bar

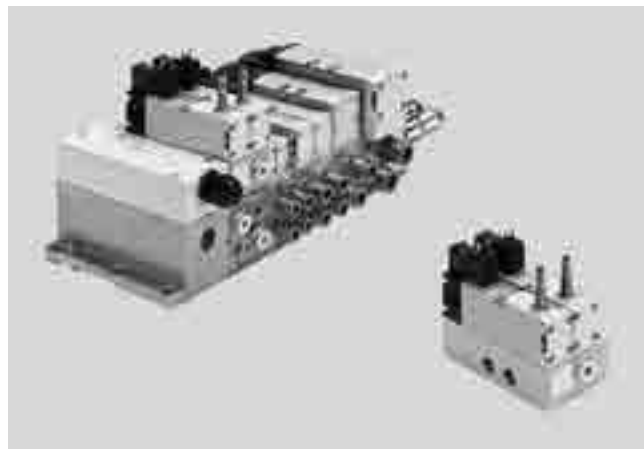

Description

The control block is designed for two-channel actuation of pneumatic drive components such as double-acting linear cylinders, for example, and can be used to realise the following protective measures:

- Protection against unexpected start-up (EN 1037)
- Reversing hazardous movements, provided the reversing motion will not result in further hazards

The control block has attributes for that enable Performance Level e to be achieved for the safety measures. The control block has been developed and manufactured in accordance with the basic and proven safety principles of EN ISO 13849-1 and EN ISO 13849-2.

The requirements of EN ISO 13849-1 and EN ISO 13849-2 (e.g. CCF, DC) must be taken into consideration for implementation and operation of the component and for use in higher categories (2 to 4). When using this product in machines or systems subject to specific C standards, the requirements specified in these standards must be observed.

The control block with safety function is designed for installation in machines and automation systems and must only be used in industrial applications (high-demand mode). The control block with safety function is suitable for use as a press safety valve to EN 962.

More information and technical data
 → Internet: user documentation

Version for valve terminal VTSA/VTSA-F

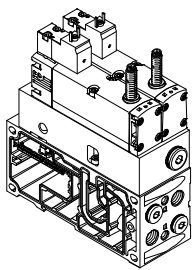

The valves with integrated piston position sensing on manifold sub-base for valve terminal VTSA/VTSA-F need to be supplied with electrical power regardless of the type of electrical actuation (individual, multi-pin plug or fieldbus/control block connection).

The electrical connection for the solenoid valves is established separately via a standardised square plug to EN 175301-803, type C. The piston position sensing feature of the inductive PNP or NPN proximity sensor is realised using a push-in connector in the size M8x1 to EN 61076-2-104.

Note

The appropriate manifold sub-base VABV-S4- ..., which is required for integration into the valve terminal, is not part of the control block. It is automatically allocated by the configurator on selection of the control block.

Note

The control block with safety function (VOFA) is also available as a decentralised individual connection variant with electrical and pneumatic

individual connection. For information see:
 → Internet: vofa

Valve terminals VTSA/VTSA-F, NPT

Data sheet – Control block with safety function

Pneumatic/electrical interlinking

Function

The safety function is achieved through two-channel pneumatic interlinking of two 5/2-way single solenoid valves within the control block: port (4) is only pressurised if both solenoid valves are switched to switching position (14).

Port (2) is always pressurised if at least one of the two solenoid valves is

in normal position. The valve is reset via a mechanical spring.

The switching operation of the solenoid valves can be monitored by sensing via the proximity sensors at the solenoid valves (switching position sensing).

This is done by means of a logic

operation of the control signal and the signal change of the proximity sensor to check whether the piston spools of the solenoid valves are reaching or leaving the normal position (expectations).

The piston spools of the solenoid valves are designed so that pneumatic

short circuits between ports (2) and (4) are ruled out (freedom from overlap).

The two solenoid valves must be actuated via two separate ducts to achieve the desired category 4 (Performance Level e, to EN ISO 13849-1).

Circuit symbol¹⁾

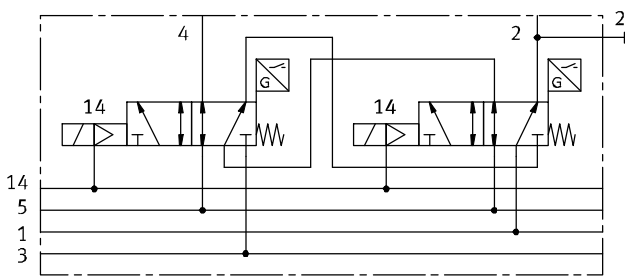

For the control block with safety function VOFA-B26-T52-... for the valve terminal, there is two-channel pneumatic interlinking of two 5/2-way solenoid

valves, width 26 mm, with the intermediate plate as vertical stacking (output 2 is switched in parallel, output 4 is switched in series).

1) The circuit symbol represents a valve with a proximity sensor with switching output signal with an N/O contact. In accordance with ISO 1219-1, this symbol applies to both N/O contacts and N/C contacts. The switching element function of the sensors used here is designed as an N/C contact.

Safety characteristics

Conforms to standard	EN 13849-1
Safety function	Protection against manipulation, prevention of unexpected start-up Reversing a movement
Performance Level (PL)	Protection against manipulation, prevention of unexpected start-up (up to category 4, Performance Level e) Reversing a movement/to category 4, Performance Level e
Proven component	Yes
Note on forced switch on/off	Min. 1/week
Certificate issuing authority	IFA 1001179
CE marking (see declaration of conformity)	To EU EMC Directive ¹⁾ To EC Machinery Directive
Max. positive test pulse with 0 signal [µs]	1000
Max. negative test pulse with 1 signal [µs]	800
Shock resistance	Shock test with severity level 2, to EN 60068-2-27
Vibration resistance	Transport application test with severity level 2, to EN 60068-2-6

1) For information about the applicability of the component see the manufacturer's EC declaration of conformity at: www.festo.com/sp → User documentation.
If the component is subject to restrictions on usage in residential, office or commercial environments or small businesses, further measures to reduce the emitted interference may be necessary.

Valve terminals VTSA/VTSA-F, NPT

Technical data – Control block with safety function

General technical data	
Design	Piston spool valve
Standard nominal flow rate [l/min]	830
Reset method	Mechanical spring
Sealing principle	Soft
Exhaust function	With flow control
Actuation type	Electric
Non-overlapping	Yes
Type of control	Piloted
Direction of flow	Non-reversible
Exhaust function	With flow control
Suitability for vacuum	–
Nominal size [mm]	9
Pilot air supply	Via valve terminal
Type of mounting	Via through-hole, on manifold sub-base
Mounting position	Any
Manual override	–
Valve switching status display	Via accessories
Pneumatic connections	
Supply port 1	Via the manifold sub-base of the valve terminal
Exhaust port 3/5	
Working ports 2/4	
Pilot air supply 14	
Pressure gauge	G $\frac{1}{4}$

Operating and environmental conditions	
Operating medium	Compressed air to ISO 8573-1:2010 [7:4:4]
Pilot medium	Compressed air to ISO 8573-1:2010 [7:4:4]
Notes about the operating/pilot medium	Lubricated operation possible (in which case lubricated operation will always be required)
Operating pressure [bar]	0 ... 10
Operating pressure for valve terminal with internal pilot air supply [bar]	3 ... 10
Pilot pressure [bar]	3 ... 10
Noise level LpA [dB(A)]	85
Ambient temperature [°C]	–5 ... +50
Temperature of medium [°C]	–5 ... +50
Corrosion resistance class CRC	0
CE marking (see declaration of conformity)	To EU EMC Directive ¹⁾
	To EC Machinery Directive

1) For information about the applicability of the component see the manufacturer's EC declaration of conformity at: www.festo.com/sp → User documentation.
If the component is subject to restrictions on usage in residential, office or commercial environments or small businesses, further measures to reduce the emitted interference may be necessary.

Valve terminals VTSA/VTSA-F, NPT

Technical data – Control block with safety function

Electrical data – Control block			
Electrical connection		Plug to EN 175301-803, type C, without protective conductor	
Nominal operating voltage	[V DC]	24	
Permissible voltage fluctuations	[%]	-15/+10	
Surge resistance	[kV]	2.5	
Degree of contamination		3	
Power consumption	[W]	1.8	
Max. magnetic interference field	[mT]	60	
Switching position sensing		Normal position via sensor	
Duty cycle	[%]	100	
Protection class to EN 60529		IP65, NEMA 4 (for all types of signal transmission in assembled state)	
Protection against direct and indirect contact		PELV Protected to EN 60950/IEC 950	
Valve switching time	On	[ms]	22
	Off	[ms]	59
Valve sensor switching time ¹⁾	On	[ms]	60
	Off	[ms]	11

- 1) Valve sensor switching time off: period of time from coil being energised to sensor being switched off when using a PNP sensor.
Valve sensor switching time on: period of time from coil being de-energised to 0-L edge at the sensor when using a PNP sensor.



Note

With a duty cycle of 100%, the control block must be de-energised once per week.

Electrical data – Sensor (to EN-60947-5-2)	
Electrical connection	
Cable, 3-wire	
Plug M8x1, 3-pin	
Cable length	[m] 2.5
Switching output	
PNP or NPN	
Switching element function	
N/C contact	
Switching status display	
Yellow LED	
Operating voltage range	[V DC] 10 ... 30
Residual ripple	[%] ±10
Sensor idle current	[mA] Max. 10
Max. output current	[mA] 200
Voltage drop	[V] Max. 2
Max. switching frequency	[Hz] 5,000
Protection against short circuit	
Pulsed	
Protection against polarity reversal for sensor	
For all electrical connections	
Measuring principle	
Inductive	

Materials	
Sub-base/manifold sub-base	Wrought aluminium alloy
Valve	Die-cast aluminium, PA
Seals	FPM, NBR, HNBR
Screws	Galvanised steel
Sensor housing	High-alloy stainless steel
Sensor cable sheath	PUR
Note on materials	RoHS-compliant

Valve terminals VTSA/VTSA-F, NPT

Technical data – Control block with safety function

Dimensions Download CAD data → www.festo.com

Version for valve terminal VTSA/VTSA-F

1 Proximity sensor PNP or NPN, size M8x1, plug connection to EN 61076-2-104

2 Electrical connection to EN 175301-803, type C

3 Pneumatic connection G $\frac{1}{4}$ sealed with blanking plug

4 2x screw with internal hex (2.5 A/F), M4x12 (included in the scope of delivery)

Type	B1	B2	B3	H1	H2	H3	L1	L2	L3	L4
VOFA-B26-T52-M-1C1-APP	53	46	37	105.8	34.6	17	133.7	128.5	109.2	78.5
VOFA-B26-T52-M-1C1-ANP										

Ordering data							
Valve function	Code	Switching output	Width [mm]	Weight [g]	Part No.	Type	
Control block, version for valve terminal VTSA/VTSA-F							
<p>2x 5/2-way valve, single solenoid, mechanical spring return, with switching position sensing via inductive sensor and 3-pin sensor push-in connector M8, mounted on intermediate plate for pneumatic interlinking</p>	SP ²⁾	PNP	53	1112	- ¹⁾	VOFA-B26-T52-M-1C1-APP	
	SN ²⁾	NPN	53	1112	- ¹⁾	VOFA-B26-T52-M-1C1-ANP	

1) The control block with safety function can only be ordered via the valve terminal configurator and therefore does not have a separate part number. The appropriate and necessary manifold sub-base for valve terminal VTSA/VTSA-F is automatically allocated to the control block by the configurator.
 2) Code letter within the order code for a valve terminal configuration.



Note

The sensors contained in the valves must not be replaced by the customer. Incorrect assembly can result in malfunctions or damage to the valve. Please contact Festo in the event of a malfunction.

Valve terminals VTSA/VTSA-F, NPT

Accessories – Control block with safety function

FESTO

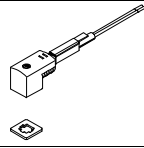
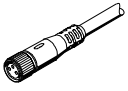
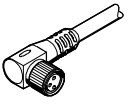
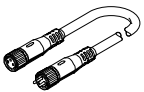
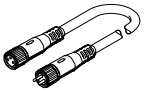
Ordering data				
	Code	Description	Part No.	Type
Plug socket for electrical connection of individual valves, type C				
	–	<ul style="list-style-type: none"> Angled socket, type C, 3-pin Straight plug, PG7 230 V AC 	151687	MSSD-EB
	–	<ul style="list-style-type: none"> Angled socket, type C, 3-pin Straight plug, M12x1 	539712	MSSD-EB-M12
Illuminating seal for plug pattern to EN 175301-803, type C				Technical data → Internet: meb-ld
	–	For plug socket MSSD, 12 ... 24 V DC	151717	MEB-LD-12-24DC
Connecting cable for electrical connection of individual valves, type C				
	GG	<ul style="list-style-type: none"> Angled socket, type C, 3-pin, with LED Open end, 3-wire 	2.5 m	151688 KMEB-1-24-2,5-LED
	GH	<ul style="list-style-type: none"> 24 V DC, PVC 	5 m	151689 KMEB-1-24-5-LED
	GJ		10 m	193457 KMEB-1-24-10-LED
Connecting cable for electrical connection of sensors for switching position sensing				
	GM	<ul style="list-style-type: none"> Straight socket, M8x1, 3-pin Open end, 3-wire 	2.5 m	541333 NEBU-M8G3-K-2,5-LE3
	GN	<ul style="list-style-type: none"> Straight socket, M8x1, 3-pin Open end, 3-wire 	5 m	541334 NEBU-M8G3-K-5-LE3
	GO	<ul style="list-style-type: none"> Angled socket, M8x1, 3-pin Open end, 3-wire 	2.5 m	541338 NEBU-M8W3-K-2,5-LE3
	GP	<ul style="list-style-type: none"> Angled socket, M8x1, 3-pin Open end, 3-wire 	5 m	541341 NEBU-M8W3-K-5-LE3
	–	<ul style="list-style-type: none"> Angled socket, rotatable, M8x1, 3-pin Open end, 3-wire 	2.5 m	8001660 NEBU-M8R3-K-2,5-LE3
	–	<ul style="list-style-type: none"> Angled socket, rotatable, M8x1, 3-pin Open end, 3-wire 	5 m	8001661 NEBU-M8R3-K-5-LE3
	GQ	<ul style="list-style-type: none"> Straight socket, M8x1, 3-pin Straight plug, M8x1, 4-pin 	2.5 m	554037 NEBU-M8G3-K-2,5-M8G4
	–	Modular system for connecting cables	–	NEBU-... → Internet: nebu
Pneumatic connection accessories				
<p>A selection of possible fittings, blanking plugs, silencers and other pneumatic accessories can be found in the chapter Accessories → page or on the Internet via the individual search terms:</p> <p>Internet → connection technology, silencer, blanking plug</p>				

Valve terminals VTSA/VTSA-F, NPT

Technical data – Pilot air switching valve, width 18 mm, 26 mm

Function¹⁾

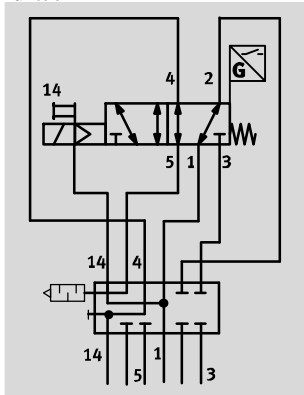

- - Flow rate
150 l/min (18 mm)
450 l/min (26 mm)
- - Valve width
18 mm
26 mm
- - Voltage
24 V DC
- - Operating pressure
-0.9 ... 10 bar

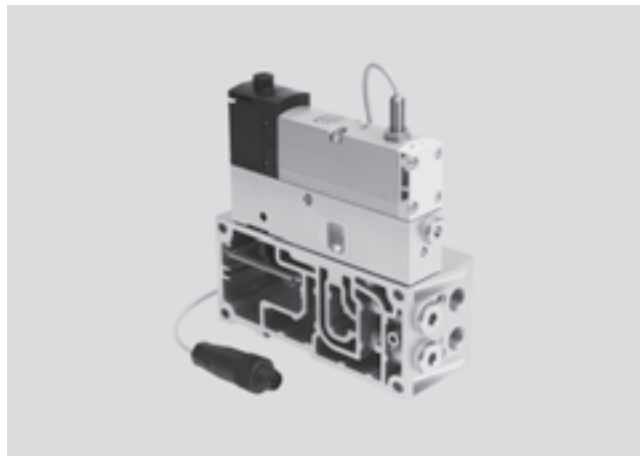

Description

The pilot air switching valve is essentially a combination of a 5/2-way solenoid valve with switching position sensing and the intermediate plate VABF-S4-...-S. It enables verifiable switching on and off (sensor function) of the pilot air supply from duct 1 to 14 for the entire pressure zone or

valve terminal. This valve is not a safety device in accordance with the Machinery Directive 2006/42/EC. When used in higher categories, the sensor signal from the valve must be evaluated by the control system.

This valve is suitable for use in safety-related parts of control systems to EN ISO 13849-1. This valve is designed for installation in machines and automation systems and must

only be used in industrial applications (high-demand mode). More information and technical data → Internet: user documentation

Alternative switching position sensing with pressure switch

As an alternative to the sensor function in the solenoid valve, a pressure switch can be mounted (instead of the

blanking plug) in the intermediate plate VABF-S4-...-S. This pressure switch enables verifiable switching on

and off (sensor function) of the pilot air supply. An ISO solenoid valve without a sensor can therefore be

mounted on the intermediate plate for the same function. → Internet: spba

- - Note

The pilot air switching valve can only be operated on the valve terminal VTSA/VTSA-F in combination with a right-hand end plate for external

pilot air type VABE-S6-1RZ-... . Port 14 on the right-hand end plate must be sealed for this.

Vertical stacking variant for valve terminal VTSA/VTSA-F, width 18 mm, 26 mm

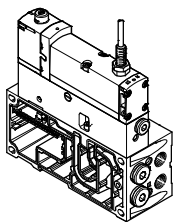

The valves with integrated piston position sensing in plug-in design for valve terminal VTSA/VTSA-F can be used regardless of the type of electrical actuation (individual, multi-pin plug or fieldbus/control block connection). This module is supplied pre-

assembled together with the valve terminal VTSA/VTSA-F. No other assembly steps are required before installation.

The piston position sensing feature is realised by means of an inductive PNP proximity sensor with cable and

push-in connector in the size M12x1 to EN 61076-2-104.

Alternatively, combinations with the pressure switch in the intermediate plate and ISO solenoid valves are possible.

- - Note

All solenoid valves VSVA to ISO 15407-1 can be used.

→ Internet: vsva

1) The circuit symbol represents a valve with a proximity sensor with switching output signal with an N/O contact. In accordance with ISO 1219-1, this symbol applies to both N/O contacts and N/C contacts. The switching element function of the sensors used here is designed as an N/C contact.

Valve terminals VTSA/VTSA-F, NPT

Data sheet – Pilot air switching valve, width 18 mm, 26 mm

Function – Pneumatic/electrical interlinking

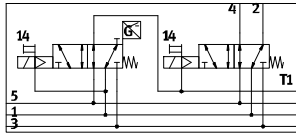

The function for switching off the pilot air is essentially achieved by combining the intermediate plate type VABF-S4-...-S with the 5/2-way single solenoid valve type VSVA-B-M52-MZD-...-1T1L-APX-0,5. The valve terminal is not supplied with any pilot air via the right-hand end plate type VABE-S6-1 (ident. code XS, external pilot air). Port 14 on the end plate is sealed.

The pilot air for the valve is branched from duct (1) in the intermediate plate

and redirected to the pilot air duct (14) of the valve terminal when the valve is in the switching position. Ports (2) and (4) of the manifold sub-base are sealed with blanking plugs.

The switching operation of the solenoid valve can be monitored by sensing via the proximity sensor in the solenoid valve (or pressure switch in the intermediate plate VABF...).

This is done by means of a logic operation of the control signal and the signal change of the proximity sensor

to check whether the piston spools of the solenoid valves are reaching or leaving the normal position (expectations).

The piston spool of the solenoid valve is designed so that pneumatic short circuits between ports (2) and (4) are ruled out (freedom from overlap).

Alternatively, combinations with the pressure switch in the intermediate plate and ISO solenoid valves are possible.



Note

A valve from the VTSA/VTSA-F modular system can be planned or configured to the right of the valve

with piston position sensing on the intermediate plate of the pilot air switching valve.

Pilot air switching valve with integrated piston position sensing

The pilot air switching valve can be ordered as a combination of a 5/2-way solenoid valve with switching position sensing and the intermediate plate VABF-S4-...-S.

Alternative switching position sensing with pressure switch

As an alternative to the pilot air switching valve with integrated piston position sensing, a combination of ISO solenoid valve and pressure switch in the intermediate plate is possible.

Various 5/2-way solenoid valves are available in combination with a pressure switch SPBA-... for this purpose.

Safety characteristics

Conforms to standard	EN 13849-1/2
Note on forced switch on/off	Min. 1/week
CE marking (see declaration of conformity)	In accordance with EU EMC Directive ¹⁾
Shock resistance	Shock test with severity level 2, to EN 60068-2-27
Vibration resistance	Transport application test with severity level 2, to EN 60068-2-6

1) For information about the applicability of the component see the manufacturer's EC declaration of conformity at: www.festo.com/sp → User documentation.
If the component is subject to restrictions on usage in residential, office or commercial environments or small businesses, further measures to reduce the emitted interference may be necessary.

Safety characteristics

Valve function 5/2-way, single solenoid	Test pulses	
	Max. positive test pulse with 0 signal [μs]	Max. negative test pulse with 1 signal [μs]
VSVA-B-M52-MZD- ...	1200	1100
VSVA-B-M52-MZD-A2 ... (without sensor)	1500	800
VSVA-B-M52-MZ- ...	1000	800

Valve terminals VTSA/VTSA-F, NPT

Technical data – Pilot air switching valve, width 18 mm, 26 mm

General technical data		
	Intermediate plate type VABF-S4-2-S and solenoid valve type VSVA-B-M52-MZD-A2-1T1L-APX-0,5 mounted on valve terminal VTSA/VTSA-F	Intermediate plate type VABF-S4-1-S and solenoid valve type VSVA-B-M52-MZD-A1-1T1L-APX-0,5 mounted on valve terminal VTSA/VTSA-F
Width	18 mm	26 mm
Design	Piston spool valve	
Sealing principle	Soft	
Actuation type	Electric	
Type of control	Piloted	
Type of mounting: Solenoid valve on intermediate plate Intermediate plate on manifold sub-base	M3 M3x12 (captive)	M4 M4x12 (captive)
Mounting position	Any	
Pneumatic connections		
Supply port	1	Via the manifold sub-base of the valve terminal
Exhaust port	3/5	Via the manifold sub-base of the valve terminal
Working ports	2/4	Sealed with blanking plug type B-1/4
Pilot air supply	14	Via the manifold sub-base of the valve terminal
Pressure gauge/pressure switch		G $\frac{1}{8}$

Switching times [ms]			
Width		18 mm	26 mm
Valve type		5/2	5/2
Identifier		MZD-A2	MZD-A1
Valve switching time	On	12	20
	Off	38	54
Valve sensor switching time ¹⁾	On	32	60
	Off	9	11

1) Valve sensor switching time off: period of time from coil being energised to sensor being switched off when using a PNP sensor.
Valve sensor switching time on: period of time from coil being de-energised to 0-L edge at the sensor when using a PNP sensor.

Protective circuit

Each VSVA solenoid coil is provided with a spark arresting protective circuit and protected against polarity reversal.

24 V DC version

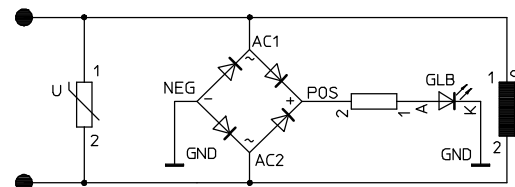

Valve terminals VTSA/VTSA-F, NPT

Technical data – Pilot air switching valve, width 18 mm, 26 mm

Peripherals overview

Pilot air switching valve with piston position sensing

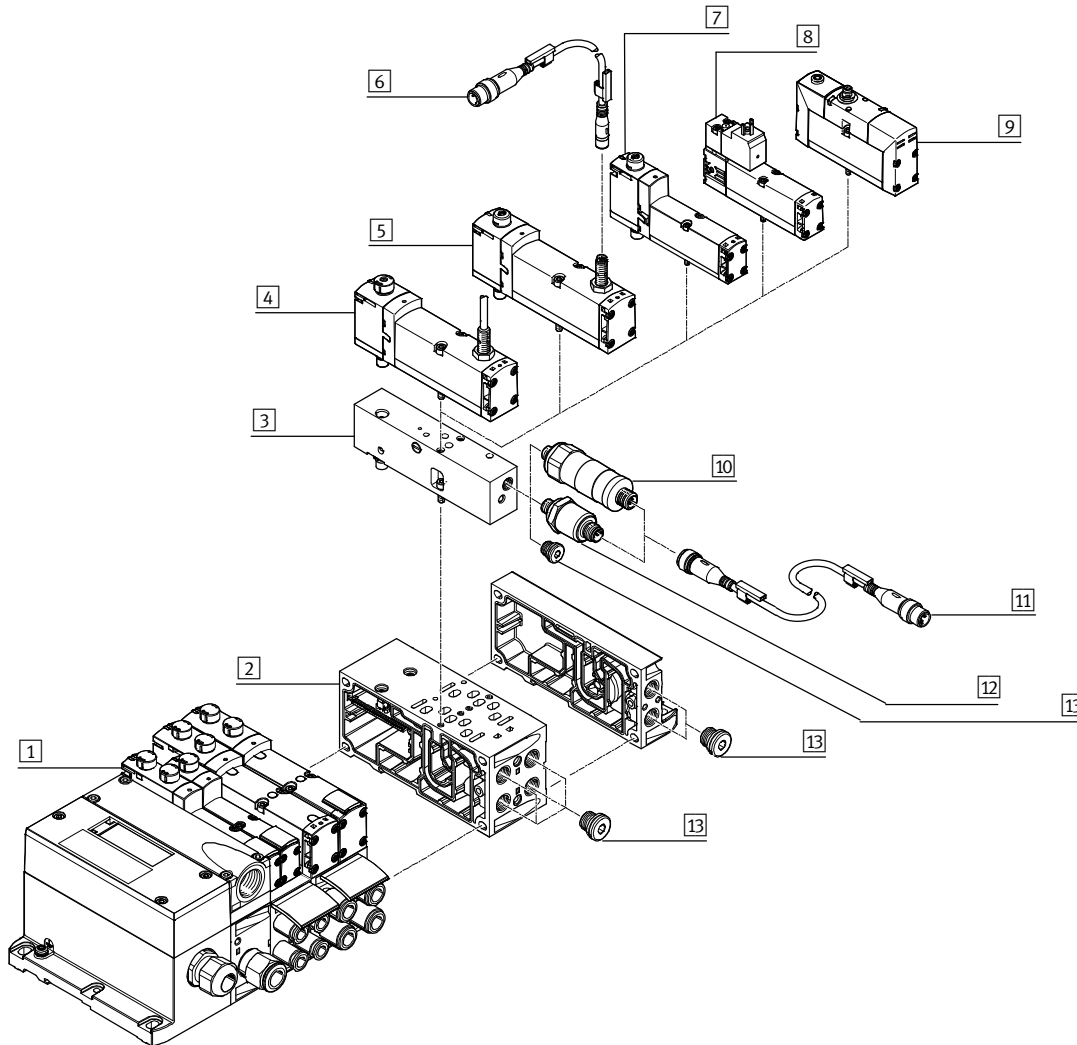

Peripherals overview – Pilot air switching valve

	Brief description	→ Page/Internet	
1	Valve terminal VTSA/VTSA-F	Valve terminal with multi-pin plug interface	vtsa
2	Manifold sub-base VABF-...	Width 18 mm or 26 mm	150
3	Intermediate plate VABF-S4-...	For pilot air switching valve	150
4	Solenoid valve VSVA-B-M52-...	Width 18 mm or 26 mm, with sensor and integrated cable 0.5 m	150
5	Solenoid valve VSVA-B-M52-...	Width 18 mm or 26 mm, with sensor for external connecting cable	150
6	Connecting cable NEBU-M8 ...	For connection to sensor	151
7	Solenoid valve VSVA-B-M52-...	Width 18 mm or 26 mm ¹⁾	150
8	Solenoid valve VSVA-B-M52-...	Width 18 mm or 26 mm, with plug to EN 175301, type C ¹⁾	150
9	Solenoid valve VSVA-B-M52-...	Width 18 mm or 26 mm, with round plug ¹⁾	vsva
10	Pressure switch SPBA-...	Mechanically actuated	151
11	Connecting cable NEBU-M12G5-...	For connection to pressure switch	151
12	Pressure switch SPBA-...	Electrically actuated	151
13	Blanking plug	–	194

1) The switching position sensing function is performed with pressure switches when using solenoid valves without integrated sensor. The pressure switch is screwed into the intermediate plate instead of the blanking plug.

Valve terminals VTSA/VTSA-F, NPT

FESTO

Technical data – Pilot air switching valve, width 18 mm, 26 mm

Electrical data – Pilot air switching valve		
Nominal operating voltage	[V DC]	24
Permissible voltage fluctuations	[%]	±10
Surge resistance	[kV]	2.5
Degree of contamination		3
Power consumption	[W]	1.6 W
Max. magnetic interference field	[mT]	60
Switching position sensing		Normal position via sensor
Duty cycle	[%]	100
Protection class		IP65, NEMA 4 (for all types of signal transmission in assembled state)

Electrical data – Sensor						
Sensor identifier		APP	ANP	APC	ANC	APX
Switching output		PNP	NPN	PNP	NPN	PNP
Sensor connection		Plug, M8x1, 3-pin		With fixed cable and open end		With fixed cable and plug M12x1, 4-pin
Cable length	[m]	0.5 (with socket M8x1, plug M12x1)		2.5		0.5
Switching element function		N/C contact				
Switching status display		Yellow LED (on sensor)				
Operating voltage range	[V DC]	10 ... 30				
Residual ripple	[%]	±10				
Rated operating voltage	[V DC]	24				
Max. idle current	[mA]	10				
Max. output current	[mA]	200				
Max. voltage drop	[V]	2				
Max. switching frequency	[Hz]	5000				
Protection against short circuit		Pulsed				
Protection against incorrect polarity		For all electrical connections				
Measuring principle		Inductive				
Switching position sensing		Valve normal position via sensor				

Valve terminals VTSA/VTSA-F, NPT

Technical data – Pilot air switching valve, width 18 mm, 26 mm

FESTO



Operating and environmental conditions	
Operating medium	Compressed air to ISO 8573-1:2010 [7:4:4]
Notes about the operating/ pilot medium	Lubricated operation possible (in which case lubricated operation will always be required)
Operating pressure [bar]	-0.9 ... 10
Noise level LpA [dB(A)]	85
Ambient temperature [°C]	-5 ... +50
Temperature of medium [°C]	-5 ... +50
Fire protection classification to UL94	HB (not part nos.: 539159, 539185)
Note on materials	RoHS-compliant
Approval certificate	c UL us – Recognized (OL), only for valve function (M52-MZD)
	C-Tick (not part nos.: 539159, 539185)
	CSA (OL), only for valve function (M52-MZD)

Materials	
Sub-base/manifold sub-base	Die-cast aluminium
Valve	Die-cast aluminium, PA
Seals	FPM, NBR
Screws	Galvanised steel
Sensor housing	High-alloy stainless steel
Sensor cable sheath	TPE-U(PUR)

Product weight		
Width	18 mm	26 mm
5/2-way solenoid valve type...		
VSVA-B-M52-MZD-A1-1T1L-APC	-	307 g
VSVA-B-M52-MZD-A1-1T1L-APP	-	264 g
VSVA-B-M52-MZ-A1-1C1-APC	-	332 g
VSVA-B-M52-MZ-A1-1C1-APP	-	289 g
VSVA-B-M52-MZD-A1-1T1L-ANC	-	307 g
VSVA-B-M52-MZD-A1-1T1L-ANP	-	264 g
VSVA-B-M52-MZ-A1-1C1-ANC	-	332 g
VSVA-B-M52-MZ-A1-1C1-ANP	-	289 g
VSVA-B-M52-MZD-A1-1T1L-APX-0.5	-	281 g
VSVA-B-M52-MZD-A2-1T1L-APX-0.5	157 g	-
VSVA-B-M52-MZD-A2-1T1L-APP	140 g	-
VSVA-B-M52-MZD-A2-1T1L-ANP	140 g	-
VSVA-B-M52-MZD-A1-1T1L	-	293 g
VSVA-B-M52-MZD-A2-1T1L	163 g	-
Intermediate plate		
VABF-S4-2-S	203.5 g	-
VABF-S4-1-S	-	295 g

Valve terminals VTSA/VTSA-F, NPT

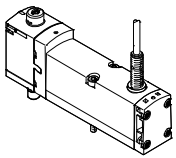
Ordering data – Pilot air switching valve, width 18 mm, 26 mm

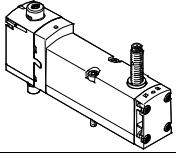
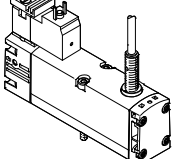
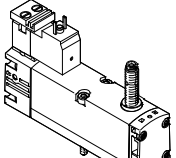
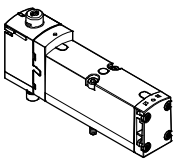
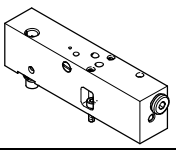
Ordering data		Code	Valve function	Part No.	Type	
5/2-way solenoid valve, 24 V DC, plug-in design for valve terminal VTSA/VTSA-F with proximity sensor						
	SS	5/2-way valve, single solenoid, mechanical spring return, with 0.5 m connecting cable and 4-pin sensor push-in connector M12x1	PNP	18 mm	573201	VSVA-B-M52-MZD-A2-1T1L-APX-0,5
				26 mm	570850	VSVA-B-M52-MZD-A1-1T1L-APX-0,5
	-	5/2-way valve, single solenoid, mechanical spring return, with 2.5 m connecting cable	PNP	26 mm	560723	VSVA-B-M52-MZD-A1-1T1L-APC
			NPN	26 mm	560742	VSVA-B-M52-MZD-A1-1T1L-ANC
	-	5/2-way valve, single solenoid, mechanical spring return, with 3-pin sensor push-in connector M8x1	PNP	18 mm	573202	VSVA-B-M52-MZD-A2-1T1L-APP
				26 mm	560724	VSVA-B-M52-MZD-A1-1T1L-APP
			NPN	18 mm	573203	VSVA-B-M52-MZD-A2-1T1L-ANP
				26 mm	560743	VSVA-B-M52-MZD-A1-1T1L-ANP
	-	5/2-way valve, single solenoid, mechanical spring return, with plug to EN 175301, type C, with 2.5 m connecting cable	PNP	26 mm	560725	VSVA-B-M52-MZ-A1-1C1-APC
			NPN	26 mm	560745	VSVA-B-M52-MZ-A1-1C1-ANP
	-	5/2-way valve, single solenoid, mechanical spring return, with plug to EN 175301, type C, with 3-pin sensor push-in connector M8x1	PNP	26 mm	560726	VSVA-B-M52-MZ-A1-1C1-APP
			NPN	26 mm	560744	VSVA-B-M52-MZ-A1-1C1-ANC
5/2-way solenoid valve, 24 V DC, plug-in design for valve terminal VTSA/VTSA-F						
	-	5/2-way valve, single solenoid, mechanical spring return		26 mm	539159	VSVA-B-M52-MZD-A1-1T1L
				18 mm	539185	VSVA-B-M52-MZD-A2-1T1L
Intermediate plate for pilot air switching valve for valve terminal VTSA/VTSA-F						
	ZO	Intermediate plate, for switching the pilot air from duct 1 to 14		18 mm	573200	VABF-S4-2-S
				26 mm	570851	VABF-S4-1-S

 **Note**

Further solenoid valves with switching position sensing can be ordered as distinct types. These are preconfigured with the required MO

cover caps.
→ Solenoid valve with switching position sensing page 140

 **Note**



The sensors contained in the valves must not be replaced by the customer. Incorrect assembly can

result in malfunctions or damage to the valve. Please contact Festo in the event of a malfunction.

Valve terminals VTSA/VTSA-F, NPT

Ordering data – Pilot air switching valve, width 18 mm, 26 mm

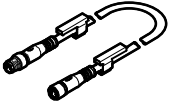
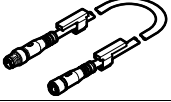
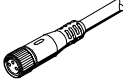
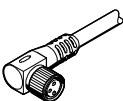
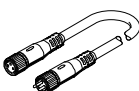
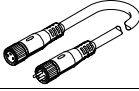
FESTO

Ordering data				
	Code	Description	Part No.	Type
Pressure switch for intermediate plate for pilot air switching valve				
	WL	Mechanical pressure switch for switchable pilot air supply (only in combination with intermediate plate ZO), with plug M12x1, 4-pin	8000033	SPBA-P2R-G18-W-M12-0,25X
	WH	Electrical pressure switch for switchable pilot air supply, switching output 2xPNP (only in combination with intermediate plate ZO), with plug M12x1, 4-pin	8000210	SPBA-P2R-G18-2P-M12-0,25X
Connecting cable for connection of pressure switches				
	GE	<ul style="list-style-type: none"> Straight socket, M12x1, 5-pin Straight plug, M12x1, 4-pin 	0.5 m	8000208 NEBU-M12G5-K-0.5-M12G4
Connecting cable for electrical connection of sensors for switching position sensing				
	–	<ul style="list-style-type: none"> Straight socket, M8x1, 3-pin Straight plug, M12x1, 3-pin 	0.5 m	8000209 NEBU-M8G3-K-0.5-M12G3
	GM	<ul style="list-style-type: none"> Straight socket, M8x1, 3-pin Open end, 3-wire 	2.5 m	541333 NEBU-M8G3-K-2,5-LE3
	GN	<ul style="list-style-type: none"> Straight socket, M8x1, 3-pin Open end, 3-wire 	5 m	541334 NEBU-M8G3-K-5-LE3
	GO	<ul style="list-style-type: none"> Angled socket, M8x1, 3-pin Open end, 3-wire 	2.5 m	541338 NEBU-M8W3-K-2,5-LE3
	GP	<ul style="list-style-type: none"> Angled socket, M8x1, 3-pin Open end, 3-wire 	5 m	541341 NEBU-M8W3-K-5-LE3
	–	<ul style="list-style-type: none"> Angled socket, rotatable, M8x1, 3-pin Open end, 3-wire 	2.5 m	8001660 NEBU-M8R3-K-2.5-LE3
	–	<ul style="list-style-type: none"> Angled socket, rotatable, M8x1, 3-pin Open end, 3-wire 	5 m	8001661 NEBU-M8R3-K-5-LE3
	GQ	<ul style="list-style-type: none"> Straight socket, M8x1, 3-pin Straight plug, M8x1, 4-pin 	2.5 m	554037 NEBU-M8G3-K-2,5-M8G4
	–	Modular system for connecting cables	–	– NEBU-... → Internet: nebu
Cover				
	N	Cover cap for manual override, non-detenting	10 pieces	541010 VAMC-S6-CH
	V	Cover cap for manual override, covered	10 pieces	541011 VAMC-S6-CS
Pneumatic connection accessories				
A selection of possible fittings, blanking plugs, silencers and other pneumatic accessories can be found in the chapter Accessories → page 194 or on the Internet via the individual search terms: Internet → connection technology, silencer, blanking plug				

Valve terminals VTSA/VTSA-F, NPT



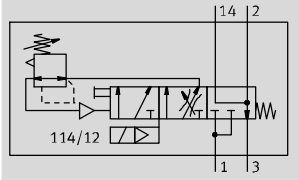

Technical data – Soft-start valve, width 43 mm

Function without sensor

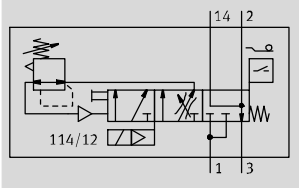

with sensor



-  - Flow rate
Pressurisation: 3000 l/min
Exhausting: 3300 l/min
-  - Module width
43 mm
-  - Temperature range
-5 ... +50 °C
-  - Operating pressure
2 ... 12 bar

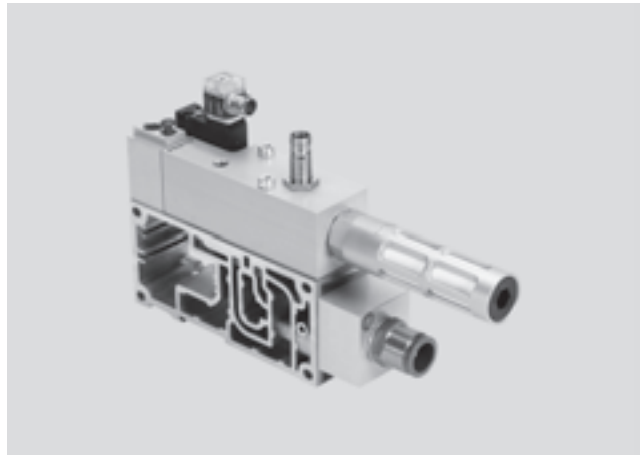

Description

Function

The purpose of the soft-start valve is to slowly and safely build up the supply pressure in duct 1 of the valve terminal or to quickly exhaust it. Switch-on takes place in two stages:

- First the working pressure provided for duct 1 gradually increases (the speed can be adjusted using a flow control screw).

- Once the working pressure in duct 1 reaches a previously set value, the soft-start valve switches the full operating pressure at duct 1 of the valve terminal.
The switching point for full operating pressure is set to 4 bar at the factory, but can be changed using an adjusting screw.

The full operating pressure is applied to duct 14 (pilot air) at all times. This pressure causes the valves on the valve terminal to move immediately to the required switching position; no undefined status is possible. Duct 1 of the valve terminal is exhausted via the soft-start valve's exhaust port only in the normal

position, when the valve is not switched. The exhaust air can optionally be ducted with a QS fitting or using a silencer. A detenting manual override with self-reset via an electrical control signal is available for maintenance and service purposes.

Note

When using "Protection against unexpected start-up":
Protection against unexpected

activation of the manual override (MO) must be guaranteed in all operating modes.

Diagnostics

The piston position of the soft-start valve can be monitored by a sensor with integrated LED display. This sensor registers whether the valve has

switched and thus whether the valve terminal is being supplied with air. Pressure sensing via a pressure gauge (optional) is also possible.

The soft-start valve can alternatively be ordered with a sensor. Due to the calibration that is required, there is no provision for subsequent

retrofitting of a sensor. Connecting cables with integrated LED display are provided for displaying the signal status.

Pilot air supply

The valve terminal can either be supplied with internal pilot air via the soft-start valve or with internal or external pilot air via the various end

plate variants. The type of pilot air supply is determined by the seal of the soft-start valve.

The scope of delivery of the soft-start valve includes both the seal for internal pilot air supply (with hole)

and the seal for external pilot air supply (without hole).

Creation of pressure zones with a soft-start valve

The soft-start valve can be used for the pneumatic compressed air supply of the valve terminal or of a pressure zone. The soft-start valve may only be used as the single compressed air supply component on valve terminals

with a pressure zone or within a pressure zone. If a soft-start valve in combination with a right-hand end plate (code XP3) is chosen for a pressure zone, a supply plate with a blanking plug in

duct 1 (code W) is required in this pressure zone. When using a soft-start valve, an air supply plate (with blanking plug in duct 1) is generally also required for this pressure zone for removal of the

exhaust air (duct 3/5). An air supply plate is not required if the exhaust air (duct 3/5) in a pressure zone with soft-start valve can be removed via the right-hand end plate.

Valve terminals VTSA/VTSA-F, NPT

Data sheet – Soft-start valve, width 43 mm

Restrictions

Compressed air supply	Exhaust air	Pilot air supply	Reverse operation
There must be no other elements supplying compressed air in the pressure zone in which the soft-start valve is being operated.	Exhaust air cannot be discharged via the soft-start valve. If it is being used in a pressure zone with duct 3/5 separated, an exhaust plate is required.	If internal pilot air supply (duct 14) via the soft-start valve is chosen, there must be no other pilot air supply within the valve terminal.	The soft-start valve is not approved for reverse operation.



Note

Setting options as well as drawings with descriptions of the components for the soft-start valve can be found in the user documentation. The adjusting screws are freely accessible in the built-in state.

General technical data

Design	Piston spool valve
Actuation type	Electric
Sealing principle	Soft
Type of mounting	On sub-base, ISO size 1 to ISO 5599-2
Mounting position	Any
Valve function	Soft-start function
Manual override	Detenting, self-resetting via electrical control signal, normal position on top → page156
Reset method	Mechanical spring
Type of control	Piloted
Pilot air supply	Internal, external
Direction of flow	Non-reversible
Piston position sensing	Switching position via sensor

Standard nominal flow rate [l/min]

Pressurisation	3000
Exhausting	3300

Operating and environmental conditions

Type	VABF-S6-1-P5A4-...-1	VABF-S6-1-P5A4-...-2A
Operating medium	Compressed air to ISO 8573-1:2010 [7:4:4]	
Notes about the operating/pilot medium	Lubricated operation possible (in which case lubricated operation will always be required)	
Operating pressure [bar]	2 ... 12	2 ... 10
Switchover pressure [bar] presetting	4	
Ambient temperature [°C]	-5 ... +50	
Note on materials	Conforms to RoHS	
CE marking (see declaration of conformity)	-	To EU Low Voltage Directive

Valve terminals VTSA/VTSA-F, NPT

Technical data – Soft-start valve, width 43 mm

Valve switching times [ms]		
Valve switching time	On	17
	Off	50

Electrical data – Soft-start valve		
Type	VABF-S6-1-P5A4-...-1	VABF-S6-1-P5A4-...-2A
Electrical connection	Plug type C to EN 175301-803, square design	
Nominal operating voltage [V]	24 DC	110 AC
Operating voltage range [V]	24 DC $\pm 10\%$	110 AC $\pm 10\%$
Coil characteristics	24 V DC: 2.5 W	110/120 V AC: 50/60 Hz, 3.0 VA pick-up power 110/120 V AC: 50/60 Hz, 2.4 VA holding capacity
Protection class to EN 60529	IP65, NEMA 4 (for all types of signal transmission in assembled state)	

Electrical data – Sensor		
Type	SIEN-M12B-PS-S-L	SIEN-M12B-NS-S-L
Electrical connection	Plug M12x1 to EN 60947-5-2, 4-pin	
Switching output	PNP	NPN
Switching element function	N/O contact	
Switching status display	Yellow LED	
Operating voltage range [V DC]	10 ... 30	
Residual ripple [%]	± 10	
Rated operating voltage [V DC]	24	
Sensor idle current [mA]	10	
Max. output current [mA]	200	
Max. voltage drop [V]	2	
Max. switching frequency [Hz]	3,000	
Protection against short circuit	Pulsed	
Protection against polarity reversal for sensor	For all electrical connections	
Measuring principle	Inductive	
Piston position sensing	Switching position via sensor	

Materials – Soft-start valve	
Housing	Wrought aluminium alloy
Seals	NBR, HNBR
Screws	Galvanised steel

Valve terminals VTSA/VTSA-F, NPT

Technical data – Soft-start valve, width 43 mm

Example 1: Pressure zone with soft-start valve and pilot air supply

Internal, external pilot air supply

Requirements

- Compressed air supply via soft-start valve
- Right-hand end plate¹⁾: blanking plug in duct 1

For internal pilot air supply:

- Seal (soft-start valve - manifold sub-base) with pilot air supply hole "open" and
- Right-hand end plate: blanking plug in duct 14

For external pilot air supply:

- Seal (soft-start valve - manifold sub-base) with pilot air supply hole "closed" and
- Pilot air supply via duct 14 in the right-hand end plate

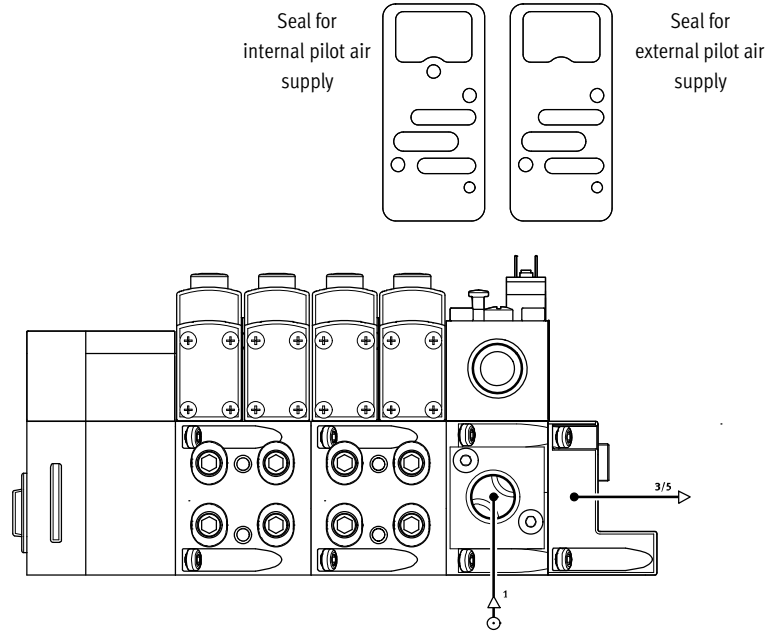

1) With this configuration, a right-hand end plate with pilot air selector is not possible, as it does not allow the discharge of exhaust air

Example 2: Pressure zone with soft-start valve, supply plate and pilot air supply

Internal, external pilot air supply

Requirements

- Compressed air supply via soft-start valve
- Supply plate: blanking plug in duct 1
- Right-hand end plate: blanking plug in duct 1, 3, 5 or
- Right-hand end plate with pilot air selector

For internal pilot air supply:

- Seal (soft-start valve - manifold sub-base) with pilot air supply hole "open" and
- Right-hand end plate: blanking plug in duct 14 or
- End plate with coding (position 2, internal pilot air supply)

For external pilot air supply:

- Seal (soft-start valve - manifold sub-base) with pilot air supply hole "closed" and
- Pilot air supply via duct 14 in the right-hand end plate or
- End plate with coding (position 1, external pilot air supply)

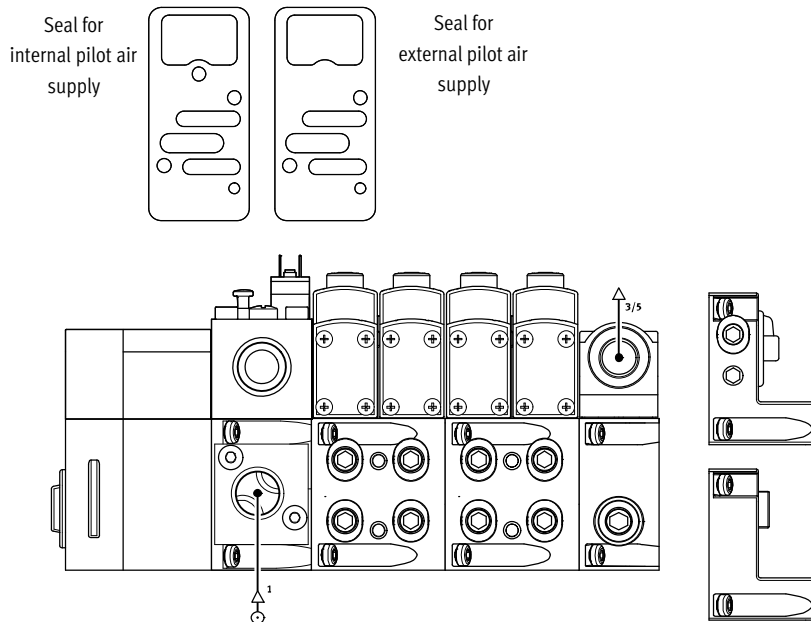

Valve terminals VTSA/VTSA-F, NPT

Technical data – Soft-start valve, width 43 mm

Dimensions

Download CAD data → www.festo.com

Soft-start valve

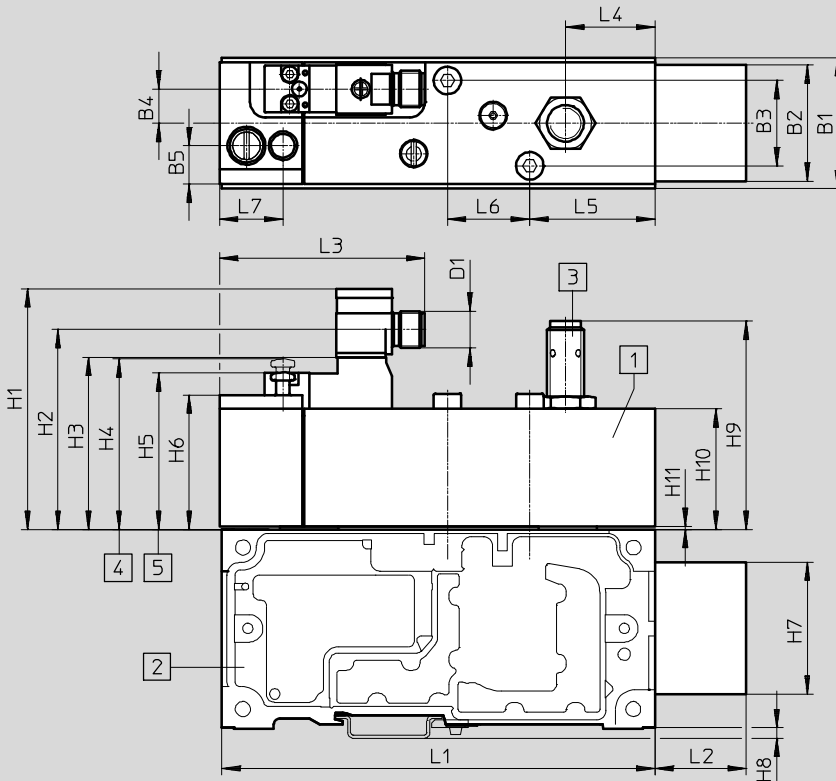

- 1 Soft-start valve, (port pattern to ISO 5599-2)
- 2 Manifold sub-base with connecting adapter (ducts 2 and 4), pneumatic connection 1/2" NPT
- 3 Soft-start valve optionally with sensor or protective cap
- 4 Normal position (not actuated)
- 5 Switching position (actuated)

Type	B1	B2	B3	B4	B5	D1	L1	L2	L3	L4	L5	L6	L7
VABF-S6-1-P5A4-N12-4- ...	43	36.5	28	11.2	12.6	M12x1	142	30	67.3	29.3	41	27	20.8

Type	H1	H2	H3	H4	H5	H6	H7	H8	H9	H10	H11
VABF-S6-1-P5A4-N12-4- ...	78.9	65.5	56.4	55.9	51.5	44	41.2	3.5	68.3	39.5	1

Seal¹⁾ between soft-start valve and manifold sub-base

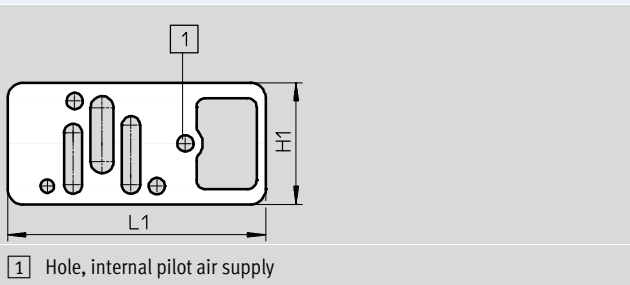

1 Hole, internal pilot air supply

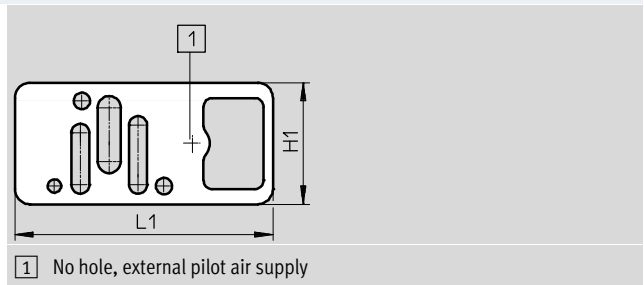

1 No hole, external pilot air supply

Type	H1	L1
VABD-S6- ...	40	84.8

1) Seals included with the manifold sub-base

Valve terminals VTSA/VTSA-F, NPT



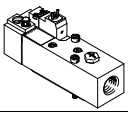
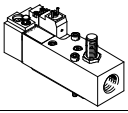
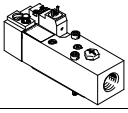
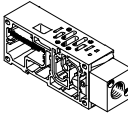





Technical data – Soft-start valve, width 43 mm

Ordering data				
	Description	Weight [g]	Part No.	Type
Soft-start valve, 24 V DC				
	Without sensor output, pneumatic connection 1/2" NPT	590	558231	VABF-S6-1-P5A4-N12-4-1
	With sensor output PNP, pneumatic connection 1/2" NPT	605	558232	VABF-S6-1-P5A4-N12-4-1-P
	With sensor output NPN, pneumatic connection 1/2" NPT	605	558234	VABF-S6-1-P5A4-N12-4-1-N
Soft-start valve, 110 V AC				
	Without sensor output, pneumatic connection 1/2" NPT	590	558229	VABF-S6-1-P5A4-N12-4-2A
Manifold sub-base				
	Prepared for mounting of a soft-start valve (ports for ducts 2 and 4 combined), pneumatic connection 1/2" NPT	570	556988	VABV-S6-1Q-N12

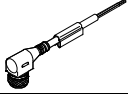
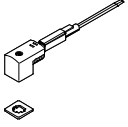
Valve terminals VTSA/VTSA-F, NPT

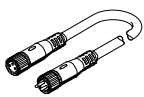
FESTO

Accessories – Soft-start valve, width 43 mm



Ordering data					
Name	Code	Description	Part No.	Type	
Cover cap					
	–	M12, for sealing the sensor opening	10 pieces	165592	ISK-M12
Electrical connection for soft-start valve					
	P1	<ul style="list-style-type: none"> Angled socket, type C, 2-pin, with LED Straight plug, M12x1, 2-pin 24 V DC 		188024	MSSD-EB-M12-MONO
	GB	<ul style="list-style-type: none"> Straight socket, M12x1, 5-pin Open end, 4-wire 	5 m	541328	NEBU-M12G5-K-5-LE4
	–	<ul style="list-style-type: none"> Angled socket, M12x1, 5-pin Open end, 4-wire 	5 m	541329	NEBU-M12W5-K-5-LE4
	GG	<ul style="list-style-type: none"> Angled socket, type C, 3-pin, with LED 	2.5 m	151688	KMEB-1-24-2,5-LED
	GH	<ul style="list-style-type: none"> Open end, 3-wire 	5 m	151689	KMEB-1-24-5-LED
	GJ	<ul style="list-style-type: none"> 24 V DC, PVC 	10 m	193457	KMEB-1-24-10-LED
	GK	<ul style="list-style-type: none"> Angled socket, type C, 3-pin 	2.5 m	151690	KMEB-1-230AC-2,5
	GL	<ul style="list-style-type: none"> Open end, 3-wire 230 V AC, PVC 	5 m	151691	KMEB-1-230AC-5
Connecting cable for electrical connection of the proximity sensor					
	–	<ul style="list-style-type: none"> Straight socket, M12x1, 5-pin Open end, 4-wire 	5 m	541328	NEBU-M12G5-K-5-LE4
	GC	<ul style="list-style-type: none"> Angled socket, M12x1, 5-pin Open end, 4-wire 	5 m	541329	NEBU-M12W5-K-5-LE4
	–	Modular system for connecting cables		–	NEBU... → Internet: nebu
Pressure gauge					
	–	0 ... 10 bar, pneumatic connection M5		526323	MA-27-10-M5
Silencer					
	U	Standard version, connecting thread NPT (1 piece)	1/2" NPT	6844	U-1/2-B
	A	Sintered version, connecting thread NPT (10 pieces)	1/2" NPT	1205863	AMTE-M-LH-G12
Pneumatic connection accessories					
<p>A selection of possible fittings, blanking plugs, silencers and other pneumatic accessories can be found in the chapter Accessories → page or on the Internet via the individual search terms:</p> <p>Internet → connection technology, silencer, blanking plug</p>					

Valve terminals VTSA/VTSA-F, NPT

Technical data – Vacuum block

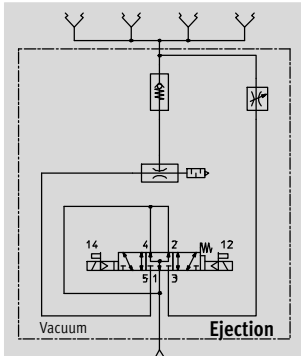
Function



-  - Width, vacuum block 53 mm
-  - Voltage 24 V DC
-  - Operating pressure 4 ... 8 bar

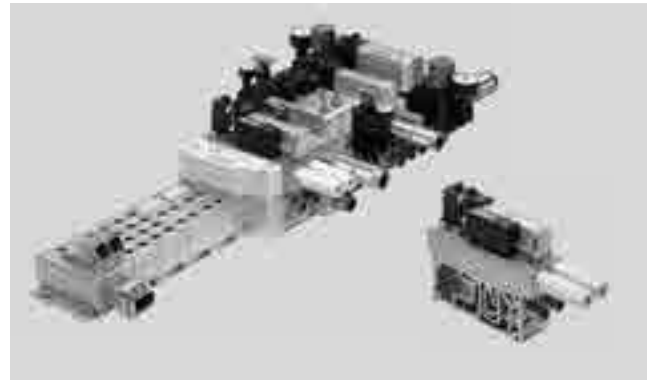

Description

The vacuum block can be integrated into the existing valve terminal VTSA/VTSA-F. To do this, the vacuum block is screwed to a manifold sub-base for 2 valve positions, width 26 mm. The vacuum block is used in conjunction

with a suction gripper to pick up, hold and place components. Picking up and holding is carried out by means of a vacuum by a suction gripper. Once the component has been positioned,

it is released by an an ejector pulse. This ejector pulse is created by pressurising the vacuum system so that the vacuum briefly breaks down. The ejector pulse is adjustable.

 - Note
The vacuum block VABF-S4-1-V2B1 can be operated in combination with the vertical stacking for pilot air switch-off (intermediate plate VABF-S4-1-S plus 5/2-way valve) on the valve terminal VTSA.

Function

The intended use of the vacuum block VABF-S4-1-V2B10 ... is to generate a vacuum. The generated vacuum and a suction gripper produce a force by means of which a workpiece can be gripped and transported. The supply of compressed air for vacuum generation is controlled by a solenoid valve. The vacuum is generated by actuating solenoid coil 12.

The setpoint value set at duct B for the generated vacuum is monitored via a vacuum sensor (with switching output). Vacuum generation reverts to a self-latching loop phase after reaching the set reference value. The vacuum block controls the vacuum generation process independently within the range of the set switching points (air-saving function).

The integrated solenoid valve is used to generate an ejector pulse by activating coil 14. The workpiece is thus safely released from the suction and the vacuum is rapidly broken down. The length of the ejector pulse can be influenced by the duration of the electrical pulse. The strength of the ejector pulse is influenced by the adjustable flow control valve.

 - Note
In the absence of electric or pneumatic supply when the valve is in the "create vacuum" or "air saving" state, the valve reverts to the "generate vacuum" position.

Operating mode of the air-saving function (LS)

If the desired threshold value (1) (turn off suction) is reached for the vacuum, vacuum generation is automatically switched off. Non-return valves

prevent the reduction of the vacuum. Nonetheless, leakage (e.g. due to rough workpiece surfaces) will slowly reduce the vacuum. If the pressure

drops below the set threshold value (2) (turn on suction), vacuum generation is switched on automatically.

Vacuum is generated until the set threshold value (1) (turn off suction) is reached again.

Threshold value to switch off suction (air-saving function) (1):

The vacuum generator is switched off simultaneously with the setting of

output Out A. The preset value is -700 mbar.

Threshold value to switch on suction (2):

The threshold value (2) should always be above the switching point of duct B (3) "vacuum sensing". The gap

between (2) and (3) should be at least 50 mbar.

 - Note
Setting options and further instructions are described in the operating instruction and/or documentation
VABF-S4-1-V2B1... in the Festo Support Portal.
→ Internet

Valve terminals VTSA/VTSA-F, NPT

Technical data – Vacuum block

General technical data		
Valve function		5/3-way, pressurised
Design		Non-modular
Mounting position		Any
Nominal width of laval nozzle (vacuum generation)	[mm]	2.0
Ejector characteristics		High vacuum, standard
Integrated functions		<ul style="list-style-type: none"> • Electric ejector pulse valve, • Flow control valve • On-off valve, electrical • Electric air-saving circuit • Non-return valve • Open silencer • Vacuum switch
Silencer design		Open
Measured variable		Relative pressure
Measuring principle		Piezoresistive
Switching function		Threshold value comparator
Protection against short circuit		Yes
Protection against polarity reversal		For all electrical connections
Inductive protective circuit		Adapted to MZ, MY, ME coils
Switching element function		N/O contact
Threshold value setting range	[bar]	-0.999 ... 0 (recommended operating range: -0.95 ... -0.05)
Hysteresis setting range	[bar]	-0.9 ... 0
Power supply, vacuum block		Via own plug M12
Pneumatic supply, vacuum block		Via valve terminal VTSA/VTSA-F
Ejector pulse		Intensity adjustable via flow control screw
Actuation type		<ul style="list-style-type: none"> • Solenoid valve • Vacuum block
		Electrically activated Vacuum generation via Venturi nozzle
Type of control - solenoid valve		Piloted
Direction of flow		Non-reversible
Exhaust function		With flow control (duct 3 and 5)
Type of mounting		Via through-hole, screwed onto manifold sub-base, width 26 mm
Manual override		Detenting, non-detenting, covered
		<ul style="list-style-type: none"> • for vacuum generation • for ejector pulse
		Yes, solenoid coil 12 (is retained) Yes, solenoid coil 14 (non-detenting), (only effective when power supply switched off)
Valve switching status display		LED
Pneumatic connections		
Supply port	1, 3	Via the manifold sub-base of the valve terminal, width 26 mm
Exhaust port	3/5	Via modular silencer for vacuum block
Working port (vacuum port)	2	Via the manifold sub-base of the valve terminal (QS push-in fitting – vacuum), G¼
Ports	4	Via the manifold sub-base of the valve terminal (sealed with blanking plug type B-¼)

Valve terminals VTSA/VTSA-F, NPT

Technical data – Vacuum block

Technical data, pressure switch - Vacuum block (delivery status)	
Duct A: air-saving function	
<ul style="list-style-type: none"> Switching behaviour Switching point [mbar] Hysteresis [mbar] Switching characteristic 	Threshold value comparator –700 200 NO (normally open contact)
Duct B, vacuum sensing	
<ul style="list-style-type: none"> Switching behaviour Switching point [mbar] Hysteresis [mbar] Switching characteristic 	Threshold value comparator –400 5 NO (normally open contact)



Note

Setting options for duct A and duct B and further instructions are described in the operating instruction and/or documentation

VABF-S4-1-V2B1... in the Festo Support Portal.
 → Internet

Electrical data	
Electrical connection	4-pin plug to ISO 15407-2 (separate power supply to the vacuum block, not via valve terminal)
Nominal operating voltage [V DC]	24
Operating voltage range [V DC]	21.6 ... 26.4
Duty cycle [%]	100
Max. output current [mA]	50
Voltage drop [V]	≤1.5
Idle current [mA]	50 ... 150 (dependent on the switching status of the solenoid coils)
Coil characteristics [V DC]	24
Power consumption (Coil characteristics) [W]	1.3
Overload protection	Yes
Accuracy (full scale) [% FS]	±3
Protection class to EN 60529	IP65, NEMA 4 (for all types of signal transmission in assembled state)

Electrical connection ¹⁾			
	Connector plug M12x1, 4-pin to EN 61076-2-101	Pin1 – + 24 V DC (brown (BN)) Pin2 – Out B (white (WH)) Pin3 – 0 V DC (blue (BU)) Pin4 – Out A (black (BK))	Supply voltage Switching output B (duct B) 0 DC V Switching output A (duct A)

1) Max. permissible signal line length: 5 m

Valve terminals VTSA/VTSA-F, NPT

Technical data – Vacuum block

Operating and environmental conditions	
Operating medium	Compressed air to ISO 8573-1:2010 [7:4:4]
Notes about the operating medium	Unlubricated operation
Operating pressure [bar]	4 ... 8
Nominal operating pressure [bar]	6
Pressure measuring range [bar]	-1 ... 0
Partial vacuum [bar]	Up to approx. 0.9 (as a function of operating pressure)
Ambient temperature [°C]	0 ... 50
Temperature of medium [°C]	0 ... 50

Materials	
Housing, jet nozzle	Wrought aluminium alloy
Screws	Galvanised steel
Seals	NBR
Plug housing	Nickel-plated die-cast zinc
Plug contacts	Gold-plated brass
Inspection window on pressure sensor	PA
Pressure sensor keyboard	TPE-U
Note on materials	RoHS-compliant

Pressure ratios, air consumption and flow rate

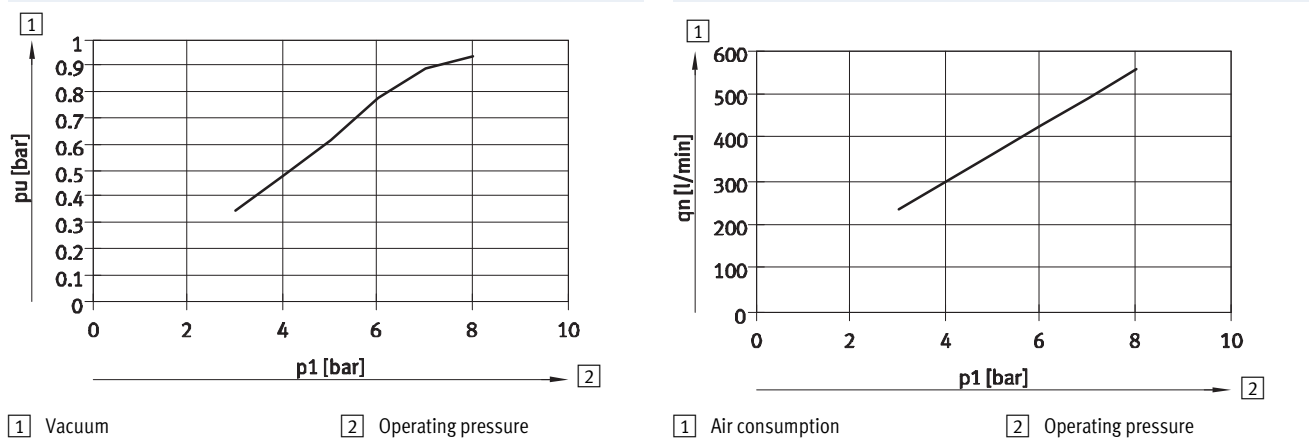

Valve terminals VTSA/VTSA-F, NPT

Technical data – Vacuum block

Dimensions

Download CAD data → www.festo.com

Vacuum block

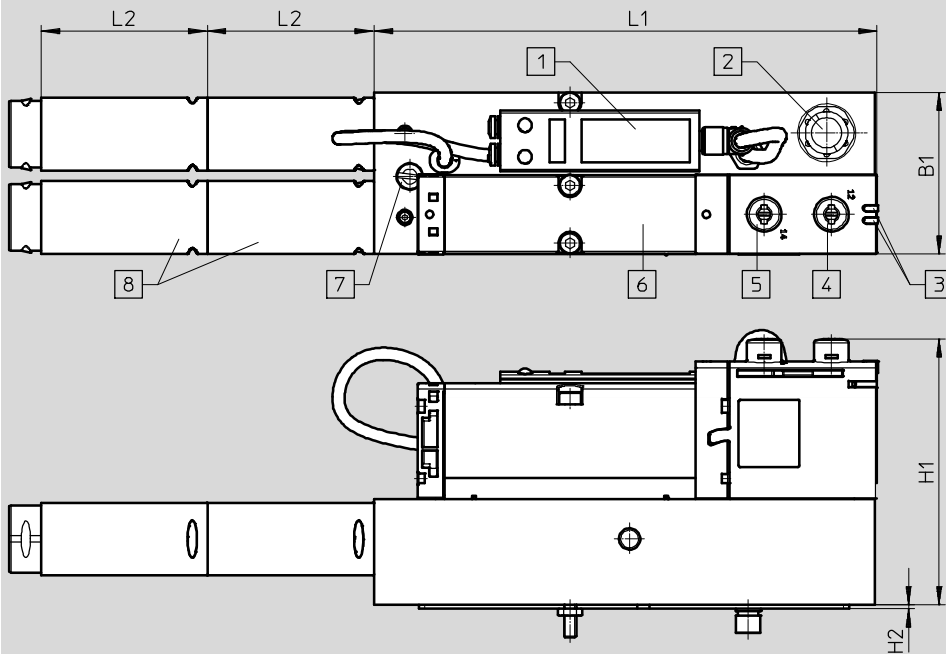



- | | | | |
|---|---|--|---|
| 1 Pressure sensor with LCD display and operating buttons | 3 LED switching status display for solenoid valve | 5 Manual override for ejector pulse (only effective when the power supply is switched off) | 6 Solenoid valve |
| 2 Connector for electrical connection and vacuum sensing (M12, 4-pin) | 4 Manual override for vacuum generation | | 7 Flow control screw for adjusting the intensity of the ejector pulse |
| | | | 8 Modular silencer |

Type	B1	H1	H2	L1	L2
VABF-S4-1-V2B1-C-VH-20	53	87.1	1.2	164.7	54.2

Valve terminals VTSA/VTSA-F, NPT

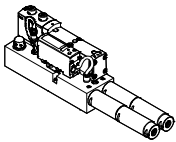
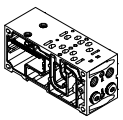
Technical data – Vacuum block

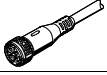
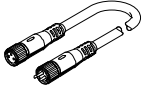
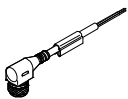
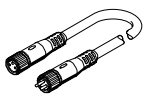



Ordering data				
	Code	Description	Part No.	Type
Vacuum block for valve terminal VTSA/VTSA-F				
	VB	Vacuum block for valve terminal VTSA/VTSA-F with air-saving function and adjustable ejector pulse	1120 g	571425 VABF-S4-1-V2B1-C-VH-20
Manifold sub-base				
	L ²⁾	For vacuum block 2 valve positions, 4 addresses, with 2 blanking plugs in port 4	26 mm	– ¹⁾ VABV-S4-...
	LK ²⁾	For vacuum block 2 valve positions, 4 addresses, with 2 blanking plugs in port 4 with small QS fitting	26 mm	– ¹⁾ VABV-S4-...
Connecting cable				
	–	<ul style="list-style-type: none"> • Straight socket, M12x1, 5-pin • Open end, 4-wire 	2.5 m	550326 NEBU-M12G5-K-2.5-LE4
	–	<ul style="list-style-type: none"> • Straight socket, M12x1, 5-pin • Open end, 4-wire 	5 m	541328 NEBU-M12G5-K-5-LE4
	–	<ul style="list-style-type: none"> • Straight socket, M12x1, 4-pin • Straight plug, M12x1, 4-pin 	2.5 m	18684 KM12-M12-GSGD-2.5
	–	<ul style="list-style-type: none"> • Straight socket, M12x1, 4-pin • Straight plug, M12x1, 4-pin 	5 m	18686 KM12-M12-GSGD-5
	GC	<ul style="list-style-type: none"> • Angled socket, M12x1, 5-pin • Open end, 4-wire 	5 m	541329 NEBU-M12W5-K-5-LE4
	–	Modular system for connecting cables	–	NEBU-... → Internet: nebu
Pneumatic connection accessories				
<p>A selection of possible fittings, blanking plugs, silencers and other pneumatic accessories can be found in the chapter Accessories → page 194 or on the Internet via the individual search terms:</p> <p>Internet → connection technology, silencer, blanking plug</p>				

1) The manifold sub-base for use with the vacuum block can only be ordered via the valve terminal configurator and therefore does not have a separate part number.

2) Code letter within the order code for a valve terminal configuration.

Valve terminals VTSA/VTSA-F, NPT

Adaptation to width 65 mm

-  - Valve width 65 mm
ISO size 3
-  - Flow rate
Up to 4000 l/min
-  - Operating pressure
-0.9 ... 10 bar
-  - Voltage
24 V DC
-  - Temperature range
-5 ... +50 °C



Description

Function

The adaptation of valves, regulator and flow control plates of width 65 mm, ISO size 3 in type 04

technology further expands the scope of application of the valve terminal VTSA/VTSA-F:

- 5 valve sizes with pneumatic function integration on a valve terminal VTSA/VTSA-F.
- Max. flow rate up to 4,000 l/min.
- Max. 26 solenoid coils of width 65 mm, ISO size 3 can be adapted to the valve terminal VTSA/VTSA-F. The total number of solenoid coils of all widths must not exceed 32.

Restrictions

End plate with pilot air selector

If components of ISO size 3 are used, the end plate with pilot air selector is not available for selection.

Pilot air supply via adapter plate

If no pneumatic components are installed on the left-hand side of the adapter plate (electrical components only), ducts 12 and 14 of the adapter plate must be sealed with blanking plugs.

Pressure zones

Max. 2 pressure zones are possible with ISO size 3.

Valve terminals VTSA/VTSA-F, NPT

Key features – Adaptation to width 65 mm

Equipment options

Valve functions for width 65 mm, ISO size 3

- 5/2-way valve
 - Single solenoid, pneumatic spring/mechanical spring
 - Double solenoid
 - Double solenoid with dominant signal
- 5/3-way valve
 - Mid-position pressurised
 - Mid-position closed
 - Mid-position exhausted

Special features

Fieldbus connection/CPX terminal	Multi-pin plug connection	AS-Interface	Combinable
<ul style="list-style-type: none"> • Max. 32 valve positions/ max. 32 solenoid coils • Any compressed air supply • Any number of pressure zones 	<ul style="list-style-type: none"> • Max. 32 valve positions/ max. 32 solenoid coils • Parallel modular valve linking • Any compressed air supply • Any number of pressure zones 	<ul style="list-style-type: none"> • 1 to 8 valve positions/max. 8 solenoid coils. Auxiliary power supply is required. 	<ul style="list-style-type: none"> • Width 65 mm: valve flow rate up to 4000 l/min • Width 18 mm, 26 mm, 42 mm and 52 mm can be combined on a single valve terminal. Width 65 mm is mounted at the end of the VTSA/VTSA-F configuration via adapter VABA

 Note
The total number of solenoid coils of all widths must not exceed 32.

Valve terminal configurator

➔ Internet: www.festo.com

A valve terminal configurator is available to help you select a suitable VTSA/VTSA-F valve terminal. This makes it much easier to order the right product.

The valve terminals are fully assembled according to your order specification and are individually checked. This reduces assembly and installation time to a minimum.

Order a valve terminal VTSA using the order code:

Ordering system for VTSA
➔ Internet: vtsa

Ordering system for CPX
➔ Internet: cpx

Order a valve terminal VTSA-F using the order code:

Ordering system for VTSA-F
➔ Internet: vtsa-f

Ordering system for CPX
➔ Internet: cpx

 Note
Please note that despite the basic configuration for ISO size 3 valves

- the manual override is always non-detenting
- exhaust air 3/5 of the adapter plate for ISO size 3 is always routed separately
- there is no option for 90° connection plate, outlet at bottom
- there is no option for sintered silencers
- there is no option for pneumatic accessories

Valve terminals VTSA/VTSA-F, NPT

Peripherals – Pneumatic components, width 65 mm

FESTO

Overview of modules for width 65 mm, ISO size 3

ISO 5599-2 size 3

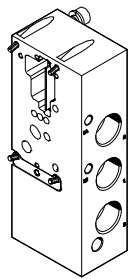

Adapter plate

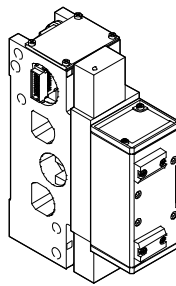

Valve with manifold sub-base

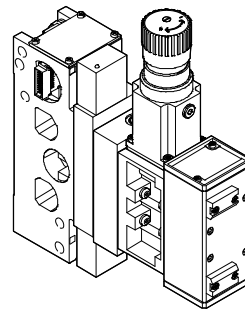

Vertical stacking

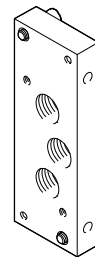

End plate

Pneumatics

Pneumatic modules

- Manifold sub-base for ISO valves
- Size 3: (1/2" NPT) 4000 l/min

Adapter plate

- Pressure supply connection duct 1
- Exhaust connection duct 3/5 (separated)
- External pilot air supply connection (optional) for pneumatic components on the left-hand side

Pneumatic modules

- Manifold sub-base for one ISO valve
- Pilot control via intermediate solenoid plate
- ISO size 3

Vertical stacking

- Valves
- Flow control plates
- Intermediate pressure regulator plates
- Pressure gauge
- Creation of pressure zones with 10 bar or vacuum (with external pilot air supply only)

Information on valve activation for ISO size 3

- All intermediate solenoid plates feature a non-detenting manual override
- Valve terminals with internal pilot air supply: restricted pressure range
- Valve terminals with external pilot air supply: pressure zones up to 10 bar or vacuum operation possible. In this case, the pilot air supply must be regulated and supplied externally.

Additional modules

- Flow control plates: one-way flow control valves can be mounted between the manifold sub-base and the valve so that the speed of travel can be set separately for single and double-acting cylinders
- Pressure regulators: intermediate pressure regulator plates for setting the contact pressure of a cylinder, either separately on duct 1, 2 or 4, or shared by 2 and 4
- Pressure gauge on pressure regulator

Flexible compressed air supply

- Compressed air supply via the adapter plate or the right-hand end plate
- With large valve terminals, compressed air can be supplied at both sides

- Creation of pressure zones: maximum of 2 pressure zones, up to 10 bar as well as for vacuum, are possible for all valve sizes. Compressed air supply at both sides is essential in this case
- Regulated external pilot air supply should be used for pressures < 3 bar

Options

- Vacant positions for subsequent extensions
- All pneumatic connections can also be supplied with a G thread

Valve terminals VTSA/VTSA-F, NPT

Peripherals – Pneumatic components, width 65 mm

FESTO

Pneumatic components of width 65 mm, ISO size 3

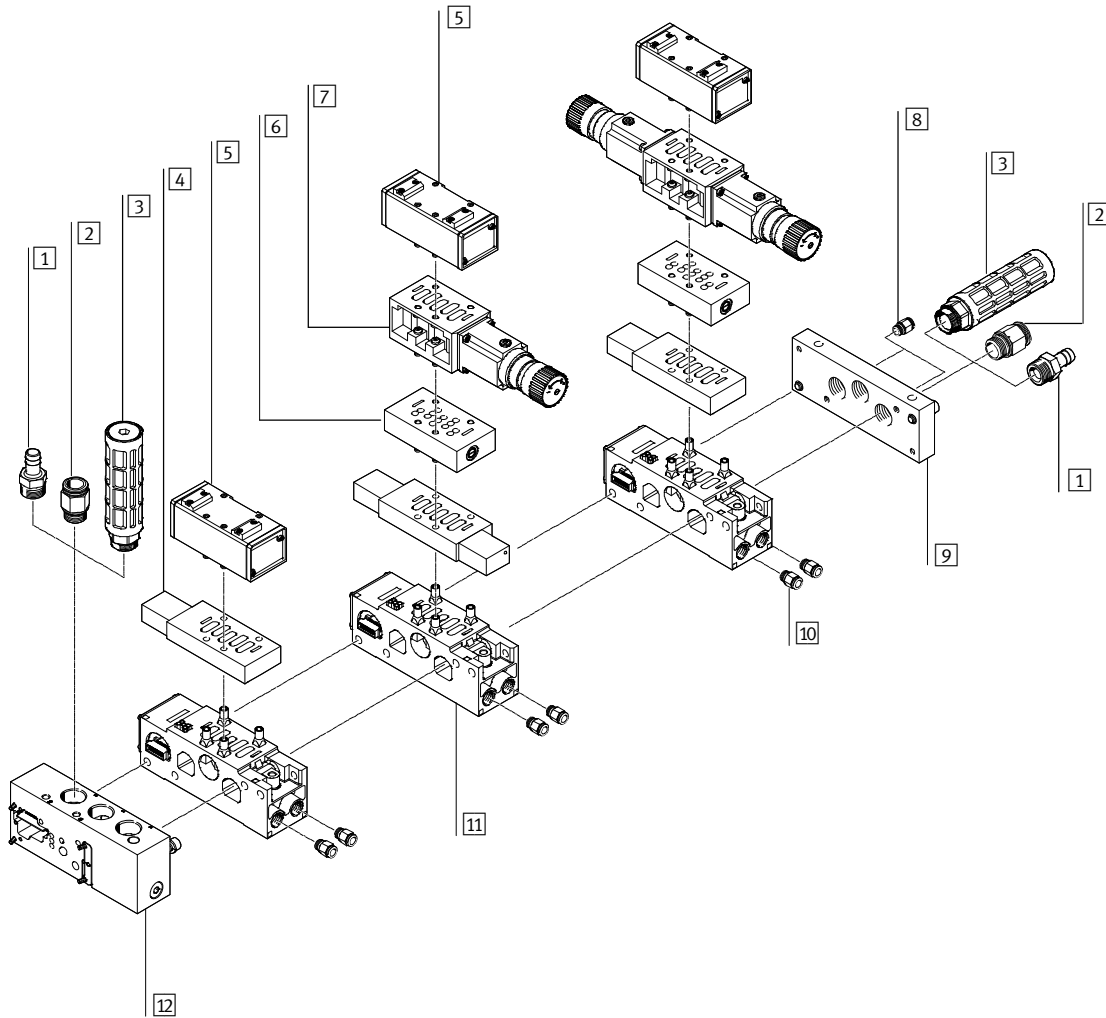

	Brief description	→ Page/Internet
1	Female hose connector 1"	–
2	Fitting	For compressed air supply
3	Silencer	For exhaust air
4	Intermediate solenoid plate	For pneumatically actuated standard valves
5	Valve	Pneumatically actuated standard valve
6	Flow control plate	For exhaust air flow control
7	Intermediate pressure regulator plate	–
8	Fitting	For pilot air
9	End plate	Right-hand end plate
10	Fitting	For supply air (QS 16, QS 12)
11	Manifold sub-base	For linking the valve terminal
12	Adapter plate VABA ...	For adaptation of ISO size 3 components to valve terminal VTSA/VTSA-F

Valve terminals VTSA/VTSA-F, NPT

Key features – Pneumatic components, width 65 mm

Key features – Pneumatic components

Adapter plate VABA ...

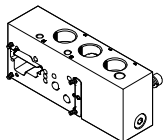

The adapter plate VABA ... is used for adapting of valves of width 65 mm ISO size 3 to valve terminal VTSA/VTSA-F. Connections for supply/exhaust air

and pilot air supply are available. The external pilot air used here supplies the valve terminal with valves of width 18 ... 52 mm on the left-hand

side of the adapter. The external pilot air supply for the valves with a width of 65 mm, ISO size 3 is provided via the end plate IEPR

Blanking plates

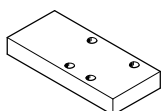

Blanking plates are used to seal off vacant valve positions. No intermediate solenoid plate is

mounted underneath the blanking plate. This depends on the valve used and must be ordered with the valve if

the terminal is extended at a later date.

Valves and pilot control

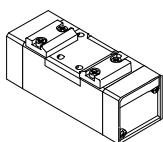

The valves used are pneumatically actuated standard valves that are controlled by means of an intermediate solenoid plate.

Valves and flow lines

The selection of pilot air supply is made at the intermediate solenoid plate by configuring two plugs. Air can

be taken from the supply air, or from a separate air supply. A separate pilot air supply is required in principle if

supply pressure is less than 3 bar (including vacuum). In this case it is advisable to restrict

the pilot air supply to max. 10 bar with a suitable regulator.

Valve terminals VTSA/VTSA-F, NPT

Key features – Pneumatic components, width 65 mm

The following circuit symbols are shown as solenoid valves and are the combination (set) consisting of pneumatic valve with corresponding intermediate solenoid plate. The symbols printed on the components can therefore vary.

Valve function			
Terminal code	Circuit symbol	Width 65 mm	Description
0		■	5/2-way valve, single solenoid <ul style="list-style-type: none"> • With intermediate solenoid plate • Mechanical spring
-		■	5/2-way valve, single solenoid <ul style="list-style-type: none"> • With intermediate solenoid plate • Pneumatic spring
M		■	5/2-way valve, single solenoid <ul style="list-style-type: none"> • With intermediate solenoid plate • Pneumatic spring, air spring supplied by external pilot air
J		■	5/2-way valve, double solenoid <ul style="list-style-type: none"> • With intermediate solenoid plate
D		■	5/2-way valve, double solenoid <ul style="list-style-type: none"> • With intermediate solenoid plate • Dominant signal
G		■	5/3-way valve <ul style="list-style-type: none"> • With intermediate solenoid plate • Mid-position closed
E		■	5/3-way valve <ul style="list-style-type: none"> • With intermediate solenoid plate • Mid-position exhausted
B		■	5/3-way valve <ul style="list-style-type: none"> • With intermediate solenoid plate • Mid-position pressurised
L		■	Blanking plate

-  - Note
 A filter must be installed upstream of valves operated in vacuum mode. This prevents any foreign matter in the intake air getting into the valve (e.g. when operating a suction cup).

Valve terminals VTSA/VTSA-F, NPT

Key features – Pneumatic components, width 65 mm

Vertical stacking, width 65 mm

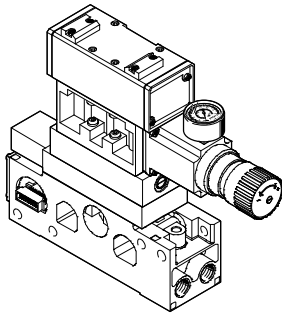

Additional components can be added to each ISO size 3 valve position between the sub-base (manifold sub-base) and the valve. These functions

are known as vertical stacking modules and enable special functioning or control of an individual valve position.

Vertical stacking components

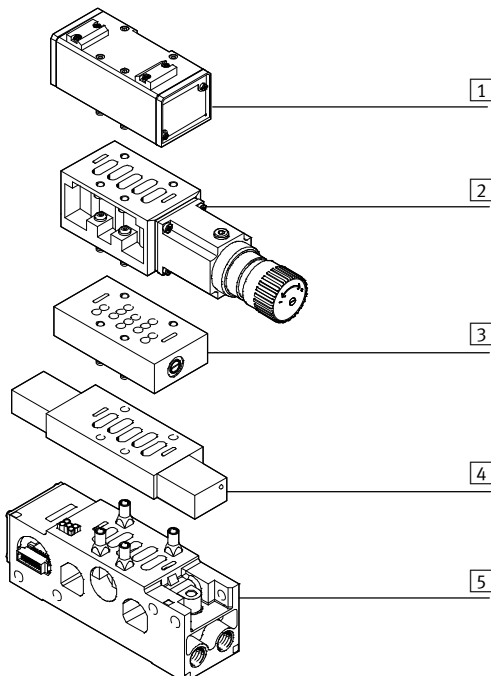

- 1 Valve ISO size 3
- 2 Intermediate pressure regulator plate
- 3 Flow control plate
- 4 Intermediate solenoid plate
- 5 Manifold sub-base with port pattern to DIN ISO 5599-2



Note

Certain combinations are not possible due to the design of the individual vertical stacking components.

Valve terminals VTSA/VTSA-F, NPT

Key features – Pneumatic components, width 65 mm



Flow control plate, width 65 mm

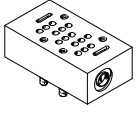

Intermediate plate with integrated exhaust air restrictors at ports 3 and 5 for regulating cylinder speed.

Intermediate pressure regulator plate and pressure gauge, for width 65 mm

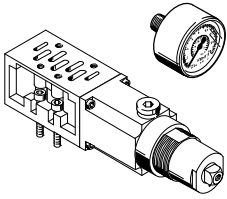

Intermediate plate with integrated pressure regulator for regulating pressure at

- Ports 2 and 4 (B, A)
- Port 4 (A)
- Port 2 (B)
- Port 1 (P)

Easy pressure adjustment

Pressure gauges can be screwed directly into the intermediate pressure regulator plate to adjust the pressure.

Functions			
Code	Circuit symbol	Width 65 mm	Description
X		■	Flow control plate (with two one-way flow control valves for exhaust air flow control)
ZA		■	Intermediate pressure regulator plate, port 1
ZB		■	Intermediate pressure regulator plate, port 4
ZC		■	Intermediate pressure regulator plate, port 2
ZD		■	Intermediate pressure regulator plate, ports 2 and 4
S T R		■	Isolating disc for creating pressure zones Duct separation 1, 3, 5 Duct separation 1 Duct separation 3, 5
T		-	Pressure gauge for regulator, max. 10 bar
-		-	Pressure gauge for regulator, max. 16 bar

Valve terminals VTSA/VTSA-F, NPT

Key features – Pneumatic components, width 65 mm

Manifold sub-base for valves, width 65 mm

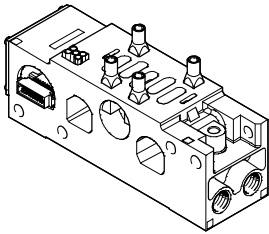

Adaptation to size 65 mm ISO size 3 is based on a modular system which consists of manifold sub-bases and valves. The manifold sub-bases contain a duct seal and an electrical inter-linking module, are screwed together and thus form the support system for the valves. Inside the manifold

sub-bases are the connection ducts for supplying compressed air to and exhausting from the valves on the terminal as well as the working ports for the pneumatic cylinders for each valve.

Each manifold sub-base is connected to the next using two screws.

Individual valve terminal sections can be isolated and further manifold sub-bases inserted by loosening these screws. This ensures that the valve terminal can be rapidly and reliably extended, even for width 65 mm, ISO size 3.

Port pattern to ISO 5599-2 of the manifold sub-base for valves with width 65 mm

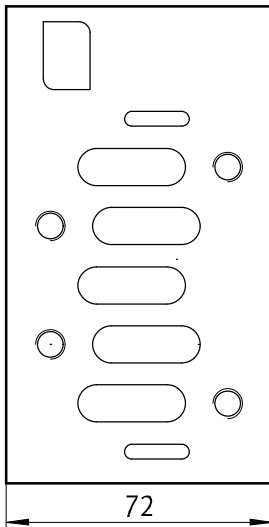

Valve terminals VTSA/VTSA-F, NPT

Key features – Pneumatic components, width 65 mm

Compressed air supply and exhausting

Right-hand end plate

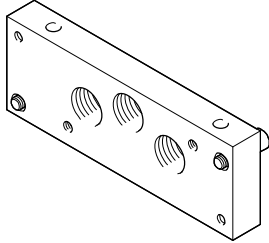

With the adaptation to width 65 mm ISO size 3, compressed air is supplied via the right-hand end plate and/or the adapter plate VABA

Exhausting is via silencers or ports for ducted exhaust air on the adapter plate VABA ... and/or on the right-hand end plate.

The external pilot air supply for the valves with a width of 65 mm, ISO size 3 is provided via the end plate IEPR

Pilot air supply

When using valves with a width of 65 mm, the internal/external pilot air supply for the valves with a width of 18 ... 52 mm is provided via the adapter plate VABA-....
The external pilot air supply for the valves with a width of 65 mm is provided via the right-hand end plate IEPR

Internal pilot air supply

Internal pilot air supply can be selected if the working pressure is between 3 ... 10 bar.
The pilot air supply is then branched from the compressed air supply 1 using an internal connection. Ports 12 and 14 on the right-hand end plate are sealed with a blanking plug.

External pilot air supply

If the working pressure is not within the range from 3 ... 10 bar, you must operate the valves with a width of 65 mm, ISO size 3 using external pilot air supply. The pilot air supply is then supplied via ports 12 and 14 on the right-hand end plate.



Note

If a gradual pressure build-up is required in the system by means of an external soft-start valve, then external pilot air should be selected whereby the pilot pressure is already applied at the point of switch-on.

Creating pressure zones

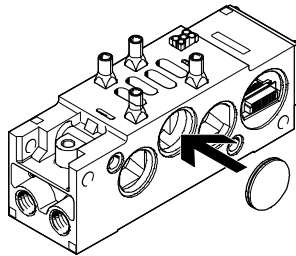

Different supply pressures are possible in the area containing the valves with a width of 65 mm by installing isolating discs between two manifold blocks. When doing this it should be

noted that the isolating disc is inserted into the manifold sub-base from the right. The supply and exhaust is effected on the left-hand side via the adapter plate VABA ... and via the right

end plate. Usually, only duct 1 has to be isolated. In special cases, isolating discs may also be inserted into exhaust ducts 3 and 5.

Manual override (MO)

MO with automatic reset (non-detenting)

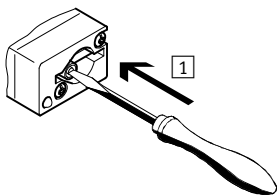

- 1 Press in the stem of the manual override using a pointed object or screwdriver. The valve is in switching position.

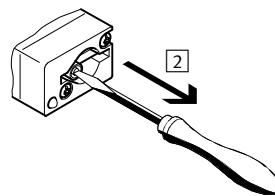

- 2 Remove the pointed object or screwdriver. The spring force pushes the stem of the manual override back. The valve returns to its initial position (not with double solenoid valve code J, D).

Valve terminals VTSA/VTSA-F, NPT

Key features – Electrical components, width 65 mm

Electrical connection concept

Replacing the solenoid coil fuse

Each solenoid coil is protected with a (fast-blowing) 0.315 A fuse. These fuses are located behind the cover of

each manifold sub-base on the printed circuit board. Each single solenoid manifold sub-base has one fuse, while

each double solenoid manifold sub-base has two fuses.



Note

Make sure that there is sufficient clearance for maintenance purposes.

Changing the solenoid coil fuse

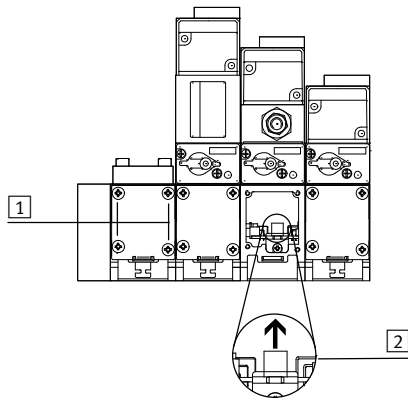

- 1 Loosen the fastening screws in the cover
- 2 Carefully remove the fuse from its base.
Right fuse for valve solenoid 14
Left fuse for valve solenoid 12

Valve terminals VTSA/VTSA-F, NPT

Key features – Assembly, width 65 mm

Rear side mounting

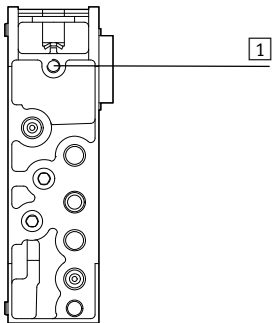

1 Blind hole for rear side mounting

The rear side of the manifold sub-bases has holes (blind holes) for mounting the valve terminal on machines or metal racks (rear side mounting).

M8 threads need to be cut for this purpose.

Wall mounting in the area of the adaptation to width 65 mm, ISO size 3

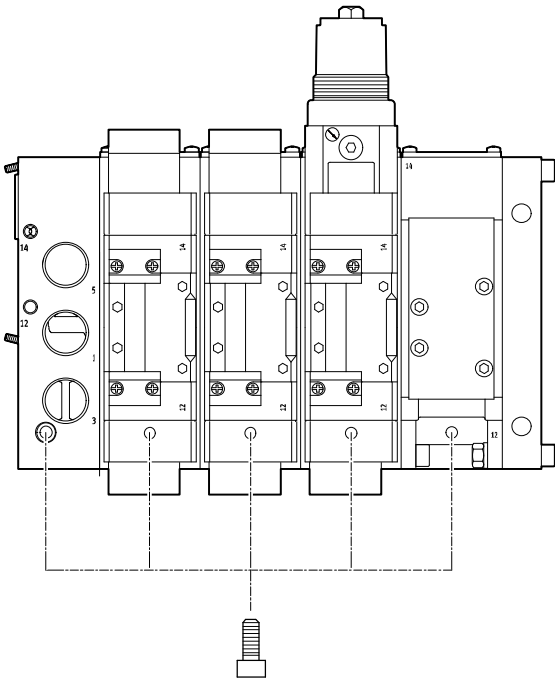

- With screws M8 on the adapter plate and the manifold sub-bases
- Holes (blind holes) on the underside of the manifold sub-bases

- Hole (through-hole) in the adapter plate

-  - Note

The mounting holes of every second manifold sub-base must be used for

the wall mounting of a valve terminal VTSA-ASI in size ISO 3.

Valve terminals VTSA/VTSA-F, NPT

Technical data – General technical data, width 65 mm

General technical data for valve functions		
Design		Piston spool valve
• Valves		
• Intermediate pressure regulator plate		Pressure regulator with secondary exhausting
Width	[mm]	65
Nominal size	[mm]	14.5
Type of mounting		
• Valves		With through-holes on the manifold sub-base
• Flow control plate		With through-holes on the manifold sub-base
• Intermediate pressure regulator plate		With through-holes on the manifold sub-base
Mounting position		Any
Manual override		Non-detenting
Pneumatic connections – NPT connection		
Supply air	1	1" NPT
Exhaust air	3/5	1" NPT
Working ports	2/4	1/2" NPT
Pilot air supply	12/14	1/8" NPT

Technical data										
Valve function	Terminal code	Valve switching times in [ms]			Flow direction		Type of reset		Standard nominal flow rate in [l/min]	
		On	Off	Change-over	Reversible	Non-reversible	Pneumatic spring	Mechanical spring		
5/2-way, double solenoid	J	–	–	8	■	–	–	–	4500	
5/2-way, double solenoid with dominant signal	D	29	36	–	■	–	–	–	4500	
5-2-way single solenoid, air spring supplied by external pilot air	M	29	36	–	■	–	■	–	4500	
5/2-way, single solenoid	–	29	36	–	–	■	■	–	4500	
5/2-way, single solenoid	O	17	61	–	■	–	–	■	4500	
5/3-way, closed ¹⁾	G	17	61	–	■	–	–	■	3600	
5/3-way, exhausted ¹⁾	E	18	63	–	■	–	–	■	3800	
5/3-way, pressurised ¹⁾	B	16	60	–	■	–	–	■	3800	
Intermediate plate										
For single solenoid valves (MUH-ZP-D-3-24G)	–	–	–	–	–	–	■	–	■	–
For double solenoid, 5/3-way and dominant valves (MUHX2-ZP-D-3-24G)	–	–	–	–	–	–	■	–	■	–
For single solenoid valves, air spring supplied by external pilot air (MUH-ZP-D-3-L-24G)	–	–	–	–	–	–	■	–	■	–
Intermediate pressure regulator plate										
LR-ZP-A-D-	ZB	–	–	–	–	–	–	–	–	2300
LR-ZP-B-D-	ZC	–	–	–	–	–	–	–	–	2300
LR-ZP-B-D-	ZA	–	–	–	–	–	–	–	–	1800
LR-ZP-A/B-D-	ZD	–	–	–	–	–	–	–	–	–

1) If neither solenoid coil is energised, the valve assumes its mid-position by means of spring force.
If both solenoid coils are energised at the same time, the valve remains in the previously assumed switching position.

Valve terminals VTSA/VTSA-F, NPT

Technical data – General technical data, width 65 mm

Operating and environmental conditions	
Valve functions, adapter plate	
Operating medium	Compressed air to ISO 8573-1:2010 [7:4:4]
Notes about the operating/ pilot medium	Lubricated operation possible (in which case lubricated operation will always be required)
Operating pressure for valve terminal • With ext. pilot air supply • With int. pilot air supply	-0.9 ... +10 3 ... 10
Pilot pressure for valve terminal	3 ... 10
Operating pressure, valves • With ext. pilot air supply • With int. pilot air supply	-0.9 ... +10 (for reversible valves, for non-reversible valves 2 ... 10) 3 ... 10 (for mech. return valves, for pneum. return valves 2 ... 10)
Pilot pressure for valves	3 ... 10 (for mech. return valves, for pneum. return valves 2 ... 10)
Pressure regulation range	0 ... 12 (for intermediate pressure regulator plate)
Ambient temperature	-5 ... +50
Temperature of medium	-5 ... +50
Mounting position	Any
Certification	c UL us - Recognized (OL)
CE marking (see declaration of conformity)	In accordance with EU EMC Directive ¹⁾ (for intermediate plate MUH ...)
Relative air humidity	90

1) For information about the applicability of the component see the manufacturer's EC declaration of conformity at: www.festo.com/sp → User documentation.
If the component is subject to restrictions on usage in residential, office or commercial environments or small businesses, further measures to reduce the emitted interference may be necessary.

Electrical data – Solenoid coil	
Protection against electric shock (protection against direct and indirect contact to EN 60204-1/IEC 204)	By means of PELV power supply unit
Operating voltage [V]	24 DC ±10%
Electrical power [W] consumption per coil	3.1 (130 mA at 24 V DC)
Duty cycle	100% (50% concurrence)
Protection class to EN 60529	IP65 (in assembled state)
Relative air humidity [%]	90% at 40 °C, non-condensing

Electrical data – Adapter plate	
Width	60 mm
Operating voltage [V]	24 DC ±10%
Max. acceptable current [mA] load per signal	500
Duty cycle	100%
Protection class to EN 60529	IP65 and NEMA 4 (for all types of signal transmission in assembled state)

Valve terminals VTSA/VTSA-F, NPT

Technical data – General technical data, width 65 mm

Materials	
Valves	Die-cast aluminium, steel
Adapter plate	Wrought aluminium alloy
Seals	Nitrile rubber
Flow control plate	Anodised aluminium, brass
Intermediate pressure regulator plate	Die-cast aluminium, steel
Screws	Galvanised steel
Note on materials	RoHS-compliant

Product weight	
Approx. weight	[g]
Adapter plate	2600
Manifold sub-base	1120
Right-hand end plate	1120
Intermediate solenoid plate	500
Valves	
• Single solenoid, double solenoid	760
• Mid-position	840
Blanking plate	180
Flow control plate	850
Intermediate pressure regulator plate	
• P, B, A	1120
• A/B	1770

Valve terminals VTSA/VTSA-F, NPT

Technical data – Adaptation to width 65 mm

Dimensions

Download CAD data → www.festo.com

Adapter plate with components, width 65 mm

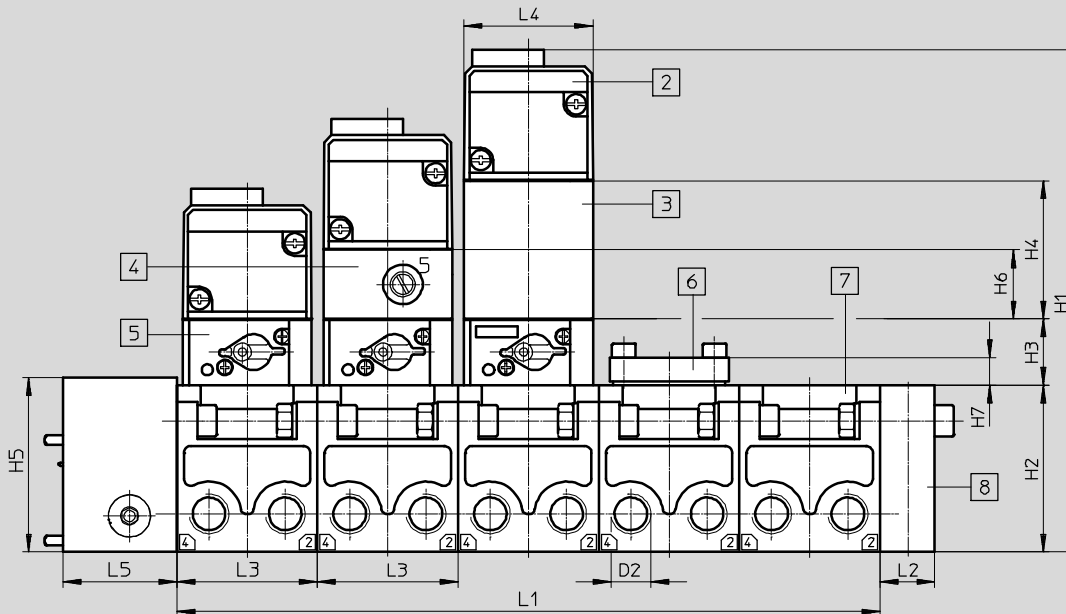
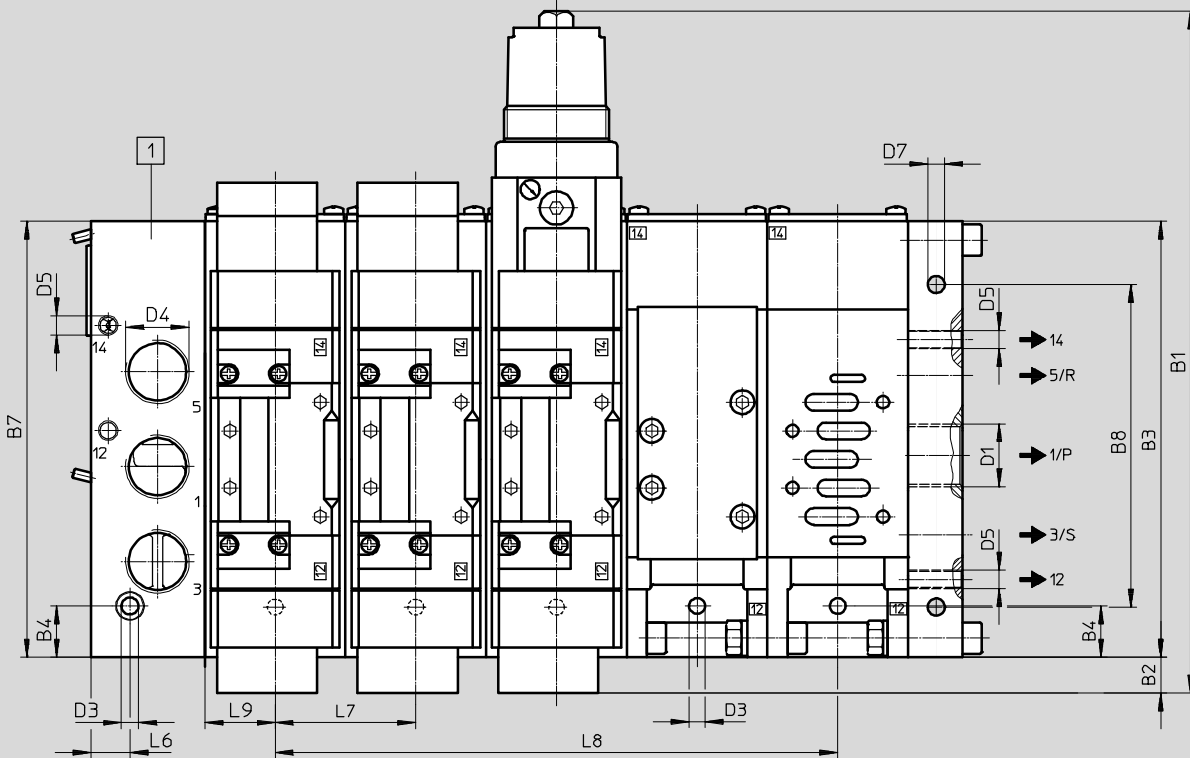

- 1 Adapter plate
- 2 ISO valve
- 3 Intermediate pressure regulator plate
- 4 Flow control plate
- 5 Intermediate solenoid plate
- 6 Blanking plate
- 7 Manifold sub-base
- 8 End plate

Type		~B1	B2	B3	B4	B7	B8	D1	D2	D3	D4	D5	D7
VABA-S6-7-S2-3-P...	[mm]	315	6	230	27	230	170	1 NPT	1/2NPT	9	1 NPT	1/8NPT	9

Type		H1	H2	H3	H4	H5	H6	H7	L1 ¹⁾	L2	L3	L4	L5	L6	L7	L8 ¹⁾	L9
VABA-S6-7-S2-3-P...	[mm]	235	82	28	63	92	29	21.5	nx72	28	72	70	40	20.5	72	(n-1)x72	36

1) n = number of valves

Valve terminals VTSA/VTSA-F, NPT

Technical data – Dimensions, width 65 mm

Dimensions

Download CAD data → www.festo.com

Manifold sub-bases for valves with width 65 mm

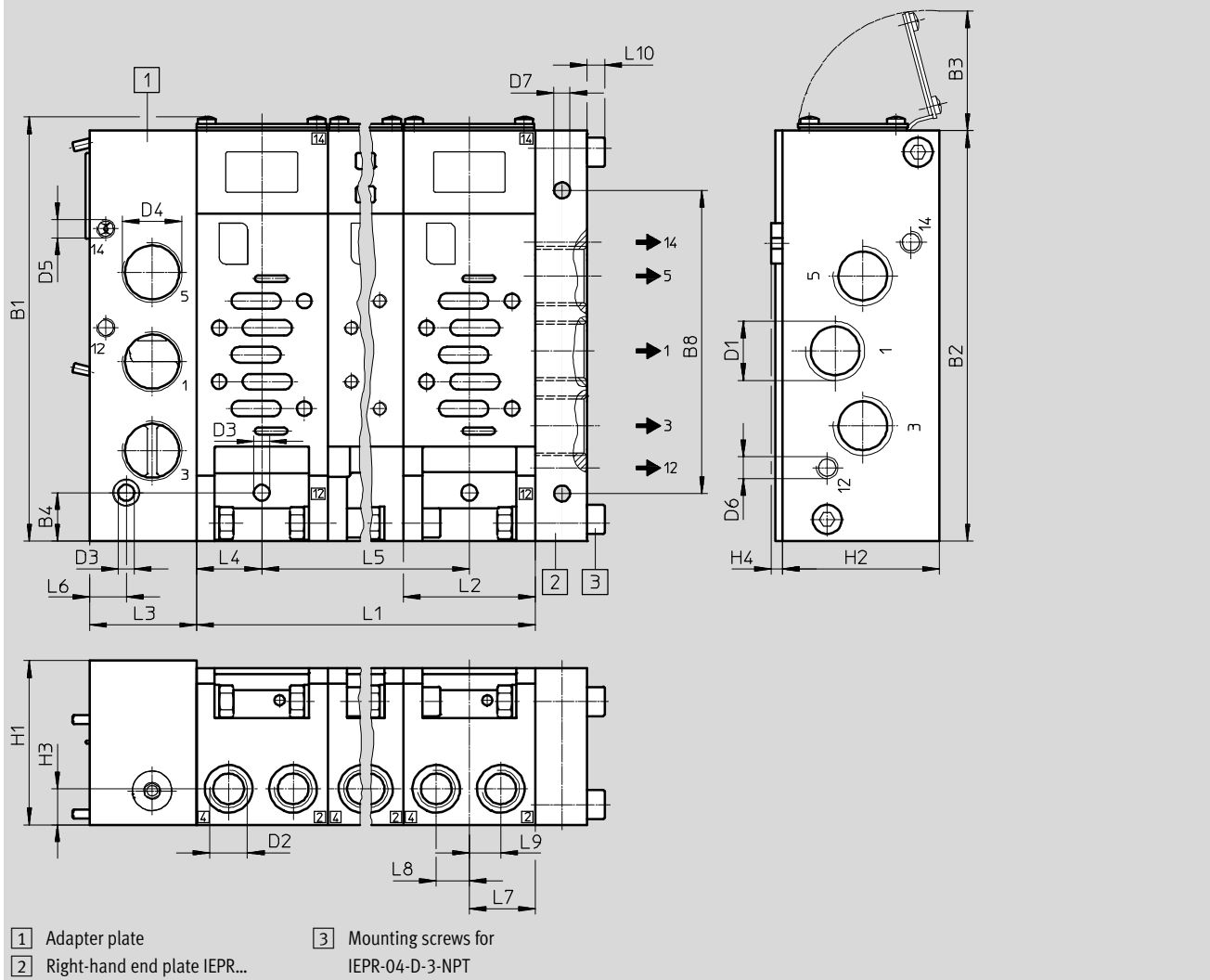

Type		~B1	B2	B3	B4	B8	D1	D2	D3	D4	D5	D6	D7
VIGI/VIGK-04-D-3-NPT	[mm]	237 max.	230	64 max.	27	170	G1	1/2NPT	9.0	1 NPT	1/8NPT	G1/8	9

Type		H1	H2	H3	H4	L1 ¹⁾	L2	L3	L4	L5 ¹⁾	L6	L7	L8	L9	L10
VIGI/VIGK-04-D-3-NPT	[mm]	92	82	20	5	nx72	72	60	36	(n-1)x72	20.5	36	18	18	10

1) n = number of valves

Valve terminals VTSA/VTSA-F, NPT

Technical data – Dimensions, width 65 mm

FESTO

Dimensions

Download CAD data → www.festo.com

Intermediate pressure regulator plate

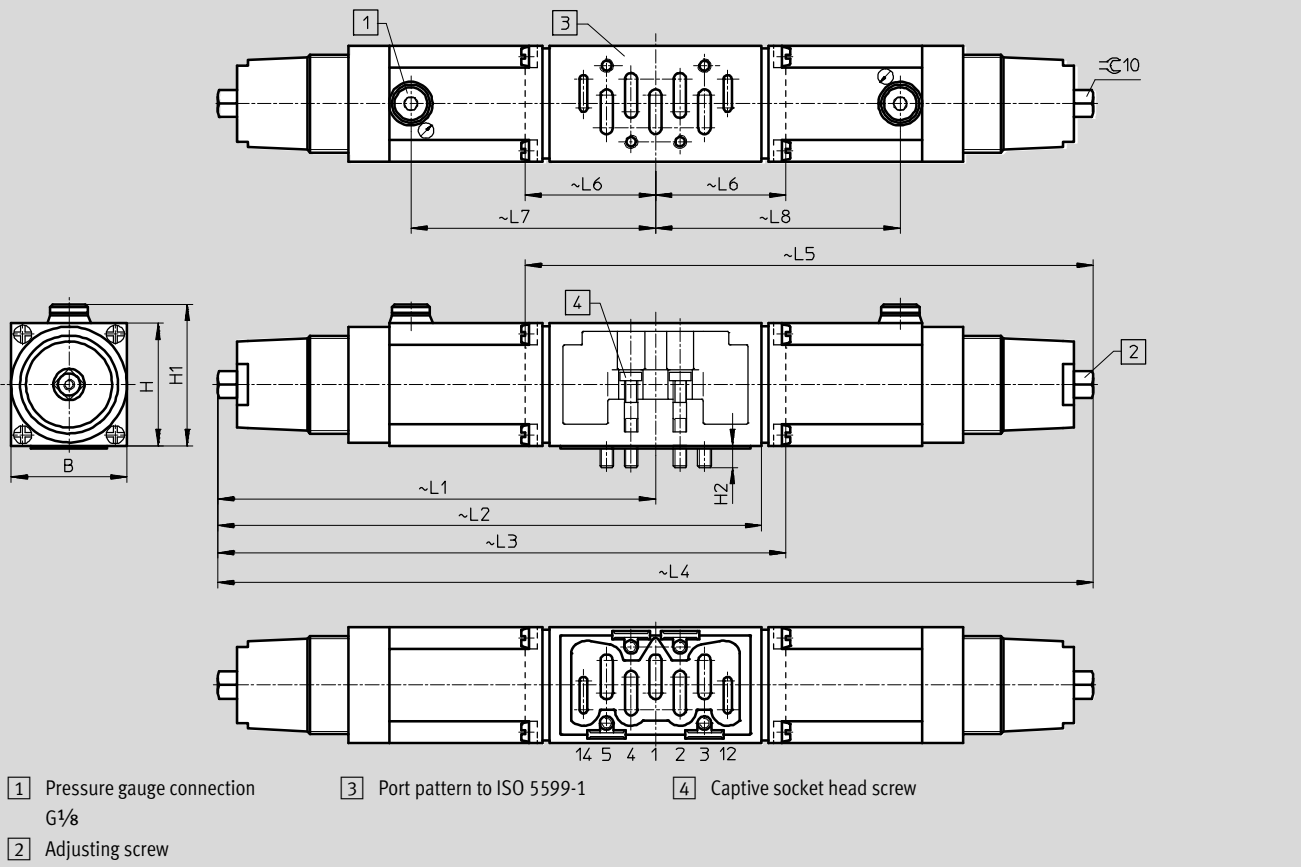

Type		B	H	H1	H2	L1	L2	L3	L4	L5	L6	L7	L8
LR-ZP-A-D-3	[mm]	70	63	65	14	201.5	–	274	–	–	–	119	–
LR-ZP-B-D-3	[mm]	70	63	65	14	201.5	–	–	–	274	72.5	–	119
LR-ZP-A/B-D-3	[mm]	70	63	65	14	201.5	–	–	403	–	–	119	119
LR-ZP-P-D-3	[mm]	70	63	65	14	201.5	260	–	–	–	–	119	–

Flow control plate

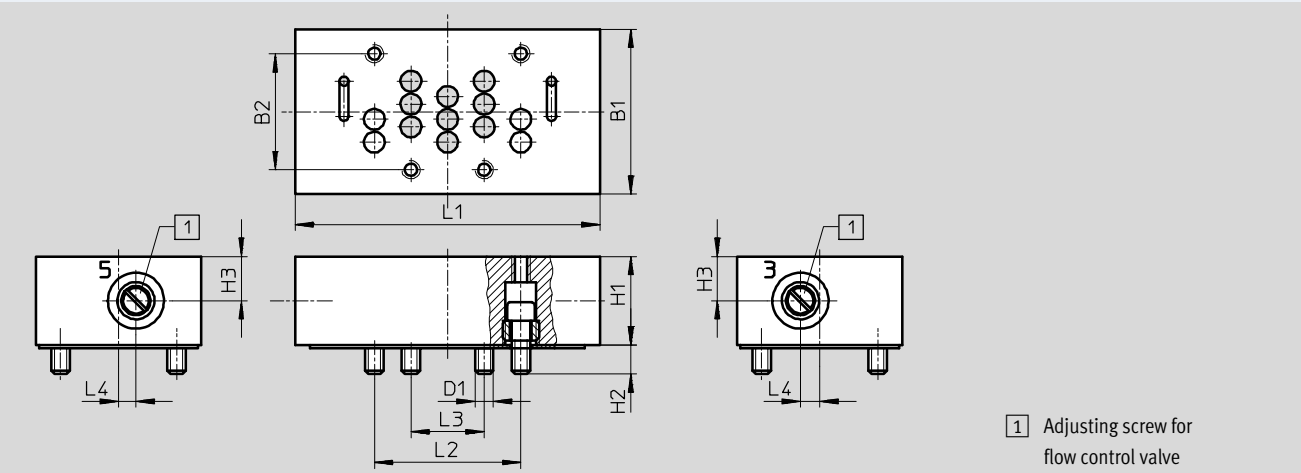

Type		B1	B2	D1	H1	H2	H3	L1	L2	L3	L4
GRO-ZP-3-ISO-B	[mm]	70	48	M8	33	12	16.5	132	64	32	7

Valve terminals VTSA/VTSA-F, NPT

Ordering data – Individual valve 24 V DC, width 65 mm

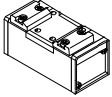
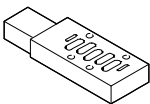
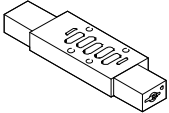

FESTO

Ordering data				
Name	Code	Description	Part No.	Type
Pneumatic valve (can be ordered individually)				
	–	5/2-way valve, single solenoid, mechanical spring return	151863	VL-5/2-D-3-FR-C
	–	5/2-way valve, single solenoid, pneumatic spring return	151864	VL-5/2-D-3-C
	–	5/2-way valve, double solenoid	151865	J-5/2-D-3-C
	–	5/2-way valve, double solenoid, dominant signal	151866	JD-5/2-D-3-C
	–	5/3-way valve, mid-position closed	151867	VL-5/3G-D-3-C
	–	5/3-way valve, mid-position exhausted	151868	VL-5/3E-D-3-C
	–	5/3-way valve, mid-position pressurised	151869	VL-5/3B-D-3-C
Intermediate solenoid plate for pneumatic valve (can be ordered individually)				
	–	For actuation of a single solenoid, pneumatically actuated directional control valve	34934	MUH-ZP-D-3-24G
	–	For actuation of a single solenoid, pneumatically actuated directional control valve, air spring supplied by external pilot air	151715	MUH-ZP-D-3-L-24G
	–	For actuation of double solenoid, pneumatically actuated directional control valves or 5/3-way valves	34935	MUHX2-ZP-D-3-24G

Valve terminals VTSA/VTSA-F, NPT

FESTO

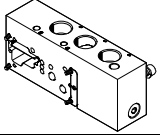
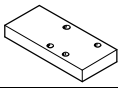
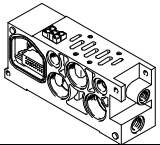
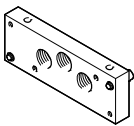
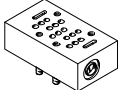
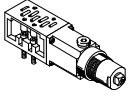
Accessories – Adaptation to width 65 mm

Ordering data – Accessories				
Name	Code	Description	Part No.	Type
Adapter plate				
	–	Adapter plate for adaptation of ISO size 3 components to valve terminal VTSA/VTSA-F (external pilot air)	1302085	VABA-S6-7-S2-3-P-N1
	–	Adapter plate for adaptation of ISO size 3 components to valve terminal VTSA/VTSA-F (internal pilot air)	1302091	VABA-S6-7-S2-3-P-B-N1
Blanking plate				
	L	Blanking plate for vacant position	36121	IAP-04-D-3
Manifold sub-base, port pattern to ISO 5599-2				
	M ¹⁾	1 valve position, 2 addresses, for double solenoid valves (with QS 16)	18842	VIGI-04-D-3-NPT
	MK ¹⁾	1 valve position, 2 addresses, for double solenoid valves (with QS 12)		
	N ¹⁾	1 valve position, 1 address, for single solenoid, valves (with QS 16)	18836	VIGM-04-D-3-NPT
	NK ¹⁾	1 valve position, 1 address, for single solenoid, valves (with QS 12)		
Right-hand end plate				
	–	With supply air/exhaust air, internal/external pilot air supply (internal/external pilot air is regulated via MUH plate (solenoid valve))	18881	IEPR-04-D-3-NPT
Flow control plate				
	X	Flow control plate (with two one-way flow control valves for exhaust air flow control)	119674	GRO-ZP-3-ISO-B
Intermediate pressure regulator plate				
	ZA	Port 1, 0.0 ... 12 bar	35968	LR-ZP-P-D-3
	ZB	Port 4, 0.5 ... 12 bar	35971	LR-ZP-A-D-3
	ZC	Port 2, 0.5 ... 12 bar	35426	LR-ZP-B-D-3
	ZD	Port 2 and 4, 0.5 ... 12 bar	35429	LR-ZP-A/B-D-3
Isolating disc				
	T	Duct separation 1	18910	NSC-04-D-3
	R	Duct separation 3, 5		
	S	Duct separation 1, 3, 5		
Pressure gauge				
	T	For regulator, max. 10 bar	162835	MA-40-10-1/8-EN
	–	For regulator, max. 16 bar	529046	MA-40-16-1/8-EN-DPA

1) Code letter within the order code for a valve terminal configuration.

Valve terminals VTSA/VTSA-F, NPT

Technical data – Valves on individual sub-base

FESTO

-  - Valve width to ISO 15407-2
- 18 mm
 - 26 mm
- to ISO 5599-2
- 42 mm (ISO 1)
 - 52 mm (ISO 2)

-  - Voltage
- 24 V DC
 - 110 V AC

-  - Flow rate
- Width 18 mm: up to 600 l/min
 - Width 26 mm: up to 1200 l/min
 - Width 42 mm: up to 1500 l/min
 - Width 52 mm: up to 3400 l/min

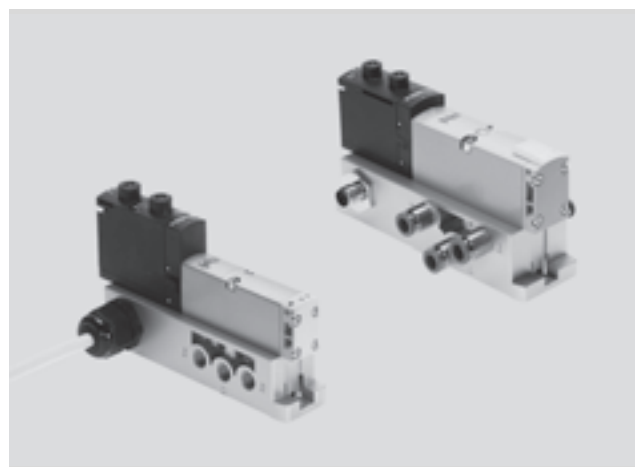

General technical data				
Design	Piston spool valve			
Sealing principle	Soft			
Actuation type	Electric			
Type of control	Piloted			
Exhaust function, with flow control	Via individual sub-base			
Lubrication	Life-time lubrication			
Type of mounting	<ul style="list-style-type: none"> • Valve: Screwed onto sub-base • Individual sub-base: Screwed via through-hole 			
Mounting position	Any			
Manual override	Detenting, non-detenting, covered			
Pneumatic connections – NPT thread				
Width	18 mm	26 mm	42 mm	52 mm
Pneumatic connection	Via sub-base			
Supply port	1	1/8"NPT	1/4"NPT	3/8"NPT
Exhaust port	3/5	1/8"NPT	1/4"NPT	3/8"NPT
Working ports	2/4	1/8"NPT	1/4"NPT	3/8"NPT
External pilot air supply port	14	10-32UNF-2B	1/8"NPT	1/8"NPT
Pilot exhaust air port	12	10-32UNF-2B	1/8"NPT	1/8"NPT

Operating and environmental conditions, individual sub-base	
Operating medium	Compressed air to ISO 8573-1:2010 [7:4:4]
Notes about the operating/pilot medium	Lubricated operation possible (in which case lubricated operation will always be required)
Operating pressure [bar]	-0.9 ... +10
Ambient temperature [°C]	-5 ... +50
Certification	c UL us - Recognized (OL)
CE marking (see declaration of conformity)	In accordance with EU Low Voltage Directive (not for VABS-S4...R3 and variants BB 52, VABS-S2-2S...)
Protection class	IP65, NEMA 4 (for all types of signal transmission in assembled state)

Valve terminals VTSA/VTSA-F, NPT

Technical data – Valves on individual sub-base

Standard nominal flow rate of valve/individual sub-base [l/min], 24 V DC, 110 V AC				
Valve function (with valve code)	Width 18 mm		Width 26 mm	
	Valve	Valve on individual sub-base	Valve	Valve on individual sub-base
5/2-way, double solenoid (B52)	750	600	1400	1200
5/2-way, double solenoid with dominant signal (D52)	750	600	1400	1200
5/2-way, single solenoid, pneum. spring (M52-A)	750	600	1400	1200
5/2-way single solenoid, mech. spring (M52-M)	750	600	1400	1200
5/3-way, closed (P53C)	700	550	1400 ¹⁾ 700 ²⁾	1200 ¹⁾ 700 ²⁾
5/3-way, exhausted (P53E)	700 ¹⁾ 330 ²⁾	500 ¹⁾ 330 ²⁾	1400 ¹⁾ 700 ²⁾	1200 ¹⁾ 700 ²⁾
5/3-way, pressurised (P53U)	700 ¹⁾ 330 ²⁾	500 ¹⁾ 330 ²⁾	1400 ¹⁾ 700 ²⁾	1200 ¹⁾ 700 ²⁾
5/3-way, exhausted, switching position 14 detenting (P53ED) ³⁾	–	–	1400 ¹⁾ 700 ²⁾	1200 ¹⁾ 700 ²⁾
5/3-way, exhausted, switching position 12 detenting (P53EP) ³⁾	–	–	1400 ¹⁾ 700 ²⁾	1200 ¹⁾ 700 ²⁾
5/3-way, port 2 pressurised, 4 exhausted, switching position 14 detenting (P53AD) ³⁾	–	–	700 ¹⁾ 700 ²⁾	700 ¹⁾ 700 ²⁾
5/3-way, port 4 pressurised, 2 exhausted, switching position 14 detenting (P53BD) ³⁾	–	400	–	–
2x3/2-way, single solenoid, closed (T32C)	600	500	1250	1100
2x3/2-way, single solenoid, open (T32U)	600	500	1250	1100
2x3/2-way, single solenoid, open/closed (T32H)	600	500	1250	1100
2x3/2-way, single solenoid, closed (T32N)	600	500	1250	1100
2x3/2-way, single solenoid, open (T32F)	600	500	1250	1100
2x3/2-way, single solenoid, open/closed (T32W)	600	500	1250	1100
2x2/2-way, single solenoid, closed (T22C)	700	500	1350	1100
2x2/2-way, single solenoid, closed (T22CV)	700	500	1350	1100

1) Switching position

2) Mid-position

3) The valve functions P53AD, P53BD, P53ED and P53EP are only available in the 24 V DC version. Values only apply to 24 V DC.

Valve terminals VTSA/VTSA-F, NPT

Technical data – Valves on individual sub-base

Standard nominal flow rate of valve/individual sub-base [l/min], 24 V DC, 110 V AC				
Valve function (with valve code)	Width 42 mm		Width 52 mm	
	Valve	Valve on individual sub-base	Valve	Valve on individual sub-base
5/2-way, double solenoid (B52)	2000	1500	4000	3400
5/2-way, double solenoid with dominant signal (D52)	2000	1500	4000	3400
5/2-way, single solenoid, pneum. spring (M52-A)	2000	1500	4000	3400
5/2-way single solenoid, mech. spring (M52-M)	2000	1500	4000	3400
5/3-way, closed (P53C)	1900 ¹⁾ 950 ²⁾	1400 ¹⁾ 800 ²⁾	3600 ¹⁾ 1700 ²⁾	3200 ¹⁾ 1700 ²⁾
5/3-way, exhausted (P53E)	1900 ¹⁾ 950 ²⁾	1400 ¹⁾ 800 ²⁾	3600 ¹⁾ 1700 ²⁾	3200 ¹⁾ 1700 ²⁾
5/3-way, pressurised (P53U)	1900 ¹⁾ 950 ²⁾	1400 ¹⁾ 800 ²⁾	3600 ¹⁾ 1700 ²⁾	3200 ¹⁾ 1700 ²⁾
5/3-way, pressurised 1 to 2, 4 to 5 closed (P53F) ³⁾	1700 ¹⁾ 700 ²⁾	1400 ¹⁾ 700 ²⁾	3000 ¹⁾ 900 ²⁾	2600 ¹⁾ 900 ²⁾
2x3/2-way, single solenoid, closed (T32C)	1600	1200	3000	2600
2x3/2-way, single solenoid, open (T32U)	1600	1200	3000	2600
2x3/2-way, single solenoid, open/closed (T32H)	1600	1200	3000	2600
2x3/2-way, single solenoid, closed (T32N)	1600	1200	3000	2600
2x3/2-way, single solenoid, open (T32F)	1600	1200	3000	2600
2x3/2-way, single solenoid, open/closed (T32W)	1600	1200	3000	2600
2x2/2-way, single solenoid, closed (T22C)	1600	1400	4000	3400
2x2/2-way, single solenoid, closed (T22CV)	1600	1400	–	–

1) Switching position

2) Mid-position

3) The valve function P53F is only available in the 24 V DC version. Values only apply to 24 V DC.

Electrical data		
Acceptable current load at 40 °C	[A]	2 (1 A per coil)
Protection class to EN 60529		IP65, NEMA 4 (for all types of signal transmission in assembled state)
Variants with cable connector		
Operating voltage range	[V DC]	24 ±10% (for variants with cable terminal VABS-...-K1/C1, ...-K2)
	[V AC]	110 ±10% (50 ... 60 Hz) (for variants with cable and spring-loaded terminal VABS-...-K1/C1, ...-K2)
Surge resistance	[kV]	4
Degree of contamination		3
Duty cycle	[ED]	100%



Note

A cable connector is needed to ensure the IP protection class and to protect against tensile load, twisting and bending.

Valve terminals VTSA/VTSA-F, NPT

Technical data – Valves on individual sub-base

Materials				
Width	18 mm	26 mm	42 mm	52 mm
Connecting plate	Die-cast aluminium			Gravity die-cast aluminium
Valve	Die-cast aluminium, reinforced polyamide			
Seals	Nitrile rubber, elastomer (support made of steel)			

Product weight [g]				
Width	18 mm	26 mm	42 mm	52 mm
Valves				
5/2-way valve, 5/2-way, double solenoid (B52, D52)	172	276	439	732
5/2-way solenoid valve, single solenoid (M52-AZD, M52-MZD)	163	293	426	702
5/3-way solenoid valve (P53C, P53E, P53U)	191	320	456	780
5/3-way solenoid valve (P53BD)	172	–	–	–
5/3-way solenoid valve (P53ED, P53EP)	–	291	–	–
5/3-way solenoid valve (P53AD)	–	301	–	–
5/3-way solenoid valve (P53F)	–	–	456	780
2x 3/2-way solenoid valve (T32C, T32U, T32H, T32N, T32F, T32W)	190	335	442	740
2x 2/2-way solenoid valve (T22C, T22CV)	190	335	442	740
Individual connection				
Individual sub-base	192	302	386	815

Valve terminals VTSA/VTSA-F, NPT

Technical data – Valves on individual sub-base

Dimensions

Download CAD data → www.festo.com

Individual sub-base with cable terminals, width 18 mm

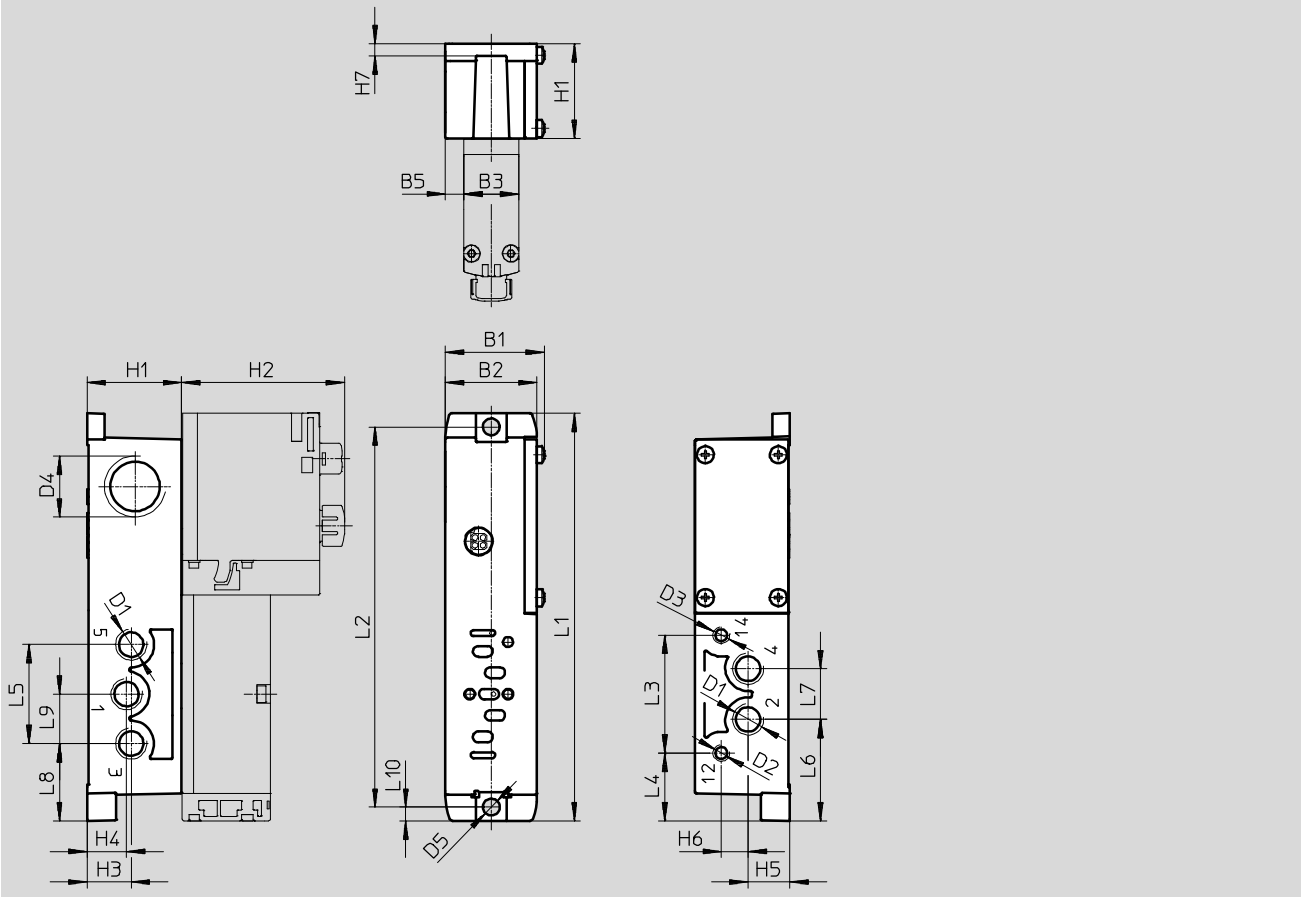

Type	B1	B2	B3	B5	D1	D2	D3	D4	D5 Ø	H1	H2	H3	H4	H5	H6	H7
VABS-S4-2S-N18-K2 ¹⁾	32.4	30	18	6	1/8" NPT	10-32UNF-2B	10-32UNF-2B	M20x1.5	5.5	31	53.4	14.5	13	13.7	8.8	4
VABS-S4-2S-N18-B-K2 ²⁾							-									

Type	L1	L2	L3	L4	L5	L6	L7	L8	L9	L10
VABS-S4-2S-N18-K2 ¹⁾	133.5	124.5	38.6	22.2	32.4	33.2	16.6	25.3	16.2	4.5
VABS-S4-2S-N18-B-K2 ²⁾										

- 1) External pilot air supply
- 2) Internal pilot air supply

• - Note: This product conforms to ISO 1179-1 and to ISO 228-1

Valve terminals VTSA/VTSA-F, NPT

Technical data – Valves on individual sub-base

Dimensions

Download CAD data → www.festo.com

Individual sub-base with cable terminals, width 26 mm

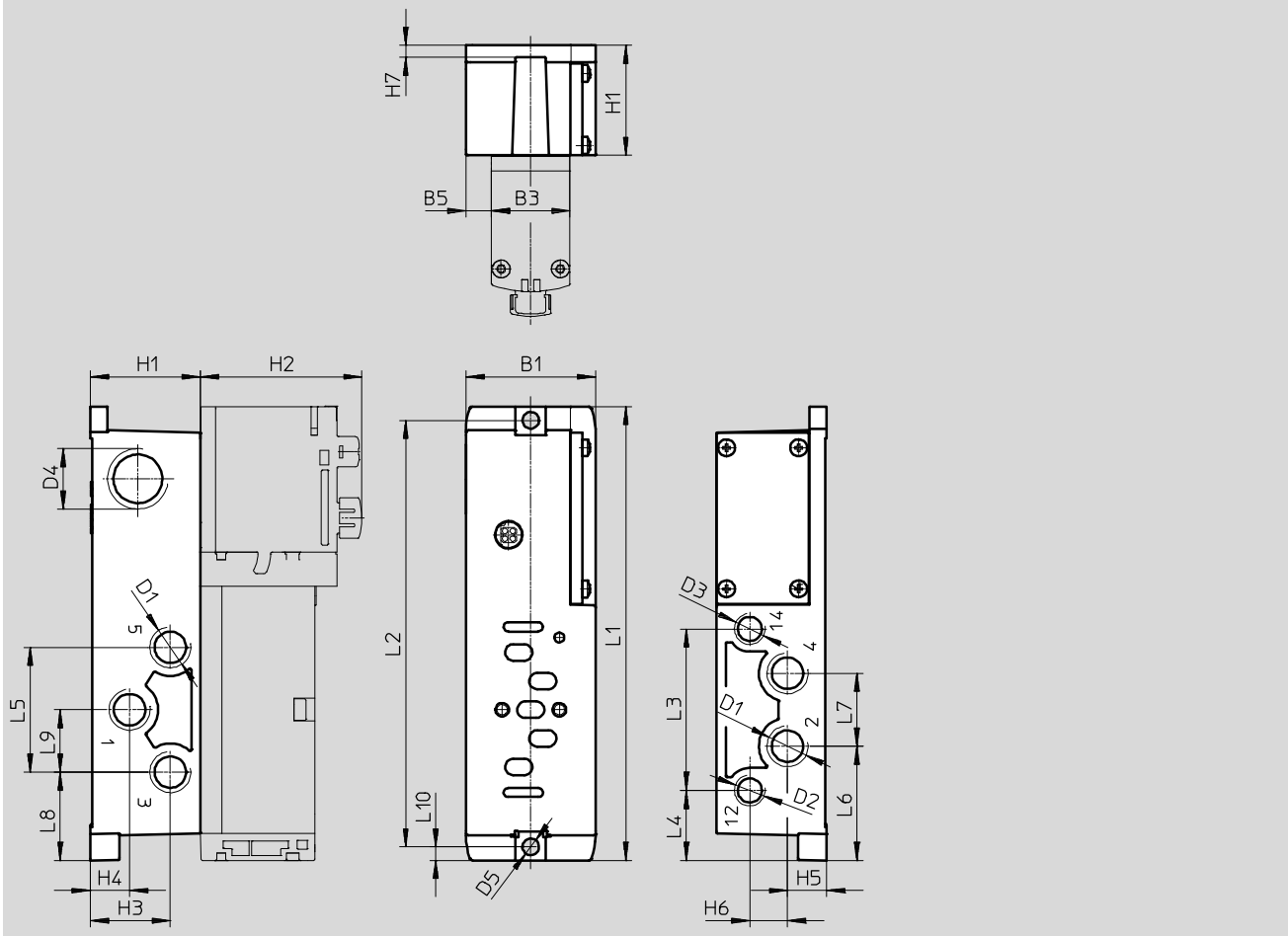

Type	B1	B3	B5	D1	D2	D3	D4	D5 Ø	H1	H2	H3	H4	H5	H6	H7
VABS-S4-1S-G14-K2 ¹⁾	43	26	8.5	1/4"NPT	1/8"NPT	1/8"NPT	M20x1.5	5.5	36.5	53.5	26.5	13	13	12.5	4
VABS-S4-1S-G14-B-K2 ²⁾						-									

Type	L1	L2	L3	L4	L5	L6	L7	L8	L9	L10
VABS-S4-1S-G14-K2 ¹⁾	150.6	141.5	53.6	23.2	41.4	37.9	24.2	29.3	20.7	4.5
VABS-S4-1S-G14-B-K2 ²⁾										

- 1) External pilot air supply
- 2) Internal pilot air supply

· † - Note: This product conforms to ISO 1179-1 and to ISO 228-1

Valve terminals VTSA/VTSA-F, NPT

Technical data – Valves on individual sub-base

Dimensions

Download CAD data → www.festo.com

Individual sub-base with spring-loaded terminal or for self-assembly, width 42 mm

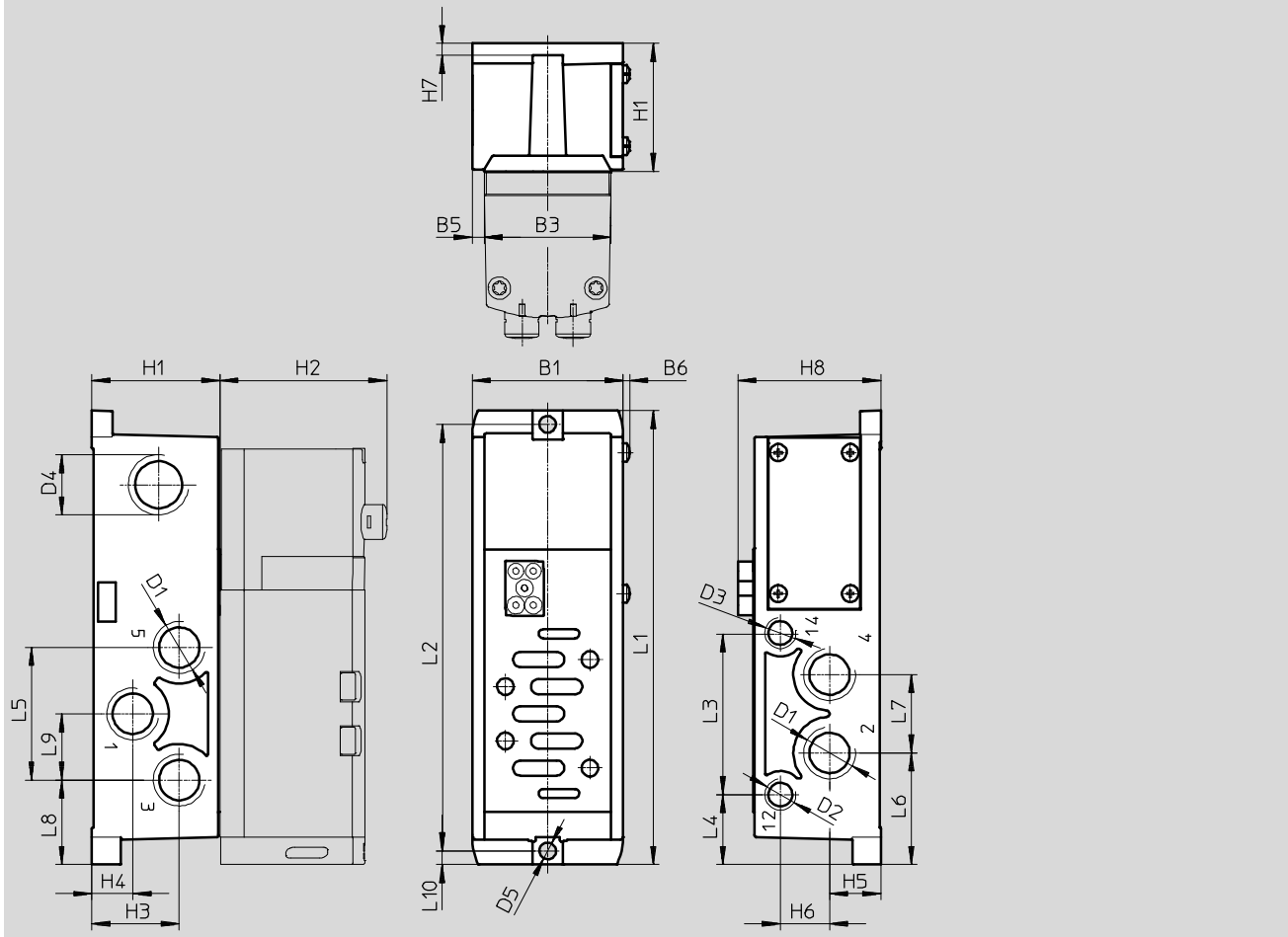

Type	B1	B3	B5	B6	D1	D2	D3	D4	D5 Ø	H1	H2	H3	H4	H5	H6	H7	H8
VABS-S2-1S-N38-K1 ¹⁾	50	42	4	2.2	3/8"NPT	1/8"NPT	1/8"NPT	M20x1.5	5.5	42.5	55.3	29	13.6	17.1	16.3	4	47.5
VABS-S2-1S-N38-C1 ¹⁾																	
VABS-S2-1S-N38-B-K1 ²⁾							-										
VABS-S2-1S-N38-B-C1 ²⁾																	

Type	L1	L2	L3	L4	L5	L6	L7	L8	L9	L10
VABS-S2-1S-N38-K1 ¹⁾	150.6	141.5	53.6	23.2	44	37	26	28	22	4.5
VABS-S2-1S-N38-C1 ¹⁾										
VABS-S2-1S-N38-B-K1 ²⁾										
VABS-S2-1S-N38-B-C1 ²⁾										

- 1) External pilot air supply
- 2) Internal pilot air supply

-||- Note: This product conforms to ISO 1179-1 and to ISO 228-1

-||- Note

Electrical connection

- VABS-...-K1: open end
- VABS-...-C1: spring-loaded terminal

Valve terminals VTSA/VTSA-F, NPT

Technical data – Valves on individual sub-base

FESTO

Dimensions

Download CAD data → www.festo.com

Individual sub-base with spring-loaded terminal or for self-assembly, width 52 mm

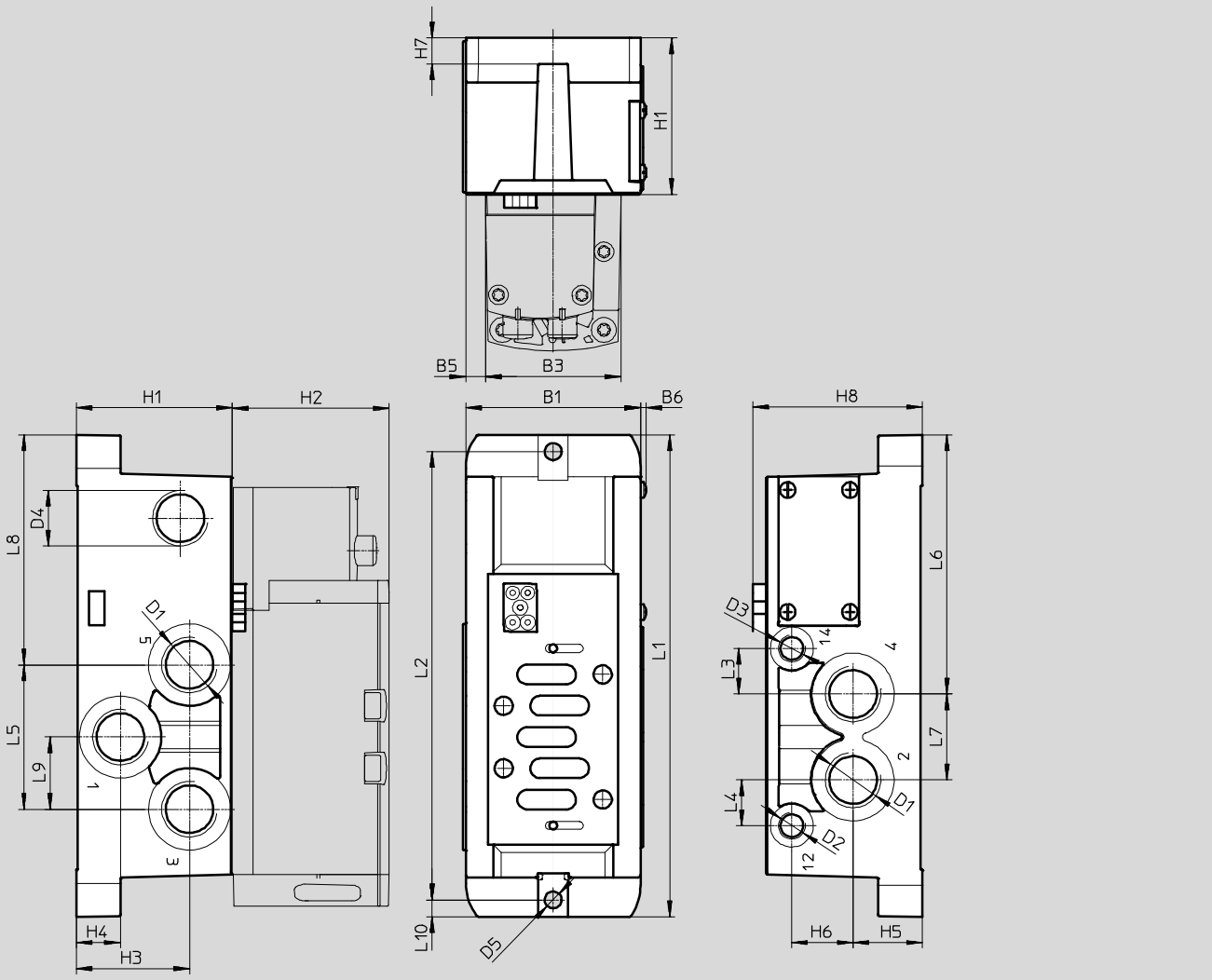

Type	B1	B3	B5	B6	D1	D2	D3	D4	D5 Ø	H1	H2	H3	H4	H5	H6	H7	H8
VABS-S2-2S-N12-K1 ¹⁾	67	52	7.5	2.2	1/2"NPT	1/8"NPT	1/8"NPT	M20x1.5	6.5	60	60	43.5	17	26.5	23.5	10	65
VABS-S2-2S-N12-C1 ¹⁾																	
VABS-S2-2S-N12-B-K1 ²⁾							-										
VABS-S2-2S-N12-B-C1 ²⁾																	

Type	L1	L2	L3	L4	L5	L6	L7	L8	L9	L10
VABS-S2-2S-N12-K1 ¹⁾	185	172	17.5	17.5	55.4	99.5	33	88.3	27.7	6.5
VABS-S2-2S-N12-C1 ¹⁾										
VABS-S2-2S-N12-B-K1 ²⁾										
VABS-S2-2S-N12-B-C1 ²⁾										

- 1) External pilot air supply
2) Internal pilot air supply

- Note: This product conforms to ISO 1179-1 and to ISO 228-1

Note

Electrical connection

- VABS-...-K1: open end
- VABS-...-C1: spring-loaded terminal

Valve terminals VTSA/VTSA-F, NPT

Accessories – Individual connection

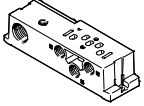
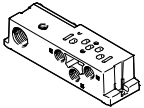
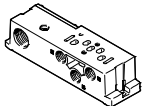
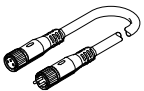
Ordering data					
	Description		Width	Part No.	Type
Individual sub-base, electrical connection via cable terminals					
	Threaded connection, internal pilot air supply	Connections 1/8"NPT	18 mm	541068	VABS-S4-2S-N18-B-K2
		Connections 1/4"NPT	26 mm	541066	VABS-S4-1S-N14-B-K2
	Threaded connection, external pilot air supply	Connections 1/8"NPT	18 mm	539724	VABS-S4-2S-N18-K2
		Connections 1/4"NPT	26 mm	539726	VABS-S4-1S-N14-K2
Individual sub-base, electrical connection via spring-loaded terminal					
	Threaded connection, internal pilot air supply	Connections 3/8"NPT	42 mm	546763	VABS-S2-1S-N38-B-C1
		Connections 1/2"NPT	52 mm	555644	VABS-S2-2S-N12-B-C1
	Threaded connection, external pilot air supply	Connections 3/8"NPT	42 mm	546761	VABS-S2-1S-N38-C1
		Connections 1/2"NPT	52 mm	555639	VABS-S2-2S-N12-C1
Individual sub-base, electrical connection via cable (open end)					
	Threaded connection, internal pilot air supply	Connections 3/8"NPT	42 mm	546103	VABS-S2-1S-N38-B-K1
		Connections 1/2"NPT	52 mm	555642	VABS-S2-2S-N12-B-K1
	Threaded connection, external pilot air supply	Connections 3/8"NPT	42 mm	546100	VABS-S2-1S-N38-K1
		Connections 1/2"NPT	52 mm	555637	VABS-S2-2S-N12-K1
Connecting cable for electrical connection of individual valves at the individual electrical connection					
	Modular system for connecting cables			–	NEBU-... → Internet: nebu
Pneumatic connection accessories					
A selection of possible fittings, blanking plugs, silencers and other pneumatic accessories can be found in the chapter Accessories → page 194 or on the Internet via the individual search terms: Internet → connection technology, silencer, blanking plug					

Valve terminals VTSA/VTSA-F, NPT

Accessories

FESTO

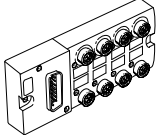
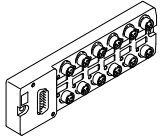
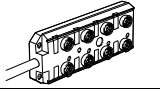
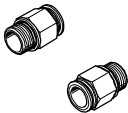
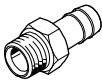

Ordering data					
	Description		Part No.	Type	PU ¹⁾
Multi-pin plug distributor					
	15-pin Sub-D socket/8x 3-pin M8 plugs	8 I/Os	177669	MPV-E/A08-M8	1
	15-pin Sub-D socket/12x 3-pin M8 plugs	12 I/Os	177670	MPV-E/A12-M8	1
	15-pin cable/8x 5-pin M12 plugs	8 I/Os	177671	MPV-E/A08-M12	1
Push-in fitting					
	Connecting thread 1/4" NPT for tubing O.D.	1/2 □	567771	QB-1/4-1/2-U	10
		3/8 □	533278	QB-1/4-3/8-U	10
		5/16 □	533277	QB-1/4-5/16-U	10
	Connecting thread 1/8" NPT for tubing O.D.	3/8 □	567773	QB-1/8-3/8-U	10
		1/4 □	533273	QB-1/8-1/4-U	10
		5/16 □	533274	QB-1/8-5/16-U	10
	Connecting thread 3/8" NPT for tubing O.D.	1/2 □	533282	QB-3/8-1/2-U	5
		3/8 □	533281	QB-3/8-3/8-U	5
	Connecting thread 1/2" NPT for tubing O.D.	5/8 □	190682	QS-1/2-5/8-U	1
		1/2 □	533284	QB-1/2-1/2-U	5
Female hose connector					
	For right-hand end plate (connecting thread NPT)	3/4 □	564848	N-3/4-P-19-NPT	1
		R1	572243	N-1-P-19-NPT	1
	For adapter plate (connecting thread NPT)	R1			1

1) Packaging unit

Valve terminals VTSA/VTSA-F, NPT

Accessories

FESTO

Ordering data						
	Code	Description		Part No.	Type	PU ¹⁾
Silencer						
	U	Standard version, connecting thread NPT	1/8" □	12638	U-1/8-B-NPT	1
			1/4" □	12639	U-1/4-B-NPT	1
			1/2" □	12741	U-1/2-B-NPT	1
			3/4" □	566823	U-3/4-B-NPT	1
			1" □	571280	U-1-B-NPT	1
	A	Sintered version, connecting thread NPT	1/8" □	1206989	AMTE-M-LH-N18	20
			1/4" □	1206990	AMTE-M-LH-N14	20
			1/2" □	1206992	AMTE-M-LH-N12	10
Blanking plug						
	-	Connecting thread NPT	1/8" □	173985	B-1/8-NPT	1
			1/4" □	174165	B-1/4-NPT	1
			1/2" □	31785	B-1/2-NPT	1
			3/4" □	31786	B-3/4-NPT	1
			1" □	31787	B-1-NPT	1
Other pneumatic connection accessories						
A selection of possible fittings, blanking plugs and silencers can be found on the Internet via the individual search terms: Internet → connection technology, silencer, blanking plug						

1) Packaging unit

Product Range and Company Overview

A Complete Suite and Company Overview

Our experienced engineers provide complete support at every stage of your development process, including: conceptualization, analysis, engineering, design, assembly, documentation, validation, and production.



Custom Automation Components
Complete custom engineered solutions



Custom Control Cabinets
Comprehensive engineering support and on-site services



Complete Systems
Shipment, stocking and storage services

The Broadest Range of Automation Components

With a comprehensive line of more than 30,000 automation components, Festo is capable of solving the most complex automation requirements.



Electromechanical
Electromechanical actuators, motors, controllers & drivers



Pneumatics
Pneumatic linear and rotary actuators, valves, and air supply



PLCs and I/O Devices
PLC's, operator interfaces, sensors and I/O devices

Supporting Advanced Automation... As No One Else Can!

Festo is a leading global manufacturer of pneumatic and electromechanical systems, components and controls for industrial automation, with more than 16,000 employees in 60 national headquarters serving more than 180 countries. For more than 80 years, Festo has continuously elevated the state of manufacturing with innovations and optimized motion control solutions that deliver higher performing, more profitable automated manufacturing and processing equipment. Our dedication to the advancement of automation extends beyond technology to the education and development of current and future automation and robotics designers with simulation tools, teaching programs, and on-site services.

Quality Assurance, ISO 9001 and ISO 14001 Certifications

Festo Corporation is committed to supply all Festo products and services that will meet or exceed our customers' requirements in product quality, delivery, customer service and satisfaction.

To meet this commitment, we strive to ensure a consistent, integrated, and systematic approach to management that will meet or exceed the requirements of the ISO 9001 standard for Quality Management and the ISO 14001 standard for Environmental Management.



© Copyright 2013, Festo Corporation. While every effort is made to ensure that all dimensions and specifications are correct, Festo cannot guarantee that publications are completely free of any error, in particular typing or printing errors. Accordingly, Festo cannot be held responsible for the same. For Liability and Warranty conditions, refer to our "Terms and Conditions of Sale", available from your local Festo office. All rights reserved. No part of this publication may be reproduced, distributed, or transmitted in any form or by any means, electronic, mechanical, photocopying or otherwise, without the prior written permission of Festo. All technical data subject to change according to technical update.



Printed on recycled paper at New Horizon Graphic, Inc., FSC certified as an environmental friendly printing plant.

Festo North America

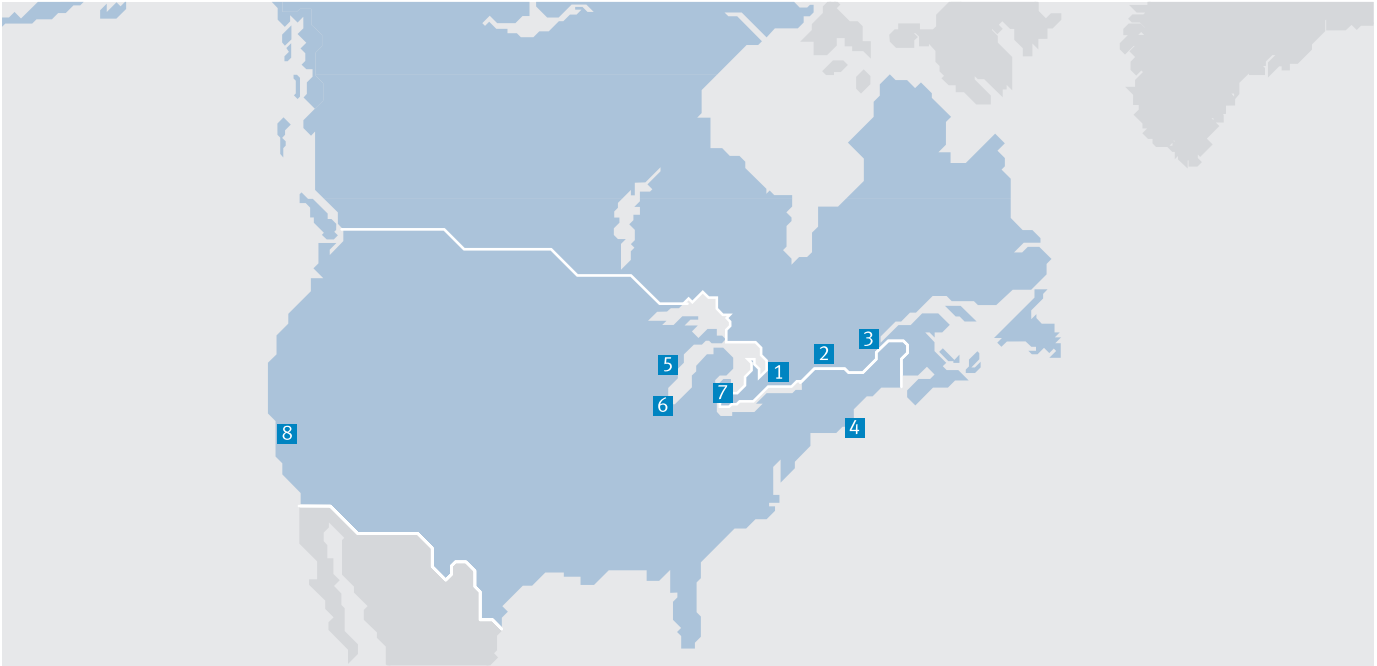

**1 Festo Canada
Headquarters
Festo Inc.**
5300 Explorer Drive
Mississauga, ON
L4W 5G4

2 Montréal
5600, Trans-Canada
Pointe-Claire, QC
H9R 1B6

3 Québec City
2930, rue Watt#117
Québec, QC
G1X 4G3



**4 Festo United States
Headquarters
Festo Corporation**
395 Moreland Road
Hauppauge, NY
11788

5 Appleton
North 922 Tower View Drive, Suite N
Greenville, WI
54942

7 Detroit
1441 West Long Lake Road
Troy, MI
48098

6 Chicago
85 W Algonquin - Suite 340
Arlington Heights, IL
60005

8 Silicon Valley
4935 Southfront Road, Suite F
Livermore, CA
94550

Festo Regional Contact Center

Canadian Customers

Commercial Support:
Tel: 1 877 GO FESTO (1 877 463 3786)
Fax: 1 877 FX FESTO (1 877 393 3786)
Email: festo.canada@ca.festo.com

Technical Support:

Tel: 1 866 GO FESTO (1 866 463 3786)
Fax: 1 877 FX FESTO (1 877 393 3786)
Email: technical.support@ca.festo.com

USA Customers

Commercial Support:
Tel: 1 800 99 FESTO (1 800 993 3786)
Fax: 1 800 96 FESTO (1 800 963 3786)
Email: customer.service@us.festo.com

Technical Support:

Tel: 1 866 GO FESTO (1 866 463 3786)
Fax: 1 800 96 FESTO (1 800 963 3786)
Email: product.support@us.festo.com