

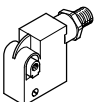



Proximity sensors, block design



Proximity sensors, block design

Product range overview

Measuring principle	Version	Type	Mounting	Switching element function		Switching output	Electrical connection	
				N/O contact	N/C contact		Cable	Plug
Magneto-resistive	Operating voltage range 10 ... 30 V DC							
		SMTO-1	Via accessories	■	-	PNP	3-wire	M8x1, 3-pin
				■	-	NPN	3-wire	M8x1, 3-pin
	SMTSO-1 Welding field immune		■	-	PNP	-	M12x1, 3-pin	
Magnetic reed	Operating voltage range 0 ... 30 V DC							
		SMEO-1	Via accessories	■	-	Contacting	-	M8x1, 3-pin ¹⁾
				■	-		3-wire	M8x1, 3-pin
	Operating voltage range 0 ... 250 V AC, 0 ... 200 V DC							
		SMEO-1-B	Via accessories	■	-	Contacting	2-wire	-
		SMEO-1		■	-		2-wire	-
				■	-		2-wire	-
	SMEO-1-S6-C Heat-resistant up to 120 °C	■		-	2-wire		-	
Magnetic	Pneumatic proximity sensor, operating pressure 2 ... 6 bar							
	SMPO-1	Via accessories	■ ²⁾	-	-	-	-	
Magneto-inductive	Operating voltage range 10 ... 30 V DC							
		SMT-C1	Clamped	■	-	PNP	3-wire	M8x1, 3-pin M12x1, 3-pin

1) The proximity sensor has 2 wires internally. One pin of the M8 plug is unused.

2) 3/2-way valve, normally closed

Proximity sensors, block design

Product range overview

Type	Connection direction		Replacement with- out re-adjustment	Switching status display via LED	Free of copper and PTFE	→ Page/Internet
	In-line	Lateral				
Operating voltage range 10 ... 30 V DC						
SMT0-1	■	-	■ 1)	■	■	7
	■	-	■ 1)	■	-	
SMTSO-1 Welding field immune	■	-	-	■	-	9
Operating voltage range 0 ... 30 V DC						
SME0-1	■	-	■ 1)	-	■	11
	■	-	■ 1)	■	■	
Operating voltage range 0 ... 250 V DC, 0 ... 200 V DC						
SME0-1-B	■	-	■ 1)	-	-	11
SME0-1	■	-	■ 1)	■	-	
	■	-	■ 1)	-	-	
SME0-1-S6-C Heat-resistant up to 120 °C	■	-	■ 1)	■	-	
Pneumatic proximity sensor, operating pressure 2 ... 6 bar						
SMPO-1	■	-	■ 1)	- 2)	-	14
Operating voltage range 10 ... 30 V DC						
SMT-C1	■	-	-	■	■	16

1) Not in combination with mounting kit SMB-1 or SMBS-...

2) Switching status is indicated via a pneumatic pin

Proximity sensors, block design

Overview of peripherals

FESTO

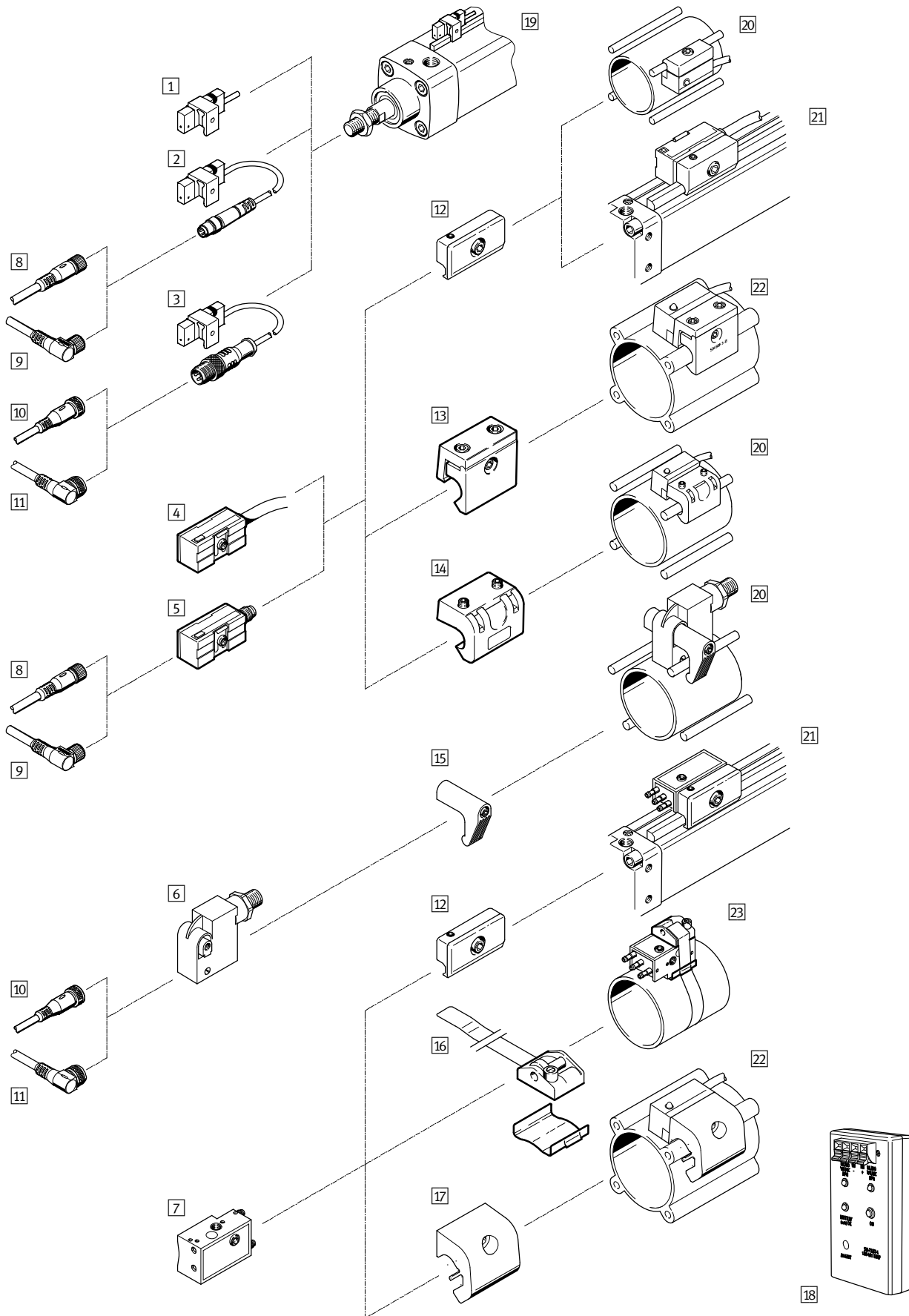

Proximity sensors, block design

Overview of peripherals

Mounting attachments and accessories			
	Brief description	→ Page/Internet	
Proximity sensors			
1	SMT-C1-...	Magneto-inductive, with cable and clamping component	16
2	SMT-C1-...	Magneto-inductive, with cable and plug M8x1 and clamping component	16
3	SMT-C1-...	Magneto-inductive, with cable and plug M12x1 and clamping component	16
4	SMT0-1-...	Magneto-resistive, with cable	7
	SME0-1-...	Magnetic reed, with cable	11
5	SMT0-1-...	Magneto-resistive, with plug M8x1	7
	SME0-1-...	Magnetic reed, with plug M8x1	11
6	SMTSO-1-...	Magneto-resistive, welding field immune, with plug M12x1	9
7	SMPO-1-...	Pneumatic	14
Accessories			
8	Connecting cable NEBU-M8G3-...	Straight socket, M8x1, 3-pin	21
9	Connecting cable NEBU-M8W3-...	Angled socket, M8x1, 3-pin	
10	Connecting cable NEBU-M12G5-...	Straight socket, M12x1, 3-pin	
11	Connecting cable NEBU-M12W5-...	Angled socket, M12x1, 3-pin	
12	Mounting kit SMB-1	For drives with tie rod \varnothing 6 mm or mounting rail For standard cylinders DSBG	19
13	Mounting kit SMBU-1-B	For standard cylinders DNU	19
14	Mounting kits SMB-2-B, SMB-3-B	For standard cylinders DSBG	19
15	Mounting kit SMBT-1	For standard cylinders DSBG	20
16	Mounting kit SMBS-...	For round cylinders	20
17	Mounting kit SMBU-1-H-32	For standard cylinders DNU	20
18	Sensor tester SM-TEST-1		sm-test-1
Drives			
19	Standard cylinder DSBF-C or CDN-...-R with sensor rail	\varnothing 32 ... 100 mm	-
20	Standard cylinder DSBG	\varnothing 32 ... 125 mm	-
21	Flat cylinder DZH	\varnothing 32 ... 63 mm	-
	Semi-rotary drive DRQ	\varnothing 40 ... 100 mm	
22	Standard cylinder DNU	\varnothing 32 ... 125 mm	
23	Round cylinder	\varnothing 8 ... 100 mm	

Proximity sensors, block design

Type codes

Proximity sensor for cylinders with tie or mounting rod

SMT0-1 – PS – K – LED – 24 – C

Function	
SMT0-1	Proximity sensor, block design, magneto-resistive
SMTSO-1	Proximity sensor, block design, magneto-resistive, welding field immune
SMEO-1	Proximity sensor, block design, magnetic reed
SMPO-1	Proximity sensor, block design, magnetic
Switching output, switching element function	
PS	PNP, N/O contact, 3-wire
NS	NPN, N/O contact, 3-wire
	N/O contact, 2 or 3-wire
Electrical connection, cable length	
K	Cable, 2.5 m
S	Plug M8x1
Switching status display	
LED	Yellow LED
Rated operating voltage	
24	24 V DC
230	230 V AC
Generation	
B	B series
C	C series

Proximity sensor for standard cylinders DSBF-C or CDN-...-R with sensor strip

SMT-C1 – PS – 24V – K – 5,0 – OE

Function	
SMT-C1	Proximity sensor, block design, magneto-inductive
Switching element function, switching output	
PS	N/O contact, 3-wire, PNP
Rated operating voltage	
24V	24 V DC
Version	
K	Cable
Cable length	
0,3	0.3 m
5,0	5.0 m
10,0	10.0 m
Electrical connection	
OE	Open end
M8D	Cable with plug M8x1, rotatable thread
M12	Cable with plug M12x1

Proximity sensors SMT0-1, block design, magneto-resistive

Technical data

Function

e.g. PNP, N/O contact, with cable

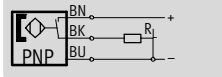

e.g. NPN, N/O contact, with cable

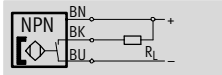

- Magneto-resistive measuring principle



Design	
Constructional design	Block design
Type of mounting	Via accessories
Connection direction	In-line
Reproducibility of switching point ¹⁾	[mm] ±0.1
Switching status display	Yellow LED

1) Only applicable to drives secured against rotation.

Technical data – N/O contact		
Switch output	PNP NPN	
Electrical connection	Cable, 3-wire	Plug M8x1, 3-pin
Cable length	[m] 2.5	–
Operating voltage range	[V DC] 10 ... 30	
Max. switching current	[mA] 200	
Max. switching capacity	[W] 6	
Voltage drop	[V] 3	
Residual current	[mA] ≤0.01	
Switch-on time	[ms] ≤1	
Switch-off time	[ms] ≤1	
Protection against short circuit	Yes	
Protection against polarity reversal	For all electrical connections	
Protection class	IP67	

Operating and environmental conditions			
Electrical connection	Cable		Plug
Cable installation	Fixed	Flexible	
Ambient temperature	[°C] –25 ... +70	–5 ... +70	–25 ... +70
Corrosion resistance class CRC ¹⁾	4		2
CE symbol (declaration of conformity)	In accordance with EU EMC directive ²⁾		
Certification	RCM trademark		

- 1) Corrosion resistance class CRC 2 to Festo standard FN 940070
Moderate corrosion stress. Indoor applications in which condensation may occur. External visible parts with primarily decorative requirements for the surface and which are in direct contact with the ambient atmosphere typical for industrial applications.
Corrosion resistance class CRC 4 to Festo standard FN 940070
Particularly high corrosion stress. Outdoor exposure under extreme corrosive conditions. Parts exposed to aggressive media, for instance in the chemical or food industries. These applications may need to be supported by special tests (→ also FN 940082) using appropriate media.
- 2) For information about the applicability of the component see the manufacturer's EC declaration of conformity at: www.festo.com/sp → User documentation.
If the component is subject to restrictions on usage in residential, office or commercial environments or small businesses, further measures to reduce the emitted interference may be necessary.

Materials	
Housing	Die-cast zinc, polyester
Cable sheath	Polyvinyl chloride
Note on materials	Free of copper and PTFE

Proximity sensors SMTO-1, block design, magneto-resistive

Technical data

Product weights [g]		
Electrical connection	Cable	Plug
N/O contact		
PNP	85	20
NPN	85	20

Dimensions Download CAD data → www.festo.com

Cable type

1 Connecting cable
2 Yellow LED

Plug type M8x1

2 Yellow LED
3 Plug suitable for plug socket with cable NEBU-M8...
4 Installation space for angled socket

Ordering data

	Switch output	Electrical connection		Cable length [m]	Part No.	Type
		Cable	Plug M8x1			
	N/O contact					
	PNP	3-wire	–	2.5	151683	SMTO-1-PS-K-LED-24-C
		–	3-pin	–	151685	SMTO-1-PS-S-LED-24-C
	NPN	3-wire	–	2.5	151684	SMTO-1-NS-K-LED-24-C
–		3-pin	–	151686	SMTO-1-NS-S-LED-24-C	

Proximity sensors SMTSO-1, block design, magneto-resistive

Technical data

Function

PNP, N/O contact, with plug

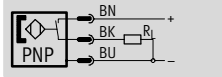

- Welding field immune
- Magneto-resistive measuring principle



Design	
Constructional design	Block design
Type of mounting	Via accessories
Connection direction	In-line
Reproducibility of switching point ¹⁾	[mm] ±0.1
Switching status display	Yellow LED
Ready status display	Green LED

1) Only applicable to drives secured against rotation

Technical data – PNP, N/O contact	
Electrical connection	Plug M12x1, 3-pin
Operating voltage range	[V DC] 10 ... 30
Max. switching current	[mA] 200
Max. switching capacity	[W] 6
Voltage drop	[V] 3
Residual current	[mA] 0.01
Switch-on time	[ms] ≤35
Switch-off time	[ms] ≤20
Resistance to interference from magnetic fields	Alternating magnetic field 50 ... 60 Hz
Protection against short circuit	Yes
Protection against polarity reversal	For all electrical connections
Protection class	IP65/IP67

Operating and environmental conditions	
Ambient temperature	[°C] -25 ... +70
Corrosion resistance class CRC ¹⁾	1
CE symbol (declaration of conformity)	In accordance with EU EMC directive ²⁾
Certification	RCM trademark

- 1) Corrosion resistance class CRC 1 to Festo standard FN 940070
Low corrosion stress. For dry indoor applications or transport and storage protection. Also applies to parts behind covers, in the non-visible interior area, and parts which are covered in the application (e.g. drive trunnions).
- 2) For information about the applicability of the component see the manufacturer's EC declaration of conformity at: www.festo.com/sp → User documentation.
If the component is subject to restrictions on usage in residential, office or commercial environments or small businesses, further measures to reduce the emitted interference may be necessary.

Materials	
Housing	Die-cast zinc

Product weights [g]	
N/O contact	
PNP	70

Proximity sensors SMTSO-1, block design, magneto-resistive

Technical data

Dimensions Download CAD data → www.festo.com

Plug type M12x1

The drawing shows two views of the sensor. The left view is a front view with dimensions: 34 (total height), 22 (height to LED), 7.5 (height to M4 hole), 10 (height to mounting hole), 34 (width to mounting hole), 11 (width to end of plug), 55 (width to end of cable), and ~85 (total length). Callouts 1, 2, 4, and 5 are present. The right view is a side view with dimensions: 25 (height), 17 (width to mounting hole), and 22 (total width). Callouts 3 and 4 are present. A legend on the right lists: 1 Green LED, 2 Yellow LED, 3 Mounting kit, 4 Installation space for socket.

Ordering data				
	Switch output	Electrical connection	Part No.	Type
	N/O contact			
	Welding field immune			
	PNP	Plug M12x1, 3-pin	30441	SMTSO-1-PS-S-LED-24

Proximity sensors SMEO-1, block design, magnetic reed

Technical data

Function

e.g. N/O contact, 3-wire, with cable

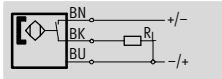

e.g. N/O contact, 3-wire, with plug

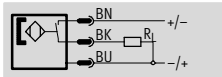

- Magnetic reed measuring principle

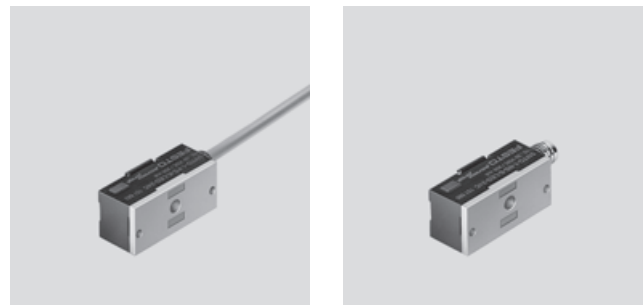

Technical data				
Electrical connection	3-wire		2-wire	
Type	SMEO-1-...-24		SMEO-1-LED-230	SMEO-1-B SMEO-1-S6 heat-resistant
Design	Block design		Block design	
Conforms to	-		EN 60947-5-2	
Certification	C-Tick		C-Tick	
CE mark (see declaration of conformity)	To EU EMC Directive ¹⁾ -		To EU EMC Directive ¹⁾ To EU Low Voltage Directive	
Note on materials	Free of copper and PTFE		Free of copper and PTFE	

1) For information about the applicability of the component see the manufacturer's EC declaration of conformity at: www.festo.com/sp → User documentation.
If the component is subject to restrictions on usage in residential, office or commercial environments or small businesses, further measures to reduce the emitted interference may be necessary.

Input signal/measuring element		
Type	SMEO-1	SMEO-1-S6 heat-resistant
Measuring principle	Magnetic reed	Magnetic reed
Ambient temperature [°C]	-20 ... +70	-50 ... +120

Switching output				
Electrical connection	3-wire		2-wire	
Type	SMEO-1-...-24		SMEO-1-LED-230	SMEO-1-B SMEO-1-S6 heat-resistant
	Contacting, bipolar		Contacting, bipolar	
Switching element function	N/O contact		N/O contact	
Reproducibility of switching point ¹⁾ [mm]	±0.1		±0.1	
Switch-on time [ms]	≤0.5		≤0.5	
Switch-off time [ms]	≤0.03		≤0.03	
Max. switching frequency [Hz]	-		500	500
Max. output current [mA]	1,000		-	1,000
Max. output current DC [mA]	-		120	1,000
Max. output current AC [mA]	-		250	1,000
Max. switching capacity DC [W]	27		40	
Max. switching capacity AC [VA]	-		40	
Voltage drop [V]	-		0 ... 4.5	0
Residual current [mA]	-		0	

1) Only applicable to drives secured against rotation.

Output, additional data	
Protection against short circuit	No
Protection against overloading	No

Proximity sensors SMEO-1, block design, magnetic reed

FESTO

Technical data

Electronic components					
Electrical connection		3-wire		2-wire	
Type		SMEO-1-...-LED-24	SMEO-1-S-24-B	SMEO-1-LED-230	SMEO-1-B SMEO-1-S ₆ heat-resistant
Operating voltage range DC	[V]	12 ... 27	0 ... 30	5 ... 200	0 ... 200
Operating voltage range AC	[V]	–	–	5 ... 250	0 ... 250
Reverse polarity protection		No		No	

Electromechanical components					
Electrical connection		3-wire		2-wire	
Type		SMEO-1-LED-24	SMEO-1-S-...-B	SMEO-1-LED-230	SMEO-1-B SMEO-1-S ₆ heat-resistant
Electrical connection		Cable, 3-wire	Plug M8x1, 3-pin	Cable, 2-wire	
Connection direction		In-line			
Cable length	[m]	2.5	–	2.5	2.5
		5		5	–
Cable sheath materials		TPE-U (PUR)	–	PVC	PVC TPE-S

Mechanical components			
Electrical connection		3-wire	2-wire
Type of mounting		Via accessories	
Tightening torque	[Nm]	–	2.9
Product weight	[g]		
Housing materials		Die-cast zinc	Die-cast zinc
		–	Epoxy resin
			TPE-O
			Steel
			PET
			PC

Display/operation					
Electrical connection		3-wire		2-wire	
Type		SMEO-1-...-LED-24	SMEO-1-S-24-B	SMEO-1-LED-230	SMEO-1-B SMEO-1-S ₆ heat-resistant
Switching status display		Yellow LED	–	Yellow LED	–

Immissions/emissions					
Electrical connection		3-wire		2-wire	
Type		SMEO-1-...-LED-24	SMEO-1-S-24-B	SMEO-1-LED-230	SMEO-1-B SMEO-1-S ₆ heat-resistant
Ambient temperature with flexible cable installation	[°C]	–5 ... +70	–	–5 ... +70	–5 ... +70 –40 ... +120
Protection class		IP67		IP67	
Surge capacity	[kV]	–		4	
Degree of contamination		–		3	

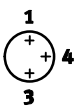
Pin allocation to EN 60947-5-2			
M8x1, 3-pin			
N/O contact			
	Pin	Wire colour	Allocation
	1	Brown	+
	3	Blue	–
	4	Black	Output

Proximity sensors SMEO-1, block design, magnetic reed

Technical data

Dimensions Download CAD data → www.festo.com

SMEO-1 – Cable SMEO-1-S – Plug M8x1

1 Connecting cable
2 Yellow LED

2 Yellow LED
3 Plug to fit connecting cable NEBU-M8
4 Installation space for angled socket

Ordering data							
	Electrical connection		Cable length [m]	Switching status display	Product weight [g]	Part No.	Type
	Cable	Plug M8x1					
	N/O contact						
	Operating voltage range 12 ... 27 V DC						
	3-wire	–	2.5	■	85	30459	SMEO-1-LED-24-B
			5.0	■	130	151672	SMEO-1-LED-24-K5-B
	–	3-pin	–	■	20	150848	SMEO-1-S-LED-24-B
	Operating voltage range 0 ... 30 V DC						
	–	3-pin ¹⁾	–	–	20	150847	SMEO-1-S-24-B
	Operating voltage range 0 ... 250 V AC, 0 ... 200 V DC						
	2-wire	–	2.5	■	100	151671	SMEO-1-LED-230-B
			5.0	■	130	160998	SMEO-1-LED-230-K5-B
			2.5	–	100	30457	SMEO-1-B
	Heat-resistant up to 120 °C						
2-wire	–	2.5	–	100	151673	SMEO-1-S6-C	

1) The proximity sensor has 2 wires internally. One pin of the M8 plug is unused.

Proximity sensors SMPO-1, block design, pneumatic

Technical data

Function
3/2-way valve,
normally closed

- Pneumatic proximity sensor
- Magnetic measuring principle

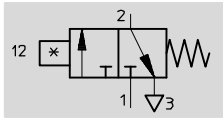

Design	
Constructional design	Block design
Type of mounting	Via accessories
Connection direction	In-line
Reproducibility of switching point ¹⁾	[mm] ±0.1
Switching status display	Optical

1) Only applicable to drives secured against rotation.

Technical data	
Switching element function	3/2-way valve, normally closed
Operating medium	Filtered, unlubricated compressed air
Operating pressure	[bar] 2 ... 6
Switch-on time	[ms] 12
Switch-off time	[ms] 30
Pneumatic connection	Barbed connector for tubing, nominal diameter 3 mm
Protection class	IP65

Operating and environmental conditions	
Ambient temperature	[°C] -15 ... +60
Corrosion resistance class CRC ¹⁾	1

1) Corrosion resistance class 1 according to Festo standard 940 070
Components requiring low corrosion resistance. Transport and storage protection. Parts that do not have primarily decorative surface requirements, e.g. in internal areas that are not visible or behind covers.

Materials	
Housing	Polyamide
Barbed connector	Brass
Note on materials	Free of copper and PTFE

Product weights [g]	
PNP	14

Proximity sensors SMPO-1, block design, pneumatic

Technical data

Dimensions

Download CAD data → www.festo.com

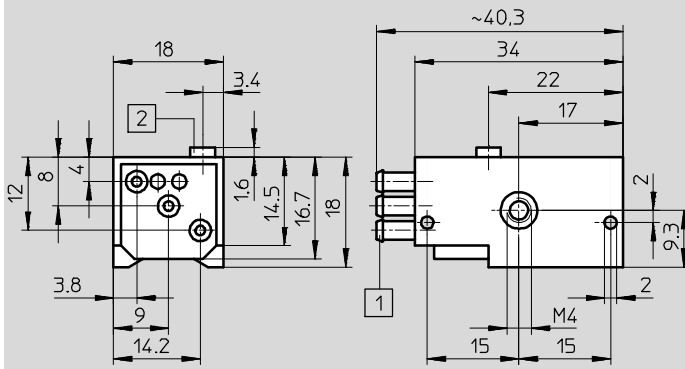

- 1 Barbed connector for tubing, nominal diameter 3 mm
- 2 Visual indicator

Ordering data

	Pneumatic connection	Part No.	Type
	3/2-way valve, normally closed	31008	SMPO-1-H-B
	Barbed connector for 3 mm I.D. tubing		

Proximity sensors SMT-C1, block design, magneto-inductive

Technical data

Function
PNP, N/O contact, with cable

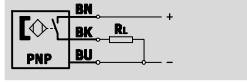

Function
PNP, N/O contact, with plug

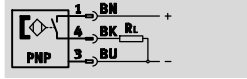

- Magneto-inductive measuring principle
- For standard cylinders DSBF-C or CDN-...-R with sensor strip



Technical data	
Design	Block design
Based on standard	EN 60947-5-2
Certification	RCM trademark
CE mark (see declaration of conformity)	To EU EMC Directive ¹⁾
Note on materials	Cable free of halogen Free of copper and PTFE

1) For information about the applicability of the component see the manufacturer's EC declaration of conformity at: www.festo.com/sp → User documentation.
If the component is subject to restrictions on usage in residential, office or commercial environments or small businesses, further measures to reduce the emitted interference may be necessary.

Input signal/measuring element	
Measuring principle	Magneto-inductive
Ambient temperature	[°C] -20 ... +70

Switching output	
Switching output	PNP
Switching element function	N/O contact
Switch-on time	[ms] 0 ... 0.5
Switch-off time	[ms] 0 ... 0.5
Max. output current	[mA] 200
Max. switching capacity DC	[W] 6
Voltage drop	[V] 0 ... 1.8

Output, additional data	
Protection against short circuit	Pulsed
Protection against overloading	Yes

Proximity sensors SMT-C1, block design, magneto-inductive

Technical data

Electronic components		
Operating voltage range DC	[V]	10 ... 30
Residual ripple	[%]	10
Reverse polarity protection		For all electrical connections

Electromechanical components			
Type	SMT-C1-...-OE	SMT-C1-...-M8D	SMT-C1-...-M12
Electrical connection	Cable, 3-wire	Cable with plug M8x1, 3-pin, rotatable thread	Cable with plug M12x1, 3-pin
Connection direction	In-line		
Cable length	[m]	–	0.3
		5	–
		10	–
Cable sheath materials	TPE-O		
Wire ends	Wire end sleeve		

Mechanical components	
Type of mounting	Clamped
Tightening torque	[Nm] 1.2
Mounting position	Any
Housing materials	High-alloy stainless steel
	Wrought aluminium alloy
	Nickel-plated brass
	PP
	TPE-O
	TPE-U(PU)

Display/operation	
Switching status display	Yellow LED

Immissions/emissions	
Ambient temperature with flexible cable installation	[°C] –20 ... +70
Protection class	To IEC 60529
	IP65
	IP68

Proximity sensors SMT-C1, block design, magneto-inductive

Technical data

Pin allocation to EN 60947-5-2				M12x1, 3-pin			
M8x1, 3-pin				N/O contact			
	Pin	Wire colour	Allocation		Pin	Wire colour	Allocation
	1	Brown	+		1	Brown	+
	3	Blue	-		3	Blue	-
	4	Black	Output		4	Black	Output

Dimensions Download CAD data → www.festo.com

- 1 Example: Plug M8
- 2 Yellow LED
- 3 Theoretical switching point
- 4 Mounting rail on the drive

	B1	B2	B3	D1	H1	H2	H3	H4	H5	L1	L2	L3	L4	L5	L6	L7	≅
SMT-C1	16	3.5	8.8	3	17	9.2	4	4	3.8	34	26	14.5	13	10	3.5	3	5.5

Ordering data								
	Switching output	Electrical connection			Cable length [m]	Weight [g]	Part No.	Type
		Cable	Cable with plug					
				M8x1, rotatable thread	M12x1			
	N/O contact							
	PNP	3-wire	-	-	5	65.9	571339	SMT-C1-PS-24V-K-5,0-OE
					10	114.5	571340	SMT-C1-PS-24V-K-10,0-OE
		-	3-pin	-	0.3	24.4	571342	SMT-C1-PS-24V-K-0,3-M8D
	-	-	3-pin	0.3	32.6	571341	SMT-C1-PS-24V-K-0,3-M12	

Proximity sensors, block design

Accessories

Mounting kit SMB-1

Material:
Die-cast zinc

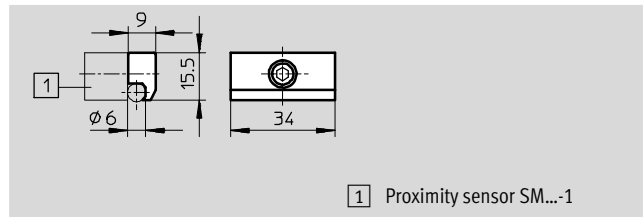

1 Proximity sensor SM...-1

Dimensions and ordering data		Part No.	Type
For piston \varnothing			
32 ... 100		11886	SMB-1

Mounting kit SMB-2-B/SMB-3-B

Material:
Die-cast aluminium

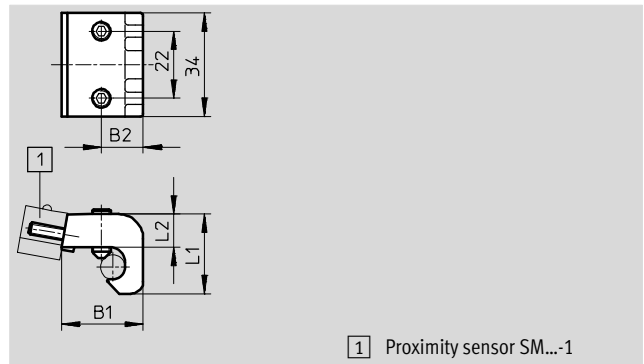

1 Proximity sensor SM...-1

Dimensions and ordering data						
For piston \varnothing	B1	B2	L1	L2	Part No.	Type
32 ... 50	18	11	23	11.6	36162	SMB-2-B
63 ... 100	26.8	13.7	26	10.8	36163	SMB-3-B

Mounting kit SMBU

Material:
Die-cast aluminium

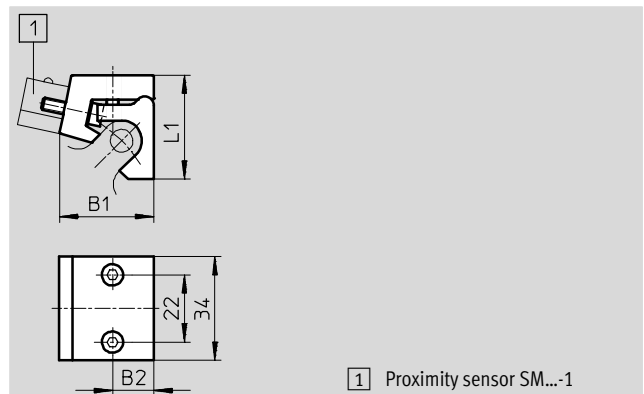

1 Proximity sensor SM...-1

Dimensions and ordering data					
For piston \varnothing	B1	B2	L1	Part No.	Type
32 ... 50	19	8.5	30	36173	SMBU-1-B¹⁾
63 ... 100	31	13.5	34	36174	SMBU-2-B¹⁾
125	31	13.5	37	152828	SMBU-3-B

1) Free of copper and PTFE

Proximity sensors, block design

Accessories



Mounting kit SMBU-1-H-32

Material:
Aluminium

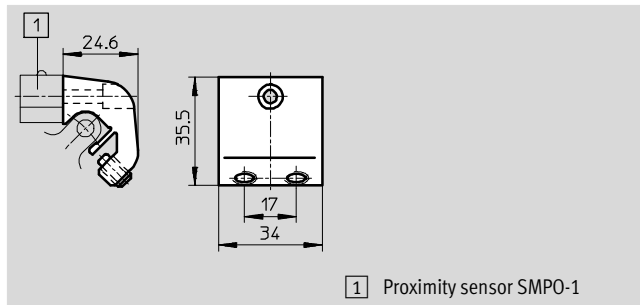

1 Proximity sensor SMPO-1

Dimensions and ordering data		
For piston Ø	Part No.	Type
32	150216	SMBU-1-H-32

Mounting kit SMBS

Material:
Brass, plastic

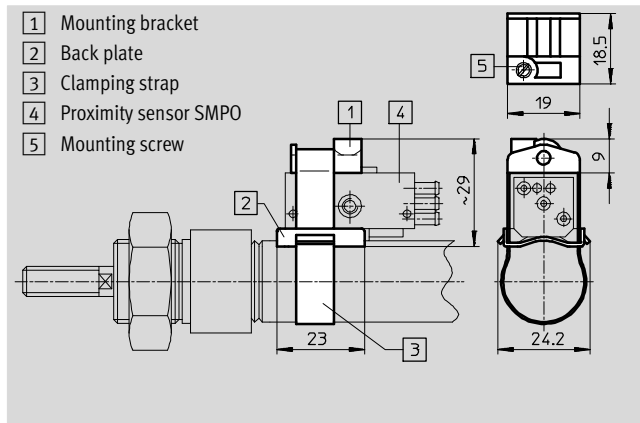

Dimensions and ordering data		
For piston Ø	Part No.	Type
8 ... 25	151225	SMBS-1
32 ... 100	151226	SMBS-2

Mounting kit SMBT-1

Material:
Die-cast zinc

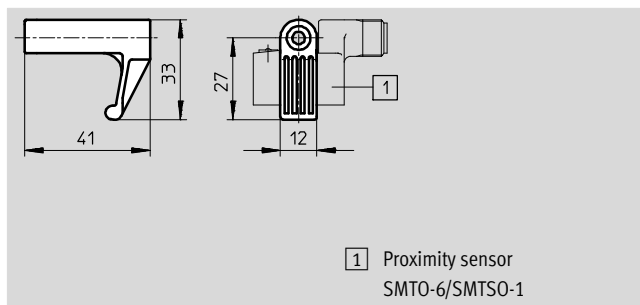





1 Proximity sensor SMT0-6/SMTSO-1

Dimensions and ordering data		
For piston Ø	Part No.	Type
32 ... 200	150002	SMBT-1

Proximity sensors, block design

Accessories

Ordering data – Connecting cables			Technical data → Internet: nebu		
		Number of wires	Cable length [m]	Part No.	Type
Socket M8x1, 3-pin					
	For SMT-C1 and SMT0/SME0-1	3	2.5	541333	NEBU-M8G3-K-2.5-LE3
			5	541334	NEBU-M8G3-K-5-LE3
	For SMT-C1 and SMT0/SME0-1	3	2.5	541338	NEBU-M8W3-K-2.5-LE3
			5	541341	NEBU-M8W3-K-5-LE3
Socket M12x1, 5-pin					
	For SMT-C1 and SMT0-6 SMTSO-1	3	2.5	541363	NEBU-M12G5-K-2.5-LE3
			5	541364	NEBU-M12G5-K-5-LE3
	For SMT-C1 and SMT0-6 SMTSO-1	3	2.5	541367	NEBU-M12W5-K-2.5-LE3
			5	541370	NEBU-M12W5-K-5-LE3

Product Range and Company Overview

A Complete Suite and Company Overview

Our experienced engineers provide complete support at every stage of your development process, including: conceptualization, analysis, engineering, design, assembly, documentation, validation, and production.



Custom Automation Components
Complete custom engineered solutions



Custom Control Cabinets
Comprehensive engineering support and on-site services



Complete Systems
Shipment, stocking and storage services

The Broadest Range of Automation Components

With a comprehensive line of more than 30,000 automation components, Festo is capable of solving the most complex automation requirements.



Electromechanical
Electromechanical actuators, motors, controllers & drivers



Pneumatics
Pneumatic linear and rotary actuators, valves, and air supply



PLCs and I/O Devices
PLC's, operator interfaces, sensors and I/O devices

Supporting Advanced Automation... As No One Else Can!

Festo is a leading global manufacturer of pneumatic and electromechanical systems, components and controls for industrial automation, with more than 16,000 employees in 60 national headquarters serving more than 180 countries. For more than 80 years, Festo has continuously elevated the state of manufacturing with innovations and optimized motion control solutions that deliver higher performing, more profitable automated manufacturing and processing equipment. Our dedication to the advancement of automation extends beyond technology to the education and development of current and future automation and robotics designers with simulation tools, teaching programs, and on-site services.

Quality Assurance, ISO 9001 and ISO 14001 Certifications

Festo Corporation is committed to supply all Festo products and services that will meet or exceed our customers' requirements in product quality, delivery, customer service and satisfaction.

To meet this commitment, we strive to ensure a consistent, integrated, and systematic approach to management that will meet or exceed the requirements of the ISO 9001 standard for Quality Management and the ISO 14001 standard for Environmental Management.

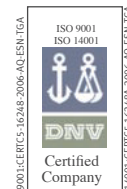

© Copyright 2013, Festo Corporation. While every effort is made to ensure that all dimensions and specifications are correct, Festo cannot guarantee that publications are completely free of any error, in particular typing or printing errors. Accordingly, Festo cannot be held responsible for the same. For Liability and Warranty conditions, refer to our "Terms and Conditions of Sale", available from your local Festo office. All rights reserved. No part of this publication may be reproduced, distributed, or transmitted in any form or by any means, electronic, mechanical, photocopying or otherwise, without the prior written permission of Festo. All technical data subject to change according to technical update.



Printed on recycled paper at New Horizon Graphic, Inc., FSC certified as an environmental friendly printing plant.

Festo North America

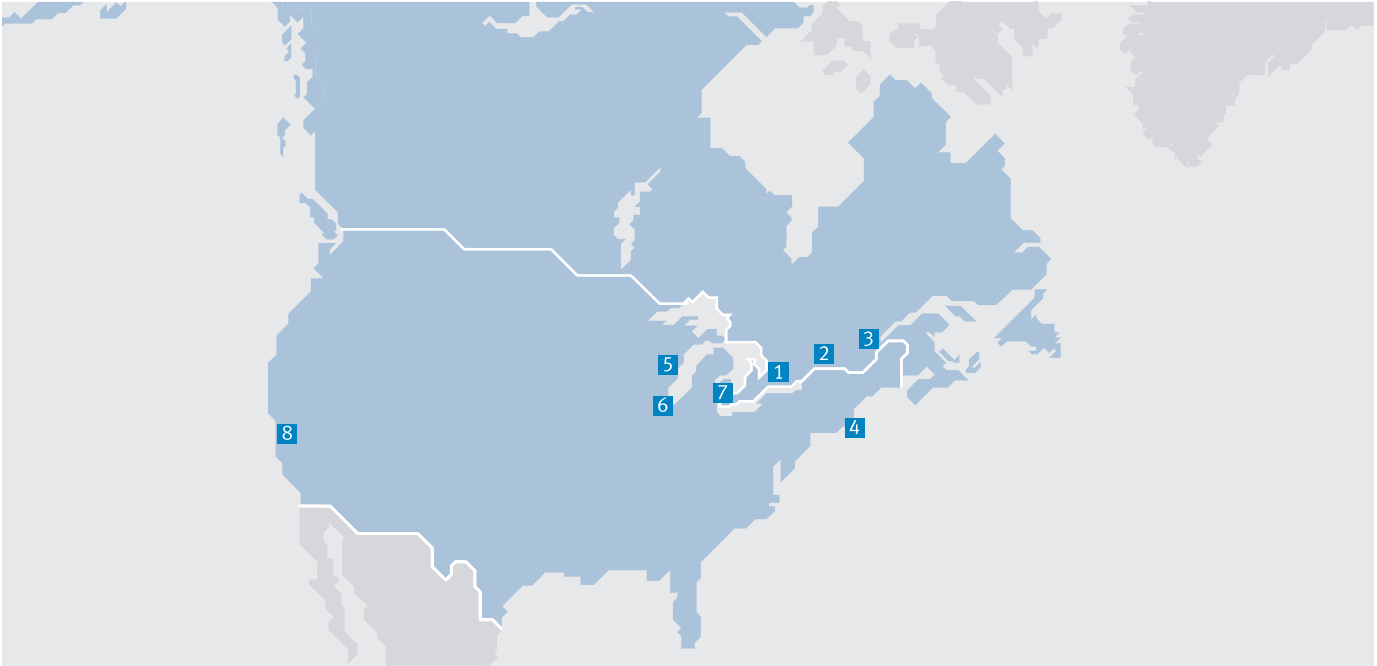

**1 Festo Canada
Headquarters
Festo Inc.**
5300 Explorer Drive
Mississauga, ON
L4W 5G4

2 Montréal
5600, Trans-Canada
Pointe-Claire, QC
H9R 1B6

3 Québec City
2930, rue Watt#117
Québec, QC
G1X 4G3



**4 Festo United States
Headquarters
Festo Corporation**
395 Moreland Road
Hauppauge, NY
11788

5 Appleton
North 922 Tower View Drive, Suite N
Greenville, WI
54942

7 Detroit
1441 West Long Lake Road
Troy, MI
48098

6 Chicago
85 W Algonquin - Suite 340
Arlington Heights, IL
60005

8 Silicon Valley
4935 Southfront Road, Suite F
Livermore, CA
94550

Festo Regional Contact Center

Canadian Customers

Commercial Support:
Tel: 1 877 GO FESTO (1 877 463 3786)
Fax: 1 877 FX FESTO (1 877 393 3786)
Email: festo.canada@ca.festo.com

Technical Support:
Tel: 1 866 GO FESTO (1 866 463 3786)
Fax: 1 877 FX FESTO (1 877 393 3786)
Email: technical.support@ca.festo.com

USA Customers

Commercial Support:
Tel: 1 800 99 FESTO (1 800 993 3786)
Fax: 1 800 96 FESTO (1 800 963 3786)
Email: customer.service@us.festo.com

Technical Support:
Tel: 1 866 GO FESTO (1 866 463 3786)
Fax: 1 800 96 FESTO (1 800 963 3786)
Email: product.support@us.festo.com