

Flow sensors SFE



Flow sensors SFE

Product range overview

FESTO

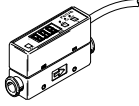
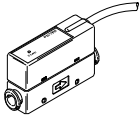
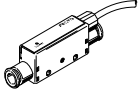
Type	Operating pressure [bar]	Flow measuring range [l/min]	Pneumatic connection	Type of mounting	Electrical output		→ Page/ Internet
					Digital	Analogue	
Flow sensor SFE3, with integrated digital display							
	-0.7 ... +7	0.05 ... 0.5	Push-in fitting 6 mm	Via through-hole, via mounting bracket	2x PNP 2x NPN	1 ... 5 V	5
		0.1 ... 1					
		0.5 ... 5					
		1 ... 10					
		5 ... 50	Female thread G1/8				
Flow sensor SFET-F, unidirectional							
	-0.7 ... +7	0.05 ... 0.5	Push-in fitting 6 mm	Via through-hole, via mounting bracket	2x PNP ¹⁾ 2x NPN ¹⁾	1 ... 5 V	8
		0.1 ... 1					
		0.5 ... 5					
		1 ... 10					
		5 ... 50	Female thread G1/8				
Flow sensor SFET-R, bidirectional							
	-0.9 ... +2	-0.05 ... +0.05	Push-in fitting 4 mm	Via through-hole, via mounting bracket	2x PNP ¹⁾ 2x NPN ¹⁾	1 ... 5 V	10
		-0.1 ... +0.1					
		-0.5 ... +0.5					
		-1 ... +1					
		-5 ... +5					
		-10 ... +10					

1) In combination with flow indicator. Must be ordered separately as an accessory.

Flow sensors SFE

Peripherals overview

FESTO

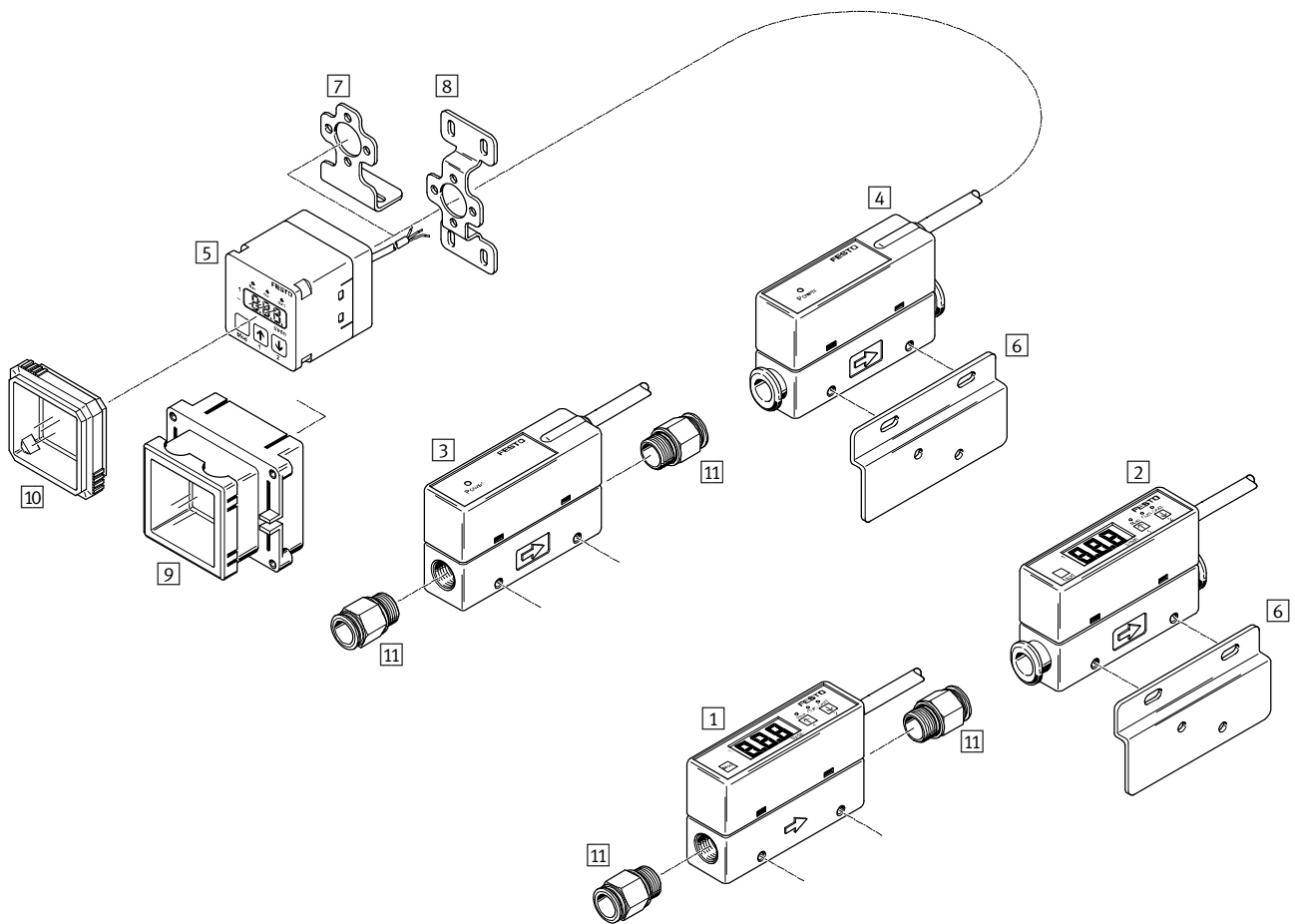

Mounting attachments and accessories		→ Page/Internet
1	Flow sensor SFE3-...-W18 with female thread	5
2	Flow sensor SFE3-...-WQ... with QS push-in fitting	5
3	Flow sensor SFET-...-W18 with female thread	8
4	Flow sensor SFET-...-WQ... with QS push-in fitting	8
5	Flow indicator SFEV for flow sensor SFET	12
6	Mounting bracket SFEZ-BW1	14
7	Mounting bracket SFEV-BW1	14
8	Mounting bracket SFEV-WH1	14
9	Front panel installation kit SFEV-FH1	15
10	Protective cover SFEV-SH1	15
11	Push-in fitting QS-G1/8	15

Flow sensors SFE

Type codes

FESTO

SFE 3 - F 100 - L - W Q6 - 2P B - K1

Type

SFE	Flow sensor
-----	-------------

Design

3	With integrated digital display
T	Flow transmitter

Flow input

F	Unidirectional
R	Bidirectional

Flow measuring range [l/min]

Unidirectional	
005	0.05 ... 0.5
010	0.1 ... 1
050	0.5 ... 5
100	1 ... 10
500	5 ... 50
Bidirectional	
0005	-0.05 ... +0.05
0010	-0.1 ... +0.1
0050	-0.5 ... +0.5
0100	-1 ... +1
0500	-5 ... +5
1000	-10 ... +10

Medium

L	Compressed air
---	----------------

Mounting

W	Wall or surface mounting
---	--------------------------

Pneumatic connection

Q4	Push-in fitting 4 mm
Q6	Push-in fitting 6 mm
18	Female thread G $\frac{1}{8}$

Switching output

2P	2x PNP
2N	2x NPN

Analogue output

B	1 ... 5 V
D	1 ... 5 V

Electrical connection

K1	1 m cable, open end
K3	3 m cable, open end

Flow sensors SFE3, with integrated digital display

Technical data

Function

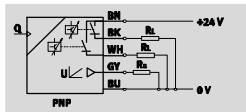

Switching output 2x PNP

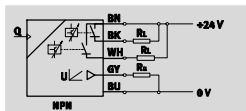

Switching output 2x NPN

- Switching output 2x PNP or 2x NPN
- Analogue output 1 ... 5 V
- 3½-character digital display



Technical data						
Type		SFE3-F005	SFE3-F010	SFE3-F050	SFE3-F100	SFE3-F500
General technical data						
Flow measuring range	[l/min]	0.05 ... 0.5	0.1 ... 1	0.5 ... 5	1 ... 10	5 ... 50
Pneumatic connection		QS-6				Female thread G1/8
Display range	[l/min]	0.05 ... 0.5	0.1 ... 1	0.5 ... 5	1 ... 10	5 ... 50
Type of display		3½-character, alphanumeric				
Mounting position		Vertical, horizontal				
Accuracy FS ¹⁾	[%]	8	5			
Reproducibility, switching value FS	[%]	1				3
Product weight	[g]	70				90
Electrical data						
Switching output		2x PNP 2x NPN				
Analogue output	[V]	1 ... 5				
Switching element function		N/O contact N/C contact				
Switching function		Window comparator Threshold comparator				
Switch-on time	[ms]	50				
Load resistance	[kOhm]	>50				
Operating voltage range DC	[V]	12 ... 24				
Electrical connection		Cable				
Cable length	[m]	1				
Protection class		IP40				

1) % FS = % of the measuring range (full scale)

Operating and environmental conditions		
Operating pressure	[bar]	-0.7 ... +7
Operating medium		Compressed air in accordance with ISO 8573-1:2010 [1:4:2] Nitrogen
Ambient temperature	[°C]	0 ... 50
Temperature of medium	[°C]	0 ... 50
CE mark (see declaration of conformity)		To EU EMC Directive
Certification		C-Tick
Corrosion resistance class CRC ²⁾		2

2) Corrosion resistance class CRC 2 to Festo standard FN 940070
Moderate corrosion stress. Indoor applications in which condensation may occur. External visible parts with primarily decorative requirements for the surface and which are in direct contact with the ambient atmosphere typical for industrial applications.

Flow sensors SFE3, with integrated digital display



Technical data

Materials					
Type	SFE3-F005	SFE3-F010	SFE3-F050	SFE3-F100	SFE3-F500
Housing	PA				PA, aluminium
Cable sheath	PVC				
Note on materials	Contains PWIS (paint-wetting impairment substances)				

Dimensions Download CAD data → www.festo.com

Push-in fitting QS-6

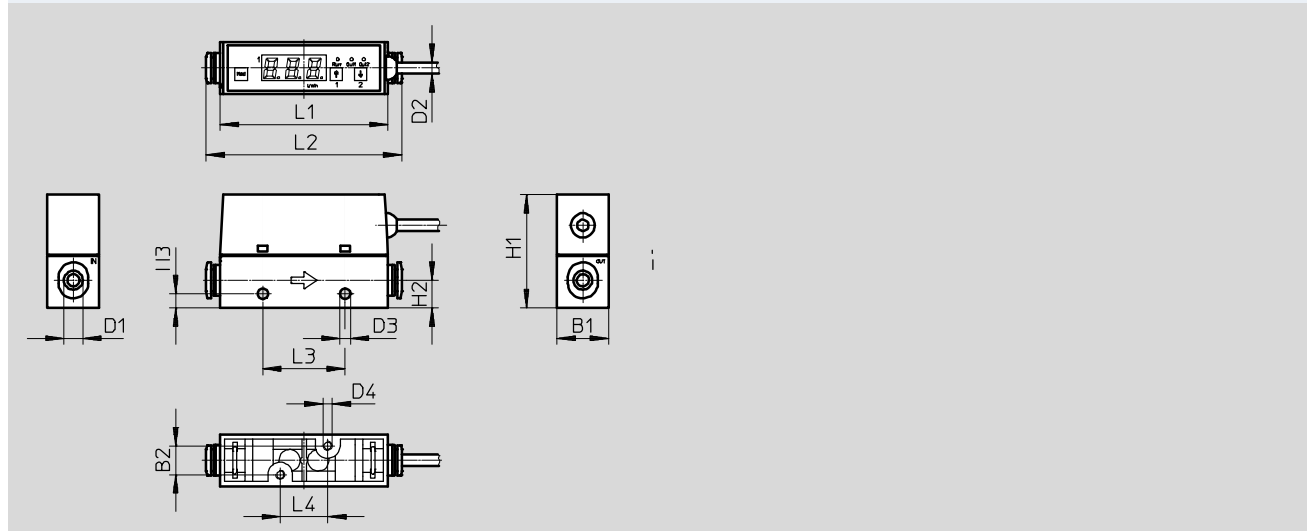

Type	B1	B2	D1	D2	D3	D4	H1	H2	H3	L1	L2	L3	L4
SFE3-F...-L-WQ6-2...B-K1	17	9.5	QS-6	3.7	3.4	M3x5	37	9	4.6	55	64	27	15.5

Flow sensors SFE3, with integrated digital display

Technical data

Dimensions Download CAD data → www.festo.com

Female thread G $\frac{1}{8}$

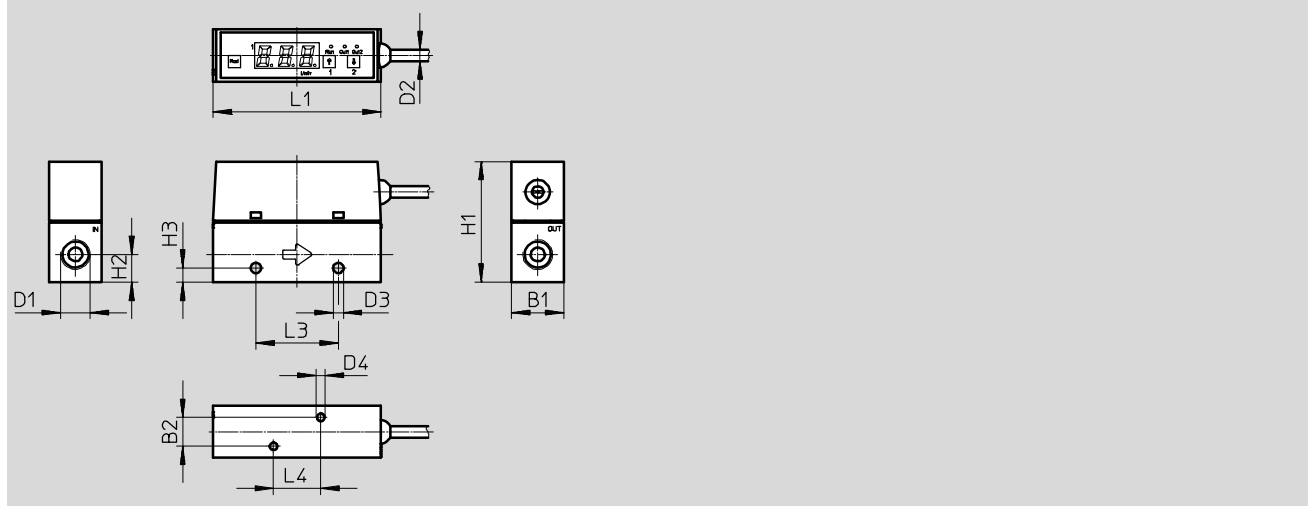

Type	B1	B2	D1	D2	D3	D4	H1	H2	H3	L1	L3	L4
SFE3-F500-L-W18-2...B-K1	17	9.5	G $\frac{1}{8}$	3.7	3.4	M3x5	39.5	9	4.6	55	27	15.5

Ordering data

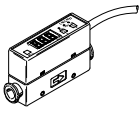
Version	Flow measuring range [l/min]	Switching output			
		2x PNP		2x NPN	
		Part No.	Type	Part No.	Type
	0.05 ... 0.5	538519	SFE3-F005-L-WQ6-2PB-K1	538524	SFE3-F005-L-WQ6-2NB-K1
	0.1 ... 1	538520	SFE3-F010-L-WQ6-2PB-K1	538525	SFE3-F010-L-WQ6-2NB-K1
	0.5 ... 5	538521	SFE3-F050-L-WQ6-2PB-K1	538526	SFE3-F050-L-WQ6-2NB-K1
	1 ... 10	538522	SFE3-F100-L-WQ6-2PB-K1	538527	SFE3-F100-L-WQ6-2NB-K1
	5 ... 50	538523	SFE3-F500-L-W18-2PB-K1	538528	SFE3-F500-L-W18-2NB-K1

Flow sensors SFET, unidirectional

Technical data



Function

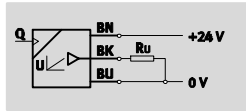

- Analogue output 1 ... 5 V
- Connection of a separate digital display SFEV-F possible



Technical data						
Type	SFET-F005	SFET-F010	SFET-F050	SFET-F100	SFET3-F500	
General technical data						
Flow measuring range	[l/min]	0.05 ... 0.5	0.1 ... 1	0.5 ... 5	1 ... 10	5 ... 50
Pneumatic connection		QS-6				Female thread G1/8
Mounting position		Vertical, horizontal				
Linearity error FS ¹⁾	[%]	8	5			
Reproducibility, switching value FS	[%]	1				3
Product weight	[g]	70				90
Electrical data						
Analogue output	[V]	1 ... 5				
Operating voltage range DC	[V]	12 ... 24				
Switch-on time	[ms]	50				
Load resistance	[kOhm]	50				
Electrical connection		Cable				
Cable length	[m]	1				
Protection class		IP40				

1) % FS = % of the measuring range (full scale)

Operating and environmental conditions	
Operating pressure	[bar] -0.7 ... +7
Operating medium	Compressed air in accordance with ISO 8573-1:2010 [1:4:2] Nitrogen
Ambient temperature	[°C] 0 ... 50
Temperature of medium	[°C] 0 ... 50
CE mark (see declaration of conformity)	To EU EMC Directive
Certification	C-Tick
Corrosion resistance class CRC ²⁾	2

2) Corrosion resistance class CRC 2 to Festo standard FN 940070
Moderate corrosion stress. Indoor applications in which condensation may occur. External visible parts with primarily decorative requirements for the surface and which are in direct contact with the ambient atmosphere typical for industrial applications.

Materials					
Type	SFET-F005	SFET-F010	SFET-F050	SFET-F100	SFET-F500
Housing	PA				PVC, aluminium
Cable sheath	PVC				
Note on materials	Contains PWIS (paint-wetting impairment substances)				

Flow sensors SFET, unidirectional

Technical data

FESTO

Dimensions

Download CAD data → www.festo.com

Push-in fitting QS-6

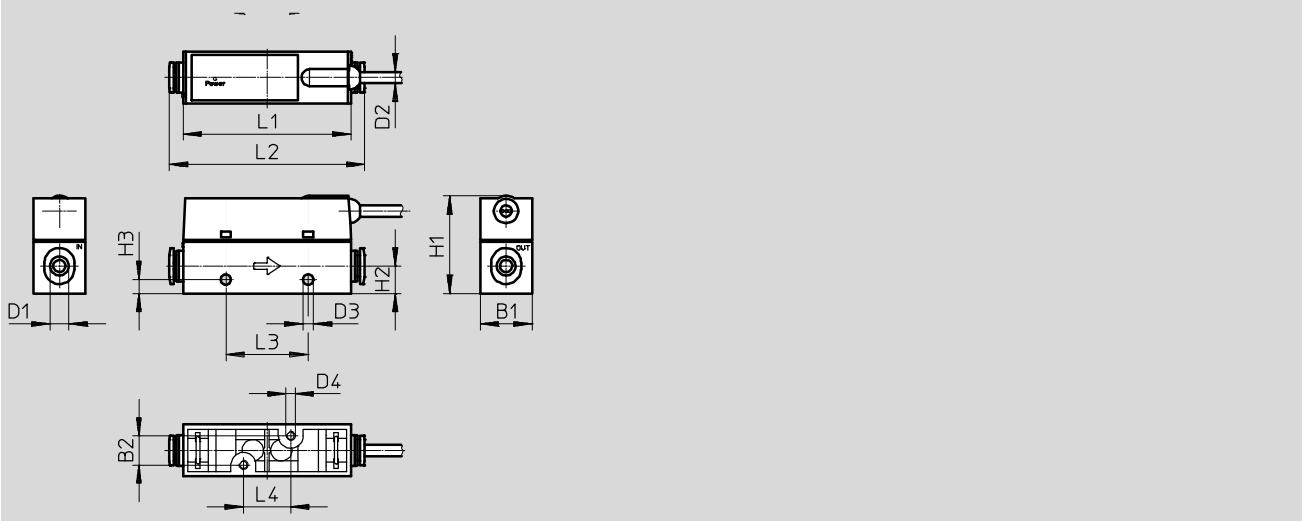

Type	B1	B2	D1	D2 ∅	D3 ∅	D4	H1	H2	H3	L1	L2	L3	L4
SFET-F...-L-WQ6-B-K1	17	9.5	QS6	3.7	3.4	M3x5	32	9	4.6	55	64	27	15.5

Dimensions

Download CAD data → www.festo.com

Female thread G1/8

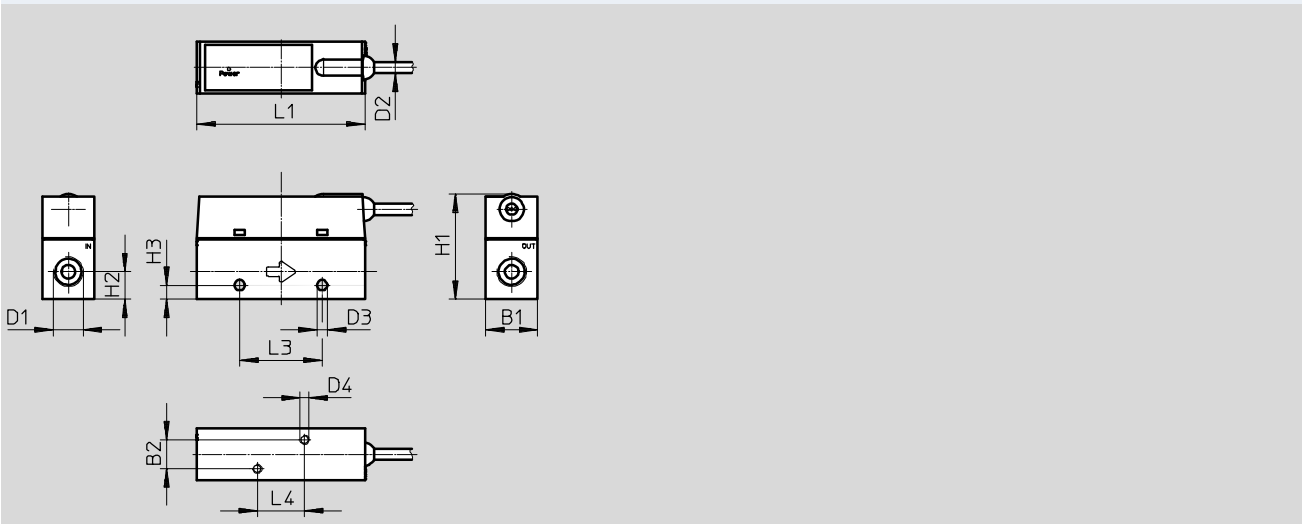

Type	B1	B2	D1	D2 ∅	D3 ∅	D4	H1	H2	H3	L1	L3	L4
SFET-F500-L-W18-B-K1	17	9.5	G1/8	3.7	3.4	M3x5	34.5	9	4.6	55	27	15.5

Ordering data

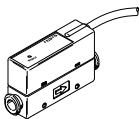
Version	Flow measuring range [l/min]	Part No.	Type
	0.05 ... 0.5	538529	SFET-F005-L-WQ6-B-K1
	0.1 ... 1	538530	SFET-F010-L-WQ6-B-K1
	0.5 ... 5	538531	SFET-F050-L-WQ6-B-K1
	1 ... 10	538532	SFET-F100-L-WQ6-B-K1
	5 ... 50	538533	SFET-F500-L-W18-B-K1

Flow sensors SFET, bidirectional

Technical data

FESTO

Function

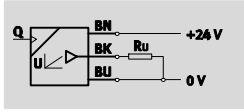

- Suitable for vacuum
- Bidirectional flow
- Analogue output 1 ... 5 V
- Connection of a separate digital display SFEV-R possible



Technical data							
Type	SFET-R0005	SFET-R0010	SFET-R0050	SFET-R0100	SFET-R0500	SFET-R1000	
General technical data							
Flow measuring range	[l/min]	-0.05 ... +0.05	-0.1 ... +0.1	-0.5 ... +0.5	-1 ... +1	-5 ... +5	-10 ... +10
Pneumatic connection		QS-4					
Mounting position		Vertical, horizontal					
Linearity error FS ¹⁾		5					
Reproducibility, switching value FS	[%]	1				2	
Product weight	[g]	25					
Electrical data							
Analogue output	[V]	1 ... 5					
Operating voltage range DC	[V]	12 ... 24					
Switch-on time	[ms]	5					
Load resistance	[kOhm]	>50					
Electrical connection		Cable					
Cable length	[m]	3					
Protection class		IP40					

1) % FS = % of the measuring range (full scale)

Operating and environmental conditions	
Operating pressure	[bar] -0.9 ... +2
Operating medium	Compressed air in accordance with ISO 8573-1:2010 [1:4:2] Nitrogen
Ambient temperature	[°C] 0 ... 50
Temperature of medium	[°C] 0 ... 50
CE mark (see declaration of conformity)	To EU EMC Directive
Certification	C-Tick
Corrosion resistance class CRC ²⁾	2

2) Corrosion resistance class CRC 2 to Festo standard FN 940070

Moderate corrosion stress. Indoor applications in which condensation may occur. External visible parts with primarily decorative requirements for the surface and which are in direct contact with the ambient atmosphere typical for industrial applications.

Materials	
Housing	PA
Cable sheath	PVC
Note on materials	Contains PWIS (paint-wetting impairment substances)

Flow sensors SFET, bidirectional

Technical data

Dimensions

Download CAD data → www.festo.com

Push-in fitting QS-4

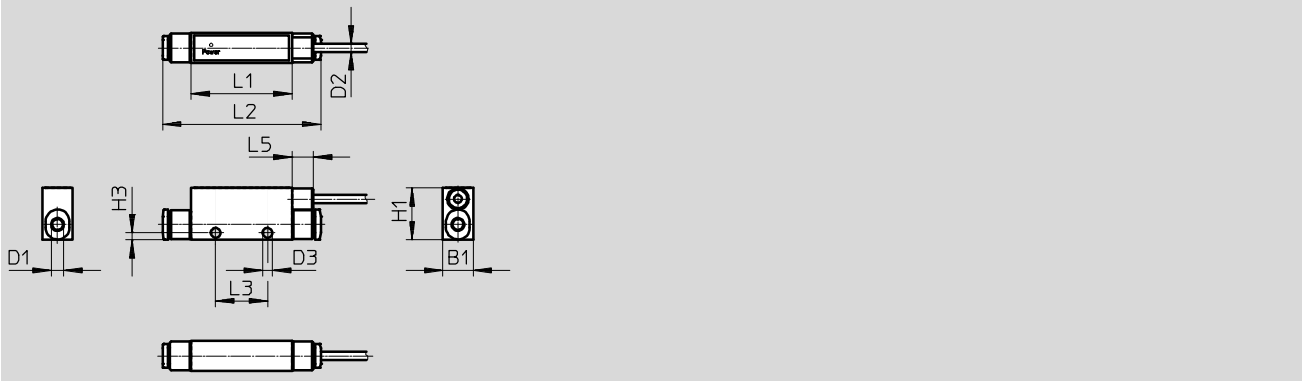

Type	B1	D1	D2 ·∅·	D3 ·∅·	H1	H3	L1	L2	L3	L5
SFET-R...-L-WQ4-D-K3	10	QS4	2.6	3.2	17	2.3	33	51.8	17	7

Ordering data

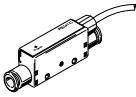
Version	Flow measuring range [l/min]	Part No.	Type
	-0.05 ... +0.05	538534	SFET-R0005-L-WQ4-D-K3
	-0.1 ... +0.1	538535	SFET-R0010-L-WQ4-D-K3
	-0.5 ... +0.5	538536	SFET-R0050-L-WQ4-D-K3
	-1 ... +1	538537	SFET-R0100-L-WQ4-D-K3
	-5 ... +5	538538	SFET-R0500-L-WQ4-D-K3
	-10 ... +10	538539	SFET-R1000-L-WQ4-D-K3

Flow sensors SFE

Accessories

FESTO

Function

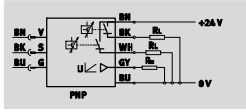

Switching output 2x PNP

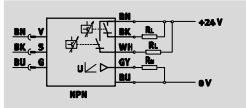

Switching output 2x NPN

Flow indicator SFEV
for flow sensor SFET



Electrical data	
Type of display	3½-character, alphanumeric
Switching output	2x PNP
	2x NPN
Analogue output [V]	1 ... 5
Switching element function	N/C contact, N/O contact
Switching function	Window comparator
	Threshold comparator
Operating voltage range DC [V]	12 ... 24
Electrical connection	Cable
Protection class	IP40

Operating and environmental conditions	
Ambient temperature [°C]	0 ... 50
CE mark (see declaration of conformity)	To EU EMC Directive
Certification	C-Tick

Materials	
Housing	PA
Cable sheath	PVC
Note on materials	Contains PWIS (paint-wetting impairment substances)

Flow sensors SFE

Accessories

FESTO

Dimensions

Download CAD data → www.festo.com

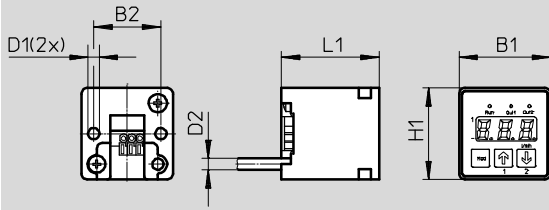

Type	L1	B1	B2	D1 ∅	D2 ∅	H1
SFEV-...-L-2B-K1	32	30	22	2.7	3.7	30

Ordering data

Download CAD data → www.festo.com

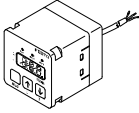
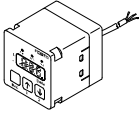
Version	Analogue output [V]	Display range [l/min]	Switching output			
			2x PNP		2x NPN	
			Part No.	Type	Part No.	Type
For flow sensor SFET-F, unidirectional						
	1 ... 5	0.05 ... 0.5	538540	SFEV-F005-L-2PB-K1	538545	SFEV-F005-L-2NB-K1
		0.1 ... 1	538541	SFEV-F010-L-2PB-K1	538546	SFEV-F010-L-2NB-K1
		0.5 ... 5	538542	SFEV-F050-L-2PB-K1	538547	SFEV-F050-L-2NB-K1
		1 ... 10	538543	SFEV-F100-L-2PB-K1	538548	SFEV-F100-L-2NB-K1
		5 ... 50	538544	SFEV-F500-L-2PB-K1	538549	SFEV-F500-L-2NB-K1
For flow sensor SFET-R, bidirectional						
	1 ... 5	-0.05 ... +0.05	538550	SFEV-R0005-L-2PD-K1	538556	SFEV-R0005-L-2ND-K1
		-0.1 ... +0.1	538551	SFEV-R0010-L-2PD-K1	538557	SFEV-R0010-L-2ND-K1
		-0.5 ... +0.5	538552	SFEV-R0050-L-2PD-K1	538558	SFEV-R0050-L-2ND-K1
		-1 ... +1	538553	SFEV-R0100-L-2PD-K1	538559	SFEV-R0100-L-2ND-K1
		-5 ... +5	538554	SFEV-R0500-L-2PD-K1	538560	SFEV-R0500-L-2ND-K1
		-10 ... +10	538555	SFEV-R1000-L-2PD-K1	538561	SFEV-R1000-L-2ND-K1

Flow sensors SFE

Accessories



Mounting bracket SFEZ-BW1

Material:
Nickel-plated steel
Free of copper and PTFE

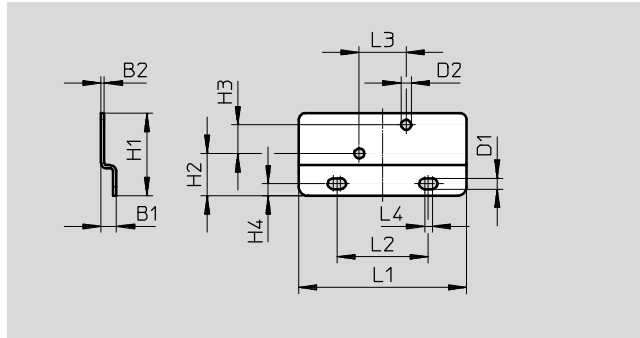

Type	B1	B2	D1 ∅	D2 ∅	H1	H2	H3	H4	L1	L2	L3	L4	Part No.	Type
SFEZ-BW1	5	1	3.5	3.3	27	13.9	9.4	4	55	30	15.4	2.5	538562	SFEZ-BW1

Mounting bracket SFEV-BW1

Material:
Nickel-plated steel
Free of copper and PTFE

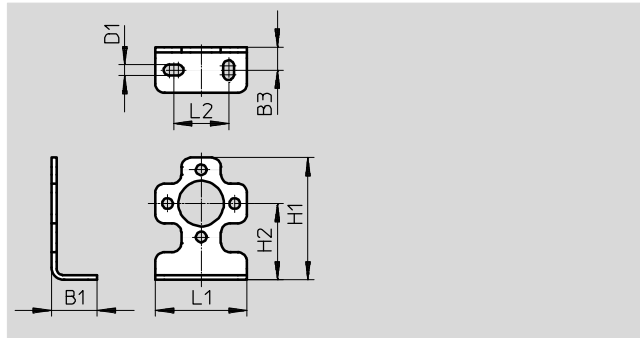

Type	B1	B3	D1 ∅	H1	H2	L1	L2	Part No.	Type
SFEV-BW1	15	7.5	3.6	40	25	30	18	538563	SFEV-BW1

Mounting bracket SFEV-WH1

Material:
Nickel-plated steel
Free of copper and PTFE

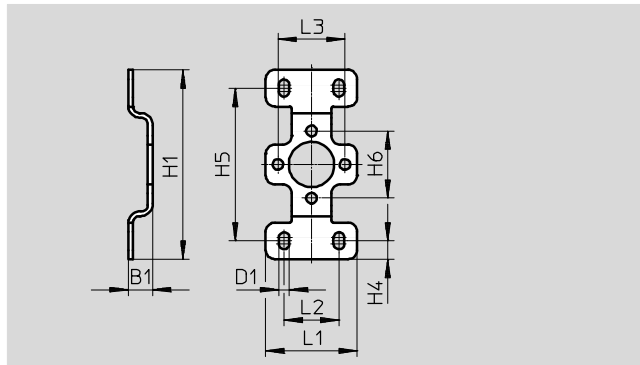

Type	B1	D1 ∅	H1	H4	H5	H6	L1	L2	L3	Part No.	Type
SFEV-WH1	8	3.5	62	6	50	22	30	18	22	538564	SFEV-WH1

Flow sensors SFE

Accessories

Front panel installation kit SFEV-FH1

Material:
Reinforced polyamide
Free of copper and PTFE

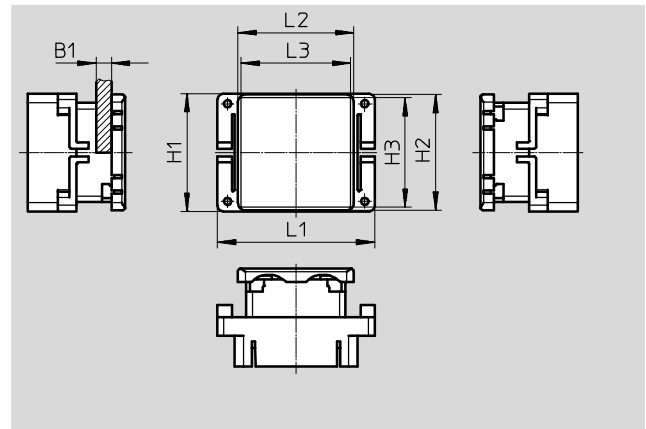

Type	B1	L1	L2	L3	H1	H2	H3	Part No.	Type
SFEV-FH1	0.6 ... 8	51.5	38	36	38.6	38	36	538565	SFEV-FH1

Protective cover SFEV-SH1

Material:
Reinforced polyamide
Free of copper and PTFE

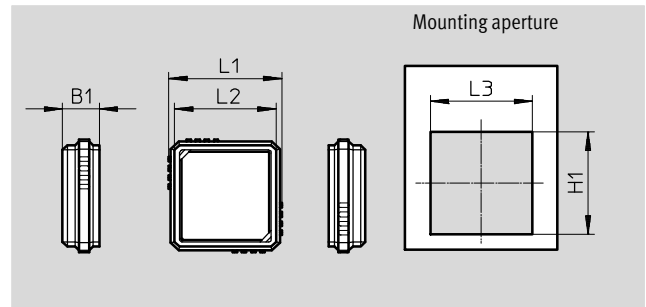
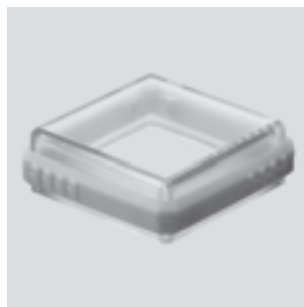

Type	B1	L1	L2	L3 ± 0.3	H1 ± 0.3	Part No.	Type
SFEV-SH1	12	37	33.2	33.5	33.5	538566	SFEV-SH1

Ordering data – Push-in fittings		Technical data → Internet: quick star	
	Threaded connection	Push-in fitting for tubing O.D. [mm]	Part No. Type
	G $\frac{1}{8}$	4	186095 QS-G $\frac{1}{8}$ -4
		6	186096 QS-G $\frac{1}{8}$ -6
		8	186098 QS-G $\frac{1}{8}$ -8

Product Range and Company Overview

A Complete Suite and Company Overview

Our experienced engineers provide complete support at every stage of your development process, including: conceptualization, analysis, engineering, design, assembly, documentation, validation, and production.



Custom Automation Components
Complete custom engineered solutions



Custom Control Cabinets
Comprehensive engineering support and on-site services



Complete Systems
Shipment, stocking and storage services

The Broadest Range of Automation Components

With a comprehensive line of more than 30,000 automation components, Festo is capable of solving the most complex automation requirements.



Electromechanical
Electromechanical actuators, motors, controllers & drivers



Pneumatics
Pneumatic linear and rotary actuators, valves, and air supply



PLCs and I/O Devices
PLC's, operator interfaces, sensors and I/O devices

Supporting Advanced Automation... As No One Else Can!

Festo is a leading global manufacturer of pneumatic and electromechanical systems, components and controls for industrial automation, with more than 16,000 employees in 60 national headquarters serving more than 180 countries. For more than 80 years, Festo has continuously elevated the state of manufacturing with innovations and optimized motion control solutions that deliver higher performing, more profitable automated manufacturing and processing equipment. Our dedication to the advancement of automation extends beyond technology to the education and development of current and future automation and robotics designers with simulation tools, teaching programs, and on-site services.

Quality Assurance, ISO 9001 and ISO 14001 Certifications

Festo Corporation is committed to supply all Festo products and services that will meet or exceed our customers' requirements in product quality, delivery, customer service and satisfaction.

To meet this commitment, we strive to ensure a consistent, integrated, and systematic approach to management that will meet or exceed the requirements of the ISO 9001 standard for Quality Management and the ISO 14001 standard for Environmental Management.



© Copyright 2013, Festo Corporation. While every effort is made to ensure that all dimensions and specifications are correct, Festo cannot guarantee that publications are completely free of any error, in particular typing or printing errors. Accordingly, Festo cannot be held responsible for the same. For Liability and Warranty conditions, refer to our "Terms and Conditions of Sale", available from your local Festo office. All rights reserved. No part of this publication may be reproduced, distributed, or transmitted in any form or by any means, electronic, mechanical, photocopying or otherwise, without the prior written permission of Festo. All technical data subject to change according to technical update.



Printed on recycled paper at New Horizon Graphic, Inc., FSC certified as an environmental friendly printing plant.

Festo North America



**1 Festo Canada
Headquarters
Festo Inc.**
5300 Explorer Drive
Mississauga, ON
L4W 5G4

2 Montréal
5600, Trans-Canada
Pointe-Claire, QC
H9R 1B6

3 Québec City
2930, rue Watt#117
Québec, QC
G1X 4G3



**4 Festo United States
Headquarters
Festo Corporation**
395 Moreland Road
Hauppauge, NY
11788

5 Appleton
North 922 Tower View Drive, Suite N
Greenville, WI
54942

7 Detroit
1441 West Long Lake Road
Troy, MI
48098

6 Chicago
85 W Algonquin - Suite 340
Arlington Heights, IL
60005

8 Silicon Valley
4935 Southfront Road, Suite F
Livermore, CA
94550

Festo Regional Contact Center

Canadian Customers

Commercial Support:
Tel: 1 877 GO FESTO (1 877 463 3786)
Fax: 1 877 FX FESTO (1 877 393 3786)
Email: festo.canada@ca.festo.com

Technical Support:

Tel: 1 866 GO FESTO (1 866 463 3786)
Fax: 1 877 FX FESTO (1 877 393 3786)
Email: technical.support@ca.festo.com

USA Customers

Commercial Support:
Tel: 1 800 99 FESTO (1 800 993 3786)
Fax: 1 800 96 FESTO (1 800 963 3786)
Email: customer.service@us.festo.com

Technical Support:

Tel: 1 866 GO FESTO (1 866 463 3786)
Fax: 1 800 96 FESTO (1 800 963 3786)
Email: product.support@us.festo.com