







Branching modules/Distributor blocks MS-FRM, MS series

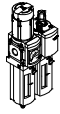
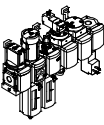

Branching modules/Distributor blocks MS-FRM, MS series

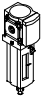

Product range overview – MS series service units

Type	Size	Pneumatic connection in housing	Connecting plate	Pressure regulation range [bar]						Grade of filtration [µm]			
				0.05	0.05	0.1	0.3	0.1	0.5	0.01	1	5	40
Code			AG.../AQ...	0.7	2.5	4	7	12	16	A	B	C	E
Service unit combinations													
MSB-FRC 	4	G1/8, G1/4	G1/8, G1/4, G3/8	-	-	-	■	■	-	-	-	■	■
	6	G1/4, G3/8, G1/2	G1/4, G3/8, G1/2, G3/4	-	-	-	■	■	-	-	-	■	■
	9	-	-	-	-	-	-	-	-	-	-	-	-
	12	-	-	-	-	-	-	-	-	-	-	-	-
Service unit combinations (further variants can be ordered using the configurator → Internet: msb4, msb6 or msb9)													
MSB 	4	G1/4	G1/8, G1/4, G3/8	-	-	-	■	■	-	-	-	■	■
	6	G1/2	G1/4, G3/8, G1/2, G3/4	-	-	-	■	■	-	-	-	■	■
	9	-	-	-	-	-	-	-	-	-	-	-	-
	12	-	-	-	-	-	-	-	-	-	-	-	-
Individual devices													
Filter regulators MS-LFR 	4	G1/8, G1/4	G1/8, G1/4, G3/8	-	-	■	■	■	-	-	-	■	■
	6	G1/4, G3/8, G1/2	G1/4, G3/8, G1/2, G3/4	-	-	■	■	■	■	-	-	■	■
	9	G3/4, G1	G1/2, G3/4, G1, G1 1/4, G1 1/2	-	-	■	■	■	■	-	-	■	■
	12	-	G1, G1 1/4, G1 1/2, G2	-	-	-	■	■	■	-	-	■	■
Filters MS-LF 	4	G1/8, G1/4	G1/8, G1/4, G3/8	-	-	-	-	-	-	-	-	■	■
	6	G1/4, G3/8, G1/2	G1/4, G3/8, G1/2, G3/4	-	-	-	-	-	-	-	-	■	■
	9	G3/4, G1	G1/2, G3/4, G1, G1 1/4, G1 1/2	-	-	-	-	-	-	-	-	■	■
	12	-	G1, G1 1/4, G1 1/2, G2	-	-	-	-	-	-	-	-	■	■
Fine and micro filters MS-LFM 	4	G1/8, G1/4	G1/8, G1/4, G3/8	-	-	-	-	-	-	■	■	-	-
	6	G1/4, G3/8, G1/2	G1/4, G3/8, G1/2, G3/4	-	-	-	-	-	-	■	■	-	-
	9	G3/4, G1	G1/2, G3/4, G1, G1 1/4, G1 1/2	-	-	-	-	-	-	■	■	-	-
	12	-	G1, G1 1/4, G1 1/2, G2	-	-	-	-	-	-	■	■	-	-
Activated carbon filters MS-LFX 	4	G1/8, G1/4	G1/8, G1/4, G3/8	-	-	-	-	-	-	-	-	-	-
	6	G1/4, G3/8, G1/2	G1/4, G3/8, G1/2, G3/4	-	-	-	-	-	-	-	-	-	-
	9	G3/4, G1	G1/2, G3/4, G1, G1 1/4, G1 1/2	-	-	-	-	-	-	-	-	-	-
	12	-	G1, G1 1/4, G1 1/2, G2	-	-	-	-	-	-	-	-	-	-
Water separators MS-LWS 	4	-	-	-	-	-	-	-	-	-	-	-	-
	6	G1/4, G3/8, G1/2	G1/4, G3/8, G1/2, G3/4	-	-	-	-	-	-	-	-	-	-
	9	G3/4, G1	G1/2, G3/4, G1, G1 1/4, G1 1/2	-	-	-	-	-	-	-	-	-	-
	12	-	G1, G1 1/4, G1 1/2, G2	-	-	-	-	-	-	-	-	-	-

Branching modules/Distributor blocks MS-FRM, MS series

Product range overview – MS series service units

Type	Size	Bowl guard		Condensate drains				Pressure indicator					Security		Options		→ Page/ Internet
		Plastic bowl with plastic bowl guard	Metal bowl	Manual rotary	Semi-automatic	Fully automatic	External, fully automatic, electrical	Cover plate (without pressure gauge)	Integrated MS pressure gauge	Adapter plate for EN pressure gauge G1/8	Adapter plate for EN pressure gauge G1/4	Pressure sensor	Rotary knob with detent, lockable via accessories	Rotary knob with integrated lock	Silencer	Flow direction from right to left	
Code		R	U	M	H	V	E...	VS	AG	A8	A4	AD...	AS	E11	S	Z	
Service unit combinations																	
MSB-FRC	4	■	-	■	-	■	-	-	■	-	-	-	■	-	-	■	msb4
	6	■	■	■	-	■	-	-	■	-	-	-	■	-	-	■	msb6
	9	-	-	-	-	-	-	-	-	-	-	-	-	-	-	-	-
	12	-	-	-	-	-	-	-	-	-	-	-	-	-	-	-	-
Service unit combinations																	
MSB	4	■	■	■	-	■	-	-	■	-	-	-	■	-	-	■	msb4
	6	■	■	■	-	■	-	-	■	-	-	-	■	-	-	■	msb6
	9	-	-	-	-	-	-	-	-	-	-	-	-	-	-	-	-
	12	-	-	-	-	-	-	-	-	-	-	-	-	-	-	-	-
Individual devices																	
Filter regulators MS-LFR	4	■	■	■	■	■	-	■	■	■	■	■	■	■	-	■	ms4-lfr
	6	■	■	■	■	■	■	■	■	■	■	■	■	■	-	■	ms6-lfr
	9	-	■	■	■	■	■	■	■	■	■	■	■	■	-	■	ms9-lfr
	12	-	■	■	-	■	■	■	■	■	■	■	■	■	-	■	ms12-lfr
Filters MS-LF	4	■	■	■	■	■	-	-	-	-	-	-	-	-	-	■	ms4-lf
	6	■	■	■	■	■	■	-	-	-	-	-	-	-	-	■	ms6-lf
	9	-	■	■	■	■	■	-	-	-	-	-	-	-	-	■	ms9-lf
	12	-	■	■	-	■	■	-	-	-	-	-	-	-	-	■	ms12-lf
Fine and micro filters MS-LFM	4	■	■	■	■	■	-	-	-	-	-	-	-	-	-	■	ms4-lfm
	6	■	■	■	■	■	■	-	-	-	-	-	-	-	-	■	ms6-lfm
	9	-	■	■	■	■	■	-	-	-	-	-	-	-	-	■	ms9-lfm
	12	-	■	■	-	■	■	-	-	-	-	-	-	-	-	■	ms12-lfm
Activated carbon filters MS-LFX	4	■	■	-	-	-	-	-	-	-	-	-	-	-	-	■	ms4-lfx
	6	■	■	-	-	-	-	-	-	-	-	-	-	-	-	■	ms6-lfx
	9	-	■	-	-	-	-	-	-	-	-	-	-	-	-	■	ms9-lfx
	12	-	■	-	-	-	-	-	-	-	-	-	-	-	-	■	ms12-lfx
Water separators MS-LWS	4	-	-	-	-	-	-	-	-	-	-	-	-	-	-	-	-
	6	-	■	-	-	■	■	-	-	-	-	-	-	-	-	■	ms6-lws
	9	-	■	-	-	■	■	-	-	-	-	-	-	-	-	■	ms9-lws
	12	-	■	-	-	■	■	-	-	-	-	-	-	-	-	■	ms12-lws

Branching modules/Distributor blocks MS-FRM, MS series



Product range overview – MS series service units

Type	Size	Pneumatic connection in housing	Connecting plate	Pressure regulation range [bar]								Supply voltage			
				0.05	0.05	0.1	0.3	0.1	0.5	24 V DC, connection pattern to EN 175301	24 V DC, connection M12 to IEC 61076-2-101	110 V AC, connection pattern to EN 175301	230 V AC, connection pattern to EN 175301		
Code			AG.../AQ...	D2	D4	D5	D6	D7	D8	V24	V24P	V110	V230		
Individual devices															
Pressure regulators MS-LR		4	G1/8, G1/4	G1/8, G1/4, G3/8	-	-	■	■	■	-	-	-	-		
		6	G1/4, G3/8, G1/2	G1/4, G3/8, G1/2, G3/4	-	-	■	■	■	■	-	-	-		
		9	G3/4, G1	G1/2, G3/4, G1, G1 1/4, G1 1/2	-	-	■	■	■	■	-	-	-		
		12	-	G1, G1 1/4, G1 1/2, G2	-	-	-	■	■	■	-	-	-		
Pressure regulators MS-LRB		4	G1/4	G1/8, G1/4, G3/8	-	-	■	■	■	-	-	-	-		
		6	G1/2	G1/4, G3/8, G1/2, G3/4	-	-	■	■	■	■	-	-	-		
		9	-	-	-	-	-	-	-	-	-	-	-		
		12	-	-	-	-	-	-	-	-	-	-	-		
Precision pressure regulators MS-LRP		4	-	-	■	■	■	-	■	-	-	-	-		
		6	G1/4, G3/8, G1/2	G1/4, G3/8, G1/2, G3/4	■	■	■	-	■	-	-	-	-		
		9	-	-	-	-	-	-	-	-	-	-	-		
		12	-	-	-	-	-	-	-	-	-	-	-		
Precision pressure regulators MS-LRPB		4	-	-	■	■	■	-	■	-	-	-	-		
		6	G1/2	G1/4, G3/8, G1/2, G3/4	■	■	■	-	■	-	-	-	-		
		9	-	-	-	-	-	-	-	-	-	-	-		
		12	-	-	-	-	-	-	-	-	-	-	-		
Electrical pressure regulators MS-LRE		4	-	-	-	-	-	-	-	-	-	-	-		
		6	G1/4, G3/8, G1/2	G1/4, G3/8, G1/2, G3/4	-	-	■	■	■	■	-	-	-		
		9	-	-	-	-	-	-	-	-	-	-	-		
		12	-	-	-	-	-	-	-	-	-	-	-		
Lubricators MS-LOE		4	G1/8, G1/4	G1/8, G1/4, G3/8	-	-	-	-	-	-	-	-	-		
		6	G1/4, G3/8, G1/2	G1/4, G3/8, G1/2, G3/4	-	-	-	-	-	-	-	-	-		
		9	G3/4, G1	G1/2, G3/4, G1, G1 1/4, G1 1/2	-	-	-	-	-	-	-	-	-		
		12	-	G1, G1 1/4, G1 1/2, G2	-	-	-	-	-	-	-	-	-		
On-off valves, manually actuated MS-EM(1)		4	G1/8, G1/4	G1/8, G1/4, G3/8	-	-	-	-	-	-	-	-	-		
		6	G1/4, G3/8, G1/2	G1/4, G3/8, G1/2, G3/4	-	-	-	-	-	-	-	-	-		
		9	G3/4, G1	G1/2, G3/4, G1, G1 1/4, G1 1/2	-	-	-	-	-	-	-	-	-		
		12	-	G1, G1 1/4, G1 1/2, G2	-	-	-	-	-	-	-	-	-		
On-off valves, electrically actuated MS-EE		4	G1/8, G1/4	G1/8, G1/4, G3/8	-	-	-	-	-	■	-	■	■		
		6	G1/4, G3/8, G1/2	G1/4, G3/8, G1/2, G3/4	-	-	-	-	-	■	-	■	■		
		9	G3/4, G1	G1/2, G3/4, G1, G1 1/4, G1 1/2	-	-	-	-	-	■	■	■	■		
		12	-	G1, G1 1/4, G1 1/2, G2	-	-	-	-	-	■	■	■	■		
Soft-start valves, pneumatically actuated MS-DL		4	G1/8, G1/4	G1/8, G1/4, G3/8	-	-	-	-	-	-	-	-	-		
		6	G1/4, G3/8, G1/2	G1/4, G3/8, G1/2, G3/4	-	-	-	-	-	-	-	-	-		
		9	-	-	-	-	-	-	-	-	-	-	-		
		12	-	G1, G1 1/4, G1 1/2, G2	-	-	-	-	-	-	-	-	-		
Soft-start valves, electrically actuated MS-DE		4	G1/8, G1/4	G1/8, G1/4, G3/8	-	-	-	-	-	■	-	■	■		
		6	G1/4, G3/8, G1/2	G1/4, G3/8, G1/2, G3/4	-	-	-	-	-	■	-	■	■		
		9	-	-	-	-	-	-	-	-	-	-	-		
		12	-	G1, G1 1/4, G1 1/2, G2	-	-	-	-	-	■	■	■	■		

Branching modules/Distributor blocks MS-FRM, MS series

Product range overview – MS series service units

Type	Size	Bowl guard		Pressure indicator				Security			Options		→ Page/ Internet
		Plastic bowl with plastic bowl guard	Metal bowl	Cover plate (without pressure gauge)	Integrated MS pressure gauge	Adapter plate for EN pressure gauge G1/8	Adapter plate for EN pressure gauge G1/4	Pressure sensor	Rotary knob with detent, lockable via accessories	Rotary knob with integrated lock	Silencer	Flow direction from right to left	
Code		R	U	VS	AG	A8	A4	AD...	AS	E11	S	Z	
Individual devices													
Pressure regulators MS-LR	4	-	-	■	■	■	■	■	■	■	-	■	ms4-lr
	6	-	-	■	■	-	■	■	■	■	-	■	ms6-lr
	9	-	-	■	■	-	■	■	■	■	-	■	ms9-lr
	12	-	-	■	■	-	■	-	■	■	-	■	ms12-lr
Pressure regulators MS-LRB	4	-	-	■	■	■	■	■	■	■	-	■	ms4-lrb
	6	-	-	■	■	-	■	■	■	■	-	■	ms6-lrb
	9	-	-	-	-	-	-	-	-	-	-	-	-
	12	-	-	-	-	-	-	-	-	-	-	-	-
Precision pressure regulators MS-LRP	4	-	-	-	-	-	-	-	-	-	-	-	-
	6	-	-	■	-	■	■	■	■	■	-	■	ms6-lrp
	9	-	-	-	-	-	-	-	-	-	-	-	-
	12	-	-	-	-	-	-	-	-	-	-	-	-
Precision pressure regulators MS-LRPB	4	-	-	-	-	-	-	-	-	-	-	-	-
	6	-	-	■	-	■	■	■	■	■	-	■	ms6-lrpb
	9	-	-	-	-	-	-	-	-	-	-	-	-
	12	-	-	-	-	-	-	-	-	-	-	-	-
Electrical pressure regulators MS-LRE	4	-	-	-	-	-	-	-	-	-	-	-	-
	6	-	-	■	■	-	■	-	-	-	-	■	ms6-lre
	9	-	-	-	-	-	-	-	-	-	-	-	-
	12	-	-	-	-	-	-	-	-	-	-	-	-
Lubricators MS-LOE	4	■	■	-	-	-	-	-	-	-	-	■	ms4-loe
	6	■	■	-	-	-	-	-	-	-	-	■	ms6-loe
	9	-	■	-	-	-	-	-	-	-	-	■	ms9-loe
	12	-	■	-	-	-	-	-	-	-	-	■	ms12-loe
On-off valves, manually actuated MS-EM(1)	4	-	-	■	■	■	■	■	-	-	■	■	ms4-em1
	6	-	-	■	■	-	■	■	-	-	■	■	ms6-em1
	9	-	-	■	■	-	■	-	-	-	■	■	ms9-em
	12	-	-	■	■	-	■	-	-	-	■	■	ms12-em
On-off valves, electrically actuated MS-EE	4	-	-	■	■	■	■	■	-	-	■	■	ms4-ee
	6	-	-	■	■	-	■	■	-	-	■	■	ms6-ee
	9	-	-	■	■	-	■	■	-	-	■	■	ms9-ee
	12	-	-	■	■	-	■	-	-	-	■	■	ms12-ee
Soft-start valves, pneumatically actuated MS-DL	4	-	-	■	■	■	■	■	-	-	-	■	ms4-dl
	6	-	-	■	■	-	■	■	-	-	-	■	ms6-dl
	9	-	-	-	-	-	-	-	-	-	-	-	-
	12	-	-	■	■	-	■	-	-	-	-	■	ms12-dl
Soft-start valves, electrically actuated MS-DE	4	-	-	■	■	■	■	■	-	-	-	■	ms4-de
	6	-	-	■	■	-	■	■	-	-	-	■	ms6-de
	9	-	-	-	-	-	-	-	-	-	-	-	-
	12	-	-	■	■	-	■	-	-	-	-	■	ms12-de

Branching modules/Distributor blocks MS-FRM, MS series



Product range overview – MS series service units

Type	Size	Pneumatic connection in housing	Connecting plate	Performance Level			Supply voltage				
				Category 1, 1-channel	Category 3, 2-channel	Category 4, 2-channel with self-monitoring	24 V DC, connection pattern to EN 175301	24 V DC, connection M12 to IEC 61076-2-101/ to EN 60947-5-2	110 V AC, connection pattern to EN 175301	230 V AC, connection pattern to EN 175301	
Code			AG.../AQ...	C	D	E	V24	V24P	V110	V230	
Individual devices											
Soft start and exhaust valves MS-SV-C		4	–								
		6	G $\frac{1}{2}$	G $\frac{1}{4}$, G $\frac{3}{8}$, G $\frac{1}{2}$, G $\frac{3}{4}$	■	–	–	■	■	■	■
		9	G $\frac{3}{4}$, G1	G $\frac{1}{2}$, G $\frac{3}{4}$, G1, G1 $\frac{1}{4}$, G1 $\frac{1}{2}$	■	–	–	■	■	■	■
		12	–								
Soft start and exhaust valves MS-SV-D		4	–								
		6	G $\frac{1}{2}$	G $\frac{1}{4}$, G $\frac{3}{8}$, G $\frac{1}{2}$, G $\frac{3}{4}$	–	■	–	■	■	–	–
		9	–								
		12	–								
Soft start and exhaust valves MS-SV-E		4	–								
		6	G $\frac{1}{2}$	G $\frac{1}{4}$, G $\frac{3}{8}$, G $\frac{1}{2}$, G $\frac{3}{4}$	–	–	■	■	–	–	–
		9	–								
		12	–								
Membrane air dryers MS-LDM1		4	G $\frac{1}{8}$, G $\frac{1}{4}$	G $\frac{1}{8}$, G $\frac{1}{4}$, G $\frac{3}{8}$	–	–	–	–	–	–	–
		6	G $\frac{1}{4}$, G $\frac{3}{8}$, G $\frac{1}{2}$	G $\frac{1}{4}$, G $\frac{3}{8}$, G $\frac{1}{2}$, G $\frac{3}{4}$	–	–	–	–	–	–	–
		9	–								
		12	–								
Branching modules MS-FRM		4	G $\frac{1}{8}$, G $\frac{1}{4}$	G $\frac{1}{8}$, G $\frac{1}{4}$, G $\frac{3}{8}$	–	–	–	–	–	–	–
		6	G $\frac{1}{4}$, G $\frac{3}{8}$, G $\frac{1}{2}$	G $\frac{1}{4}$, G $\frac{3}{8}$, G $\frac{1}{2}$, G $\frac{3}{4}$	–	–	–	–	–	–	–
		9	G $\frac{3}{4}$, G1	G $\frac{1}{2}$, G $\frac{3}{4}$, G1, G1 $\frac{1}{4}$, G1 $\frac{1}{2}$	–	–	–	–	–	–	–
		12	–	G1, G1 $\frac{1}{4}$, G1 $\frac{1}{2}$, G2	–	–	–	–	–	–	–
Distributor blocks MS-FRM-FRZ		4	–	–	–	–	–	–	–	–	–
		6	–	–	–	–	–	–	–	–	–
		9	–								
		12	–								
Flow sensors SFAM		4	–								
		6	G $\frac{1}{2}$	G $\frac{1}{2}$	–	–	–	–	–	–	–
		9	–	G1, G1 $\frac{1}{2}$	–	–	–	–	–	–	–
		12	–								

Branching modules/Distributor blocks MS-FRM, MS series

Product range overview – MS series service units

Type	Size	Bowl guard		Pressure indicator				Switch output			Options		→ Page/ Internet
		Plastic bowl with plastic bowl guard	Metal bowl	Cover plate (without pressure gauge)	Integrated MS pressure gauge	Adapter plate for EN pressure gauge G1/8	Adapter plate for EN pressure gauge G1/4	Pressure sensor	2x PNP or NPN, 1 analogue output 4 ... 20 mA	2x PNP or NPN, 1 analogue output 0 ... 10 V	Silencer	Flow direction from right to left	
Code		R	U	VS	AG	A8	A4	AD...	2SA	2SV	S	Z/R	
Individual devices													
Soft start and exhaust valves MS-SV-C	4	-											-
	6	-	-	■	■	-	■	■	-	-	■	■	ms6-sv
	9	-	-	■	■	-	■	■	-	-	■	■	ms9-sv
	12	-											-
Soft start and exhaust valves MS-SV-D	4	-											-
	6	-	-	■	■	-	■	■	-	-	■	■	ms6-sv
	9	-											-
	12	-											-
Soft start and exhaust valves MS-SV-E	4	-											-
	6	-	-	■	■	-	■	■	-	-	■	■	ms6-sv
	9	-											-
	12	-											-
Membrane air dryers MS-LDM1	4	-	■	-	-	-	-	-	-	-	-	■	ms4-ldm1
	6	-	■	-	-	-	-	-	-	-	-	■	ms6-ldm1
	9	-											-
	12	-											-
Branching modules MS-FRM	4	-	-	■	■	■	■	■	-	-	-	■	8
	6	-	-	■	■	-	■	■	-	-	-	■	8
	9	-	-	■	■	-	■	■	-	-	-	■	20
	12	-	-	■	-	-	-	-	-	-	-	-	28
Distributor blocks MS-FRM-FRZ	4	-	-	-	-	-	-	-	-	-	-	■	18
	6	-	-	-	-	-	-	-	-	-	-	■	18
	9	-											-
	12	-											-
Flow sensors SFAM	4	-											-
	6	-	-	-	-	-	-	-	■	■	-	■	sfam-62
	9	-	-	-	-	-	-	-	■	■	-	■	sfam-90
	12	-											-

Branching modules MS4/MS6-FRM, MS series

Peripherals overview

Branching module MS4/MS6-FRM

 Note

Additional accessories:

- Module connector for combination with size MS4/MS6 or size MS9 → Internet: amv, rmv, armv
- Adapter plate for mounting on profiles → Internet: ipm-80, ipm-40-80, ipm-80-80

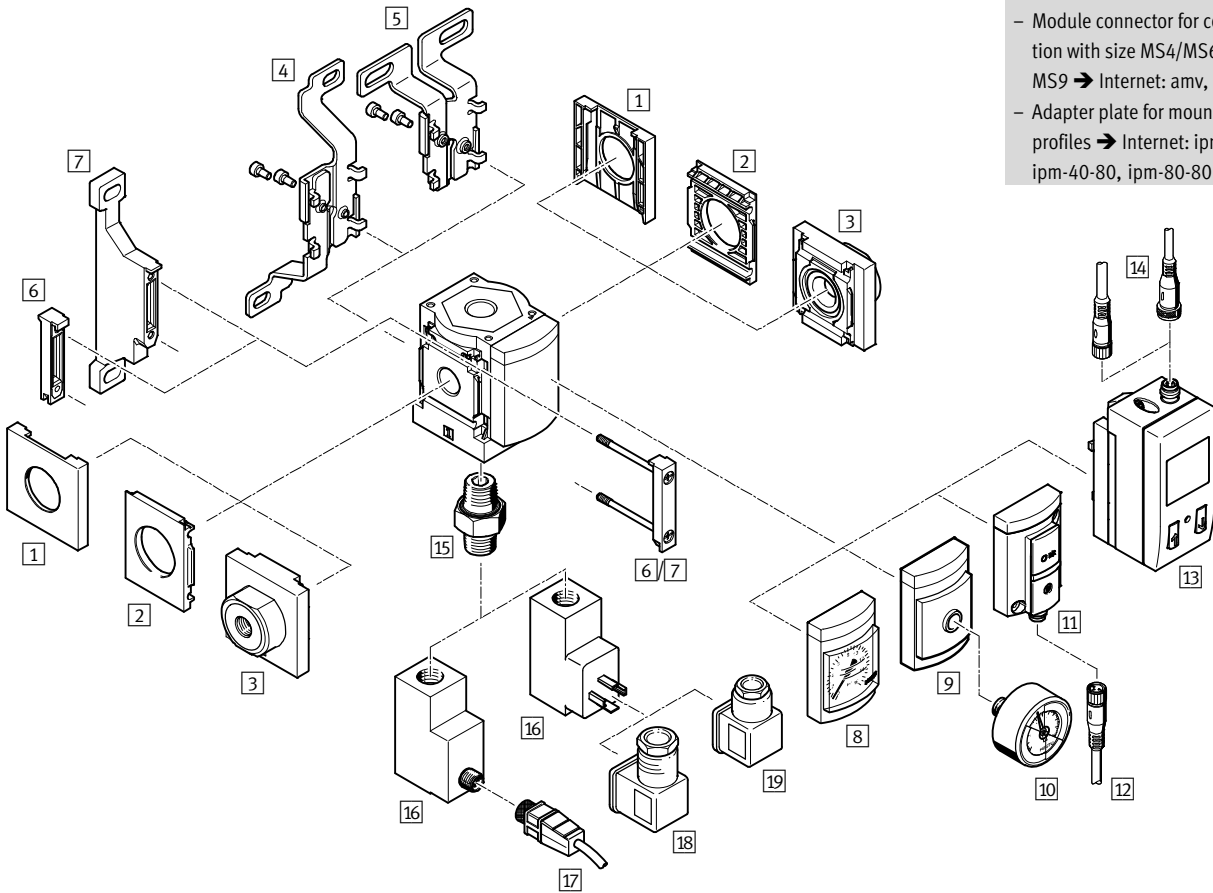

Branching modules MS4/MS6-FRM, MS series

Peripherals overview

Mounting attachments and accessories						
		Individual device		Combination		→ Page/Internet
		Without connecting plate	With connecting plate	Without connecting plate	With connecting plate	
1	Cover cap MS4/6-END	■	-	■	-	ms4-end, ms6-end
2	Mounting plate MS4/6-AEND	■ ¹⁾	-	■ ¹⁾	-	ms4-aend, ms6-aend
3	Connecting plate-SET MS4/6-AG...	-	■ ¹⁾	-	■ ¹⁾	ms4-ag, ms6-ag
4	Mounting bracket MS4/6-WB	■	■	-	-	ms4-wb, ms6-wb
5	Mounting bracket MS4-WBM	■	■	-	-	ms4-wbm
6	Module connector MS4/6-MV	-	■	■	■	ms4-mv, ms6-mv
7	Mounting bracket MS4/6-WP	■	■	■	■	ms4-wp, ms6-wp
	Mounting bracket (not illustrated) MS4/6-WPB/WPE/WPM	■	■	■	■	ms4-wp, ms6-wp
8	MS pressure gauge AG	■	■	■	■	16
9	Adapter plate for EN pressure gauge 1/8/1/4 A8/A4	■	■	■	■	16
10	Pressure gauge MA	■	■	■	■	33
11	Pressure sensor without display AD7 ... AD10	■	■	■	■	16
12	Connecting cable NEBU-M8...-LE3	■	■	■	■	33
13	Pressure sensor with display AD1 ... AD4	■	■	■	■	16
14	Connecting cable NEBU-M8...-LE3/NEBU-M12...-LE4	■	■	■	■	33
15	Double nipple ESK	■	■	■	■	34
16	Pressure switch PEV X/Y/M12	■	■	■	■	16
17	Connecting cable NEBU-M12...-LE4	■	■	■	■	33
18	Angled socket PEV-1/4-WD-LED...	■	■	■	■	34
19	Plug socket MSSD-C-4P	■	■	■	■	34

1) Module connector MS4/6-MV [6] or mounting bracket MS4/6-WP/WPB/WPE/WPM [7] is required for mounting.

Branching modules MS4/MS6-FRM, MS series

FESTO

Type codes

		MS	4	-	FRM	-	1/4	-	Y
Series									
MS	Standard service unit								
Size									
4	Grid dimension 40 mm								
6	Grid dimension 62 mm								
Service function									
FRM	Branching module								
Pneumatic connection									
MS4									
1/8	Female thread G1/8								
1/4	Female thread G1/4								
MS6									
1/4	Female thread G1/4								
3/8	Female thread G3/8								
1/2	Female thread G1/2								
Non-return function/pressure switch									
	Standard								
I	With integrated non-return function								
Y	With pressure switch								

Further variants can be ordered using the modular system → 16

- Connecting plates
- Pressure gauge/pressure gauge alternatives
- Alternative pressure gauge scale
- Pressure switch
- Type of mounting
- EU certification
- UL certification
- Flow direction

Branching modules MS4/MS6-FRM, MS series

Technical data

Function
Standard

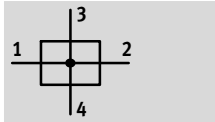

With integrated non-return function

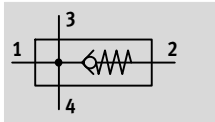

- - Flow rate
1,200 ... 14,700 l/min

- - Temperature range
-10 ... +60 °C

- - Operating pressure
0 ... 20 bar



- Pneumatic manifold with 4 connections
- Can be used as an intermediate distributor for varying air qualities
- Attachment facility for auxiliary modules
- Outlet top and bottom
- An integrated non-return valve prevents the return flow e.g. of lubricated compressed air
- Optional pressure sensor
- Optional device variant EX4 for use in potentially explosive areas in zones 1, 2, 21 and 22

General technical data		
Size	MS4	MS6
Pneumatic connection 1, 2	Female thread	G ¹ / ₈ or G ¹ / ₄
	Connecting plate AG...	G ¹ / ₈ , G ¹ / ₄ or G ³ / ₈
Pneumatic connection 3, 4	G ¹ / ₄	G ¹ / ₂
Design	Branching module	
	Branching module with non-return function	
Type of mounting	Via accessories	
	In-line installation	
Assembly position	Any ¹⁾	
Pressure display	Via pressure sensor for displaying output pressure via LCD display and electrical output	
	Via pressure sensor for displaying output pressure via operational status indicator and electrical output	
	Via pressure gauge for displaying output pressure	
	Via pressure gauge with red/green scale for displaying output pressure	
	G ¹ / ₄ prepared	
	G ¹ / ₈ prepared	-

1) The branching module must be mounted vertically when combined with a pressure sensor as condensate must not collect in the pressure sensor.
 - - Note: This product conforms to ISO 1179-1 and to ISO 228-1

Standard nominal flow rate q _N ¹⁾ [l/min]					
Size	MS4		MS6		
	G ¹ / ₈	G ¹ / ₄	G ¹ / ₄	G ³ / ₈	G ¹ / ₂
Standard					
In main flow direction 1 → 2	1,800	4,600	4,200	9,200	14,700
Outlet at top	1,600	1,500	6,000	4,700	4,400
Outlet at bottom	1,700	1,500	6,400	4,800	4,600
With non-return function					
In main flow direction 1 → 2	1,200	1,750	3,200	5,500	6,000
Outlet at top	500	500	2,700	2,900	3,100
Outlet at bottom	500	500	2,800	3,200	3,300

1) Measured at p₁ = 6 bar and p₂ = 5 bar, Δp = 1 bar

Branching modules MS4/MS6-FRM, MS series

FESTO

Technical data

Operating and environmental conditions						
Size	MS4			MS6		
Variant	Standard	Non-return function I	Pressure switch X/Y/M12	Standard	Non-return function I	Pressure switch X/Y/M12
Operating pressure [bar]	0 ... 14 (0 ... 10) ¹⁾	0 ... 10	0 ... 12 (0 ... 10) ¹⁾	0 ... 20 (0 ... 10) ¹⁾	0 ... 20 (0 ... 10) ¹⁾	0 ... 12 (0 ... 10) ¹⁾
Operating medium	Compressed air in accordance with ISO 8573-1:2010 [7:4:4] Inert gases					
Note on operating/pilot medium	Operation with lubricated medium possible (in which case lubricated operation will always be required)					
Ambient temperature [°C]	-10 ... +60 (0 ... +50) ²⁾					
Temperature of medium [°C]	-10 ... +60 (0 ... +50) ²⁾					
Storage temperature [°C]	-10 ... +60					
Corrosion resistance class CRC ³⁾	2					
UL certification	cULus recognized (OL)					

1) Value in brackets applies to MS4/MS6-FRM with pressure sensor AD... or with UL certification.

2) Value in brackets applies to MS4/MS6-FRM with pressure sensor AD... .

3) Corrosion resistance class CRC 2 to Festo standard FN 940070

Moderate corrosion stress. Indoor applications in which condensation may occur. External visible parts with primarily decorative requirements for the surface and which are in direct contact with the ambient atmosphere typical for industrial applications.

ATEX	
EU certification	EX4
ATEX category gas	II 2G
Ex-ignition protection type gas	c T6 X
ATEX category dust	II 2D
EX-ignition protection type dust	c 60 °C X
ATEX ambient temperature	-10 °C ≤ Ta ≤ +60 °C
CE mark (see declaration of conformity)	To EU Explosion Protection Directive (ATEX)

Weight [g]		
Size	MS4	MS6
Branching module	165	458
Branching module with non-return function I	160	400
Branching module with pressure sensor AD...	255	528
Branching module with pressure switch X/Y/M12	405	736

Materials

Sectional view

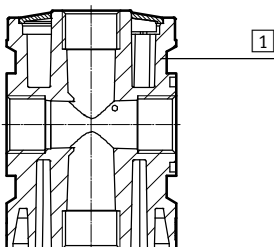

Branching module	
1) Housing	Die-cast aluminium
Note on materials	RoHS-compliant Free of copper and PTFE (not with variants AG or AD...)

Branching modules MS4/MS6-FRM, MS series

Technical data

Dimensions – Basic version

Download CAD data → www.festo.com

With female thread, with cover plate

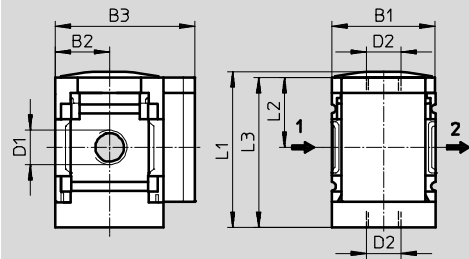

→ Flow direction

Type	B1	B2	B3	D1	D2	L1	L2	L3
MS4-FRM-1/8	40	21	54	G1/8	G1/4	60.4	27	58
MS4-FRM-1/4				G1/4				
MS6-FRM-1/4	62	31	76	G1/4	G1/2	87.2	39	84.5
MS6-FRM-3/8				G3/8				
MS6-FRM-1/2				G1/2				

Note: This product conforms to ISO 1179-1 and to ISO 228-1

Dimensions – Pressure gauge/pressure gauge alternatives

Download CAD data → www.festo.com

Integrated MS pressure gauge with standard scale AG or red-green scale RG, display unit [bar]

Adapter plate A8/A4 for EN pressure gauge 1/8/1/4, without pressure gauge

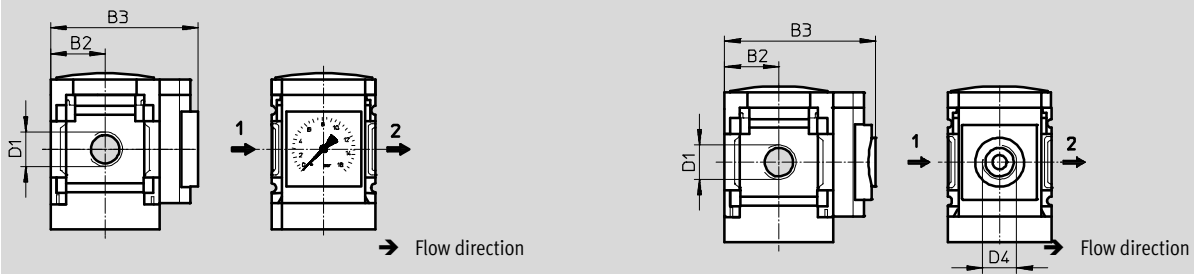

Type	B2	B3		D1	D4
		Standard	With integrated non-return function I		
MS4-FRM-1/8-...-AG	21	65		G1/8	-
MS4-FRM-1/4-...-AG				G1/4	
MS4-FRM-1/8-...-RG	21	66.5		G1/8	-
MS4-FRM-1/4-...-RG				G1/4	
MS4-FRM-1/8-...-A8	21	58.5		G1/8	G1/8
MS4-FRM-1/4-...-A8				G1/4	
MS4-FRM-1/8-...-A4	21	58.5		G1/8	G1/4
MS4-FRM-1/4-...-A4				G1/4	
MS6-FRM-1/4-...-AG	31	77		G1/4	-
MS6-FRM-3/8-...-AG				G3/8	
MS6-FRM-1/2-...-AG				G1/2	
MS6-FRM-1/4-...-RG	31	78.5		G1/4	-
MS6-FRM-3/8-...-RG				G3/8	
MS6-FRM-1/2-...-RG				G1/2	
MS6-FRM-1/4-...-A4	31	78.5		G1/4	G1/4
MS6-FRM-3/8-...-A4				G3/8	
MS6-FRM-1/2-...-A4				G1/2	

Note: This product conforms to ISO 1179-1 and to ISO 228-1

Branching modules MS4/MS6-FRM, MS series

Technical data

Dimensions – Pressure gauge/pressure gauge alternatives Download CAD data → www.festo.com
 Pressure sensor with LCD display AD1 ... AD4 Technical data → Internet: sde1

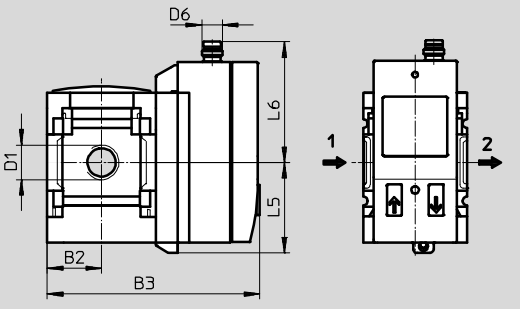

→ Flow direction

Variant AD1:
SDE1-D10-G2-MS-L-P1-M8 with 3-pin plug M8x1, 1 switch output PNP

Variant AD2:
SDE1-D10-G2-MS-L-N1-M8 with 3-pin plug M8x1, 1 switch output NPN

Variant AD3:
SDE1-D10-G2-MS-L-PI-M12 with 4-pin plug M12x1, 1 switch output PNP and 4 ... 20 mA analogue

Variant AD4:
SDE1-D10-G2-MS-L-NI-M12 with 4-pin plug M12x1, 1 switch output NPN and 4 ... 20 mA analogue

Pressure sensor with operational status indicator AD7 ... AD10 Technical data → Internet: sde5

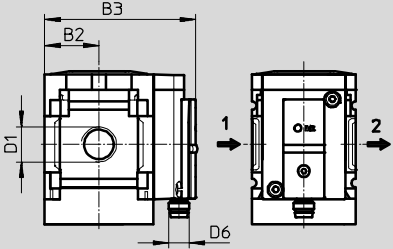

→ Flow direction

Variant AD7:
SDE5-D10-O-...-P-M8 with 3-pin plug M8x1, threshold value comparator, 1 switching output PNP, N/O contact

Variant AD8:
SDE5-D10-C-...-P-M8 with 3-pin plug M8x1, threshold value comparator, 1 switching output PNP, N/C contact

Variant AD9:
SDE5-D10-O3-...-P-M8 with 3-pin plug M8x1, window comparator, 1 switching output PNP, N/O contact

Variant AD10:
SDE5-D10-C3-...-P-M8 with 3-pin plug M8x1, window comparator, 1 switching output PNP, N/C contact

Type	B2	B3	D1	D6	L5	L6
MS4-FRM-1/8-...-AD1/AD2	21	82.6	G1/8	M8x1	35.1	46.7
MS4-FRM-1/4-...-AD1/AD2			G1/4			
MS4-FRM-1/8-...-AD3/AD4	21	82.6	G1/8	M12x1	35.1	55.8
MS4-FRM-1/4-...-AD3/AD4			G1/4			
MS4-FRM-1/8-...-AD7/AD8/AD9/AD10	21	59	G1/8	M8x1	-	-
MS4-FRM-1/4-...-AD7/AD8/AD9/AD10			G1/4			
MS6-FRM-1/4-...-AD1/AD2	31	103	G1/4	M8x1	35.1	46.7
MS6-FRM-3/8-...-AD1/AD2			G3/8			
MS6-FRM-1/2-...-AD1/AD2			G1/2			
MS6-FRM-1/4-...-AD3/AD4	31	103	G1/4	M12x1	35.1	55.8
MS6-FRM-3/8-...-AD3/AD4			G3/8			
MS6-FRM-1/2-...-AD3/AD4			G1/2			
MS6-FRM-1/4-...-AD7/AD8/AD9/AD10	31	79	G1/4	M8x1	-	-
MS6-FRM-3/8-...-AD7/AD8/AD9/AD10			G3/8			
MS6-FRM-1/2-...-AD7/AD8/AD9/AD10			G1/2			

• Note: This product conforms to ISO 1179-1 and to ISO 228-1

Branching modules MS4/MS6-FRM, MS series

Technical data

Dimensions – Pressure switch Download CAD data → www.festo.com
 Pressure switch with adjustable pressure switching point X/Y/M12 Technical data → Internet: pev-1/4

Variant X:
PEV-1/4-SC-0D with display, plug, square design to EN 175 301, type A

Variant Y:
PEV-1/4-B-0D, plug, square design to EN 175 301, type A

Variant M12:
PEV-1/4-B-M12 with 4-pin plug M12x1

Type	B1	B2	B4	D1	L1
MS4-FRM-...-X/Y	40	21	63	–	92.3
MS4-FRM-...-M12	40	21	61	M12x1	92.3
MS6-FRM-...-X/Y	62	31	73	–	99.5
MS6-FRM-...-M12	62	31	71	M12x1	99.5

Ordering data							
Size	Connection	Standard		With integrated non-return function		With pressure switch PEV-1/4-B-0D (variant Y)	
		Part No.	Type	Part No.	Type	Part No.	Type
MS4	G1/8	529559	MS4-FRM-1/8 ¹⁾	–	–	–	–
	G1/4	529555	MS4-FRM-1/4 ¹⁾	536966	MS4-FRM-1/4-1 ¹⁾	529556	MS4-FRM-1/4-Y ¹⁾
MS6	G1/4	529857	MS6-FRM-1/4 ¹⁾	536967	MS6-FRM-1/4-1 ¹⁾	529858	MS6-FRM-1/4-Y ¹⁾
	G3/8	529861	MS6-FRM-3/8 ¹⁾	–	–	529862	MS6-FRM-3/8-Y ¹⁾
	G1/2	529853	MS6-FRM-1/2 ¹⁾	536969	MS6-FRM-1/2-1 ¹⁾	529854	MS6-FRM-1/2-Y ¹⁾

1) Free of copper and PTFE

Branching modules MS4/MS6-FRM, MS series

Ordering data – Modular products

M Mandatory data →

Module No.	Series	Size	Function	Pneumatic connection
527703 527676	MS	4 6	FRM	1/8, 1/4, 3/8, 1/2, AG...
Order example				
527676	MS	6	- FRM	- 3/8

Ordering table						
Grid dimension	[mm]	40	62	Condi- tions	Code	Enter code
M Module No.		527703	527676			
Series		Standard			MS	MS
Size		4	6		...	
Function		Branching module			-FRM	-FRM
Pneumatic connection		Female thread G1/8	-	<input type="checkbox"/>	-1/8	
		Female thread G1/4	Female thread G1/4	<input type="checkbox"/>	-1/4	
		-	Female thread G3/8	<input type="checkbox"/>	-3/8	
		-	Female thread G1/2	<input type="checkbox"/>	-1/2	
		Connecting plate G1/8	-		-AGA	
		Connecting plate G1/4	Connecting plate G1/4		-AGB	
		Connecting plate G3/8	Connecting plate G3/8		-AGC	
		-	Connecting plate G1/2		-AGD	
	-	Connecting plate G3/4		-AGE		

1/8, 1/4, 3/8, 1/2, AD1 ... AD4, AD7 ... AD10, X, Y, M12, WPM
Not with EU certification EX4

Transfer order code

	MS		- FRM		
--	-----------	--	--------------	--	--

Branching modules MS4/MS6-FRM, MS series

Ordering data – Modular products

Options							
Auxiliary function	Pressure gauge/ pressure gauge alternatives	Alternative pressure gauge scale	Pressure switch	Type of mounting	EU certification	UL certification	Flow direction
I	AG, A8, A4, RG, AD1 ... AD4, AD7 ... AD10	PSI, MPA	X, Y, M12	WP, WPM, WB, WBM	EX4	UL1	Z
-	- AG	-	-	-	-	-	-

Ordering table							
Grid dimension	[mm]	40	62	Conditions	Code	Enter code	
0	Auxiliary function	With integrated non-return function				-I	
	Pressure gauge/pressure gauge alternatives	MS pressure gauge, bar				-AG	
		Adapter plate for EN pressure gauge 1/8, without pressure gauge	-			-A8	
		Adapter plate for EN pressure gauge 1/4, without pressure gauge				-A4	
		Integrated pressure gauge, red-green scale				-RG	
		Pressure sensor with LCD display, plug M8, 1 switching output PNP, 3-pin			1 2	-AD1	
		Pressure sensor with LCD display, plug M8, 1 switching output NPN, 3-pin			1 2	-AD2	
		Pressure sensor with LCD display, plug M12, 1 switching output PNP, 4-pin, analogue output 4 ... 20 mA			1 2	-AD3	
		Pressure sensor with LCD display, plug M12, 1 switching output NPN, 4-pin, analogue output 4 ... 20 mA			1 2	-AD4	
		Pressure sensor with operational status indicator, plug M8, threshold value comparator, PNP, N/O contact			1 2	-AD7	
		Pressure sensor with operational status indicator, plug M8, threshold value comparator, PNP, N/C contact			1 2	-AD8	
		Pressure sensor with operational status indicator, plug M8, window comparator, PNP, N/O contact			1 2	-AD9	
		Pressure sensor with operational status indicator, plug M8, window comparator, PNP, N/C contact			1 2	-AD10	
		Alternative pressure gauge scale	psi		3	-PSI	
			MPa		4	-MPA	
	Pressure switch	Pressure switch PEV with display, plug socket, EN 175301, type A, square		1 5	-X		
		Pressure switch PEV without display, plug socket, EN 175301, type A, square		1 5	-Y		
		Pressure switch PEV without display, plug socket, round, M12, 4-pin		1 5	-M12		
	Type of mounting	Mounting bracket standard design		6	-WP		
		Mounting bracket for attaching the service units		1 6	-WPM		
		Mounting bracket centrally at rear (wall mounting top and bottom), connecting plates not required				-WB	
		Mounting bracket centrally at rear (wall mounting top), connecting plates not required	-			-WBM	
	EU certification	II 2GD to EU Directive 94/9/EG				-EX4	
	UL certification	cULus, ordinary location for Canada and USA				-UL1	
	Flow direction	Flow direction from right to left				-Z	

2 AD1 ... AD4, AD7 ... AD10

Measuring range max. 10 bar

3 PSI

Only in combination with pressure gauge AG

4 MPA

Only in combination with pressure gauge AG or RG

5 X, Y, M12

Max. permissible operating pressure P1 = 12 bar.

6 WP, WPM

Only with connecting plate AGA, AGB, AGC, AGD or AGE

Transfer order code

- [] - [] - [] - [] - [] - [] - [] - []

Distributor blocks MS4/MS6-FRM-FRZ, MS series

Technical data

Function

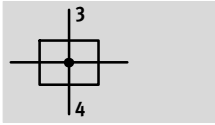

- - Flow rate
2,900 ... 14,600 l/min
- - Temperature range
-10 ... +60 °C
- - Operating pressure
0 ... 20 bar



- - Note
The distributor block MS4/6-FRM-FRZ has a half grid dimension width.

- Pneumatic manifold with 4 connections
- Outlet top and bottom
- Can be used as an intermediate distributor for varying air qualities
- Can be used as an intermediate distributor between two pressure regulators with large rotary knob with pressure gauge on size MS4

General technical data		
Size	MS4	MS6
Pneumatic connection 3, 4	G1/4	G1/2
Design	Branching module	
Type of mounting	Via accessories	
	In-line installation	
Assembly position	Any	

- - Note: This product conforms to ISO 1179-1 and to ISO 228-1

Standard nominal flow rate $q_{nN}^{1)}$ [l/min]		
Size	MS4	MS6
In main flow direction 1 \rightarrow 2	4,050	14,600
Outlet at top	3,250	10,400
Outlet at bottom	2,900	9,850

1) Measured at $p_1 = 6$ bar and $p_2 = 5$ bar, $\Delta p = 1$ bar

Operating and environmental conditions		
Size	MS4	MS6
Operating pressure [bar]	0 ... 14 (0 ... 10) ¹⁾	0 ... 20 (0 ... 10) ¹⁾
Operating medium	Compressed air in accordance with ISO 8573-1:2010 [7:4:4]	
	Inert gases	
Note on operating/pilot medium	Operation with lubricated medium possible (in which case lubricated operation will always be required)	
Ambient temperature [°C]	-10 ... +60	
Temperature of medium [°C]	-10 ... +60	
Storage temperature [°C]	-10 ... +60	
Corrosion resistance class CRC ²⁾	2	
UL certification	cULus recognized (OL)	

1) Value in brackets applies to MS4/MS6-FRM-FRZ with UL certification.

2) Corrosion resistance class CRC 2 to Festo standard FN 940070

Moderate corrosion stress. Indoor applications in which condensation may occur. External visible parts with primarily decorative requirements for the surface and which are in direct contact with the ambient atmosphere typical for industrial applications.

Distributor blocks MS4/MS6-FRM-FRZ, MS series

Technical data

Weight [g]		
Size	MS4	MS6
Distributor block	60	163

Materials

Sectional view

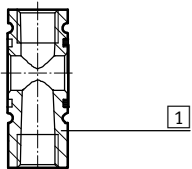

Distributor block	
1 Housing	Die-cast aluminium
Note on materials	RoHS-compliant
	Free of copper and PTFE

Dimensions

Download CAD data → www.festo.com

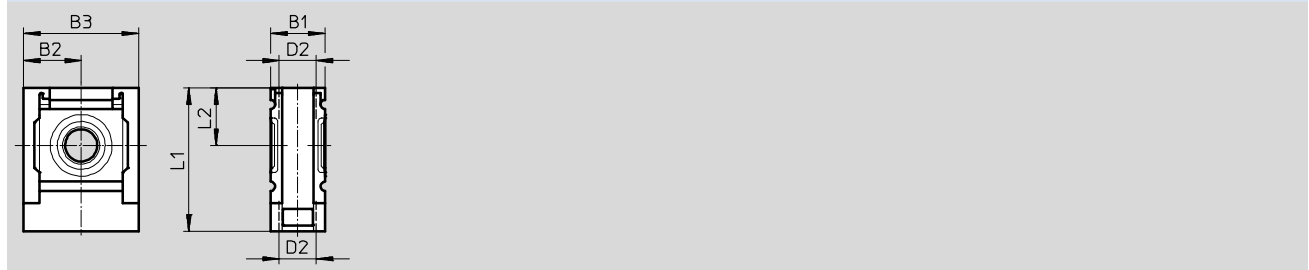

Type	B1	B2	B3	D2	L1	L2
MS4-FRM-FRZ	20	21	42	G $\frac{1}{4}$	52.5	21
MS6-FRM-FRZ	31	31	62	G $\frac{1}{2}$	76.5	31

· † · Note: This product conforms to ISO 1179-1 and to ISO 228-1

Ordering data		
Size	Part No.	Type
MS4	549336	MS4-FRM-FRZ
MS6	549337	MS6-FRM-FRZ

Branching modules MS9-FRM, MS series

Peripherals overview

FESTO

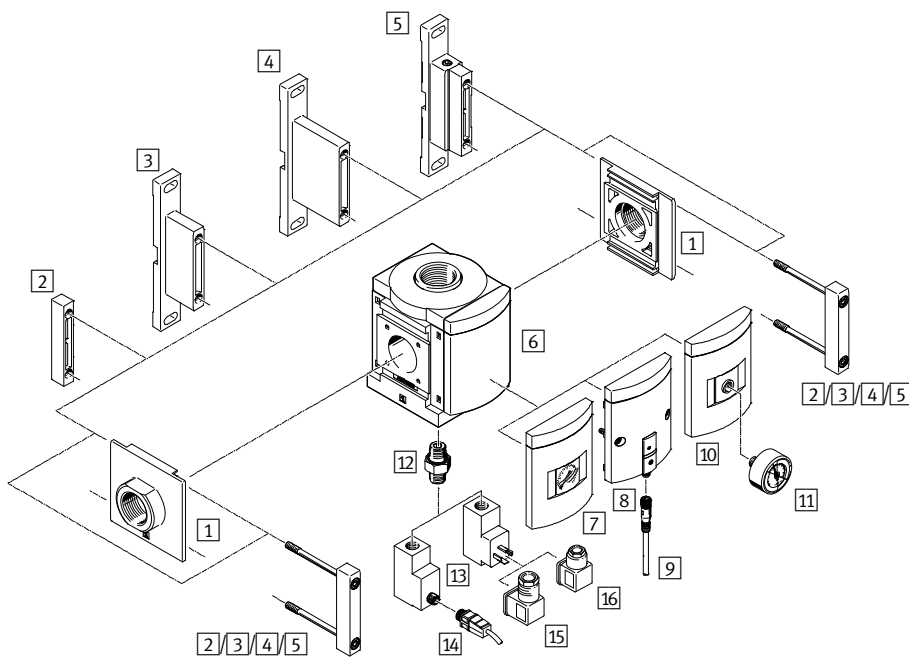

- - Note
 Additional accessories:
 - Module connector for combination with size MS6, MS9 or MS12
 → Internet: rmv, armv

Mounting attachments and accessories					
	Individual component	Combination		→ Page/ Internet	
		With female thread 3/4 or 1	With connecting plate AG...		Module without connecting thread, without connecting plate G
		Without EU certification EX4	With EU certification EX4		
1	Connecting plate-SET MS9-AG...	-	■	■	ms9-ag
2	Module connector MS9-MV	-	-	■	ms9-mv
3	Mounting bracket MS9-WP	■	■	■	ms9-wp
4	Mounting bracket MS9-WPB	■	■	■	ms9-wp
5	Mounting bracket MS9-WPM	■	-	■	ms9-wp
6	Cover plate VS	■	■	■	26
7	MS pressure gauge AG	■	■	■	26
8	Pressure sensor without display AD7 ... AD10	■	-	■	26
9	Connecting cable NEBU-M8...-LE3	■	-	■	33
10	Adapter plate for EN pressure gauge 1/4 A4	■	■	■	26
11	Pressure gauge MA	■	■	■	33
12	Double nipple (included in the scope of delivery) ESK	■	-	■	-
13	Pressure switch PEV X/Y/M12	■	-	■	26
14	Connecting cable NEBU-M12...-LE4	■	-	■	33
15	Angled socket PEV-1/4-WD-LED-...	■	-	■	34
16	Plug socket MSSD-C-4P	■	-	■	34

Branching modules MS9-FRM, MS series

Type codes

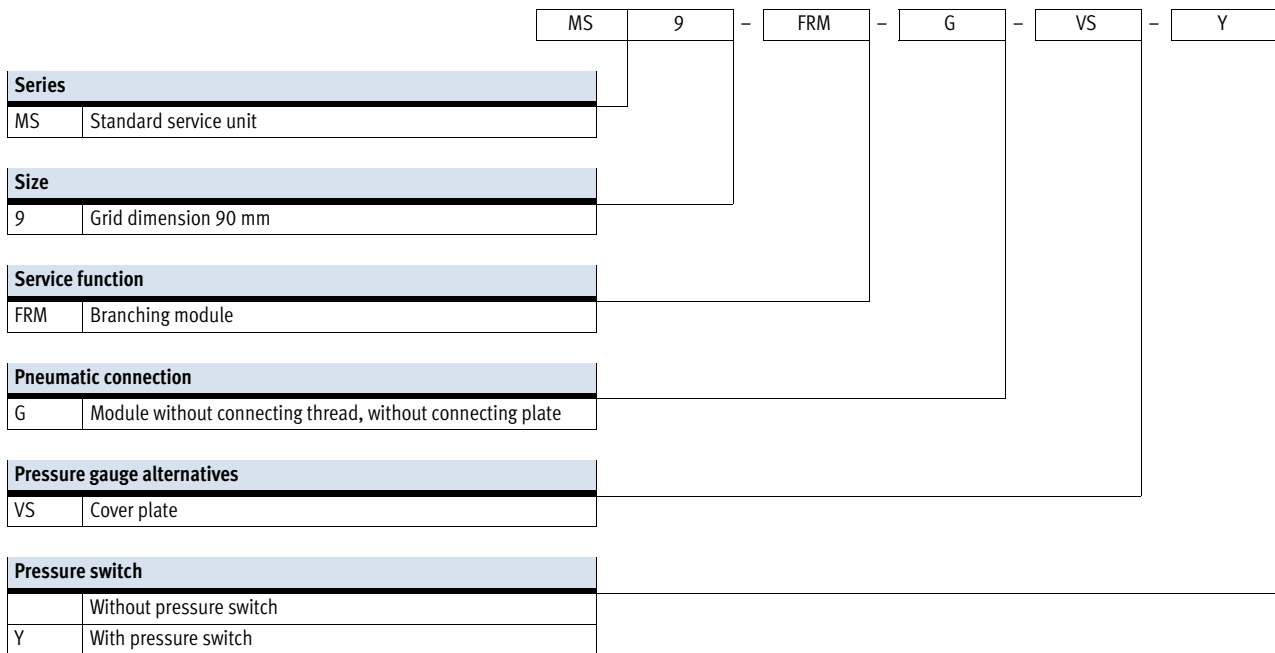

Additional variants can be ordered using the modular system → 26

- Pneumatic connection
- Pressure gauge/pressure gauge alternatives
- Alternative pressure gauge scale
- Pressure switch
- Type of mounting
- EU certification
- UL certification
- Flow direction



Branching modules MS9-FRM, MS series

Technical data

FESTO

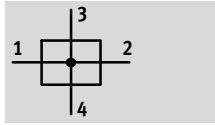
Function



-  - Flow rate
10,000 ... 50,000 l/min
-  - Temperature range
-10 ... +60 °C
-  - Operating pressure
0 ... 20 bar



- Pneumatic manifold with 4 connections
- Attachment facility for auxiliary modules
- Outlet at top and bottom
- Can be used as an intermediate distributor for varying air qualities
- Optional device variant EX4 for use in potentially explosive areas in zones 1, 2, 21 and 22
- Optional pressure sensor

General technical data	
Pneumatic connection 1, 2	
Female thread	G $\frac{3}{4}$ or G1
Connecting plate AG...	G $\frac{1}{2}$, G $\frac{3}{4}$, G1, G1 $\frac{1}{4}$ or G1 $\frac{1}{2}$
Module without connecting thread/plate G	-
Pneumatic connection 3, 4	G1
Design	Branching module
Type of mounting	Via accessories
	In-line installation
	Front panel mounting
Mounting position	Any ¹⁾
Pressure display	Via pressure sensor for displaying output pressure via operational status indicator and electrical output
	Via pressure gauge for displaying output pressure
	Via pressure gauge with red/green scale for displaying output pressure
	G $\frac{1}{4}$ prepared

1) The branching module must be mounted vertically when combined with a pressure sensor as condensate must not collect in the pressure sensor.

-  - Note: This product conforms to ISO 1179-1 and to ISO 228-1

Standard nominal flow rate $q_{nN}^{1)}$ [l/min]					
Pneumatic connection	Connecting plate AGD	Female thread G $\frac{3}{4}$ or connecting plate AGE	Female thread G1 or connecting plate AGF	Connecting plate AGG	Connecting plate AGH
In main flow direction 1 \rightarrow 2	10,000	25,000	45,000	47,000	50,000
Outlet at top	13,000				
Outlet at bottom	13,000				

1) Measured at $p_1 = 6$ bar and $p_2 = 5$ bar, $\Delta p = 1$ bar

Branching modules MS9-FRM, MS series

Technical data

Operating and environmental conditions			
Variant	Standard	Pressure switch X/Y/M12	Pressure sensor AD...
Operating pressure [bar]	0 ... 20	0 ... 12	0 ... 10
Operating medium	Compressed air in accordance with ISO 8573-1:2010 [7:4:4]		
Note on operating/pilot medium	Operation with lubricated medium possible		
Ambient temperature [°C]	-10 ... +60	-10 ... +60	0 ... +50
Temperature of medium [°C]	-10 ... +60	-10 ... +60	0 ... +50
Storage temperature [°C]	-10 ... +60	-10 ... +60	-10 ... +60
Corrosion resistance class CRC ¹⁾	2		
Certification (variant UL1)	cULus recognized (OL)		

1) Corrosion resistance class CRC 2 to Festo standard FN 940070

Moderate corrosion stress. Indoor applications in which condensation may occur. External visible parts with primarily decorative requirements for the surface and which are in direct contact with the ambient atmosphere typical for industrial applications.

ATEX	
EU certification	EX4
ATEX category gas	II 2G
Ex-ignition protection type gas	c T6 X
ATEX category dust	II 2D
EX-ignition protection type dust	c 60 °C X
ATEX ambient temperature	-10 °C ≤ Ta ≤ +60 °C
CE mark (see declaration of conformity)	To EU Explosion Protection Directive (ATEX)

Weight [g]	
Branching module	1,000
Branching module with pressure switch X/Y/M12	1,100

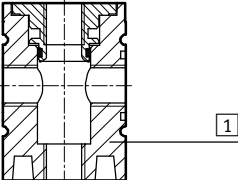
Materials															
Sectional view															
	Branching module														
	<table border="1"> <tbody> <tr> <td>1</td> <td>Housing</td> <td>Die-cast aluminium</td> </tr> <tr> <td>-</td> <td>Cover</td> <td>PA reinforced</td> </tr> <tr> <td>-</td> <td>Connecting plate, module connector, mounting bracket</td> <td>Die-cast aluminium</td> </tr> <tr> <td colspan="2">Note on materials</td> <td>RoHS-compliant</td> </tr> <tr> <td colspan="2"></td> <td>Free of copper and PTFE (not with variant AG)</td> </tr> </tbody> </table>	1	Housing	Die-cast aluminium	-	Cover	PA reinforced	-	Connecting plate, module connector, mounting bracket	Die-cast aluminium	Note on materials		RoHS-compliant		
1	Housing	Die-cast aluminium													
-	Cover	PA reinforced													
-	Connecting plate, module connector, mounting bracket	Die-cast aluminium													
Note on materials		RoHS-compliant													
		Free of copper and PTFE (not with variant AG)													

Dimensions – Basic version Download CAD data → www.festo.com

Module without connecting thread, without connecting plate G, with cover plate VS

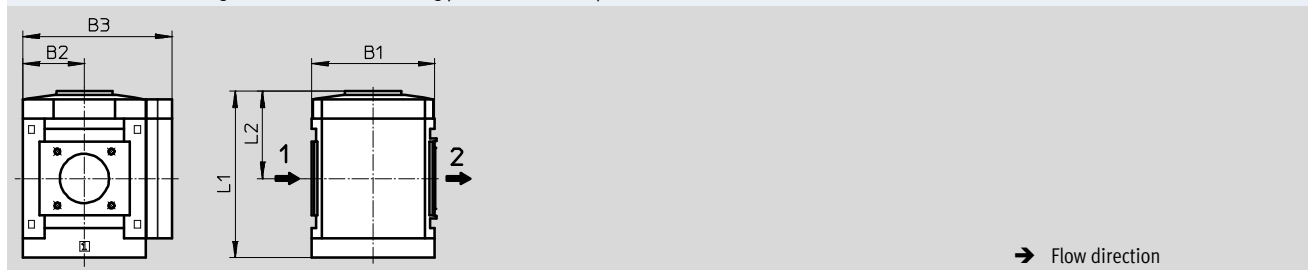

Type	B1	B2	B3	L1	L2
MS9-FRM-G	90	45	109	122	64

Branching modules MS9-FRM, MS series

Technical data

FESTO

Dimensions – Connecting thread/connecting plate

Download CAD data → www.festo.com

With female thread 3/4 or 1

With connecting plate AG...

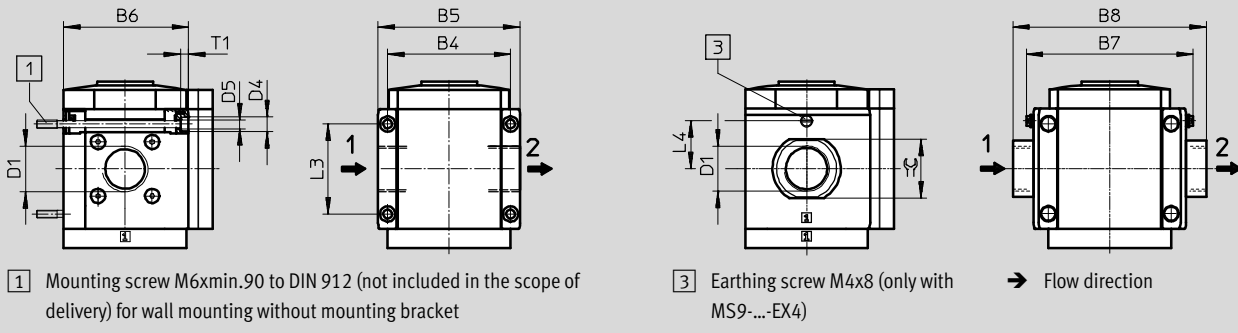

Type	B4	B5	B6	B7		B8	D1	D4	D5	L3	T1		⌀
					EX4							EX4	
MS9-FRM-3/4	90	104	91.5	-	-	-	G3/4	11	6.5	66	-	6	-
MS9-FRM-1							G1						
MS9-FRM-AGD	-	-	-	112	122	132	G1/2	-	-	-	35	-	30
MS9-FRM-AGE						132	G3/4						36
MS9-FRM-AGF						142	G1						41
MS9-FRM-AGG						162	G1 1/4						50
MS9-FRM-AGH						176	G1 1/2						55

• Note: This product conforms to ISO 1179-1 and to ISO 228-1

Dimensions – Pressure gauge/pressure gauge alternatives

Download CAD data → www.festo.com

Integrated MS pressure gauge with standard scale AG or red/green scale RG

Adapter plate A4 for EN pressure gauge 1/4, without pressure gauge

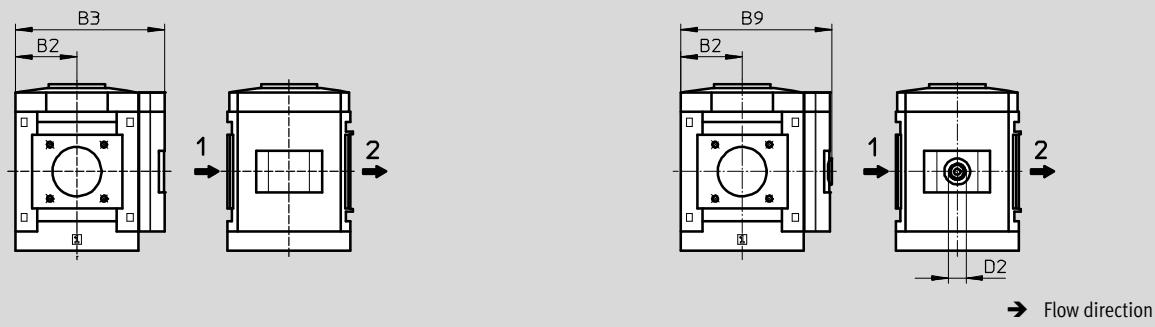

Type	B2	B3	B9	D2
MS9-FRM-...-AG/RG	45	109	-	-
MS9-FRM-...-A4		-	110	G1/4

• Note: This product conforms to ISO 1179-1 and to ISO 228-1

Branching modules MS9-FRM, MS series

Technical data

Dimensions – Pressure gauge/pressure gauge alternatives Download CAD data → www.festo.com
 Pressure sensor with operational status indicator AD7 ... AD10 Technical data → Internet: sde5

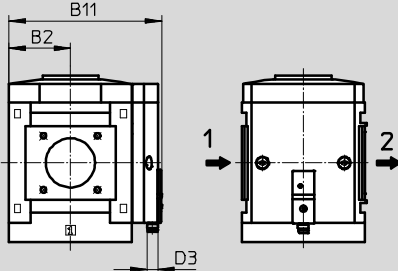

Variant AD7:
SDE5-D10-O-...-P-M8 with 3-pin plug M8x1, threshold value comparator, 1 switching output PNP, N/O contact

Variant AD8:
SDE5-D10-C-...-P-M8 with 3-pin plug M8x1, threshold value comparator, 1 switching output PNP, N/C contact

Variant AD9:
SDE5-D10-O3-...-P-M8 with 3-pin plug M8x1, window comparator, 1 switching output PNP, N/O contact

Variant AD10:
SDE5-D10-C3-...-P-M8 with 3-pin plug M8x1, window comparator, 1 switching output PNP, N/C contact

→ Flow direction

Type	B2	B11	D3
MS9-FRM-...-AD7/AD8/AD9/AD10	45	112	M8

Dimensions – Pressure switch Download CAD data → www.festo.com
 Pressure switch with adjustable pressure switching point X/Y/M12 Technical data → Internet: pev-1/4

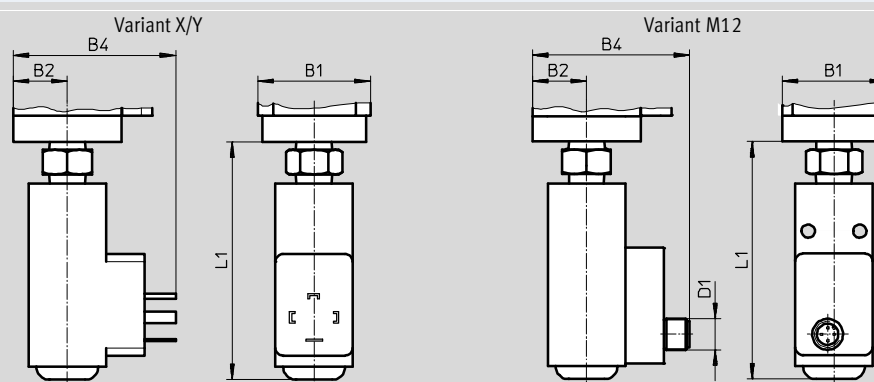

Variant X:
PEV-1/4-SC-OD with display, plug, square design to EN 175 301, type A

Variant Y:
PEV-1/4-B-OD, plug, square design to EN 175 301, type A

Variant M12:
PEV-1/4-B-M12 with 4-pin plug M12x1

Type	B1	B2	B4	D1	L1
MS9-FRM-...-X/Y	90	45	87	–	105
MS9-FRM-...-M12	90	45	85	M12x1	105

Ordering data

Size	Connection	Standard		With pressure switch PEV-1/4-B-OD (variant Y)	
		Part No.	Type	Part No.	Type
Cover plate					
MS9	–	564145	MS9-FRM-G-VS ¹⁾	564147	MS9-FRM-G-VS-Y ¹⁾

1) Free of copper and PTFE

Branching modules MS9-FRM, MS series

Ordering data – Modular products

M Mandatory data →

Module No.	Series	Size	Function	Pneumatic connection
562534	MS	9	FRM	¾, 1, AG..., G
Ordering example				
562534	MS	9	- FRM	- AGE

Ordering table

Grid dimension	[mm]	90	Condi- tions	Code	Enter code
M Module No.	562534				
Series	Standard			MS	MS
Size	9			9	9
Function	Branching module			-FRM	-FRM
Pneumatic connection	Female thread G¾		<input type="checkbox"/>	-¾	
	Female thread G1		<input type="checkbox"/>	-1	
	Connecting plate G½			-AGD	
	Connecting plate G¾			-AGE	
	Connecting plate G1			-AGF	
	Connecting plate G1¼			-AGG	
	Connecting plate G1½			-AGH	
	Module without connecting thread, without connecting plate		<input type="checkbox"/>	-G	

¾, 1, G, AD7, AD8, AD9, AD10, X, Y, M12, WPM
Not with EU certification EX4

Transfer order code

562534 MS 9 - FRM -

Branching modules MS9-FRM, MS series

Ordering data – Modular products

→ M	O Options					
Pressure gauge/ pressure gauge alternatives	Alternative pressure gauge scale	Pressure switch	Type of mounting	EU certification	UL certification	Flow direction
AG, VS, A4, RG, AD7 ... AD10	PSI, MPA, BAR	X, Y, M12	WP, WPM, WPB	EX4	UL1	Z
- VS	-	-	-	-	-	-

Ordering table		Grid dimension [mm]	90	Conditions	Code	Enter code
M	Pressure gauge/pressure gauge alternatives	MS pressure gauge			-AG	
		Cover plate			-VS	
		Adapter plate for EN pressure gauge 1/4, without pressure gauge			-A4	
		Integrated pressure gauge, red/green scale		2	-RG	
		Pressure sensor with operational status indicator, plug M8, threshold value comparator, PNP, N/O contact		1 3	-AD7	
		Pressure sensor with operational status indicator, plug M8, threshold value comparator, PNP, N/C contact		1 3	-AD8	
		Pressure sensor with operational status indicator, plug M8, window comparator, PNP, N/O contact		1 3	-AD9	
		Pressure sensor with operational status indicator, plug M8, window comparator, PNP, N/C contact		1 3	-AD10	
O	Alternative pressure gauge scale	psi		4	-PSI	
		MPa		4	-MPA	
		bar		4	-BAR	
	Pressure switch	Pressure switch PEV with display, plug socket, EN175301, type A, cube		1 5	-X	
		Pressure switch PEV without display, plug socket, EN 175301, type A, cube		1 5	-Y	
		Pressure switch PEV without display, plug socket, round, M12, 4-pin		1 5	-M12	
	Type of mounting	Mounting bracket standard design		6	-WP	
		Mounting bracket for attaching the service units		1 6	-WPM	
		Mounting bracket for large wall gap		6	-WPB	
	EU certification	II 2GD to EU Directive 94/9/EG			-EX4	
UL certification	cULus, ordinary location for Canada and USA			-UL1		
Flow direction	Flow direction from right to left			-Z		

1 3/4, 1, G, AD7, AD8, AD9, AD10, X, Y, M12, WPM

Not with EU certification EX4

2 RG

Not with alternative pressure gauge scale PSI, PSI scale serves only as an auxiliary scale

3 AD7 ... AD10

Measuring range max. 10 bar

4 PSI, MPA, BAR

Not with pressure gauge alternatives VS, A4, AD7, AD8, AD9, AD10

5 X, Y, M12

Max. permissible operating pressure P1 = 12 bar

6 WP, WPM, WPB

Not with pneumatic connection G

Transfer order code

- - - - - - -

Branching modules MS12-FRM, MS series

Peripherals overview

Branching modules MS12-FRM

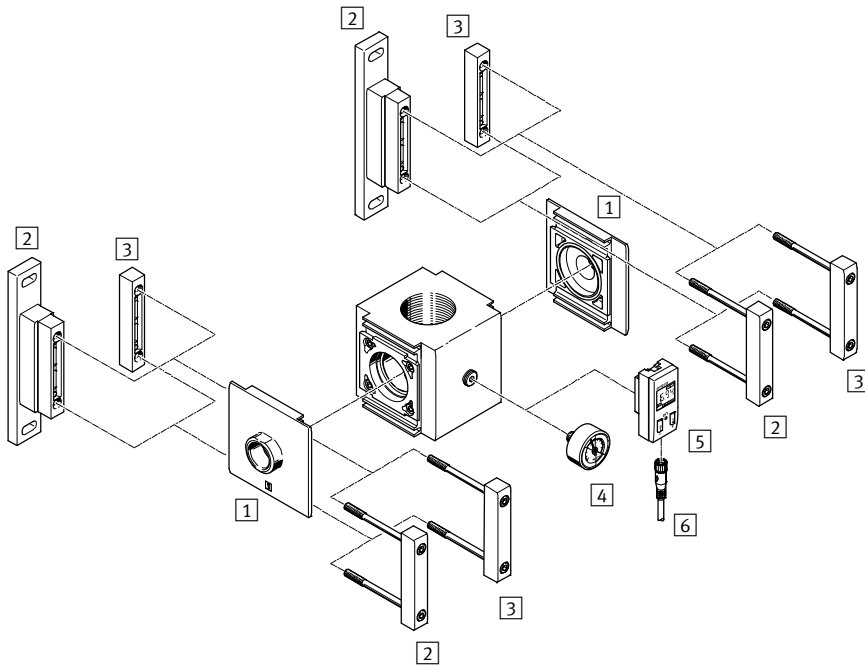

 Note
 Additional accessories:
 – Module connector for combination with size MS9 → Internet: armv

Mounting attachments and accessories

		→ Page/Internet
1	Connecting plate-SET MS12-AG...	ms12-ag
2	Mounting bracket MS12-WP	ms12-wp
3	Module connector MS12-MV	ms12-mv
4	Pressure gauge MA	33
5	Pressure sensor SDE1...-R14/R18	33
6	Connecting cable NEBU-M8...-LE3/NEBU-M8...-LE4/NEBU-M12...-LE3	33

Branching modules MS12-FRM, MS series

Type codes

		MS	12	-	FRM	-	G
Series							
MS	Standard service unit						
Size							
12	Grid dimension 124 mm						
Service function							
FRM	Branching module						
Connection size							
G	Module without connecting thread, without connecting plate Connecting plates → Accessories						

Further variants can be ordered using the modular system → 32

- Connecting plates
- Type of mounting



Branching modules MS12-FRM, MS series

Technical data

FESTO

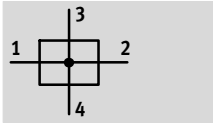
Function



-  - Flow rate
25,000 ... 42,000 l/min
-  - Temperature range
-10 ... +60 °C
-  - Operating pressure
0 ... 20 bar



- Pneumatic manifold with 4 connections
- Attachment facility for auxiliary modules
- Outlet top and bottom
- Can be used as an intermediate distributor for varying air qualities

General technical data

Pneumatic connection 1, 2	
Connecting plate AG...	G1, G1¼, G1½ or G2
Module without connecting thread/plate G	-
Pneumatic connection 3	G2
Pneumatic connection 4	G1
Design	Branching module
Type of mounting	Via accessories
	In-line installation
Assembly position	Any

• Note: This product conforms to ISO 1179-1 and to ISO 228-1

Standard nominal flow rate $q_{nN}^{1)}$ [l/min]

In main flow direction 1 → 2	25,000 ... 42,000
------------------------------	-------------------

1) Dependent on connecting plate AG... selected
Measured at $p_1 = 6$ bar and $p_2 = 5$ bar, $\Delta p = 1$ bar

Operating and environmental conditions

Operating pressure	[bar]	0 ... 20
Operating medium		Compressed air in accordance with ISO 8573-1:2010 [-:--:-]
Ambient temperature	[°C]	-10 ... +60
Temperature of medium	[°C]	-10 ... +60
Storage temperature	[°C]	-10 ... +60
Corrosion resistance	CRC ¹⁾	2

1) Corrosion resistance class CRC 2 to Festo standard FN 940070
Moderate corrosion stress. Indoor applications in which condensation may occur. External visible parts with primarily decorative requirements for the surface and which are in direct contact with the ambient atmosphere typical for industrial applications.

Branching modules MS12-FRM, MS series

Technical data

Weights [g]	
Branching module	3,000

Materials

Sectional view

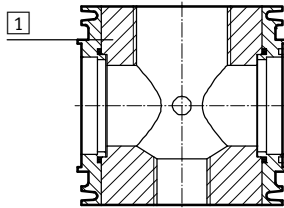

Branching module		
1	Body	Die-cast aluminium
-	Seals	NBR
-	Connecting plate, module connector, mounting bracket	Die-cast aluminium
Note on materials		Free of copper and PTFE

Dimensions – Basic version

Download CAD data → www.festo.com

Without connecting thread G

1) G $\frac{1}{4}$ Female thread in body, sealed with cover plate by default

→ Flow direction

Type	B1	B2	B3	D2	D3	D4	L1	L2
MS12-FRM-G	124	124	134	G2	G1	G $\frac{1}{4}$	122	61

• Note: This product conforms to ISO 1179-1 and to ISO 228-1

Ordering data

Size	Connection	Part No.	Type
MS12	-	541681	MS12-FRM-G ¹⁾

1) Free of copper and PTFE

• Note: This product conforms to ISO 1179-1 and to ISO 228-1

Branching modules MS12-FRM, MS series

Ordering data – Modular products

M Mandatory data				O Options		
Module No.	Series	Size	Function	Pneumatic connection	Type of mounting	
535035	MS	12	FRM	AG..., G	WP	
Order example						
535035	MS	12	- FRM	- AGF	- WP	

Ordering table					
Grid dimension	[mm]	124	Condi- tions	Code	Enter code
M	Module No.	535035			
	Series	Standard		MS	MS
	Size	12		12	12
	Function	Branching module		-FRM	-FRM
	Pneumatic connection	Connecting plate G1		-AGF	
		Connecting plate G1¼		-AGG	
		Connecting plate G1½		-AGH	
		Connecting plate G2		-AGI	
		Module without connecting thread, without connecting plate		-G	
O	Type of mounting	Mounting bracket standard design	1	-WP	

1 WP Only with connecting plate AGF, AGG, AGH or AGI.

Transfer order code

535035	MS	12	- FRM	-		-	
--------	----	----	-------	---	--	---	--



Branching modules/distributor blocks MS-FRM, MS series

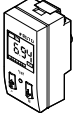

FESTO

Accessories

Ordering data – Pressure gauge MA						
	Nominal size	Pneumatic connection	Display range		Part No.	Type
			[bar]	[psi]		
	Pressure gauge MA, EN 837-1					Technical data → Internet: ma
	40	R $\frac{1}{4}$	0 ... 16	0 ... 232	187080	MA-40-16-R $\frac{1}{4}$ -EN
		G $\frac{1}{4}$	0 ... 16	0 ... 232	183901	MA-40-16-G $\frac{1}{4}$ -EN
	Pressure gauge MA, EN 837-1, with red-green range					Technical data → Internet: ma
40	R $\frac{1}{8}$	0 ... 16	–	525726	MA-40-16-R $\frac{1}{8}$ -E-RG	
50	R $\frac{1}{4}$	0 ... 16	–	525729	MA-50-16-R $\frac{1}{4}$ -E-RG	

Ordering data – Pressure sensor SDE1						Technical data → Internet: sde1	
	Pneumatic connection	Electrical output	Electrical connection	Display	Part No.	Type	
Pressure sensor SDE1 for direct mounting on the service unit with pressure gauge connection (adapter plate for pneumatic connection included in scope of delivery), pressure measurement range 0 ... 10 bar, relative pressure measurement							
	Male thread R $\frac{1}{8}$	1 switching output PNP	M8x1, 3-pin	LCD	192026	SDE1-D10-G2-R18-C-P1-M8	
			M8x1, 3-pin	Illuminated LCD	529970	SDE1-D10-G2-R18-L-P1-M8	
			M12x1, 3-pin	Illuminated LCD	534064	SDE1-D10-G2-R18-L-P1-M12	
		2 switching outputs PNP	M8x1, 4-pin	LCD	192027	SDE1-D10-G2-R18-C-P2-M8	
			1 switching output PNP and 0 ... 10 V analogue	M8x1, 4-pin	LCD	529958	SDE1-D10-G2-R18-C-PU-M8
				M8x1, 4-pin	Illuminated LCD	529972	SDE1-D10-G2-R18-L-PU-M8
	Male thread R $\frac{1}{4}$	1 switching output PNP	M8x1, 3-pin	LCD	192028	SDE1-D10-G2-R14-C-P1-M8	
			M8x1, 3-pin	Illuminated LCD	529967	SDE1-D10-G2-R14-L-P1-M8	
			M12x1, 3-pin	Illuminated LCD	534157	SDE1-D10-G2-R14-L-P1-M12	
		2 switching outputs PNP	M8x1, 4-pin	LCD	192029	SDE1-D10-G2-R14-C-P2-M8	
			1 switching output PNP and 0 ... 10 V analogue	M8x1, 4-pin	LCD	529968	SDE1-D10-G2-R14-L-P2-M8
				M8x1, 4-pin	Illuminated LCD	529957	SDE1-D10-G2-R14-C-PU-M8
M8x1, 4-pin	Illuminated LCD	529969	SDE1-D10-G2-R14-L-PU-M8				

Ordering data – Connecting cable NEBU-M8					Technical data → Internet: nebu
	Electrical connection	Number of wires	Cable length [m]	Part No.	Type
	M8x1, straight socket	3	2.5	541333	NEBU-M8G3-K-2.5-LE3
			5	541334	NEBU-M8G3-K-5-LE3
		4	2.5	541342	NEBU-M8G4-K-2.5-LE4
			5	541343	NEBU-M8G4-K-5-LE4
	M8x1, angled socket	3	2.5	541338	NEBU-M8W3-K-2.5-LE3
			5	541341	NEBU-M8W3-K-5-LE3
		4	2.5	541344	NEBU-M8W4-K-2.5-LE4
			5	541345	NEBU-M8W4-K-5-LE4

Ordering data – Connecting cable NEBU-M12					Technical data → Internet: nebu
	Electrical connection	Number of wires	Cable length [m]	Part No.	Type
	M12x1, straight socket	3	2.5	541363	NEBU-M12G5-K-2.5-LE3
			5	541364	NEBU-M12G5-K-5-LE3
		4	2.5	550326	NEBU-M12G5-K-2.5-LE4
			5	541328	NEBU-M12G5-K-5-LE4
	M12x1, angled socket	3	2.5	541367	NEBU-M12W5-K-2.5-LE3
			5	541370	NEBU-M12W5-K-5-LE3
		4	2.5	550325	NEBU-M12W5-K-2.5-LE4
			5	541329	NEBU-M12W5-K-5-LE4

Branching modules/distributor blocks MS-FRM, MS series

FESTO

Accessories

Ordering data – Angled socket PEV						Technical data → Internet: pev-1/4
	Description	Operating voltage range	Electrical connection	Switching status display	Part No.	Type
	For PEV-1/4-...-OD	15 ... 30 V DC	4-pin	Yellow LED	164274	PEV-1/4-WD-LED-24
		≤ 230 V AC ≤ 180 V DC	4-pin	Yellow LED	164275	PEV-1/4-WD-LED-230

Ordering data – Plug socket MSSD						Technical data → Internet: mssd-c-4p
	Description	Operating voltage range	Electrical connection	Type of mounting: cable connection	Part No.	Type
	For PEV-1/4-...-OD	≤ 250 V AC/DC	3-pin	Clamping screws	171157	MSSD-C-4P

Ordering data – Double nipple ESK					
	Description	Pneumatic connection		Part No.	Type
	Adjustable for angular compensation • For retrofitting pressure switch PEV to branching module MS-FRM	R1/4	R1/4	151521	ESK-1/4-1/4
			R1/2	534153	ESK-1/4-1/2

Product Range and Company Overview

A Complete Suite and Company Overview

Our experienced engineers provide complete support at every stage of your development process, including: conceptualization, analysis, engineering, design, assembly, documentation, validation, and production.



Custom Automation Components
Complete custom engineered solutions



Custom Control Cabinets
Comprehensive engineering support and on-site services



Complete Systems
Shipment, stocking and storage services

The Broadest Range of Automation Components

With a comprehensive line of more than 30,000 automation components, Festo is capable of solving the most complex automation requirements.



Electromechanical
Electromechanical actuators, motors, controllers & drivers



Pneumatics
Pneumatic linear and rotary actuators, valves, and air supply



PLCs and I/O Devices
PLC's, operator interfaces, sensors and I/O devices

Supporting Advanced Automation... As No One Else Can!

Festo is a leading global manufacturer of pneumatic and electromechanical systems, components and controls for industrial automation, with more than 16,000 employees in 60 national headquarters serving more than 180 countries. For more than 80 years, Festo has continuously elevated the state of manufacturing with innovations and optimized motion control solutions that deliver higher performing, more profitable automated manufacturing and processing equipment. Our dedication to the advancement of automation extends beyond technology to the education and development of current and future automation and robotics designers with simulation tools, teaching programs, and on-site services.

Quality Assurance, ISO 9001 and ISO 14001 Certifications

Festo Corporation is committed to supply all Festo products and services that will meet or exceed our customers' requirements in product quality, delivery, customer service and satisfaction.

To meet this commitment, we strive to ensure a consistent, integrated, and systematic approach to management that will meet or exceed the requirements of the ISO 9001 standard for Quality Management and the ISO 14001 standard for Environmental Management.



© Copyright 2013, Festo Corporation. While every effort is made to ensure that all dimensions and specifications are correct, Festo cannot guarantee that publications are completely free of any error, in particular typing or printing errors. Accordingly, Festo cannot be held responsible for the same. For Liability and Warranty conditions, refer to our "Terms and Conditions of Sale", available from your local Festo office. All rights reserved. No part of this publication may be reproduced, distributed, or transmitted in any form or by any means, electronic, mechanical, photocopying or otherwise, without the prior written permission of Festo. All technical data subject to change according to technical update.



Printed on recycled paper at New Horizon Graphic, Inc., FSC certified as an environmental friendly printing plant.

Festo North America

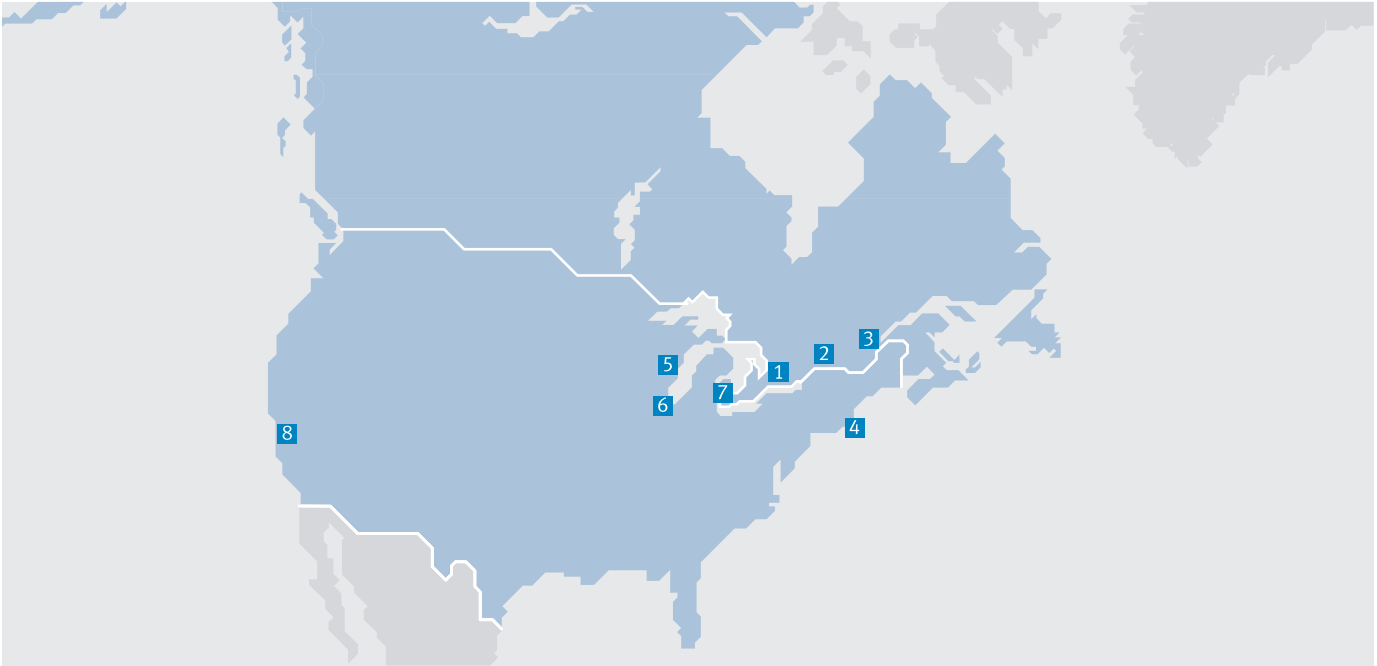

**1 Festo Canada
Headquarters
Festo Inc.**
5300 Explorer Drive
Mississauga, ON
L4W 5G4

2 Montréal
5600, Trans-Canada
Pointe-Claire, QC
H9R 1B6

3 Québec City
2930, rue Watt#117
Québec, QC
G1X 4G3



**4 Festo United States
Headquarters
Festo Corporation**
395 Moreland Road
Hauppauge, NY
11788

5 Appleton
North 922 Tower View Drive, Suite N
Greenville, WI
54942

7 Detroit
1441 West Long Lake Road
Troy, MI
48098

6 Chicago
85 W Algonquin - Suite 340
Arlington Heights, IL
60005

8 Silicon Valley
4935 Southfront Road, Suite F
Livermore, CA
94550

Festo Regional Contact Center

Canadian Customers

Commercial Support:
Tel: 1 877 GO FESTO (1 877 463 3786)
Fax: 1 877 FX FESTO (1 877 393 3786)
Email: festo.canada@ca.festo.com

Technical Support:

Tel: 1 866 GO FESTO (1 866 463 3786)
Fax: 1 877 FX FESTO (1 877 393 3786)
Email: technical.support@ca.festo.com

USA Customers

Commercial Support:
Tel: 1 800 99 FESTO (1 800 993 3786)
Fax: 1 800 96 FESTO (1 800 963 3786)
Email: customer.service@us.festo.com

Technical Support:

Tel: 1 866 GO FESTO (1 866 463 3786)
Fax: 1 800 96 FESTO (1 800 963 3786)
Email: product.support@us.festo.com