

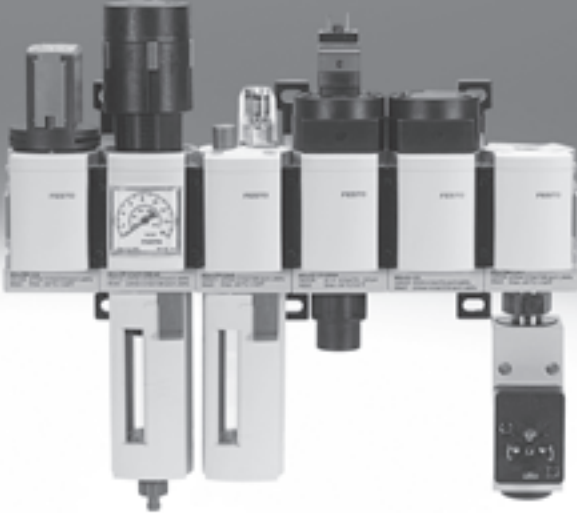





Service unit combinations MSB, MS series

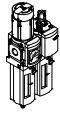
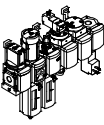

Service unit combinations MSB, MS series

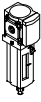

Product range overview – MS series service units

Type	Size	Pneumatic connection in housing	Connecting plate	Pressure regulation range [bar]						Grade of filtration [µm]			
				0.05 ... 0.7	0.05 ... 2.5	0.1 ... 4	0.3 ... 7	0.1 ... 12	0.5 ... 16	0.01	1	5	40
Code			AG.../AQ...	D2	D4	D5	D6	D7	D8	A	B	C	E
Service unit combinations													
MSB-FRC 	4	G1/8, G1/4	G1/8, G1/4, G3/8	-	-	-	■	■	-	-	-	■	■
	6	G1/4, G3/8, G1/2	G1/4, G3/8, G1/2, G3/4	-	-	-	■	■	-	-	-	■	■
	9	-	-	-	-	-	-	-	-	-	-	-	-
	12	-	-	-	-	-	-	-	-	-	-	-	-
Service unit combinations (further variants can be ordered using the configurator → Internet: msb4, msb6 or msb9)													
MSB 	4	G1/4	G1/8, G1/4, G3/8	-	-	-	■	■	-	-	-	■	■
	6	G1/2	G1/4, G3/8, G1/2, G3/4	-	-	-	■	■	-	-	-	■	■
	9	-	-	-	-	-	-	-	-	-	-	-	-
	12	-	-	-	-	-	-	-	-	-	-	-	-
Individual devices													
Filter regulators MS-LFR 	4	G1/8, G1/4	G1/8, G1/4, G3/8	-	-	■	■	■	-	-	-	■	■
	6	G1/4, G3/8, G1/2	G1/4, G3/8, G1/2, G3/4	-	-	■	■	■	■	-	-	■	■
	9	G3/4, G1	G1/2, G3/4, G1, G1 1/4, G1 1/2	-	-	■	■	■	■	-	-	■	■
	12	-	G1, G1 1/4, G1 1/2, G2	-	-	-	■	■	■	-	-	■	■
Filters MS-LF 	4	G1/8, G1/4	G1/8, G1/4, G3/8	-	-	-	-	-	-	-	-	■	■
	6	G1/4, G3/8, G1/2	G1/4, G3/8, G1/2, G3/4	-	-	-	-	-	-	-	-	■	■
	9	G3/4, G1	G1/2, G3/4, G1, G1 1/4, G1 1/2	-	-	-	-	-	-	-	-	■	■
	12	-	G1, G1 1/4, G1 1/2, G2	-	-	-	-	-	-	-	-	■	■
Fine and micro filters MS-LFM 	4	G1/8, G1/4	G1/8, G1/4, G3/8	-	-	-	-	-	-	■	■	-	-
	6	G1/4, G3/8, G1/2	G1/4, G3/8, G1/2, G3/4	-	-	-	-	-	-	■	■	-	-
	9	G3/4, G1	G1/2, G3/4, G1, G1 1/4, G1 1/2	-	-	-	-	-	-	■	■	-	-
	12	-	G1, G1 1/4, G1 1/2, G2	-	-	-	-	-	-	■	■	-	-
Activated carbon filters MS-LFX 	4	G1/8, G1/4	G1/8, G1/4, G3/8	-	-	-	-	-	-	-	-	-	-
	6	G1/4, G3/8, G1/2	G1/4, G3/8, G1/2, G3/4	-	-	-	-	-	-	-	-	-	-
	9	G3/4, G1	G1/2, G3/4, G1, G1 1/4, G1 1/2	-	-	-	-	-	-	-	-	-	-
	12	-	G1, G1 1/4, G1 1/2, G2	-	-	-	-	-	-	-	-	-	-
Water separators MS-LWS 	4	-	-	-	-	-	-	-	-	-	-	-	-
	6	G1/4, G3/8, G1/2	G1/4, G3/8, G1/2, G3/4	-	-	-	-	-	-	-	-	-	-
	9	G3/4, G1	G1/2, G3/4, G1, G1 1/4, G1 1/2	-	-	-	-	-	-	-	-	-	-
	12	-	G1, G1 1/4, G1 1/2, G2	-	-	-	-	-	-	-	-	-	-

Service unit combinations MSB, MS series

Product range overview – MS series service units

Type	Size	Bowl guard		Condensate drains				Pressure indicator					Security		Options		→ Page/ Internet
		Plastic bowl with plastic bowl guard	Metal bowl	Manual rotary	Semi-automatic	Fully automatic	External, fully automatic, electrical	Cover plate (without pressure gauge)	Integrated MS pressure gauge	Adapter plate for EN pressure gauge G1/8	Adapter plate for EN pressure gauge G1/4	Pressure sensor	Rotary knob with detent, lockable via accessories	Rotary knob with integrated lock	Silencer	Flow direction from right to left	
Code		R	U	M	H	V	E...	VS	AG	A8	A4	AD...	AS	E11	S	Z	
Service unit combinations																	
MSB-FRC	4	■	-	■	-	■	-	-	■	-	-	-	■	-	-	■	msb4
	6	■	■	■	-	■	-	-	■	-	-	-	■	-	-	■	msb6
	9	-	-	-	-	-	-	-	-	-	-	-	-	-	-	-	-
	12	-	-	-	-	-	-	-	-	-	-	-	-	-	-	-	-
Service unit combinations																	
MSB	4	■	■	■	-	■	-	-	■	-	-	-	■	-	-	■	8
	6	■	■	■	-	■	-	-	■	-	-	-	■	-	-	■	8
	9	-	-	-	-	-	-	-	-	-	-	-	-	-	-	-	-
	12	-	-	-	-	-	-	-	-	-	-	-	-	-	-	-	-
Individual devices																	
Filter regulators MS-LFR	4	■	■	■	■	■	-	■	■	■	■	■	■	■	-	■	ms4-lfr
	6	■	■	■	■	■	■	■	■	■	■	■	■	■	-	■	ms6-lfr
	9	-	■	■	■	■	■	■	■	■	■	■	■	■	-	■	ms9-lfr
	12	-	■	■	-	■	■	■	■	■	■	■	■	■	-	■	ms12-lfr
Filters MS-LF	4	■	■	■	■	■	-	-	-	-	-	-	-	-	-	■	ms4-lf
	6	■	■	■	■	■	■	-	-	-	-	-	-	-	-	■	ms6-lf
	9	-	■	■	■	■	■	-	-	-	-	-	-	-	-	■	ms9-lf
	12	-	■	■	-	■	■	-	-	-	-	-	-	-	-	■	ms12-lf
Fine and micro filters MS-LFM	4	■	■	■	■	■	-	-	-	-	-	-	-	-	-	■	ms4-lfm
	6	■	■	■	■	■	■	-	-	-	-	-	-	-	-	■	ms6-lfm
	9	-	■	■	■	■	■	-	-	-	-	-	-	-	-	■	ms9-lfm
	12	-	■	■	-	■	■	-	-	-	-	-	-	-	-	■	ms12-lfm
Activated carbon filters MS-LFX	4	■	■	-	-	-	-	-	-	-	-	-	-	-	-	■	ms4-lfx
	6	■	■	-	-	-	-	-	-	-	-	-	-	-	-	■	ms6-lfx
	9	-	■	-	-	-	-	-	-	-	-	-	-	-	-	■	ms9-lfx
	12	-	■	-	-	-	-	-	-	-	-	-	-	-	-	■	ms12-lfx
Water separators MS-LWS	4	-	-	-	-	-	-	-	-	-	-	-	-	-	-	-	-
	6	-	■	-	-	■	■	-	-	-	-	-	-	-	-	■	ms6-lws
	9	-	■	-	-	■	■	-	-	-	-	-	-	-	-	■	ms9-lws
	12	-	■	-	-	■	■	-	-	-	-	-	-	-	-	■	ms12-lws

Service unit combinations MSB, MS series

Product range overview – MS series service units

Type	Size	Pneumatic connection in housing	Connecting plate	Pressure regulation range [bar]								Supply voltage			
				0.05	0.05	0.1	0.3	0.1	0.5	24 V DC, connection pattern to EN 175301	24 V DC, connection M12 to IEC 61076-2-101	110 V AC, connection pattern to EN 175301	230 V AC, connection pattern to EN 175301		
Code			AG.../AQ...	D2	D4	D5	D6	D7	D8	V24	V24P	V110	V230		
Individual devices															
Pressure regulators MS-LR		4	G1/8, G1/4	G1/8, G1/4, G3/8	-	-	■	■	■	-	-	-	-		
		6	G1/4, G3/8, G1/2	G1/4, G3/8, G1/2, G3/4	-	-	■	■	■	■	-	-	-		
		9	G3/4, G1	G1/2, G3/4, G1, G1 1/4, G1 1/2	-	-	■	■	■	■	-	-	-		
		12	-	G1, G1 1/4, G1 1/2, G2	-	-	-	■	■	■	-	-	-		
Pressure regulators MS-LRB		4	G1/4	G1/8, G1/4, G3/8	-	-	■	■	■	-	-	-	-		
		6	G1/2	G1/4, G3/8, G1/2, G3/4	-	-	■	■	■	■	-	-	-		
		9	-												
		12	-												
Precision pressure regulators MS-LRP		4	-												
		6	G1/4, G3/8, G1/2	G1/4, G3/8, G1/2, G3/4	■	■	■	-	■	-	-	-	-		
		9	-												
		12	-												
Precision pressure regulators MS-LRPB		4	-												
		6	G1/2	G1/4, G3/8, G1/2, G3/4	■	■	■	-	■	-	-	-	-		
		9	-												
		12	-												
Electrical pressure regulators MS-LRE		4	-												
		6	G1/4, G3/8, G1/2	G1/4, G3/8, G1/2, G3/4	-	-	■	■	■	■	-	-	-		
		9	-												
		12	-												
Lubricators MS-LOE		4	G1/8, G1/4	G1/8, G1/4, G3/8	-	-	-	-	-	-	-	-	-		
		6	G1/4, G3/8, G1/2	G1/4, G3/8, G1/2, G3/4	-	-	-	-	-	-	-	-	-		
		9	G3/4, G1	G1/2, G3/4, G1, G1 1/4, G1 1/2	-	-	-	-	-	-	-	-	-		
		12	-	G1, G1 1/4, G1 1/2, G2	-	-	-	-	-	-	-	-	-		
On-off valves, manually actuated MS-EM(1)		4	G1/8, G1/4	G1/8, G1/4, G3/8	-	-	-	-	-	-	-	-	-		
		6	G1/4, G3/8, G1/2	G1/4, G3/8, G1/2, G3/4	-	-	-	-	-	-	-	-	-		
		9	G3/4, G1	G1/2, G3/4, G1, G1 1/4, G1 1/2	-	-	-	-	-	-	-	-	-		
		12	-	G1, G1 1/4, G1 1/2, G2	-	-	-	-	-	-	-	-	-		
On-off valves, electrically actuated MS-EE		4	G1/8, G1/4	G1/8, G1/4, G3/8	-	-	-	-	-	■	-	■	■		
		6	G1/4, G3/8, G1/2	G1/4, G3/8, G1/2, G3/4	-	-	-	-	-	■	-	■	■		
		9	G3/4, G1	G1/2, G3/4, G1, G1 1/4, G1 1/2	-	-	-	-	-	■	■	■	■		
		12	-	G1, G1 1/4, G1 1/2, G2	-	-	-	-	-	■	■	■	■		
Soft-start valves, pneumatically actuated MS-DL		4	G1/8, G1/4	G1/8, G1/4, G3/8	-	-	-	-	-	-	-	-	-		
		6	G1/4, G3/8, G1/2	G1/4, G3/8, G1/2, G3/4	-	-	-	-	-	-	-	-	-		
		9	-												
		12	-	G1, G1 1/4, G1 1/2, G2	-	-	-	-	-	-	-	-	-		
Soft-start valves, electrically actuated MS-DE		4	G1/8, G1/4	G1/8, G1/4, G3/8	-	-	-	-	-	■	-	■	■		
		6	G1/4, G3/8, G1/2	G1/4, G3/8, G1/2, G3/4	-	-	-	-	-	■	-	■	■		
		9	-												
		12	-	G1, G1 1/4, G1 1/2, G2	-	-	-	-	-	■	■	■	■		

Service unit combinations MSB, MS series

Product range overview – MS series service units

Type	Size	Bowl guard		Pressure indicator				Security			Options		→ Page/ Internet
		Plastic bowl with plastic bowl guard	Metal bowl	Cover plate (without pressure gauge)	Integrated MS pressure gauge	Adapter plate for EN pressure gauge G1/8	Adapter plate for EN pressure gauge G1/4	Pressure sensor	Rotary knob with detent, lockable via accessories	Rotary knob with integrated lock	Silencer	Flow direction from right to left	
Code		R	U	VS	AG	A8	A4	AD...	AS	E11	S	Z	
Individual devices													
Pressure regulators MS-LR	4	-	-	■	■	■	■	■	■	■	-	■	ms4-lr
	6	-	-	■	■	-	■	■	■	■	-	■	ms6-lr
	9	-	-	■	■	-	■	■	■	■	-	■	ms9-lr
	12	-	-	■	■	-	■	-	■	■	-	■	ms12-lr
Pressure regulators MS-LRB	4	-	-	■	■	■	■	■	■	■	-	■	ms4-lrb
	6	-	-	■	■	-	■	■	■	■	-	■	ms6-lrb
	9	-	-	-	-	-	-	-	-	-	-	-	-
	12	-	-	-	-	-	-	-	-	-	-	-	-
Precision pressure regulators MS-LRP	4	-	-	-	-	-	-	-	-	-	-	-	-
	6	-	-	■	-	■	■	■	■	■	-	■	ms6-lrp
	9	-	-	-	-	-	-	-	-	-	-	-	-
	12	-	-	-	-	-	-	-	-	-	-	-	-
Precision pressure regulators MS-LRPB	4	-	-	-	-	-	-	-	-	-	-	-	-
	6	-	-	■	-	■	■	■	■	■	-	■	ms6-lrpb
	9	-	-	-	-	-	-	-	-	-	-	-	-
	12	-	-	-	-	-	-	-	-	-	-	-	-
Electrical pressure regulators MS-LRE	4	-	-	-	-	-	-	-	-	-	-	-	-
	6	-	-	■	■	-	■	-	-	-	-	■	ms6-lre
	9	-	-	-	-	-	-	-	-	-	-	-	-
	12	-	-	-	-	-	-	-	-	-	-	-	-
Lubricators MS-LOE	4	■	■	-	-	-	-	-	-	-	-	■	ms4-loe
	6	■	■	-	-	-	-	-	-	-	-	■	ms6-loe
	9	-	■	-	-	-	-	-	-	-	-	■	ms9-loe
	12	-	■	-	-	-	-	-	-	-	-	■	ms12-loe
On-off valves, manually actuated MS-EM(1)	4	-	-	■	■	■	■	■	-	-	■	■	ms4-em1
	6	-	-	■	■	-	■	■	-	-	■	■	ms6-em1
	9	-	-	■	■	-	■	-	-	-	■	■	ms9-em
	12	-	-	■	■	-	■	-	-	-	■	■	ms12-em
On-off valves, electrically actuated MS-EE	4	-	-	■	■	■	■	■	-	-	■	■	ms4-ee
	6	-	-	■	■	-	■	■	-	-	■	■	ms6-ee
	9	-	-	■	■	-	■	■	-	-	■	■	ms9-ee
	12	-	-	■	■	-	■	-	-	-	■	■	ms12-ee
Soft-start valves, pneumatically actuated MS-DL	4	-	-	■	■	■	■	■	-	-	-	■	ms4-dl
	6	-	-	■	■	-	■	■	-	-	-	■	ms6-dl
	9	-	-	-	-	-	-	-	-	-	-	-	-
	12	-	-	■	■	-	■	-	-	-	-	■	ms12-dl
Soft-start valves, electrically actuated MS-DE	4	-	-	■	■	■	■	■	-	-	-	■	ms4-de
	6	-	-	■	■	-	■	■	-	-	-	■	ms6-de
	9	-	-	-	-	-	-	-	-	-	-	-	-
	12	-	-	■	■	-	■	-	-	-	-	■	ms12-de

Service unit combinations MSB, MS series

Product range overview – MS series service units



Type	Size	Pneumatic connection in housing	Connecting plate	Performance Level			Supply voltage				
				Category 1, 1-channel	Category 3, 2-channel	Category 4, 2-channel with self-monitoring	24 V DC, connection pattern to EN 175301	24 V DC, connection M12 to IEC 61076-2-101/ to EN 60947-5-2	110 V AC, connection pattern to EN 175301	230 V AC, connection pattern to EN 175301	
Code			AG.../AQ...	C	D	E	V24	V24P	V110	V230	
Individual devices											
Soft start and exhaust valves MS-SV-C		4	–								
		6	G $\frac{1}{2}$	G $\frac{1}{4}$, G $\frac{3}{8}$, G $\frac{1}{2}$, G $\frac{3}{4}$	■	–	–	■	■	■	■
		9	G $\frac{3}{4}$, G1	G $\frac{1}{2}$, G $\frac{3}{4}$, G1, G1 $\frac{1}{4}$, G1 $\frac{1}{2}$	■	–	–	■	■	■	■
		12	–								
Soft start and exhaust valves MS-SV-D		4	–								
		6	G $\frac{1}{2}$	G $\frac{1}{4}$, G $\frac{3}{8}$, G $\frac{1}{2}$, G $\frac{3}{4}$	–	■	–	■	■	–	–
		9	–								
		12	–								
Soft start and exhaust valves MS-SV-E		4	–								
		6	G $\frac{1}{2}$	G $\frac{1}{4}$, G $\frac{3}{8}$, G $\frac{1}{2}$, G $\frac{3}{4}$	–	–	■	■	–	–	–
		9	–								
		12	–								
Membrane air dryers MS-LDM1		4	G $\frac{1}{8}$, G $\frac{1}{4}$	G $\frac{1}{8}$, G $\frac{1}{4}$, G $\frac{3}{8}$	–	–	–	–	–	–	–
		6	G $\frac{1}{4}$, G $\frac{3}{8}$, G $\frac{1}{2}$	G $\frac{1}{4}$, G $\frac{3}{8}$, G $\frac{1}{2}$, G $\frac{3}{4}$	–	–	–	–	–	–	–
		9	–								
		12	–								
Branching modules MS-FRM		4	G $\frac{1}{8}$, G $\frac{1}{4}$	G $\frac{1}{8}$, G $\frac{1}{4}$, G $\frac{3}{8}$	–	–	–	–	–	–	–
		6	G $\frac{1}{4}$, G $\frac{3}{8}$, G $\frac{1}{2}$	G $\frac{1}{4}$, G $\frac{3}{8}$, G $\frac{1}{2}$, G $\frac{3}{4}$	–	–	–	–	–	–	–
		9	G $\frac{3}{4}$, G1	G $\frac{1}{2}$, G $\frac{3}{4}$, G1, G1 $\frac{1}{4}$, G1 $\frac{1}{2}$	–	–	–	–	–	–	–
		12	–	G1, G1 $\frac{1}{4}$, G1 $\frac{1}{2}$, G2	–	–	–	–	–	–	–
Distributor blocks MS-FRM-FRZ		4	G $\frac{1}{4}$	–	–	–	–	–	–	–	–
		6	G $\frac{1}{2}$	–	–	–	–	–	–	–	–
		9	–								
		12	–								
Flow sensors SFAM		4	–								
		6	G $\frac{1}{2}$	G $\frac{1}{2}$	–	–	–	–	–	–	–
		9	–	G1, G1 $\frac{1}{2}$	–	–	–	–	–	–	–
		12	–								

Service unit combinations MSB, MS series

Product range overview – MS series service units

Type	Size	Bowl guard		Pressure indicator					Switch output			Options		→ Page/ Internet
		Plastic bowl with plastic bowl guard	Metal bowl	Cover plate (without pressure gauge)	Integrated MS pressure gauge	Adapter plate for EN pressure gauge G1/8	Adapter plate for EN pressure gauge G1/4	Pressure sensor	2x PNP or NPN, 1 analogue output 4 ... 20 mA	2x PNP or NPN, 1 analogue output 0 ... 10 V	Silencer	Flow direction from right to left		
Code		R	U	VS	AG	A8	A4	AD...	2SA	2SV	S	Z/R		
Individual devices														
Soft start and exhaust valves MS-SV-C	4	-												
	6	-	-	■	■	-	■	■	-	-	■	■	ms6-sv	
	9	-	-	■	■	-	■	■	-	-	■	■	ms9-sv	
	12	-											-	
Soft start and exhaust valves MS-SV-D	4	-											-	
	6	-	-	■	■	-	■	■	-	-	■	■	ms6-sv	
	9	-											-	
	12	-											-	
Soft start and exhaust valves MS-SV-E	4	-											-	
	6	-	-	■	■	-	■	■	-	-	■	■	ms6-sv	
	9	-											-	
	12	-											-	
Membrane air dryers MS-LDM1	4	-	■	-	-	-	-	-	-	-	-	■	ms4-ldm1	
	6	-	■	-	-	-	-	-	-	-	-	■	ms6-ldm1	
	9	-											-	
	12	-											-	
Branching modules MS-FRM	4	-	-	■	■	■	■	■	-	-	-	■	ms4-frm	
	6	-	-	■	■	-	■	■	-	-	-	■	ms6-frm	
	9	-	-	■	■	-	■	■	-	-	-	■	ms9-frm	
	12	-	-	■	-	-	-	-	-	-	-	-	ms12-frm	
Distributor blocks MS-FRM-FRZ	4	-	-	-	-	-	-	-	-	-	-	■	ms4-frm	
	6	-	-	-	-	-	-	-	-	-	-	■	ms6-frm	
	9	-											-	
	12	-											-	
Flow sensors SFAM	4	-											-	
	6	-	-	-	-	-	-	-	■	■	-	■	sfam-62	
	9	-	-	-	-	-	-	-	■	■	-	■	sfam-90	
	12	-											-	

Service unit combinations MSB4/MSB6, MS series

Product range overview

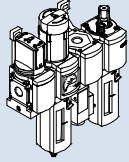
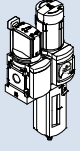
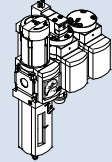
Combinations	Combination 1		Combination 2		Combination 3	
						
Comprising:						
Manually operated on-off valve	EM1	■	■	■	-	-
Filter regulator with pressure gauge, lockable	LFR	■	■	■	■	■
Lubricator	LOE	■	-	-	-	-
Solenoid actuated on-off valve	EE	-	-	-	■	■
Solenoid actuated on-off valve, with pressure sensor	EE	-	-	-	-	-
Pneumatically actuated soft-start valve	DL	-	-	-	■	■
Branching module with pressure switch	FRM	■	-	-	-	-
Branching module with pressure sensor	FRM	-	-	-	-	-
Mounting bracket	WP	■	■	■	■	■
Type codes → Page		10	10	10	10	10
Technical data → Page		11	14	14	17	17

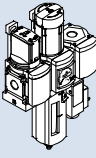
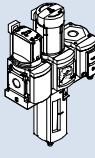
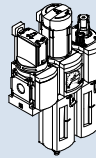
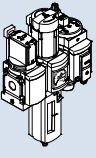
Combinations	Combination 4		Combination 5		Combination 6		Combination 7	
								
Comprising:								
Manually operated on-off valve	EM1	■	■	■	■	■	■	■
Filter regulator with pressure gauge, lockable	LFR	■	■	■	■	■	■	■
Lubricator	LOE	-	-	-	■	-	-	-
Solenoid actuated on-off valve	EE	-	-	■	-	-	-	-
Solenoid actuated on-off valve, with pressure sensor	EE	-	-	-	-	-	■	■
Pneumatically actuated soft-start valve	DL	-	-	■	-	-	-	-
Branching module with pressure switch	FRM	■	-	■	-	-	-	-
Branching module with pressure sensor	FRM	-	■	-	-	-	-	-
Mounting bracket	WP	■	■	■	■	■	■	■
Type codes → Page		10	10	10	10	10	10	10
Technical data → Page		20	20	24	27	27	30	30

Service unit combinations MSB4/MSB6, MS series

Peripherals overview

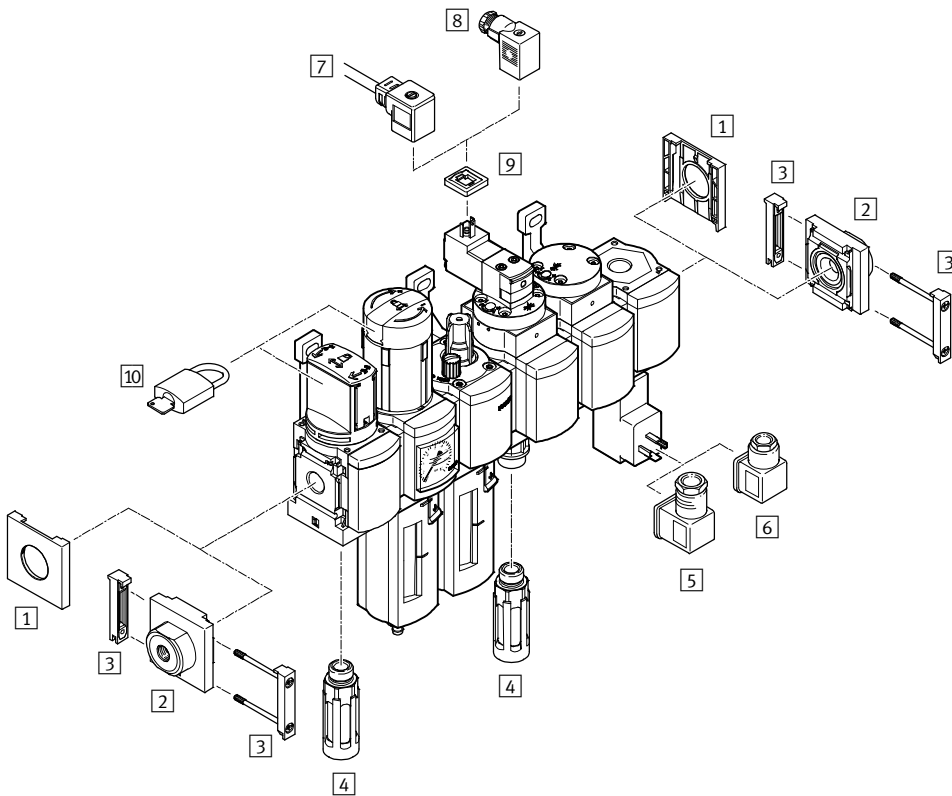

- - Note
 The choice of accessories depends on the selected service unit combination.
 Range of accessories
 → Peripherals pages of the individual devices

Mounting attachments and accessories		→ Page/Internet
1	Cover cap MS4/6-END	ms4-end, ms6-end
2	Connecting plate-SET MS4/6-AG...	ms4-ag, ms6-ag
3	Module connector MS4/6-MV	ms4-mv, ms6-mv
4	Silencer U	33
5	Angled socket PEV-1/4-WD-LED	33
6	Plug socket MSSD-C-4P	33
7	Plug socket with cable KMEB	33
8	Plug socket MSSD-EB	33
9	Illuminating seal MEB-LD	33
10	Padlock LRVS-D	33
-	Mounting bracket MS4/6-WP/WPB/WPE/WPM	ms4-wp, ms6-wp

Service unit combinations MSB4/MSB6, MS series

Type codes

MSB		6	-	1/2	:	C3	J1	D1	A1	F3	-	WP
Series												
MSB	Service unit combination											
Size												
4	Grid dimension 40 mm											
6	Grid dimension 62 mm											
Pneumatic connection												
MSB4												
1/4	Thread G1/4											
MSB6												
1/2	Thread G1/2											
Service unit combination												
On-off valve		→ Internet: ms4-em1, ms6-em1										
C3	MS...-EM1											
Filter regulator		→ Internet: ms4-lfr, ms6-lfr										
J1	MS...-LFR-D7-ERM-AS											
J2	MS...-LFR-D7-ERV-AS											
J3	MS...-LFR-D7-CRM-AS											
J4	MS...-LFR-D7-CRV-AS											
J120	MS...-LFR-D6-ERM-MPAAS											
Soft-start valve		→ Internet: ms4-dl, ms6-dl										
A1	MS...-DL											
Lubricator		→ Internet: ms4-loe, ms6-loe										
M1	MS...-LOE-R											
On-off valve		→ Internet: ms4-ee, ms6-ee										
D1	MS...-EE-V24											
D14	MS...-EE-10V24P-AD7											
Branching module		→ Internet: ms4-frm, ms6-frm										
F3	MS...-FRM-Y											
F12	MS...-FRM-AD7											
Type of mounting												
WP	Mounting bracket											

Further variants can be ordered using the modular system → www.festo.com

- Connection size
- Connecting plates
- Service unit equipment
- Alternative flow direction

Service unit combinations MSB4/MSB6, MS series

Technical data – Combination 1

Function
With condensate drain
manual rotary

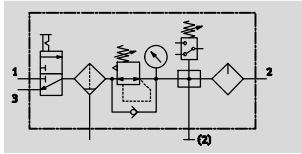

- On-off valve MS...-EM1 manually actuated
- Filter regulator MS...-LFR-D7 with pressure gauge
- Branching module MS...-FRM-Y with pressure switch without display
- Lubricator MS...-LOE-R
- Mounting bracket MS...-WP

- - Flow rate
950 l/min
- - Temperature range
-10 ... +60 °C
- - Pressure regulation range
1 ... 12 bar
- - www.festo.com



- For filtered and lubricated compressed air
- Supply pressure can be opened and closed
- Output pressure is infinitely adjustable within the pressure regulation range
- The unit is vented when switched off
- Electrical pressure monitoring with adjustable switching pressure
- Removal of filtered and unlubricated compressed air at the branching module connections

General technical data	
Size	MSB4
Pneumatic connection 1, 2, 3	G $\frac{1}{4}$
Regulating function	Output pressure constant, with primary pressure compensation, with return flow function, with secondary venting
Type of mounting	Via accessories
Assembly position	Vertical $\pm 5^\circ$
Grade of filtration [μm]	40
Air purity class at the output	Compressed air in accordance with ISO 8573-1:2010 [7:4:4] (grade of filtration 40 μm)
Bowl guard	Plastic bowl guard
Condensate drain	Manual rotary
Actuator lock	Rotary knob with detent, lockable with accessories
Pressure regulation range [bar]	1 ... 12
Pressure indicator	With pressure gauge

- - Note: This product conforms to ISO 1179-1 and to ISO 228-1

Standard nominal flow rate qnN [l/min]	
Size	MSB4
Grade of filtration	40 μm 950

Service unit combinations MSB4/MSB6, MS series

Technical data – Combination 1

Operating and environmental conditions	
Condensate drain	Manual rotary
Size	MSB4
Operating pressure [bar]	1.5 ... 14
Operating medium	Compressed air in accordance with ISO 8573-1:2010 [7:4:4]
	Inert gases
Note on operating/pilot medium	Operation with lubricated medium possible (in which case lubricated operation will always be required)
Ambient temperature [°C]	-10 ... +60
Temperature of medium [°C]	-10 ... +60
Storage temperature [°C]	-10 ... +60
Corrosion resistance CRC ¹⁾	2

1) Corrosion resistance class CRC 2 to Festo standard FN 940070
 Moderate corrosion stress. Indoor applications in which condensation may occur. External visible parts with primarily decorative requirements for the surface and which are in direct contact with the ambient atmosphere typical for industrial applications.

Weights [g]	
Size	MSB4
Service unit combination	1,700
Mounting bracket	40

-  - Note
 Materials → Technical data of the individual devices

Standard flow rate qn as a function of output pressure p2

Pressure regulation range 1 ... 12 bar Grade of filtration 40 µm
 MSB4-1/4

Primary pressure p1 = 10 bar

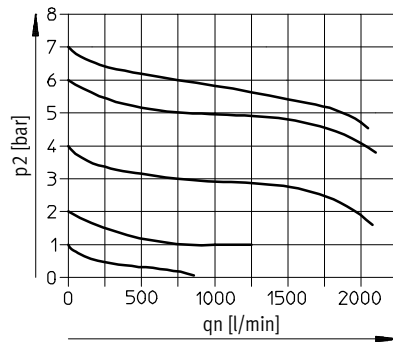

Service unit combinations MSB4/MSB6, MS series

Technical data – Combination 1

Dimensions

Download CAD data → www.festo.com

Manually actuated on-off valve, filter regulator with pressure gauge, branching module with pressure switch, lubricator

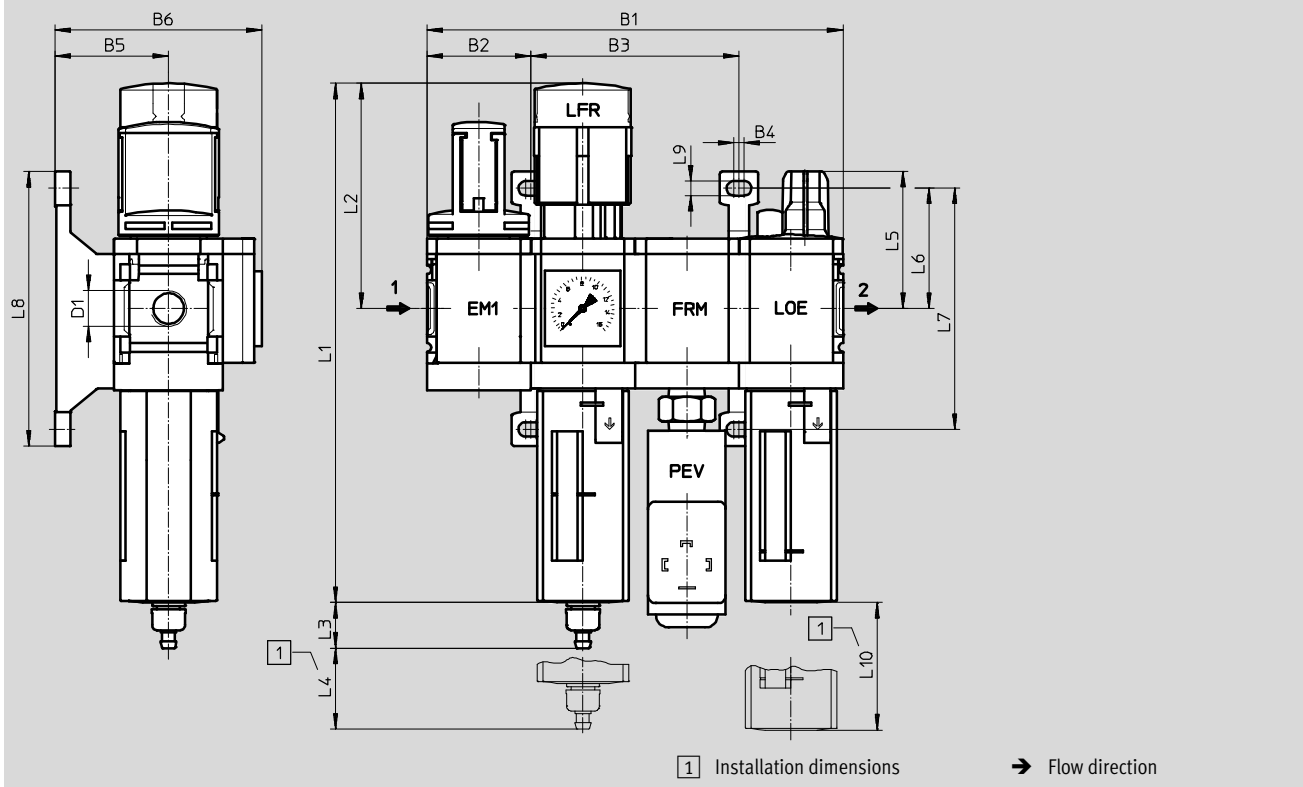

Type	B1	B2	B3	B4	B5	B6	D1	L1	L2
MSB4	160.8	40.2	80.4	4	44	80	G $\frac{1}{4}$	201	87

Type	L3	L4	L5	L6	L7	L8	L9	L10
MSB4	17.7	25	53	46.5	93.2	106	5.6	80

• • Note: This product conforms to ISO 1179-1 and to ISO 228-1

Ordering data

Size	Condensate drain	Connection	Grade of filtration 40 μ m
			Part No. Type
Pressure regulation range 1 ... 12 bar, pressure gauge with outer scale in bar and inner scale in psi			
MSB4	manual rotary	G $\frac{1}{4}$	542295 MSB4-$\frac{1}{4}$:C3J1F3M1-WP

Service unit combinations MSB4/MSB6, MS series

Technical data – Combination 2



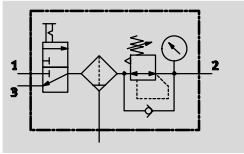

Function

With condensate drain
manual rotary

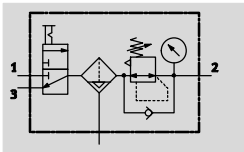

With condensate drain
fully automatic



-  Flow rate
950 ... 5,500 l/min
-  Temperature range
-10 ... +60 °C
-  Pressure regulation
range
0.5 ... 12 bar
-  www.festo.com



- For filtered and unlubricated compressed air
- Supply pressure can be opened and closed
- Output pressure is infinitely adjustable within the pressure regulation range

- On-off valve MS...-EM1 manually actuated
- Filter regulator MS...-LFR with pressure gauge
- Mounting bracket MS...-WP

General technical data		
Size	MSB4	MSB6
Pneumatic connection 1, 2, 3	G $\frac{1}{4}$	G $\frac{1}{2}$
Regulating function	Output pressure constant, with primary pressure compensation, with return flow function, with secondary venting	
Type of mounting	Via accessories	
Assembly position	Vertical $\pm 5^\circ$	
Grade of filtration $[\mu\text{m}]$	5	
	40	
Air purity class at the output	Compressed air in accordance with ISO 8573-1:2010 [6:4:4] (grade of filtration 5 μm)	
	Compressed air in accordance with ISO 8573-1:2010 [7:4:4] (grade of filtration 40 μm)	
Bowl guard	Plastic bowl guard	
Condensate drain	Manual rotary	
	Fully automatic	
Actuator lock	Rotary knob with detent, lockable with accessories	
Pressure regulation range [bar]	0.5 ... 7	
	0.5 ... 12	
Pressure indicator	With pressure gauge	

-  Note: This product conforms to ISO 1179-1 and to ISO 228-1

Standard nominal flow rate q_{nN} [l/min]					
Condensate drain	Manual rotary			Fully automatic	
	MSB4	MSB6	MSB4	MSB6	
Pressure regulation range 0.5 ... 7 bar					
Grade of filtration	40 μm	1,150	5,500	-	-
Pressure regulation range 0.5 ... 12 bar					
Grade of filtration	5 μm	950	4,800	950	4,800
	40 μm	1,700	5,100	1,000	5,100

Service unit combinations MSB4/MSB6, MS series

Technical data – Combination 2

Operating and environmental conditions				
Condensate drain	Manual rotary		Fully automatic	
Size	MSB4	MSB6	MSB4	MSB6
Operating pressure [bar]	0.8 ... 14	0.8 ... 18	2 ... 12	2 ... 12
Operating medium	Compressed air in accordance with ISO 8573-1:2010 [7:4:4] Inert gases			
Note on operating/pilot medium	Operation with lubricated medium possible (in which case lubricated operation will always be required)			
Ambient temperature [°C]	-10 ... +60		+5 ... +60	
Temperature of medium [°C]	-10 ... +60		+5 ... +60	
Storage temperature [°C]	-10 ... +60		-10 ... +60	
Corrosion resistance CRC ¹⁾	2			

1) Corrosion resistance class CRC 2 to Festo standard FN 940070

Moderate corrosion stress. Indoor applications in which condensation may occur. External visible parts with primarily decorative requirements for the surface and which are in direct contact with the ambient atmosphere typical for industrial applications.

Weights [g]		
Size	MSB4	MSB6
Service unit combination	1,300	1,100
Mounting bracket	40	76

 Note

Materials → Technical data of the individual devices

Standard flow rate q_n as a function of output pressure p_2

Pressure regulation range 0.5 ... 12 bar Grade of filtration 5 μm

Grade of filtration 40 μm

MSB4-1/4

Primary pressure $p_1 = 10$ bar

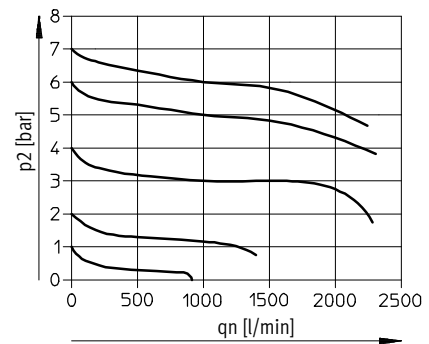
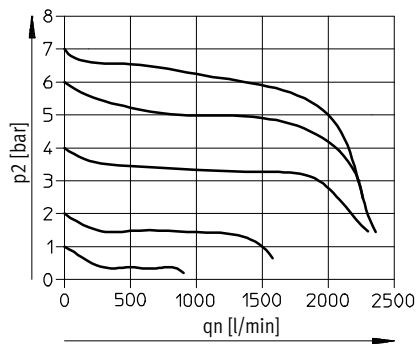

MSB6-1/2

Primary pressure $p_1 = 10$ bar

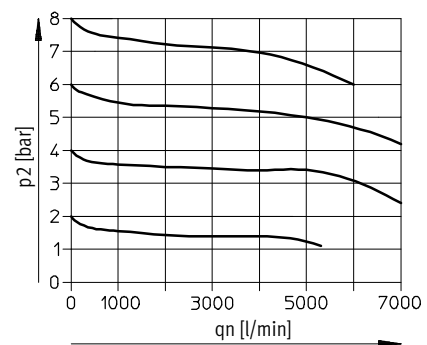
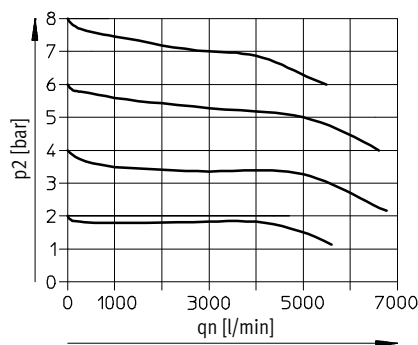

Service unit combinations MSB4/MSB6, MS series

Technical data – Combination 2

Dimensions

Download CAD data → www.festo.com

Manually actuated on-off valve, filter regulator with pressure gauge

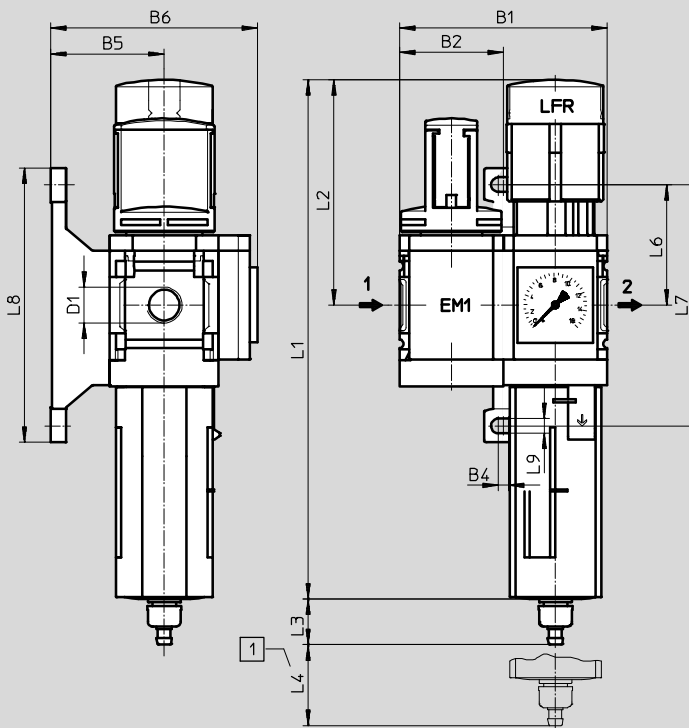

1 Installation dimensions

→ Flow direction

Type	B1	B2	B4	B5	B6	D1	L1	L2
MSB4	80.4	40.2	4	44	80	G $\frac{1}{4}$	201	87
MSB6	124	62	4.5	54	100	G $\frac{1}{2}$	285	134.5

Type	L3 Condensate drain		L4	L6	L7	L8	L9
	manual rotary	fully automatic					
MSB4	17.7	20.4	25	46.5	93.2	106	5.6
MSB6	15.8	18.5	68	71	142	158	6.6

– Note: This product conforms to ISO 1179-1 and to ISO 228-1

Ordering data

Size	Condensate drain	Connection	Grade of filtration 5 μ m		Grade of filtration 40 μ m	
			Part No.	Type	Part No.	Type
Pressure regulation range 0.5 ... 7 bar, pressure gauge with outer scale in MPa						
MSB4	manual rotary	G $\frac{1}{4}$	–	–	8042668	MSB4- $\frac{1}{4}$:C3J120-WP
MSB6	manual rotary	G $\frac{1}{2}$	–	–	8042672	MSB6- $\frac{1}{2}$:C3J120-WP
Pressure regulation range 0.5 ... 12 bar, pressure gauge with outer scale in bar and inner scale in psi						
MSB4	manual rotary	G $\frac{1}{4}$	542304	MSB4- $\frac{1}{4}$:C3J3-WP	8025354	MSB4- $\frac{1}{4}$:C3J1-WP
	fully automatic	G $\frac{1}{4}$	542310	MSB4- $\frac{1}{4}$:C3J4-WP	542298	MSB4- $\frac{1}{4}$:C3J2-WP
MSB6	manual rotary	G $\frac{1}{2}$	542280	MSB6- $\frac{1}{2}$:C3J3-WP	8025355	MSB6- $\frac{1}{2}$:C3J1-WP
	fully automatic	G $\frac{1}{2}$	542286	MSB6- $\frac{1}{2}$:C3J4-WP	542274	MSB6- $\frac{1}{2}$:C3J2-WP

Service unit combinations MSB4/MSB6, MS series

Technical data – Combination 3



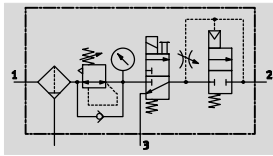

Function

With condensate drain
manual rotary

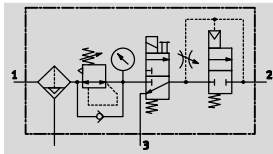

With condensate drain
fully automatic



-  Flow rate
750 ... 3,100 l/min
-  Temperature range
-10 ... +60 °C
-  Pressure regulation range
4 ... 12 bar
-  www.festo.com



- Filter regulator MS...-LFR-D7 with pressure gauge
- On-off valve MS...-EE-V24 solenoid actuated
- Soft-start valve MS...-DL pneumatically actuated
- Mounting bracket MS...-WP

- For filtered and unlubricated compressed air
- Output pressure is infinitely adjustable within the pressure regulation range
- Gradual pressure build-up prevents sudden, unpredictable movements
- When supply pressure is closed, quick venting ensures rapid pressure reduction

General technical data		
Size	MSB4	MSB6
Pneumatic connection 1, 2, 3	G1/4	G1/2
Regulating function	Output pressure constant, with primary pressure compensation, with return flow function, with secondary venting	
Type of mounting	Via accessories	
Assembly position	Vertical ±5°	
Grade of filtration [µm]	40	
Air purity class at the output	Compressed air in accordance with ISO 8573-1:2010 [7:4:-] (grade of filtration 40 µm)	
Bowl guard	Plastic bowl guard	
Condensate drain	Manual rotary	
	-	Fully automatic
Actuator lock	Rotary knob with detent, lockable with accessories	
Pressure regulation range [bar]	4 ... 12	
Pressure indicator	With pressure gauge	
Coil characteristics	24 V DC: 1.5 W	24 V DC: 1.5 W

- | - Note: This product conforms to ISO 1179-1 and to ISO 228-1

Standard nominal flow rate qnN [l/min]		
Size	MSB4	MSB6
Grade of filtration 40 µm	750	3,100

Service unit combinations MSB4/MSB6, MS series

Technical data – Combination 3

Operating and environmental conditions				
Condensate drain		Manual rotary		Fully automatic
Size	MSB4	MSB6	MSB6	
Operating pressure [bar]	4.5 ... 14	4.5 ... 18	4.5 ... 12	
Operating medium	Compressed air in accordance with ISO 8573-1:2010 [-:4:-]		Compressed air in accordance with ISO 8573-1:2010 [7:4:-]	
	Inert gases			
Note on operating/pilot medium	Operation with lubricated medium possible (in which case lubricated operation will always be required)			
Ambient temperature [°C]	-10 ... +60		+5 ... +60	
Temperature of medium [°C]	-10 ... +60		+5 ... +60	
Storage temperature [°C]	-10 ... +60		-10 ... +60	
Corrosion resistance CRC ¹⁾	2			

1) Corrosion resistance class CRC 2 to Festo standard FN 940070
 Moderate corrosion stress. Indoor applications in which condensation may occur. External visible parts with primarily decorative requirements for the surface and which are in direct contact with the ambient atmosphere typical for industrial applications.

Weights [g]		
Size	MSB4	MSB6
Service unit combination	1,600	2,400
Mounting bracket	40	76

-  - Note
 Materials → Technical data of the individual devices

Standard flow rate qn as a function of output pressure p2

Pressure regulation range 4 ... 12 bar
 Grade of filtration 40 µm
 MSB4-1/4

Primary pressure p1 = 10 bar

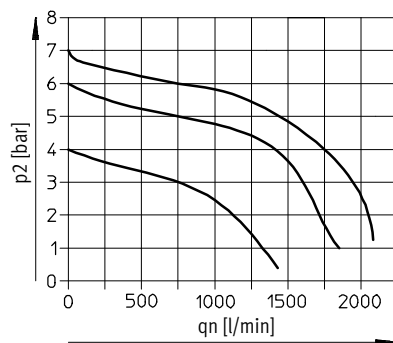

MSB6-1/2

Primary pressure p1 = 10 bar

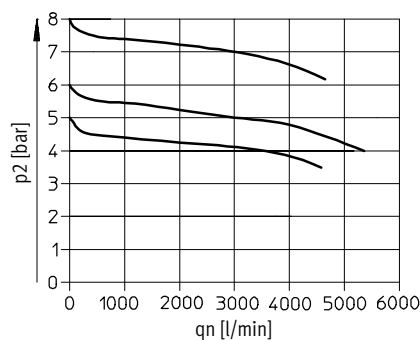

Service unit combinations MSB4/MSB6, MS series

Technical data – Combination 3

Dimensions Download CAD data → www.festo.com

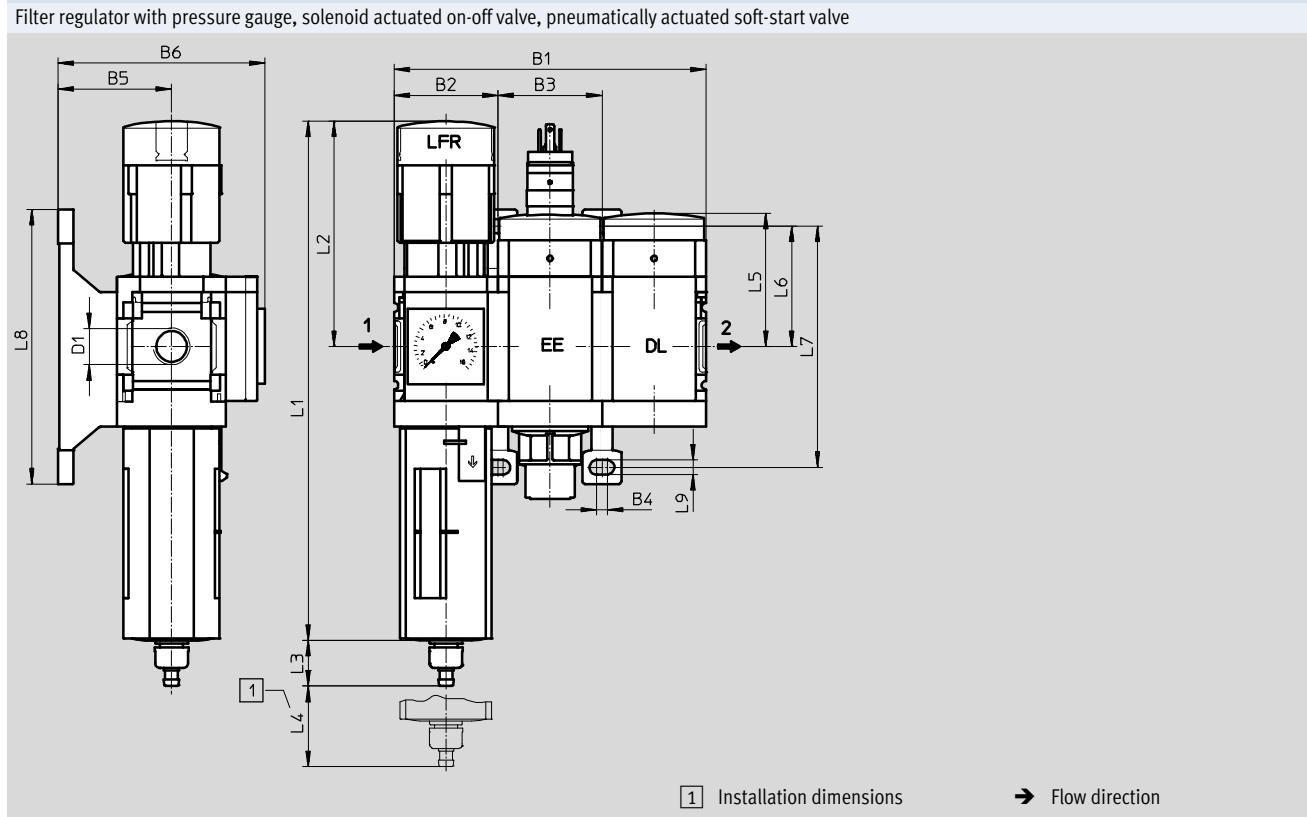

Type	B1	B2	B3	B4	B5	B6	D1	L1	L2
MSB4	120.6	40.2	40.2	4	44	80	G $\frac{1}{4}$	201	87
MSB6	186	62	62	4.5	54	100	G $\frac{1}{2}$	285	134.5

Type	L3 Condensate drain		L4	L5	L6	L7	L8	L9
	manual rotary	fully automatic						
MSB4	17.7	–	25	51.7	46.5	93.2	106	5.6
MSB6	15.8	18.5	68	71	71	142	158	6.6

Note: This product conforms to ISO 1179-1 and to ISO 228-1

Ordering data			
Size	Condensate drain	Connection	Grade of filtration 40 μ m
			Part No. Type
Pressure regulation range 4 ... 12 bar, pressure gauge with outer scale in bar and inner scale in psi			
MSB4	manual rotary	G $\frac{1}{4}$	531101 MSB4-$\frac{1}{4}$:J1D1A1-WP
MSB6	manual rotary	G $\frac{1}{2}$	530222 MSB6-$\frac{1}{2}$:J1D1A1-WP
	fully automatic	G $\frac{1}{2}$	530224 MSB6-$\frac{1}{2}$:J2D1A1-WP

Service unit combinations MSB4/MSB6, MS series

Technical data – Combination 4

Function
With condensate drain,
manual rotary

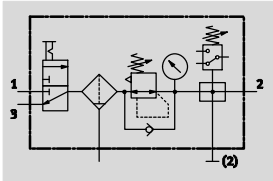

With condensate drain,
fully automatic

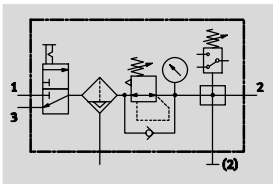

- - Flow rate
1,300 ... 5,300 l/min
- - Temperature range
-10 ... +60 °C
- - Pressure regulation range
0.5 ... 12 bar
- - www.festo.com



- Manually operated on-off valve MS...-EM1
- Filter regulator MS...-LFR with pressure gauge

- Branching module MS...-FRM-Y with pressure switch or MS...-FRM-AD7 with pressure sensor for displaying output pressure via operational status indicator
- Mounting bracket MS...-WP

- For filtered and unlubricated compressed air supply
- Supply pressure can be opened and closed
- Output pressure is infinitely adjustable within the pressure regulation range
- Electrical pressure monitoring with adjustable switching pressure

General technical data				
Size	MSB4		MSB6	
Branching module with	Pressure switch	Pressure sensor	Pressure switch	Pressure sensor
Pneumatic connection 1, 2, 3	G1/4		G1/2	
Regulator function	Output pressure constant, with primary pressure compensation, with return flow, with secondary venting			
Type of mounting	Via accessories			
Mounting position	Vertical ±5°			
Grade of filtration [µm]	40			
Air purity class at the output	Compressed air according to ISO 8573-1:2010 [7:4:4] (grade of filtration 40 µm)			
Bowl guard	Plastic bowl guard			
Condensate drain	Manual rotary	Manual rotary	Manual rotary	Manual rotary
	Fully automatic	–	Fully automatic	–
Actuation security	Rotary knob with detent, can be locked using accessories			
Pressure regulation range [bar]	–	0.5 ... 7	–	0.5 ... 7
	0.5 ... 12	0.5 ... 10	0.5 ... 12	0.5 ... 10
Pressure indication	Via pressure gauge for displaying output pressure			

• Note: This product conforms to ISO 1179-1 and to ISO 228-1

Standard nominal flow rate qnN [l/min]				
Size	MSB4		MSB6	
Branching module with	Pressure switch	Pressure sensor	Pressure switch	Pressure sensor
Pressure regulation range 0.5 ... 7 bar				
Grade of filtration 40 µm	–	1,750	–	5,300
Pressure regulation range 0.5 ... 10 bar				
Grade of filtration 40 µm	–	1,600	–	4,500
Pressure regulation range 0.5 ... 12 bar				
Grade of filtration 40 µm	1,300	–	4,500	–

Service unit combinations MSB4/MSB6, MS series

Technical data – Combination 4

Operating and environmental conditions						
Condensate drain	Manual rotary				Fully automatic	
Size	MSB4		MSB6		MSB4	MSB6
Branching module with	Pressure switch	Pressure sensor	Pressure switch	Pressure sensor	Pressure switch	Pressure switch
Operating pressure [bar]	0.8 ... 14		0.8 ... 18		2 ... 12	2 ... 12
Operating medium	Compressed air according to ISO 8573-1:2010 [7:4:4] Inert gases					
Note on operating/ pilot medium	Lubricated operation possible (in which case lubricated operation will always be required)					
Ambient temperature [°C]	-10 ... +60	0 ... +50	-10 ... +60	0 ... +50	+5 ... +60	
Temperature of medium [°C]	-10 ... +60	0 ... +50	-10 ... +60	0 ... +50	+5 ... +60	
Storage temperature [°C]	-10 ... +60				-10 ... +60	
Corrosion resistance class CRC ¹⁾	2					

1) Corrosion resistance class CRC 2 to Festo standard FN 940070

Moderate corrosion stress. Indoor applications in which condensation may occur. External visible parts with primarily decorative requirements for the surface and which are in direct contact with the ambient atmosphere typical for industrial applications.

Weight [g]		
Size	MSB4	MSB6
Service unit combination	1,500	2,000
Mounting bracket	40	76

 Note
Materials → Technical data of the individual devices

Standard flow rate q_n as a function of output pressure p_2

Pressure regulation range 0.5 ... 12 bar Grade of filtration 40 μm
MSB4-1/4

Primary pressure $p_1 = 10$ bar

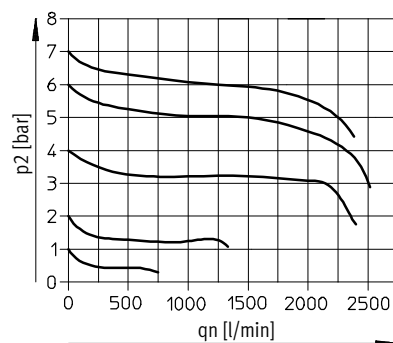

MSB6-1/2

Primary pressure $p_1 = 10$ bar

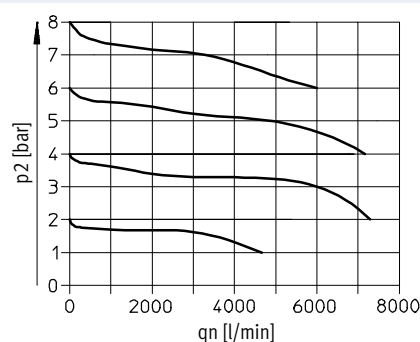

Service unit combinations MSB4/MSB6, MS series

Technical data – Combination 4

Dimensions

Download CAD data → www.festo.com

Manually actuated on-off valve, filter regulator with pressure gauge, branching module with pressure switch

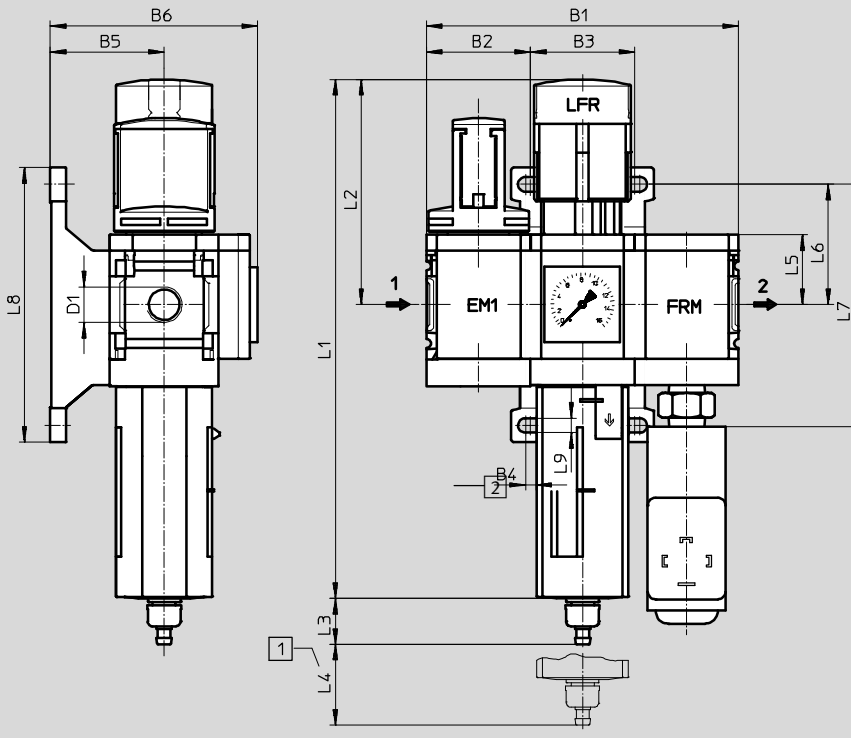

- 1 Installation dimensions
- 2 Pressure switch PEV-1/4-B-0D with adjustable pressure switching point; plug, square design to EN 175 301, type A
→ Internet: pev

→ Flow direction

Type	B1	B2	B3	B4	B5	B6	D1	L1	L2
MSB4	120.6	40.2	40.2	4	44	80	G1/4	201	87
MSB6	186	62	62	4.5	54	100	G1/2	285	134.5

Type	L3 Condensate drain		L4	L5	L6	L7	L8	L9
	Manual rotary	Fully automatic						
MSB4	17.7	20.4	25	27	46.5	93.2	106	5.6
MSB6	15.8	18.5	68	39	71	142	158	6.6

Note: This product conforms to ISO 1179-1 and to ISO 228-1

Service unit combinations MSB4/MSB6, MS series

Technical data – Combination 4

FESTO

Dimensions

Download CAD data → www.festo.com

Manually actuated on-off valve, filter regulator with pressure gauge, branching module with pressure sensor

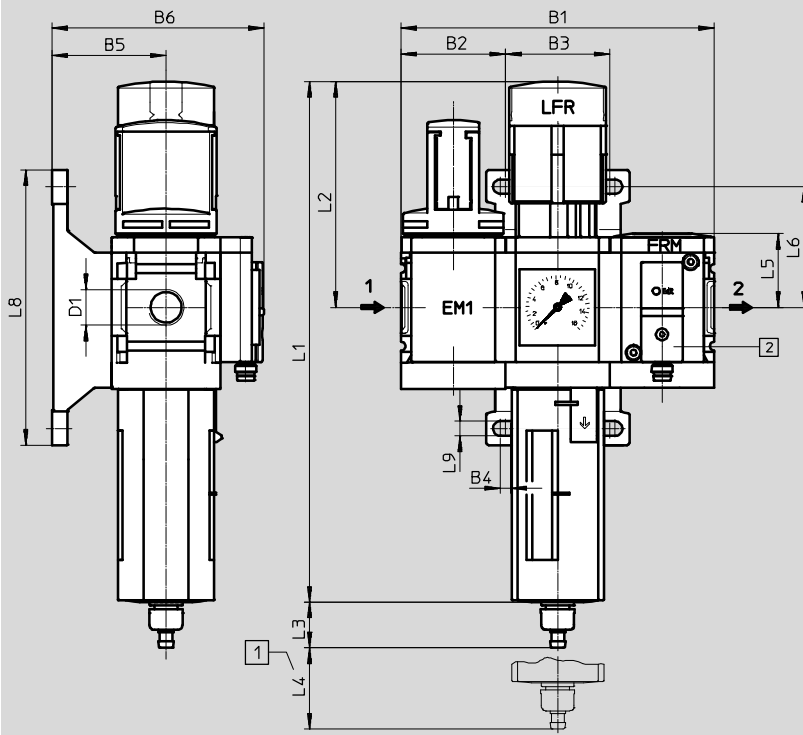

- 1 Installation dimensions
- 2 Pressure sensor
SDE5-D10-O-...-P-M8 with
3-pin plug M8x1, threshold
value comparator, 1 switching
output PNP, N/O contact
→ Internet: sde5



→ Flow direction

Type	B1	B2	B3	B4	B5	B6	D1
MSB4	120.6	40.2	40.2	4	44	82	G $\frac{1}{4}$
MSB6	186	62	62	4.5	54	102	G $\frac{1}{2}$

Type	L1	L2	L3	L4	L5	L6	L8	L9
MSB4	201	87	17.7	25	29.4	46.5	106	5.6
MSB6	285	134.5	15.8	68	41.7	71	158	6.6

–||– Note: This product conforms to ISO 1179-1 and to ISO 228-1

Ordering data

Size	Condensate drain	Connection	Grade of filtration 40 μ m		Branching module with pressure sensor	
			Part No.	Type	Part No.	Type
Pressure regulation range 0.5 ... 7 bar, pressure gauge with outer scale in MPa						
MSB4	Manual rotary	G $\frac{1}{4}$	–	–	8042667	MSB4- $\frac{1}{4}$:C3:J120:F12-WP 
MSB6	Manual rotary	G $\frac{1}{2}$	–	–	8042671	MSB6- $\frac{1}{2}$:C3:J120:F12-WP 
Pressure regulation range 0.5 ... 10 bar, pressure gauge with outer scale in bar and inner scale in psi						
MSB4	Manual rotary	G $\frac{1}{4}$	–	–	8025356	MSB4- $\frac{1}{4}$:C3:J1:F12-WP
MSB6	Manual rotary	G $\frac{1}{2}$	–	–	8025357	MSB6- $\frac{1}{2}$:C3:J1:F12-WP
Pressure regulation range 0.5 ... 12 bar, pressure gauge with outer scale in bar and inner scale in psi						
MSB4	Manual rotary	G $\frac{1}{4}$	542294	MSB4- $\frac{1}{4}$:C3:J1F3-WP	–	–
	Fully automatic	G $\frac{1}{4}$	542300	MSB4- $\frac{1}{4}$:C3:J2F3-WP	–	–
MSB6	Manual rotary	G $\frac{1}{2}$	542270	MSB6- $\frac{1}{2}$:C3:J1F3-WP	–	–
	Fully automatic	G $\frac{1}{2}$	542276	MSB6- $\frac{1}{2}$:C3:J2F3-WP	–	–

Service unit combinations MSB4/MSB6, MS series

Technical data – Combination 5

Function

With condensate drain
manual rotary

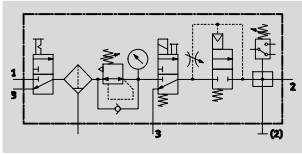

With condensate drain
fully automatic

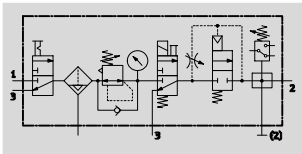

- - Flow rate
750 ... 3,100 l/min
- - Temperature range
-10 ... +60 °C
- - Pressure regulation
range
4 ... 12 bar
- - www.festo.com



- On-off valve MS...-EM1 manually actuated
- Filter regulator MS...-LFR-D7 with pressure gauge
- On-off valve MS...-EE-V24 solenoid actuated
- Soft-start valve MS...-DL pneumatically actuated
- Branching module MS...-FRM-Y with pressure switch without display
- Mounting bracket MS...-WP

- For filtered and unlubricated compressed air
- Supply pressure can be opened and closed
- Output pressure is infinitely adjustable within the pressure regulation range
- Gradual pressure build-up prevents sudden, unpredictable movements
- To shut-off and vent the following device or the system
- Electrical pressure monitoring with adjustable switching pressure

General technical data		
Size	MSB4	MSB6
Pneumatic connection 1, 2, 3	G1/4	G1/2
Regulating function	Output pressure constant, with primary pressure compensation, with return flow function, with secondary venting	
Type of mounting	Via accessories	
Assembly position	Vertical ±5°	
Grade of filtration [µm]	- 40	5
Air purity class at the output	Compressed air in accordance with ISO 8573-1:2010 [6:4:4] (grade of filtration 5 µm) Compressed air in accordance with ISO 8573-1:2010 [7:4:4] (grade of filtration 40 µm)	
Bowl guard	Plastic bowl guard	
Condensate drain	Manual rotary Fully automatic	
Actuator lock	Rotary knob with detent, lockable with accessories	
Pressure regulation range [bar]	4 ... 12	
Pressure indicator	With pressure gauge	
Coil characteristics	24 V DC: 1.5 W	24 V DC: 1.5 W

- - Note: This product conforms to ISO 1179-1 and to ISO 228-1

Standard nominal flow rate qnN [l/min]		
Size	MSB4	MSB6
Grade of filtration 5 µm	-	3,000
40 µm	750	3,100

Service unit combinations MSB4/MSB6, MS series

Technical data – Combination 5

Operating and environmental conditions				
Condensate drain	Manual rotary		Fully automatic	
Size	MSB4	MSB6	MSB4	MSB6
Operating pressure [bar]	4.5 ... 14	4.5 ... 18	4.5 ... 12	4.5 ... 12
Operating medium	Compressed air in accordance with ISO 8573-1:2010 [7:4:4]			
	Inert gases			
Note on operating/pilot medium	Operation with lubricated medium possible (in which case lubricated operation will always be required)			
Ambient temperature [°C]	-10 ... +60		+5 ... +60	
Temperature of medium [°C]	-10 ... +60		+5 ... +60	
Storage temperature [°C]	-10 ... +60		-10 ... +60	
Corrosion resistance CRC ¹⁾	2			

1) Corrosion resistance class CRC 2 to Festo standard FN 940070
 Moderate corrosion stress. Indoor applications in which condensation may occur. External visible parts with primarily decorative requirements for the surface and which are in direct contact with the ambient atmosphere typical for industrial applications.

Weights [g]		
Size	MSB4	MSB6
Service unit combination	2,200	3,500
Mounting bracket	40	76

 Note
 Materials → Technical data of the individual devices

Standard flow rate q_n as a function of output pressure p_2
 Pressure regulation range 4 ... 12 bar
 MSB4-1/4

Primary pressure $p_1 = 10$ bar

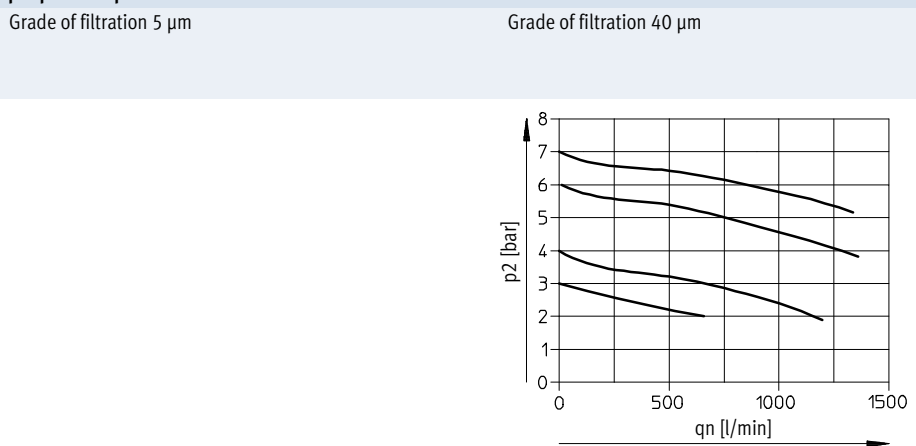

MSB6-1/2

Primary pressure $p_1 = 10$ bar

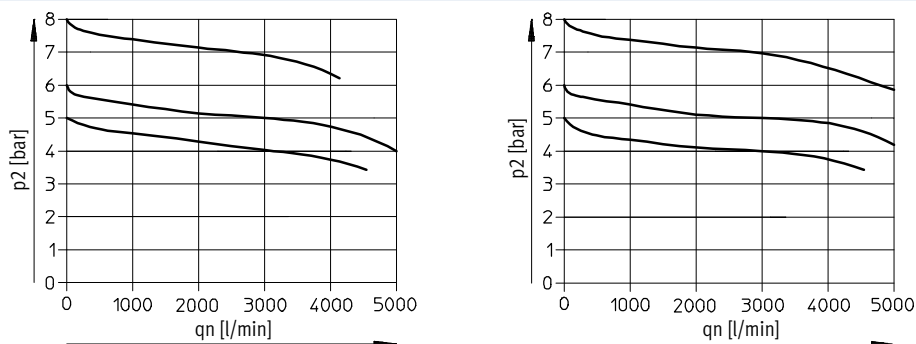

Service unit combinations MSB4/MSB6, MS series

Technical data – Combination 5

Dimensions

Download CAD data → www.festo.com

Manually actuated on-off valve, filter regulator with pressure gauge, solenoid actuated on-off valve, pneumatically actuated soft-start valve, branching module with pressure switch

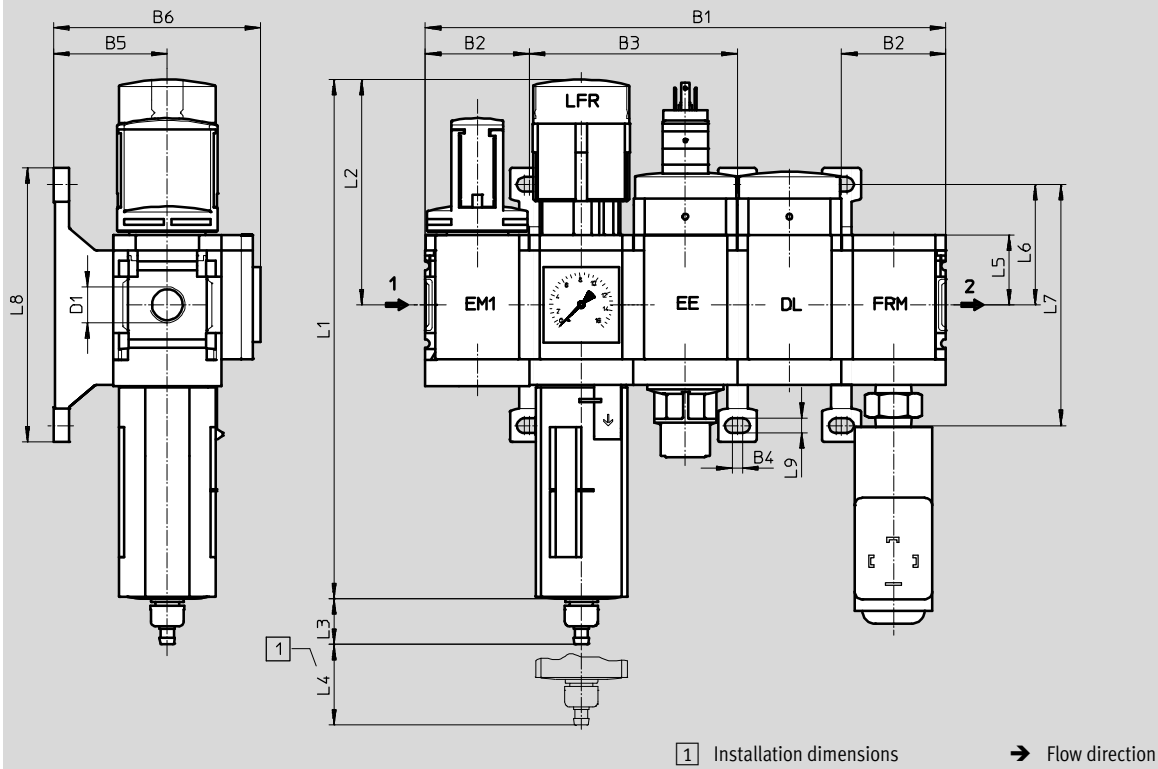

Type	B1	B2	B3	B4	B5	B6	D1	L1	L2
MSB4	201	40.2	80.4	4	44	80	G $\frac{1}{4}$	201	87
MSB6	310	62	124	4.5	54	100	G $\frac{1}{2}$	285	134.5

Type	L3 Condensate drain		L4	L5	L6	L7	L8	L9
	manual rotary	fully automatic						
MSB4	17.7	20.4	25	27	46.5	93.2	106	5.6
MSB6	15.8	18.5	68	39	71	142	158	6.6

– † – Note: This product conforms to ISO 1179-1 and to ISO 228-1

Ordering data

Size	Condensate drain	Connection	Grade of filtration 5 μ m		Grade of filtration 40 μ m	
			Part No.	Type	Part No.	Type
Pressure regulation range 4 ... 12 bar, pressure gauge with outer scale in bar and inner scale in psi						
MSB4	manual rotary	G $\frac{1}{4}$	–	–	542293	MSB4- $\frac{1}{4}$:C3J1D1A1F3-WP
	fully automatic	G $\frac{1}{4}$	–	–	542299	MSB4- $\frac{1}{4}$:C3J2D1A1F3-WP
MSB6	manual rotary	G $\frac{1}{2}$	542281	MSB6- $\frac{1}{2}$:C3J3D1A1F3-WP	542269	MSB6- $\frac{1}{2}$:C3J1D1A1F3-WP
	fully automatic	G $\frac{1}{2}$	542287	MSB6- $\frac{1}{2}$:C3J4D1A1F3-WP	542275	MSB6- $\frac{1}{2}$:C3J2D1A1F3-WP

Service unit combinations MSB4/MSB6, MS series

Technical data – Combination 6

Function
With condensate drain
manual rotary

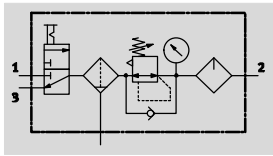

With condensate drain
fully automatic

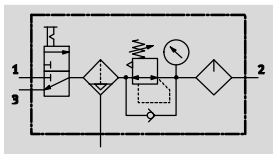

- On-off valve MS...-EM1 manually actuated
- Filter regulator MS...-LFR-D7 with pressure gauge
- Lubricator MS...-LOE-R
- Mounting bracket MS...-WP

- Flow rate
750 ... 3,100 l/min
- Temperature range
-10 ... +60 °C
- Pressure regulation range
1 ... 12 bar
- www.festo.com



- For filtered and lubricated compressed air
- Supply pressure can be opened and closed
- Output pressure is infinitely adjustable within the pressure regulation range

General technical data		
Size	MSB4	MSB6
Pneumatic connection 1, 2, 3	G1/4	G1/2
Regulating function	Output pressure constant, with primary pressure compensation, with return flow function, with secondary venting	
Type of mounting	Via accessories	
Assembly position	Vertical ±5°	
Grade of filtration [µm]	40	
Air purity class at the output	Compressed air in accordance with ISO 8573-1:2010 [7:4:4] (grade of filtration 40 µm)	
Bowl guard	Plastic bowl guard	
Condensate drain	Manual rotary	
	-	Fully automatic
Actuator lock	Rotary knob with detent, lockable with accessories	
Pressure regulation range [bar]	1 ... 12	
Pressure indicator	With pressure gauge	

- Note: This product conforms to ISO 1179-1 and to ISO 228-1

Standard nominal flow rate qnN [l/min]		
Size	MSB4	MSB6
Grade of filtration 40 µm	750	3,100

Service unit combinations MSB4/MSB6, MS series

Technical data – Combination 6

Operating and environmental conditions			
Condensate drain	Manual rotary		Fully automatic
Size	MSB4	MSB6	MSB6
Operating pressure [bar]	1.5 ... 14	1.5 ... 18	2 ... 12
Operating medium	Compressed air in accordance with ISO 8573-1:2010 [7:4:4]		
	Inert gases		
Note on operating/pilot medium	Operation with lubricated medium possible (in which case lubricated operation will always be required)		
Ambient temperature [°C]	-10 ... +60		+5 ... +60
Temperature of medium [°C]	-10 ... +60		+5 ... +60
Storage temperature [°C]	-10 ... +60		-10 ... +60
Corrosion resistance CRC ¹⁾	2		

1) Corrosion resistance class CRC 2 to Festo standard FN 940070
 Moderate corrosion stress. Indoor applications in which condensation may occur. External visible parts with primarily decorative requirements for the surface and which are in direct contact with the ambient atmosphere typical for industrial applications.

Weights [g]		
Size	MSB4	MSB6
Service unit combination	1,500	1,750
Mounting bracket	40	76

-  - Note
 Materials → Technical data of the individual devices

Standard flow rate qn as a function of output pressure p2
 Pressure regulation range 1 ... 12 bar Grade of filtration 40 µm Grade of filtration 5 µm
 MSB4-1/4

Primary pressure p1 = 10 bar

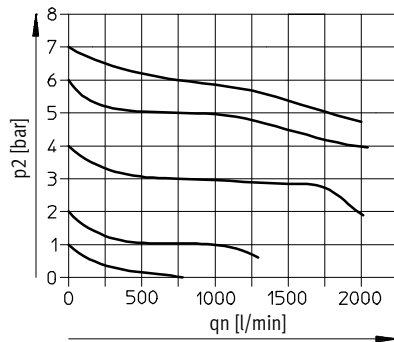

MSB6-1/2

Primary pressure p1 = 10 bar

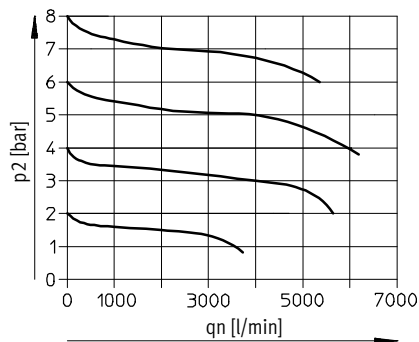

Service unit combinations MSB4/MSB6, MS series

Technical data – Combination 6

Dimensions

Download CAD data → www.festo.com

Manually actuated on-off valve, filter regulator with pressure gauge, lubricator

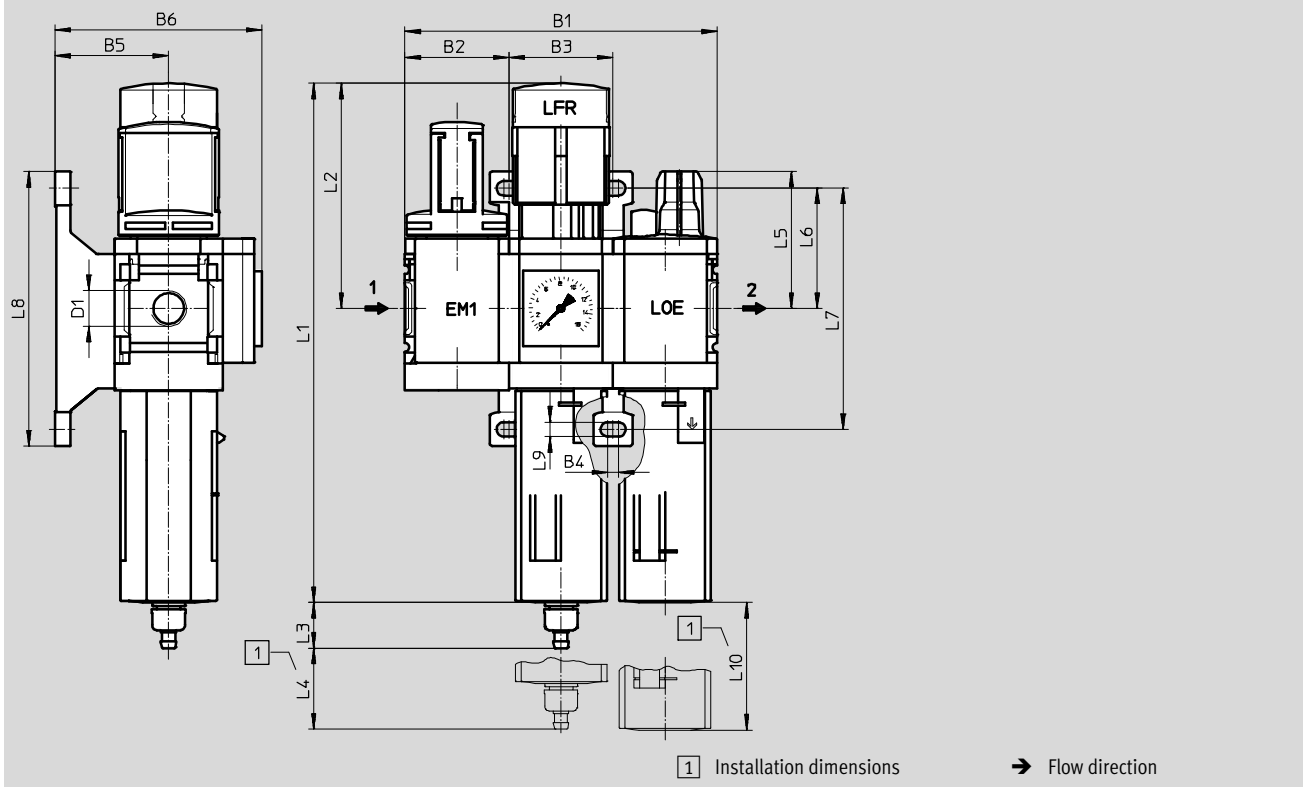

Type	B1	B2	B3	B4	B5	B6	D1	L1	L2
MSB4	120.6	40.2	40.2	4	44	80	G $\frac{1}{4}$	201	87
MSB6	186	62	62	4.5	54	100	G $\frac{1}{2}$	285	134.5

Type	L3 Condensate drain		L4	L5	L6	L7	L8	L9	L10
	manual rotary	fully auto- matic							
MSB4	17.7	–	25	53	46.5	93.2	106	5.6	80
MSB6	15.8	18.5	68	66	71	142	158	6.6	130

Note: This product conforms to ISO 1179-1 and to ISO 228-1

Ordering data

Size	Condensate drain	Connection	Grade of filtration 40 μ m	
			Part No.	Type
Pressure regulation range 1 ... 12 bar, pressure gauge with outer scale in bar and inner scale in psi				
MSB4	manual rotary	G $\frac{1}{4}$	542296	MSB4- $\frac{1}{4}$:C3J1M1-WP
MSB6	manual rotary	G $\frac{1}{2}$	542272	MSB6- $\frac{1}{2}$:C3J1M1-WP
	fully automatic	G $\frac{1}{2}$	542278	MSB6- $\frac{1}{2}$:C3J2M1-WP



Service unit combinations MSB4/MSB6, MS series

Technical data – Combination 7

Function

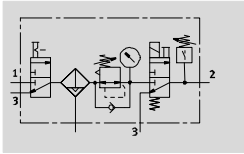
With condensate drain,
manual rotary



-  - Flow rate
1,400 ... 4,400 l/min
-  - Temperature range
0 ... +50 °C
-  - Pressure regulation range
0.5 ... 10 bar



- Manually operated on-off valve
MS...-EM1
- Filter regulator MS...-LFR with
pressure gauge
- Solenoid actuated on-off valve
MS...-EE-10V24P-AD7, with
pressure sensor for displaying
output pressure via operational
status indicator
- Mounting bracket MS...-WP

- For filtered and unlubricated
compressed air supply
- Supply pressure can be opened and
closed
- Output pressure is infinitely
adjustable within the pressure
regulation range
- When the supply pressure is closed,
quick venting ensures rapid
pressure reduction
- Electrical pressure monitoring with
adjustable switching pressure

General technical data		
Size	MSB4	MSB6
Pneumatic connection 1, 2, 3	G $\frac{1}{4}$	G $\frac{1}{2}$
Regulator function	Output pressure constant, with primary pressure compensation, with return flow, with secondary venting	
Type of mounting	Via accessories	
Mounting position	Vertical $\pm 5^\circ$	
Grade of filtration [μm]	40	
Air purity class at the output	Compressed air according to ISO 8573-1:2010 [7:4:4]	
Bowl guard	Plastic bowl guard	
Condensate drain	Manual rotary	
Actuation security	Rotary knob with detent, can be locked using accessories	
Pressure regulation range [bar]	0.5 ... 7	
	0.5 ... 10	
Pressure indication	Via pressure sensor for displaying output pressure via operational status indicator and electrical output	
	Via pressure gauge for displaying output pressure	

-  - Note: This product conforms to ISO 1179-1 and to ISO 228-1

Electrical data – On-off valve MS...-EE-10V24P-AD7	
Coil characteristics	24 V DC: 1.8 W; permissible voltage fluctuations $-15\%/+10\%$
Electrical connection	M12x1 to IEC 61076-2-101
Protection class for solenoid coil	IP65
Duty cycle [%]	100

Service unit combinations MSB4/MSB6, MS series

FESTO

Technical data – Combination 7

Standard nominal flow rate q _N [l/min]		
Size	MSB4	MSB6
Pressure regulation range 0.5 ... 7 bar		
Grade of filtration	40 µm	1,600
Pressure regulation range 0.5 ... 10 bar		
Grade of filtration	40 µm	1,400

Operating and environmental conditions		
Condensate drain	Manual rotary	
Size	MSB4	MSB6
Operating pressure [bar]	0.8 ... 14	0.8 ... 18
Operating medium	Compressed air according to ISO 8573-1:2010 [7:4:4]	
	Inert gases	
Note on operating/pilot medium	Lubricated operation possible (in which case lubricated operation will always be required)	
Ambient temperature [°C]	0 ... +50	
Temperature of medium [°C]	0 ... +50	
Storage temperature [°C]	-10 ... +60	
Corrosion resistance class CRC ¹⁾	2	

1) Corrosion resistance class CRC 2 to Festo standard FN 940070

Moderate corrosion stress. Indoor applications in which condensation may occur. External visible parts with primarily decorative requirements for the surface and which are in direct contact with the ambient atmosphere typical for industrial applications.

Weight [g]		
Size	MSB4	MSB6
Service unit combination	1,600	2,000
Mounting bracket	40	76

 - Note

Materials → Technical data of the individual devices

Service unit combinations MSB4/MSB6, MS series

Technical data – Combination 7

Dimensions

Download CAD data → www.festo.com

Manually actuated on-off valve, filter regulator with pressure gauge, solenoid actuated on-off valve with pressure sensor

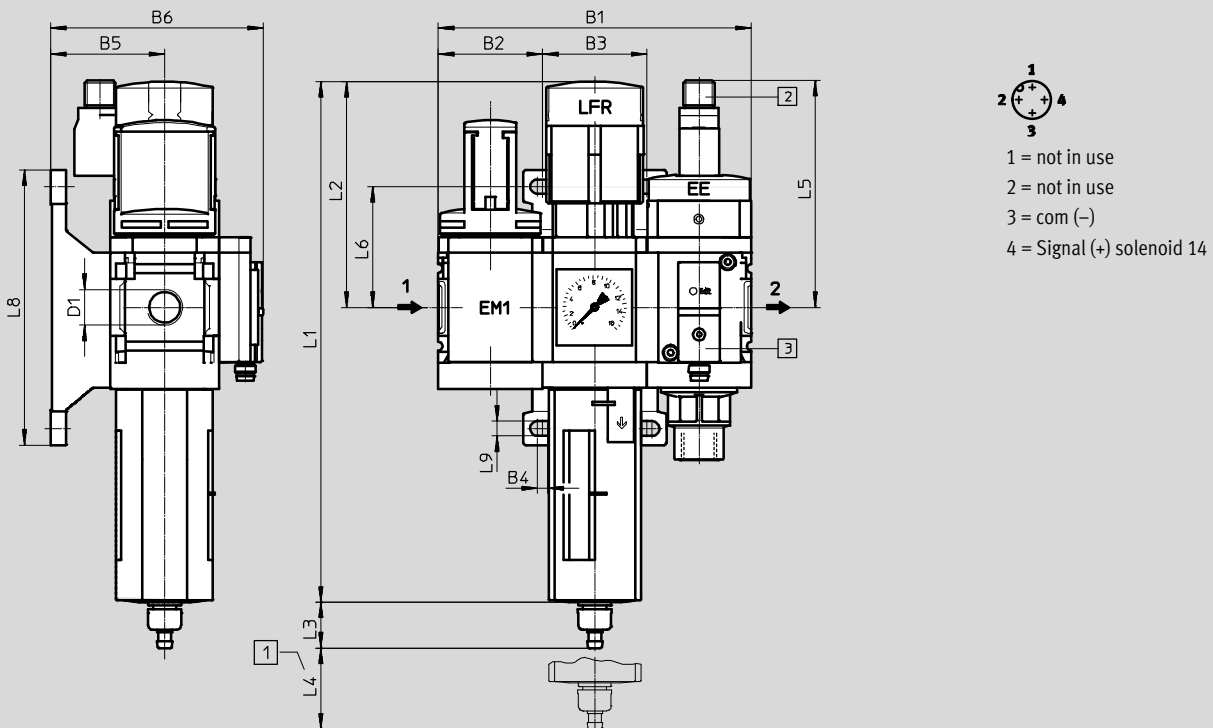

- 1 Installation dimensions
2 Electrical connection to IEC 61076-2-101, plug M12x1, 2-pin for NEBU-M12

- 3 Pressure sensor SDE5-D10-O-...-P-M8 with 3-pin plug M8x1, threshold value comparator, 1 switching output PNP, N/O contact
→ Internet: sde5

→ Flow direction

Type	B1	B2	B3	B4	B5	B6	D1
MSB4	120.6	40.2	40.2	4	44	82	G $\frac{1}{4}$
MSB6	186	62	62	4.5	54	102	G $\frac{1}{2}$

Type	L1	L2	L3	L4	L5	L6	L8	L9
MSB4	201	87	17.7	25	86.3	46.5	106	5.6
MSB6	285	134.5	15.8	68	104	71	158	6.6

– | – Note: This product conforms to ISO 1179-1 and to ISO 228-1

Ordering data

Size	Condensate drain	Connection	Grade of filtration 40 μ m	
			Part No.	Type
Pressure regulation range 0.5 ... 7 bar, pressure gauge with outer scale in MPa				
MSB4	Manual rotary	G $\frac{1}{4}$	8042666	MSB4- $\frac{1}{4}$:C3:J120:D14-WP
MSB6	Manual rotary	G $\frac{1}{2}$	8042670	MSB6- $\frac{1}{2}$:C3:J120:D14-WP
Pressure regulation range 0.5 ... 10 bar, pressure gauge with outer scale in bar and inner scale in psi				
MSB4	Manual rotary	G $\frac{1}{4}$	8025358	MSB4- $\frac{1}{4}$:C3:J1:D14-WP
MSB6	Manual rotary	G $\frac{1}{2}$	8025359	MSB6- $\frac{1}{2}$:C3:J1:D14-WP

Service unit combinations MSB, MS series

FESTO

Accessories

Ordering data – Silencer U				Technical data → Internet: u	
	Description	Pneumatic connection	Part No.	Type	
	for MS4-EM1/EE	G $\frac{1}{4}$	6842	U-$\frac{1}{4}$-B	
	for MS6-EM1/EE	G $\frac{1}{2}$	6844	U-$\frac{1}{2}$-B	

Ordering data – Angled socket PEV					Technical data → Internet: pev	
	Description	Operating voltage range	Electrical connection	Switching status display	Part No.	Type
	for PEV- $\frac{1}{4}$ -...-OD	15 ... 30 V DC	4-pin	Yellow LED	164274	PEV-$\frac{1}{4}$-WD-LED-24
		≤ 230 V AC	4-pin	Yellow LED	164275	PEV-$\frac{1}{4}$-WD-LED-230
		≤ 180 V DC				

Ordering data – Plug socket MSSD					Technical data → Internet: mssd	
	Description	Operating voltage range	Electrical connection	Type of mounting cable connection	Part No.	Type
	for PEV- $\frac{1}{4}$ -...-OD for MS4/6-EE/DE	≤ 250 V AC/DC	3-pin	Clamping screws	171157	MSSD-C-4P
			3-pin	Clamping screws	151687	MSSD-EB
		≤ 250 V AC/DC	4-pin	Insulation displacement technology	192745	MSSD-EB-S-M14

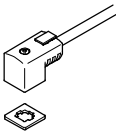
Ordering data – Plug socket with cable KMEB						Technical data → Internet: kmeb	
	Description	Operating voltage range	Electrical connection	Switching status display	Cable length [m]	Part No.	Type
	for MS4/6-EE/DE	24 V DC	2-pin	LED	2.5	547268	KMEB-3-24-2,5-LED
					5	547269	KMEB-3-24-5-LED
					2.5	547270	KMEB-3-24-2,5
			5	547271	KMEB-3-24-5		
			3-pin	LED	2.5	151688	KMEB-1-24-2,5-LED
					5	151689	KMEB-1-24-5-LED
		10			193457	KMEB-1-24-10-LED	
		230 V AC	3-pin	-	2.5	151690	KMEB-1-230AC-2,5
					5	151691	KMEB-1-230AC-5



Ordering data – Illuminating seal MEB-LD				Technical data → Internet: meb	
	Description	Operating voltage range	Part No.	Type	
	for plug socket with cable KMEB and plug socket MSSD-EB	12 ... 24 V DC	151717	MEB-LD-12-24DC	
		230 V DC/AC ±10%	151718	MEB-LD-230AC	

Ordering data – Padlock LRVS-D			
	Description	Weight [g]	Part No. Type
	for filter or pressure regulators	120	193786 LRVS-D

Service unit combinations MSB, MS series

FESTO

Accessories

Ordering data – Connecting cable NEBU-M8				Technical data → Internet: nebu	
	Electrical connection	Number of wires	Cable length [m]	Part No.	Type
	M8x1, straight socket	3	2.5	541333	NEBU-M8G3-K-2.5-LE3
			5	541334	NEBU-M8G3-K-5-LE3
	M8x1, angled socket	3	2.5	541338	NEBU-M8W3-K-2.5-LE3
			5	541341	NEBU-M8W3-K-5-LE3

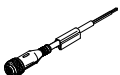
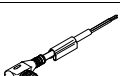
Ordering data – Connecting cable NEBU-M12				Technical data → Internet: nebu	
	Electrical connection	Number of wires	Cable length [m]	Part No.	Type
	M12x1, straight socket	4	2.5	550326	NEBU-M12G5-K-2.5-LE4
			5	541328	NEBU-M12G5-K-5-LE4
	M12x1, angled socket	4	2.5	550325	NEBU-M12W5-K-2.5-LE4
			5	541329	NEBU-M12W5-K-5-LE4

Product Range and Company Overview

A Complete Suite and Company Overview

Our experienced engineers provide complete support at every stage of your development process, including: conceptualization, analysis, engineering, design, assembly, documentation, validation, and production.



Custom Automation Components
Complete custom engineered solutions



Custom Control Cabinets
Comprehensive engineering support and on-site services



Complete Systems
Shipment, stocking and storage services

The Broadest Range of Automation Components

With a comprehensive line of more than 30,000 automation components, Festo is capable of solving the most complex automation requirements.



Electromechanical
Electromechanical actuators, motors, controllers & drivers



Pneumatics
Pneumatic linear and rotary actuators, valves, and air supply



PLCs and I/O Devices
PLC's, operator interfaces, sensors and I/O devices

Supporting Advanced Automation... As No One Else Can!

Festo is a leading global manufacturer of pneumatic and electromechanical systems, components and controls for industrial automation, with more than 16,000 employees in 60 national headquarters serving more than 180 countries. For more than 80 years, Festo has continuously elevated the state of manufacturing with innovations and optimized motion control solutions that deliver higher performing, more profitable automated manufacturing and processing equipment. Our dedication to the advancement of automation extends beyond technology to the education and development of current and future automation and robotics designers with simulation tools, teaching programs, and on-site services.

Quality Assurance, ISO 9001 and ISO 14001 Certifications

Festo Corporation is committed to supply all Festo products and services that will meet or exceed our customers' requirements in product quality, delivery, customer service and satisfaction.

To meet this commitment, we strive to ensure a consistent, integrated, and systematic approach to management that will meet or exceed the requirements of the ISO 9001 standard for Quality Management and the ISO 14001 standard for Environmental Management.



© Copyright 2013, Festo Corporation. While every effort is made to ensure that all dimensions and specifications are correct, Festo cannot guarantee that publications are completely free of any error, in particular typing or printing errors. Accordingly, Festo cannot be held responsible for the same. For Liability and Warranty conditions, refer to our "Terms and Conditions of Sale", available from your local Festo office. All rights reserved. No part of this publication may be reproduced, distributed, or transmitted in any form or by any means, electronic, mechanical, photocopying or otherwise, without the prior written permission of Festo. All technical data subject to change according to technical update.



Printed on recycled paper at New Horizon Graphic, Inc., FSC certified as an environmental friendly printing plant.

Festo North America



**1 Festo Canada
Headquarters
Festo Inc.**
5300 Explorer Drive
Mississauga, ON
L4W 5G4

2 Montréal
5600, Trans-Canada
Pointe-Claire, QC
H9R 1B6

3 Québec City
2930, rue Watt#117
Québec, QC
G1X 4G3



**4 Festo United States
Headquarters
Festo Corporation**
395 Moreland Road
Hauppauge, NY
11788

5 Appleton
North 922 Tower View Drive, Suite N
Greenville, WI
54942

7 Detroit
1441 West Long Lake Road
Troy, MI
48098

6 Chicago
85 W Algonquin - Suite 340
Arlington Heights, IL
60005

8 Silicon Valley
4935 Southfront Road, Suite F
Livermore, CA
94550

Festo Regional Contact Center

Canadian Customers

Commercial Support:
Tel: 1 877 GO FESTO (1 877 463 3786)
Fax: 1 877 FX FESTO (1 877 393 3786)
Email: festo.canada@ca.festo.com

Technical Support:
Tel: 1 866 GO FESTO (1 866 463 3786)
Fax: 1 877 FX FESTO (1 877 393 3786)
Email: technical.support@ca.festo.com

USA Customers

Commercial Support:
Tel: 1 800 99 FESTO (1 800 993 3786)
Fax: 1 800 96 FESTO (1 800 963 3786)
Email: customer.service@us.festo.com

Technical Support:
Tel: 1 866 GO FESTO (1 866 463 3786)
Fax: 1 800 96 FESTO (1 800 963 3786)
Email: product.support@us.festo.com