

Radial grippers HGRC



# Radial grippers HGRC

Key features

## At a glance

### General information

The compact and cost-optimised radial gripper consists of a two-part mirror-symmetrical housing made of die-cast zinc. The force generated by the linear motion of the piston is translated into the gripper jaw movement via a pneumatic piston, which acts directly on the gripper jaws

installed in the housing by means of a moment compensator in accordance with the rack and pinion principle. To ensure a low-backlash plain-bearing guide for the gripper jaws, appropriate guide elements are fitted in the housing and pretensioned by means of socket head screws.

- Double-acting gripper
- Internal fixed flow control, does away with the need for external flow control in 90% of applications
- High force with minimal volume
- Suitable for external and internal gripping

- Opening angle of 180°
- Repetition accuracy of 0.05 mm
- Slot for proximity sensor SME/SMT-10
- Wide range of options for mounting on drives

-  - Note  
Sizing software for gripper selection  
➔ [www.festo.com](http://www.festo.com)

## Details

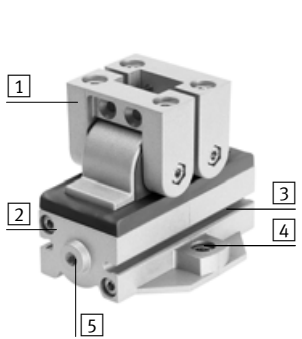

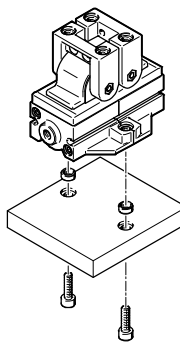

- 1 Gripper jaw
- 2 Housing based on half-shell principle
- 3 Slot for proximity sensor, for sensing the piston position
- 4 Mounting option
- 5 Supply port

## Mounting option from underneath

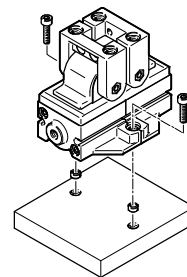

## from above



-  - Note  
Radial grippers are not designed for the following sample applications:

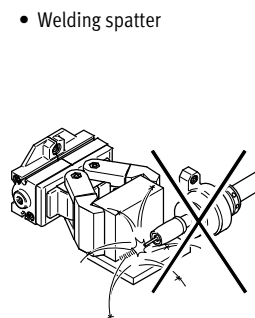
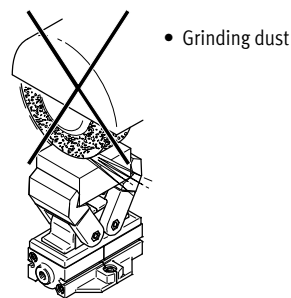
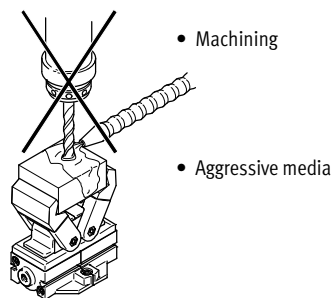

# Radial grippers HGRC

Peripherals overview and type codes

## Peripherals overview

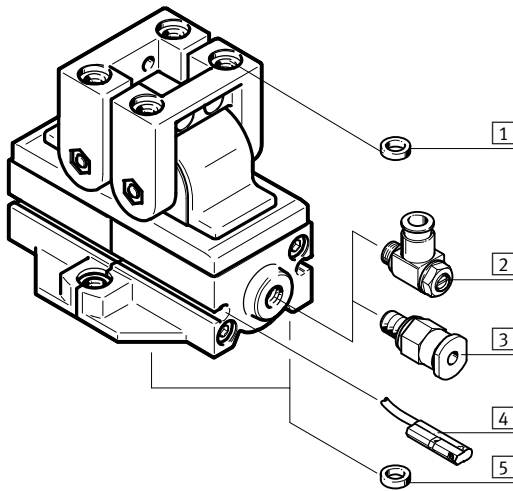

## System product for handling and assembly technology

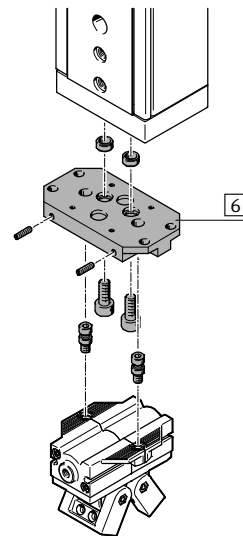

Accessories			
Type	Brief description	→ Page/Internet	
1 Centring sleeve ZBH	<ul style="list-style-type: none"> <li>For centring when attaching gripper fingers</li> <li>4 included in the scope of delivery of the gripper</li> </ul>	12	
2 One-way flow control valve GRLA	For regulating speed	gria	
3 Push-in fitting QS	For connecting compressed air tubing with standard O.D.	quick star	
4 Proximity sensor SME/SMT-10	For sensing the piston position	12	
5 Centring sleeve ZBH	<ul style="list-style-type: none"> <li>For centring when attaching to a drive or plate</li> <li>2 included in the scope of delivery of the gripper</li> </ul>	12	
6 –	Drive/gripper connections	adapter kit	

## Type codes

HGRC		–	12	–	A
<b>Type</b>					
HGRC	Radial gripper				
<b>Size</b>					
<b>Position sensing</b>					
A	Via proximity sensor				

# Radial grippers HGRC

Technical data

FESTO

Function  
Double-acting  
HGRC-...-A

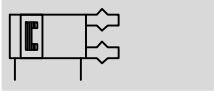

-  - Size  
12, 16, 20 mm
-  - Opening angle  
180°



General technical data			
Size	12	16	20
Design	Rack and pinion Force-guided motion sequence		
Mode of operation	Double-acting		
Gripper function	Radial		
Number of gripper jaws	2		
Max. opening angle	[°] 180		
Pneumatic connection	M5		
Repetition accuracy <sup>1)</sup>	[mm] ≤ 0.05		
Max. interchangeability	[mm] ≤ 0.2		
Max. gripper jaw backlash <sup>2)</sup>	[mm] ≤ 0.1		
Max. gripper jaw angular backlash <sup>3)</sup>	[°] ≤ 0.5		
Max. operating frequency	[Hz] ≤ 4		
Rotational symmetry	[mm] ≤ ∅ 0.2		
Position sensing	Via proximity sensor		
Type of mounting	Via female thread and centring sleeve		
Mounting position	Any		
Product weight	[g] 200	350	700

1) End-position drift under constant operating conditions with 100 consecutive strokes in the direction of movement of the gripper jaws

2) Perpendicular to the direction of motion of the gripper jaws

3) Pretensioned, backlash-free ball bearing guide

Operating and environmental conditions		
Operating pressure	[bar]	2 ... 8
Operating medium		Compressed air in accordance with ISO 8573-1:2010 [7:4:4]
Note on operating/pilot medium		Operation with lubricated medium possible (in which case lubricated operation will always be required)
Ambient temperature <sup>1)</sup>	[°C]	+5 ... +60
Corrosion resistance class CRC <sup>2)</sup>		2

1) Note operating range of proximity sensors

2) Corrosion resistance class 2 according to Festo standard 940 070

Components subject to moderate corrosion stress. Externally visible parts with primarily decorative surface requirements which are in direct contact with a normal industrial environment or media such as coolants or lubricating agents

# Radial grippers HGRC

Technical data

## Materials

Sectional view

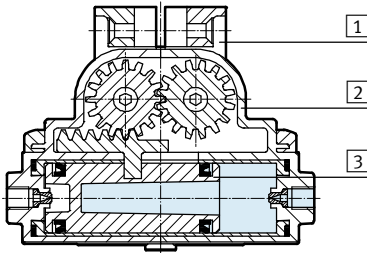

Radial gripper		
1	Gripper jaw	Die-cast zinc, painted
2	Housing	Die-cast zinc, painted
3	Piston	Polyamide
-	Seals	Polyurethane, nitrile rubber
-	Note on materials	Free of copper, PTFE and silicone RoHS-compliant

## Total gripping torque at 6 bar

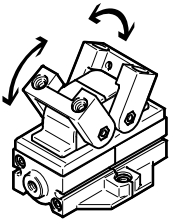

Size		12	16	20
Opening	[Ncm]	22	72	144
Closing	[Ncm]	22	72	144

## Static characteristic load values at the gripper jaws

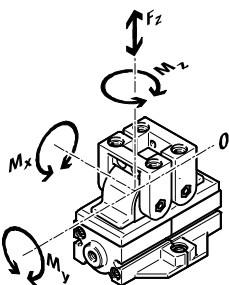

The indicated permissible forces and torques apply to a single gripper jaw. The indicated values include the lever arm, additional applied loads caused by the workpiece or external gripper

fingers, as well as forces which occur during movement.

The zero co-ordinate line (gripper jaw guide) must be taken into consideration for the calculation of torques.

Size		12	16	20
Max. permissible force $F_z$	[N]	40	60	80
Max. permissible torque $M_x$	[Nm]	2.5	4	8
Max. permissible torque $M_y$	[Nm]	0.6	1	1.9
Max. permissible torque $M_z$	[Nm]	2	3.2	6.7

# Radial grippers HGRC

Technical data

FESTO

## Mass moment of inertia

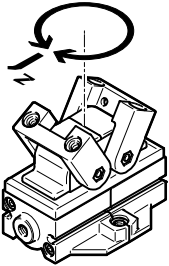

Mass moment of inertia [ $\text{kgm}^2 \times 10^{-4}$ ] of the radial gripper in relation to the central axis with no load.

Size		12	16	20
HGRC-...-A	[ $\text{kgm}^2 \times 10^{-4}$ ]	0.52	1.35	4.31

## Opening and closing times [ms] at 6 bar

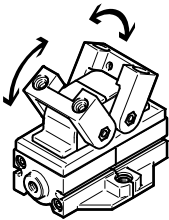

The indicated opening and closing times [ms] have been measured at room temperature and an operating pressure of 6 bar with vertically mounted gripper and without additional gripper fingers.

The grippers must be throttled for greater applied loads. Opening and closing times must then be adjusted accordingly.

Size		12	16	20
Without external gripper fingers				
HGRC-...-A	Opening	120	160	170
	Closing	100	150	160

# Radial grippers HGRC

Technical data

## Gripping force $F_{Grip}$ per gripper jaw as a function of operating pressure and lever arm $x$

Gripping forces as a function of the operating pressure and the lever arm can be determined for the size using the following graph.

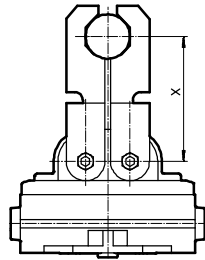

HGRC-12-A

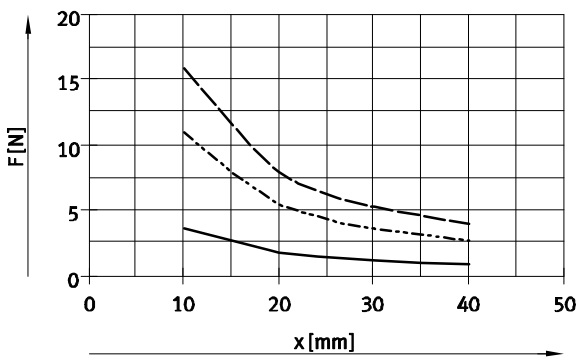

HGRC-16-A

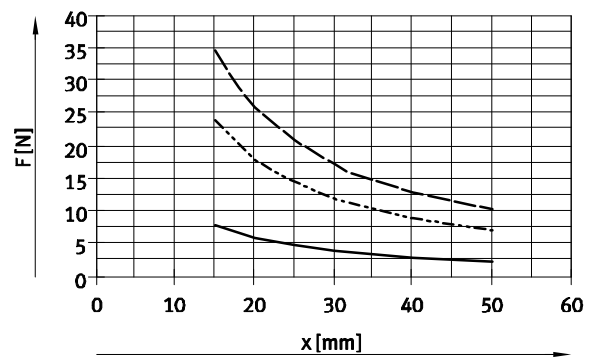

HGRC-20-A

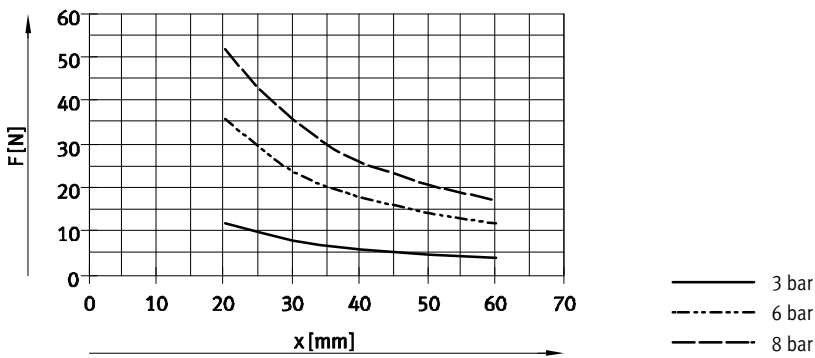

- 3 bar
- - - 6 bar
- · - 8 bar

# Radial grippers HGRC

Technical data

FESTO

## Dimensions

Download CAD data → [www.festo.com](http://www.festo.com)

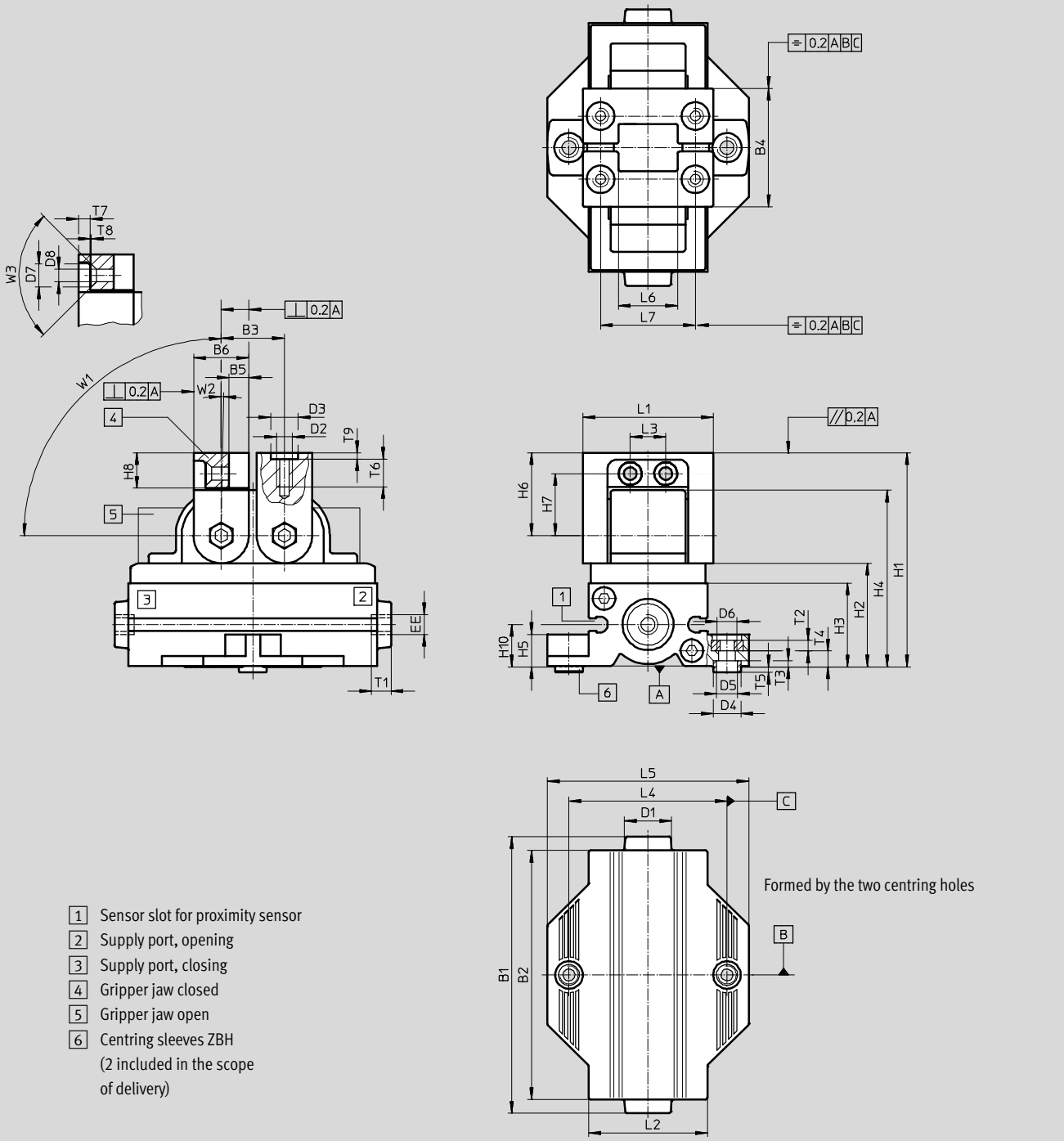



# Radial grippers HGRC

Technical data

Type	B1	B2	B3 ±0.05	B4 +0.25 -0.05	B5 +0.5	B6 +0.1	D1	D2	D3 +0.05 -0.02	D4 F10/h7	D5
HGRC-12	57	52	12	23	4	11	12	M3	5	7	5.3
HGRC-16	70	63	16	30	5.5	14	12	M4	7	7	5.3
HGRC-20	86	79	20	38	6	18	12	M5	9	9	6.4

Type	D6	D7	D8	EE	H1 ±0.5	H2	H3	H4	H5	H6 ±0.2	H7
HGRC-12	M4	4.8	2.6	M5	43.2	20.7	18.2	35.2	6.9	17	12.5
HGRC-16	M5	5.8	3.2	M5	54.2	26.2	21.2	44.7	8.2	21	15.7
HGRC-20	M6	8.1	4.4	M5	68.2	32.7	27	55.7	10.2	26.5	19.5

Type	H8	H10	L1 ±0.2	L2	L3 ±0.1	L4 <sup>1)</sup>	L5	L6 +0.25 -0.05	L7 <sup>1)</sup>	T1 min.
HGRC-12	7.5	9.2	27.5	25.5	6	33	42	12	20	4.5
HGRC-16	9	10.7	33	30	9	40	51	15	24	5
HGRC-20	12	13.7	45	38	12	50	65	21	33	5

Type	T2	T3 ±0.1	T4 +0.4 -0.3	T5 +0.1 -0.3	T6 min.	T7 +0.2	T8	T9 +0.1	W1 ±2	W2 ±3	W3
HGRC-12	2.2	1.7	3.1	1.3	6	1.7	0.5	1.3	90°	1°	90°
HGRC-16	2.7	1.8	3.8	1.2	7	3	0.3	1.6	90°	1°	90°
HGRC-20	3.2	2.3	5.2	1.7	9	3.5	0.5	2.1	90°	1°	90°

1) Tolerance for centring hole ±0.03  
Tolerance for thread ±0.2

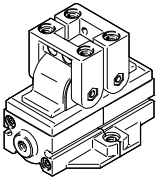
Ordering data		
	Size [mm]	Double-acting Part No. Type
	12	<b>565129</b> HGRC-12-A
	16	<b>565131</b> HGRC-16-A
	20	<b>565133</b> HGRC-20-A

# Radial grippers HGRC

Accessories

FESTO



## Adapter kit HAPG

Material:  
Wrought aluminium alloy  
Free of copper and PTFE  
RoHS-compliant



Note

The kit includes the individual mounting interface as well as the necessary mounting material.

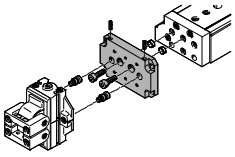
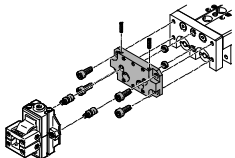
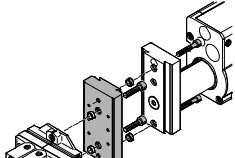
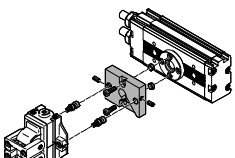
Permissible drive/gripper combinations with adapter kit							Download CAD data → <a href="http://www.festo.com">www.festo.com</a>	
Combination	Drive Size	Gripper Size	Mounting option		Adapter kit			
					CRC <sup>1)</sup>	Part No.	Type	
<b>DGSL/HGRC</b>	DGSL	HGRC			DHAA, HAPG			
	12, 16	12	■	■	2	529018	HAPG-58	
	20, 25	16	■	■		191267	HAPG-49	
	20, 25	20	■	■		191269	HAPG-51	
<b>SLT/HGRC</b>	SLT	HGRC			DHAA, HAPG			
	10	12	-	■	2	542670	HAPG-100	
	16	12	-	■		529018	HAPG-58	
	16	16	-	■		542666	HAPG-101	
	20	16	-	■		191267	HAPG-49	
	20	20	-	■		542667	HAPG-102	
	25	20	-	■		191269	HAPG-51	
<b>HMP/HGRC</b>	HMP	HGRC			DHAA, HAPG			
	16	16	■	-	2	191263	HAPG-45	
	20, 25	20	■	-		191264	HAPG-46	
<b>DRQD/HGRC</b>	DRQD-...	HGRC			DHAA, HAPG			
	12, 16	12	■	■	2	542671	HAPG-SD2-41	
	16, 20	16	■	■		542668	HAPG-SD2-42	
	20	20	■	■		542669	HAPG-SD2-43	
	25	20	■	■		542758	HAPG-SD2-44	

1) Corrosion resistance class 2 according to Festo standard 940 070

Components subject to moderate corrosion stress. Externally visible parts with primarily decorative surface requirements which are in direct contact with a normal industrial environment or media such as coolants or lubricating agents.

# Radial grippers HGRC



Accessories



## Adapter kit HAPG, HMSV

Material:  
Wrought aluminium alloy  
Free of copper and PTFE  
RoHS-compliant

 Note  
The kit includes the individual mounting interface as well as the necessary mounting material.

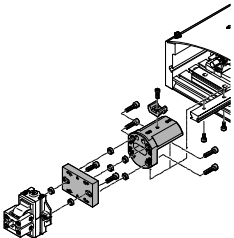
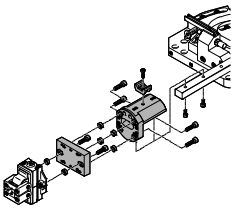
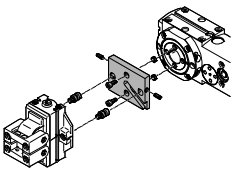
Permissible drive/gripper combinations with adapter kit						Download CAD data → <a href="http://www.festo.com">www.festo.com</a>	
Combination	Drive Size	Gripper Size	Mounting option		Adapter kit		
					CRC <sup>1)</sup>	Part No.	Type
	HSP	HGRC			DHAA, HAPG		
	16	16	-	■	2	191901	HAPG-55
	25	20	-	■		540882	HAPG-71-B
						191901	HAPG-55
						540883	HAPG-72-B
	HSW	HGRC			DHAA, HAPG		
	12	16	-	■	2	191901	HAPG-55
	16	16	-	■		540882	HAPG-71-B
						191901	HAPG-55
						540882	HAPG-71-B
	ERMB	HGRC			DHAA, HAPG		
	20	16	■	■	2	542668	HAPG-SD2-42
	20	20	■	■		542669	HAPG-SD2-43
	25	20	■	■		542758	HAPG-SD2-44

1) Corrosion resistance class 2 according to Festo standard 940 070  
Components subject to moderate corrosion stress. Externally visible parts with primarily decorative surface requirements which are in direct contact with a normal industrial environment or media such as coolants or lubricating agents.

# Radial grippers HGRC

Accessories

FESTO



Ordering data – Centring sleeves		Technical data → Internet: zbh		
For size [mm]	Part No.	Type	PU <sup>1)</sup>	
	For attachment to a drive or on a plate			
	12, 16	<b>186717</b>	<b>ZBH-7</b>	10
	20	<b>150927</b>	<b>ZBH-9</b>	10
For attaching gripper fingers				
	12	<b>189652</b>	<b>ZBH-5</b>	10
	16	<b>186717</b>	<b>ZBH-7</b>	10
	20	<b>150927</b>	<b>ZBH-9</b>	10

1) Packaging unit

Ordering data – Proximity sensors for C-slot					
Type of mounting	Electrical connection, connection direction	Switching output	Cable length [m]	Part No.	Type
	N/O contact, magneto-resistive				
	Insertable in slot from above	Cable, 3-wire, in-line	PNP	2.5	<b>551373</b> <b>SMT-10M-PS-24V-E-2,5-L-OE</b>
		Plug M8x1, 3-pin, in-line		0.3	<b>551375</b> <b>SMT-10M-PS-24V-E-0,3-L-M8D</b>
	N/O contact, magnetic reed				
Insertable in slot length-wise	Cable, 3-wire, in-line	Contacting	2.5	<b>173210</b> <b>SME-10-KL-LED-24</b>	
	Plug M8x1, 3-pin, in-line		0.3	<b>173212</b> <b>SME-10-SL-LED-24</b>	

Ordering data – Proximity sensors for C-slot					
Type of mounting	Electrical connection, connection direction	Switching output	Cable length [m]	Part No.	Type
	N/O contact, magneto-resistive				
	Insertable in slot from above	Cable, 3-wire, lateral	PNP	2.5	<b>551374</b> <b>SMT-10M-PS-24V-E-2,5-Q-OE</b>
		Plug M8x1, 3-pin, lateral		0.3	<b>551376</b> <b>SMT-10M-PS-24V-E-0,3-Q-M8D</b>
	N/O contact, magnetic reed				
Insertable in slot length-wise	Cable, 3-wire, lateral	Contacting	2.5	<b>173211</b> <b>SME-10-KQ-LED-24</b>	
	Plug M8x1, 3-pin, lateral		0.3	<b>173213</b> <b>SME-10-SQ-LED-24</b>	

Ordering data – Proximity sensors for C-slot					
Type of mounting	Electrical connection, connection direction	Switching output	Cable length [m]	Part No.	Type
	N/O contact, magneto-resistive				
	Insertable in slot length-wise	Cable, 3-wire, lateral	PNP	2.5	<b>547862</b> <b>SMT-10G-PS-24V-E-2,5Q-OE</b>
		Plug M8x1, 3-pin, lateral		0.3	<b>547863</b> <b>SMT-10G-PS-24V-E-0,3Q-M8D</b>

Ordering data – Connecting cables				Technical data → Internet: nebu	
Electrical connection, left	Electrical connection, right	Cable length [m]	Part No.	Type	
	Cable, open end, 3-wire	2.5	<b>541333</b>	<b>NEBU-M8G3-K-2.5-LE3</b>	
		5	<b>541334</b>	<b>NEBU-M8G3-K-5-LE3</b>	
	Cable, open end, 3-wire	2.5	<b>541338</b>	<b>NEBU-M8W3-K-2.5-LE3</b>	
		5	<b>541341</b>	<b>NEBU-M8W3-K-5-LE3</b>	

## Product Range and Company Overview

### A Complete Suite and Company Overview

Our experienced engineers provide complete support at every stage of your development process, including: conceptualization, analysis, engineering, design, assembly, documentation, validation, and production.



**Custom Automation Components**  
Complete custom engineered solutions



**Custom Control Cabinets**  
Comprehensive engineering support and on-site services



**Complete Systems**  
Shipment, stocking and storage services

### The Broadest Range of Automation Components

With a comprehensive line of more than 30,000 automation components, Festo is capable of solving the most complex automation requirements.



**Electromechanical**  
Electromechanical actuators, motors, controllers & drivers



**Pneumatics**  
Pneumatic linear and rotary actuators, valves, and air supply



**PLCs and I/O Devices**  
PLC's, operator interfaces, sensors and I/O devices

### Supporting Advanced Automation... As No One Else Can!

Festo is a leading global manufacturer of pneumatic and electromechanical systems, components and controls for industrial automation, with more than 16,000 employees in 60 national headquarters serving more than 180 countries. For more than 80 years, Festo has continuously elevated the state of manufacturing with innovations and optimized motion control solutions that deliver higher performing, more profitable automated manufacturing and processing equipment. Our dedication to the advancement of automation extends beyond technology to the education and development of current and future automation and robotics designers with simulation tools, teaching programs, and on-site services.

### Quality Assurance, ISO 9001 and ISO 14001 Certifications

Festo Corporation is committed to supply all Festo products and services that will meet or exceed our customers' requirements in product quality, delivery, customer service and satisfaction.

To meet this commitment, we strive to ensure a consistent, integrated, and systematic approach to management that will meet or exceed the requirements of the ISO 9001 standard for Quality Management and the ISO 14001 standard for Environmental Management.



© Copyright 2013, Festo Corporation. While every effort is made to ensure that all dimensions and specifications are correct, Festo cannot guarantee that publications are completely free of any error, in particular typing or printing errors. Accordingly, Festo cannot be held responsible for the same. For Liability and Warranty conditions, refer to our "Terms and Conditions of Sale", available from your local Festo office. All rights reserved. No part of this publication may be reproduced, distributed, or transmitted in any form or by any means, electronic, mechanical, photocopying or otherwise, without the prior written permission of Festo. All technical data subject to change according to technical update.



Printed on recycled paper at New Horizon Graphic, Inc., FSC certified as an environmental friendly printing plant.

# Festo North America

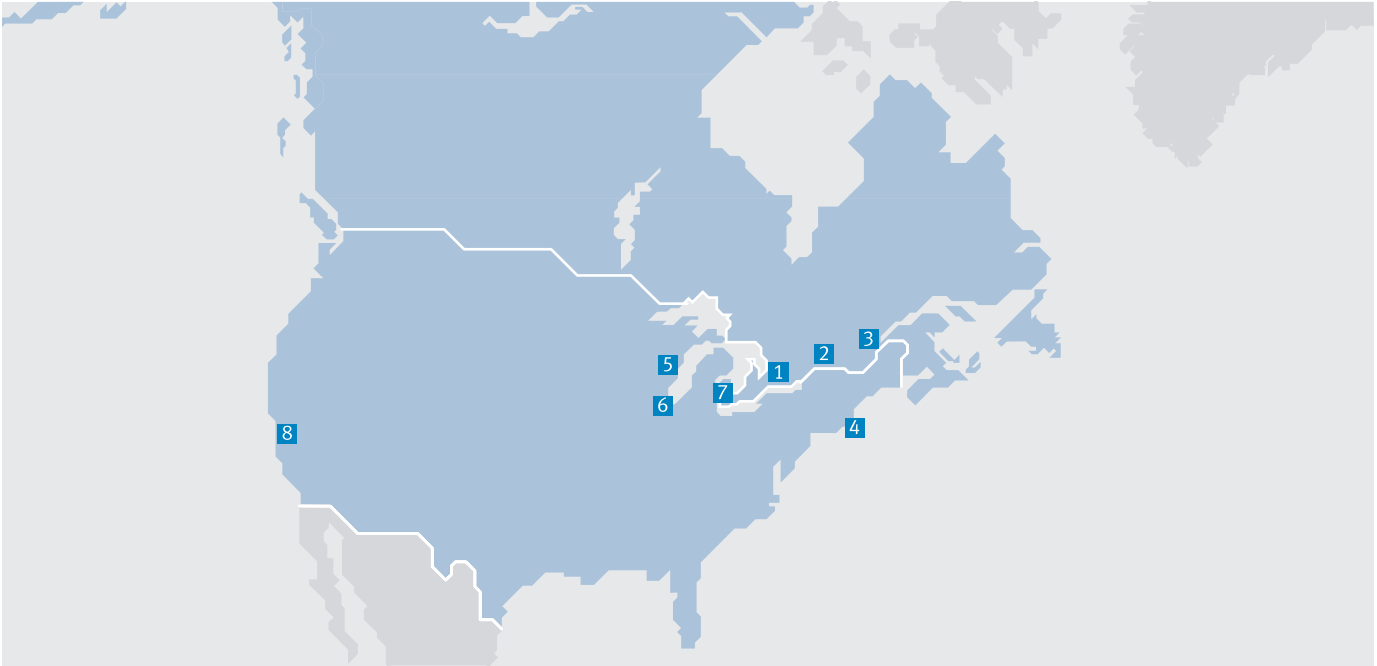

**1 Festo Canada  
Headquarters  
Festo Inc.**  
5300 Explorer Drive  
Mississauga, ON  
L4W 5G4

**2 Montréal**  
5600, Trans-Canada  
Pointe-Claire, QC  
H9R 1B6

**3 Québec City**  
2930, rue Watt#117  
Québec, QC  
G1X 4G3



**4 Festo United States  
Headquarters  
Festo Corporation**  
395 Moreland Road  
Hauppauge, NY  
11788

**5 Appleton**  
North 922 Tower View Drive, Suite N  
Greenville, WI  
54942

**7 Detroit**  
1441 West Long Lake Road  
Troy, MI  
48098

**6 Chicago**  
85 W Algonquin - Suite 340  
Arlington Heights, IL  
60005

**8 Silicon Valley**  
4935 Southfront Road, Suite F  
Livermore, CA  
94550

## Festo Regional Contact Center

### Canadian Customers

Commercial Support:  
Tel: 1 877 GO FESTO (1 877 463 3786)  
Fax: 1 877 FX FESTO (1 877 393 3786)  
Email: festo.canada@ca.festo.com

Technical Support:  
Tel: 1 866 GO FESTO (1 866 463 3786)  
Fax: 1 877 FX FESTO (1 877 393 3786)  
Email: technical.support@ca.festo.com

### USA Customers

Commercial Support:  
Tel: 1 800 99 FESTO (1 800 993 3786)  
Fax: 1 800 96 FESTO (1 800 963 3786)  
Email: customer.service@us.festo.com

Technical Support:  
Tel: 1 866 GO FESTO (1 866 463 3786)  
Fax: 1 800 96 FESTO (1 800 963 3786)  
Email: product.support@us.festo.com

Subject to change

Internet: [www.festo.com/us](http://www.festo.com/us)