

Fieldbus Direct

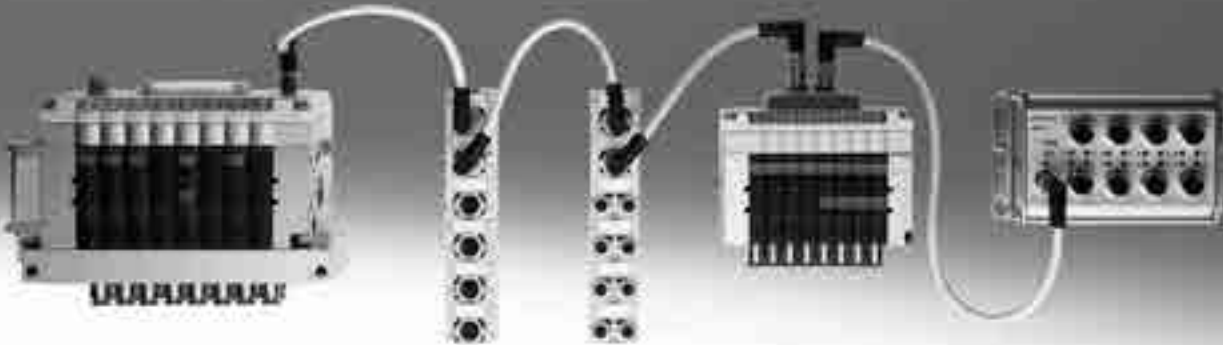

Fieldbus Direct

Key features

FESTO



The system

- Extremely compact and space-saving design
- Low-cost solution for the connection of a small number of valves to a fieldbus
- Extremely safe, protection class up to IP65 depending on the series

The Fieldbus Direct system comprises the following valve terminal series:

- CPV
- CPV-SC

The Fieldbus Direct product range is the most compact way of connecting valves to a fieldbus. The fieldbus node is directly integrated in the electrical actuation of the valve terminal and therefore takes up only a minimal amount of space.

Fieldbus Direct is a system for the connection of one valve terminal to nine different fieldbus standards. The most important systems including PROFIBUS, Interbus, DeviceNet and CANopen are supported.

The CP string extension option allows the functions and components of the CPI installation system to be used.

The optional string extension allows additional valve terminals and I/O modules to be connected to the fieldbus node of the Fieldbus Direct system.

The I/O modules and cables for the CP string extension are ordered using the order code for the CPI installation system.

The maximum length of the CP string extension is 10 metres, which means that the extension modules can be mounted directly on-site. All of the required electrical signals are transmitted via the CPI cable, which means that no further installation is needed on the extension module.

Valve terminal configurator

A valve terminal configurator is available online to help you select a suitable Fieldbus Direct valve terminal. Like all valve terminals, Fieldbus Direct is ordered using an ident. code.

This ident. code specifies the valve functions, the number of valves, vacant positions as well as the additional functions and the type of compressed air supply.

As is the case with all Festo products, all Fieldbus Direct valve terminals are supplied:

- fully pre-assembled
- fitted with fittings on request

Online via: → www.festo.com

- tested for electrical function
- tested for pneumatic function
- securely packaged
- manuals can be downloaded free of charge

Fieldbus Direct

Key features

Switch module for CPV Direct

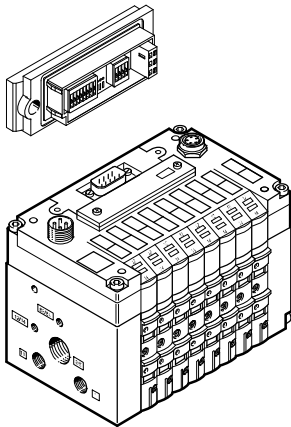

The bus parameters and the device configuration of CPV Direct are set using the removable switch module.

The integrated DIL switches are easy to set and check, even if the mounting position is difficult to access.

In the case of the valve terminals with the CP system according to Specification "B", the DIL switches for parameterisation/configuration are integrated in the basic electrical unit.

CP string extension

The optional string extension allows an additional valve terminal and I/O modules to be connected to the fieldbus nodes of the Fieldbus Direct system. A CP string of the CP installation system is integrated in the fieldbus node as an extension. Different input and output modules as well as CPV, MPA-S and CPV-SC valve terminals can be connected.

The maximum length of the CP string extension is 10 metres, which means that the extension modules can be mounted directly on-site. All of the required electrical signals are transmitted via the CP cable, which in turn means that no further installation is needed on the extension module.

The CP string interface offers:

- 16 input signals
- 16 output signals for output modules 24 V DC or solenoid coils
- Logic and sensor supply for the input modules
- Load voltage supply for the valve terminals
- Logic supply for the output modules

The variant according to Specification "B" supports the connection of

- 32 inputs
- 32 outputs 24 V DC or solenoid coils.

It goes without saying that the CP modules without Specification "B" can also be connected to the CPI string extension of valve terminals.

CPV Direct with fieldbus node

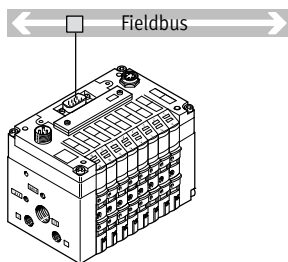

- 8 valve slices
- 16 solenoid coils
- 16 3/2-way valves

CPV Direct with input module 24 V DC for detecting the cylinder end positions

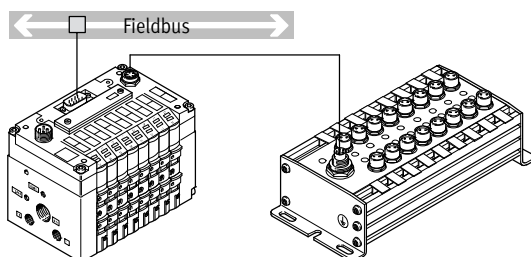

- 8 valve slices with up to 16 solenoid coils
- 16 inputs M8 or M12, each with sensor supply

Variant according to Specification "B"

- 32 input signals
- 32 output signals/solenoid coils

Fieldbus Direct

Key features – Bus connection

Fieldbus Direct system diagnostics

The fieldbus node together with the modules connected to the CP string offer several diagnostic options.

Diagnostic LEDs on the Fieldbus Direct node

The fieldbus-specific LEDs display the communication status and the fieldbus function.

Further LEDs display the power supply status of all connected modules as a common message.

- Undervoltage
- Short circuit
- Interruption of voltage

Diagnostic LEDs on the CP extension modules

LEDs on the individual CP/CPI modules display the current status of the switching signals of the inputs or outputs. Additional LEDs display short circuits or overload of the power supply and communication faults on the CP connection.

Diagnostic messages via the fieldbus

All available diagnostic information is transferred to the fieldbus node by means of the CP connection. This means that the diagnostic information for the entire device can be transferred to the fieldbus master.

- Configuration errors
- Short circuit/overload of an output module
- Short circuit/undervoltage of the sensor supply
- Undervoltage/load voltage of the valves
- Interruption of a CP string to one of the CP modules

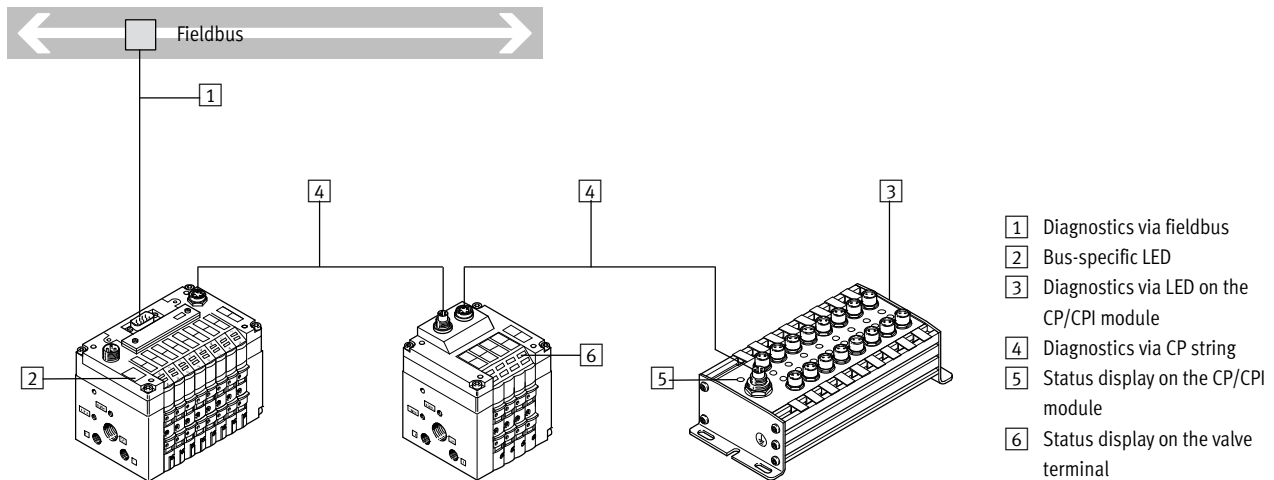

Fieldbus Direct

Overview of examples

Connection options

CPV-SC

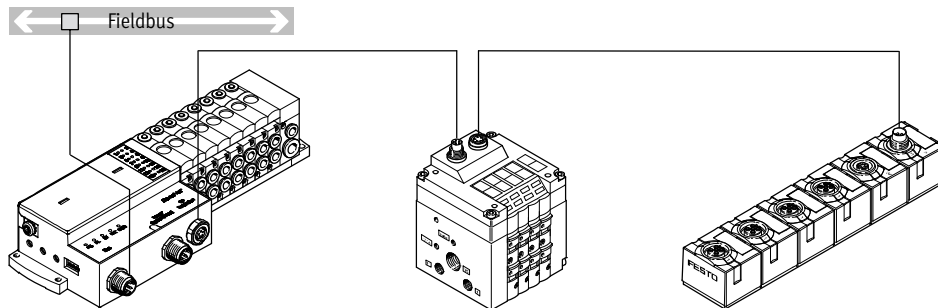

CPVSC1 valve terminals with fieldbus interfaces can be equipped with 4 to 16 valve positions and 4 to 16 solenoid coils.

Designs

- PROFIBUS connection
- 4 to 16 solenoid coils

Valve terminals with CP interface

CPV valve terminal

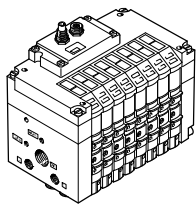

CPV10
CPV14
CPV18

- Max. 16 valves in 8 valve slices
- Highly compact and space-saving
- Width 10, 14, 18 mm
- Nominal flow rate 400/800/1600 l/min
- CPV10, CPV14 and CPV18 with CPI functionality

Further information

➔ Internet: [cpv](#)

MPA-S valve terminal

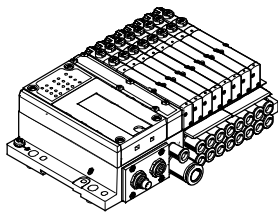

MPA1
MPA2

- Max. 32 valves
- Modular and versatile
- Width 10, 20 mm
- Nominal flow rate 360/700 l/min
- CPI functionality

Further information

➔ Internet: [mpa-s](#)

CPV-SC valve terminal

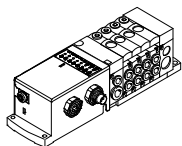

CPV-SC

- Max. 16 valves
- Extremely compact
- Width 10 mm
- Nominal flow rate 170 l/min
- CPI functionality

Further information

➔ Internet: [cpv-sc](#)

CP/CPI installation system input/output modules

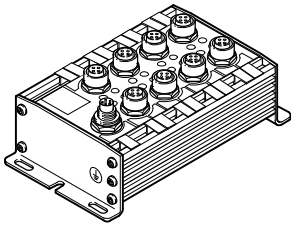

CP-E16-M12x2-5POL
CP-E16N-M12x2-5POL

- 16 inputs 24 V DC
- Signal status display via 16 LEDs
- Operating status display
- M12 socket, double allocation
- 1x M9 CP/CPI connection
- PNP/NPN, IP65

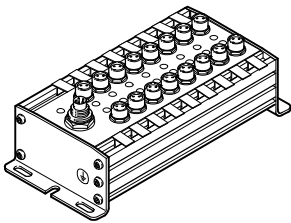

CP-E16-M8
CP-E16N-M8

- 16 inputs 24 V DC
- Signal status display via 16 LEDs
- Operating status display
- M8 socket, single allocation
- 1x M9 CP connection
- PNP/NPN, IP65

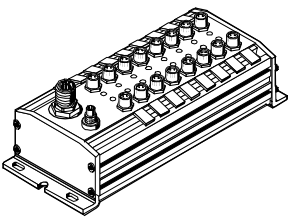

CP-E16-M8-Z

- 16 inputs 24 V DC
- Signal status display via 16 LEDs
- Operating status display
- Electrical isolation through additional power supply
- M8 socket, single allocation
- 1x M9 CP connection
- Separate sensor supply
- PNP/NPN, IP65

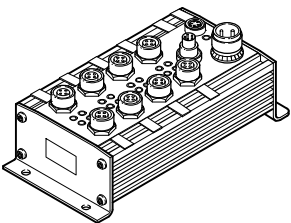

CP-A08-M12-5POL
CP-A08N-M12

- 8 outputs 24 V DC
- Output signal display via 8 LEDs
- Operating status display
- M12 socket, single allocation
- 2x M9 CP connection
- Separate load voltage
- Outputs resistant to overloads and short circuits
- PNP/NPN, IP65

Detailed description of input and output modules

➔ Internet: ctec

CP/CPI Compact Line input/output modules

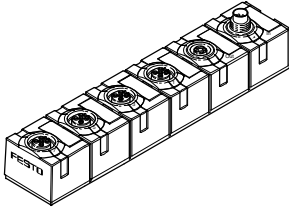

CP-E08-M12x2-CL

- 8 inputs 24 V DC
- Signal status display via 8 LEDs
- Operating status display
- 4x M12 socket, 5-pin, double allocation
- 2x M9 CP connection
- PNP, IP65/67

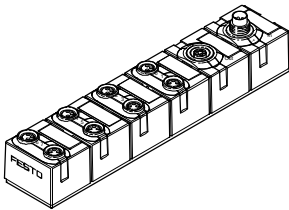

CP-E08-M8-CL

- 8 inputs 24 V DC
- Signal status display via 8 LEDs
- Operating status display
- 8x M8 socket, 3-pin, single allocation
- 2x M9 CP connection
- PNP, IP65/67

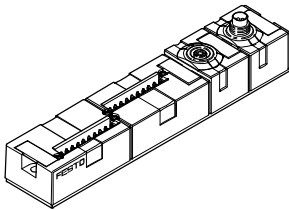

CP-E16-KL-CL

- 16 inputs 24 V DC
- Indirect signal status display via LEDs in the connection set of the tension-spring socket
- Operating status display
- Screw terminal or tension-spring sockets
- 2x M9 CP connection
- PNP, IP20

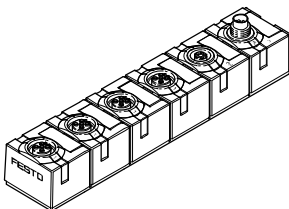

CP-A04-M12x2-CL

- 4 outputs 24 V DC
- Signal status display via 4 LEDs
- Operating status display
- 4x M12 socket, 5-pin, double allocation
- 2x M9 CP connection
- Outputs resistant to overloads and short circuits
- PNP, IP65/67

Detailed description of input and output modules

➔ Internet: ctec

CP/CPI Eco Line input/output modules

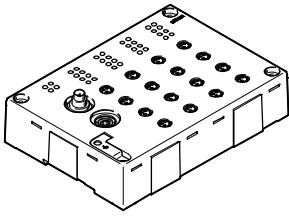

CP-E16-M8-EL

- 16 inputs 24 V DC
- Signal status display via LEDs
- Operating status display
- 16x M8 socket, 3-pin, double allocation
- 2x M9 CP connection
- PNP

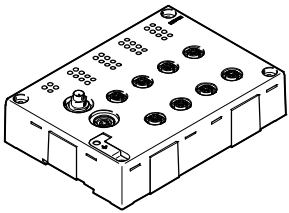

CP-E16-M12-EL

- 16 inputs 24 V DC
- Signal status display via LEDs
- Operating status display
- 8x M8 socket, 5-pin, single allocation
- 2x M9 CP connection
- PNP

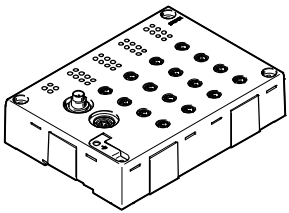

CP-E32-M8-EL

- 32 inputs 24 V DC
- Signal status display via LEDs
- Operating status display
- 16x M8 socket, 4-pin
- 2x M9 CP connection
- PNP

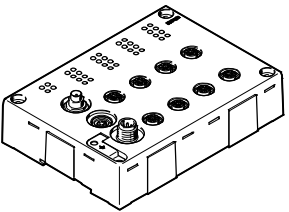

CP-A08-M12-EL-Z

- 8 outputs 24 V DC
- Signal status display via LEDs
- Operating status display
- 4x M12 socket, 5-pin, double allocation
- 2x M9 CP connection
- Outputs resistant to overloads and short circuits
- PNP

Detailed description of input and output modules

➔ Internet: ctec

CP connecting cable

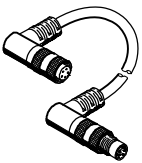

The CP string is connected using pre-assembled CP cables, which are supplied in lengths from 0.5 to 8 metres.

Fieldbus systems for CPV Direct

FESTO



Fieldbus variants

Of the more than 20 different fieldbus systems (protocols) available on the market, some have emerged as the most important variants. Festo supports these by means of various fieldbus nodes (FBxx) on its valve terminals. Fieldbus systems require a powerful, central PLC and a master interface adapted to that particular fieldbus.

Fieldbus systems are generally used when several devices with many inputs/outputs, complex functions or high communication levels must be controlled. In this case, the advantages of simple cabling, easy diagnostics and maintenance outweigh the extra outlay for a fieldbus master interface and the necessary know-how.

ABB

MOELLER

Festo fieldbus

A fieldbus developed by Festo with simple prompting, supported by the controllers of the FPC, SF and IPC series (Festo FB5). A maximum of 98 bus stations can be connected to the Festo fieldbus. The bus can operate with 4 different baud rates (31.25, 62.5, 187.75 and 375 kbps).

INTERBUS

An open fieldbus standard, originally developed by Phoenix Contact and now in worldwide use. Important installation accessories such as bus plugs must be obtained from Phoenix or its partners.

PROFIBUS DP

An open fieldbus standard, originally developed by Siemens and in worldwide use. The bus can operate with baud rates from 9.6 kBaud to 12 MBaud.

CANopen

BECKHOFF

CC-Link

DeviceNet

An open fieldbus system based on CAN technology originally developed for the automotive sector. DeviceNet was originally developed by Rockwell (Allen Bradley) and is now an open standard.

Moeller SUCONET K

A maximum of 98 bus stations can be connected to the SUCONET K fieldbus. The bus operates with a baud rate of 187.5 or 375 kbps, depending on the design, bus length, etc. The bus interface is based on RS 485 with a master/slave structure.

ABB CS31

The fieldbus from ABB connects a maximum of 63 fieldbus stations to the fieldbus master. The data is transferred at a constant baud rate of 187.5 kbps. The protocol is suitable for use in all areas of automation technology.



CC-Link

Fieldbus from Mitsubishi (Control & Communication-Link). The integrated interface with RS 485 transmission technology is designed for the typical CC-Link 3-wire connection technology (in accordance with CLPA CC-Link Spec. V1.11).

CANopen

Another fieldbus system based on CAN. Standardised by the "CAN in Automation" (CiA) user group. CANopen is characterised by its multi-master capability and high protocol efficiency. It is used throughout industrial automation.

Beckhoff Fieldbus Box

A fibre optic cable (FOC) fieldbus developed by Beckhoff. This fieldbus is a ring bus. The baud rate is 2000 kbps. A maximum of 124 stations can be connected. The use of fibre optic cables makes it suitable for use in environments where there is a lot of interference.

Fieldbus Direct

Peripherals overview



Fieldbus systems						
Valve terminal type	Fieldbus protocol	Valve terminal	CP string extension		Plug type, bus connection	→ Page/Internet
		Number of solenoid coils	Number of solenoid coils/outputs	Number of inputs		
CPV-...-GE-DI01-8	PROFIBUS DP (12 Mbaud) Festo ABB CS31 Moeller SUCONET K	16	16 / 8	16	<ul style="list-style-type: none"> • Sub-D fieldbus plug • 2xM12, 5-pin, B-coded 	13
CPV-...-GE-DI02-8	PROFIBUS DP (12 Mbaud)	16	32 / 32	32	<ul style="list-style-type: none"> • Screw terminal strip, 5-pin • Sub-D socket, 9-pin • Socket and plug, M12x1, 5-pin, B-coded 	17
CPVSC1-AE16-DP	PROFIBUS	16	32 / 32	32	Sub-D socket, 9-pin	21
CPV-...-GE-DN2-8	DeviceNet	16	16 / 8	16	<ul style="list-style-type: none"> • 2x M12, 5-pin • Screw terminal strip, 5-pin 	25
CPV-...-DN3-8	DeviceNet	16	32 / 32	32	<ul style="list-style-type: none"> • Screw terminal strip, 5-pin • Sub-D socket, 9-pin • Socket and plug, M12x1, 5-pin, A-coded 	29
CPV-...-GE-CO2-8	CANopen	16	16 / 8	16	<ul style="list-style-type: none"> • Sub-D • 2x M12, 5-pin • Screw terminal strip, 5-pin 	33
CPV-...-CO3-8	CANopen	16	32 / 32	32	<ul style="list-style-type: none"> • Screw terminal strip, 5-pin • Sub-D socket, 9-pin • Socket and plug, M12x1, 5-pin, A-coded 	37
CPV-...-GE-IB-8	INTERBUS	16	16 / 8	16	Sub-D fieldbus plug	41
CPV-...-GE-IP-8 ¹⁾	Beckhoff Fieldbus Box	16	–	–	FOC	45
CPV-...-GE-CC-8	CC-Link	16	–	16	<ul style="list-style-type: none"> • Sub-D, 9-pin • Screw terminal strip 	49

1) String extension not possible

Fieldbus Direct

Key features – Electrical connection

Operating voltage and load current supply

The operating voltages for the Fieldbus Direct valve terminal and for the extension modules are connected centrally via the 4- or 5-pin M12 plug. It must supply the operating voltages for the electronic unit of the fieldbus node and the modules connected to the CP string.

The load supply for the valves is supplied separately from the supply for the electronic unit.

The valves of the Fieldbus Direct valve terminals and the valves/outputs on the CP string extension are supplied

together via pin 2 of the M12 plug. The power supply for the sensors connected to the input module is normally also supplied by the M12 plug. Up to 500 mA for the sensor supply is made available to the connected input module via the CP string.

A separate, electrically isolated sensor supply is available with the two input modules CP-E16-KL-IP20-Z and CP-E16-M8-Z. In this case, a max. current of 2 A is available for the sensors.

Since the CP string carries the lines for both communication and the entire power supply for the connected modules, it represents a very easily installed extension option.

The following functions are supported via the CP string:

- Connection for data exchange
- Power supply for the connected modules
- Sensor voltage supply of up to 500 mA

- Load voltage supply for the connected valves

The electrical modules are protected against overload by electronic fuses. All diagnostic information for the modules is transferred to the fieldbus node via the CP string and from there forwarded to the PLC according to the relevant protocol.

Example of circuitry for CPV Direct – Connection of load voltage

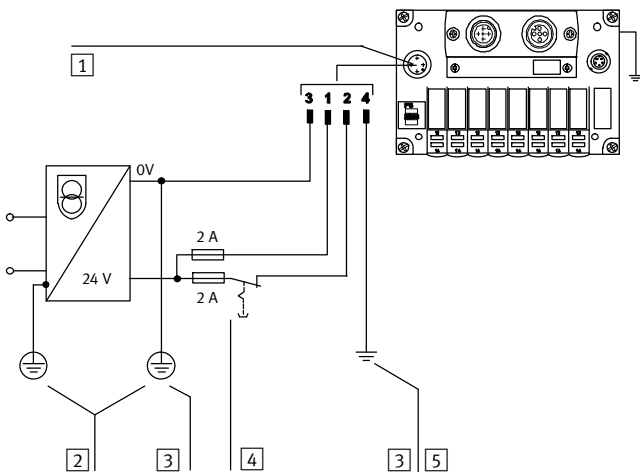

- 1 Connection for power supply on the CPV Direct valve terminal
- 2 Protective earth (PE)
- 3 Equipotential bonding
- 4 Load voltage (can be disconnected separately) and external fuse
- 5 Earth terminal on pin 4, configured for 3 A

Pin allocation – Power supply for CPV Direct

	Pin	Description	Notes
	1	24 V DC electronics and sensors	The voltage is supplied via a 4-pin M12 plug (A-coded).
	2	24 V DC valves and outputs	
	3	0 V electronics and sensors	
	4	Earth terminal	

Fieldbus Direct

Key features – Electrical connection



Operating voltage and load current supply

Example of circuitry for CPVSC1 – Connection of load voltage

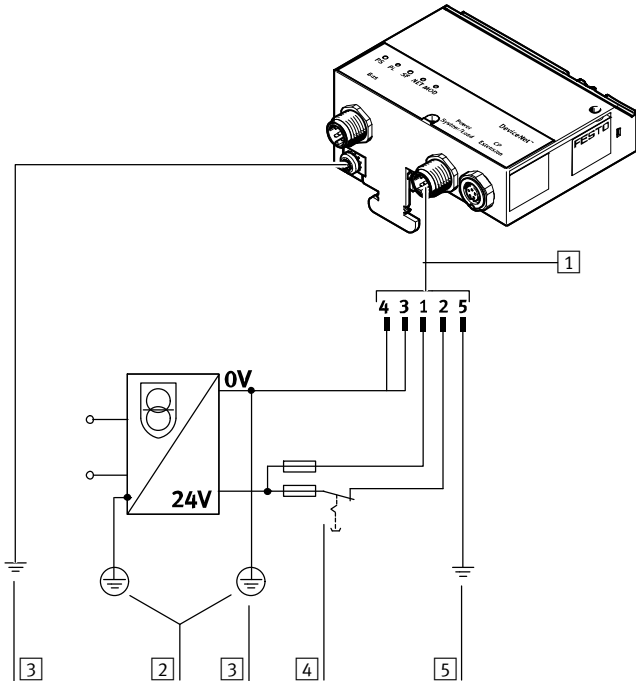

- 1 Connection for power supply
- 2 Protective earth (PE)
- 3 Equipotential bonding
- 4 Load voltage (can be disconnected separately) and external fuse
- 5 Earth terminal at pin 5

Pin allocation – Power supply for CPVSC1

	Pin	Description	Notes
	1	24 V DC electronics and sensors	The voltage is supplied via a 5-pin M12 plug (B-coded).
	2	24 V DC valves and outputs	In case of extension with 1st generation CP valve terminals (without auxiliary power supply), a bridge must be placed between pin 3 and pin 4.
	3	0 V electronics and sensors	This cancels the electrical isolation.
	4	0 V valves and outputs	
	5	Protective earth (PE)	

Fieldbus Direct, CPV-DI01

Technical data – Fieldbus node CPV-DI01

FESTO



CPV fieldbus node for communication between a CPV valve terminal and a fieldbus master. The fieldbus node is used for activation of a CPV valve terminal with 8 valve slices and 16 solenoid coils and for displaying the switching status via LED. The CPV... valves are activated via automatic current reduction, which results in less power consumption and heat emission. 16 digital inputs and 8 digital outputs or 16 valves can be connected via a serial CP string extension.

DI01 supports 4 different fieldbus protocols, which are selected by means of DIL switches:

- PROFIBUS DP
- Moeller SUCOnet K
- ABB CS31
- Festo fieldbus

The CPV fieldbus node is available in three sizes, with identical performance characteristics:

- CPV10
- CPV14
- CPV18



Application

Bus connection

Sub-D socket

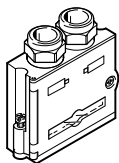

M12 adapter

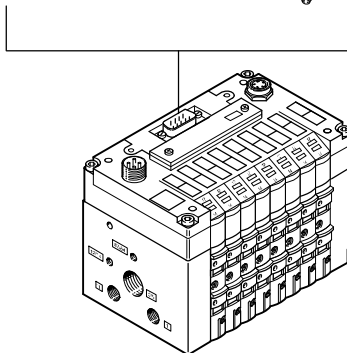
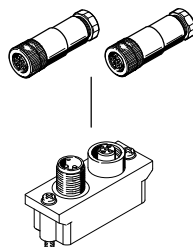

Sub-D socket

- 9-pin Sub-D socket
- Installation with IP65 protection

The bus connection is established via a 9-pin Sub-D socket with a typical PROFIBUS allocation (to EN 50 170). The bus connector plug (with protection class IP65 from Festo or IP20 from other manufacturers) facilitates the connection of an incoming and an outgoing bus cable. An active bus terminal can be connected using the integrated DIL switch. The Sub-D interface is designed for the activation of network components via a fibre optic cable connection.

M12 adapter

- Plug connector 2xM12
- Installation with IP65 protection

Alternatively the bus connection can be established via a 2x M12 adapter (B-coded).

Fieldbus Direct, CPV-DI01

Technical data – Fieldbus node CPV-DI01

General technical data				
Type		CPV10-GE-DI01-8	CPV14-GE-DI01-8	CPV18-GE-DI01-8
Fieldbus interface		Either <ul style="list-style-type: none"> • Sub-D socket, 9-pin • Socket and plug, M12x1, 5-pin, B-coded 		
Electrical isolation of the fieldbus interface		Via optocoupler		
Baud rates	[kbps]	9.6 ... 12,000; automatic detection		
Addressing range	PROFIBUS DP (12 MBaud) Festo fieldbus ABB CS31 Moeller SUCONET K	1 ... 125; Set using a switch module		
CP/CPI string extension		Yes, 16 inputs and 8 outputs (or 16 valves)		
LED display (bus-specific)	BUS	Communication and configuration errors		
LED display	Product-specific	Valve switching status		
	Power	Operating voltage for electrics and load supply		
Product identification		Product family 4: Valves		
Ident. number		0xC9		
Type of communication		Cyclical communication		
Configuration support		GSD file and bitmaps		
Max. no. of solenoid coils		16		
Max. no. of solenoid coils with string extension		32		
Max. no. of outputs		8 (1x16 solenoid coils omitted)		
Max. no. of inputs		16		
Device-specific diagnostics		<ul style="list-style-type: none"> • Short circuit/overload of outputs • Undervoltage of valves • Undervoltage of outputs • Undervoltage of sensor supply • Missing module on CP/CPI string extension • Via device-specific diagnostics (DPVO) 		
Operating voltage	Nominal value	[V DC]	24, reverse polarity protected	
	Permissible range	[V]	20.4 ... 26.4	
	Residual ripple	[Vss]	4	
	Power failure bridging	[ms]	10	
Current consumption		[mA]	Max. 100 + sensor supply	
Protection class to EN 60529			IP65	
Materials	Housing		Die-cast aluminium	
	Cover		Reinforced polyamide	
	Seal		Nitrile rubber	
Dimensions			➔ Internet: cpv	
Weight				
Technical data on valves				

Operating and environmental conditions		
Ambient temperature	[°C]	-5 ... +50
Storage temperature	[°C]	-20 ... +70
Fieldbus certification		PNO
Certification		cULus recognized (OL)
CE symbol (see declaration of conformity)		In accordance with EU EMC directive

Fieldbus Direct, CPV-DI01

Technical data – Fieldbus node CPV-DI01



Connection and display components

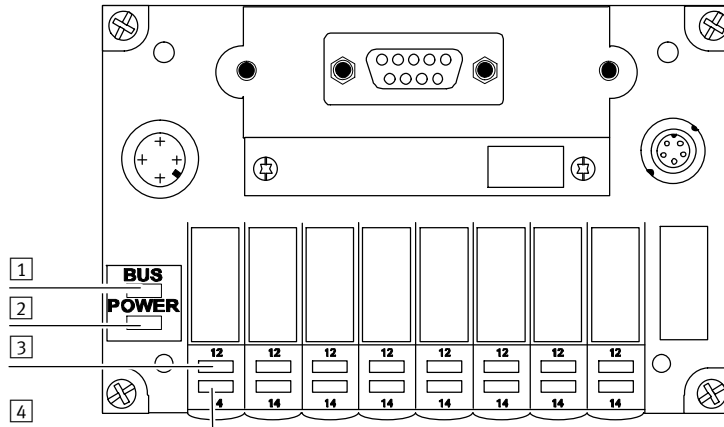

- 1 Red LED: Bus status/error (BUS)
- 2 Green LED: Power supply (POWER)
- 3 Yellow LED row: For pilot solenoid coils 12
- 4 Yellow LED row: For pilot solenoid coils 14

Pin allocation for fieldbus interface (viewed on plug)









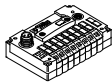

	Pin	Festo Sub-D plug (IP65)	Manufacturer-specific signal designation				
			Festo fieldbus interface	ABB CS31	PROFIBUS DP	Moeller SUCONET K	
						Sub-D 9-pin	DIN (round) 5-pin
	1	–	–	–	n.c.	–	–
	2	–	–	–	n.c.	–	–
	3	B	S+	Bus1	RxD/TxD-P	3 (T _A /R _A)	4 (T _A /R _A)
	4	–	–	–	CNTR-P	–	–
	5	–	–	–	DGND	–	–
	6	–	–	–	VP	–	–
	7	–	–	–	n.c.	–	–
	8	A	S-	Bus2	RxD/TxD-N	7 (T _B /R _B)	1 (T _B /R _B)
	9	–	–	–	n.c.	–	–
	Housing	Cable clip	Screened	Screened	Screened	4 (screened)	Housing

Pin allocation for M12 adapter

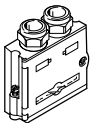
	Bus In (pin)	Bus Out (socket)	PROFIBUS DP (signal)	Description
	M12 and 5	M12 and 5	Screened	Screened or functional earth
	4	4	RxD / TxD-P	Data B
	–	3	DGND	Reference potential to supply voltage positive (VP)
	–	1	VP (P5V)	Supply voltage positive
	2	2	RxD / TxD-N	Data A

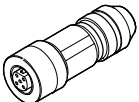
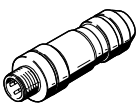
Fieldbus Direct, CPV-DI01

Accessories – Fieldbus node CPV-DI01

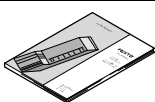
Ordering data			
Designation		Part No.	Type
Fieldbus node			
	CPV10	165809	CPV10-GE-DI01-8
	CPV14	165811	CPV14-GE-DI01-8
	CPV18	165813	CPV18-GE-DI01-8
Switch module			
	For setting bus parameters and device configuration in the case of CPV	165814	CPV10/14/18-GE-DI-SM
Power supply			
	Power supply socket, straight, M12, 4-pin	18497	FBSD-GD-7
		18495	FBSD-GD-9
	Power supply socket, angled, 4-pin	18524	FBSD-WD-7
		18525	FBSD-WD-9
Fieldbus connection			
	Fieldbus socket, Sub-D connection	532216	FBS-SUB-9-GS-DP-B
Bus connection Micro Style M12			
	Bus connection Micro Style, 2xM12	533118	FBA-2-M12-5POL-RK
	Socket M12x1, 5-pin, straight, for self-assembly of a connecting cable for FBA-2-M12-5POL-RK	1067905	NECU-M-B12G5-C2-PB
	Plug M12x1, 5-pin, straight, for self-assembly of a connecting cable for FBA-2-M12-5POL-RK	1066354	NECU-M-S-B12G5-C2-PB
	Fieldbus socket for Micro Style connection, M12, 5-pin, straight	18324	FBSD-GD-9-5POL
	Plug for Micro Style connection, M12, 5-pin, straight	175380	FBS-M12-5GS-PG9
Valve terminal connection			
	Connecting cable, angled plug, angled socket	0.25 m	540327 KVI-CP-3-WS-WD-0,25
		0.5 m	540328 KVI-CP-3-WS-WD-0,5
		2 m	540329 KVI-CP-3-WS-WD-2
		5 m	540330 KVI-CP-3-WS-WD-5
		8 m	540331 KVI-CP-3-WS-WD-8
	Connecting cable, straight plug, straight socket	2 m	540332 KVI-CP-3-GS-GD-2
		5 m	540333 KVI-CP-3-GS-GD-5
		8 m	540334 KVI-CP-3-GS-GD-8
User documentation			
	User documentation for CPV Direct, CPV fieldbus node DI01	German	165816 P.BE-CP-DI01-DE
		English	165817 P.BE-CP-DI01-EN
		Italian	165818 P.BE-CP-DI01-IT
		French	165819 P.BE-CP-DI01-FR
		Spanish	165820 P.BE-CP-DI01-ES

Fieldbus Direct, CPV-DI02-8

Technical data – Fieldbus node CPV-DI02-8



CPV fieldbus node according to the CP system with Specification “B” for communication between a CPV valve terminal and a fieldbus master. The fieldbus node is used for activation of a CPV valve terminal with 8 valve slices and 16 solenoid coils and for displaying the switching status via LED. The CPV... valves are activated via automatic current reduction, which results in less power consumption and heat emission. 32 digital inputs and outputs or 32 solenoid coils can be connected via a serial CP string extension.

The CPV fieldbus node is available in three sizes, with identical performance characteristics:

- CPV10
- CPV14
- CPV18

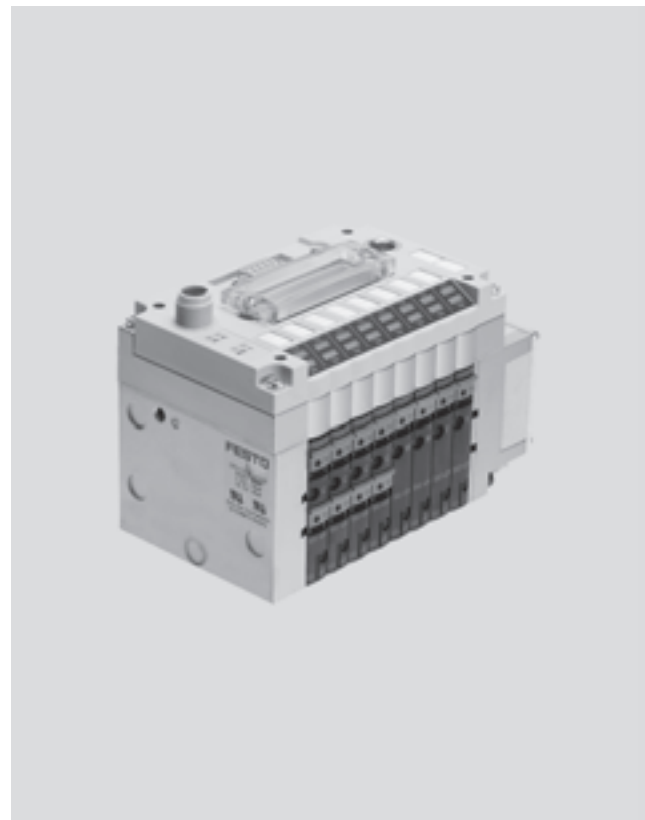

Application

Bus connection

Screw terminals

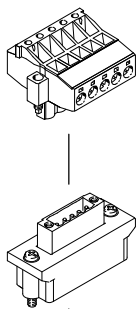

Plug connector 2xM12

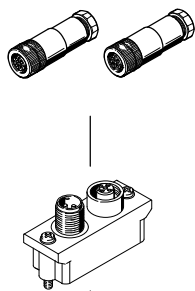

Sub-D fieldbus plug

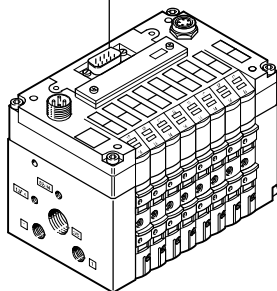
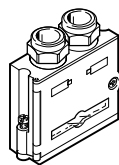

Sub-D socket

- 9-pin Sub-D socket
- Installation with IP65 protection

The bus connection is established via a 9 pin Sub-D socket with a typical PROFIBUS allocation (to EN 50170). The bus connector plug (with protection class IP65 from Festo or IP20 from other manufacturers) facilitates the connection of an incoming and an outgoing bus cable. An active bus terminal can be connected using the integrated DIL switch. The Sub-D interface is designed for the activation of network components via a fibre optic cable connection.

M12 adapter

- Plug connector 2xM12
- Installation with IP65 protection

Alternatively the bus connection can be established via a 2x M12 adapter (A-coded).

Screw terminals

• 5-pin screw terminal strip for installation in protected environments (IP20). The bus connection is established via a 5-pin row. If the valve terminal is ordered with this bus connection, the 5-pin screw terminal strip will also be supplied. It is designed with double screw terminals for the incoming and the outgoing bus cable. This connection technology provides a T-distributor function.

Fieldbus Direct, CPV-DI02-8

Technical data – Fieldbus node CPV-DI02-8

General technical data				
Type		CPV10-GE-DI02-8	CPV14-GE-DI02-8	CPV18-GE-DI02-8
Fieldbus interface	Either	<ul style="list-style-type: none"> Screw terminal strip, 5-pin Sub-D socket, 9-pin Socket and plug, M12x1, 5-pin, B-coded 		
Electrical isolation of the fieldbus interface		Via optocoupler		
CP string extension		Yes, 32 inputs and 32 outputs		
Baud rates	[kbps]	9.6 ... 12,000; Automatic detection		
Addressing range	PROFIBUS DP (12 Mbaud)	1 ... 125; Set using a switch module		
LED display	Bus-specific	Communication and configuration errors		
	Product-specific	Valve switching status		
	Power	Operating voltage for electrics and load supply		
Ident. number		0xC9		
Type of communication		Cyclical communication		
Configuration support		GSD file and bitmaps		
Max. no. of solenoid coils		16		
Max. no. of solenoid coils with string extension		48 with string extension		
Max. no. of outputs		16 solenoid coils and 32 outputs		
Max. no. of inputs		32		
LED diagnostic displays	POWER	Operating voltage for electronics and load supply		
	BUS	Communication and configuration errors		
Device-specific diagnostics		<ul style="list-style-type: none"> Short circuit/overload of outputs Undervoltage of valves Undervoltage of outputs Undervoltage of sensor supply Missing module on CP string extension Via device-specific diagnostics (DPVO) 		
Operating voltage	Nominal value	[V DC]	24, reverse polarity protected	
	Permissible range	[V]	20.4 ... 26.4	
	Residual ripple	[Vss]	4	
	Power failure bridging	[ms]	10	
Current consumption		[mA]	Max. 100 + sensor supply	
Protection class to EN 60529			<ul style="list-style-type: none"> IP20 with 5-pin screw terminal strip IP65 Sub-D, socket/plug M12x1 	
Materials	Housing		Die-cast aluminium	
	Cover		Reinforced polyamide	
	Seals		Nitrile rubber, polychloroprene rubber	
Dimensions			→ Internet: cpv	
Weight				
Technical data on valves				

Operating and environmental conditions		
Ambient temperature	[°C]	-5 ... +50
Storage temperature	[°C]	-20 ... +70
Fieldbus certification		PNO
Certification		cULus recognized (OL)
CE symbol (see declaration of conformity)		In accordance with EU EMC directive
Note on materials		RoHS-compliant

Fieldbus Direct, CPV-DI02-8

Technical data – Fieldbus node CPV-DI02-8

Connection and display components

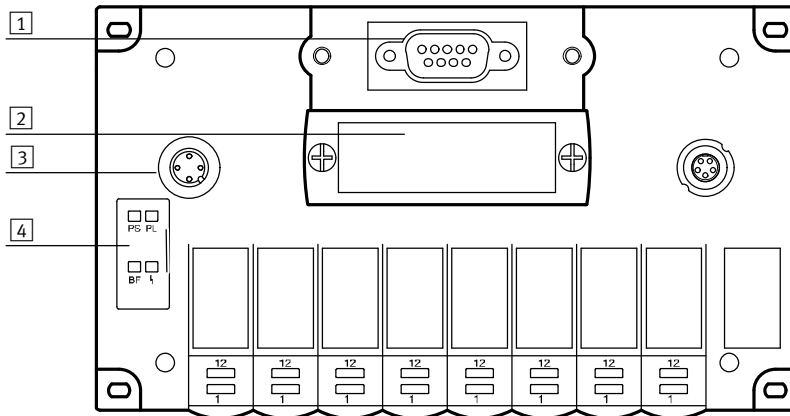

- 1 Fieldbus connection (9-pin Sub-D socket)
- 2 Removable switch cover
- 3 Operating/load voltage connection (4-pin M12 plug)
- 4 Power LEDs (PS, PL) and bus status LEDs (BF)

Pin allocation for PROFIBUS DP interface (viewed on plug)









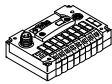

	Pin	Signal	Description
	1	n.c.	Not connected
	2	n.c.	Not connected
	3	RxD/TxD-P	Received/transmitted data P
	4	CNTR-P	Repeater control signal
	5	DGND	Data reference potential (M5V)
	6	VP	Supply voltage positive (P5V)
	7	n.c.	Not connected
	8	RxD/TxD-N	Received/transmitted data N
	9	n.c.	Not connected
	Housing	Screened	Connection to functional earth

Pin allocation for M12 adapter

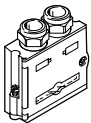
	Pin	Signal	Description
	1	VP	Supply voltage positive (P5V)
	2	RxD/TxD-N	Received/transmitted data N
	3	DGND	Data reference potential (M5V)
	4	RxD/TxD-P	Received/transmitted data P
	5	FE	Functional earth

Fieldbus Direct, CPV-DI02-8

Accessories – Fieldbus node CPV-DI02-8

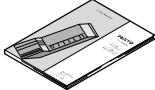
Ordering data			
Designation		Part No.	Type
Fieldbus node			
	CPV10	546188	CPV10-GEDI02-8
	CPV14	546190	CPV14-GEDI02-8
	CPV18	546192	CPV18-GEDI02-8
Switch module			
	For setting bus parameters and device configuration in the case of CPV	165814	CPV10/14/18-GE-DI-SM
Power supply			
	Power supply socket, straight, M12x1, 4-pin	18497	FBSD-GD-7
		18495	FBSD-GD-9
	Power supply socket, angled, M12x1, 4-pin	18524	FBSD-WD-7
		18525	FBSD-WD-9
Fieldbus connection			
	Fieldbus socket, Sub-D connection	532216	FBS-SUB-9-GS-DP-B
	M12 adapter	525632	FBA-2-M12-5POL
Bus connection, 5-pin screw terminal strip			
	Open Style adapter for 5-pin terminal strip	525634	FBA-1-SL-5POL
	5-pin terminal strip	525635	FBSD-KL-2x5POL
Valve terminal connection			
	Connecting cable, angled plug, angled socket	0.25 m	540327 KVI-CP-3-WS-WD-0,25
		0.5 m	540328 KVI-CP-3-WS-WD-0,5
		2 m	540329 KVI-CP-3-WS-WD-2
		5 m	540330 KVI-CP-3-WS-WD-5
		8 m	540331 KVI-CP-3-WS-WD-8
	Connecting cable, straight plug, straight socket	2 m	540332 KVI-CP-3-GS-GD-2
		5 m	540333 KVI-CP-3-GS-GD-5
		8 m	540334 KVI-CP-3-GS-GD-8
User documentation			
	User documentation for CPV Direct, CPV fieldbus node DI02-8	German	548731 P.BE-CPV-DI02-DE
		English	548732 P.BE-CPV-DI02-EN
		Spanish	548733 P.BE-CPV-DI02-ES
		French	548734 P.BE-CPV-DI02-FR
		Italian	548735 P.BE-CPV-DI02-IT

Fieldbus Direct, CPVSC1-AE16-DP

Technical data – Fieldbus node CPVSC1-AE16-DP

FESTO



CPV-SC fieldbus node for communication between a CPV-SC valve terminal and a fieldbus master. The fieldbus node is used for activation of a CPV-SC valve terminal with up to 16 solenoid coils on max. 16 valve positions and for displaying the switching status via LED.

The CPV-SC... valves are activated via automatic current reduction, which results in less power consumption and heat emission. 32 digital inputs and outputs can be connected via a serial CP string extension.



Application

Bus connection

The bus connection is established via a 9 pin Sub-D socket with a typical PROFIBUS allocation (to EN 50170). The bus connector plug facilitates the

connection of an incoming and an outgoing bus cable. There is no internal bus terminating resistor.

Condition monitoring

Condition monitoring supports preventative maintenance which is part of the function chain in automation systems. Each valve is assigned a switching

cycle counter that automatically registers movements of the system components. Once a maximum number of activa-

tions is reached, a message is sent to the controller via PROFIBUS and maintenance can be started. In the same way condition monitoring supports the

determining of service intervals for the function chain. All movements immediately after installation are registered.

Fieldbus Direct, CPVSC1-AE16-DP



Technical data – Fieldbus node CPVSC1-AE16-DP

General technical data			
Type	CPVSC1-AE16-DP		
Fieldbus interface	Sub-D socket, 9-pin		
Electrical isolation of fieldbus interface	Via optocoupler		
Baud rate	[kbps]	9.6 ... 12,000; automatic detection	
Addressing range	0 ... 125 Set using rotary switch		
CP string extension	Yes, 32 inputs and outputs		
LED display (bus-specific)	BF	Bus fault	
LED display (product-specific)	PS	Common message regarding power supply	
	PL	Power supply for valves	
	SF	CP system fault	
Type of communication	DPV0: Cyclical communication		
Protocol	PROFIBUS		
Max. no. of solenoid coils	16		
Device-specific diagnostics	<ul style="list-style-type: none"> • Short circuit/overload of outputs • Short circuit/overload of inputs • Undervoltage of valve terminal • Undervoltage of valve terminal (extension) • Undervoltage of output module • Undervoltage of sensor supply • Missing module on the CP/CPI string • Condition monitoring 		
Parameterisation	Via GSD file		
Additional functions	<ul style="list-style-type: none"> • Condition counter • Tool change function 		
Operating voltage	Nominal value	[V DC]	24, reverse polarity protected
	Permissible range	[V]	20.4 ... 26.4
	Residual ripple	[Vss]	4
	Power failure bridging	[ms]	20
Current consumption	[mA]	Max. 200 + sensor supply	
Protection class to EN 60529	IP40		
Materials	Polyamide		
Note on materials	RoHS-compliant		
Dimensions (L x W x D)	[mm]	78 x 113 x 40	
Weight	[g]	200	
Technical data on valves	➔ Internet: cpv-sc		

Operating and environmental conditions			
Ambient temperature	[°C]	-5 ... +50	
Storage temperature	[°C]	-20 ... +50	

Fieldbus Direct, CPVSC1-AE16-DP

Technical data – Fieldbus node CPVSC1-AE16-DP

Connection and display components

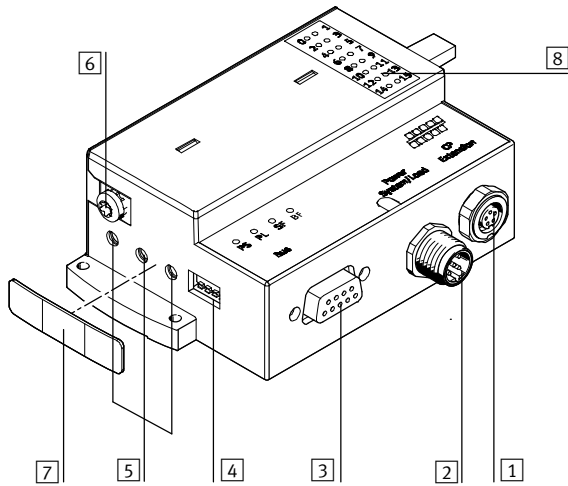

- 1 Connection for CP extension
- 2 Connection for power supply
- 3 Connection for fieldbus
- 4 DIL switch for CP extension
- 5 Rotary switch for station number
- 6 Earth terminal
- 7 Cover (for IP40 protection)
- 8 Switching status display per valve

Pin allocation for PROFIBUS DP interface





Pin allocation	Pin	Signal	Description
Sub-D plug socket on the valve terminal			
	1	n.c.	Not connected
	2	n.c.	Not connected
	3	RxD/TxD-P	Received/transmitted data P
	4	CNTR-P ¹⁾	Repeater control signal
	5	DGND	Data reference potential (M5V)
	6	VP	Supply voltage (P5V)
	7	n.c.	Not connected
	8	RxD/TxD-N	Received/transmitted data N
	9	n.c.	Not connected
	Housing	Screened	Connection to housing

1) The repeater control signal CNTR-P is realised as a TTL signal.

Fieldbus Direct, CPVSC1-AE16-DP

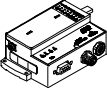
FESTO

Accessories – Fieldbus node CPVSC1-AE16-DP

Ordering data				
Designation			Part No.	Type
Fieldbus node				
	Fieldbus node		541919	CPVSC1-AE16-DP
Power supply Micro Style M12				
	M12, 5-pin, straight socket (A-coded)		18324	FBSD-GD-9-5POL
Valve terminal connection				
	Connecting cable, angled plug, angled socket	0.25 m	540327	KVI-CP-3-WS-WD-0,25
		0.5 m	540328	KVI-CP-3-WS-WD-0,5
		2 m	540329	KVI-CP-3-WS-WD-2
		5 m	540330	KVI-CP-3-WS-WD-5
		8 m	540331	KVI-CP-3-WS-WD-8
	Connecting cable, straight plug, straight socket	2 m	540332	KVI-CP-3-GS-GD-2
		5 m	540333	KVI-CP-3-GS-GD-5
		8 m	540334	KVI-CP-3-GS-GD-8
User documentation				
	User documentation for valve terminal CPV-SC-DP	German	548725	P.BE-CPASC-CPVSC-DP-DE
		English	548726	P.BE-CPASC-CPVSC-DP-EN
		French	548728	P.BE-CPASC-CPVSC-DP-FR
		Italian	548729	P.BE-CPASC-CPVSC-DP-IT
		Spanish	548727	P.BE-CPASC-CPVSC-DP-ES

Fieldbus Direct, CPV-DN2

Technical data – Fieldbus node CPV-DN2



CPV fieldbus node for communication between a CPV valve terminal and a fieldbus master. The fieldbus node is used for activation of a CPV valve terminal with 8 valve slices and 16 solenoid coils and for displaying the switching status via LED.

The CPV-... valves are activated via automatic current reduction, which results in less power consumption and heat emission. 16 digital inputs and 8 digital outputs or 16 solenoid coils can be connected via a serial CP string extension.

The CPV fieldbus node supports the DeviceNet protocol and conforms to the device profile of the pneumatic valve.

The CPV fieldbus node is available in three sizes, with identical performance characteristics:

- CPV10
- CPV14
- CPV18



Application

Bus connection

Screw terminals

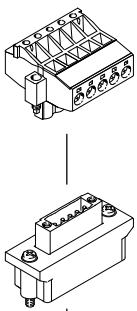

Plug connector 2xM12

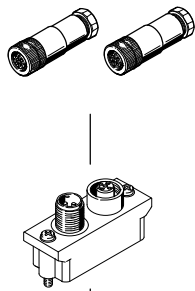

Sub-D fieldbus plug

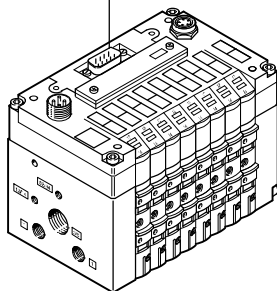
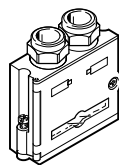

Sub-D socket

- 9-pin Sub-D socket
- Installation with IP65 protection

The bus connection is established via a 9 pin Sub-D socket with a typical PROFIBUS allocation (to EN 50170). The bus connector plug (with protection class IP65 from Festo or IP20 from other manufacturers) facilitates the connection of an incoming and an outgoing bus cable. An active bus terminal can be connected using the integrated DIL switch. The Sub-D interface is designed for the activation of network components via a fibre optic cable connection.

M12 adapter

- Plug connector 2xM12
- Installation with IP65 protection

Alternatively the bus connection can be established via a 2x M12 adapter (A-coded).

Screw terminals

• 5-pin screw terminal strip for installation in protected environments (IP20). The bus connection is established via a 5-pin row. If the valve terminal is ordered with this bus connection, the 5-pin screw terminal strip will also be supplied. It is designed with double screw terminals for the incoming and the outgoing bus cable. This connection technology provides a T-distributor function.

Fieldbus Direct, CPV-DN2

Technical data – Fieldbus node CPV-DN2

Condition monitoring			
Condition monitoring supports preventative maintenance which is part of the function chain in automation systems. Each valve is assigned a switching	cycle counter that automatically registers movements of the system components. Once a maximum number of activa-	tions is reached, a message is sent to the controller via DeviceNet and maintenance can be started. In the same way condition monitoring supports the	determining of service intervals for the function chain. All movements immediately after installation are registered.

General technical data				
Type		CPV10-GE-DN2-8	CPV14-GE-DN2-8	CPV18-GE-DN2-8
Fieldbus interface		Either <ul style="list-style-type: none"> • Sub-D socket, 9-pin • Screw terminal strip, 5-pin • Socket and plug, M12x1, 5-pin, A-coded 		
Electrical isolation of the fieldbus interface		Via optocoupler		
Baud rates	[kbps]	125, 250, 500; set using a switch module		
Addressing range		0 ... 63; set using a switch module		
CP string extension		Yes, 16 inputs and 8 outputs (or 16 valves)		
LED diagnostics displays	PS	Common message regarding power supply		
	MNS	DeviceNet status		
Product family		Pneumatic valve (27 dec.)		
Ident. number		8942 dec.		
Type of communication		Polling, change of state, strobed I/O		
Configuration support		EDS file and graphics symbol		
Max. no. of solenoid coils		16		
Max. no. of solenoid coils with string extension		32		
Max. no. of outputs		8 (1x16 solenoid coils omitted)		
Max. no. of inputs		16		
Device-specific diagnostics		<ul style="list-style-type: none"> • Short circuit/overload of outputs • Short circuit/overload of inputs • Undervoltage of valve terminal • Undervoltage of valve terminal (extension) • Undervoltage of output module • Undervoltage of sensor supply • Missing module on the CP/CPI string • Condition monitoring 		
Additional functions		Condition counter		
Operating voltage	Nominal value	[V DC]	24, reverse polarity protected	
	Permissible range	[V DC]	20.4 ... 26.4	
	Residual ripple	[Vss]	4	
	Power failure bridging	[ms]	20	
Current consumption		[mA]	Max. 200 + sensor supply	
Protection class to EN 60529			<ul style="list-style-type: none"> • IP20 with 5-pin screw terminal strip • IP65 Sub-D, socket/plug M12x1 	
Materials	Housing		Die-cast aluminium	
	Cover		Polyamide, glass fibre (Ultramide)	
	Seal		Nitrile rubber, Neoprene	
Dimensions			➔ Internet: cpv	
Weight				
Technical data on valves				

Operating and environmental conditions		
Ambient temperature	[°C]	-5 ... +50
Storage temperature	[°C]	-20 ... +70
Fieldbus certification		ODVA
Certification		cULus recognized (OL)
CE symbol (see declaration of conformity)		In accordance with EU EMC directive
Note on materials		RoHS-compliant

Fieldbus Direct, CPV-DN2

Technical data – Fieldbus node CPV-DN2

Connection and display components

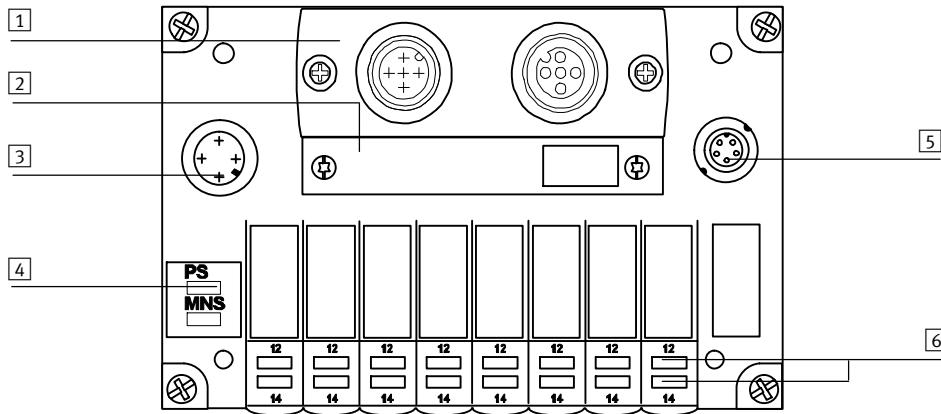

- 1 Interchangeable fieldbus connection:
 - Micro Style connection (2xM12)
 - Open Style connection (terminal strip)
 - 9-pin Sub-D plug
- 2 Switch module (removable)
- 3 Connection for power supply (4-pin M12 plug, operating voltage for electronics, load voltage for CP valves)
- 4 LEDs:
 - Power status (PS)
 - Module/network status (MNS)
- 5 CP extension connection
- 6 Switching status displays of CPV solenoid coils

Pin allocation for DeviceNet interface (viewed on plug)

	Pin	Signal	Description
	1	n.c.	Not connected
	2	CAN_L	CAN Low
	3	CAN_GND	0 V CAN interface
	4	n.c.	Not connected
	5	Screened	Optional screened connection
	6	GND	Ground optional
	7	CAN_H	CAN high
	8	n.c.	Not connected
	9	CAN_V+	24 V supply CAN interface

Pin allocation for M12 adapter









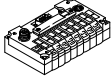

	Pin	Signal-specific wire colour	Signal	Description
	1	blank	Screened	Connection to housing
	2	red	24 V DC bus	24 V supply CAN interface
	3	black	0 V bus	0 V CAN interface
	4	white	CAN_H	Received/transmitted data high
	5	blue	CAN_L	Received/transmitted data low

Pin allocation for Open Style adapter

	Pin	Signal-specific wire colour	Signal	Description
	1	black	0 V bus	0 V CAN interface
	2	blue	CAN_L	Received/transmitted data low
	3	blank	Screened	Connection to housing
	4	white	CAN_H	Received/transmitted data high
	5	red	24 V DC bus	24 V supply CAN interface

Fieldbus Direct, CPV-DN2

Accessories – Fieldbus node CPV-DN2

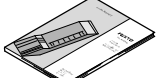
Ordering data			
Designation		Part No.	Type
Fieldbus node			
	CPV10	525630	CPV10-GE-DN2-8
	CPV14	525878	CPV14-GE-DN2-8
	CPV18	525880	CPV18-GE-DN2-8
Switch module			
	For setting bus parameters and device configuration in the case of CPV	165814	CPV10/14/18-GE-DI-SM
Power supply			
	Power supply socket, straight M12x1, 4-pin	18497	FBSD-GD-7
		18495	FBSD-GD-9
	Power supply socket, angled M12x1, 4-pin	18524	FBSD-WD-7
		18525	FBSD-WD-9
Bus connection Micro Style M12			
	Bus connection Micro Style, 2xM12	525632	FBA-2-M12-5POL
	Fieldbus socket for Micro Style connection, M12, 5-pin, straight	18324	FBSD-GD-9-5POL
	Plug for Micro Style connection, M12, 5-pin, straight	175380	FBS-M12-5GS-PG9
Bus connection Open Style, 5-pin screw terminal strip			
	Bus connection Open Style for 5-pin terminal strip	525634	FBA-1-SL-5POL
	Bus connection, 5-pin terminal strip	525635	FBSD-KL-2x5POL
Valve terminal connection			
	Connecting cable, angled plug, angled socket	0.25 m	540327 KVI-CP-3-WS-WD-0,25
		0.5 m	540328 KVI-CP-3-WS-WD-0,5
		2 m	540329 KVI-CP-3-WS-WD-2
		5 m	540330 KVI-CP-3-WS-WD-5
		8 m	540331 KVI-CP-3-WS-WD-8
	Connecting cable, straight plug, straight socket	2 m	540332 KVI-CP-3-GS-GD-2
		5 m	540333 KVI-CP-3-GS-GD-5
		8 m	540334 KVI-CP-3-GS-GD-8
User documentation			
	User documentation for CPV Direct, CPV fieldbus node DN2	German	526016 P.BE-CP-DN2-DE
		English	526017 P.BE-CP-DN2-EN
		Italian	526018 P.BE-CP-DN2-IT
		French	526019 P.BE-CP-DN2-FR
		Spanish	526020 P.BE-CP-DN2-ES

Fieldbus Direct, CPV-DN3-8

Technical data – Fieldbus node CPV-DN3-8



CPV fieldbus node according to the CP system with Specification “B” for communication between a CPV valve terminal and a fieldbus master. The fieldbus node is used for activation of a CPV valve terminal with 8 valve slices and 16 solenoid coils and for displaying the switching status via LED.

The CPV-... valves are activated via automatic current reduction, which results in less power consumption and heat emission. 32 digital inputs and outputs or 32 solenoid coils can be connected via a serial CPI string extension.

The CPV fieldbus node is available in three sizes, with identical performance characteristics:

- CPV10
- CPV14
- CPV18



Application

Bus connection

Screw terminals

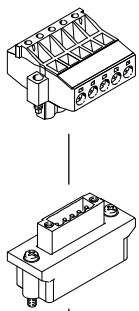

Plug connector 2xM12

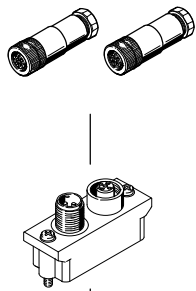

Sub-D fieldbus plug

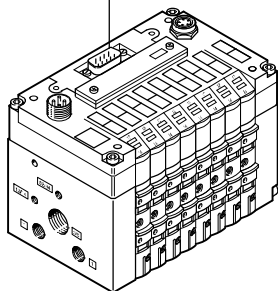
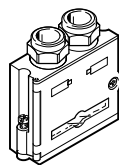

Sub-D socket

- 9-pin Sub-D socket
- Installation with IP65 protection

The bus connection is established via a 9-pin Sub-D socket. The bus connector plug (with protection class IP65 from Festo or IP20 from other manufacturers) facilitates the connection of an incoming and an outgoing bus cable. An active bus terminal can be connected using the integrated DIL switch. The Sub-D interface is designed for the activation of network components via a fibre optic cable connection.

M12 adapter

- Plug connector 2xM12
- Installation with IP65 protection

Alternatively the bus connection can be established via a 2x M12 adapter (B-coded).

Screw terminals

5-pin screw terminal strip for installation in protected environments (IP20). The bus connection is established via a 5-pin row. If the valve terminal is ordered with this bus connection, the 5-pin screw terminal strip will also be supplied. It is designed with double screw terminals for the incoming and the outgoing bus cable. This connection technology provides a T-distributor function.

Fieldbus Direct, CPV-DN3-8

Technical data – Fieldbus node CPV-DN3-8

Condition monitoring			
Condition monitoring supports preventative maintenance which is part of the function chain in automation systems.	cycle counter that automatically registers movements of the system components.	tions is reached, a message is sent to the controller via DeviceNet and maintenance can be started. In the same way condition monitoring supports the	determining of service intervals for the function chain.
Each valve is assigned a switching	Once a maximum number of activa-		All movements immediately after installation are registered.

General technical data				
Type		CPV10-GE-DN3-8	CPV14-GE-DN3-8	CPV18-GE-DN3-8
Fieldbus interface	Either	<ul style="list-style-type: none"> Screw terminal strip, 5-pin Sub-D socket, 9-pin Socket and plug, M12x1, 5-pin, A-coded 		
Electrical isolation of fieldbus interface		Via optocoupler		
CP string extension		Yes, 32 inputs and 32 outputs		
Baud rates	[kbps]	125, 250, 500; set using a switch module		
Addressing range		0 ... 63; set using a switch module		
Product identification	Product type	Pneumatic valve (27 dec.)		
Product identification	Product code	8942 dec.		
Types of communication		Polling, change of state, strobed I/O		
Configuration support		EDS file and graphics symbol		
Max. no. of solenoid coils		16		
Max. no. of solenoid coils with string extension		48		
Max. no. of outputs		16 solenoid coils and 32 outputs		
Max. no. of inputs		32		
LED diagnostic displays	PS	Common message regarding power supply		
LED display	Bus-specific	MNS: DeviceNet status		
LED display	Product-specific	Valve switching status		
	Power	Operating voltage for electrics and load supply		
Device-specific diagnostics		<ul style="list-style-type: none"> Short circuit/overload of outputs Short circuit/overload of inputs Undervoltage of valve terminal Undervoltage of valve terminal (extension) Undervoltage of output module Undervoltage of sensor supply Missing module on CP string Condition monitoring 		
Additional functions		Condition counter		
Operating voltage	Nominal value	[V DC]	24, reverse polarity protected	
	Permissible range	[V]	20.4 ... 26.4	
	Residual ripple	[Vss]	4	
	Power failure bridging	[ms]	10	
Current consumption		[mA]	Max. 200 + sensor supply	
Protection class to EN 60529			<ul style="list-style-type: none"> IP20 with 5-pin screw terminal strip IP65 Sub-D, socket/plug M12x1 	
Materials	Housing		Die-cast aluminium	
Materials	Cover		Reinforced polyamide	
Materials	Seal		Nitrile rubber	
Dimensions			➔ Internet: cpv	
Weight				
Technical data on valves				

Operating and environmental conditions			
Ambient temperature		[°C]	-5 ... +50
Storage temperature		[°C]	-20 ... +70
Fieldbus certification			ODVA
Certification			cULus recognized (OL)
CE symbol (see declaration of conformity)			In accordance with EU EMC directive
Note on materials			RoHS-compliant

Fieldbus Direct, CPV-DN3-8

Technical data – Fieldbus node CPV-DN3-8

Connection and display components

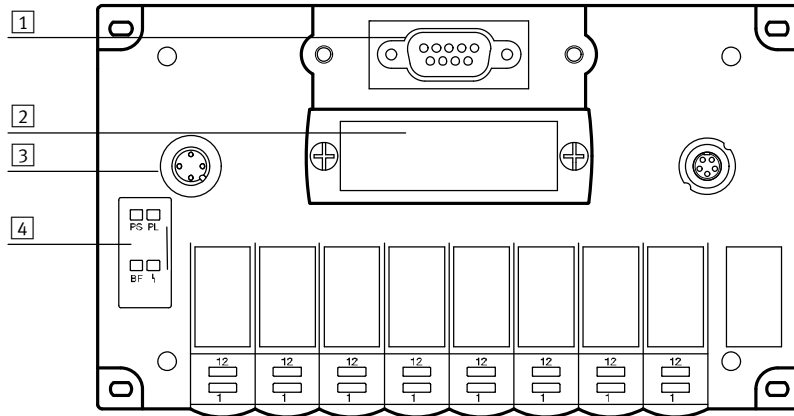

- 1 Fieldbus connection (9-pin Sub-D socket)
- 2 Removable switch cover
- 3 Operating/load voltage connection (4-pin M12 plug)
- 4 Power LEDs (PS, PL) and bus status LEDs (BF)

Pin allocation for DeviceNet interface (viewed on plug)

	Pin	Signal	Description
	1	n.c.	Not connected
	2	CAN_L	CAN Low
	3	CAN_GND	0 V CAN interface
	4	n.c.	Not connected
	5	Screened	Optional screened connection
	6	GND	Ground optional
	7	CAN_H	CAN high
	8	n.c.	Not connected
	9	CAN_V+	24 V supply CAN interface

Pin allocation for M12 Micro Style adapter









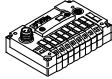

	Pin	Signal-specific wire colour	Signal	Description
	1	blank	Screened	Connection to housing
	2	red	24 V DC bus	24 V supply CAN interface
	3	black	0 V bus	0 V CAN interface
	4	white	CAN_H	Received/transmitted data high
	5	blue	CAN_L	Received/transmitted data low

Pin allocation for Open Style adapter

	Pin	Signal-specific wire colour	Signal	Description
	1	black	0 V bus	0 V CAN interface
	2	blue	CAN_L	Received/transmitted data low
	3	blank	Screened	Connection to housing
	4	white	CAN_H	Received/transmitted data high
	5	red	24 V DC bus	24 V DC supply CAN interface

Fieldbus Direct, CPV-DN3-8

Accessories – Fieldbus node CPV-DN3-8

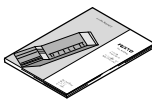
Ordering data			
Designation		Part No.	Type
Fieldbus node			
	CPV10	546198	CPV10-GE-DN3-8
	CPV14	546200	CPV14-GE-DN3-8
	CPV18	546202	CPV18-GE-DN3-8
Switch module			
	For setting bus parameters and device configuration in the case of CPV	165814	CPV10/14/18-GE-DI-SM
Power supply			
	Power supply socket, straight M12x1, 4-pin	18497	FBSD-GD-7
		18495	FBSD-GD-9
	Power supply socket, angled M12x1, 4-pin	18524	FBSD-WD-7
		18525	FBSD-WD-9
Bus connection Micro Style M12			
	Bus connection Micro Style, 2xM12	525632	FBA-2-M12-5POL
	Fieldbus socket for Micro Style connection, M12, 5-pin, straight	18324	FBSD-GD-9-5POL
	Plug for Micro Style connection, M12, 5-pin, straight	175380	FBS-M12-5GS-PG9
Bus connection Open Style, 5-pin screw terminal strip			
	Bus connection Open Style for 5-pin terminal strip	525634	FBA-1-SL-5POL
	Bus connection, 5-pin terminal strip	525635	FBSD-KL-2x5POL
Valve terminal connection			
	Connecting cable, angled plug, angled socket	0.25 m	540327 KVI-CP-3-WS-WD-0,25
		0.5 m	540328 KVI-CP-3-WS-WD-0,5
		2 m	540329 KVI-CP-3-WS-WD-2
		5 m	540330 KVI-CP-3-WS-WD-5
		8 m	540331 KVI-CP-3-WS-WD-8
	Connecting cable, straight plug, straight socket	2 m	540332 KVI-CP-3-GS-GD-2
		5 m	540333 KVI-CP-3-GS-GD-5
		8 m	540334 KVI-CP-3-GS-GD-8
User documentation			
	User documentation for CPV Direct, CPV fieldbus node DN3	German	548737 P.BE-CPV-DN3-DE
		English	548738 P.BE-CPV-DN3-EN
		Italian	548741 P.BE-CPV-DN3-IT
		French	548740 P.BE-CPV-DN3-FR
		Spanish	548739 P.BE-CPV-DN3-ES

Fieldbus Direct, CPV-C02

Technical data – Fieldbus node CPV-C02

FESTO

CANopen

CPV fieldbus node for communication between a CPV valve terminal and a fieldbus master. The fieldbus node is used for activation of a CPV valve terminal with 8 valve slices and 16 solenoid coils and for displaying the switching status via LED.

The CPV-... valves are activated via automatic current reduction, which results in less power consumption and heat emission. 16 digital inputs and 8 digital outputs or 16 solenoid coils can be connected via a serial CP string extension.

The CPV fieldbus node is available in three sizes, with identical performance characteristics:

- CPV10
- CPV14
- CPV18



Application

Bus connection

Screw terminals

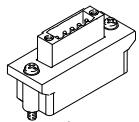
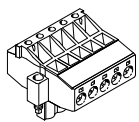

Plug connector 2xM12

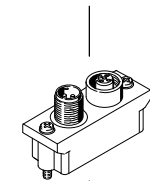
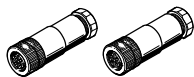

Sub-D fieldbus plug

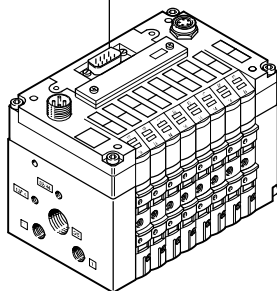
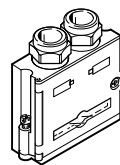

The branch line length does not apply to any type of connection used.

Screw terminals

- 5-pin screw terminal strip
- For installations in protected environments (IP20)

The bus connection is established via a 5-pin row.

If the valve terminal is ordered with this bus connection, the 5-pin screw terminal strip will also be supplied. It is designed with double screw terminals for the incoming and the outgoing bus cable. This connection technology provides a T-distributor function.

Plug connector 2xM12

- Plug connector 2xM12
- Installation with IP65 protection

The bus connection is established via an M12 plug and socket.

The bus connection fulfils the requirement of a T-distributor, this means that the CPV valve terminal can be disconnected from the bus without interrupting the bus.

Sub-D fieldbus plug

- 9-pin Sub-D plug
 - Installation with IP65 protection
- The bus connection is established via a 9-pin Sub-D plug as per the CAN in Automation (CiA) specification DS102 with additional 24 V CAN transceiver supply (option as per DS102). The bus connector plug facilitates the connection of an incoming and an outgoing bus cable. There are spring-loaded terminals for the four wires (CAN_L, CAN_H, 24 V, 0 V) of the incoming and outgoing bus cable.

Fieldbus Direct, CPV-C02

Technical data – Fieldbus node CPV-C02

FESTO

Condition monitoring

Condition monitoring supports preventative maintenance which is part of the function chain in automation systems.

Each valve is assigned a switching

cycle counter that automatically registers movements of the system components.

Once a maximum number of activa-

tions is reached, a message is sent to the controller via CANopen and maintenance can be started. In the same way condition monitoring supports the

determining of service intervals for the function chain.

All movements immediately after installation are registered.

General technical data				
Type		CPV10-GE-C02-8	CPV14-GE-C02-8	CPV18-GE-C02-8
Fieldbus interface	Either	<ul style="list-style-type: none"> • Sub-D socket, 9-pin • Socket and plug, M12x1, 5-pin, A-coded • Screw terminal strip, 5-pin 		
Baud rates		[kbps]	125, 250, 500, 1000; set using a switch module	
CP string extension			Yes, 16 inputs and 8 outputs (or 16 valves)	
Addressing range			Node ID 1 ... 127; set using a switch element	
LED display (bus-specific)	MNS		CANopen status	
LED display (product-specific)	PS		Electronics supply and load voltage supply Valve switching status	
Type of communication			To DS401	
Product identification			Product family: Digital I/O DS 401, vendor code: 0xD	
Number of PDOs			1 Tx/Rx	
Number of SDOs			1 server SDO	
Configuration support			EDS file and bitmaps	
Max. no. of solenoid coils			16	
Max. no. of solenoid coils with string extension			32	
Max. no. of outputs			8 (1x16 solenoid coils omitted)	
Max. no. of inputs			16	
Device-specific diagnostics			<ul style="list-style-type: none"> • Missing module on the CP string • Short circuit/overload of outputs • Short circuit/overload of inputs • Undervoltage of output module • Undervoltage of sensor supply • Undervoltage of valve terminal • Via emergency message and object 1001/1002/1003 • Condition monitoring 	
Parameterisation			Via SDO	
Additional functions			Condition counter	
Operating voltage	Nominal value	[V DC]	24, reverse polarity protected	
	Permissible range	[V]	20.4 ... 26.4	
	Residual ripple	[Vss]	4	
	Power failure bridging	[ms]	10	
Current consumption		[mA]	Max. 200 + sensor supply	
Protection class to EN 60529			<ul style="list-style-type: none"> • IP20 with 5-pin screw terminal strip • IP65 Sub-D, socket/plug M12x1 	
Materials	Housing		Die-cast aluminium	
	Cover		Reinforced polyamide	
	Seal		Nitrile rubber	
Dimensions			➔ Internet: cpv	
Weight				
Technical data on valves				

Operating and environmental conditions

Ambient temperature	[°C]	-5 ... +50
Storage temperature	[°C]	-20 ... +70
Fieldbus certification		CIA
Certification		cULus recognized (OL)
CE symbol (see declaration of conformity)		In accordance with EU EMC directive
Note on materials		RoHS-compliant

Fieldbus Direct, CPV-C02

Technical data – Fieldbus node CPV-C02



Connection and display components

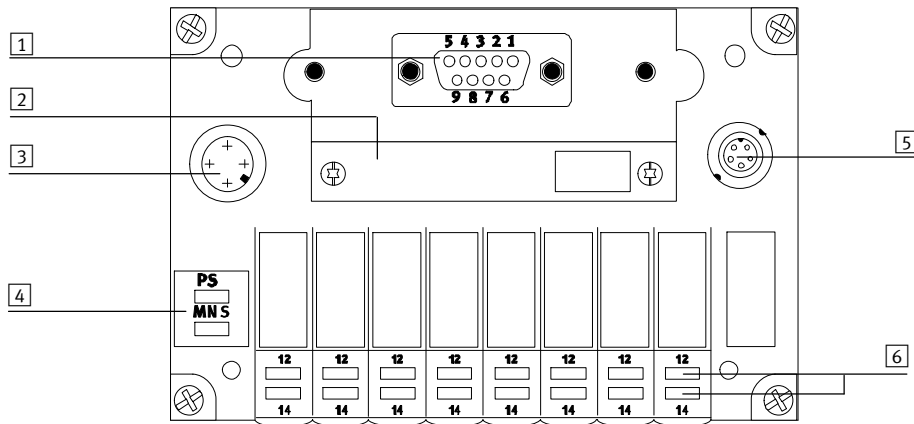

- 1 Fieldbus connection:
– 9-pin Sub-D plug
- 2 Switch module (removable)
- 3 Connection for power supply
(4-pin M12 plug, operating voltage for electronics, load voltage for CP valves)
- 4 LEDs:
– Power status (PS)
– Module/network status (MNS)
- 5 CP extension connection
- 6 Switching status displays of CPV solenoid coils

Pin allocation for CANopen interface (viewed on plug)

	Pin	Signal	Description
	1	n.c.	Not connected
	2	CAN_L	Received/transmitted data low
	3	CAN_GND	0 V CAN interface
	4	n.c.	Not connected
	5	CAN_Shld	Optional screened connection
	6	GND	Ground
	7	CAN_H	Received/transmitted data high
	8	n.c.	Not connected
	9	CAN_V+	24 V supply CAN interface
	Housing	Screened	Connection to FE

Pin allocation for M12 adapter









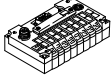

	Pin	Signal	Description
	1	Screened	Connection to housing
	2	CAN_V+	24 V supply CAN interface
	3	CAN_GND	0 V CAN interface
	4	CAN_H	Received/transmitted data high
	5	CAN_L	Received/transmitted data low

Pin allocation for Open Style adapter

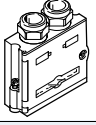
	Pin	Signal	Description
	1	CAN_GND	0 V CAN interface
	2	CAN_L	Received/transmitted data low
	3	Screened	Connection to housing
	4	CAN_H	Received/transmitted data high
	5	CAN_V+	24 V supply CAN interface

Fieldbus Direct, CPV-CO2

Accessories – Fieldbus node CPV-CO2

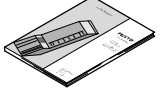
Ordering data			
Designation		Part No.	Type
Fieldbus node			
	CPV10	525876	CPV10-GE-CO2-8
	CPV14	525882	CPV14-GE-CO2-8
	CPV18	525884	CPV18-GE-CO2-8
Switch module			
	For setting bus parameters and device configuration in the case of CPV	165814	CPV10/14/18-GE-DI-SM
Power supply			
	Power supply socket, straight M12x1, 4-pin	18497	FBSD-GD-7
		18495	FBSD-GD-9
	Power supply socket, angled M12x1, 4-pin	18524	FBSD-WD-7
		18525	FBSD-WD-9
Bus connection			
	Sub-D plug for CANopen	532219	FBS-SUB-9-BU-2x5POL-B
Bus connection 2xM12			
	M12 adapter	525632	FBA-2-M12-5POL
	Fieldbus socket, M12, 5-pin, straight	18324	FBSD-GD-9-5POL
	Plug, M12, 5-pin, straight	175380	FBS-M12-5GS-PG9
Bus connection, 5-pin screw terminal strip			
	Open Style adapter for 5-pin terminal strip	525634	FBA-1-SL-5POL
	5-pin terminal strip	525635	FBSD-KL-2x5POL
Valve terminal connection			
	Connecting cable, angled plug, angled socket	0.25 m	540327 KVI-CP-3-WS-WD-0,25
		0.5 m	540328 KVI-CP-3-WS-WD-0,5
		2 m	540329 KVI-CP-3-WS-WD-2
		5 m	540330 KVI-CP-3-WS-WD-5
		8 m	540331 KVI-CP-3-WS-WD-8
	Connecting cable, straight plug, straight socket	2 m	540332 KVI-CP-3-GS-GD-2
		5 m	540333 KVI-CP-3-GS-GD-5
		8 m	540334 KVI-CP-3-GS-GD-8
User documentation			
	User documentation for CPV Direct, CPV fieldbus node CO2	German	526009 P.BE-CP-CO2-DE
		English	526010 P.BE-CP-CO2-EN
		Spanish	526011 P.BE-CP-CO2-ES
		French	526012 P.BE-CP-CO2-FR
		Italian	526013 P.BE-CP-CO2-IT

Fieldbus Direct, CPV-C03-8

Technical data – Fieldbus node CPV-C03-8

FESTO

CANopen

CPV fieldbus node according to the CP system with Specification “B” (enhanced functionality) for communication between a CPV valve terminal and a fieldbus master. The fieldbus node is used for activation of a CPV valve terminal with 8 valve slices and 16 solenoid coils and for displaying the switching status via LED.

The CPV-... valves are activated via automatic current reduction, which results in less power consumption and heat emission. 32 digital inputs and outputs or 32 solenoid coils can be connected via a serial CPI string extension.

The CPV fieldbus node is available in three sizes, with identical performance characteristics:

- CPV10
- CPV14
- CPV18



Application

Bus connection

Screw terminals

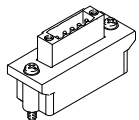
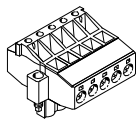

Plug connector 2xM12

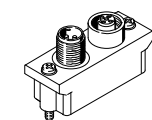
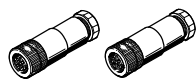

Sub-D fieldbus plug

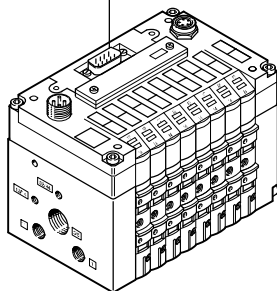
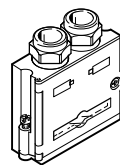

The branch line length does not apply to any type of connection used.

Screw terminals

- 5-pin screw terminal strip
- For installation in protected environments (IP20)

The bus connection is established via a 5-pin row.

If the valve terminal is ordered with this bus connection, the 5-pin screw terminal strip will also be supplied. It is designed with double screw terminals for the incoming and the outgoing bus cable. This connection technology provides a T-distributor function.

Plug connector 2xM12

- Plug connector 2xM12
- Installation with IP65 protection

The bus connection is established via an M12 plug and socket.

The bus connection fulfils the requirement of a T-distributor, which means that the CPV valve terminal can be disconnected from the bus without interrupting the bus.

Sub-D fieldbus plug

- 9-pin Sub-D plug
 - Installation with IP65 protection
- The bus connection is established via a 9-pin Sub-D plug as per the CAN in Automation (CiA) specification DS102 with additional 24 V CAN transceiver supply (option as per DS102). The bus connector plug facilitates the connection of an incoming and an outgoing bus cable. There are spring-loaded terminals for the four wires (CAN_L, CAN_H, 24 V, 0 V) of the incoming and outgoing bus cable.

Fieldbus Direct, CPV-C03-8

Technical data – Fieldbus node CPV-C03-8

Condition monitoring			
Condition monitoring supports preventative maintenance which is part of the function chain in automation systems. Each valve is assigned a switching	cycle counter that automatically registers movements of the system components. Once a maximum number of activa-	tions is reached, a message is sent to the controller via CANopen and maintenance can be started. In the same way condition monitoring supports the	determining of service intervals for the function chain. All movements immediately after installation are registered.

General technical data				
Type		CPV10-GE-C03-8	CPV14-GE-C03-8	CPV18-GE-C03-8
Fieldbus interface	Either	<ul style="list-style-type: none"> Screw terminal strip, 5-pin Sub-D socket, 9-pin Socket and plug, M12x1, 5-pin, A-coded 		
Electrical isolation of the fieldbus interface		Via optocoupler		
Note on the fieldbus interface		<ul style="list-style-type: none"> 24 VDC version CAN interface via bus Interface to CiA DS102 		
CP string extension		Yes, 32 inputs and 32 outputs		
Baud rates	[kbps]	125, 250, 500 and 1000; set using DIL switch		
Addressing range		Node ID 1 ... 127; set using DIL switch		
Product identification		Product family: Digital I/O DS401, vendor code: 0xD		
Number of PDOs		1 Tx/Rx		
Number of SDOs		1 server SDO		
Configuration support		EDS file and bitmaps		
Max. address capacity, inputs	[Byte]	8		
Max. address capacity, outputs	[Byte]	8		
Max. no. of solenoid coils		16		
Max. no. of solenoid coils with string extension		48		
Max. no. of outputs		16 solenoid coils and 32 outputs		
Max. no. of inputs		32		
LED displays (bus-specific)	MNS	Bus status (module/network status)		
LED displays (product-specific)		Valve switching status		
	PS	Operating voltage for electronics and load supply		
Device-specific diagnostics		<ul style="list-style-type: none"> Short circuit/overload of outputs Condition monitoring Short circuit/overload of inputs Undervoltage of valves Undervoltage of valve terminal Undervoltage of output module Undervoltage of valve terminal extension Undervoltage of sensor supply Missing module on the CP/CPI string Via emergency message and object 1001, 1002 and 1003 		
Parameterisation		Via SDO		
Additional functions		Condition counter		
Operating voltage	Nominal value	[V DC]	24, reverse polarity protected	
	Permissible range	[V]	20.4 ... 26.4	
	Residual ripple	[Vss]	4	
	Power failure bridging	[ms]	10	
Current consumption		[mA]	Max. 200 + sensor supply	
Protection class to EN 60529			<ul style="list-style-type: none"> IP20 with 5-pin screw terminal strip IP65 Sub-D, socket/plug M12x1 	
Materials	Housing		Die-cast aluminium	
	Cover		Reinforced polyamide	
	Seals		Nitrile rubber, polychloroprene rubber	
Dimensions			➔ Internet: cpv	
Weight				
Technical data on valves				

Fieldbus Direct, CPV-C03-8

Technical data – Fieldbus node CPV-C03-8



Operating and environmental conditions		
Ambient temperature	[°C]	−5 ... +50
Storage temperature	[°C]	−20 ... +70
Fieldbus certification		CIA
Certification		cULus recognized (OL) CE, CIA certification
CE symbol (see declaration of conformity)		In accordance with EU EMC directive
Note on materials		RoHS-compliant

Connection and display components

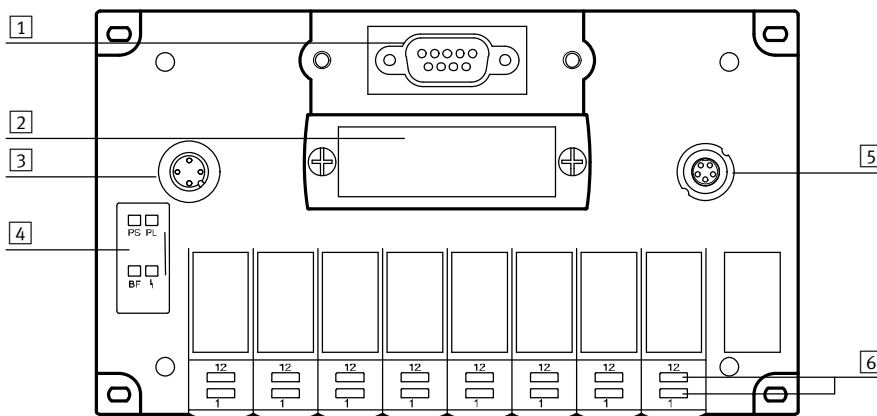

- 1 Fieldbus connection (9-pin Sub-D socket)
- 2 Removable switch cover
- 3 Operating/load voltage connection (4-pin M12 plug)
- 4 Power LEDs (PS, PL) and bus status LEDs (BF)
- 5 CPI extension connection
- 6 Switching status displays of CP solenoid coils

Pin allocation for CANopen interface (viewed on plug)

	Pin	Signal	Description
	1	n.c.	Not connected
	2	CAN_L	Received/transmitted data low
	3	CAN_GND	0 V CAN interface
	4	n.c.	Not connected
	5	CAN_Shld	Optional screened connection
	6	GND	Ground
	7	CAN_H	Received/transmitted data high
	8	n.c.	Not connected
	9	CAN_V+	24 V supply CAN interface
	Housing	Screened	Connection to FE

Pin allocation for M12 adapter







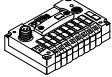

	Pin	Signal	Description
	1	Screened	Connection to housing
	2	CAN_V+	24 V supply CAN interface
	3	CAN_GND	0 V CAN interface
	4	CAN_H	Received/transmitted data high
	5	CAN_L	Received/transmitted data low

Pin allocation for Open Style adapter

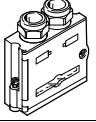
	Pin	Signal	Description
	1	CAN_GND	0 V CAN interface
	2	CAN_L	Received/transmitted data low
	3	Screened	Connection to housing
	4	CAN_H	Received/transmitted data high
	5	CAN_V+	24 V supply CAN interface

Fieldbus Direct, CPV-C03-8

Accessories – Fieldbus node CPV-C03-8

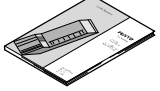
Ordering data			
Designation		Part No.	Type
Fieldbus node			
	CPV10	546204	CPV10-GE-C03-8
	CPV14	546206	CPV14-GE-C03-8
	CPV18	546208	CPV18-GE-C03-8
Power supply			
	Power supply socket, straight, M12x1, 4 pin	18497	FBSD-GD-7
		18495	FBSD-GD-9
	Power supply socket, angled, M12x1, 4 pin	18524	FBSD-WD-7
		18525	FBSD-WD-9
Bus connection			
	Sub-D plug for CANopen	532219	FBS-SUB-9-BU-2x5POL-B
Bus connection 2xM12			
	M12 adapter	525632	FBA-2-M12-5POL
	Fieldbus socket, M12, 5-pin, straight	18324	FBSD-GD-9-5POL
	Plug, M12, 5-pin, straight	175380	FBS-M12-5GS-PG9
Bus connection, 5-pin screw terminal strip			
	Open Style adapter for 5-pin terminal strip	525634	FBA-1-SL-5POL
	5-pin terminal strip	525635	FBSD-KL-2x5POL
Valve terminal connection			
	Connecting cable, angled plug, angled socket	0.25 m	540327 KVI-CP-3-WS-WD-0,25
		0.5 m	540328 KVI-CP-3-WS-WD-0,5
		2 m	540329 KVI-CP-3-WS-WD-2
		5 m	540330 KVI-CP-3-WS-WD-5
		8 m	540331 KVI-CP-3-WS-WD-8
	Connecting cable, straight plug, straight socket	2 m	540332 KVI-CP-3-GS-GD-2
		5 m	540333 KVI-CP-3-GS-GD-5
		8 m	540334 KVI-CP-3-GS-GD-8
User documentation			
	User documentation for CPV Direct, CPV fieldbus node C03	German	548743 P.BE-CPV-C03-DE
		English	548744 P.BE-CPV-C03-EN
		Spanish	548745 P.BE-CPV-C03-ES
		French	548746 P.BE-CPV-C03-FR
		Italian	548747 P.BE-CPV-C03-IT

Fieldbus Direct, CPV-IB

Technical data – Fieldbus node CPV-IB



CPV fieldbus node for communication between a CPV valve terminal and an INTERBUS master. The fieldbus node is used for activation of a CPV valve terminal with 8 valve slices and 16 solenoid coils and for displaying the switching status via LED. The CPV-... valves are activated via automatic current reduction, which results in less power consumption and heat emission. 16 digital inputs and 8 digital outputs or 16 solenoid coils can be connected via a serial CP string extension. The CPV fieldbus node IB supports the INTERBUS fieldbus protocol and represents a remote bus station. The CPV fieldbus node is available in three sizes, with identical performance characteristics:

- CPV10
- CPV14
- CPV18



Application

Bus connection

Sub-D socket

INTERBUS incoming

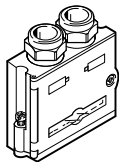

Sub-D plug

INTERBUS outgoing

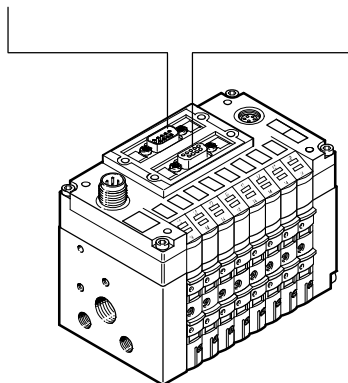
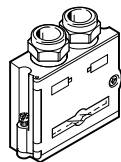

The bus connection is established via a 9-pin Sub-D socket and a 9-pin Sub-D plug with a typical INTERBUS pin allocation.

The bus connector plugs (with protection class IP65 from Festo or IP20 from other manufacturers) facilitate the connection of the incoming and the outgoing bus cable. The outgoing bus plug contains the typical INTERBUS RBST bridge for identification of the outgoing bus connection.

The Sub-D interfaces are designed for the control of network components using a fibre optic cable connection.

Fieldbus Direct, CPV-IB

Technical data – Fieldbus node CPV-IB

General technical data				
Type		CPV10-GE-IB-8	CPV14-GE-IB-8	CPV18-GE-IB-8
Fieldbus interface		Sub-D, 9-pin, socket and pin		
Electrical isolation of the fieldbus interface		Via optocoupler		
Baud rates	[kbps]	500, 2000; set using a DIL switch		
CP/CPI string extension		Yes, 16 inputs and 8 outputs (or 16 valves)		
Bus type		Remote bus		
Profile		12 (digital I/O devices)		
PCP channel		No		
Configuration support		Icons for CMD software		
Max. no. of solenoid coils		16		
Max. no. of solenoid coils with string extension		32		
Max. no. of outputs		8 (16 solenoid coils omitted)		
Max. no. of inputs		16		
Max. no. of process data bits	Inputs	32		
	Outputs	32		
LED displays (bus-specific)	BA	Bus active		
	RC	Remotebus check		
	RD	Remotebus disable		
	UL	Operating voltage of INTERBUS interface		
LED display (product-specific)		Valve switching status		
	Diagnostics	Short circuit, load supply, sensor supply, configuration error		
	Pow	Operating voltage and load supply		
Device-specific diagnostics		<ul style="list-style-type: none"> • Short circuit/overload of outputs • Short circuit/overload of inputs • Undervoltage of valve terminal • Undervoltage of valve terminal (extension) • Undervoltage of output module • Undervoltage of sensor supply • Missing module on the CP string • Via peripherals errors 		
Parameterisation		No		
Additional functions		Diagnostics using status bits (inputs)		
Operating voltage	Nominal value	[V DC]	24, reverse polarity protected	
	Permissible range	[V]	20.4 ... 26.4	
	Residual ripple	[Vss]	4	
	Power failure bridging	[ms]	10	
Current consumption		[mA]	Max. 200 + sensor supply	
Protection class to EN 60529			IP65	
Materials	Housing		Die-cast aluminium	
	Cover		Reinforced polyamide	
	Seals		Nitrile rubber, polychloroprene rubber	
Dimensions			➔ Internet: cpv	
Weight				
Technical data on valves				

Operating and environmental conditions			
Ambient temperature	[°C]		-5 ... +50
Storage temperature	[°C]		-20 ... +70
Fieldbus certification			INTERBUS club
Certification			cULus recognized (OL)
CE symbol (see declaration of conformity)			In accordance with EU EMC directive

Fieldbus Direct, CPV-IB

Technical data – Fieldbus node CPV-IB

Connection and display components

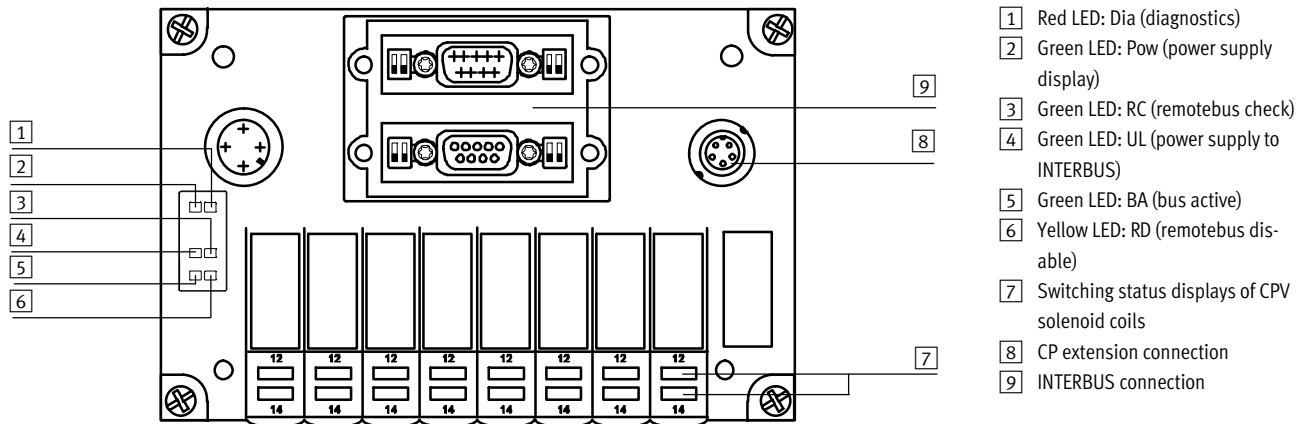

Pin allocation for INTERBUS interface, incoming (viewed on plug)

	Pin	Signal	Description
	1	DO1	Data out
	2	/DI1	Data in
	3	GND	Reference conductor/ground
	4	n.c.	Not connected
	5	n.c.	Not connected
	6	/DO1	Data out inverse
	7	/DI1	Data in inverse
	8	n.c.	Not connected
	9	n.c.	Not connected
	Housing	Screened	Connection to functional earth via R/C combination





Pin allocation for INTERBUS interface, outgoing (viewed on socket)

	Pin	Signal	Description
	1	DO2	Data out
	2	/DI2	Data in
	3	GND	Reference conductor/ground
	4	n.c.	Not connected
	5	+5 V	Station detection ¹⁾
	6	/DO2	Data out inverse
	7	/DI2	Data in inverse
	8	n.c.	Not connected
	9	RBST	Station detection ¹⁾
	Housing	Screened	Connection to functional earth via R/C combination

1) The incoming interface is electrically isolated from the CPX peripherals. The plug housing is connected to the FE of the CPX terminal via an R/C combination. The CPX terminal contains the protocol chip SUPI 3 OPC. This ensures automatic detection of additional connected INTERBUS stations. There is therefore no need for a bridge between pin 5 and pin 9.

Fieldbus Direct, CPV-IB

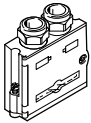
Accessories – Fieldbus node CPV-IB

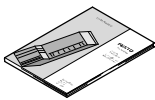
Ordering data				
Designation			Part No.	Type
Fieldbus node				
	CPV10		197177	CPV10-GE-IB-8
	CPV14		197179	CPV14-GE-IB-8
	CPV18		197181	CPV18-GE-IB-8
Power supply				
	Power supply socket, straight M12x1, 4-pin		18497	FBSD-GD-7
			18495	FBSD-GD-9
	Power supply socket, angled M12x1, 4-pin		18524	FBSD-WD-7
			18525	FBSD-WD-9
Bus connection				
	Fieldbus plug, Sub-D connection for INTERBUS incoming		532218	FBS-SUB-9-BU-IB-B
	Fieldbus plug, Sub-D connection for INTERBUS outgoing		532217	FBS-SUB-9-GS-IB-B
Valve terminal connection				
	Connecting cable, angled plug, angled socket	0.25 m	540327	KVI-CP-3-WS-WD-0,25
		0.5 m	540328	KVI-CP-3-WS-WD-0,5
		2 m	540329	KVI-CP-3-WS-WD-2
		5 m	540330	KVI-CP-3-WS-WD-5
		8 m	540331	KVI-CP-3-WS-WD-8
	Connecting cable, straight plug, straight socket	2 m	540332	KVI-CP-3-GS-GD-2
		5 m	540333	KVI-CP-3-GS-GD-5
		8 m	540334	KVI-CP-3-GS-GD-8
User documentation				
	User documentation for CPV Direct, CPV fieldbus node IB	German	527515	P.BE-CP-IB-DE
		English	527516	P.BE-CP-IB-EN
		Spanish	527517	P.BE-CP-IB-ES
		French	527518	P.BE-CP-IB-FR
		Italian	527519	P.BE-CP-IB-IT

Fieldbus Direct, CPV-IP

Technical data – Fieldbus node CPV-IP

FESTO

BECKHOFF

CPV fieldbus node for communication between a CPV valve terminal and an IP-Link coupler box. The fieldbus node is used for activation of a CPV valve terminal with 8 valve slices and 16 solenoid coils and for displaying the switching status via LED.

The CPV-... valves are activated via automatic current reduction, which results in less power consumption and heat emission.

The CPV fieldbus node supports the fieldbus protocol IP-Link.

The CPV fieldbus node is available in two sizes, with identical performance characteristics:

- CPV10
- CPV14



Application

Bus connection

The bus connection is established using two IP-Link fibre optic cable connectors.

The bus connector plugs (with protection class IP65) facilitate the connection of the incoming and outgoing fibre optic cable (FOC).

Power supply

The power is supplied via a 4-pin M8 connection (socket). The supply to the internal logic is fully electrically isolated from the supply to the solenoid coils.

The second M8 connection (pin) enables power to be supplied to additional CPV IP-Link valve terminals and other IP-Link modules.

Fieldbus Direct, CPV-IP

Technical data – Fieldbus node CPV-IP

General technical data		
Type		CPV10-GE-IP-8 CPV14-GE-IP-8
Fieldbus interface		IP-Link Incoming, outgoing
Electrical isolation of the fieldbus interface		FOC
CP string extension		No
Baud rates	[kbps]	2000
Data model	Compact	16 outputs
Configuration support	PROFIBUS	GSD file
	INTERBUS	Not necessary
	CANopen	EDS file
	DeviceNet	EDS file
Max. no. of solenoid coils		16
LED displays (bus-specific)	US	Operating voltage of internal logic
	UP	Operating voltage of valves
	RUN	Bus active
	ERR	Data transmission error
Product identification		Product family 4: Valves
Device-specific diagnostics		IE4404
Parameterisation		Via register communication: watchdog setting for coils 1 ... 16
Operating voltage	Nominal value	[V DC] 24, reverse polarity protected
	Permissible range	[V] 20.4 ... 28.8
	Power failure bridging	[ms] 10
	Residual ripple	[Vss] 4
Current consumption	Logic	[mA] Max. 100
	Valves	Depending on valve type
Protection class to EN 60529		IP65
Materials	Housing	Die-cast aluminium
	Cover	Reinforced polyamide
	Seals	Nitrile rubber, polychloroprene rubber
Dimensions		➔ Internet: cpv
Weight		
Technical data on valves		

Operating and environmental conditions		
Ambient temperature	[°C]	-5 ... +50
Storage temperature	[°C]	-20 ... +70
Certification		cULus recognized (OL)
CE symbol (see declaration of conformity)		In accordance with EU EMC directive
Note on materials		RoHS-compliant

Fieldbus Direct, CPV-IP

Technical data – Fieldbus node CPV-IP

Connection and display components

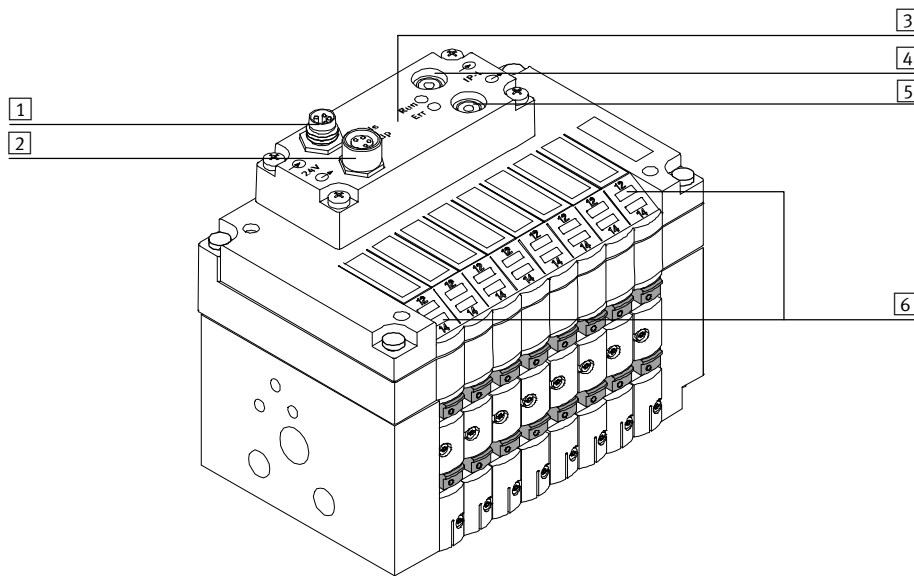

- 1 Connection for power supply, incoming (M8, 4-pin, plug)
- 2 Connection for power supply, outgoing (M8, 4-pin, socket)
- 3 LEDs:
 - US: Operating voltage for electronics (green)
 - UP: Load voltage for valves (green)
 - RUN: Bus active (green)
 - ERR: Error (red)
- 4 Fieldbus connection, incoming (IP-Link fibre optic cable IP65 socket)
- 5 Fieldbus connection, outgoing (IP-Link fibre optic cable IP65 socket)
- 6 LEDs (yellow) for switching status display of CPV solenoid coils

Power supply, incoming

	Pin	Signal
	1	24 V DC operating voltage for electronics (US)
	2	24 V DC load voltage for valves (UP)
	3	0 V electronics (US)
	4	0 V valves (UP)

Power supply, outgoing

	Pin	Signal
	1	24 V DC operating voltage for electronics (US)
	2	24 V DC load voltage for valves (UP)
	3	0 V electronics (US)
	4	0 V valves (UP)

Fieldbus Direct, CPV-IP

Technical data – Fieldbus node CPV-IP

Equipotential bonding

Example of connection with electrical isolation of operating and load voltage with 2 PELV power supply units

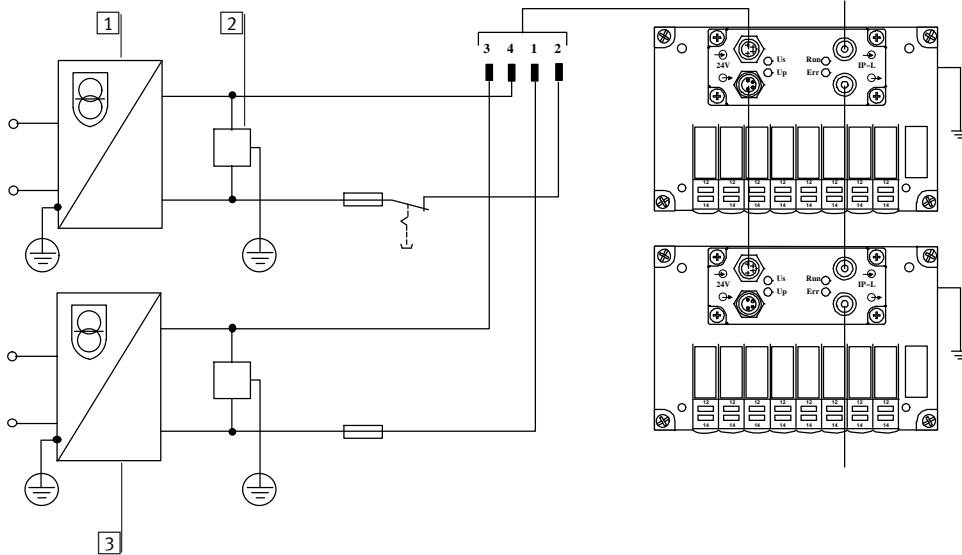

- 1 Power supply unit for load voltage
- 2 Device for isolation monitoring
- 3 Power supply unit for operating voltage

CPV Direct is prepared for the connection with electrical isolation of operating and load voltage.

Example of connection with PELV power supply unit and equipotential bonding

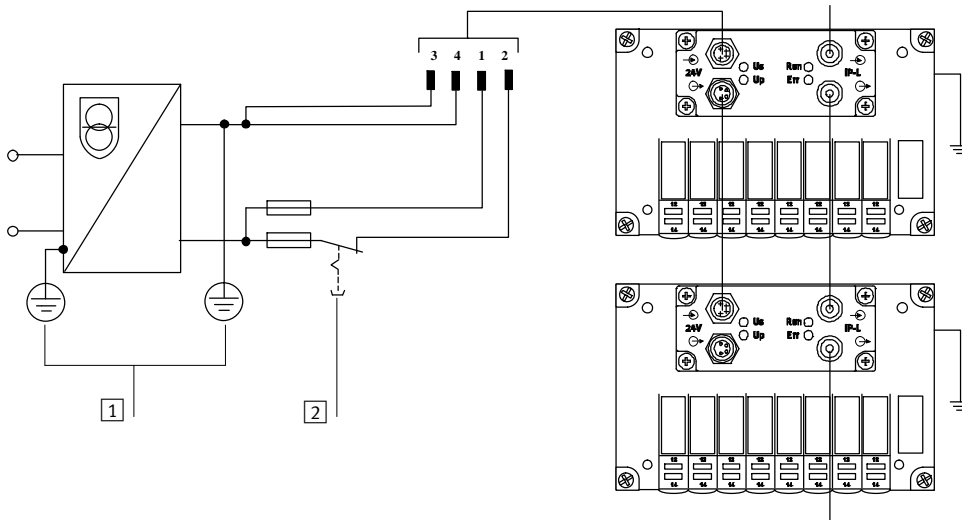

- 1 PE and equipotential bonding
- 2 Load voltage (can be disconnected separately) plus external fuses

The CPV valve terminal has an earth terminal for equipotential bonding on the end plate.

Ordering data

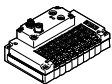
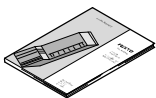
Designation		Part No.	Type
Fieldbus node			
	CPV10	534509	CPV10-GE-IP-8
	CPV14	534507	CPV14-GE-IP-8
User documentation			
	User documentation for CPV Direct, CPV fieldbus node IP	German	534516 P.BE-CPV-DI-IP-DE
		English	534517 P.BE-CPV-DI-IP-EN

Fieldbus Direct, CPV-CC-8

Technical data – Fieldbus node CPV-CC-8

FESTO

CC-Link

CPV fieldbus node for communication between a CPV valve terminal and a higher-order master for Control & Communication-Link (CC-Link) from Mitsubishi. The fieldbus node is used for activation of a CPV valve terminal with 8 valve slices and 16 solenoid coils and for displaying the switching status via LED.

The CPV-... valves are activated via automatic current reduction, which results in less power consumption and heat emission. A CP input module with 16 digital inputs can be connected via a serial CP string extension.

The CPV fieldbus node is available in three sizes, with identical performance characteristics:

- CPV10
- CPV14
- CPV18



Application

Bus connection

The bus connection can be selected when ordering and is established by means of:

- a terminal strip with IP20 protection
- a Sub-D plug with IP65 protection

from Festo

- a Sub-D plug with IP20 protection from other manufacturers

All connection types have an integrated T-distributor function and thus support the connection of an incoming

and outgoing bus cable.

The integrated interface with RS 485 transmission technology is designed for the typical CC-Link 3-wire connection technology (in accordance with CLPA CC-Link Spec. V1.11).

CC-Link implementation

The CPV fieldbus node supports one station per slave.

Cyclical data transmission for the solenoid coils, digital inputs and

status information is conducted using the bit and word ranges (Rx/Ry/RWr/RWw).

Fieldbus Direct, CPV-CC-8

Technical data – Fieldbus node CPV-CC-8

General technical data				
Type		CPV10-GE-CC-8	CPV14-GE-CC-8	CPV18-GE-CC-8
Fieldbus interface		Either <ul style="list-style-type: none"> • 9-pin Sub-D socket • Screw terminal strip, 5-pin 		
CP string extension		Yes 16 inputs (connection of an additional CP valve terminal or CP output module not possible)		
Baud rates	[kbps]	156 ... 10,000; set using DIL switch		
Addressing range		1 ... 64; set using DIL switch		
No. of stations per slave		1 station, Permanent setting		
Vendor code		0x0177		
Product identification		Machine type 0x3C		
LED displays (bus-specific)	RUN	Communication OK		
LED displays (bus-specific)	Pow/Err	Operating voltage/CRC error or communication error		
LED displays (product-specific)		Valve switching status		
Type of communication		Cyclical communication		
Max. no. of solenoid coils		16		
Max. no. of outputs		0		
Max. no. of inputs		16		
Device-specific diagnostics		<ul style="list-style-type: none"> • Short circuit/overload of inputs • Undervoltage of valve terminal • Undervoltage of sensor supply • Missing module on the CP string • Remote ready • Via status byte 		
Parameterisation		Hold/clear via DIL switch		
Additional functions		8-bit system status in the bit range (Rx)		
Operating voltage	Nominal value	[V DC]	24, reverse polarity protected	
	Permissible range	[V]	20.4 ... 26.4	
	Power failure bridging	[ms]	20	
Current consumption		[mA]	Max. 200 + sensor supply	
Protection class to EN 60529			IP20, IP65 (Sub-D)	
Materials	Housing		Die-cast aluminium	
	Cover		Reinforced polyamide	
	Seals		Nitrile rubber, polychloroprene rubber	
Dimensions			→ Internet: cpv	
Weight				
Technical data on valves				

Operating and environmental conditions				
Ambient temperature		[°C]	-5 ... +50	
Storage temperature		[°C]	-20 ... +50	
Certification			cULus recognized (OL)	
CE symbol (see declaration of conformity)			In accordance with EU EMC directive	
Note on materials			RoHS-compliant	

Fieldbus Direct, CPV-CC-8

Technical data – Fieldbus node CPV-CC-8

Connection and display components

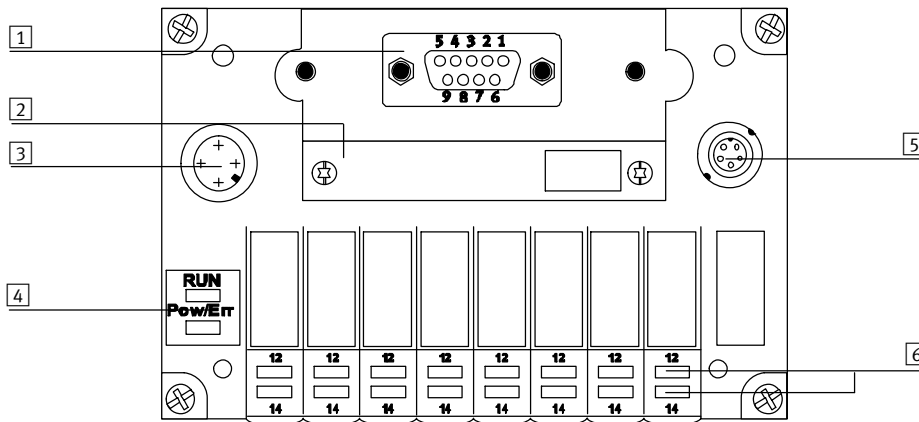

- 1 Fieldbus connection, 9-pin Sub-D socket
- 2 Switch module (removable)
- 3 Connection for power supply (4-pin M12 plug, operating voltage for electronics/sensors, load voltage for CP valves)
- 4 LEDs:
 - Data communication (RUN)
 - Operating voltage/error (Pow/Err)
- 5 CP extension connection
- 6 Switching status displays of CP solenoid coils

Pin allocation for Sub-D interface (socket view)

	Pin	Signal	Description
	1	n.c.	Not connected
	2	DA	Data A
	3	DG	Data reference potential
	4	n.c.	Not connected
	5	n.c.	FE via R/C combination (not used with CC-Link: connection via R/C combination to FE (1 Mohm/220 nF))
	6	n.c.	Not connected
	7	CAN_H	Data B
	8	n.c.	Not connected
	9	n.c.	Not connected
	Housing	SLD	Screened

Pin allocation for terminal strip

	Pin	Signal	Description
	1	FG	Functional earth/housing
	2	SLD	Screened
	3	DG	Data reference potential
	4	DB	Data B
	5	DA	Data A

Fieldbus Direct, CPV-CC-8



Accessories – Fieldbus node CPV-CC-8

Ordering data			
Designation		Part No.	Type
Fieldbus node			
	CPV10	197959	CPV10-GE-CC-8
	CPV14	197967	CPV14-GE-CC-8
	CPV18	197969	CPV18-GE-CC-8
Switch module			
	For setting bus parameters and device configuration in the case of CPV	165814	CPV10/14/18-GE-DI-SM
Power supply			
	Power supply socket, straight, M12x1, 4-pin	18497	FBSD-GD-7
		18495	FBSD-GD-9
	Power supply socket, angled, M12x1, 4-pin	18524	FBSD-WD-7
		18525	FBSD-WD-9
Bus connection Open Style, 5-pin screw terminal strip			
	Bus connection, 5-pin terminal strip for CC-Link	197962	FBA-1-KL-5POL
	Fieldbus plug, Sub-D connection	532220	FBS-SUB-9-GS-2x4POL-B
Valve terminal connection			
	Connecting cable, angled plug, angled socket	0.25 m	540327 KVI-CP-3-WS-WD-0,25
		0.5 m	540328 KVI-CP-3-WS-WD-0,5
		2 m	540329 KVI-CP-3-WS-WD-2
		5 m	540330 KVI-CP-3-WS-WD-5
		8 m	540331 KVI-CP-3-WS-WD-8
	Connecting cable, straight plug, straight socket	2 m	540332 KVI-CP-3-GS-GD-2
		5 m	540333 KVI-CP-3-GS-GD-5
		8 m	540334 KVI-CP-3-GS-GD-8
User documentation			
	User documentation for CPV Direct, CPV fieldbus node CC	German	197963 P.BE-CP-CC-DE
		English	197964 P.BE-CP-CC-EN
		Japanese	197965 P.BE-CP-CC-J

Product Range and Company Overview

A Complete Suite and Company Overview

Our experienced engineers provide complete support at every stage of your development process, including: conceptualization, analysis, engineering, design, assembly, documentation, validation, and production.



Custom Automation Components
Complete custom engineered solutions



Custom Control Cabinets
Comprehensive engineering support and on-site services



Complete Systems
Shipment, stocking and storage services

The Broadest Range of Automation Components

With a comprehensive line of more than 30,000 automation components, Festo is capable of solving the most complex automation requirements.



Electromechanical
Electromechanical actuators, motors, controllers & drivers



Pneumatics
Pneumatic linear and rotary actuators, valves, and air supply



PLCs and I/O Devices
PLC's, operator interfaces, sensors and I/O devices

Supporting Advanced Automation... As No One Else Can!

Festo is a leading global manufacturer of pneumatic and electromechanical systems, components and controls for industrial automation, with more than 16,000 employees in 60 national headquarters serving more than 180 countries. For more than 80 years, Festo has continuously elevated the state of manufacturing with innovations and optimized motion control solutions that deliver higher performing, more profitable automated manufacturing and processing equipment. Our dedication to the advancement of automation extends beyond technology to the education and development of current and future automation and robotics designers with simulation tools, teaching programs, and on-site services.

Quality Assurance, ISO 9001 and ISO 14001 Certifications

Festo Corporation is committed to supply all Festo products and services that will meet or exceed our customers' requirements in product quality, delivery, customer service and satisfaction.

To meet this commitment, we strive to ensure a consistent, integrated, and systematic approach to management that will meet or exceed the requirements of the ISO 9001 standard for Quality Management and the ISO 14001 standard for Environmental Management.



© Copyright 2013, Festo Corporation. While every effort is made to ensure that all dimensions and specifications are correct, Festo cannot guarantee that publications are completely free of any error, in particular typing or printing errors. Accordingly, Festo cannot be held responsible for the same. For Liability and Warranty conditions, refer to our "Terms and Conditions of Sale", available from your local Festo office. All rights reserved. No part of this publication may be reproduced, distributed, or transmitted in any form or by any means, electronic, mechanical, photocopying or otherwise, without the prior written permission of Festo. All technical data subject to change according to technical update.



Printed on recycled paper at New Horizon Graphic, Inc., FSC certified as an environmental friendly printing plant.

Festo North America

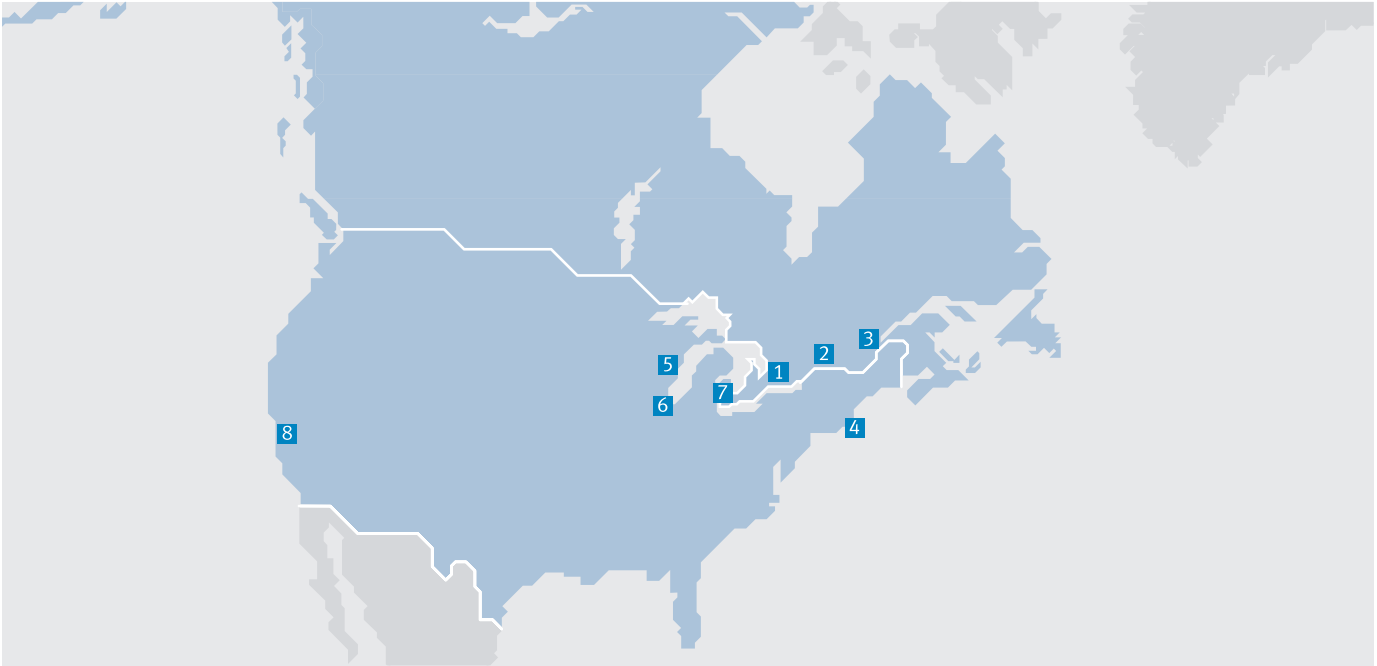

**1 Festo Canada
Headquarters
Festo Inc.**
5300 Explorer Drive
Mississauga, ON
L4W 5G4

2 Montréal
5600, Trans-Canada
Pointe-Claire, QC
H9R 1B6

3 Québec City
2930, rue Watt#117
Québec, QC
G1X 4G3



**4 Festo United States
Headquarters
Festo Corporation**
395 Moreland Road
Hauppauge, NY
11788

5 Appleton
North 922 Tower View Drive, Suite N
Greenville, WI
54942

7 Detroit
1441 West Long Lake Road
Troy, MI
48098

6 Chicago
85 W Algonquin - Suite 340
Arlington Heights, IL
60005

8 Silicon Valley
4935 Southfront Road, Suite F
Livermore, CA
94550

Festo Regional Contact Center

Canadian Customers

Commercial Support:
Tel: 1 877 GO FESTO (1 877 463 3786)
Fax: 1 877 FX FESTO (1 877 393 3786)
Email: festo.canada@ca.festo.com

Technical Support:

Tel: 1 866 GO FESTO (1 866 463 3786)
Fax: 1 877 FX FESTO (1 877 393 3786)
Email: technical.support@ca.festo.com

USA Customers

Commercial Support:
Tel: 1 800 99 FESTO (1 800 993 3786)
Fax: 1 800 96 FESTO (1 800 963 3786)
Email: customer.service@us.festo.com

Technical Support:

Tel: 1 866 GO FESTO (1 866 463 3786)
Fax: 1 800 96 FESTO (1 800 963 3786)
Email: product.support@us.festo.com