

Axial kits EAMM-A

FESTO



Axial kits EAMM-A

Type codes

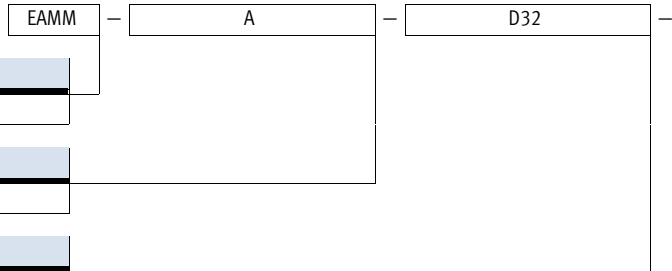

Type	
EAMM	Kit

Motor configuration	
A	Axial

Axis mechanism interface	
D19	EGSL-35
D32	ESBF-32, EGSL-45, ERMB-20, EHMB-20
D32-35A	ERMB-20, EHMB-20
D40	ESBF-40, EGSL-55, ERMB-25, EHMB-25
D50	ESBF-50
D60	ESBF-63, EGSL-75, ERMB-32, EHMB-32
D80	ESBF-80
D100	ESBF-100
E20	DGE-18-...-SP, DMES-18
E32	DGE-25-...-SP, DMES-25
E48	DGE-40-...-SP, DMES-40
E72	DGE-63-...-SP, DMES-63
F28	DGEA-18
F30	DGE-25-...-ZR
F32	DGEA-25
F37	DGE-25-...-ZR-RF
F40	DGE-40-...-ZR, DGEA-40
F47	DGE-40-...-ZR-RF
F62	DGE-63-...-ZR
F80	DGE-63-...-ZR-RF
G13	DGE-8-...-ZR
G16	DGE-12-...-ZR
G19	DGE-18-...-ZR
L27	EGC-50-...-TB
L38	EGC-70-...-TB
L48	EGC-80-...-TB
L62	EGC-120-...-TB
L95	EGC-185-...-TB
M43	EGC-HD-125-...-TB
M48	EGC-HD-160-...-TB
M80	EGC-HD-220-...-TB
N38	ELGA-TB-...-70
N48	ELGA-TB-...-80
N80	ELGA-TB-...-120
L95	ELGA-TB-KF-150
P3-28D	EGSK-15
P4-28B	EGSK-20/EGSP-20
P5-28B	EGSK-26/EGSP-26
P6-38A	EGSK-33
P8-38A	EGSK-46, EGSP-33
P10-38A	EGSP-46
R27	ELGG-...-35, ELGR-...-35
R38	ELGG-...-45, ELGR-...-45
R48	ELGG-...-55, ELGR-...-55
S38	EGC-70-...-BS, EGC-HD-125-...-BS, ELGA-BS-...-70
S48	EGC-80-...-BS, EGC-HD-160-...-BS, ELGA-BS-...-80
S62	EGC-120-...-BS, EGC-HD-220-...-BS, ELGA-BS-...-120
S95	EGC-185-...-BS, ELGA-BS-...-150

Axial kits EAMM-A

Type codes

60P	-	
-----	---	--

Motor interface	
40P	Servo motor EMME-AS-40
60P	Servo motor EMME-AS-60
80P	Servo motor EMME-AS-80
40A	Servo motor EMMS-AS-40
55A	Servo motor EMMS-AS-55
70A	Servo motor EMMS-AS-70
100A	Servo motor EMME-AS-100, EMMS-AS-100
140A	Servo motor EMMS-AS-140
190A	Servo motor EMMS-AS-190
28A	Stepper motor EMMS-ST-28
42A	Stepper motor EMMS-ST-42
57A	Stepper motor EMMS-ST-57
87A	Stepper motor EMMS-ST-87
32B	Motor unit MTR-DCI-32-...-G7/G14
42B	Motor unit MTR-DCI-42-...-G7
42C	Motor unit MTR-DCI-42-...-G14
52B	Motor unit MTR-DCI-52-...-G7
52C	Motor unit MTR-DCI-52-...-G14
62B	Motor unit MTR-DCI-62-...-G7/G14/G22
67A	Integrated drive EMCA-EC-67
40G	Gear unit EMGA-40, EMGC-40
60G	Gear unit EMGA-60-...-SAS/SST
60H	Gear unit EMGA-60-...-EAS, EMGC-60
80G	Gear unit EMGA-80
120G	Gear unit EMGA-120-...-SAS
160G	Gear unit EMGA-160-...-SAS

Generation	
-	First generation/basic version
G2	Second generation/optimesed housing geometry

Special design	
S1	Degree of protection IP65

Axial kits EAMM-A

Product range overview

FESTO

Permissible axis/motor combinations with toothed belt axis DGE-ZR

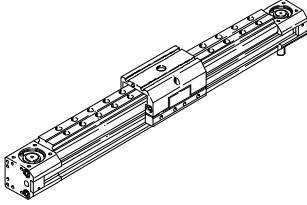

Motor/gear unit ¹⁾	Axial kit	
Type	Part No.	Type
DGE-8-...-ZR		
With servo motor		
EMMS-AS-40-...	550921	EAMM-A-G13-40A
With stepper motor		
EMMS-ST-42-...	550922	EAMM-A-G13-42A
DGE-12-...-ZR		
With servo motor		
EMMS-AS-40-...	550923	EAMM-A-G16-40A
EMMS-AS-55-...	550925	EAMM-A-G16-55A
With stepper motor		
EMMS-ST-42-...	550924	EAMM-A-G16-42A
DGE-18-...-ZR		
With servo motor		
EMMS-AS-40-...	550926	EAMM-A-G19-40A
EMMS-AS-55-...	550927	EAMM-A-G19-55A
With servo motor and gear unit		
EMME-AS-40-...	1454259	EAMM-A-G19-40G
EMGA-40-P-G...-EAS-40		
EMMS-AS-40-...	1454259	EAMM-A-G19-40G
EMGA-40-P-G...-SAS-40		
With stepper motor		
EMMS-ST-57-...	550928	EAMM-A-G19-57A
With stepper motor and gear unit		
EMMS-ST-42-...	1454259	EAMM-A-G19-40G
EMGA-40-P-G...-SST-42		
With integrated drive		
EMCA-EC-67-...	1454260	EAMM-A-G19-67A
With integrated drive and gear unit		
EMCA-EC-67-...	1454259	EAMM-A-G19-40G
EMGC-40-...		

Motor/gear unit ¹⁾	Axial kit	
Type	Part No.	Type
DGE-25-...-ZR		
With servo motor		
EMMS-AS-55-...	550929	EAMM-A-F30-55A
EMMS-AS-70-...	550932	EAMM-A-F30-70A
With servo motor and gear unit		
EMME-AS-40-...	1454254	EAMM-A-F30-40G
EMGA-40-P-G...-EAS-40		
EMMS-AS-40-...	1454254	EAMM-A-F30-40G
EMGA-40-P-G...-SAS-40		
EMMS-AS-55-...	550931	EAMM-A-F30-60G
EMGA-60-P-G...-SAS-55		
EMME-AS-60-...	1454255	EAMM-A-F30-60H
EMGA-60-P-G...-EAS-60		
EMMS-AS-70-...	550931	EAMM-A-F30-60G
EMGA-60-P-G...-SAS-70		
With stepper motor		
EMMS-ST-57-...	550930	EAMM-A-F30-57A
EMMS-ST-87-...	550933	EAMM-A-F30-87A
With stepper motor and gear unit		
EMMS-ST-42-...	1454254	EAMM-A-F30-40G
EMGA-40-P-G...-SST-42		
EMMS-ST-57-...	550931	EAMM-A-F30-60G
EMGA-60-P-G...-SST-57		
With integrated drive and gear unit		
EMCA-EC-67-...	1454254	EAMM-A-F30-40G
EMGC-40-...		
EMCA-EC-67-...	1454255	EAMM-A-F30-60H
EMGC-60-...		

1) The input torque must not exceed the maximum permissible transferable torque of the axial kit.

Axial kits EAMM-A

Product range overview

Permissible axis/motor combinations with toothed belt axis DGE-ZR

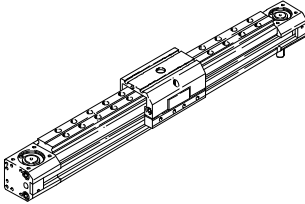

Motor/gear unit ¹⁾	Axial kit	
Type	Part No.	Type
DGE-25-...-ZR-RF		
With servo motor		
EMMS-AS-55-...	550942	EAMM-A-F37-55A
EMMS-AS-70-...	550945	EAMM-A-F37-70A
With servo motor and gear unit		
EMME-AS-40-...	1454257	EAMM-A-F37-40G
EMGA-40-P-G...-EAS-40		
EMMS-AS-40-...	1454257	EAMM-A-F37-40G
EMGA-40-P-G...-SAS-40		
EMMS-AS-55-...	550944	EAMM-A-F37-60G
EMGA-60-P-G...-SAS-55		
EMME-AS-60-...	1454258	EAMM-A-F37-60H
EMGA-60-P-G...-EAS-60		
EMMS-AS-70-...	550944	EAMM-A-F37-60G
EMGA-60-P-G...-SAS-70		
With stepper motor		
EMMS-ST-57-...	550943	EAMM-A-F37-57A
EMMS-ST-87-...	550946	EAMM-A-F37-87A
With stepper motor and gear unit		
EMMS-ST-42-...	1454257	EAMM-A-F37-40G
EMGA-40-P-G...-SST-42		
EMMS-ST-57-...	550944	EAMM-A-F37-60G
EMGA-60-P-G...-SST-57		
With integrated drive and gear unit		
EMCA-EC-67-...	1454257	EAMM-A-F37-40G
EMGC-40-...		
EMCA-EC-67-...	1454258	EAMM-A-F37-60H
EMGC-60-...		

Motor/gear unit ¹⁾	Axial kit	
Type	Part No.	Type
DGE-40-...-ZR		
With servo motor		
EMMS-AS-70-...	550934	EAMM-A-F40-70A
EMME-AS-100-...	550937	EAMM-A-F40-100A
EMMS-AS-100-...	550937	EAMM-A-F40-100A
With servo motor and gear unit		
EMMS-AS-70-...	550935	EAMM-A-F40-80G
EMGA-80-P-G...-SAS-70		
EMME-AS-80-...	550935	EAMM-A-F40-80G
EMGA-80-P-G...-EAS-80		
EMMS-AS-100-...	550935	EAMM-A-F40-80G
EMGA-80-P-G...-SAS-100		
With stepper motor		
EMMS-ST-87-...	550936	EAMM-A-F40-87A
With stepper motor and gear unit		
EMMS-ST-87-...	550935	EAMM-A-F40-80G
EMGA-80-P-G...-SST-87		
DGE-40-...-ZR-RF		
With servo motor		
EMME-AS-100-...	550949	EAMM-A-F47-100A
EMMS-AS-100-...	550949	EAMM-A-F47-100A
EMMS-AS-140-...	550950	EAMM-A-F47-140A
With servo motor and gear unit		
EMMS-AS-70-...	550947	EAMM-A-F47-80G
EMGA-80-P-G...-SAS-70		
EMME-AS-80-...	550947	EAMM-A-F47-80G
EMGA-80-P-G...-EAS-80		
EMMS-AS-100-...	550947	EAMM-A-F47-80G
EMGA-80-P-G...-SAS-100		
With stepper motor		
EMMS-ST-87-...	550948	EAMM-A-F47-87A
With stepper motor and gear unit		
EMMS-ST-87-...	550947	EAMM-A-F47-80G
EMGA-80-P-G...-SST-87		

1) The input torque must not exceed the maximum permissible transferable torque of the axial kit.

Axial kits EAMM-A

Product range overview

FESTO

Permissible axis/motor combinations with toothed belt axis DGE-ZR

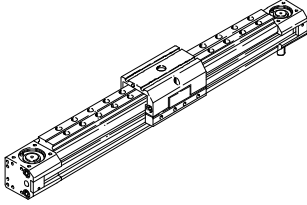

Motor/gear unit ¹⁾	Axial kit	
Type	Part No.	Type
DGE-63-...-ZR		
With servo motor		
EMME-AS-100-...	550939	EAMM-A-F62-100A
EMMS-AS-100-...	550939	EAMM-A-F62-100A
EMMS-AS-140-...	550941	EAMM-A-F62-140A
With servo motor and gear unit		
EMMS-AS-70-...	550938	EAMM-A-F62-80G
EMGA-80-P-G...-SAS-70		
EMME-AS-80-...	550938	EAMM-A-F62-80G
EMGA-80-P-G...-EAS-80		
EMMS-AS-100-...	550938	EAMM-A-F62-80G
EMGA-80-P-G...-SAS-100		
EMMS-AS-100-...	550940	EAMM-A-F62-120G
EMGA-120-P-G...-SAS-100		
EMMS-AS-140-...	550940	EAMM-A-F62-120G
EMGA-120-P-G...-SAS-140		
With stepper motor and gear unit		
EMMS-ST-87-...	550938	EAMM-A-F62-80G
EMGA-80-P-G...-SST-87		

Motor/gear unit ¹⁾	Axial kit	
Type	Part No.	Type
DGE-63-...-ZR-RF		
With servo motor		
EMME-AS-100-...	550952	EAMM-A-F80-100A
EMMS-AS-100-...	550952	EAMM-A-F80-100A
EMMS-AS-140-...	550954	EAMM-A-F80-140A
With servo motor and gear unit		
EMMS-AS-70-...	550951	EAMM-A-F80-80G
EMGA-80-P-G...-SAS-70		
EMME-AS-80-...	550951	EAMM-A-F80-80G
EMGA-80-P-G...-EAS-80		
EMMS-AS-100-...	550951	EAMM-A-F80-80G
EMGA-80-P-G...-SAS-100		
EMMS-AS-100-...	550951	EAMM-A-F80-120G
EMGA-120-P-G...-SAS-100		
EMMS-AS-140-...	550953	EAMM-A-F80-120G
EMGA-120-P-G...-SAS-140		
EMMS-AS-140-...	550955	EAMM-A-F80-160G
EMGA-160-P-G...-SAS-140		
With stepper motor and gear unit		
EMMS-ST-87-...	550951	EAMM-A-F80-80G
EMGA-80-P-G...-SST-87		

1) The input torque must not exceed the maximum permissible transferable torque of the axial kit.

Axial kits EAMM-A

Product range overview

Permissible axis/motor combinations with spindle axis DGE-SP

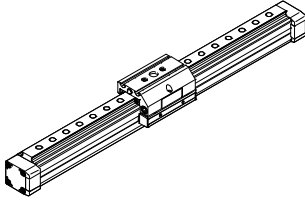

Motor/gear unit ¹⁾	Axial kit	
Type	Part No.	Type
DGE-18		
With servo motor		
EMMS-AS-40-...	550961	EAMM-A-E20-40A
EMMS-AS-55-...	550963	EAMM-A-E20-55A
With stepper motor		
EMMS-ST-42-...	550962	EAMM-A-E20-42A
DGE-25		
With servo motor		
EMMS-AS-40-...	550964	EAMM-A-E32-40A
EMMS-AS-55-...	550965	EAMM-A-E32-55A
With servo motor and gear unit		
EMME-AS-40-... EMGA-40-P-G...-EAS-40	1454247	EAMM-A-E32-40G
EMMS-AS-40-... EMGA-40-P-G...-SAS-40	1454247	EAMM-A-E32-40G
With stepper motor		
EMMS-ST-57-...	550966	EAMM-A-E32-57A
With stepper motor and gear unit		
EMMS-ST-42-... EMGA-40-P-G...-SST-42	1454247	EAMM-A-E32-40G
With integrated drive		
EMCA-EC-67-...	1454246	EAMM-A-E32-67A
With integrated drive and gear unit		
EMCA-EC-67-... EMGC-40-...	1454247	EAMM-A-E32-40G

Motor/gear unit ¹⁾	Axial kit	
Type	Part No.	Type
DGE-40		
With servo motor		
EMMS-AS-55-...	550969	EAMM-A-E48-55A
EMMS-AS-70-...	550971	EAMM-A-E48-44A-70A
EMME-AS-100-...	550973	EAMM-A-E48-100A
EMMS-AS-100-...	550973	EAMM-A-E48-100A
With servo motor and gear unit		
EMME-AS-40-... EMGA-40-P-G...-EAS-40	550968	EAMM-A-E48-40G
EMMS-AS-40-... EMGA-40-P-G...-SAS-40	550968	EAMM-A-E48-40G
EMME-AS-60-... EMGA-60-P-G...-EAS-60	1454249	EAMM-A-E48-60H
With stepper motor		
EMMS-ST-57-...	550970	EAMM-A-E48-57A
EMMS-ST-87-...	550972	EAMM-A-E48-87A
With stepper motor and gear unit		
EMMS-ST-42-... EMGA-40-P-G...-SST-42	550968	EAMM-A-E48-40G
With integrated drive and gear unit		
EMCA-EC-67-... EMGC-40-...	550968	EAMM-A-E48-40G
EMCA-EC-67-... EMGC-60-...	1454249	EAMM-A-E48-60H

1) The input torque must not exceed the maximum permissible transferable torque of the axial kit.

Axial kits EAMM-A

Product range overview

FESTO

Permissible axis/motor combinations with spindle axis DGE-SP

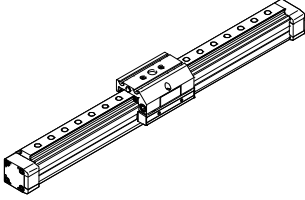

Motor/gear unit ¹⁾	Axial kit	
Type	Part No.	Type
DGE-63		
With servo motor		
EMMS-AS-70-...	550975	EAMM-A-E72-70A
EMME-AS-100-...	550978	EAMM-A-E72-100A
EMMS-AS-100-...	550978	EAMM-A-E72-100A
With servo motor and gear unit		
EMMS-AS-55-... EMGA-60-P-G...-SAS-55	550974	EAMM-A-E72-60G
EMME-AS-60-... EMGA-60-P-G...-EAS-60	1454250	EAMM-A-E72-60H
EMMS-AS-70-... EMGA-60-P-G...-SAS-70	550974	EAMM-A-E72-60G
EMMS-AS-70-... EMGA-80-P-G...-SAS-70	550976	EAMM-A-E72-80G
EMME-AS-80-... EMGA-80-P-G...-EAS-80	550976	EAMM-A-E72-80G
EMMS-AS-100-... EMGA-80-P-G...-SAS-100	550976	EAMM-A-E72-80G
With stepper motor		
EMMS-ST-87-...	550977	EAMM-A-E72-87A
With stepper motor and gear unit		
EMMS-ST-57-... EMGA-60-P-G...-SST-57	550974	EAMM-A-E72-60G
EMMS-ST-87-... EMGA-80-P-G...-SST-87	550976	EAMM-A-E72-80G
With integrated drive and gear unit		
EMCA-EC-67-... EMGC-60-...	1454250	EAMM-A-E72-60H

1) The input torque must not exceed the maximum permissible transferable torque of the axial kit.

Axial kits EAMM-A

Product range overview

Permissible axis/motor combinations with positioning axis DMES

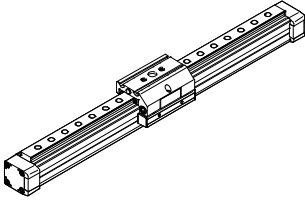

Motor/gear unit ¹⁾	Axial kit	
Type	Part No.	Type
DMES-18		
With servo motor		
EMMS-AS-40-...	550961	EAMM-A-E20-40A
EMMS-AS-55-...	550963	EAMM-A-E20-55A
With stepper motor		
EMMS-ST-42-...	550962	EAMM-A-E20-42A
With motor unit		
MTR-DCI-32S-...	556991	EAMM-A-E20-32B
DMES-25		
With servo motor		
EMMS-AS-40-...	550964	EAMM-A-E32-40A
EMMS-AS-55-...	550965	EAMM-A-E32-55A
With servo motor and gear unit		
EMME-AS-40-... EMGA-40-P-G...-EAS-40	1454247	EAMM-A-E32-40G
EMMS-AS-40-... EMGA-40-P-G...-SAS-40	1454247	EAMM-A-E32-40G
With stepper motor		
EMMS-ST-57-...	550966	EAMM-A-E32-57A
With stepper motor and gear unit		
EMMS-ST-42-... EMGA-40-P-G...-SST-42	1454247	EAMM-A-E32-40G
With integrated drive		
EMCA-EC-67-...	1454246	EAMM-A-E32-67A
With motor unit		
MTR-DCI-42S-...G7	556992	EAMM-A-E32-42B
MTR-DCI-42S-...G14	556993	EAMM-A-E32-42C
With integrated drive and gear unit		
EMCA-EC-67-... EMGC-40-...	1454247	EAMM-A-E32-40G
DMES-40		
With servo motor		
EMMS-AS-70-...	557448	EAMM-A-E48-64A-70A
EMME-AS-100-...	550973	EAMM-A-E48-100A
EMMS-AS-100-...	550973	EAMM-A-E48-100A
With stepper motor		
EMMS-ST-57-...	550970	EAMM-A-E48-57A
EMMS-ST-87-...	550972	EAMM-A-E48-87A
With integrated drive		
EMCA-EC-67-...	1454248	EAMM-A-E48-67A
With motor unit		
MTR-DCI-52S-...G7	556994	EAMM-A-E48-52B
MTR-DCI-52S-...G14	556995	EAMM-A-E48-52C
With integrated drive and gear unit		
EMCA-EC-67-... EMGC-40-...	1454249	EAMM-A-E48-60H

Motor/gear unit ¹⁾	Axial kit	
Type	Part No.	Type
DMES-63		
With servo motor		
EMMS-AS-70-...	550975	EAMM-A-E72-70A
EMME-AS-100-...	550978	EAMM-A-E72-100A
EMMS-AS-100-...	550978	EAMM-A-E72-100A
With servo motor and gear unit		
EMMS-AS-55-... EMGA-60-P-G...-SAS-55	550974	EAMM-A-E72-60G
EMME-AS-60-... EMGA-60-P-G...-EAS-60	1454250	EAMM-A-E72-60H
EMMS-AS-70-... EMGA-60-P-G...-SAS-70	550974	EAMM-A-E72-60G
EMMS-AS-70-... EMGA-80-P-G...-SAS-70	550976	EAMM-A-E72-80G
EMME-AS-80-... EMGA-80-P-G...-EAS-80	550976	EAMM-A-E72-80G
EMMS-AS-100-... EMGA-80-P-G...-SAS-100	550976	EAMM-A-E72-80G
With stepper motor		
EMMS-ST-87-...	550977	EAMM-A-E72-87A
With stepper motor and gear unit		
EMMS-ST-57-... EMGA-60-P-G...-SST-57	550974	EAMM-A-E72-60G
EMMS-ST-87-... EMGA-80-P-G...-SST-87	550976	EAMM-A-E72-80G
With motor unit		
MTR-DCI-62S-...	556996	EAMM-A-E72-62B
With integrated drive and gear unit		
EMCA-EC-67-... EMGC-60-...	1454250	EAMM-A-E72-60H

1) The input torque must not exceed the maximum permissible transferable torque of the axial kit.

Axial kits EAMM-A

Product range overview

FESTO

Permissible axis/motor combinations with electric cylinder ESBF

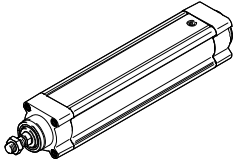

Motor/gear unit ¹⁾	Axial kit	
Type	Part No.	Type
ESBF-32		
With servo motor		
EMME-AS-40-...	1976465	EAMM-A-D32-40P
	2207372	EAMM-A-D32-40P-S1 ²⁾
EMMS-AS-40-...	543147	EAMM-A-D32-40A
	1322178	EAMM-A-D32-40A-S1 ²⁾
EMMS-AS-55-...	550979	EAMM-A-D32-55A
	1322180	EAMM-A-D32-55A-S1 ²⁾
EMME-AS-60-...	1956054	EAMM-A-D32-60P
	2234020	EAMM-A-D32-60P-S1 ²⁾
With servo motor and gear unit		
EMME-AS-40-...	1454238	EAMM-A-D32-40G
EMGA-40-P-G...-EAS-40	2256396	EAMM-A-D32-40G-S1 ²⁾
EMMS-AS-40-...	1454238	EAMM-A-D32-40G
EMGA-40-P-G...-SAS-40	2256396	EAMM-A-D32-40G-S1 ²⁾
EMMS-AS-55-...	2946758	EAMM-A-D32-60G
EMGA-60-P-G...-SAS-55	2946759	EAMM-A-D32-60G-S1 ²⁾
EMME-AS-60-...	2946760	EAMM-A-D32-60H
EMGA-60-P-G...-EAS-60	2946761	EAMM-A-D32-60H-S1 ²⁾
EMMS-AS-70-...	2946758	EAMM-A-D32-60G
EMGA-60-P-G...-SAS-70	2946759	EAMM-A-D32-60G-S1 ²⁾
With stepper motor		
EMMS-ST-42-...	543148	EAMM-A-D32-42A
	1322179	EAMM-A-D32-42A-S1 ²⁾
EMMS-ST-57-...	550980	EAMM-A-D32-57A
	1322181	EAMM-A-D32-57A-S1 ²⁾
With stepper motor and gear unit		
EMMS-ST-42-...	1454238	EAMM-A-D32-40G
EMGA-40-P-G...-SST-42	2256396	EAMM-A-D32-40G-S1 ²⁾
EMMS-ST-57-...	2946758	EAMM-A-D32-60G
EMGA-60-P-G...-SST-57	2946759	EAMM-A-D32-60G-S1 ²⁾
With integrated drive		
EMCA-EC-67-...	1454239	EAMM-A-D32-67A
	2256397	EAMM-A-D32-67A-S1 ²⁾
With integrated drive and gear unit		
EMCA-EC-67-...	1454238	EAMM-A-D32-40G
EMGC-40-...	2256396	EAMM-A-D32-40G-S1 ²⁾
EMCA-EC-67-...	2946760	EAMM-A-D32-60H
EMGC-60-...	2946761	EAMM-A-D32-60H-S1 ²⁾

Motor/gear unit ¹⁾	Axial kit	
Type	Part No.	Type
ESBF-40		
With servo motor		
EMMS-AS-55-...	543153	EAMM-A-D40-55A
	1322182	EAMM-A-D40-55A-S1 ²⁾
EMME-AS-60-...	1977000	EAMM-A-D40-60P
	2151519	EAMM-A-D40-60P-S1 ²⁾
EMMS-AS-70-...	550981	EAMM-A-D40-70A
	1322185	EAMM-A-D40-70A-S1 ²⁾
With servo motor and gear unit		
EMME-AS-40-...	2256398	EAMM-A-D40-40G-G2
EMGA-40-P-G...-EAS-40	2256399	EAMM-A-D40-40G-S1 ²⁾
EMMS-AS-40-...	2256398	EAMM-A-D40-40G-G2
EMGA-40-P-G...-SAS-40	2256399	EAMM-A-D40-40G-S1 ²⁾
EMMS-AS-55-...	2256400	EAMM-A-D40-60G
EMGA-60-P-G...-SAS-55	2256409	EAMM-A-D40-60G-S1 ²⁾
EMME-AS-60-...	1454242	EAMM-A-D40-60H
EMGA-60-P-G...-EAS-60	2256401	EAMM-A-D40-60H-S1 ²⁾
EMMS-AS-70-...	2256400	EAMM-A-D40-60G
EMGA-60-P-G...-SAS-70	2256409	EAMM-A-D40-60G-S1 ²⁾
With stepper motor		
EMMS-ST-57-...	543154	EAMM-A-D4057A
	1322183	EAMM-A-D40-57A-S1 ¹⁾
EMMS-ST-87-...	550982	EAMM-A-D40-87A
	1322186	EAMM-A-D40-87A-S1 ¹⁾
With stepper motor and gear unit		
EMMS-ST-42-...	2256398	EAMM-A-D40-40G-G2
EMGA-40-P-G...-SST-42	2256399	EAMM-A-D40-40G-S1 ²⁾
EMMS-ST-57-...	2256400	EAMM-A-D40-60G
EMGA-60-P-G...-SST-57	2256409	EAMM-A-D40-60G-S1 ²⁾
With integrated drive		
EMCA-EC-67-...	1454243	EAMM-A-D40-67A
	2256695	EAMM-A-D40-67A-S1 ²⁾
With integrated drive and gear unit		
EMCA-EC-67-...	2256398	EAMM-A-D40-40G-G2
EMGC-40-...	2256399	EAMM-A-D40-40G-S1 ²⁾
EMCA-EC-67-...	1454242	EAMM-A-D40-60H
EMGC-60-...	2256401	EAMM-A-D40-60H-S1 ²⁾

- 1) The input torque must not exceed the maximum permissible transferable torque of the axial kit.
- 2) With protection class IP65.

Axial kits EAMM-A

Product range overview

FESTO

Permissible axis/motor combinations with electric cylinder ESBF

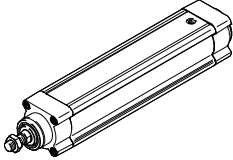

Motor/gear unit ¹⁾	Axial kit	
Type	Part No.	Type
ESBF-50		
With servo motor		
EMMS-AS-70-...	2733783	EAMM-A-D50-70A
	2734287	EAMM-A-D50-70A-S1 ²⁾
EMME-AS-80-...	2733785	EAMM-A-D50-80P
	2734289	EAMM-A-D50-80P-S1 ²⁾
EMME-AS-100-...	2733784	EAMM-A-D50-100A
	2734288	EAMM-A-D50-100A-S1 ²⁾
EMMS-AS-100-...	2733784	EAMM-A-D50-100A
	2734288	EAMM-A-D50-100A-S1 ²⁾
With servo motor and gear unit		
EMMS-AS-55-...	2733786	EAMM-A-D50-60G
EMGA-60-P-G...-SAS-55	2734290	EAMM-A-D50-60G-S1 ²⁾
EMME-AS-60-...	2733796	EAMM-A-D50-60H
EMGA-60-P-G...-EAS-60	2907418	EAMM-A-D50-60H-S1 ²⁾
EMMS-AS-70-...	2733786	EAMM-A-D50-60G
EMGA-60-P-G...-SAS-70	2734290	EAMM-A-D50-60G-S1 ²⁾
EMMS-AS-70-...	2733787	EAMM-A-D50-80G
EMGA-80-P-G...-SAS-70	2734291	EAMM-A-D50-80G-S1 ²⁾
EMME-AS-80-...	2733787	EAMM-A-D50-80G
EMGA-80-P-G...-EAS-80	2734291	EAMM-A-D50-80G-S1 ²⁾
EMMS-AS-100-...	2733787	EAMM-A-D50-80G
EMGA-80-P-G...-SAS-100	2734291	EAMM-A-D50-80G-S1 ²⁾
With stepper motor		
EMMS-ST-87-...	2733781	EAMM-A-D50-87A
	2734286	EAMM-A-D50-87A-S1 ²⁾
With stepper motor and gear unit		
EMMS-ST-57-...	2733786	EAMM-A-D60-60G
EMGA-60-P-G...-SST-57	2734290	EAMM-A-D50-60G-S1 ²⁾
EMMS-ST-87-...	2733787	EAMM-A-D50-80G
EMGA-80-P-G...-SST-87	2734291	EAMM-A-D50-80G-S1 ²⁾
With integrated drive and gear unit		
EMCA-EC-67-...	2733796	EAMM-A-D50-60H
EMGC-60-...	2907418	EAMM-A-D50-60H-S1 ²⁾

Motor/gear unit ¹⁾	Axial kit	
Type	Part No.	Type
ESBF-63		
With servo motor		
EMMS-AS-70-...	543161	EAMM-A-D60-70A
	2256699	EAMM-A-D60-70A-S1 ²⁾
EMME-AS-80-...	1977073	EAMM-A-D60-80P
	2218564	EAMM-A-D60-80P-S1 ²⁾
EMME-AS-100-...	550983	EAMM-A-D60-100A
	2256700	EAMM-A-D60-100A-S1 ²⁾
EMMS-AS-100-...	550983	EAMM-A-D60-100A
	2256700	EAMM-A-D60-100A-S1 ²⁾
With servo motor and gear unit		
EMMS-AS-55-...	2256696	EAMM-A-D60-60G-G2
EMGA-60-P-G...-SAS-55	2256698	EAMM-A-D60-60G-S1 ²⁾
EMME-AS-60-...	1454245	EAMM-A-D60-60H
EMGA-60-P-G...-EAS-60	2256697	EAMM-A-D60-60H-S1 ²⁾
EMMS-AS-70-...	2256696	EAMM-A-D60-60G-G2
EMGA-60-P-G...-SAS-70	2256698	EAMM-A-D60-60G-S1 ²⁾
EMMS-AS-70-...	1499402	EAMM-A-D60-80G
EMGA-80-P-G...-SAS-70	2946762	EAMM-A-D60-80G-S1 ²⁾
EMME-AS-80-...	1499402	EAMM-A-D60-80G
EMGA-80-P-G...-EAS-80	2946762	EAMM-A-D60-80G-S1 ²⁾
EMMS-AS-100-...	1499402	EAMM-A-D60-80G
EMGA-80-P-G...-SAS-100	2946762	EAMM-A-D60-80G-S1 ²⁾
With stepper motor		
EMMS-ST-87-...	543162	EAMM-A-D60-87A
	1322188	EAMM-A-D60-87A-S1 ²⁾
With stepper motor and gear unit		
EMMS-ST-57-...	2256696	EAMM-A-D60-60G-G2
EMGA-60-P-G...-SST-57	2256698	EAMM-A-D60-60G-S1 ²⁾
EMMS-ST-87-...	1499402	EAMM-A-D60-80G
EMGA-80-P-G...-SST-87	2946762	EAMM-A-D60-80G-S1 ²⁾
With integrated drive and gear unit		
EMCA-EC-67-...	1454245	EAMM-A-D60-80H
EMGC-60-...	2256697	EAMM-A-D60-80H-S1 ²⁾

- 1) The input torque must not exceed the maximum permissible transferable torque of the axial kit.
 2) With protection class IP65.

Axial kits EAMM-A

Product range overview

FESTO

Permissible axis/motor combinations with electric cylinder ESBF

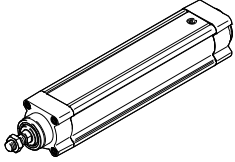

Motor/gear unit ¹⁾	Axial kit	
Type	Part No.	Type
ESBF-80		
With servo motor		
EMME-AS-100-...	1589665	EAMM-A-D80-100A
	1600673	EAMM-A-D80-100A-S1 ²⁾
EMMS-AS-100-...	1589665	EAMM-A-D80-100A
	1600673	EAMM-A-D80-100A-S1 ²⁾
EMMS-AS-140-...	1588299	EAMM-A-D80-140A
	1600674	EAMM-A-D80-140A-S1 ²⁾
With servo motor and gear unit		
EMMS-AS-70-...	2946763	EAMM-A-D80-80G
EMGA-80-P-G...-SAS-70	2946764	EAMM-A-D80-80G-S1 ²⁾
EMME-AS-80-...	2946763	EAMM-A-D80-80G
EMGA-80-P-G...-EAS-80	2946764	EAMM-A-D80-80G-S1 ²⁾
EMMS-AS-100-...	2946763	EAMM-A-D80-80G
EMGA-80-P-G...-SAS-100	2946764	EAMM-A-D80-80G-S1 ²⁾
With stepper motor and gear unit		
EMMS-ST-87-...	2946763	EAMM-A-D80-80G
EMGA-80-P-G...-SST-87	2946764	EAMM-A-D80-80G-S1 ²⁾

Motor/gear unit ¹⁾	Axial kit	
Type	Part No.	Type
ESBF-100		
With servo motor		
EMME-AS-100-...	3356796	EAMM-A-D100-100A
	3356931	EAMM-A-D100-100A-S1 ²⁾
EMMS-AS-100-...	3356796	EAMM-A-D100-100A
	3356931	EAMM-A-D100-100A-S1 ²⁾
EMMS-AS-140-...	1588349	EAMM-A-D100-140A
	1600675	EAMM-A-D100-140A-S1 ²⁾
With servo motor and gear unit		
EMMS-AS-100-...	2449341	EAMM-A-D100-120G
EMGA-120-P-G...-SAS-100	2946765	EAMM-A-D100-120G-S1 ²⁾
EMMS-AS-140-...	2449341	EAMM-A-D100-120G
EMGA-120-P-G...-SAS-140	2946765	EAMM-A-D100-120G-S1 ²⁾

- 1) The input torque must not exceed the maximum permissible transferable torque of the axial kit.
- 2) With protection class IP65.

 Note

The axial kit (without "S1" in the type code) can be retrofitted with a seal set EADS-F to change the

protection class from IP40 to IP65.
→ 71

Axial kits EAMM-A

Product range overview

Permissible axis/motor combinations with toothed belt axis EGC-TB

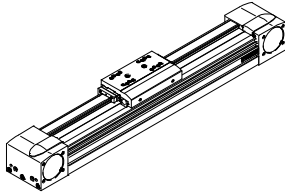

Motor/gear unit ¹⁾	Axial kit	
Type	Part No.	Type
EGC-50		
With servo motor		
EMMS-AS-55-...	557975	EAMM-A-L27-55A
With servo motor and gear unit		
EMME-AS-40-...	557974	EAMM-A-L27-40G
EMGA-40-P-G...-EAS-40		
EMMS-AS-40-...	557974	EAMM-A-L27-40G
EMGA-40-P-G...-SAS-40		
With stepper motor		
EMMS-ST-57-...	560678	EAMM-A-L27-57A
With stepper motor and gear unit		
EMMS-ST-42-...	557974	EAMM-A-L27-40G
EMGA-40-P-G...-SST-42		
With integrated drive		
EMCA-EC-67-...	1454261	EAMM-A-L27-67A
With integrated drive and gear unit		
EMCA-EC-67-...	557974	EAMM-A-L27-40G
EMGC-40-...		
EGC-70		
With servo motor		
EMME-AS-55-...	3683331	EAMM-A-L38-55A
EMME-AS-60-...	2037246	EAMM-A-L38-60P
EMMS-AS-70-...	557979	EAMM-A-L38-70A
With servo motor and gear unit		
EMMS-AS-55-...	557978	EAMM-A-L38-60G
EMGA-60-P-G...-SAS-55		
EMME-AS-60-...	1456610	EAMM-A-L38-60H
EMGA-60-P-G...-EAS-60		
EMMS-AS-70-...	557978	EAMM-A-L38-60G
EMGA-60-P-G...-SAS-70		
With stepper motor		
EMMS-ST-57-...	560679	EAMM-A-L38-57A
EMMS-ST-87-...	560680	EAMM-A-L38-87A
With stepper motor and gear unit		
EMMS-ST-57-...	557978	EAMM-A-L38-60G
EMGA-60-P-G...-SST-57		
With integrated drive and gear unit		
EMCA-EC-67-...	1456610	EAMM-A-L38-60H
EMGC-60-...		

Motor/gear unit ¹⁾	Axial kit	
Type	Part No.	Type
EGC-80		
With servo motor		
EMMS-AS-70-...	557982	EAMM-A-L48-70A
EMME-AS-80-...	2042616	EAMM-A-L48-80P
EMME-AS-100-...	557984	EAMM-A-L48-100A
EMMS-AS-100-...	557984	EAMM-A-L48-100A
With servo motor and gear unit		
EMMS-AS-55-...	557983	EAMM-A-L48-60G
EMGA-60-P-G...-SAS-55		
EMME-AS-60-...	1456611	EAMM-A-L48-60H
EMGA-60-P-G...-EAS-60		
EMMS-AS-70-...	557983	EAMM-A-L48-60G
EMGA-60-P-G...-SAS-70		
With stepper motor		
EMMS-ST-87-...	560683	EAMM-A-L48-87A
With stepper motor and gear unit		
EMMS-ST-57-...	557983	EAMM-A-L48-60G
EMGA-60-P-G...-SST-57		
With integrated drive and gear unit		
EMCA-EC-67-...	1456611	EAMM-A-L48-60H
EMGC-60-...		

1) The input torque must not exceed the maximum permissible transferable torque of the axial kit.

Axial kits EAMM-A

Product range overview

FESTO

Permissible axis/motor combinations with toothed belt axis EGC-TB

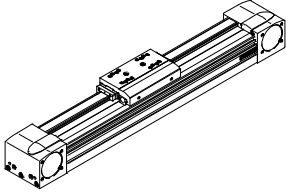

Motor/gear unit ¹⁾	Axial kit	
Type	Part No.	Type
EGC-120		
With servo motor		
EMME-AS-100-...	557988	EAMM-A-L62-100A
EMMS-AS-100-...	557988	EAMM-A-L62-100A
EMMS-AS-140-...	557990	EAMM-A-L62-140A
With servo motor and gear unit		
EMMS-AS-70-...	557989	EAMM-A-L62-80G
EMGA-80-P-G...-SAS-70		
EMME-AS-80-...	557989	EAMM-A-L62-80G
EMGA-80-P-G...-EAS-80		
EMMS-AS-100-...	557989	EAMM-A-L62-80G
EMGA-80-P-G...-SAS-100		
With stepper motor and gear unit		
EMMS-ST-87-...	557989	EAMM-A-L62-80G
EMGA-80-P-G...-SST-87		

Motor/gear unit ¹⁾	Axial kit	
Type	Part No.	Type
EGC-185		
With servo motor		
EMMS-AS-140-...	557994	EAMM-A-L95-140A
EMMS-AS-190-...	1378474	EAMM-A-L95-190A
With servo motor and gear unit		
EMMS-AS-70-...	3660191	EAMM-A-L95-80G-G2
EMGA-80-P-G...-SAS-70		
EMME-AS-80-...	3660191	EAMM-A-L95-80G-G2
EMGA-80-P-G...-EAS-80		
EMMS-AS-100-...	3660191	EAMM-A-L95-80G-G2
EMGA-80-P-G...-SAS-100		
EMMS-AS-100-...	3659941	EAMM-A-L95-120G-G2
EMGA-120-P-G...-SAS-100		
EMMS-AS-140-...	3659941	EAMM-A-L95-120G-G2
EMGA-120-P-G...-SAS-140		

1) The input torque must not exceed the maximum permissible transferable torque of the axial kit.

Axial kits EAMM-A

Product range overview

FESTO

Permissible axis/motor combinations with spindle axis EGC-BS

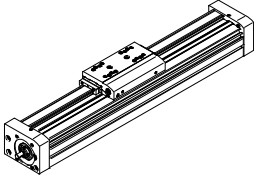

Motor/gear unit ¹⁾	Axial kit	
Type	Part No.	Type
EGC-70		
With servo motor		
EMME-AS-40-...	2219044	EAMM-A-S38-40P ²⁾
	3637972	EAMM-A-S38-40P-G2
EMMS-AS-40-...	558162	EAMM-A-S38-40A ²⁾
	3637971	EAMM-A-S38-40A-G2
EMMS-AS-55-...	558163	EAMM-A-S38-55A ²⁾
	3637967	EAMM-A-S38-55A-G2
EMME-AS-60-...	2219110	EAMM-A-S38-60P ²⁾
	3637958	EAMM-A-S38-60P-G2
With servo motor and gear unit		
EMME-AS-40-...	1456647	EAMM-A-S38-40G-G2
EMGA-40-P-G...-EAS-40		
EMMS-AS-40-...	1456647	EAMM-A-S38-40G-G2
EMGA-40-P-G...-SAS-40		
With stepper motor		
EMMS-ST-42-...	560685	EAMM-A-S38-42A ²⁾
	3637965	EAMM-A-S38-42A-G2
EMMS-ST-57-...	560686	EAMM-A-S38-57A ²⁾
	3637956	EAMM-A-S38-57A-G2
With stepper motor and gear unit		
EMMS-ST-42-...	1456647	EAMM-A-S38-40G-G2
EMGA-40-P-G...-SST-42		
With integrated drive		
EMCA-EC-67-...	1456638	EAMM-A-S38-67A-G2
With integrated drive and gear unit		
EMCA-EC-67-...	1456647	EAMM-A-S38-40G-G2
EMGC-40-...		

Motor/gear unit ¹⁾	Axial kit	
Type	Part No.	Type
EGC-80		
With servo motor		
EMMS-AS-55-...	558164	EAMM-A-S48-55A ²⁾
	3637961	EAMM-A-S48-55A-G2
EMME-AS-60-...	2220560	EAMM-A-S48-60P ²⁾
	3637964	EAMM-A-S48-60P-G2
EMMS-AS-70-...	558165	EAMM-A-S48-70A ²⁾
	3637957	EAMM-A-S48-70A-G2
With servo motor and gear unit		
EMME-AS-40-...	1456650	EAMM-A-S48-40G-G2
EMGA-40-P-G...-EAS-40		
EMMS-AS-40-...	1456650	EAMM-A-S48-40G-G2
EMGA-40-P-G...-SAS-40		
EMMS-AS-55-...	2256701	EAMM-A-S48-60G-G2
EMGA-60-P-G...-SAS-55		
EMME-AS-60-...	1456652	EAMM-A-S48-60H-G2
EMGA-60-P-G...-EAS-60		
EMMS-AS-70-...	2256701	EAMM-A-S48-60G-G2
EMGA-60-P-G...-SAS-70		
With stepper motor		
EMMS-ST-57-...	560687	EAMM-A-S48-57A ²⁾
	3637963	EAMM-A-S48-57A-G2
EMMS-ST-87-...	560688	EAMM-A-S48-87A ²⁾
	3637962	EAMM-A-S48-87A-G2
With stepper motor and gear unit		
EMMS-ST-42-...	1456650	EAMM-A-S48-40G-G2
EMGA-40-P-G...-SST-42		
EMMS-ST-57-...	2256701	EAMM-A-S48-60G-G2
EMGA-60-P-G...-SST-57		
With integrated drive and gear unit		
EMCA-EC-67-...	1456650	EAMM-A-S48-40G-G2
EMGC-40-...		
EMCA-EC-67-...	1456652	EAMM-A-S48-40G-G2
EMGC-60-...		

- 1) The input torque must not exceed the maximum permissible transferable torque of the axial kit.
 2) Type discontinued

Axial kits EAMM-A

Product range overview

FESTO

Permissible axis/motor combinations with spindle axis EGC-BS

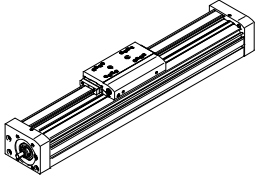

Motor/gear unit ¹⁾	Axial kit	
Type	Part No.	Type
EGC-120		
With servo motor		
EMMS-AS-70-...	558166	EAMM-A-S62-70A ²⁾
	3637959	EAMM-A-S62-70A-G2
EMME-AS-80-...	2222582	EAMM-A-S62-80P ²⁾
	3637970	EAMM-A-S62-80P-G2
EMME-AS-100-...	558167	EAMM-A-S62-100A ²⁾
	3637960	EAMM-A-S62-100A-G2
EMMS-AS-100-...	558167	EAMM-A-S62-100A ²⁾
	3637960	EAMM-A-S62-100A-G2
EMMS-AS-140-...	558168	EAMM-A-S62-140A ²⁾
	3637969	EAMM-A-S62-140A-G2
With servo motor and gear unit		
EMMS-AS-55-... EMGA-60-P-G...-SAS-55	2297649	EAMM-A-S62-60G-G2
EMME-AS-60-... EMGA-60-P-G...-EAS-60	1456654	EAMM-A-S62-60H-G2
EMMS-AS-70-... EMGA-60-P-G...-SAS-70	2297649	EAMM-A-S62-60G-G2
EMMS-AS-70-... EMGA-80-P-G...-SAS-70	1972530	EAMM-A-S62-80G-G2
EMME-AS-80-... EMGA-80-P-G...-EAS-80	1972530	EAMM-A-S62-80G-G2
EMMS-AS-100-... EMGA-80-P-G...-SAS-100	1972530	EAMM-A-S62-80G-G2
With stepper motor		
EMMS-ST-87-...	560689	EAMM-A-S62-87A ²⁾
	3637966	EAMM-A-S62-87A-G2
With stepper motor and gear unit		
EMMS-ST-57-... EMGA-60-P-G...-SST-57	2297649	EAMM-A-S48-60G-G2
EMMS-ST-87-... EMGA-80-P-G...-SST-87	1972530	EAMM-A-S48-40G-G2
With integrated drive and gear unit		
EMCA-EC-67-... EMGC-60-...	1456654	EAMM-A-S62-60H-G2

Motor/gear unit ¹⁾	Axial kit	
Type	Part No.	Type
EGC-185		
With servo motor		
EMME-AS-100-...	558169	EAMM-A-S95-100A ²⁾
	3637955	EAMM-A-S95-100A-G2
EMMS-AS-100-...	558169	EAMM-A-S95-100A ²⁾
	3637955	EAMM-A-S95-100A-G2
EMMS-AS-140-...	558170	EAMM-A-S95-140A ²⁾
	3637954	EAMM-A-S95-140A-G2

- 1) The input torque must not exceed the maximum permissible transferable torque of the axial kit.
 2) Type discontinued

Axial kits EAMM-A

Product range overview

Permissible axis/motor combinations with spindle axis ELGA-BS-...

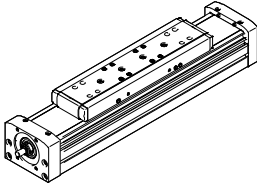

Motor/gear unit ¹⁾	Axial kit	
Type	Part No.	Type
ELGA-BS-...-70		
With servo motor		
EMME-AS-40-...	3637972	EAMM-A-S38-40P-G2
EMMS-AS-40-...	3637971	EAMM-A-S38-40A-G2
EMMS-AS-55-...	3637967	EAMM-A-S38-55A-G2
EMME-AS-60-...	3637958	EAMM-A-S38-60P-G2
With stepper motor		
EMMS-ST-42-...	3637965	EAMM-A-S38-42A-G2
EMMS-ST-57-...	3637956	EAMM-A-S38-57A-G2
ELGA-BS-...-80		
With servo motor		
EMMS-AS-55-...	3637961	EAMM-A-S48-55A-G2
EMME-AS-60-...	3637964	EAMM-A-S48-60P-G2
EMMS-AS-70-...	3637957	EAMM-A-S48-70A-G2
With stepper motor		
EMMS-ST-57-...	3637963	EAMM-A-S48-57A-G2
EMMS-ST-87-...	3637962	EAMM-A-S48-87A-G2

Motor/gear unit ¹⁾	Axial kit	
Type	Part No.	Type
ELGA-BS-...-120		
With servo motor		
EMMS-AS-70-...	3637959	EAMM-A-S62-70A-G2
EMME-AS-80-...	3637970	EAMM-A-S62-80P-G2
EMME-AS-100-...	3637960	EAMM-A-S62-100A-G2
EMMS-AS-100-...	3637960	EAMM-A-S62-100A-G2
EMMS-AS-140-...	3637969	EAMM-A-S62-140A-G2
With stepper motor		
EMMS-ST-87-...	3637966	EAMM-A-S62-87A-G2
ELGA-BS-...-185		
With servo motor		
EMME-AS-100-...	3637955	EAMM-A-S95-100A-G2
EMMS-AS-100-...	3637955	EAMM-A-S95-100A-G2
EMMS-AS-140-...	3637954	EAMM-A-S95-140A-G2

1) The input torque must not exceed the maximum permissible transferable torque of the axial kit.

Axial kits EAMM-A

Product range overview

FESTO

Permissible axis/motor combinations with toothed belt axis ELGA-TB

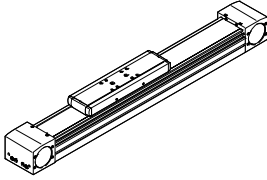

Motor/gear unit ¹⁾	Axial kit	
Type	Part No.	Type
ELGA-TB-...-70		
With servo motor		
EMMS-AS-70-...	1202331	EAMM-A-N38-70A
With servo motor and gear unit		
EMMS-AS-55-... EMGA-60-P-G...-SAS-55	1202253	EAMM-A-N38-60G
EMME-AS-60-... EMGA-60-P-G...-EAS-60	1456616	EAMM-A-N38-60H
EMMS-AS-70-... EMGA-60-P-G...-SAS-70	1202253	EAMM-A-N38-60G
With stepper		
EMMS-ST-87-...	3324111	EAMM-A-N38-87A
With stepper motor and gear unit		
EMMS-ST-57-... EMGA-60-P-G...-SST-57	1202253	EAMM-A-N38-60G
With integrated drive and gear unit		
EMCA-EC-67-... EMGC-60-...	1456616	EAMM-A-N38-60H
ELGA-TB-...-80		
With servo motor		
EMME-AS-100-... EMMS-AS-100-...	1201894	EAMM-A-N48-100A
With servo motor and gear unit		
EMMS-AS-55-... EMGA-60-P-G...-SAS-55	1972527	EAMM-A-N48-60G
EMME-AS-60-... EMGA-60-P-G...-EAS-60	1456618	EAMM-A-N48-60H
EMMS-AS-70-... EMGA-60-P-G...-SAS-70	1972527	EAMM-A-N48-60G
EMMS-AS-70-... EMGA-80-P-G...-SAS-70	1258793	EAMM-A-N48-80G
EMME-AS-80-... EMGA-80-P-G...-EAS-80	1258793	EAMM-A-N48-80G
EMMS-AS-100-... EMGA-80-P-G...-SAS-100	1258793	EAMM-A-N48-80G
With stepper motor and gear unit		
EMMS-ST-57-... EMGA-60-P-G...-SST-57	1972527	EAMM-A-N48-60G
EMMS-ST-87-... EMGA-80-P-G...-SST-87	1258793	EAMM-A-N48-80G
With integrated drive and gear unit		
EMCA-EC-67-... EMGC-60-...	1456618	EAMM-A-N48-60H

Motor/gear unit ¹⁾	Axial kit	
Type	Part No.	Type
ELGA-TB-...-120		
With servo motor		
EMMS-AS-140-...	1201691	EAMM-A-N80-140A
With servo motor and gear unit		
EMMS-AS-70-... EMGA-80-P-G...-SAS-70	2372096	EAMM-A-N80-80G
EMME-AS-80-... EMGA-80-P-G...-EAS-80	2372096	EAMM-A-N80-80G
EMMS-AS-100-... EMGA-80-P-G...-SAS-100	2372096	EAMM-A-N80-80G
EMMS-AS-100-... EMGA-120-P-G...-SAS-100	1201695	EAMM-A-N80-120G
EMMS-AS-140-... EMGA-120-P-G...-SAS-140	1201695	EAMM-A-N80-120G
With stepper motor and gear unit		
EMMS-ST-87-... EMGA-80-P-G...-SST-87	2372096	EAMM-A-N80-80G
ELGA-TB-...-150		
With servo motor		
EMMS-AS-140-... EMMS-AS-190-...	3657226 3659562	EAMM-A-L95-140A-G2 EAMM-A-L95-190A-G2
With servo motor and gear unit		
EMMS-AS-70-... EMGA-80-P-G...-SAS-70	3660191	EAMM-A-L95-80G-G2
EMME-AS-80-... EMGA-80-P-G...-EAS-80	3660191	EAMM-A-L95-80G-G2
EMMS-AS-100-... EMGA-80-P-G...-SAS-100	3660191	EAMM-A-L95-80G-G2
EMMS-AS-100-... EMGA-120-P-G...-SAS-100	3659941	EAMM-A-L95-120G-G2
EMMS-AS-140-... EMGA-120-P-G...-SAS-140	3659941	EAMM-A-L95-120G-G2
With stepper motor and gear unit		
EMMS-ST-87-... EMGA-80-P-G...-SST-87	3660191	EAMM-A-L95-80G

1) The input torque must not exceed the maximum permissible transferable torque of the axial kit.

Axial kits EAMM-A

Product range overview

Permissible axis/motor combinations with toothed belt axis EGC-HD-TB

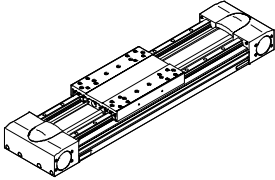

Motor/gear unit ¹⁾	Axial kit	
Type	Part No.	Type
EGC-HD-125		
With servo motor and gear unit		
EMMS-AS-55-...	1190076	EAMM-A-M43-60G
EMGA-60-P-G...-SAS-55		
EMME-AS-60-...	1456612	EAMM-A-M43-60H
EMGA-60-P-G...-EAS-60		
EMMS-AS-70-...	1190076	EAMM-A-M43-60G
EMGA-60-P-G...-SAS-70		
With stepper motor and gear unit		
EMMS-ST-57-...	1190076	EAMM-A-M43-60G
EMGA-60-P-G...-SST-57		
With integrated drive and gear unit		
EMCA-EC-67-...	1456612	EAMM-A-M43-60H
EMGC-60-...		

Motor/gear unit ¹⁾	Axial kit	
Type	Part No.	Type
EGC-HD-160		
With servo motor and gear unit		
EMME-AS-60-...	1456614	EAMM-A-M48-60H
EMGA-60-P-G...-EAS-60		
EMMS-AS-70-...	1190421	EAMM-A-M48-80G
EMGA-80-P-G...-SAS-70		
EMME-AS-80-...	1190421	EAMM-A-M48-80G
EMGA-80-P-G...-EAS-80		
EMMS-AS-100-...	1190421	EAMM-A-M48-80G
EMGA-80-P-G...-SAS-100		
With stepper motor and gear unit		
EMMS-ST-87-...	1190421	EAMM-A-M48-80G
EMGA-80-P-G...-SST-87		
With integrated drive and gear unit		
EMCA-EC-67-...	1456614	EAMM-A-M48-60H
EMGC-60-...		
EGC-HD-220		
With servo motor and gear unit		
EMMS-AS-100-...	1190774	EAMM-A-M80-120G
EMGA-120-P-G...-SAS-100		
EMMS-AS-140-...	1190774	EAMM-A-M80-120G
EMGA-120-P-G...-SAS-140		

1) The input torque must not exceed the maximum permissible transferable torque of the axial kit.

Axial kits EAMM-A

Product range overview

FESTO

Permissible axis/motor combinations with spindle axis EGC-HD-BS

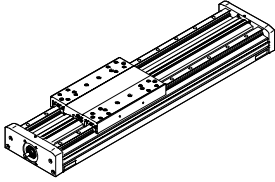

Motor ¹⁾	Axial kit	
Type	Part No.	Type
EGC-HD-125		
With servo motor		
EMME-AS-40-...	2219044	EAMM-A-S38-40P ²⁾
	3637972	EAMM-A-S38-40P-G2
EMMS-AS-40-...	558162	EAMM-A-S38-40A ²⁾
	3637971	EAMM-A-S38-40A-G2
EMMS-AS-55-...	558163	EAMM-A-S38-55A ²⁾
	3637967	EAMM-A-S38-55A-G2
EMME-AS-60-...	2219110	EAMM-A-S38-60P ²⁾
	3637958	EAMM-A-S38-60P-G2
With servo motor and gear unit		
EMME-AS-40-...	1456647	EAMM-A-S38-40G-G2
EMGA-40-P-G...-EAS-40		
EMMS-AS-40-...	1456647	EAMM-A-S38-40G-G2
EMGA-40-P-G...-SAS-40		
With stepper motor		
EMMS-ST-42-...	560685	EAMM-A-S38-42A ²⁾
	3637965	EAMM-A-S38-42A-G2
EMMS-ST-57-...	560686	EAMM-A-S38-57A ²⁾
	3637956	EAMM-A-S38-57A-G2
With stepper motor and gear unit		
EMMS-ST-42-...	1456647	EAMM-A-S38-40G-G2
EMGA-40-P-G...-SST-42		
With integrated drive		
EMCA-EC-67-...	1456638	EAMM-A-S38-67A-G2
With integrated drive and gear unit		
EMCA-EC-67-...	1456647	EAMM-A-S38-40G-G2
EMGC-40-...		

Motor ¹⁾	Axial kit	
Type	Part No.	Type
EGC-HD-160		
With servo motor		
EMMS-AS-55-...	558164	EAMM-A-S48-55A ²⁾
	3637961	EAMM-A-S48-55A-G2
EMME-AS-60-...	2220560	EAMM-A-S48-60P ²⁾
	3637964	EAMM-A-S48-60P-G2
EMMS-AS-70-...	558165	EAMM-A-S48-70A ²⁾
	3637957	EAMM-A-S48-70A-G2
With servo motor and gear unit		
EMME-AS-40-...	1456650	EAMM-A-S48-40G-G2
EMGA-40-P-G...-EAS-40		
EMMS-AS-40-...	1456650	EAMM-A-S48-40G-G2
EMGA-40-P-G...-SAS-40		
EMMS-AS-55-...	2256701	EAMM-A-S48-60G-G2
EMGA-60-P-G...-SAS-55		
EMME-AS-60-...	1456652	EAMM-A-S48-60H-G2
EMGA-60-P-G...-EAS-60		
EMMS-AS-70-...	2256701	EAMM-A-S48-60G-G2
EMGA-60-P-G...-SAS-70		
With stepper motor		
EMMS-ST-57-...	560687	EAMM-A-S48-57A ²⁾
	3637963	EAMM-A-S48-57A-G2
EMMS-ST-87-...	560687	EAMM-A-S48-87A ²⁾
	3637962	EAMM-A-S48-87A-G2
With stepper motor and gear unit		
EMMS-ST-42-...	1456650	EAMM-A-S48-40G-G2
EMGA-40-P-G...-SST-42		
EMMS-ST-57-...	2256701	EAMM-A-S48-60G-G2
EMGA-40-P-G...-SST-57		
With integrated drive and gear unit		
EMCA-EC-67-...	1456650	EAMM-A-S48-40G-G2
EMGC-40-...		
EMCA-EC-67-...	1456652	EAMM-A-S48-60H-G2
EMGC-60-...		

- 1) The input torque must not exceed the maximum permissible transferable torque of the axial kit.
- 2) Type discontinued

Axial kits EAMM-A

Product range overview

Permissible axis/motor combinations with spindle axis EGC-HD-BS

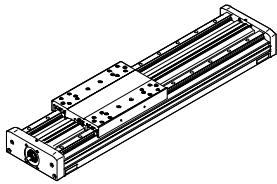

Motor ¹⁾	Axial kit	
Type	Part No.	Type
EGC-HD-220		
With servo motor		
EMMS-AS-70-...	558166	EAMM-A-S62-70A ²⁾
	3637959	EAMM-A-S62-70A-G2
EMME-AS-80-...	2222582	EAMM-A-S62-80P ²⁾
	3637970	EAMM-A-S62-80P-G2
EMME-AS-100-...	558167	EAMM-A-S62-100A ²⁾
	3637960	EAMM-A-S62-100A-G2
EMMS-AS-100-...	558167	EAMM-A-S62-100A ²⁾
	3637960	EAMM-A-S62-100A-G2
EMMS-AS-140-...	558168	EAMM-A-S62-140A ²⁾
	3637969	EAMM-A-S62-140A-G2
With servo motor and gear unit		
EMMS-AS-55-...	2297649	EAMM-A-S62-60G-G2
EMGA-60-P-G...-SAS-55		
EMME-AS-60-...	1456654	EAMM-A-S62-60H-G2
EMGA-60-P-G...-EAS-60		
EMMS-AS-70-...	2297649	EAMM-A-S62-60G-G2
EMGA-60-P-G...-SAS-70		
EMMS-AS-70-...	1972530	EAMM-A-S62-80G-G2
EMGA-80-P-G...-SAS-70		
EMME-AS-80-...	1972530	EAMM-A-S62-80G-G2
EMGA-80-P-G...-EAS-80		
EMMS-AS-100-...	1972530	EAMM-A-S62-80G-G2
EMGA-80-P-G...-SAS-100		
With stepper motor		
EMMS-ST-87-...	560689	EAMM-A-S62-87A ²⁾
	3637966	EAMM-A-S62-87A-G2
With stepper motor and gear unit		
EMMS-ST-57-...	2297649	EAMM-A-S62-60G-G2
EMGA-60-P-G...-SST-57		
EMMS-ST-87-...	1972530	EAMM-A-S62-80G-G2
EMGA-80-P-G...-SST-87		
With integrated drive and gear unit		
EMCA-EC-67-...	1456654	EAMM-A-S62-60H-G2
EMGC-60-...		
EMCA-EC-67-...	1972530	EAMM-A-S62-80G-G2
EMGC-80-...		

- 1) The input torque must not exceed the maximum permissible transferable torque of the axial kit.
 2) Type discontinued

Axial kits EAMM-A

Product range overview

FESTO

Permissible axis/motor combinations with mini slide EGSL

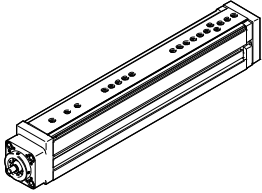

Motor/gear unit ¹⁾	Axial kit	
Type	Part No.	Type
EGSL-35		
With servo motor		
EMME-AS-40-...	1981953	EAMM-A-D19-40P
EMMS-AS-40-...	1199152	EAMM-A-D19-40A
With stepper motor		
EMMS-ST-28-...	1081659	EAMM-A-D19-28A
EMMS-ST-42-...	1087642	EAMM-A-D19-42A
EGSL-45		
With servo motor		
EMME-AS-40-...	1976465	EAMM-A-D32-40P
EMMS-AS-40-...	543147	EAMM-A-D32-40A
EMMS-AS-55-...	550979	EAMM-A-D32-55A
EMME-AS-60-...	1956054	EAMM-A-D32-60P
With servo motor and gear unit		
EMME-AS-40-...	1454238	EAMM-A-D32-40G
EMGA-40-P-G...-EAS-40		
EMMS-AS-40-...	1454238	EAMM-A-D32-40G
EMGA-40-P-G...-SAS-40		
EMMS-AS-55-...	2946758	EAMM-A-D32-60G
EMGA-60-P-G...-SAS-55		
EMME-AS-60-...	2946760	EAMM-A-D32-60H
EMGA-60-P-G...-EAS-60		
EMMS-AS-70-...	2946758	EAMM-A-D32-60G
EMGA-60-P-G...-SAS-70		
With stepper motor		
EMMS-ST-42-...	543148	EAMM-A-D32-42A
EMMS-ST-57-...	550980	EAMM-A-D32-57A
With stepper motor and gear unit		
EMMS-ST-42-...	1454238	EAMM-A-D32-40G
EMGA-40-P-G...-SST-42		
EMMS-ST-57-...	2946758	EAMM-A-D32-60G
EMGA-40-P-G...-SST-57		
With integrated drive		
EMCA-EC-67-...	1454239	EAMM-A-D32-67A
With integrated drive and gear unit		
EMCA-EC-67-...	1454238	EAMM-A-D32-40G
EMGC-40-...		
EMCA-EC-67-...	2946760	EAMM-A-D32-60H
EMGC-60-...		

Motor/gear unit ¹⁾	Axial kit	
Type	Part No.	Type
EGSL-55		
With servo motor		
EMMS-AS-55-...	543153	EAMM-A-D40-55A
EMME-AS-60-...	1977000	EAMM-A-D40-60P
EMMS-AS-70-...	550981	EAMM-A-D40-70A
With servo motor and gear unit		
EMME-AS-40-...	560282	EAMM-A-D40-40G ²⁾
EMGA-40-P-G...-EAS-40	2256398	EAMM-A-D40-40G-G2
EMMS-AS-40-...	560282	EAMM-A-D40-40G ²⁾
EMGA-40-P-G...-SAS-40	2256398	EAMM-A-D40-40G-G2
EMMS-AS-55-...	2256400	EAMM-A-D40-60G
EMGA-60-P-G...-SAS-55		
EMME-AS-60-...	1454242	EAMM-A-D40-60H
EMGA-60-P-G...-EAS-60		
EMMS-AS-70-...	2256400	EAMM-A-D40-60G
EMGA-60-P-G...-SAS-70		
With stepper motor		
EMMS-ST-57-...	543154	EAMM-A-D40-57A
EMMS-ST-87-...	550982	EAMM-A-D40-87A
With stepper motor and gear unit		
EMMS-ST-42-...	560282	EAMM-A-D40-40G ²⁾
EMGA-40-P-G...-SST-42	2256398	EAMM-A-D40-40G-G2
EMMS-ST-57-...	2256400	EAMM-A-D40-60G
EMGA-60-P-G...-SST-57		
With integrated drive		
EMCA-EC-67-...	1454243	EAMM-A-D40-67A
With integrated drive and gear unit		
EMCA-EC-67-...	560282	EAMM-A-D40-40G ²⁾
EMGC-40-...	2256398	EAMM-A-D40-40G-G2
EMCA-EC-67-...	1454242	EAMM-A-D40-60H
EMGC-60-...		

- 1) The input torque must not exceed the maximum permissible transferable torque of the axial kit.
- 2) Type discontinued

Axial kits EAMM-A

Product range overview

Permissible axis/motor combinations with mini slide EGSL

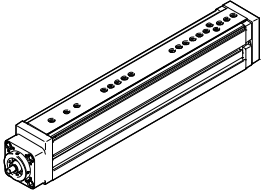

Motor/gear unit ¹⁾	Axial kit	
Type	Part No.	Type
EGSL-75		
With servo motor		
EMMS-AS-70-...	543161	EAMM-A-D60-70A
EMME-AS-80-...	1977073	EAMM-A-D60-80P
EMME-AS-100-...	550983	EAMM-A-D60-100A
EMMS-AS-100-...	550983	EAMM-A-D60-100A
With servo motor and gear unit		
EMMS-AS-55-...	560283	EAMM-A-D60-60G ²⁾
EMGA-60-P-G...-SAS-55	2256696	EAMM-A-D60-60G-G2
EMME-AS-60-...	1454245	EAMM-A-D60-60H
EMGA-60-P-G...-EAS-60		
EMMS-AS-70-...	560283	EAMM-A-D60-60G ²⁾
EMGA-60-P-G...-SAS-70	2256696	EAMM-A-D60-60G-G2
EMMS-AS-70-...	1499402	EAMM-A-D60-80G
EMGA-80-P-G...-SAS-70		
EMME-AS-80-...	1499402	EAMM-A-D60-80G
EMGA-80-P-G...-EAS-80		
EMMS-AS-100-...	1499402	EAMM-A-D60-80G
EMGA-80-P-G...-SAS-100		
With stepper motor		
EMMS-ST-87-...	543162	EAMM-A-D60-87A
With stepper motor and gear unit		
EMMS-ST-57-...	560283	EAMM-A-D60-60G ²⁾
EMGA-60-P-G...-SST-57	2256696	EAMM-A-D60-60G-G2
EMMS-ST-87-...	1499402	EAMM-A-D60-80G
EMGA-80-P-G...-SST-87		
With integrated drive and gear unit		
EMCA-EC-67-...	1454245	EAMM-A-D60-60H
EMGC-60-...		

1) The input torque must not exceed the maximum permissible transferable torque of the axial kit.
 2) Type discontinued

Axial kits EAMM-A

Product range overview

FESTO

Permissible axis/motor combinations with electric slide EGSK, EGSP

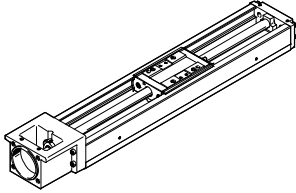

Motor/gear unit ¹⁾	Axial kit	
Type	Part No.	Type
EGSK-15		
With servo motor		
EMME-AS-40-...	1982886	EAMM-A-P3-28D-40P
With stepper motor		
EMMS-ST-28-...	1703478	EAMM-A-P3-28D-28A
EGSK-20/EGSP-20		
With servo motor		
EMME-AS-40-...	1983071	EAMM-A-P4-28B-40P
EMMS-AS-40-...	562637	EAMM-A-P4-28B-40A
With stepper motor		
EMMS-ST-28-...	1731466	EAMM-A-P4-28B-28A
EMMS-ST-42-...	562636	EAMM-A-P4-28B-42A
EGSK-26/EGSP-26		
With servo motor		
EMME-AS-40-...	1983122	EAMM-A-P5-28B-40P
EMMS-AS-40-...	562641	EAMM-A-P5-28B-40A
With stepper motor		
EMMS-ST-28-...	1731474	EAMM-A-P5-28B-28A
EMMS-ST-42-...	562640	EAMM-A-P5-28B-42A
EGSK-33		
With servo motor		
EMME-AS-40-...	1983450	EAMM-A-P6-38A-40P
EMMS-AS-40-...	562646	EAMM-A-P6-38A-40A
EMMS-AS-55-...	562647	EAMM-A-P6-38A-55A
EMME-AS-60-...	2264375	EAMM-A-P6-38A-60P
With servo motor and gear unit		
EMME-AS-40-...	2297645	EAMM-A-P6-38A-40G
EMGA-40-P-G...-EAS-40		
EMMS-AS-40-...	2297645	EAMM-A-P6-38A-40G
EMGA-40-P-G...-SAS-40		
With stepper motor		
EMMS-ST-42-...	562644	EAMM-A-P6-38A-42A
EMMS-ST-57-...	562645	EAMM-A-P6-38A-57A
With stepper motor and gear unit		
EMMS-ST-42-...	2297645	EAMM-A-P6-38A-40G
EMGA-40-P-G...-SST-42		
With integrated drive		
EMCA-EC-67-...	2297641	EAMM-A-P6-38A-67A
With integrated drive and gear unit		
EMCA-EC-67-...	2297645	EAMM-A-P6-38A-40G
EMGC-40-...		

Motor/gear unit ¹⁾	Axial kit	
Type	Part No.	Type
EGSK-46/EGSP-33		
With servo motor		
EMME-AS-40-...	1986292	EAMM-A-P8-38A-40P
EMMS-AS-40-...	562652	EAMM-A-P8-38A-40A
EMMS-AS-55-...	562653	EAMM-A-P8-38A-55A
EMME-AS-60-...	1987308	EAMM-A-P8-38A-60P
EMMS-AS-70-...	564996	EAMM-A-P8-38A-70A
With servo motor and gear unit		
EMME-AS-40-...	2297646	EAMM-A-P8-38A-40G
EMGA-40-P-G...-EAS-40		
EMMS-AS-40-...	2297646	EAMM-A-P8-38A-40G
EMGA-40-P-G...-SAS-40		
With stepper motor		
EMMS-ST-42-...	562650	EAMM-A-P8-38A-42A
EMMS-ST-57-...	562651	EAMM-A-P8-38A-57A
EMMS-ST-87-...	564998	EAMM-A-P8-38A-87A
With stepper motor and gear unit		
EMMS-ST-42-...	2297646	EAMM-A-P8-38A-40G
EMGA-40-P-G...-SST-42		
With integrated drive		
EMCA-EC-67-...	2297643	EAMM-A-P8-38A-67A
With integrated drive and gear unit		
EMCA-EC-67-...	2297646	EAMM-A-P8-38A-40G
EMGC-40-...		
EGSP-46		
With servo motor		
EMMS-AS-55-...	562659	EAMM-A-P10-38A-55A
EMME-AS-60-...	2036017	EAMM-A-P10-38A-60P
EMMS-AS-70-...	564997	EAMM-A-P10-38A-70A
With servo motor and gear unit		
EMME-AS-40-...	2297648	EAMM-A-P10-38A-40G
EMGA-40-P-G...-EAS-40		
EMMS-AS-40-...	2297648	EAMM-A-P10-38A-40G
EMGA-40-P-G...-SAS-40		
With stepper motor		
EMMS-ST-57-...	562658	EAMM-A-P10-38A-57A
EMMS-ST-87-...	564999	EAMM-A-P10-38A-87A
With stepper motor and gear unit		
EMMS-ST-42-...	2297648	EAMM-A-P10-38A-40G
EMGA-40-P-G...-SST-42		
With integrated drive		
EMCA-EC-67-...	2297644	EAMM-A-P10-38A-67A
With integrated drive and gear unit		
EMCA-EC-67-...	2297648	EAMM-A-P10-38A-40G
EMGC-40-...		

1) The input torque must not exceed the maximum permissible transferable torque of the axial kit.

Axial kits EAMM-A

Product range overview

Permissible axis/motor combinations with cantilever axis DGEA

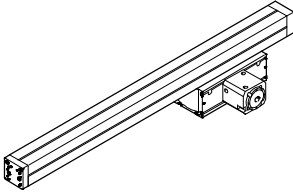

Motor/gear unit ¹⁾	Axial kit	
Type	Part No.	Type
DGEA-18		
With servo motor and gear unit		
EMME-AS-40-... EMGA-40-P-G...-EAS-40	1454251	EAMM-A-F28-40G
EMMS-AS-40-... EMGA-40-P-G...-SAS-40	1454251	EAMM-A-F28-40G
EMMS-AS-55-... EMGA-60-P-G...-SAS-55	550957	EAMM-A-F28-60G
EMME-AS-60-... EMGA-60-P-G...-EAS-60	1454252	EAMM-A-F28-60H
EMMS-AS-70-... EMGA-60-P-G...-SAS-70	550957	EAMM-A-F28-60G
With stepper motor		
EMMS-ST-57-...	550956	EAMM-A-F28-57A
EMMS-ST-87-...	550958	EAMM-A-F28-87A
With stepper motor and gear unit		
EMMS-ST-42-... EMGA-40-P-G...-SST-42	1454251	EAMM-A-F28-40G
EMMS-ST-57-... EMGA-60-P-G...-SST-57	550957	EAMM-A-F28-60G
With integrated drive and gear unit		
EMCA-EC-67-... EMGC-40-...	1454251	EAMM-A-F28-40G
EMCA-EC-67-... EMGC-60-...	1454252	EAMM-A-F28-60H

Motor/gear unit ¹⁾	Axial kit	
Type	Part No.	Type
DGEA-25		
With servo motor and gear unit		
EMMS-AS-55-... EMGA-60-P-G...-SAS-55	550959	EAMM-A-F32-60G
EMME-AS-60-... EMGA-60-P-G...-EAS-60	1454256	EAMM-A-F32-60H
EMMS-AS-70-... EMGA-60-P-G...-SAS-70	550959	EAMM-A-F32-60G
With stepper motor		
EMMS-ST-87-...	550960	EAMM-A-F32-87A
With stepper motor and gear unit		
EMMS-ST-57-... EMGA-60-P-G...-SST-57	550959	EAMM-A-F32-60G
With integrated drive and gear unit		
EMCA-EC-67-... EMGC-60-...	1454256	EAMM-A-F32-60H
DGEA-40		
With servo motor and gear unit		
EMMS-AS-70-... EMGA-80-P-G...-SAS-70	550935	EAMM-A-F40-80G
EMME-AS-80-... EMGA-80-P-G...-EAS-80	550935	EAMM-A-F40-80G
EMMS-AS-100-... EMGA-80-P-G...-SAS-100	550935	EAMM-A-F40-80G
With stepper motor and gear unit		
EMMS-ST-87-... EMGA-80-P-G...-SST-87	550935	EAMM-A-F40-80G

1) The input torque must not exceed the maximum permissible transferable torque of the axial kit.

Axial kits EAMM-A

Product range overview

FESTO

Permissible axis/motor combinations with toothed belt axis ELGG

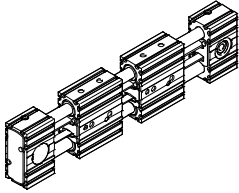

Motor/gear unit ¹⁾	Axial kit	
Type	Part No.	Type
ELGG-35		
With servo motor		
EMMS-AS-55-...	1133400	EAMM-A-R27-55A
With servo motor and gear unit		
EMME-AS-40-... EMGA-40-P-G...-EAS-40	1456622	EAMM-A-R27-40G
EMMS-AS-40-... EMGA-40-P-G...-SAS-40	1456622	EAMM-A-R27-40G
With stepper motor		
EMMS-ST-57-...	1133403	EAMM-A-R27-57A
With stepper motor and gear unit		
EMMS-ST-42-... EMGA-40-P-G...-SST-42	1456622	EAMM-A-R27-40G
With integrated drive		
EMCA-EC-67-...	1456619	EAMM-A-R27-67A
With integrated drive and gear unit		
EMCA-EC-67-... EMGC-40-...	1456622	EAMM-A-R27-40G
ELGG-45		
With servo motor		
EMME-AS-60-...	2224996	EAMM-A-R38-60P
EMMS-AS-70-...	1133401	EAMM-A-R38-70A
With servo motor and gear unit		
EMME-AS-40-... EMGA-40-P-G...-EAS-40	1456623	EAMM-A-R38-40G
EMMS-AS-40-... EMGA-40-P-G...-SAS-40	1456623	EAMM-A-R38-40G
EMMS-AS-55-... EMGA-60-P-G...-SAS-55	2310075	EAMM-A-R38-60G
EMME-AS-60-... EMGA-60-P-G...-EAS-60	1456630	EAMM-A-R38-60H
EMMS-AS-70-... EMGA-60-P-G...-SAS-70	2310075	EAMM-A-R38-60G
With stepper motor		
EMMS-ST-57-...	1578138	EAMM-A-R38-57A
EMMS-ST-87-...	1133404	EAMM-A-R38-87A
With stepper motor and gear unit		
EMMS-ST-42-... EMGA-40-P-G...-SST-42	1456623	EAMM-A-R38-40G
EMMS-ST-57-... EMGA-60-P-G...-SST-57	2310075	EAMM-A-R38-60G
With integrated drive and gear unit		
EMCA-EC-67-... EMGC-40-...	1456623	EAMM-A-R38-40G
EMCA-EC-67-... EMGC-60-...	1456630	EAMM-A-R38-60H

Motor/gear unit ¹⁾	Axial kit	
Type	Part No.	Type
ELGG-55		
With servo motor		
EMMS-AS-70-...	1578139	EAMM-A-R48-70A
EMME-AS-80-...	2225090	EAMM-A-R48-80P
EMMS-AS-100-...	1133402	EAMM-A-R48-100A
With servo motor and gear unit		
EMMS-AS-55-... EMGA-60-P-G...-SAS-55	2374780	EAMM-A-R48-60G
EMME-AS-60-... EMGA-60-P-G...-EAS-60	1456633	EAMM-A-R48-60H
EMMS-AS-70-... EMGA-60-P-G...-SAS-70	2374780	EAMM-A-R48-60G
With stepper motor		
EMMS-ST-87-...	1133405	EAMM-A-R48-87A
With stepper motor and gear unit		
EMMS-ST-57-... EMGA-60-P-G...-SST-57	2374780	EAMM-A-R48-60G
With integrated drive and gear unit		
EMCA-EC-67-... EMGC-60-...	1456633	EAMM-AR48-60H

1) The input torque must not exceed the maximum permissible transferable torque of the axial kit.

Axial kits EAMM-A

Product range overview

Permissible axis/motor combinations with toothed belt axis ELGR

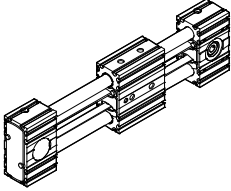

Motor ¹⁾	Axial kit	
Type	Part No.	Type
ELGR-35		
With servo motor		
EMMS-AS-55-...	1133400	EAMM-A-R27-55A
With servo motor and gear unit		
EMME-AS-40-... EMGA-40-P-G...-EAS-40	1456622	EAMM-A-R27-40G
EMMS-AS-40-... EMGA-40-P-G...-SAS-40	1456622	EAMM-A-R27-40G
With stepper motor		
EMMS-ST-57-...	1133403	EAMM-A-R27-57A
With stepper motor and gear unit		
EMMS-ST-42-... EMGA-40-P-G...-SST-42	1456622	EAMM-A-R27-40G
With integrated drive		
EMCA-EC-67-...	1456619	EAMM-A-R27-67A
With integrated drive and gear unit		
EMCA-EC-67-... EMGC-40-...	1456622	EAMM-A-R27-40G
ELGR-45		
With servo motor		
EMME-AS-60-...	2224996	EAMM-A-R38-60P
EMMS-AS-70-...	1133401	EAMM-A-R38-70A
With servo motor and gear unit		
EMME-AS-40-... EMGA-40-P-G...-EAS-40	1456623	EAMM-A-R38-40G
EMMS-AS-40-... EMGA-40-P-G...-SAS-40	1456623	EAMM-A-R38-40G
EMMS-AS-55-... EMGA-60-P-G...-SAS-55	2310075	EAMM-A-R38-60G
EMME-AS-60-... EMGA-60-P-G...-EAS-60	1456630	EAMM-A-R38-60H
EMMS-AS-70-... EMGA-60-P-G...-SAS-70	2310075	EAMM-A-R38-60G
With stepper motor		
EMMS-ST-57-...	1578138	EAMM-A-R38-57A
EMMS-ST-87-...	1133404	EAMM-A-R38-87A
With stepper motor and gear unit		
EMMS-ST-42-... EMGA-40-P-G...-SST-42	1456623	EAMM-A-R38-40G
EMMS-ST-57-... EMGA-60-P-G...-SST-57	2310075	EAMM-A-R38-60G
With integrated drive and gear unit		
EMCA-EC-67-... EMGC-40-...	1456623	EAMM-A-R38-40G
EMCA-EC-67-... EMGC-60-...	1456630	EAMM-A-R38-60H

Motor ¹⁾	Axial kit	
Type	Part No.	Type
ELGR-55		
With servo motor		
EMMS-AS-70-...	1578139	EAMM-A-R48-70A
EMME-AS-80-...	2225090	EAMM-A-R48-80P
EMMS-AS-100-...	1133402	EAMM-A-R48-100A
With servo motor and gear unit		
EMMS-AS-55-... EMGA-60-P-G...-SAS-55	2374780	EAMM-A-R48-60G
EMME-AS-60-... EMGA-60-P-G...-EAS-60	1456633	EAMM-A-R48-60H
EMMS-AS-70-... EMGA-60-P-G...-SAS-70	2374780	EAMM-A-R48-60G
With stepper motor		
EMMS-ST-87-...	1133405	EAMM-A-R48-87A
With stepper motor and gear unit		
EMMS-ST-57-... EMGA-60-P-G...-SST-57	2374780	EAMM-A-R48-60G
With integrated drive and gear unit		
EMCA-EC-67-... EMGC-60-...	1456633	EAMM-AR48-60H

1) The input torque must not exceed the maximum permissible transferable torque of the axial kit.

Axial kits EAMM-A

Product range overview

FESTO

Permissible axis/motor combinations with rotary module ERMB

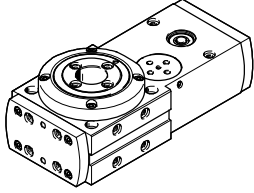

Motor/gear unit ¹⁾	Axial kit	
Type	Part No.	Type
ERMB-20		
With servo motor		
EMME-AS-40-...	2207441	EAMM-A-D32-35A-40P
EMMS-AS-40-...	560281	EAMM-A-D32-35A-40A
With stepper motor		
EMMS-ST-42-...	543148	EAMM-A-D32-42A
EMMS-ST-57-...	550980	EAMM-A-D32-57A
With integrated drive		
EMCA-EC-67-...	1454239	EAMM-A-D32-67A
With motor unit		
MTR-DCI-32S-...	543149	EAMM-A-D32-32B
With integrated drive and gear unit		
EMCA-EC-67-...	1454238	EAMM-A-D32-40G
EMGC-40-...		
EMCA-EC-67-...	2946760	EAMM-A-D32-60H
EMGC-60-...		
ERMB-25		
With servo motor		
EMMS-AS-55-...	543153	EAMM-A-D40-55A
EMME-AS-60-...	1977000	EAMM-A-D40-60P
EMMS-AS-70-...	550981	EAMM-A-D40-70A
With servo motor and gear unit		
EMME-AS-40-...	560282	EAMM-A-D40-40G
EMGA-40-P-G...-EAS-40		
EMMS-AS-40-...	560282	EAMM-A-D40-40G
EMGA-40-P-G...-SAS-40		
With stepper motor		
EMMS-ST-57-...	543154	EAMM-A-D40-57A
With stepper motor and gear unit		
EMMS-ST-42-...	560282	EAMM-A-D40-40G
EMGA-40-P-G...-SST-42		
With integrated drive		
EMCA-EC-67-...	1454243	EAMM-A-D40-67A
With motor unit		
MTR-DCI-42S-...-G7	543155	EAMM-A-D40-42B
MTR-DCI-42S-...-G14	543156	EAMM-A-D40-42C
With integrated drive and gear unit		
EMCA-EC-67-...	560282	EAMM-A-D40-40G ²⁾
EMGC-40-...	2256398	EAMM-A-D40-40G-G2
EMCA-EC-67-...	1454242	EAMM-A-D32-60H
EMGC-60-...		

Motor/gear unit ¹⁾	Axial kit	
Type	Part No.	Type
ERMB-32		
With servo motor		
EMMS-AS-70-...	543161	EAMM-A-D60-70A
EMME-AS-80-...	1977073	EAMM-A-D60-80P
EMME-AS-100-...	550983	EAMM-A-D60-100A
EMMS-AS-100-...	550983	EAMM-A-D60-100A
With servo motor and gear unit		
EMMS-AS-55-...	560283	EAMM-A-D60-60G
EMGA-60-P-G...-SAS-55		
EMMS-AS-70-...	560283	EAMM-A-D60-60G
EMGA-60-P-G...-SAS-70		
With stepper motor		
EMMS-ST-87-...	543162	EAMM-A-D60-87A
With stepper motor and gear unit		
EMMS-ST-57-...	560283	EAMM-A-D60-60G
EMGA-60-P-G...-SST-57		
With motor unit		
MTR-DCI-52S-...-G7	543163	EAMM-A-D60-52B
MTR-DCI-52S-...-G14	543164	EAMM-A-D60-52C
With integrated drive and gear unit		
EMCA-EC-67-...	1454245	EAMM-A-D60-60H
EMGC-60-...		

- 1) The input torque must not exceed the maximum permissible transferable torque of the axial kit.
- 2) Type discontinued

Axial kits EAMM-A

Product range overview

Permissible axis/motor combinations with rotary/lifting module EHMB

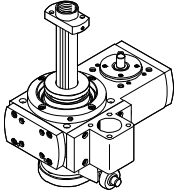

For rotary movement		
Motor/gear unit ¹⁾	Axial kit	
Type	Part No.	Type
EHMB-20		
With servo motor		
EMME-AS-40-...	2207441	EAMM-A-D32-35A-40P
EMMS-AS-40-...	560281	EAMM-A-D32-35A-40A
With stepper motor		
EMMS-ST-42-...	543148	EAMM-A-D32-42A
EMMS-ST-57-...	550980	EAMM-A-D32-57A
With integrated drive		
EMCA-EC-67-...	1454239	EAMM-A-D32-67A
With motor unit		
MTR-DCI-32S-...	543149	EAMM-A-D32-32B
With integrated drive and gear unit		
EMCA-EC-67-...	1454238	EAMM-A-D32-40G
EMGC-40-...		
EMCA-EC-67-...	2946760	EAMM-A-D32-60H
EMGC-60-...		
EHMB-25		
With servo motor		
EMMS-AS-55-...	543153	EAMM-A-D40-55A
EMME-AS-60-...	1977000	EAMM-A-D40-60P
EMMS-AS-70-...	550981	EAMM-A-D40-70A
With servo motor and gear unit		
EMME-AS-40-...	560282	EAMM-A-D40-40G
EMGA-40-P-G...-EAS-40		
EMMS-AS-40-...	560282	EAMM-A-D40-40G
EMGA-40-P-G...-SAS-40		
With stepper motor		
EMMS-ST-57-...	543154	EAMM-A-D40-57A
With stepper motor and gear unit		
EMMS-ST-42-...	560282	EAMM-A-D40-40G
EMGA-40-P-G...-SST-42		
With integrated drive		
EMCA-EC-67-...	1454243	EAMM-A-D40-67A
With motor unit		
MTR-DCI-42S-...-G7	543155	EAMM-A-D40-42B
MTR-DCI-42S-...-G14	543156	EAMM-A-D40-42C
With integrated drive and gear unit		
EMCA-EC-67-...	560282	EAMM-A-D40-40G ²⁾
EMGC-40-...	2256398	EAMM-A-D40-40G-G2
EMCA-EC-67-...	1454242	EAMM-A-D40-60H
EMGC-60-...		

For rotary movement		
Motor/gear unit ¹⁾	Axial kit	
Type	Part No.	Type
EHMB-32		
With servo motor		
EMMS-AS-70-...	543161	EAMM-A-D60-70A
EMME-AS-80-...	1977073	EAMM-A-D60-80P
EMME-AS-100-...	550983	EAMM-A-D60-100A
EMMS-AS-100-...	550983	EAMM-A-D60-100A
With servo motor and gear unit		
EMMS-AS-55-...	560283	EAMM-A-D60-60G
EMGA-60-P-G...-SAS-55		
EMMS-AS-70-...	560283	EAMM-A-D60-60G
EMGA-60-P-G...-SAS-70		
With stepper motor		
EMMS-ST-87-...	543162	EAMM-A-D60-87A
With stepper motor and gear unit		
EMMS-ST-57-...	560283	EAMM-A-D60-60G
EMGA-60-P-G...-SST-57		
With motor unit		
MTR-DCI-52S-...-G7	543163	EAMM-A-D60-52B
MTR-DCI-52S-...-G14	543164	EAMM-A-D60-52C
With integrated drive and gear unit		
EMCA-EC-67-...	1454245	EAMM-A-D60-60H
EMGC-60-...		

- 1) The input torque must not exceed the maximum permissible transferable torque of the axial kit.
- 2) Type discontinued

Axial kits EAMM-A

Technical data

Materials:

Coupling housing, coupling hubs,

motor flange: aluminium

Screws: galvanised steel



General technical data						
Type	For axis	Transferable torque [Nm]	Mass moment of inertia [kgmm ²]	Max. rotational speed [rpm]	Weight [g]	→ Page
EAMM-A-D19-28A	EGSL	1.1	0.28	10000	80	44
EAMM-A-D19-40A	EGSL	1.1	0.28	10000	110	
EAMM-A-D19-40P	EGSL	1.1	0.28	10000	110	
EAMM-A-D19-42A	EGSL	1.1	0.28	10000	130	
EAMM-A-D32-32B	EHMB, ERMB	1.1	0.28	10000	150	
EAMM-A-D32-40A	EGSL, ESBF	1.1	0.28	10000	130	
EAMM-A-D32-40G	EGSL, ESBF	6.5	5.87	8000	420	
EAMM-A-D32-40P	EGSL, ESBF	1.1	0.28	10000	160	
EAMM-A-D32-35A-40A	EHMB, ERMB	4	5.87	8000	220	
EAMM-A-D32-35A-40P	EHMB, ERMB	4	5.87	8000	160	
EAMM-A-D32-42A	EGSL, EHMB, ERMB, ESBF	1.1	0.28	10000	140	
EAMM-A-D32-55A	EGSL, EHMB, ESBF	4	5.87	8000	260	
EAMM-A-D32-57A	EGSL, EHMB, ERMB, ESBF	4	5.87	8000	270	
EAMM-A-D32-60G	EGSL, ESBF	6.5	5.87	8000	540	
EAMM-A-D32-60H	EGSL, ESBF	6.5	5.87	8000	540	
EAMM-A-D32-60P	EGSL, EHMB, ERMB, ESBF	4	5.87	8000	410	
EAMM-A-D32-67A	EGSL, ESBF	6.5	5.87	8000	410	
EAMM-A-D40-40G	EHMB, ERMB, EGSL	8	5.87	8000	350	
EAMM-A-D40-40G-G2	EGSL, ESBF	8	5.87	8000	450	
EAMM-A-D40-42B	EHMB, ERMB	8	5.87	8000	340	
EAMM-A-D40-42C	EHMB, ERMB	8	5.87	8000	370	
EAMM-A-D40-55A	EGSL, EHMB, ERMB, ESBF	8	5.87	8000	350	
EAMM-A-D40-57A	EGSL, EHMB, ERMB, ESBF	6	5.87	8000	350	
EAMM-A-D40-60G	EGSL, ESBF	12.5	5.87	8000	570	
EAMM-A-D40-60H	EGSL, ESBF	12.5	5.87	8000	570	
EAMM-A-D40-60P	EGSL, EHMB, ERMB, ESBF	8	5.87	8000	430	
EAMM-A-D40-67A	EGSL, ESBF	12.5	5.87	8000	440	
EAMM-A-D40-70A	EGSL, EHMB, ERMB, ESBF	8	5.87	8000	410	
EAMM-A-D40-87A	EGSL, EHMB, ERMB, ESBF	8	5.87	8000	530	
EAMM-A-D50-60G	ESBF	17	34.8	6000	570	
EAMM-A-D50-60H	ESBF	17	34.8	6000	570	
EAMM-A-D50-70A	ESBF	12	34.8	6000	740	
EAMM-A-D50-80G	ESBF	17	34.8	6000	1190	
EAMM-A-D50-80P	ESBF	14	34.8	6000	890	
EAMM-A-D50-87A	ESBF	12	34.8	6000	860	
EAMM-A-D50-100A	ESBF	14	34.8	6000	1140	

Axial kits EAMM-A

Technical data

General technical data						
Type	For axis	Transferable torque [Nm]	Mass moment of inertia [kgmm ²]	Max. rotational speed [rpm]	Weight [g]	→ Page
EAMM-A-D60-52B	EHMB, ERMB	14	34.8	6000	930	44
EAMM-A-D60-52C	EHMB, ERMB	14	34.8	6000	1020	
EAMM-A-D60-60G	EHMB, ERMB, EGSL	12	34.8	6000	830	
EAMM-A-D60-60G-G2	EGSL, ESBF	12	34.8	6000	1350	
EAMM-A-D60-60H	EGSL, ESBF	17	34.8	6000	1250	
EAMM-A-D60-70A	EGSL, EHMB, ERMB, ESBF	12	34.8	6000	750	
EAMM-A-D60-80G	EGSL, ESBF	17	34.8	6000	1350	
EAMM-A-D60-80P	EGSL, EHMB, ERMB, ESBF	14	34.8	6000	1040	
EAMM-A-D60-87A	EGSL, EHMB, ERMB, ESBF	12	34.8	6000	890	
EAMM-A-D60-100A	EGSL, EHMB, ERMB, ESBF	14	34.8	6000	1170	
EAMM-A-D80-80G	ESBF	60	128	5500	1990	
EAMM-A-D80-100A	ESBF	60	128	5500	2030	
EAMM-A-D80-140A	ESBF	60	128	5500	2920	
EAMM-A-D100-100A	ESBF	60	128	5500	2450	
EAMM-A-D100-120G	ESBF	143	280	4500	3520	
EAMM-A-D100-140A	ESBF	143	280	4500	3460	
EAMM-A-E20-32B	DMES	1.5	0.23	10000	100	41
EAMM-A-E20-40A	DGE-SP, DMES	1	0.13	12000	80	
EAMM-A-E20-42A	DGE-SP, DMES	1	0.13	12000	100	
EAMM-A-E20-55A	DGE-SP, DMES	1	0.13	12000	140	
EAMM-A-E32-40A	DGE-SP, DMES	7.5	6.1	8000	250	
EAMM-A-E32-40G	DGE-SP, DMES	7.5	6.1	8000	290	
EAMM-A-E32-42B	DMES	6.5	5.87	8000	340	
EAMM-A-E32-42C	DMES	6.5	5.87	8000	380	
EAMM-A-E32-55A	DGE-SP, DMES	7.5	6.1	8000	280	
EAMM-A-E32-57A	DGE-SP, DMES	7.5	6.1	8000	290	
EAMM-A-E32-67A	DMES	7.5	6.1	8000	380	
EAMM-A-E48-40G	DGE-SP	8.8	6.1	8000	550	
EAMM-A-E48-44A-70A	DGE-SP	9.2	6.1	8000	600	
EAMM-A-E48-52B	DMES	17	34.8	6000	1120	
EAMM-A-E48-52C	DMES	17	34.8	6000	1210	
EAMM-A-E48-55A	DGE-SP	8.5	6.1	8000	530	
EAMM-A-E48-57A	DGE-SP	7.5	6.1	8000	540	
EAMM-A-E48-60H	DGE-SP	17	42.3	6500	920	
EAMM-A-E48-64A-70A	DMES	17	42.3	6500	790	
EAMM-A-E48-67A	DGE-SP	17	42.3	6500	900	
EAMM-A-E48-87A	DGE-SP, DMES	17	42.3	6500	1500	
EAMM-A-E48-100A	DGE-SP, DMES	17	42.3	6500	1280	
EAMM-A-E72-60G	DGE-SP DMES	17	42.3	6500	3190	
EAMM-A-E72-60H	DGE-SP	17	42.3	6500	2590	
EAMM-A-E72-62B	DMES	17	35.5	6000	2800	
EAMM-A-E72-70A	DGE-SP, DMES	17	42.3	6500	2370	
EAMM-A-E72-80G	DGE-SP, DMES	17	42.3	6500	3190	
EAMM-A-E72-87A	DGE-SP, DMES	17	42.3	6500	3040	
EAMM-A-E72-100A	DGE-SP, DMES	17	42.3	6500	3240	
EAMM-A-F28-40G	DGEA	8.2	6.1	8000	280	70
EAMM-A-F28-57A	DGEA	7.5	6.1	8000	280	
EAMM-A-F28-60G	DGEA	8.2	6.1	8000	350	
EAMM-A-F28-60H	DGEA	8.2	6.1	8000	370	
EAMM-A-F28-87A	DGEA	8.2	6.1	8000	450	

Axial kits EAMM-A

Technical data

General technical data						
Type	For axis	Transferable torque [Nm]	Mass moment of inertia [kgmm ²]	Max. rotational speed [rpm]	Weight [g]	→ Page
EAMM-A-F30-40G	DGE-ZR	8.2	6.1	8000	280	37
EAMM-A-F30-55A	DGE-ZR	8.2	6.1	8000	270	
EAMM-A-F30-57A	DGE-ZR	7.5	6.1	8000	280	
EAMM-A-F30-60G	DGE-ZR	8.2	6.1	8000	410	
EAMM-A-F30-60H	DGE-ZR	8.2	6.1	8000	370	
EAMM-A-F30-70A	DGE-ZR	8.2	6.1	8000	330	
EAMM-A-F30-87A	DGE-ZR	8.2	6.1	8000	440	
EAMM-A-F32-60G	DGEA	17	42.3	6500	920	70
EAMM-A-F32-60H	DGEA	17	42.3	6500	810	
EAMM-A-F32-87A	DGEA	17	42.3	6500	770	
EAMM-A-F37-40G	DGE-ZR	8.2	6.1	8000	280	37
EAMM-A-F37-55A	DGE-ZR	8.2	6.1	8000	270	
EAMM-A-F37-57A	DGE-ZR	7.5	6.1	8000	270	
EAMM-A-F37-60G	DGE-ZR	8.2	6.1	8000	350	
EAMM-A-F37-60H	DGE-ZR	8.2	6.1	8000	370	
EAMM-A-F37-70A	DGE-ZR	8.2	6.1	8000	330	
EAMM-A-F37-87A	DGE-ZR	8.2	6.1	8000	480	
EAMM-A-F40-70A	DGE-ZR	17	42.3	6500	640	
EAMM-A-F40-80G	DGE-ZR, DGEA	17	42.3	6500	890	
EAMM-A-F40-87A	DGE-ZR	17	42.3	6500	790	
EAMM-A-F40-100A	DGE-ZR	17	42.3	6500	940	
EAMM-A-F47-80G	DGE-ZR	17	42.3	6500	1000	
EAMM-A-F47-87A	DGE-ZR	17	42.3	6500	780	
EAMM-A-F47-100A	DGE-ZR	17	42.3	6500	1010	
EAMM-A-F47-140A	DGE-ZR	17	42.3	6500	1930	
EAMM-A-F62-80G	DGE-ZR	85	417	4500	2760	
EAMM-A-F62-100A	DGE-ZR	85	417	4500	2540	
EAMM-A-F62-120G	DGE-ZR	92	417	4500	2480	
EAMM-A-F62-140A	DGE-ZR	92	417	4500	2780	
EAMM-A-F80-80G	DGE-ZR	85	417	4500	2810	
EAMM-A-F80-100A	DGE-ZR	85	417	4500	2560	
EAMM-A-F80-120G	DGE-ZR	92	417	4500	2730	
EAMM-A-F80-140A	DGE-ZR	92	417	4500	2640	
EAMM-A-F80-160G	DGE-ZR	92	417	4500	5240	
EAMM-A-G13-40A	DGE-ZR	1	0.13	12000	80	
EAMM-A-G13-42A	DGE-ZR	1	0.13	12000	90	
EAMM-A-G16-40A	DGE-ZR	1	0.13	12000	80	
EAMM-A-G16-42A	DGE-ZR	1	0.13	12000	120	
EAMM-A-G16-55A	DGE-ZR	1	0.13	12000	140	
EAMM-A-G19-40A	DGE-ZR	1.5	0.47	8000	160	
EAMM-A-G19-40G	DGE-ZR	1.5	0.47	8000	190	
EAMM-A-G19-55A	DGE-ZR	1.5	0.47	8000	190	
EAMM-A-G19-57A	DGE-ZR	1.5	0.47	8000	200	
EAMM-A-G19-67A	DGE-ZR	1.5	0.47	8000	290	

Axial kits EAMM-A

Technical data

General technical data						
Type	For axis	Transferable torque [Nm]	Mass moment of inertia [kgmm ²]	Max. rotational speed [rpm]	Weight [g]	→ Page
EAMM-A-L27-40G	EGC-TB	2	0.445	10000	180	52
EAMM-A-L27-55A	EGC-TB	2	0.445	10000	220	
EAMM-A-L27-57A	EGC-TB	1.6	0.355	10000	180	
EAMM-A-L27-67A	EGC-TB	2	0.445	10000	290	
EAMM-A-L38-55A	EGC-TB	4.4	0.445	8000	210	
EAMM-A-L38-57A	EGC-TB	3.6	3.2	8000	220	
EAMM-A-L38-60G	EGC-TB	4.4	3.2	8000	350	
EAMM-A-L38-60H	EGC-TB	4.4	3.3	8000	340	
EAMM-A-L38-60P	EGC-TB	4.4	3.3	8000	300	
EAMM-A-L38-70A	EGC-TB	4.4	3.2	8000	290	
EAMM-A-L38-87A	EGC-TB	4.4	3.2	8000	480	
EAMM-A-L48-60G	EGC-TB	12.5	14.5	8000	490	
EAMM-A-L48-60H	EGC-TB	12.5	14.5	8000	430	
EAMM-A-L48-70A	EGC-TB	12.5	14.5	8000	350	
EAMM-A-L48-80P	EGC-TB	17	39	6000	660	
EAMM-A-L48-87A	EGC-TB	12.5	14.5	8000	590	
EAMM-A-L48-100A	EGC-TB	17	39	6000	990	
EAMM-A-L62-80G	EGC-TB	47	147	5500	1620	
EAMM-A-L62-100A	EGC-TB	47	147	5500	1610	
EAMM-A-L62-140A	EGC-TB	47	147	5500	2420	
EAMM-A-L95-80G-G2	ELGA-TB	120	374	4500	2771	
EAMM-A-L95-120G-G2	ELGA-TB, EGC-TB	150	374	4500	2935	
EAMM-A-L95-140A-G2	ELGA-TB, EGC-TB	143	374	4500	3175	
EAMM-A-L95-190A-G2	ELGA-TB, EGC-TB	192	374	4500	4900	
EAMM-A-M43-60G	EGC-HD-TB	12.5	14.5	8000	340	
EAMM-A-M43-60H	EGC-HD-TB	12.5	14.5	8000	330	
EAMM-A-M48-60H	EGC-HD-TB	21	39	6000	320	
EAMM-A-M48-80G	EGC-HD-TB	21	39	6000	870	
EAMM-A-M80-120G	EGC-HD-TB	75	147	5500	1370	
EAMM-A-N38-60G	ELGA-TB	12.5	14.5	8000	470	
EAMM-A-N38-60H	ELGA-TB	12.5	14.5	8000	460	
EAMM-A-N38-70A	ELGA-TB	12.5	14.5	8000	430	
EAMM-A-N38-87A	ELGA-TB	12.5	14.5	8000	646	
EAMM-A-N48-60G	ELGA-TB	12.5	14.5	8000	509	
EAMM-A-N48-60H	ELGA-TB	12.5	14.5	8000	470	
EAMM-A-N48-80G	ELGA-TB	21	39	6000	1080	
EAMM-A-N48-100A	ELGA-TB	17	39	6000	1070	
EAMM-A-N80-80G	ELGA-TB	47	147	5500	1290	
EAMM-A-N80-120G	ELGA-TB	47	147	5500	1990	
EAMM-A-N80-140A	ELGA-TB	47	147	5500	2070	

Axial kits EAMM-A

Technical data

General technical data						
Type	For axis	Transferable torque [Nm]	Mass moment of inertia [kgmm ²]	Max. rotational speed [rpm]	Weight [g]	→ Page
EAMM-A-S38-40A	EGC-BS, EGC-HD-BS, ELGA-BS	6.5	5.87	8000	370	54, 62
EAMM-A-S38-40A-G2	EGC-BS, EGC-HD-BS, ELGA-BS	6.5	5.87	8000	270	
EAMM-A-S38-40G-G2	EGC-BS, EGC-HD-BS, ELGA-BS	6.5	5.87	8000	410	
EAMM-A-S38-40P	EGC-BS, EGC-HD-BS, ELGA-BS	6.5	5.87	8000	380	
EAMM-A-S38-40P-G2	EGC-BS, EGC-HD-BS, ELGA-BS	6.5	5.87	8000	280	
EAMM-A-S38-42A	EGC-BS, EGC-HD-BS, ELGA-BS	3.5	5.87	8000	410	
EAMM-A-S38-42A-G2	EGC-BS, EGC-HD-BS, ELGA-BS	3.5	5.87	8000	310	
EAMM-A-S38-55A	EGC-BS, EGC-HD-BS, ELGA-BS	6.5	5.87	8000	400	
EAMM-A-S38-55A-G2	EGC-BS, EGC-HD-BS, ELGA-BS	6.5	5.87	8000	340	
EAMM-A-S38-57A	EGC-BS, EGC-HD-BS, ELGA-BS	6.5	5.87	8000	400	
EAMM-A-S38-57A-G2	EGC-BS, EGC-HD-BS, ELGA-BS	6.5	5.87	8000	340	
EAMM-A-S38-60P	EGC-BS, EGC-HD-BS, ELGA-BS	6.5	5.87	8000	530	
EAMM-A-S38-60P-G2	EGC-BS, EGC-HD-BS, ELGA-BS	6.5	5.87	8000	420	
EAMM-A-S38-67A-G2	EGC-BS, EGC-HD-BS, ELGA-BS	6.5	5.87	8000	492	
EAMM-A-S48-40G-G2	EGC-BS, EGC-HD-BS, ELGA-BS	12.5	5.87	8000	420	
EAMM-A-S48-55A	EGC-BS, EGC-HD-BS, ELGA-BS	12.5	5.87	8000	590	
EAMM-A-S48-55A-G2	EGC-BS, EGC-HD-BS, ELGA-BS	12.5	5.87	8000	370	
EAMM-A-S48-57A	EGC-BS, EGC-HD-BS, ELGA-BS	6.5	5.87	8000	580	
EAMM-A-S48-57A-G2	EGC-BS, EGC-HD-BS, ELGA-BS	6.5	5.87	8000	570	
EAMM-A-S48-60G-G2	EGC-BS, EGC-HD-BS, ELGA-BS	12.5	5.87	8000	440	
EAMM-A-S48-60H-G2	EGC-BS, EGC-HD-BS, ELGA-BS	12.5	5.87	8000	430	
EAMM-A-S48-60P	EGC-BS, EGC-HD-BS, ELGA-BS	12.5	5.87	8000	580	
EAMM-A-S48-60P-G2	EGC-BS, EGC-HD-BS, ELGA-BS	12.5	5.87	8000	440	
EAMM-A-S48-70A	EGC-BS, EGC-HD-BS, ELGA-BS	12.5	5.87	8000	610	
EAMM-A-S48-70A-G2	EGC-BS, EGC-HD-BS, ELGA-BS	12.5	5.87	8000	450	
EAMM-A-S48-87A	EGC-BS, EGC-HD-BS, ELGA-BS	12.5	5.87	8000	760	
EAMM-A-S48-87A-G2	EGC-BS, EGC-HD-BS, ELGA-BS	12.5	5.87	8000	590	
EAMM-A-S62-60G-G2	EGC-BS, EGC-HD-BS, ELGA-BS	17	42.3	6500	1110	
EAMM-A-S62-60H-G2	EGC-BS, EGC-HD-BS, ELGA-BS	17	42.3	6500	1100	
EAMM-A-S62-70A	EGC-BS, EGC-HD-BS, ELGA-BS	17	45.5	6000	1950	
EAMM-A-S62-70A-G2	EGC-BS, EGC-HD-BS, ELGA-BS	17	45.5	6000	1040	
EAMM-A-S62-80G-G2	EGC-BS, EGC-HD-BS, ELGA-BS	17	34.8	6000	1180	
EAMM-A-S62-80P	EGC-BS, EGC-HD-BS, ELGA-BS	17	34.8	6000	1890	
EAMM-A-S62-80P-G2	EGC-BS, EGC-HD-BS, ELGA-BS	17	34.8	6000	970	
EAMM-A-S62-87A	EGC-BS, EGC-HD-BS, ELGA-BS	17	45.5	6000	2070	
EAMM-A-S62-87A-G2	EGC-BS, EGC-HD-BS, ELGA-BS	17	45.5	6000	1150	
EAMM-A-S62-100A	EGC-BS, EGC-HD-BS, ELGA-BS	17	34.8	6000	2050	
EAMM-A-S62-100A-G2	EGC-BS, EGC-HD-BS, ELGA-BS	17	34.8	6000	1240	
EAMM-A-S62-140A	EGC-BS, EGC-HD-BS, ELGA-BS	17	34.8	6000	2870	
EAMM-A-S62-140A-G2	EGC-BS, EGC-HD-BS, ELGA-BS	17	34.8	6000	2060	
EAMM-A-S95-100A	EGC-BS, EGC-HD-BS, ELGA-BS	60	128	5500	4910	
EAMM-A-S95-100A-G2	EGC-BS, EGC-HD-BS, ELGA-BS	60	128	5500	1240	
EAMM-A-S95-140A	EGC-BS, EGC-HD-BS, ELGA-BS	60	128	5500	5500	
EAMM-A-S95-140A-G2	EGC-BS, EGC-HD-BS, ELGA-BS	60	128	5500	3650	

Axial kits EAMM-A

Technical data

General technical data						
Type	For axis	Transferable torque [Nm]	Mass moment of inertia [kgmm ²]	Max. rotational speed [rpm]	Weight [g]	→ Page
EAMM-A-P3-28D-28A	EGSK	0.2	0.28	10000	30	65
EAMM-A-P3-28D-40P	EGSK	0.2	0.28	10000	60	
EAMM-A-P4-28B-28A	EGSK, EGSP	0.7	0.28	10000	40	
EAMM-A-P4-28B-40A	EGSK, EGSP	0.7	0.28	10000	50	
EAMM-A-P4-28B-40P	EGSK, EGSP	0.7	0.28	10000	50	
EAMM-A-P4-28B-42A	EGSK, EGSP	0.7	0.28	10000	60	
EAMM-A-P5-28B-28A	EGSK, EGSP	1.1	0.28	10000	40	
EAMM-A-P5-28B-40A	EGSK, EGSP	1.1	0.28	10000	50	
EAMM-A-P5-28B-40P	EGSK, EGSP	1.1	0.28	10000	50	
EAMM-A-P5-28B-42A	EGSK, EGSP	1.1	0.28	10000	60	
EAMM-A-P6-38A-40A	EGSK, EGSP	6.5	5.87	8000	100	
EAMM-A-P6-38A-40G	EGSK	6.5	5.87	8000	190	
EAMM-A-P6-38A-40P	EGSK	6.5	5.87	8000	110	
EAMM-A-P6-38A-42A	EGSK, EGSP	3.5	5.87	8000	160	
EAMM-A-P6-38A-55A	EGSK, EGSP	6.5	5.87	8000	130	
EAMM-A-P6-38A-57A	EGSK, EGSP	6.5	5.87	8000	130	
EAMM-A-P6-38A-60P	EGSK	6.5	5.87	8000	210	
EAMM-A-P6-38A-67A	EGSK	6.5	5.87	8000	230	
EAMM-A-P8-38A-40A	EGSK, EGSP	6.5	5.87	8000	100	
EAMM-A-P8-38A-40G	EGSK, EGSP	12.5	5.87	8000	190	
EAMM-A-P8-38A-40P	EGSK, EGSP	12.5	5.87	8000	110	
EAMM-A-P8-38A-42A	EGSK, EGSP	3.5	5.87	8000	160	
EAMM-A-P8-38A-55A	EGSK, EGSP	12.5	5.87	8000	130	
EAMM-A-P8-38A-57A	EGSK, EGSP	6.5	5.87	8000	130	
EAMM-A-P8-38A-60P	EGSK, EGSK	12.5	5.87	8000	210	
EAMM-A-P8-38A-67A	EGSK, EGSK	12.5	5.87	8000	230	
EAMM-A-P8-38A-70A	EGSK, EGSP	12.5	5.87	8000	200	
EAMM-A-P8-38A-87A	EGSK, EGSP	12.5	5.87	8000	380	
EAMM-A-P10-38A-40G	EGSP	12.5	5.87	8000	190	
EAMM-A-P10-38A-55A	EGSP	12.5	5.87	8000	130	
EAMM-A-P10-38A-57A	EGSP	6.5	5.87	8000	130	
EAMM-A-P10-38A-60P	EGSP	12.5	5.87	8000	210	
EAMM-A-P10-38A-67A	EGSP	12.5	5.87	8000	230	
EAMM-A-P10-38A-70A	EGSP	12.5	5.87	8000	200	
EAMM-A-P10-38A-87A	EGSP	12.5	5.87	8000	380	
EAMM-A-R27-40G	ELGG, ELGR	2	0.445	10000	240	68
EAMM-A-R27-55A	ELGG, ELGR	2	0.445	10000	170	
EAMM-A-R27-57A	ELGG, ELGR	1.6	0.355	10000	170	
EAMM-A-R27-67A	ELGG, ELGR	2	0.445	10000	280	
EAMM-A-R38-40G	ELGG, ELGR	9	3.2	8000	330	
EAMM-A-R38-57A	ELGG, ELGR	3.6	3.2	8000	280	
EAMM-A-R38-60P	ELGG, ELGR	4.4	3.3	8000	350	
EAMM-A-R38-60G	ELGG, ELGR	4.4	3.2	8000	390	
EAMM-A-R38-60H	ELGG, ELGR	4.4	3.3	8000	480	
EAMM-A-R38-70A	ELGG, ELGR	4.4	3.2	8000	350	
EAMM-A-R38-87A	ELGG, ELGR	4.4	3.2	8000	530	
EAMM-A-R48-60G	ELGG, ELGR	12.5	14.5	8000	480	
EAMM-A-R48-60H	ELGG, ELGR	12.5	14.5	8000	480	
EAMM-A-R48-70A	ELGG, ELGR	12.5	14.5	8000	450	
EAMM-A-R48-80P	ELGG, ELGR	17	39	6000	710	
EAMM-A-R48-87A	ELGG, ELGR	12.5	14.5	8000	590	
EAMM-A-R48-100A	ELGG, ELGR	17	39	6000	970	

Axial kits EAMM-A

Technical data

Operating and environmental conditions		
Ambient temperature	[°C]	-10 ... +60
Storage temperature	[°C]	-25 ... +60
Degree of protection ¹⁾		
EAMM-A-...		IP40
EAMM-A-...-S1		IP65
Relative air humidity	[%]	0 ... 95
Corrosion resistance class CRC ²⁾		1
Note on materials		RoHS-compliant

1) Only in combination with attached motor and axis.

2) Corrosion resistance class CRC 1 to Festo standard FN 940070

Low corrosion stress. For dry indoor applications or transport and storage protection. Also applies to parts behind covers, in the non-visible interior area, and parts which are covered in the application (e.g. drive trunnions).

Axial kits EAMM-A

Technical data

Dimensions and ordering data

Download CAD data → www.festo.com

DGE-ZR...

EAMM-A-G...

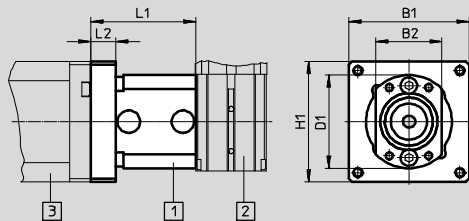

EAMM-A-F...

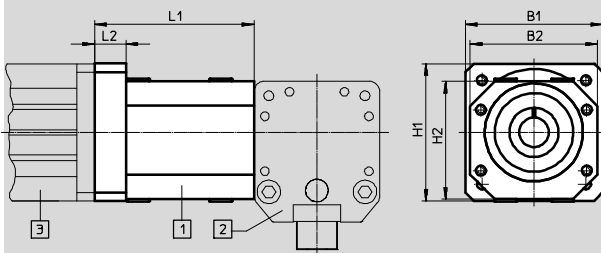

Illustration:

- 1 Axial kit
- 2 Toothed belt axis
- 3 Motor

Type	B1	B2	H1	H2	L1	L2
EAMM-A-F30-40G	50	45	50	45	57.7	17.7
EAMM-A-F30-55A	55	45	55	45	51.4	10.5
EAMM-A-F30-57A	56.4	45	56.4	45	52.7	12
EAMM-A-F30-60G	60	45	60	45	60.7	23
EAMM-A-F30-60H	60	45	60	45	60.7	20
EAMM-A-F30-70A	70	45	70	45	54.2	13.5
EAMM-A-F30-87A	85.8	45	85.8	45	56.2	15.5
EAMM-A-F37-40G	50	45	50	45	57.7	17.7
EAMM-A-F37-55A	55	45	55	45	51.4	15
EAMM-A-F37-57A	56.4	45	56.4	45	52.7	10
EAMM-A-F37-60G	60	45	60	45	60.7	11.5
EAMM-A-F37-60H	60	45	60	45	60.7	20
EAMM-A-F37-70A	70	45	70	45	54.2	14.5
EAMM-A-F37-87A	85.8	45	85.8	45	56.2	19
EAMM-A-F40-70A	70	65	70	60	81.2	16
EAMM-A-F40-80G	90	65	90	60	89.4	24
EAMM-A-F40-87A	85.8	65	85.8	60	82.7	17.5
EAMM-A-F40-100A	100	65	100	60	86.2	21
EAMM-A-F47-80G	90	65	90	60	89.4	8.3
EAMM-A-F47-87A	85.8	65	85.8	60	82.7	12.5
EAMM-A-F47-100A	100	65	100	60	86.2	5
EAMM-A-F47-140A	138	65	138	60	95.2	10.5

Axial kits EAMM-A

Technical data

Dimensions and ordering data Download CAD data → www.festo.com

DGE-ZR-...

EAMM-A-G-...

EAMM-A-F-...

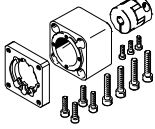

Illustration:
 1 Axial kit
 2 Toothed belt axis
 3 Motor

Type	B1	B2	D1	H1	H2	L1	L2
EAMM-A-F62-80G	115	100	-	115	100	119.2	28
EAMM-A-F62-100A	100	100	-	105	100	116.2	25
EAMM-A-F62-120G	115	100	-	115	100	119.2	28
EAMM-A-F62-140A	138	100	-	138	100	111.2	20
EAMM-A-F80-80G	115	100	-	115	100	119.2	12
EAMM-A-F80-100A	100	100	-	105	100	116.2	21
EAMM-A-F80-120G	115	100	-	115	100	119.2	10.5
EAMM-A-F80-140A	138	100	-	138	100	111.2	12
EAMM-A-F80-160G	160	100	-	160	100	151.2	21
EAMM-A-G13-40A	40	22	29	40	-	33.9	8.3
EAMM-A-G13-42A	42	22	29	42	-	42.2	16.5
EAMM-A-G16-40A	40	22	31	40	-	34.9	8.3
EAMM-A-G16-42A	42	22	31	42	-	42.4	18
EAMM-A-G16-55A	55	22	31	55	-	37.7	11
EAMM-A-G19-40A	48	31	44.5	48	-	38.5	9.5
EAMM-A-G19-40G	50	31	44.5	50	-	46	17
EAMM-A-G19-55A	55	31	44.5	55	-	39.7	10.5
EAMM-A-G19-57A	56.4	31	44.5	56.4	-	41	12
EAMM-A-G19-67A	67	31	44.5	67	-	45.1	16

Axial kits EAMM-A

Technical data

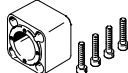

FESTO

Component parts – ordering data			
Axial kit	Comprising:		
	Motor flange	Coupling	Coupling housing
			
Part No. Type	Part No. Type	Part No. Type	Part No. Type
1454254 EAMM-A-F30-40G	550986 EAMF-A-44A/B-40G	123050 EAMC-30-35-8-10	124628 EAMK-A-F30-44A
550929 EAMM-A-F30-55A	529942 EAMF-A-44A/B-55A	557390 EAMC-30-35-8-9	124628 EAMK-A-F30-44A
550930 EAMM-A-F30-57A	530081 EAMF-A-44A/B-57A	530088 EAMC-30-35-6.35-8	124628 EAMK-A-F30-44A
550931 EAMM-A-F30-60G	529944 EAMF-A-44A/B-60G	123042 EAMC-30-35-8-11	124628 EAMK-A-F30-44A
1454255 EAMM-A-F30-60H	1780430 EAMF-A-44A-60G/H	1453063 EAMC-30-35-8-14	124628 EAMK-A-F30-44A
550932 EAMM-A-F30-70A	529943 EAMF-A-44A/B-70A	123042 EAMC-30-35-8-11	124628 EAMK-A-F30-44A
550933 EAMM-A-F30-87A	530082 EAMF-A-44A/B-87A	123042 EAMC-30-35-8-11	124628 EAMK-A-F30-44A
1454257 EAMM-A-F37-40G	550986 EAMF-A-44A/B-40G	123050 EAMC-30-35-8-10	534394 EAMK-A-F37-44A/C
550942 EAMM-A-F37-55A	529942 EAMF-A-44A/B-55A	557390 EAMC-30-35-8-9	534394 EAMK-A-F37-44A/C
550943 EAMM-A-F37-57A	530081 EAMF-A-44A/B-57A	530088 EAMC-30-35-6.35-8	534394 EAMK-A-F37-44A/C
550944 EAMM-A-F37-60G	529944 EAMF-A-44A/B-60G	123042 EAMC-30-35-8-11	534394 EAMK-A-F37-44A/C
1454258 EAMM-A-F37-60H	1780430 EAMF-A-44A-60G/H	1453063 EAMC-30-35-8-14	534394 EAMK-A-F37-44A/C
550945 EAMM-A-F37-70A	529943 EAMF-A-44A/B-70A	123042 EAMC-30-35-8-11	534394 EAMK-A-F37-44A/C
550946 EAMM-A-F37-87A	530082 EAMF-A-44A/B-87A	123042 EAMC-30-35-8-11	534394 EAMK-A-F37-44A/C
550934 EAMM-A-F40-70A	529945 EAMF-A-64A/B-70A	550998 EAMC-40-66-11-15	124629 EAMK-A-F40-64A
550935 EAMM-A-F40-80G	533139 EAMF-A-64A/C-80G	123845 EAMC-40-66-15-20	124629 EAMK-A-F40-64A
550936 EAMM-A-F40-87A	533140 EAMF-A-64A/B-87A	550998 EAMC-40-66-11-15	124629 EAMK-A-F40-64A
550937 EAMM-A-F40-100A	529947 EAMF-A-64A/C/D-100A	123844 EAMC-40-66-15-19	124629 EAMK-A-F40-64A
550947 EAMM-A-F47-80G	533139 EAMF-A-64A/C-80G	123845 EAMC-40-66-15-20	534395 EAMK-A-F47-64A
550948 EAMM-A-F47-87A	533140 EAMF-A-64A/B-87A	550998 EAMC-40-66-11-15	534395 EAMK-A-F47-64A
550949 EAMM-A-F47-100A	529947 EAMF-A-64A/C/D-100A	123844 EAMC-40-66-15-19	534395 EAMK-A-F47-64A
550950 EAMM-A-F47-140A	550988 EAMF-A-64A-140A	176033 EAMC-40-66-15-24	534395 EAMK-A-F47-64A

Axial kits EAMM-A

Technical data

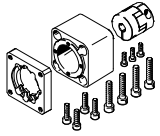
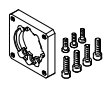
FESTO

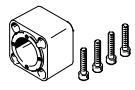
Component parts			
Axial kit	Comprising:		
	Motor flange	Coupling	Coupling housing
			
Part No. Type	Part No. Type	Part No. Type	Part No. Type
550938 EAMM-A-F62-80G	550989 EAMF-A-118A-80G	176035 EAMC-65-90-20-25	124630 EAMK-A-F62-118A/B/C
550939 EAMM-A-F62-100A	529949 EAMF-A-118C-100A	551000 EAMC-65-90-19-25	124630 EAMK-A-F62-118A/B/C
550940 EAMM-A-F62-120G	550990 EAMF-A-118A-120G	123853 EAMC-65-90-25-25	124630 EAMK-A-F62-118A/B/C
550941 EAMM-A-F62-140A	550991 EAMF-A-118B-140A	123852 EAMC-65-90-24-25	124630 EAMK-A-F62-118A/B/C
550951 EAMM-A-F80-80G	550989 EAMF-A-118A-80G	176035 EAMC-65-90-20-25	534396 EAMK-A-F80-118A/B/C
550952 EAMM-A-F80-100A	529949 EAMF-A-118C-100A	551000 EAMC-65-90-19-25	534396 EAMK-A-F80-118A/B/C
550953 EAMM-A-F80-120G	550990 EAMF-A-118A-120G	123853 EAMC-65-90-25-25	534396 EAMK-A-F80-118A/B/C
550954 EAMM-A-F80-140A	550991 EAMF-A-118B-140A	123852 EAMC-65-90-24-25	534396 EAMK-A-F80-118A/B/C
550955 EAMM-A-F80-160G	550992 EAMF-A-118A-160G	551001 EAMC-65-90-25-40	534396 EAMK-A-F80-118A/B/C
550921 EAMM-A-G13-40A	540301 EAMF-A-28A/30A-40A	540750 EAMC-B-15-22-4-6	171186 EAMK-A-G13-28A
550922 EAMM-A-G13-42A	530080 EAMF-A-28A-42A	530084 EAMC-B-15-22-4-5	171186 EAMK-A-G13-28A
550923 EAMM-A-G16-40A	540301 EAMF-A-28A/30A-40A	540750 EAMC-B-15-22-4-6	171185 EAMK-A-G16-30A
550924 EAMM-A-G16-42A	530079 EAMF-A-30A-42A	530084 EAMC-B-15-22-4-5	171185 EAMK-A-G16-30A
550925 EAMM-A-G16-55A	534807 EAMF-A-30A-55A	184262 EAMC-B-15-22-4-9	171185 EAMK-A-G16-30A
550926 EAMM-A-G19-40A	550985 EAMF-A-44A/B-40A	184265 EAMC-B-19-24-6-6	170375 EAMK-A-G19-44B
1454259 EAMM-A-G19-40G	550986 EAMF-A-44A/B-40G	1450210 EAMC-B-19-24-6-10	170375 EAMK-A-G19-44B
550927 EAMM-A-G19-55A	529942 EAMF-A-44A/B-55A	184263 EAMC-B-19-24-6-9	170375 EAMK-A-G19-44B
550928 EAMM-A-G19-57A	530081 EAMF-A-44A/B-57A	530086 EAMC-B-19-24-6-6.35	170375 EAMK-A-G19-44B
1454260 EAMM-A-G19-67A	1476305 EAMF-A-44A/B/C-67A-S1	184263 EAMC-B-19-24-6-9	170375 EAMK-A-G19-44B

Axial kits EAMM-A

Technical data

Dimensions and ordering data

Download CAD data → www.festo.com

DGE-SP-...

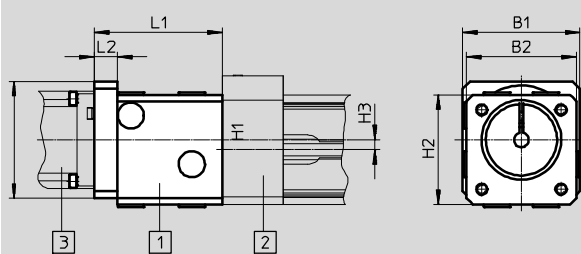

Illustration:

- 1 Axial kit
- 2 Spindle axis
- 3 Motor

DMES-...

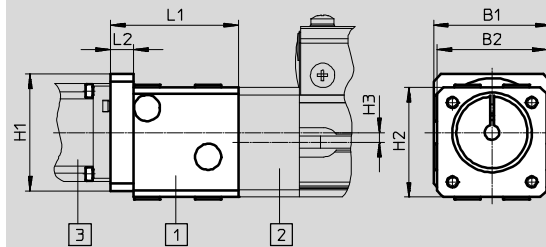

Illustration:

- 1 Axial kit
- 2 Positioning axis
- 3 Motor

Type	B1	B2	H1	H2	H3	L1	L2
EAMM-A-E20-32B	–	33.6	–	41	–	27 ^{-0.2}	7
EAMM-A-E20-40A	40	33.5	40	31.5	–	27.5	8.3
EAMM-A-E20-42A	42	33.5	42	31.5	–	35.7	5
EAMM-A-E20-55A	55	33.5	55	31.5	–	29.5	10.5
EAMM-A-E32-40A	48	45	48	45	4	52.5	9.5
EAMM-A-E32-40G	50	45	50	45	4	60	17
EAMM-A-E32-42B	–	44.8	–	54.4	4	88	23
EAMM-A-E32-42C	–	44.8	–	54.4	4	101	36
EAMM-A-E32-55A	55	45	55	45	4	53.7	10.5
EAMM-A-E32-57A	56.4	45	56.4	45	4	55	12
EAMM-A-E32-67A	67	45	67	45	4	59.1	16
EAMM-A-E48-40G	50	64 ^{-0.3}	50	64 ^{-0.3}	5	63.5	17
EAMM-A-E48-44A-70A	70	64 ^{-0.3}	70	64 ^{-0.3}	5	60	13.5
EAMM-A-E48-52B	–	63.8	–	76.4	5	121	25
EAMM-A-E48-52C	–	63.8	–	76.4	5	135	39
EAMM-A-E48-55A	55	64 ^{-0.3}	55	64 ^{-0.3}	5	57.2	10.5
EAMM-A-E48-57A	56.4	64 ^{-0.3}	56.4	64 ^{-0.3}	5	58.5	12
EAMM-A-E48-60H	70	65 ^{-0.3}	70	64 ^{-0.3}	5	94.4	24
EAMM-A-E48-64A-70A	70	65 ^{-0.3}	70	64 ^{-0.3}	5	86.2	16
EAMM-A-E48-67A	75	65 ^{-0.3}	75	64 ^{-0.3}	5	88.6	18
EAMM-A-E48-87A	85.8	65 ^{-0.3}	85.8	64 ^{-0.3}	5	87.7	17.5
EAMM-A-E48-100A	100	65 ^{-0.3}	100	64 ^{-0.3}	5	91.2	21
EAMM-A-E72-60G	70	105.6	70	114.8	8	106.9	24.4
EAMM-A-E72-60H	70	105.6	70	114.8	8	106.9	24.4
EAMM-A-E72-62B	–	105.1	–	127.3	8	150	34
EAMM-A-E72-70A	70	105.6	70	114.8	8	98.7	16
EAMM-A-E72-80G	90	105.6	90	114.8	8	106.9	24
EAMM-A-E72-87A	85.8	105.6	85.8	114.8	8	100.2	17.5
EAMM-A-E72-100A	100	105.6	100	114.8	8	103.7	21

Axial kits EAMM-A

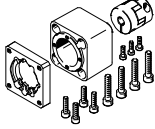
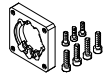
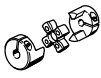
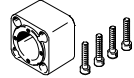

Technical data

FESTO

Component parts			
Axial kit	Comprising:		
	Motor flange	Coupling	Coupling housing
			
Part No. Type	Part No. Type	Part No. Type	Part No. Type
556991 EAMM-A-E20-32B	–	533707 EAMC-15-20-5-6	533703 EAMK-A-E20-32B
550961 EAMM-A-E20-40A	552163 EAMF-A-28B-40A	540751 EAMC-B-15-22-5-6	170374 EAMK-A-E20-28B
550962 EAMM-A-E20-42A	552164 EAMF-A-28B-42A	530085 EAMC-B-15-22-5-5	170374 EAMK-A-E20-28B
550963 EAMM-A-E20-55A	529946 EAMF-A-28A/B-55A	529953 EAMC-B-15-22-5-9	170374 EAMK-A-E20-28B
550964 EAMM-A-E32-40A	550985 EAMF-A-44A/B-40A	123040 EAMC-30-35-6-6	124631 EAMK-A-E32-44A
1454247 EAMM-A-E32-40G	550986 EAMF-A-44A/B-40G	1453062 EAMC-30-35-6-10	124631 EAMK-A-E32-44A
556992 EAMM-A-E32-42B	–	533708 EAMC-30-32-6-8	533704 EAMK-A-E32-42B
556993 EAMM-A-E32-42C	–	533708 EAMC-30-32-6-8	538578 EAMK-A-E32-42C
550965 EAMM-A-E32-55A	529942 EAMF-A-44A/B-55A	530941 EAMC-30-35-6-9	124631 EAMK-A-E32-44A
550966 EAMM-A-E32-57A	530081 EAMF-A-44A/B-57A	530087 EAMC-30-35-6-6.35	124631 EAMK-A-E32-44A
1454246 EAMM-A-E32-67A	1476305 EAMF-A-44A/B/C-67A-S1	530941 EAMC-30-35-6-9	124631 EAMK-A-E32-44A
550968 EAMM-A-E48-40G	550986 EAMF-A-44A/B-40G	552640 EAMC-30-35-10-12	124632 EAMK-A-E48-44A
550971 EAMM-A-E48-44A-70A	529943 EAMF-A-44A/B-70A	123051 EAMC-30-35-11-12	124632 EAMK-A-E48-44A
556994 EAMM-A-E48-52B	–	533709 EAMC-42-50-12-12	533705 EAMK-A-E48-52B
556995 EAMM-A-E48-52C	–	533709 EAMC-42-50-12-12	538579 EAMK-A-E48-52C
550969 EAMM-A-E48-55A	529942 EAMF-A-44A/B-55A	550996 EAMC-30-35-9-12	124632 EAMK-A-E48-44A
550970 EAMM-A-E48-57A	530081 EAMF-A-44A/B-57A	550995 EAMC-30-35-6.35-12	124632 EAMK-A-E48-44A
1454249 EAMM-A-E48-60H	550987 EAMF-A-64A/B-60G/H	1452803 EAMC-40-66-12-14	529940 EAMK-A-E48-64A
557448 EAMM-A-E48-64A-70A	529945 EAMF-A-64A/B-70A	525864 EAMC-40-66-11-12	529940 EAMK-A-E48-64A
1454248 EAMM-A-E48-67A	1460114 EAMF-A-64A/B-67A	1731999 EAMC-40-66-9-12	529940 EAMK-A-E48-64A
550972 EAMM-A-E48-87A	533140 EAMF-A-64A/B-87A	525864 EAMC-40-66-11-12	529940 EAMK-A-E48-64A
550973 EAMM-A-E48-100A	529947 EAMF-A-64A/C/D-100A	529952 EAMC-40-66-12-19	529940 EAMK-A-E48-64A

Axial kits EAMM-A

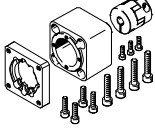
Technical data

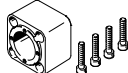
Component parts			
Axial kit	Comprising:		
	Motor flange	Coupling	Coupling housing
			
Part No. Type	Part No. Type	Part No. Type	Part No. Type
550974 EAMM-A-E72-60G	550987 EAMF-A-64A/B-60G/H	550999 EAMC-40-66-11-20	529941 EAMK-A-E72-64A
1454250 EAMM-A-E72-60H	550987 EAMF-A-64A/B-60G/H	1452809 EAMC-40-66-14-20	529941 EAMK-A-E72-64A
556996 EAMM-A-E72-62B	–	533710 EAMC-42-50-14-20	533706 EAMK-A-E72-62B
550975 EAMM-A-E72-70A	529945 EAMF-A-64A/B-70A	550999 EAMC-40-66-11-20	529941 EAMK-A-E72-64A
550976 EAMM-A-E72-80G	533139 EAMF-A-64A/C-80G	123849 EAMC-40-66-20-20	529941 EAMK-A-E72-64A
550977 EAMM-A-E72-87A	533140 EAMF-A-64A/B-87A	550999 EAMC-40-66-11-20	529941 EAMK-A-E72-64A
550978 EAMM-A-E72-100A	529947 EAMF-A-64A/C/D-100A	123847 EAMC-40-66-19-20	529941 EAMK-A-E72-64A

Axial kits EAMM-A

Technical data

FESTO

Dimensions and ordering data

Download CAD data → www.festo.com

EGSL-...

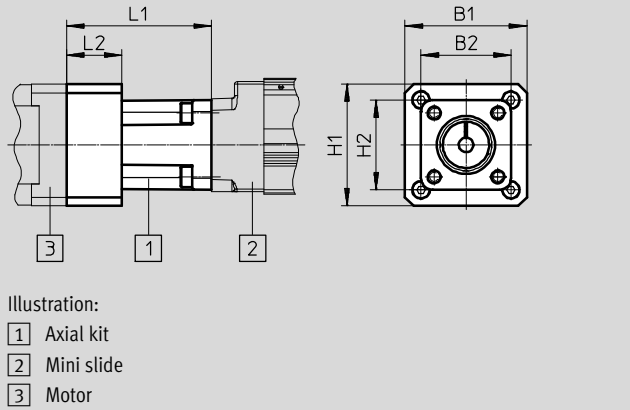

ESBF-... with degree of protection IP40

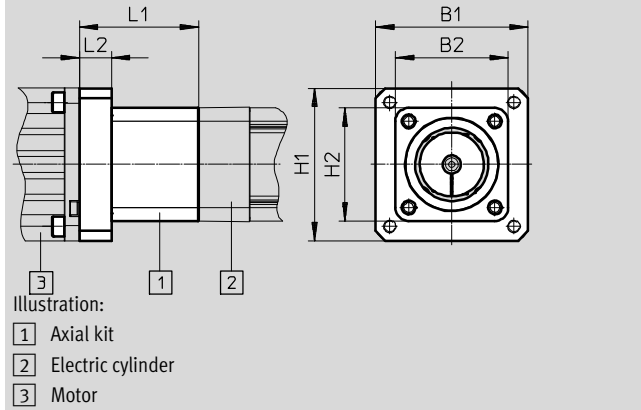

ERMB-...

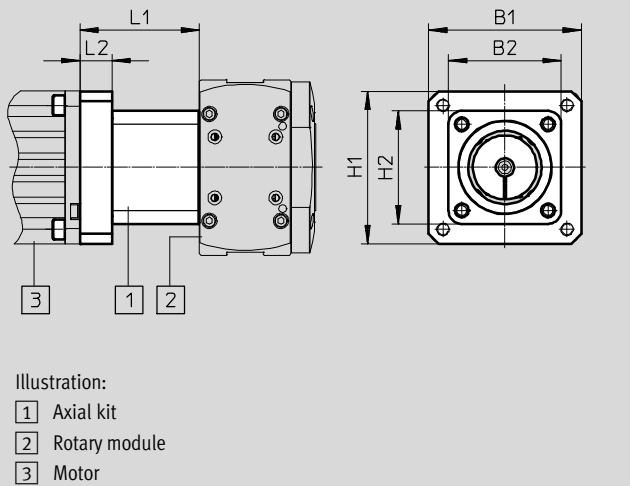

EHMB-...

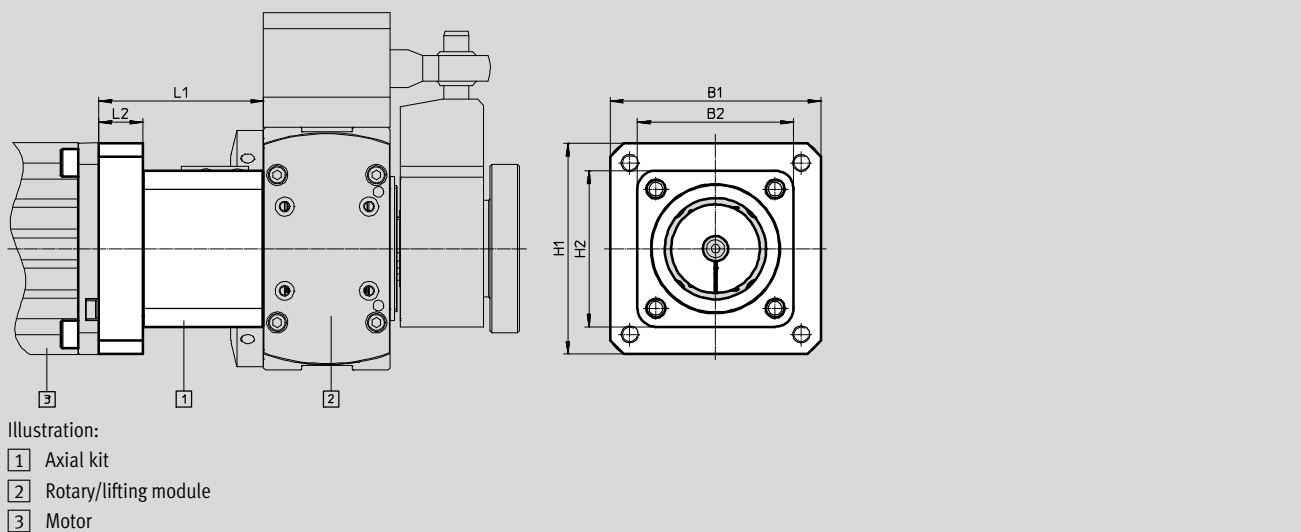

Axial kits EAMM-A



Technical data

Type	B1	B2	H1	H2	L1	L2
EAMM-A-D19-28A	30	31	30	31	46.2	15
EAMM-A-D19-40A	40	31	40	31	42.7	11.5
EAMM-A-D19-40P	39.7	31	39.7	31	45.7	14.5
EAMM-A-D19-42A	42	31	42	31	50	19
EAMM-A-D32-32B	33.6	45	41	45	43	–
EAMM-A-D32-35A-40A	–	40	–	40	46	–
EAMM-A-D32-35A-40P	–	39.7	–	39.7	49.5	–
EAMM-A-D32-40A	40	45	40	45	39.8	8.3
EAMM-A-D32-40G	60	45	60	45	62.5	24
EAMM-A-D32-40P	39.7	45	39.7	45	44	12.5
EAMM-A-D32-42A	42	45	42	45	48	5
EAMM-A-D32-55A	55	45	55	45	49.2	10.5
EAMM-A-D32-57A	56.4	45	56.4	45	50.5	12
EAMM-A-D32-60G	75	45	75	45	66.5	28
EAMM-A-D32-60H	75	45	75	45	66.5	28
EAMM-A-D32-60P	61.4	45	61.4	45	59.7	21
EAMM-A-D32-67A	67	45	67	45	54.6	16
EAMM-A-D40-40G	50	53.5	50	53.5	55.5	17
EAMM-A-D40-40G-G2	60	53.5	60	53.5	62.5	24
EAMM-A-D40-42B	44.8	53.5	54.4	53.5	88	9
EAMM-A-D40-42C	44.8	53.5	54.4	53.5	101	9
EAMM-A-D40-55A	55	53.5	55	53.5	49.2	10.5
EAMM-A-D40-57A	56.4	53.5	56.4	53.5	50.5	12
EAMM-A-D40-60G	75	53.5	75	53.5	66.5	28
EAMM-A-D40-60H	75	53.5	75	53.5	66.5	28
EAMM-A-D40-60P	61.4	53.5	61.4	53.5	59.7	21
EAMM-A-D40-67A	67	53.5	67	53.5	54.6	16
EAMM-A-D40-70A	70	53.5	70	53.5	52	13.5
EAMM-A-D40-87A	85.8	53.5	85.8	53.5	54	15.5
EAMM-A-D50-60G	90	74	90	74	87.7	35
EAMM-A-D50-60H	90	74	90	74	87.7	35
EAMM-A-D50-70A	70	74	70	74	68.2	16.2
EAMM-A-D50-80G	101	74	101	74	92.4	30
EAMM-A-D50-80P	81.3	74	81.3	74	79.7	17.5
EAMM-A-D50-87A	85.8	74	85.8	74	69.7	17.5
EAMM-A-D50-100A	100	74	100	74	84.2	21.5
EAMM-A-D60-52B	63.8	74	76.4	74	112	13
EAMM-A-D60-52C	63.8	74	76.4	74	126	13
EAMM-A-D60-60G	70	74	70	74	71.4	24
EAMM-A-D60-60G-G2	90	74	90	74	82.4	35
EAMM-A-D60-60H	90	74	90	74	82.4	35
EAMM-A-D60-70A	70	74	70	74	63.2	16
EAMM-A-D60-80G	101	74	101	74	87.4	30
EAMM-A-D60-80P	81.3	74	81.3	74	74.7	17.5
EAMM-A-D60-87A	85.8	74	85.8	74	64.7	17.5
EAMM-A-D60-100A	100	74	100	74	78.2	21
EAMM-A-D80-80G	101	97.2	101	97.2	102	30
EAMM-A-D80-100A	100	97.2	100	97.2	92	20
EAMM-A-D80-140A	140.5	97.2	140.5	97.2	102	30
EAMM-A-D100-100A	109	100	109	100	99.5	20
EAMM-A-D100-120G	109	143	109	143	111.5	32
EAMM-A-D100-140A	140.5	109	140.5	109	109.5	30

Axial kits EAMM-A

Technical data

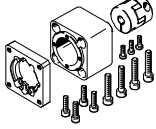
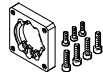

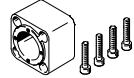
FESTO

Component parts			
Axial kit	Comprising:		
	Motor flange	Coupling	Coupling housing
			
Part No. Type	Part No. Type	Part No. Type	Part No. Type
1081659 EAMM-A-D19-28A	1087613 EAMF-A-28D-28A	562676 EAMC-16-20-5-5	1087585 EAMK-A-D19-28D
1199152 EAMM-A-D19-40A	1199144 EAMF-A-28D-40A	543419 EAMC-16-20-5-6	1087585 EAMK-A-D19-28D
1981953 EAMM-A-D19-40P	1982014 EAMF-A-28D-40P	562677 EAMC-16-20-5-8	1087585 EAMK-A-D19-28D
1087642 EAMM-A-D19-42A	1087630 EAMF-A-28D-42A	562676 EAMC-16-20-5-5	1087585 EAMK-A-D19-28D
543149 EAMM-A-D32-32B	–	543420 EAMC-16-20-6-6	552156 EAMK-A-D32-32B
560281 EAMM-A-D32-35A-40A	–	558312 EAMC-30-32-6-6	560280 EAMK-A-D32-35A-40A
2207441 EAMM-A-D32-35A-40P	–	533708 EAMC-30-32-6-8	2207509 EAMK-A-D32-35A-40P
543147 EAMM-A-D32-40A	552163 EAMF-A-28B-40A	543420 EAMC-16-20-6-6	552155 EAMK-A-D32-28B
1454238 EAMM-A-D32-40G	1460095 EAMF-A-44C-40G-S1	562681 EAMC-30-32-6-10	551006 EAMK-A-D32-44A/C
1976465 EAMM-A-D32-40P	1976704 EAMF-A-28B-40P	1232854 EAMC-16-20-6-8	552155 EAMK-A-D32-28B
543148 EAMM-A-D32-42A	552164 EAMF-A-28B-42A	543419 EAMC-16-20-5-6	552155 EAMK-A-D32-28B
550979 EAMM-A-D32-55A	529942 EAMF-A-44A/B-55A	551003 EAMC-30-32-6-9	551006 EAMK-A-D32-44A/C
550980 EAMM-A-D32-57A	530081 EAMF-A-44A/B-57A	551002 EAMC-30-32-6-6.35	551006 EAMK-A-D32-44A/C
2946758 EAMM-A-D32-60G	1460105 EAMF-A-44C-60G/H-S1	318577 EAMC-30-32-6-11	551006 EAMK-A-D32-44A/C
2946760 EAMM-A-D32-60H	1460105 EAMF-A-44C-60G/H-S1	1233256 EAMC-30-32-6-14	551006 EAMK-A-D32-44A/C
1956054 EAMM-A-D32-60P	1956846 EAMF-A-44C-60P	1233256 EAMC-30-32-6-14	551006 EAMK-A-D32-44A/C
1454239 EAMM-A-D32-67A	1476305 EAMF-A-44A/B/C-67A-S1	551003 EAMC-30-32-6-9	551006 EAMK-A-D32-44A/C

Axial kits EAMM-A

Technical data

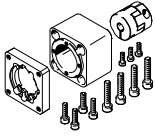
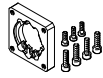

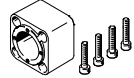
FESTO

Component parts			
Axial kit	Comprising:		
	Motor flange	Coupling	Coupling housing
			
Part No. Type	Part No. Type	Part No. Type	Part No. Type
560282 EAMM-A-D40-40G	550986 EAMF-A-44A/B-40G	558029 EAMC-30-32-8-10	552157 EAMK-A-D40-44A/C
2256398 EAMM-A-D40-40G-G2	1460095 EAMF-A-44C-40G-S1	558029 EAMC-30-32-8-10	552157 EAMK-A-D40-44A/C
543155 EAMM-A-D40-42B	–	543422 EAMC-30-32-8-8	522158 EAMK-A-D40-42B
543156 EAMM-A-D40-42C	–	543422 EAMC-30-32-8-8	522159 EAMK-A-D40-42C
543153 EAMM-A-D40-55A	529942 EAMF-A-44A/B-55A	543423 EAMC-30-32-8-9	552157 EAMK-A-D40-44A/C
543154 EAMM-A-D40-57A	530081 EAMF-A-44A/B-57A	543421 EAMC-30-32-6.35-8	552157 EAMK-A-D40-44A/C
2256400 EAMM-A-D40-60G	1460105 EAMF-A-44C-60G/H-S1	551004 EAMC-30-32-8-11	552157 EAMK-A-D40-44A/C
1454242 EAMM-A-D40-60H	1460105 EAMF-A-44C-60G/H-S1	562682 EAMC-30-32-8-14	552157 EAMK-A-D40-44A/C
1977000 EAMM-A-D40-60P	1956846 EAMF-A-44C-60P	562682 EAMC-30-32-8-14	552157 EAMK-A-D40-44A/C
1454243 EAMM-A-D40-67A	1476305 EAMF-A-44A/B/C-67A-S1	543423 EAMC-30-32-8-9	552157 EAMK-A-D40-44A/C
550981 EAMM-A-D40-70A	529943 EAMF-A-44A/B-70A	551004 EAMC-30-32-8-11	552157 EAMK-A-D40-44A/C
550982 EAMM-A-D40-87A	530082 EAMF-A-44A/B-87A	551004 EAMC-30-32-8-11	552157 EAMK-A-D40-44A/C
2733786 EAMM-A-D50-60G	2256289 EAMF-A-64B-60G/H-S1	543424 EAMC-42-50-11-12	2733780 EAMK-A-D50-64B
2733796 EAMM-A-D50-60H	2256289 EAMF-A-64B-60G/H-S1	1455671 EAMC-42-50-12-14	2733780 EAMK-A-D50-64B
2733783 EAMM-A-D50-70A	529945 EAMF-A-64A/B-70A	543424 EAMC-42-50-11-12	2733780 EAMK-A-D50-64B
2733787 EAMM-A-D50-80G	2843290 EAMF-A-64C-80G-S1	2138701 EAMC-42-50-12-20	2836865 EAMK-A-D50-64C
2733785 EAMM-A-D50-80P	1977113 EAMF-A-64A/C-80P	551005 EAMC-42-50-12-19	2836865 EAMK-A-D50-64C
2733781 EAMM-A-D50-87A	533140 EAMF-A-64A/B-87A	543424 EAMC-42-50-11-12	2733780 EAMK-A-D50-64B
2733784 EAMM-A-D50-100A	529947 EAMF-A-64A/C/D-100A	551005 EAMC-42-50-12-19	2836865 EAMK-A-D50-64C

Axial kits EAMM-A

Technical data

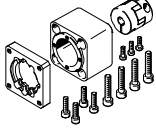
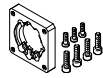
FESTO

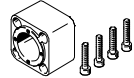
Component parts			
Axial kit	Comprising:		
	Motor flange	Coupling	Coupling housing
			
Part No. Type	Part No. Type	Part No. Type	Part No. Type
543163 EAMM-A-D60-52B	–	533709 EAMC-42-50-12-12	552161 EAMK-A-D60-52B
543164 EAMM-A-D60-52C	–	533709 EAMC-42-50-12-12	552162 EAMK-A-D60-52C
560283 EAMM-A-D60-60G	550987 EAMF-A-64A/B-60G/H	543424 EAMC-42-50-11-12	552160 EAMK-A-D60-64B
2256696 EAMM-A-D60-60G-G2	2256289 EAMF-A-64B-60G/H-S1	543424 EAMC-42-50-11-12	552160 EAMK-A-D60-64B
1454245 EAMM-A-D60-60H	2256289 EAMF-A-64B-60G/H-S1	1455671 EAMC-42-50-12-14	552160 EAMK-A-D60-64B
543161 EAMM-A-D60-70A	529945 EAMF-A-64A/B-70A	543424 EAMC-42-50-11-12	552160 EAMK-A-D60-64B
1499402 EAMM-A-D60-80G	2843290 EAMF-A-64C-80G-S1	2138701 EAMC-42-50-12-20	551007 EAMK-A-D60-64C
1977073 EAMM-A-D60-80P	1977113 EAMF-A-64A/C-80P	551005 EAMC-42-50-12-19	551007 EAMK-A-D60-64C
543162 EAMM-A-D60-87A	533140 EAMF-A-64A/B-87A	543424 EAMC-42-50-11-12	552160 EAMK-A-D60-64B
550983 EAMM-A-D60-100A	529947 EAMF-A-64A/C/D-100A	551005 EAMC-42-50-12-19	551007 EAMK-A-D60-64C
2946763 EAMM-A-D80-80G	2933286 EAMF-A-77A-80G-S1	3181801 EAMC-56-58-19-20	1593627 EAMK-A-D80-77A
1589665 EAMM-A-D80-100A	1593628 EAMF-A-77A-100A	1485673 EAMC-56-58-19-19	1593627 EAMK-A-D80-77A
1588299 EAMM-A-D80-140A	1593636 EAMF-A-77A-140A	1485674 EAMC-56-58-19-24	1593627 EAMK-A-D80-77A
3356796 EAMM-A-D100-100A	1593628 EAMF-A-77A-100A	1485674 EAMC-56-58-19-24	1593914 EAMK-A-D100-77A/B
2449341 EAMM-A-D100-120G	2449380 EAMF-A-77B-120G-S1	3187895 EAMC-67-62-24-25	1593914 EAMK-A-D100-77A/B
1588349 EAMM-A-D100-140A	1593636 EAMF-A-77A-140A	1451407 EAMC-67-62-24-24	1593914 EAMK-A-D100-77A/B

Axial kits EAMM-A

Technical data

Dimensions and ordering data

Download CAD data → www.festo.com

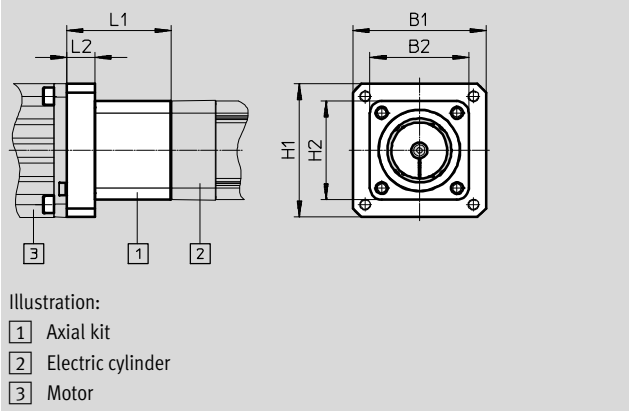

ESBF... with degree of protection IP65



Type	B1	B2	H1	H2	L1	L2
EAMM-A-D32-40A-S1	40	45	40	45	41.3	8.8
EAMM-A-D32-40G-S1	60	45	60	45	62.5	24
EAMM-A-D32-40P-S1	39.7	45	39.7	45	45.5	13
EAMM-A-D32-42A-S1	42	45	42	45	49.5	5.5
EAMM-A-D32-55A-S1	55	45	55	45	50.7	11
EAMM-A-D32-57A-S1	56.4	45	56.4	45	52	12.5
EAMM-A-D32-60G-S1	75	45	75	45	67.5	28.5
EAMM-A-D32-60H-S1	75	45	75	45	67.5	28.5
EAMM-A-D32-60P-S1	61.4	45	61.4	45	60.7	21
EAMM-A-D32-67A-S1	67	45	67	45	55.6	16
EAMM-A-D40-40G-S1	60	53.5	60	53.5	63.5	24.5
EAMM-A-D40-55A-S1	55	53.5	55	53.5	50.7	11
EAMM-A-D40-57A-S1	56.4	53.5	56.4	53.5	52	12.5
EAMM-A-D40-60G-S1	75	53.5	75	53.5	67.5	28.5
EAMM-A-D40-60H-S1	75	53.5	75	53.5	67.5	28.5
EAMM-A-D40-60P-S1	61.4	53.5	61.4	53.5	61.2	22
EAMM-A-D40-67A-S1	67	53.5	67	53.5	55.5	16.4
EAMM-A-D40-70A-S1	70	53.5	70	53.5	53.5	14
EAMM-A-D40-87A-S1	85.8	53.5	85.8	53.5	55.5	16
EAMM-A-D50-60G-S1	90	74	90	74	88.7	35.5
EAMM-A-D50-60H-S1	90	74	90	74	88.7	35.5
EAMM-A-D50-70A-S1	70	74	70	74	69.2	16.5
EAMM-A-D50-80G-S1	101	74	101	74	93.4	30.5
EAMM-A-D50-80P-S1	81.3	74	81.3	74	80.7	18
EAMM-A-D50-87A-S1	85.8	74	85.8	74	70.7	18
EAMM-A-D50-100A-S1	100	74	100	74	84.2	21.5
EAMM-A-D60-60G-S1	90	74	90	74	83.4	35.5
EAMM-A-D60-60H-S1	90	74	90	74	83.4	35.5
EAMM-A-D60-70A-S1	70	74	70	74	65	16.5
EAMM-A-D60-80G-S1	101	74	101	74	88.4	30.5
EAMM-A-D60-80P-S1	81.3	74	81.3	74	75.7	18
EAMM-A-D60-87A-S1	85.8	74	85.8	74	66.5	18
EAMM-A-D60-100A-S1	100	74	100	74	80	21.5
EAMM-A-D80-80G-S1	101	97.2	101	97.2	103.5	30.5
EAMM-A-D80-100A-S1	100	100	100	100	93.5	20.5
EAMM-A-D80-140A-S1	140.5	100	140.5	100	103.5	30.5
EAMM-A-D100-100A-S1	109	100	109	100	101	20
EAMM-A-D100-120G-S1	109	100	109	100	113	32.5
EAMM-A-D100-140A-S1	140.5	112	140.5	112	111	30.5

Axial kits EAMM-A

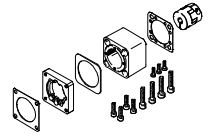
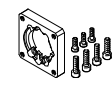

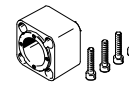
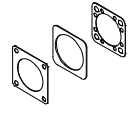
Technical data

Component parts				
Axial kit	Comprising:			
	Motor flange	Coupling	Coupling housing	Seal set
				
Part No. Type	Part No. Type	Part No. Type	Part No. Type	Part No. Type
1322178 EAMM-A-D32-40A-S1	552163 EAMF-A-28B-40A	543420 EAMC-16-20-6-6	552155 EAMK-A-D32-28B	1561526 EADS-F-D32-40A
2256396 EAMM-A-D32-40G-S1	1460095 EAMF-A-44C-40G-S1	562681 EAMC-30-32-6-10	551006 EAMK-A-D32-44A/C	2253500 EADS-F-D32-40G
2207372 EAMM-A-D32-40P-S1	1976704 EAMF-A-28B-40P	1232854 EAMC-16-20-6-8	552155 EAMK-A-D32-28B	2207219 EADS-F-D32-40P
1322179 EAMM-A-D32-42A-S1	552164 EAMF-A-28B-42A	543419 EAMC-16-20-5-6	552155 EAMK-A-D32-28B	1561527 EADS-F-D32-42A
1322180 EAMM-A-D32-55A-S1	529942 EAMF-A-44A/B-55A	551003 EAMC-30-32-6-9	551006 EAMK-A-D32-44A/C	1561528 EADS-F-D32-55A
1322181 EAMM-A-D32-57A-S1	530081 EAMF-A-44A/B-57A	551002 EAMC-30-32-6-6.35	551006 EAMK-A-D32-44A/C	1561529 EADS-F-D32-57A
2946759 EAMM-A-D32-60G-S1	1460105 EAMF-A-44C-60G/H-S1	3187577 EAMC-30-32-6-11	551006 EAMK-A-D32-44A/C	8022150 EADS-F-D32-60G/H
2946761 EAMM-A-D32-60H-S1	1460105 EAMF-A-44C-60G/H-S1	1233256 EAMC-30-32-6-14	551006 EAMK-A-D32-44A/C	8022150 EADS-F-D32-60G/H
2234020 EAMM-A-D32-60P-S1	1956846 EAMF-A-44C-60P	1233256 EAMC-30-32-6-14	551006 EAMK-A-D32-44A/C	2234012 EADS-F-D32-60P
2256397 EAMM-A-D32-67A-S1	1476305 EAMF-A-44A/B/C-67A-S1	551003 EAMC-30-32-6-9	551006 EAMK-A-D32-44A/C	2253501 EADS-F-D32-67A
2256399 EAMM-A-D40-40G-S1	1460095 EAMF-A-44C-40G-S1	558029 EAMC-30-32-8-10	552157 EAMK-A-D40-44A/C	2253502 EADS-F-D40-40G
1322182 EAMM-A-D40-55A-S1	529942 EAMF-A-44A/B-55A	543423 EAMC-30-32-8-9	552157 EAMK-A-D40-44A/C	1561530 EADS-F-D40-55A
1322183 EAMM-A-D40-57A-S1	530081 EAMF-A-44A/B-57A	543421 EAMC-30-32-6.35-8	552157 EAMK-A-D40-44A/C	1561531 EADS-F-D40-57A
2256409 EAMM-A-D40-60G-S1	1460105 EAMF-A-44C-60G/H-S1	551004 EAMC-30-32-8-11	552157 EAMK-A-D40-44A/C	2253503 EADS-F-D40-60G/H
2256401 EAMM-A-D40-60H-S1	1460105 EAMF-A-44C-60G/H-S1	562682 EAMC-30-32-8-14	552157 EAMK-A-D40-44A/C	2253503 EADS-F-D40-60G/H
2151519 EAMM-A-D40-60P-S1	1956846 EAMF-A-44C-60P	562682 EAMC-30-32-8-14	552157 EAMK-A-D40-44A/C	2151545 EADS-F-D40-60P
2256695 EAMM-A-D40-67A-S1	1476305 EAMF-A-44A/B/C-67A-S1	543423 EAMC-30-32-8-9	552157 EAMK-A-D40-44A/C	2253504 EADS-F-D40-67A
1322185 EAMM-A-D40-70A-S1	529943 EAMF-A-44A/B-70A	551004 EAMC-30-32-8-11	552157 EAMK-A-D40-44A/C	1561532 EADS-F-D40-70A
1322186 EAMM-A-D40-87A-S1	530082 EAMF-A-44A/B-87A	551004 EAMC-30-32-8-11	552157 EAMK-A-D40-44A/C	1561533 EADS-F-D40-87A

Axial kits EAMM-A

Technical data

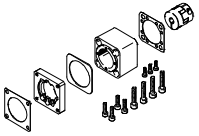
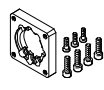
FESTO

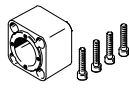
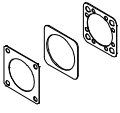
Component parts				
Axial kit	Comprising:			
	Motor flange	Coupling	Coupling housing	Seal set
				
Part No. Type	Part No. Type	Part No. Type	Part No. Type	Part No. Type
2734290 EAMM-A-D50-60G-S1	2256289 EAMF-A-64B-60G/H-S1	543424 EAMC-42-50-11-12	2733780 EAMK-A-D50-64B	2733792 EADS-F-D50-60G/H
2907418 EAMM-A-D50-60H-S1	2256289 EAMF-A-64B-60G/H-S1	1455671 EAMC-42-50-12-14	2733780 EAMK-A-D50-64B	2733792 EADS-F-D50-60G/H
2734287 EAMM-A-D50-70A-S1	529945 EAMF-A-64A/B-70A	543424 EAMC-42-50-11-12	2733780 EAMK-A-D50-64B	2733789 EADS-F-D50-70A
2734291 EAMM-A-D50-80G-S1	2843290 EAMF-A-64C-80G-S1	2138701 EAMC-42-50-12-20	2836865 EAMK-A-D50-64C	2733793 EADS-F-D50-80G
2734289 EAMM-A-D50-80P-S1	1977113 EAMF-A-64A/C-80P	551005 EAMC-42-50-12-19	2836865 EAMK-A-D50-64C	2733791 EADS-F-D50-80P
2734286 EAMM-A-D50-87A-S1	533140 EAMF-A-64A/B-87A	543424 EAMC-42-50-11-12	2733780 EAMK-A-D50-64B	2733788 EADS-F-D50-87A
2734288 EAMM-A-D50-100A-S1	529947 EAMF-A-64A/C/D-100A	551005 EAMC-42-50-12-19	2836865 EAMK-A-D50-64C	2733790 EADS-F-D50-100A
2256698 EAMM-A-D60-60G-S1	2256289 EAMF-A-64B-60G/H-S1	543424 EAMC-42-50-11-12	552160 EAMK-A-D60-64B	2253505 EADS-F-D60-60G/H
2256697 EAMM-A-D60-60H-S1	2256289 EAMF-A-64B-60G/H-S1	1455671 EAMC-42-50-12-14	552160 EAMK-A-D60-64B	2253505 EADS-F-D60-60G/H
2256699 EAMM-A-D60-70A-S1	529945 EAMF-A-64A/B-70A	543424 EAMC-42-50-11-12	552160 EAMK-A-D60-64B	8022145 EADS-F-D60-70A
2946762 EAMM-A-D60-80G-S1	2843290 EAMF-A-64C-80G-S1	2138701 EAMC-42-50-12-20	551007 EAMK-A-D60-64C	8022146 EADS-F-D60-80G
2218564 EAMM-A-D60-80P-S1	1977113 EAMF-A-64A/C-80P	551005 EAMC-42-50-12-19	551007 EAMK-A-D60-64C	2218523 EADS-F-D60-80P
1322188 EAMM-A-D60-87A-S1	533140 EAMF-A-64A/B-87A	543424 EAMC-42-50-11-12	552160 EAMK-A-D60-64B	1561536 EADS-F-D60-87A
2256700 EAMM-A-D60-100A-S1	529947 EAMF-A-64A/C/D-100A	551005 EAMC-42-50-12-19	551007 EAMK-A-D60-64C	2253507 EADS-F-D60-100A
2946764 EAMM-A-D80-80G-S1	2933286 EAMF-A-77A-80G-S1	3181801 EAMC-56-58-19-20	1593627 EAMK-A-D80-77A	8022147 EADS-F-D80-80G
1600673 EAMM-A-D80-100A-S1	1593628 EAMF-A-77A-100A	1485673 EAMC-56-58-19-19	1593627 EAMK-A-D80-77A	1593617 EADS-F-D80-100A
1600674 EAMM-A-D80-140A-S1	1593636 EAMF-A-77A-140A	1485674 EAMC-56-58-19-24	1593627 EAMK-A-D80-77A	1593671 EADS-F-D80-140A
3356931 EAMM-A-D100-100A-S1	1593628 EAMF-A-77A-100A	1485674 EAMC-56-58-19-24	1593914 EAMK-A-D100-77A/B	3356966 EADS-F-D100-100A
2946765 EAMM-A-D100-120G-S1	2449380 EAMF-A-77B-120G-S1	3187895 EAMC-67-62-24-25	1593914 EAMK-A-D100-77A/B	8022148 EADS-F-D100-120G
1600675 EAMM-A-D100-140A-S1	1593636 EAMF-A-77A-140A	1451407 EAMC-67-62-24-24	1593914 EAMK-A-D100-77A/B	1593991 EADS-F-D100-140A

Axial kits EAMM-A

Technical data

FESTO

Dimensions and ordering data

Download CAD data → www.festo.com

EGC-TB-...

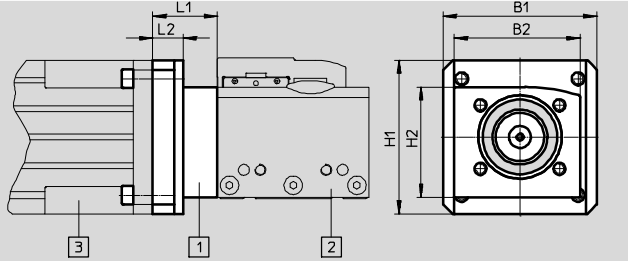

Illustration:

- 1 Axial kit
- 2 Toothed belt axis
- 3 Motor

Type	B1	B2	H1	H2	L1	L2
EAMM-A-L27-40G	50	40	50	50	28.7	–
EAMM-A-L27-55A	55	40	55	55	23.1	–
EAMM-A-L27-57A	56	39.5	56	56	23.1	–
EAMM-A-L27-67A	67	41	67	67	28	–
EAMM-A-L38-55A	55	57.5	55	50.3	26.7	11
EAMM-A-L38-57A	56	57.5	56	50.3	26.7	11
EAMM-A-L38-60G	60	57.5	60	50.3	41.7	26
EAMM-A-L38-60H	60	57.5	60	50.3	41.7	24.5
EAMM-A-L38-60P	61.4	57.5	61.4	50.3	36.7	21
EAMM-A-L38-70A	70	57.5	70	50.3	29.5	13.8
EAMM-A-L38-87A	85.8	57.5	85.8	50.3	33.7	18
EAMM-A-L48-60G	60	65	60	61	52.5	24.5
EAMM-A-L48-60H	60	65	60	61	52.5	24.5
EAMM-A-L48-70A	70	65	70	61	40.2	12.2
EAMM-A-L48-80P	81.3	65	81.3	61	54	26
EAMM-A-L48-87A	85.8	65	85.8	61	44	16
EAMM-A-L48-100A	100.5	65	100.5	61	59	31
EAMM-A-L62-80G	100	100	100	90.5	62.5	14.5
EAMM-A-L62-100A	100.5	100	100.5	90.5	62.5	14.5
EAMM-A-L62-140A	140	100	140	90.5	72.5	24.5
EAMM-A-L95-120G-G2	114	140	114	120	81	32
EAMM-A-L95-140A-G2	140	140	140	120	76	27
EAMM-A-L95-190A-G2	190	140	190	120	86	37





Component parts

Axial kit	Comprising:			
	Motor flange	Coupling	Coupling housing	Screw set
Part No. Type	Part No. Type	Part No. Type	Part No. Type	Part No. Type
557974 EAMM-A-L27-40G	558015 EAMF-A-L27-40G	557998 EAMD-19-15-10-8X10	–	–
557975 EAMM-A-L27-55A	558016 EAMF-A-L27-55A	557999 EAMD-19-15-9-8X10	–	–
560678 EAMM-A-L27-57A	560690 EAMF-A-L27-57A	561292 EAMD-16-15-6.35-8X10	–	–
1454261 EAMM-A-L27-67A	1460087 EAMF-A-L27-67A	557999 EAMD-19-15-9-8X10	–	–

Axial kits EAMM-A

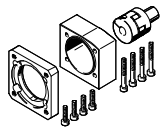
Technical data

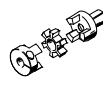
FESTO

Component parts				
Axial kit	Comprising:			
	Motor flange	Coupling	Coupling housing	Screw set
				
Part No. Type	Part No. Type	Part No. Type	Part No. Type	Part No. Type
3683331 EAMM-A-L38-55A	558176 EAMF-A-38A-55A	3717923 EAMD-25-22-9-10X12	558011 EAMK-A-L38-38A	567484 EAHM-L2-M5-30
560679 EAMM-A-L38-57A	560692 EAMF-A-38A-57A	561293 EAMD-25-22-6.35-10X12	558011 EAMK-A-L38-38A	567484 EAHM-L2-M5-30
557978 EAMM-A-L38-60G	558017 EAMF-A-38A-60G/H	558000 EAMD-25-22-11-10X12	558011 EAMK-A-L38-38A	567485 EAHM-L2-M5-35
1456610 EAMM-A-L38-60H	558017 EAMF-A-38A-60G/H	1453861 EAMD-28-22-14-10X12	558011 EAMK-A-L38-38A	567485 EAHM-L2-M5-35
2037246 EAMM-A-L38-60P	1987412 EAMF-A-38A-60P	1453861 EAMD-28-22-14-10X12	558011 EAMK-A-L38-38A	567485 EAHM-L2-M5-35
557979 EAMM-A-L38-70A	558018 EAMF-A-38A-70A	558000 EAMD-25-22-11-10X12	558011 EAMK-A-L38-38A	567484 EAHM-L2-M5-30
560680 EAMM-A-L38-87A	560693 EAMF-A-38A-87A	558000 EAMD-25-22-11-10X12	558011 EAMK-A-L38-38A	567485 EAHM-L2-M5-35
557983 EAMM-A-L48-60G	558019 EAMF-A-48A-60G/H	558001 EAMD-32-32-11-16X20	558012 EAMK-A-L48-48A	567486 EAHM-L2-M5-40
1456611 EAMM-A-L48-60H	558019 EAMF-A-48A-60G/H	1377480 EAMD-32-32-14-16X20	558012 EAMK-A-L48-48A	567486 EAHM-L2-M5-40
557982 EAMM-A-L48-70A	558025 EAMF-A-48A-70A	558001 EAMD-32-32-11-16X20	558012 EAMK-A-L48-48A	567486 EAHM-L2-M5-40
2042616 EAMM-A-L48-80P	2043427 EAMF-A-48A-80P	558002 EAMD-42-40-19-16X25	558012 EAMK-A-L48-48A	567489 EAHM-L2-M5-55
560683 EAMM-A-L48-87A	560695 EAMF-A-48A-87A	558001 EAMD-32-32-11-16X20	558012 EAMK-A-L48-48A	567487 EAHM-L2-M5-45
557984 EAMM-A-L48-100A	558020 EAMF-A-48A-100A	558002 EAMD-42-40-19-16X25	558012 EAMK-A-L48-48A	567489 EAHM-L2-M5-55
557989 EAMM-A-L62-80G	558021 EAMF-A-62A-80G	558004 EAMD-56-46-20-23X27	558013 EAMK-A-L62-62A	567492 EAHM-L2-M6-65-L
557988 EAMM-A-L62-100A	558026 EAMF-A-62A-100A	558003 EAMD-56-46-19-23X27	558013 EAMK-A-L62-62A	567491 EAHM-L2-M6-65
557990 EAMM-A-L62-140A	558022 EAMF-A-62A-140A	558005 EAMD-56-46-24-23X27	558013 EAMK-A-L62-62A	567493 EAHM-L2-M6-70
3659941 EAMM-A-L95-120G-G2	3659724 EAMF-A-95A-120G-G2	558006 EAMD-67-51-25-32X32-U	558014 EAMK-A-L95-95A/B-G2	567496 EAHM-L2-M8-70
3657226 EAMM-A-L95-140A-G2	558023 EAMF-A-95A-140A	558008 EAMD-67-51-24-32X32-U	3712650 EAMK-A-L95-95A/B-G2	567497 EAHM-L2-M8-80
3659562 EAMM-A-L95-190A-G2	1378473 EAMF-A-95A-190A	1379269 EAMD-67-51-32-32X32-U	3712650 EAMK-A-L95-95A/B-G2	567497 EAHM-L2-M8-80

Axial kits EAMM-A

Technical data

FESTO

Abmessungen und Bestellangaben

Download CAD data → www.festo.com

EGC-BS-...

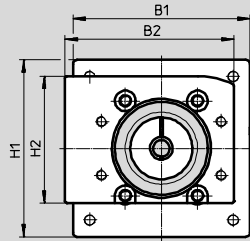
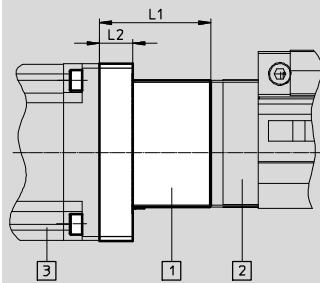

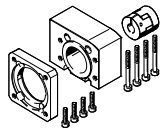

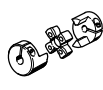
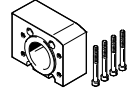

Illustration:

- 1 Axial kit
- 2 Spindle axis
- 3 Motor

Typ	B1	B2	H1	H2	L1	L2
EAMM-A-S38-40A	58	69	44	50	44	7
EAMM-A-S38-40A-G2	58	55	44	44	44	7
EAMM-A-S38-40G-G2	60	55	60	44	54	17
EAMM-A-S38-40P	58	69	44	50	54	15.5
EAMM-A-S38-40P-G2	58	55	44	44	44.7	10.7
EAMM-A-S38-42A	58	69	44	50	52	15
EAMM-A-S38-42A-G2	58	55	44	44	52	15
EAMM-A-S38-55A	55	69	55	50	48	11
EAMM-A-S38-55A-G2	55	55	55	44	48	11
EAMM-A-S38-57A	56	69	56	50	48	11
EAMM-A-S38-57A-G2	56	55	56	55	48	11
EAMM-A-S38-60P	61.4	69	61.4	50	63.2	16
EAMM-A-S38-60P-G2	61.4	55	61.4	44	58	21
EAMM-A-S38-67A-G2	67	55	67	44	53	16
EAMM-A-S48-40G-G2	60	70	60	53	55	17
EAMM-A-S48-55A	70	82	55	61.5	47.2	9.2
EAMM-A-S48-55A-G2	70	70	55	53	47.2	9.2
EAMM-A-S48-57A	70	82	55	61.5	47.2	9.2
EAMM-A-S48-57A-G2	70	70	55	53	47.2	9.2
EAMM-A-S48-60G-G2	60	70	60	53	62.5	24.5
EAMM-A-S48-60H-G2	60	70	60	53	62.5	24.5
EAMM-A-S48-60P	61.4	82	61.4	61.5	74.7	17.5
EAMM-A-S48-60P-G2	61.4	70	61.4	53	57.2	19.2
EAMM-A-S48-70A	70	82	70	61.5	50.2	12.2
EAMM-A-S48-70A-G2	70	70	70	53	50.2	12.2
EAMM-A-S48-87A	85.8	82	85.8	61.5	54	16
EAMM-A-S48-87A-G2	85.8	70	85.8	53	54	16
EAMM-A-S62-60G-G2	80	80	80	70	84.5	18
EAMM-A-S62-60H-G2	80	80	80	70	84.5	18
EAMM-A-S62-70A	82	120	70	88.5	78.5	12
EAMM-A-S62-70A-G2	82	80	70	70	78.5	12
EAMM-A-S62-80G-G2	100	80	100	70	81	14.5
EAMM-A-S62-80P	81.3	120	81.3	88.5	64.7	17.5
EAMM-A-S62-80P-G2	81.3	80	81.3	70	77	10.5
EAMM-A-S62-87A	85.8	120	85.8	88.5	81.5	15
EAMM-A-S62-87A-G2	85.8	80	85.8	70	81.5	15
EAMM-A-S62-100A	100.5	120	100.5	88.5	81	14.5
EAMM-A-S62-100A-G2	100.5	80	100.5	70	81	14.5
EAMM-A-S62-140A	140	120	140	88.5	91	24.5
EAMM-A-S62-140A-G2	140	80	140	70	91	24.5
EAMM-A-S95-100A	140	186	100	140.5	85.5	17
EAMM-A-S95-100A-G2	140	140	100	110	85.5	17
EAMM-A-S95-140A	140	186	140	140.5	95.5	27
EAMM-A-S95-140A-G2	140	140	140	110	95.5	27





Axial kits EAMM-A

Technical data

Component parts				
Axial kit	Comprising:			
	Motor flange	Coupling	Coupling housing	Screw set
				
Part No. Type	Part No. Type	Part No. Type	Part No. Type	Part No. Type
558162 EAMM-A-S38-40A	558175 EAMF-A-38B-40A	558312 EAMC-30-32-6-6	558171 EAMK-A-S38-38A/B	-
3637971 EAMM-A-S38-40A-G2	558175 EAMF-A-38B-40A	558312 EAMC-30-32-6-6	3637942 EAMK-A-S38-38A/B-G2	-
1456647 EAMM-A-S38-40G-G2	1460097 EAMF-A-38A-40G	562681 EAMC-30-32-6-10	3637942 EAMK-A-S38-38A/B-G2	567488 EAHM-L2-M5-50
2219044 EAMM-A-S38-40P	2219077 EAMF-A-38B-40P	533708 EAMC-30-32-6-8	558171 EAMK-A-S38-38A/B	-
3637972 EAMM-A-S38-40P-G2	2219077 EAMF-A-38B-40P	533708 EAMC-30-32-6-8	3637942 EAMK-A-S38-38A/B-G2	-
560685 EAMM-A-S38-42A	560691 EAMF-A-38B-42A	561333 EAMC-30-32-5-6	558171 EAMK-A-S38-38A/B	-
3637965 EAMM-A-S38-42A-G2	560691 EAMF-A-38B-42A	561333 EAMC-30-32-5-6	3637942 EAMK-A-S38-38A/B-G2	-
558163 EAMM-A-S38-55A	558176 EAMF-A-38A-55A	551003 EAMC-30-32-6-9	558171 EAMK-A-S38-38A/B	567488 EAHM-L2-M5-50
3637967 EAMM-A-S38-55A-G2	558176 EAMF-A-38A-55A	551003 EAMC-30-32-6-9	3637942 EAMK-A-S38-38A/B-G2	567488 EAHM-L2-M5-50
560686 EAMM-A-S38-57A	560692 EAMF-A-38A-57A	551002 EAMC-30-32-6-6.35	558171 EAMK-A-S38-38A/B	567488 EAHM-L2-M5-50
3637956 EAMM-A-S38-57A-G2	560692 EAMF-A-38A-57A	551002 EAMC-30-32-6-6.35	3637942 EAMK-A-S38-38A/B-G2	567488 EAHM-L2-M5-50
2219110 EAMM-A-S38-60P	1987412 EAMM-A-38A-60P	1233256 EAMC-30-32-6-14	558171 EAMK-A-S38-38A/B	567489 EAHM-L2-M5-55
3637958 EAMM-A-S38-60P-G2	1987412 EAMF-A-38A-60P	1233256 EAMC-30-32-6-14	3637942 EAMK-A-S38-38A/B-G2	567489 EAHM-L2-M5-55
1456638 EAMM-A-S38-67A-G2	1490100 EAMF-A-38A-67A	551003 EAMC-30-32-6-9	3637942 EAMK-A-S38-38A/B-G2	567489 EAHM-L2-M5-55
1456650 EAMM-A-S48-40G-G2	4067069 EAMF-A-48B-40G	558029 EAMC-30-32-8-10	3637941 EAMK-A-S48-48A/B-G2	-
558164 EAMM-A-S48-55A	558177 EAMF-A-48B-55A	543423 EAMC-30-32-8-9	558172 EAMK-A-S48-48A/B	-
3637961 EAMM-A-S48-55A-G2	558177 EAMF-A-48B-55A	543423 EAMC-30-32-8-9	3637941 EAMK-A-S48-48A/B-G2	-
560687 EAMM-A-S48-57A	560694 EAMF-A-48B-57A	543421 EAMC-30-32-6.35-8	558172 EAMK-A-S48-48A/B	-
3637963 EAMM-A-S48-57A-G2	560694 EAMF-A-48B-57A	543421 EAMC-30-32-6.35-8	3637941 EAMK-A-S48-48A/B-G2	-
2256701 EAMM-A-S48-60G-G2	558019 EAMF-A-48A-60G/H	551004 EAMC-30-32-8-11	3637941 EAMK-A-S48-48A/B-G2	567489 EAHM-L2-M5-55
1456652 EAMM-A-S48-60H-G2	558019 EAMF-A-48A-60G/H	562682 EAMC-30-32-8-14	3637941 EAMK-A-S48-48A/B-G2	567489 EAHM-L2-M5-55
2220560 EAMM-A-S48-60P	2220620 EAMF-A-48A-60P	562682 EAMC-30-32-8-14	558172 EAMK-A-S48-48A/B	567489 EAHM-L2-M5-55
3637964 EAMM-A-S48-60P-G2	2220620 EAMF-A-48A-60P	562682 EAMC-30-32-8-14	3637941 EAMK-A-S48-48A/B-G2	567489 EAHM-L2-M5-55

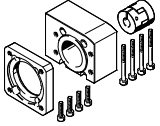
Axial kits EAMM-A

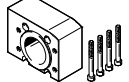
Technical data

Component parts				
Axial kit	Comprising:			
	Motor flange	Coupling	Coupling housing	Screw set
				
Part No. Type	Part No. Type	Part No. Type	Part No. Type	Part No. Type
558165 EAMM-A-S48-70A	558025 EAMF-A-48A-70A	551004 EAMC-30-32-8-11	558172 EAMK-A-S48-48A/B	567488 EAHM-L2-M5-50
3637957 EAMM-A-S48-70A-G2	558025 EAMF-A-48A-70A	551004 EAMC-30-32-8-11	3637941 EAMK-A-S48-48A/B-G2	567488 EAHM-L2-M5-50
560688 EAMM-A-S48-87A	560695 EAMF-A-48A-87A	551004 EAMC-30-32-8-11	558172 EAMK-A-S48-48A/B	567489 EAHM-L2-M5-55
3637962 EAMM-A-S48-87A-G2	560695 EAMF-A-48A-87A	551004 EAMC-30-32-8-11	3637941 EAMK-A-S48-48A/B-G2	567489 EAHM-L2-M5-55
2297649 EAMM-A-S62-60G-G2	1460112 EAMF-A-62A-60G/H	525864 EAMC-40-66-11-12	3637940 EAMK-A-S62-62A/B-G2	567495 EAHM-L2-M6-90
1456654 EAMM-A-S62-60H-G2	1460112 EAMF-A-62A-60G/H	1452803 EAMC-40-66-12-14	3637940 EAMK-A-S62-62A/B-G2	567495 EAHM-L2-M6-90
558166 EAMM-A-S62-70A	558179 EAMF-A-62B-70A	558313 EAMC-42-66-11-12	558173 EAMK-A-S62-62A/B	-
3637959 EAMM-A-S62-70A-G2	558179 EAMF-A-62B-70A	558313 EAMC-42-66-11-12	3637940 EAMK-A-S62-62A/B-G2	-
1972530 EAMM-A-S62-80G-G2	2116672 EAMF-A-62B-80G	2138701 EAMC-42-50-12-20	3637940 EAMK-A-S62-62A/B-G2	-
2222582 EAMM-A-S62-80P	2222624 EAMF-A-62B-80P	551005 EAMC-42-50-12-19	558173 EAMK-A-S62-62A/B	-
3637970 EAMM-A-S62-80P-G2	2222624 EAMF-A-62B-80P	551005 EAMC-42-50-12-19	3637940 EAMK-A-S62-62A/B-G2	-
560689 EAMM-A-S62-87A	560696 EAMF-A-62B-87A	558313 EAMC-42-66-11-12	558173 EAMK-A-S62-62A/B	-
3637966 EAMM-A-S62-87A-G2	560696 EAMF-A-62B-87A	558313 EAMC-42-66-11-12	3637940 EAMK-A-S62-62A/B-G2	-
558167 EAMM-A-S62-100A	558026 EAMF-A-62A-100A	551005 EAMC-42-50-12-19	558173 EAMK-A-S62-62A/B	567494 EAHM-L2-M6-80
3637960 EAMM-A-S62-100A-G2	558026 EAMF-A-62A-100A	551005 EAMC-42-50-12-19	3637940 EAMK-A-S62-62A/B-G2	567494 EAHM-L2-M6-80
558168 EAMM-A-S62-140A	558022 EAMF-A-62A-140A	558314 EAMC-42-50-12-24	558173 EAMK-A-S62-62A/B	567495 EAHM-L2-M6-90
3637969 EAMM-A-S62-140A-G2	558022 EAMF-A-62A-140A	558314 EAMC-42-50-12-24	3637940 EAMK-A-S62-62A/B-G2	567495 EAHM-L2-M6-90
558169 EAMM-A-S95-100A	558182 EAMF-A-95B-100A	558315 EAMC-56-58-19-25	558174 EAMK-A-S95-95A/B	-
3637955 EAMM-A-S95-100A-G2	558182 EAMF-A-95B-100A	558315 EAMC-56-58-19-25	3637939 EAMK-A-S95-95A/B-G2	-
558170 EAMM-A-S95-140A	558023 EAMF-A-95A-140A	558316 EAMC-56-58-24-25	558174 EAMK-A-S95-95A/B	567498 EAHM-L2-M8-100
3637954 EAMM-A-S95-140A-G2	558023 EAMF-A-95A-140A	558316 EAMC-56-58-24-25	3637939 EAMK-A-S95-95A/B-G2	567498 EAHM-L2-M8-100

Axial kits EAMM-A

Technical data

FESTO

Dimensions and ordering data

Download CAD data → www.festo.com

ELGA-BS-...-

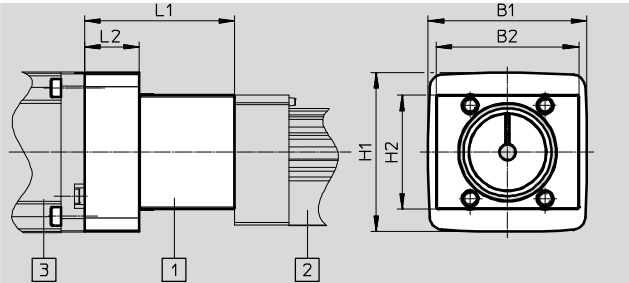

Illustration:

- 1 Axial kit
- 2 Spindle axis
- 3 Motor





Type	B1	B2	H1	H2	L1	L2
EAMM-A-S38-40A-G2	58	55	44	44	44	7
EAMM-A-S38-40P-G2	58	55	44	44	44.7	10.7
EAMM-A-S38-42A-G2	58	55	44	44	52	15
EAMM-A-S38-55A-G2	55	55	55	44	48	11
EAMM-A-S38-57A-G2	56	55	56	44	48	11
EAMM-A-S38-60P-G2	61.4	55	61.4	44	58	21
EAMM-A-S48-55A-G2	70	70	55	53	47.2	9.2
EAMM-A-S48-57A-G2	70	70	55	53	47.2	9.2
EAMM-A-S48-60P-G2	61.4	70	61.4	53	57.2	19.2
EAMM-A-S48-70A-G2	70	70	70	53	50.2	12.2
EAMM-A-S48-87A-G2	85.8	70	85.8	53	54	16
EAMM-A-S62-70A-G2	82	80	70	70	78.5	12
EAMM-A-S62-80P-G2	81.3	80	81.3	70	77	10.5
EAMM-A-S62-87A-G2	85.8	80	85.8	70	81.5	15
EAMM-A-S62-100A-G2	100.5	80	100.5	70	81	14.5
EAMM-A-S62-140A-G2	140	80	140	70	91	24.5
EAMM-A-S95-100A-G2	140	140	100	110	85.5	17
EAMM-A-S95-140A-G2	140	140	140	110	95.5	27

Component parts

Axial kit	Comprising:			
	Motor flange	Coupling	Coupling housing	Screw set
Part No. Type	Part No. Type	Part No. Type	Part No. Type	Part No. Type
3637971 EAMM-A-S38-40A-G2	558175 EAMF-A-38B-40A	558312 EAMC-30-32-6-6	3637942 EAMK-A-S38-38A/B-G2	-
3637972 EAMM-A-S38-40P-G2	2219077 EAMF-A-38B-40P	533708 EAMC-30-32-6-8	3637942 EAMK-A-S38-38A/B-G2	-
3637965 EAMM-A-S38-42A-G2	560691 EAMF-A-38B-42A	561333 EAMC-30-32-5-6	3637942 EAMK-A-S38-38A/B-G2	-
3637967 EAMM-A-S38-55A-G2	558176 EAMF-A-38A-55A	551003 EAMC-30-32-6-9	3637942 EAMK-A-S38-38A/B-G2	567488 EAHM-L2-M5-50
3637956 EAMM-A-S38-57A-G2	560692 EAMF-A-38A-57A	551002 EAMC-30-32-6-6.35	3637942 EAMK-A-S38-38A/B-G2	567488 EAHM-L2-M5-50
3637958 EAMM-A-S38-60P-G2	1987412 EAMM-A-38A-60P	1233256 EAMC-30-32-6-14	3637942 EAMK-A-S38-38A/B-G2	567489 EAHM-L2-M5-55
3637961 EAMM-A-S48-55A-G2	558177 EAMF-A-48B-55A	543423 EAMC-30-32-8-9	3637941 EAMK-A-S48-48A/B-G2	-
3637963 EAMM-A-S48-57A-G2	560694 EAMF-A-48B-57A	543421 EAMC-30-32-6.35-8	3637941 EAMK-A-S48-48A/B-G2	-
3637964 EAMM-A-S48-60P-G2	2220620 EAMF-A-48A-60P	562682 EAMC-30-32-8-14	3637941 EAMK-A-S48-48A/B-G2	567489 EAHM-L2-M5-55
3637957 EAMM-A-S48-70A-G2	558025 EAMF-A-48A-70A	551004 EAMC-30-32-8-11	3637941 EAMK-A-S48-48A/B-G2	567488 EAHM-L2-M5-50
3637962 EAMM-A-S48-87A-G2	560695 EAMF-A-48A-87A	551004 EAMC-30-32-8-11	3637941 EAMK-A-S48-48A/B-G2	567489 EAHM-L2-M5-55

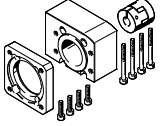
Axial kits EAMM-A

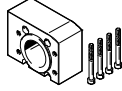
Technical data

Component parts				
Axial kit	Comprising:			
	Motor flange	Coupling	Coupling housing	Screw set
				
Part No. Type	Part No. Type	Part No. Type	Part No. Type	Part No. Type
3637959 EAMM-A-S62-70A-G2	558179 EAMF-A-62B-70A	558313 EAMC-42-66-11-12	3637940 EAMK-A-S62-62A/B-G2	–
3637970 EAMM-A-S62-80P-G2	2222624 EAMF-A-62B-80P	551005 EAMC-42-50-12-19	3637940 EAMK-A-S62-62A/B-G2	–
3637966 EAMM-A-S62-87A-G2	560696 EAMF-A-62B-87A	558313 EAMC-42-66-11-12	3637940 EAMK-A-S62-62A/B-G2	–
3637960 EAMM-A-S62-100A-G2	558026 EAMF-A-62A-100A	551005 EAMC-42-50-12-19	3637940 EAMK-A-S62-62A/B-G2	567494 EAHM-L2-M6-80
3637969 EAMM-A-S62-140A-G2	558022 EAMF-A-62A-140A	558314 EAMC-42-50-12-24	3637940 EAMK-A-S62-62A/B-G2	567495 EAHM-L2-M6-90
3637955 EAMM-A-S95-100A-G2	558182 EAMF-A-95B-100A	558315 EAMC-56-58-19-25	3637939 EAMK-A-S95-95A/B-G2	–
3637954 EAMM-A-S95-140A-G2	558023 EAMF-A-95A-140A	558316 EAMC-56-58-24-25	3637939 EAMK-A-S95-95A/B-G2	567498 EAHM-L2-M8-100

Axial kits EAMM-A

Technical data

Dimensions and ordering data

Download CAD data → www.festo.com



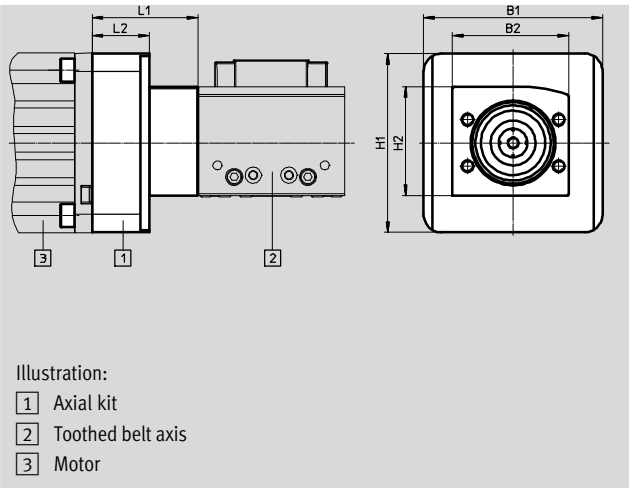

ELGA-...-TB

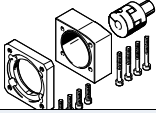

Type	B1	B2	H1	H2	L1	L2
EAMM-A-L95-80G-G2	140	140	140	120	66	17
EAMM-A-L95-120G-G2	114	140	114	120	81	32
EAMM-A-L95-140A-G2	140	140	140	120	76	27
EAMM-A-L95-190A-G2	190	140	190	120	86	37
EAMM-A-N38-60G	60	57.5	60	50.3	49.5	33
EAMM-A-N38-60H	60	57.5	60	50.3	49.5	33
EAMM-A-N38-70A	70	57.5	70	50.3	37.5	21
EAMM-A-N38-87A	85.5	57.5	85.5	50.3	42	25.5
EAMM-A-N48-60G	66	65	60	61	53.1	26
EAMM-A-N48-60H	66	65	60	61	53.1	26
EAMM-A-N48-80G	100	65	100	61	59.1	32
EAMM-A-N48-100A	100	65	100	61	59	31.9
EAMM-A-N80-80G	100	100	100	90.5	62.5	19
EAMM-A-N80-120G	124	100	124	90.5	77.5	34
EAMM-A-N80-140A	138	100	138	90.5	72.5	29

Axial kits EAMM-A

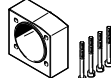
Technical data

Component parts				
Axial kit	Comprising:			
	Motor flange	Coupling	Coupling housing	Screw set
				
Part No. Type	Part No. Type	Part No. Type	Part No. Type	Part No. Type
3660191 EAMM-A-L95-80G-G2	3305700 EAMF-A-95B-80G	3717812 EAMD-67-51-20-32X32-U	3712650 EAMK-A-L95-95A/B-G2	-
3659941 EAMM-A-L95-120G-G2	3659724 EAMF-A-95A-120G-G2	558006 EAMD-67-51-25-32X32-U	3712650 EAMK-A-L95-95A/B-G2	567496 EAHM-L2-M8-70
3657226 EAMM-A-L95-140A-G2	558023 EAMF-A-95A-140A	558008 EAMD-67-51-24-32X32-U	3712650 EAMK-A-L95-95A/B-G2	567497 EAHM-L2-M8-80
3659562 EAMM-A-L95-190A-G2	1378473 EAMF-A-95A-190A	1379269 EAMD-67-51-32-32X32-U	3712650 EAMK-A-L95-95A/B-G2	567497 EAHM-L2-M8-80
1202253 EAMM-A-N38-60G	1190015 EAMF-A-38D-60G/H	558001 EAMD-32-32-11-16X20	1345947 EAMK-A-N38-38D	1202262 EAHM-L5-M6-40
1456616 EAMM-A-N38-60H	1190015 EAMF-A-38D-60G/H	1377840 EAMD-32-32-14-16X20	1345947 EAMK-A-N38-38D	1202262 EAHM-L5-M6-40
1202331 EAMM-A-N38-70A	1202337 EAMF-A-38D-70A	558001 EAMD-32-32-11-16X20	1345947 EAMK-A-N38-38D	1202288 EAHM-L5-M6-35
3324111 EAMM-A-N38-87A	3319868 EAMF-A-38D-87A	558001 EAMD-32-32-11-16X20	1345947 EAMK-A-N38-38D	1202288 EAHM-L5-M6-35
1972527 EAMM-A-N48-60G	1460111 EAMF-A-48C-60G/H	558001 EAMD-32-32-11-16X20	1345949 EAMK-A-N48-48C	1201874 EAHM-L5-M6-50
1456618 EAMM-A-N48-60H	1460111 EAMF-A-48C-60G/H	1377840 EAMD-32-32-14-16X20	1345949 EAMK-A-N48-48C	1201874 EAHM-L5-M6-50
1258793 EAMM-A-N48-80G	1190375 EAMF-A-48C-80G	1781043 EAMD-42-40-20-16X25-U	1345949 EAMK-A-N48-48C	1201874 EAHM-L5-M6-50
1201894 EAMM-A-N48-100A	1201924 EAMF-A-48C-100A	558002 EAMD-42-40-19-16X25	1345949 EAMK-A-N48-48C	1201874 EAHM-L5-M6-50
2372096 EAMM-A-N80-80G	2372201 EAMF-A-80A-80G	558004 EAMD-56-46-20-23X27	1345953 EAMK-A-N80-80A	1201712 EAHM-L5-M8-60
1201695 EAMM-A-N80-120G	1190702 EAMF-A-80A-120G	1188801 EAMD-56-46-25-23X27	1345953 EAMK-A-N80-80A	1201712 EAHM-L5-M8-60
1201691 EAMM-A-N80-140A	1190796 EAMF-A-80A-140A	558005 EAMD-56-46-24-23X27	1345953 EAMK-A-N80-80A	1201751 EAHM-L5-M8-75

Axial kits EAMM-A

Technical data

Dimensions and ordering data

Download CAD data → www.festo.com

EGC-HD-TB-...

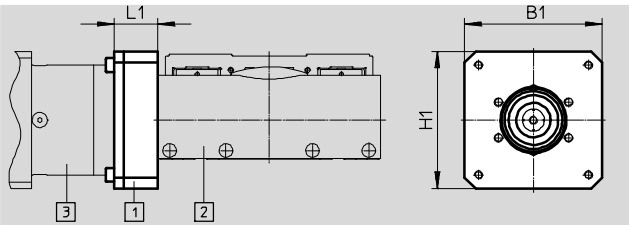

Illustration:

- 1 Axial kit
- 2 Toothed belt axis
- 3 Motor

Type	B1	H1	L1
EAMM-A-M43-60G	60	60	33
EAMM-A-M43-60H	60	60	33
EAMM-A-M48-60H	66	60	26
EAMM-A-M48-80G	100	100	32
EAMM-A-M80-120G	124	124	34

Component parts

Axial kit	Comprising:		
	Motor flange	Coupling	Centring ring
Part No. Type	Part No. Type	Part No. Type	Part No. Type
1190076 EAMM-A-M43-60G	1597579 EAMF-A-43D-60G/H	558001 EAMD-32-32-11-16X20	575962 EAML-43-4-43
1456612 EAMM-A-M43-60H	1597579 EAMF-A-43D-60G/H	1377840 EAMD-32-32-14-16X20	575962 EAML-43-4-43
1456614 EAMM-A-M48-60H	1460111 EAMF-A-48C-60G/H	3420022 EAMD-42-40-14-16X25-U	558031 EAML-48-4-48
1190421 EAMM-A-M48-80G	1190375 EAMF-A-48C-80G	1781043 EAMD-42-40-20-16X25-U	558031 EAML-48-4-48
1190774 EAMM-A-M80-120G	1190702 EAMF-A-80A-120G	1781045 EAMD-56-46-25-23X27-U	1209006 EAML-80-6-80

Axial kits EAMM-A

Technical data

FESTO

Dimensions and ordering data

Download CAD data → www.festo.com

EGC-HD-BS-...

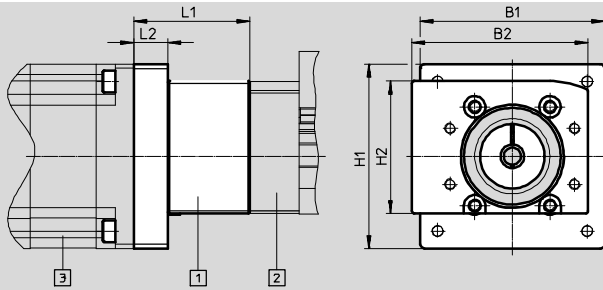

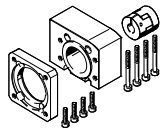

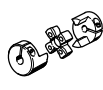
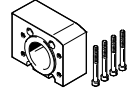

Illustration:

- 1 Axial kit
- 2 Spindle axis
- 3 Motor

Typ	B1	B2	H1	H2	L1	L2
EAMM-A-S38-40A	58	69	44	50	44	7
EAMM-A-S38-40A-G2	58	55	44	44	44	7
EAMM-A-S38-40G-G2	60	55	60	44	54	17
EAMM-A-S38-40P	58	69	44	50	54	15.5
EAMM-A-S38-40P-G2	58	55	44	44	44.7	10.7
EAMM-A-S38-42A	58	69	44	50	52	15
EAMM-A-S38-42A-G2	58	55	44	44	52	15
EAMM-A-S38-55A	55	69	55	50	48	11
EAMM-A-S38-55A-G2	55	55	55	44	48	11
EAMM-A-S38-57A	56	69	56	50	48	11
EAMM-A-S38-57A-G2	56	55	56	44	48	11
EAMM-A-S38-60P	61.4	69	61.4	50	63.2	16
EAMM-A-S38-60P-G2	61.4	55	61.4	44	58	21
EAMM-A-S38-67A-G2	67	55	67	44	53	16
EAMM-A-S48-40G-G2	60	70	60	53	55	17
EAMM-A-S48-55A	70	82	55	61.5	47.2	9.2
EAMM-A-S48-55A-G2	70	70	55	53	47.2	9.2
EAMM-A-S48-57A	70	82	55	61.5	47.2	9.2
EAMM-A-S48-57A-G2	70	70	55	53	47.2	9.2
EAMM-A-S48-60G-G2	60	70	60	53	62.5	24.5
EAMM-A-S48-60H-G2	60	70	60	53	62.5	24.5
EAMM-A-S48-60P	61.4	82	61.4	61.5	74.7	17.5
EAMM-A-S48-60P-G2	61.4	70	61.4	53	57.2	19.2
EAMM-A-S48-70A	70	82	70	61.5	50.2	12.2
EAMM-A-S48-70A-G2	70	70	70	53	50.2	12.2
EAMM-A-S48-87A	85.8	82	85.8	61.5	54	16
EAMM-A-S48-87A-G2	85.8	70	85.8	53	54	16
EAMM-A-S62-60G-G2	80	80	80	70	84.5	18
EAMM-A-S62-60H-G2	80	80	80	70	84.5	18
EAMM-A-S62-70A	82	120	70	88.5	78.5	12
EAMM-A-S62-70A-G2	82	80	70	70	78.5	12
EAMM-A-S62-80G-G2	100	80	100	70	81	14.5
EAMM-A-S62-80P	81.3	120	81.3	88.5	64.7	17.5
EAMM-A-S62-80P-G2	81.3	80	81.3	70	77	10.5
EAMM-A-S62-87A	85.8	120	85.8	88.5	81.5	15
EAMM-A-S62-87A-G2	85.8	80	85.5	70	81.5	15
EAMM-A-S62-100A	100.5	120	100.5	88.5	81	14.5
EAMM-A-S62-100A-G2	100.5	80	100.5	70	81	14.5
EAMM-A-S62-140A	140	120	140	88.5	91	24.5
EAMM-A-S62-140A-G2	140	80	140	70	91	24.5





Axial kits EAMM-A

Technical data

Component parts				
Axial kit	Comprising:			
	Motor flange	Coupling	Coupling housing	Screw set
				
Part No. Type	Part No. Type	Part No. Type	Part No. Type	Part No. Type
558162 EAMM-A-S38-40A	558175 EAMF-A-38B-40A	558312 EAMC-30-32-6-6	558171 EAMK-A-S38-38A/B	–
3637971 EAMM-A-S38-40A-G2	558175 EAMF-A-38B-40A	558312 EAMC-30-32-6-6	3637942 EAMK-A-S38-38A/B-G2	–
1456647 EAMM-A-S38-40G-G2	1460097 EAMF-A-38A-40G	562681 EAMC-30-32-6-10	3637942 EAMK-A-S38-38A/B-G2	567488 EAHM-L2-M5-50
2219044 EAMM-A-S38-40P	2219077 EAMF-A-38B-40P	533708 EAMC-30-32-6-8	558171 EAMK-A-S38-38A/B	–
3637972 EAMM-A-S38-40P-G2	2219077 EAMF-A-38B-40P	533708 EAMC-30-32-6-8	3637942 EAMK-A-S38-38A/B-G2	–
560685 EAMM-A-S38-42A	560691 EAMF-A-38B-42A	561333 EAMC-30-32-5-6	558171 EAMK-A-S38-38A/B	–
3637965 EAMM-A-S38-42A-G2	560691 EAMF-A-38B-42A	561333 EAMC-30-32-5-6	3637942 EAMK-A-S38-38A/B-G2	–
558163 EAMM-A-S38-55A	558176 EAMF-A-38A-55A	551003 EAMC-30-32-6-9	558171 EAMK-A-S38-38A/B	567488 EAHM-L2-M5-50
3637967 EAMM-A-S38-55A-G2	558176 EAMF-A-38A-55A	551003 EAMC-30-32-6-9	3637942 EAMK-A-S38-38A/B-G2	567488 EAHM-L2-M5-50
560686 EAMM-A-S38-57A	560692 EAMF-A-38A-57A	551002 EAMC-30-32-6-6.35	558171 EAMK-A-S38-38A/B	567488 EAHM-L2-M5-50
3637956 EAMM-A-S38-57A-G2	560692 EAMF-A-38A-57A	551002 EAMC-30-32-6-6.35	3637942 EAMK-A-S38-38A/B-G2	567488 EAHM-L2-M5-50
2219110 EAMM-A-S38-60P	1987412 EAMM-A-38A-60P	1233256 EAMC-30-32-6-14	558171 EAMK-A-S38-38A/B	567489 EAHM-L2-M5-55
3637958 EAMM-A-S38-60P-G2	1987412 EAMF-A-38A-60P	1233256 EAMC-30-32-6-14	3637942 EAMK-A-S38-38A/B-G2	567489 EAHM-L2-M5-55
1456638 EAMM-A-S38-67A-G2	1490100 EAMF-A-38A-67A	551003 EAMC-30-32-6-9	3637942 EAMK-A-S38-38A/B-G2	567489 EAHM-L2-M5-55
1456650 EAMM-A-S48-40G-G2	4067069 EAMF-A-48B-40G	558029 EAMC-30-32-8-10	3637941 EAMK-A-S48-48A/B-G2	–
558164 EAMM-A-S48-55A	558177 EAMF-A-48B-55A	543423 EAMC-30-32-8-9	558172 EAMK-A-S48-48A/B	–
3637961 EAMM-A-S48-55A-G2	558177 EAMF-A-48B-55A	543423 EAMC-30-32-8-9	3637941 EAMK-A-S48-48A/B-G2	–
560687 EAMM-A-S48-57A	560694 EAMF-A-48B-57A	543421 EAMC-30-32-6.35-8	558172 EAMK-A-S48-48A/B	–
3637963 EAMM-A-S48-57A-G2	560694 EAMF-A-48B-57A	543421 EAMC-30-32-6.35-8	3637941 EAMK-A-S48-48A/B-G2	–
2256701 EAMM-A-S48-60G-G2	558019 EAMF-A-48A-60G/H	551004 EAMC-30-32-8-11	3637941 EAMK-A-S48-48A/B-G2	567489 EAHM-L2-M5-55
1456652 EAMM-A-S48-60H-G2	558019 EAMF-A-48A-60G/H	562682 EAMC-30-32-8-14	3637941 EAMK-A-S48-48A/B-G2	567489 EAHM-L2-M5-55
2220560 EAMM-A-S48-60P	2220620 EAMF-A-48A-60P	562682 EAMC-30-32-8-14	558172 EAMK-A-S48-48A/B	567489 EAHM-L2-M5-55
3637964 EAMM-A-S48-60P-G2	2220620 EAMF-A-48A-60P	562682 EAMC-30-32-8-14	3637941 EAMK-A-S48-48A/B-G2	567489 EAHM-L2-M5-55

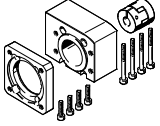
Axial kits EAMM-A

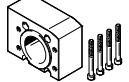
Technical data

Component parts				
Axial kit	Comprising:			
	Motor flange	Coupling	Coupling housing	Screw set
				
Part No. Type	Part No. Type	Part No. Type	Part No. Type	Part No. Type
558165 EAMM-A-S48-70A	558025 EAMF-A-48A-70A	551004 EAMC-30-32-8-11	558172 EAMK-A-S48-48A/B	567488 EAHM-L2-M5-50
3637957 EAMM-A-S48-70A-G2	558025 EAMF-A-48A-70A	551004 EAMC-30-32-8-11	3637941 EAMK-A-S48-48A/B-G2	567488 EAHM-L2-M5-50
560688 EAMM-A-S48-87A	560695 EAMF-A-48A-87A	551004 EAMC-30-32-8-11	558172 EAMK-A-S48-48A/B	567489 EAHM-L2-M5-55
3637962 EAMM-A-S48-87A-G2	560695 EAMF-A-48A-87A	551004 EAMC-30-32-8-11	3637941 EAMK-A-S48-48A/B-G2	567489 EAHM-L2-M5-55
2297649 EAMM-A-S62-60G-G2	1460112 EAMF-A-62A-60G/H	525864 EAMC-40-66-11-12	3637940 EAMK-A-S62-62A/B-G2	567495 EAHM-L2-M6-90
1456654 EAMM-A-S62-60H-G2	1460112 EAMF-A-62A-60G/H	1452803 EAMC-40-66-12-14	3637940 EAMK-A-S62-62A/B-G2	567495 EAHM-L2-M6-90
558166 EAMM-A-S62-70A	558179 EAMF-A-62B-70A	558313 EAMC-42-66-11-12	558173 EAMK-A-S62-62A/B	-
3637959 EAMM-A-S62-70A-G2	558179 EAMF-A-62B-70A	558313 EAMC-42-66-11-12	3637940 EAMK-A-S62-62A/B-G2	-
1972530 EAMM-A-S62-80G-G2	2116672 EAMF-A-62B-80G	2138701 EAMC-42-50-12-20	3637940 EAMK-A-S62-62A/B-G2	-
2222582 EAMM-A-S62-80P	2222624 EAMF-A-62B-80P	551005 EAMC-42-50-12-19	558173 EAMK-A-S62-62A/B	-
3637970 EAMM-A-S62-80P-G2	2222624 EAMF-A-62B-80P	551005 EAMC-42-50-12-19	3637940 EAMK-A-S62-62A/B-G2	-
560689 EAMM-A-S62-87A	560696 EAMF-A-62B-87A	558313 EAMC-42-66-11-12	558173 EAMK-A-S62-62A/B	-
3637966 EAMM-A-S62-87A-G2	560696 EAMF-A-62B-87A	558313 EAMC-42-66-11-12	3637940 EAMK-A-S62-62A/B-G2	-
558167 EAMM-A-S62-100A	558026 EAMF-A-62A-100A	551005 EAMC-42-50-12-19	558173 EAMK-A-S62-62A/B	567494 EAHM-L2-M6-80
3637960 EAMM-A-S62-100A-G2	558026 EAMF-A-62A-100A	551005 EAMC-42-50-12-19	3637940 EAMK-A-S62-62A/B-G2	567494 EAHM-L2-M6-80
558168 EAMM-A-S62-140A	558022 EAMF-A-62A-140A	558314 EAMC-42-50-12-24	558173 EAMK-A-S62-62A/B	567495 EAHM-L2-M6-90
3637969 EAMM-A-S62-140A-G2	558022 EAMF-A-62A-140A	558314 EAMC-42-50-12-24	3637940 EAMK-A-S62-62A/B-G2	567495 EAHM-L2-M6-90

Axial kits EAMM-A

Technical data

Dimensions and ordering data

Download CAD data → www.festo.com

EGSK-..., EGSP-...

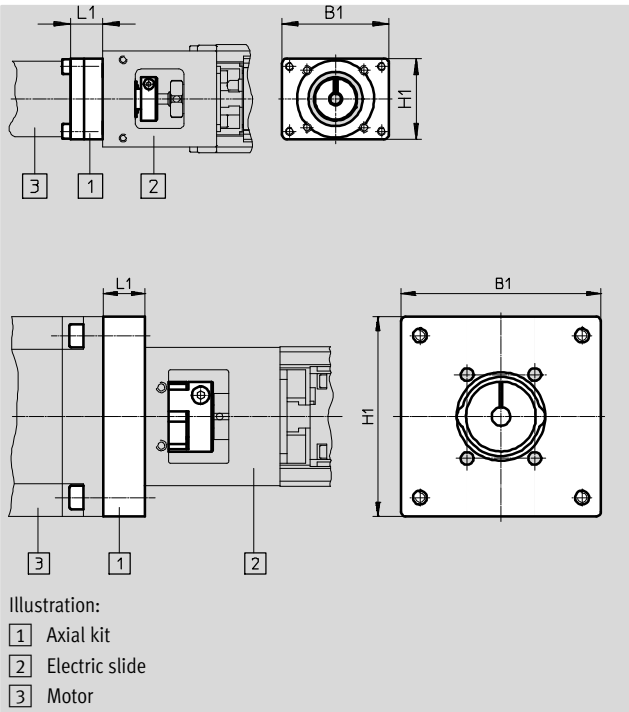

Type	B1	H1	L1
EAMM-A-P3-28D-28A	30	30	15
EAMM-A-P3-28D-40P	39.7	39.7	14.5
EAMM-A-P4-28B-28A	39.6	30	12
EAMM-A-P4-28B-40A	40	40	8.3
EAMM-A-P4-28B-40P	39.7	39.7	12.5
EAMM-A-P4-28B-42A	42	42	16.5
EAMM-A-P5-28B-28A	39.6	30	12
EAMM-A-P5-28B-40A	40	40	8.3
EAMM-A-P5-28B-40P	39.7	39.7	12.5
EAMM-A-P5-28B-42A	42	42	16.5
EAMM-A-P6-38A-40A	50	50	9
EAMM-A-P6-38A-40G	60	60	17
EAMM-A-P6-38A-40P	50	50	10.7
EAMM-A-P6-38A-42A	55	55	15
EAMM-A-P6-38A-55A	55	55	11
EAMM-A-P6-38A-57A	56	56	11
EAMM-A-P6-38A-60P	61.4	61.4	21
EAMM-A-P6-38A-67A	67	67	16
EAMM-A-P8-38A-40A	50	50	9
EAMM-A-P8-38A-40G	60	60	17
EAMM-A-P8-38A-40P	50	50	10.7
EAMM-A-P8-38A-42A	55	55	15
EAMM-A-P8-38A-55A	55	55	11
EAMM-A-P8-38A-57A	56	56	11
EAMM-A-P8-38A-60P	61.4	61.4	21
EAMM-A-P8-38A-67A	67	67	16
EAMM-A-P8-38A-70A	70	70	13.8
EAMM-A-P8-38A-87A	85.8	85.8	18
EAMM-A-P10-38A-40G	60	60	17
EAMM-A-P10-38A-55A	55	55	11
EAMM-A-P10-38A-57A	56	56	11
EAMM-A-P10-38A-60P	61.4	61.4	21
EAMM-A-P10-38A-67A	67	67	16
EAMM-A-P10-38A-70A	70	70	13.8
EAMM-A-P10-38A-87A	85.8	85.8	18

Axial kits EAMM-A

Technical data

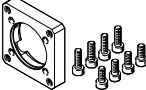
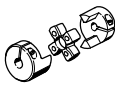
Component parts		
Axial kit	Comprising:	
	Motor flange	Coupling
		
Part No. Type	Part No. Type	Part No. Type
1703478 EAMM-A-P3-28D-28A	1087613 EAMF-A-28D-28A	562672 EAMC-16-20-3-5
1982886 EAMM-A-P3-28D-40P	1982014 EAMF-A-28D-40P	2310368 EAMC-16-20-3-8
1731466 EAMM-A-P4-28B-28A	1704476 EAMF-A-28B-28A	562674 EAMC-16-20-4-5
1983071 EAMM-A-P4-28B-40P	1976704 EAMF-A-28B-40P	562675 EAMC-16-20-4-8
562637 EAMM-A-P4-28B-40A	552163 EAMF-A-28B-40A	562673 EAMC-16-20-4-6
562636 EAMM-A-P4-28B-42A	552164 EAMF-A-28B-42A	562674 EAMC-16-20-4-5
1731474 EAMM-A-P5-28B-28A	1704476 EAMF-A-28B-28A	562676 EAMC-16-20-5-5
562641 EAMM-A-P5-28B-40A	552163 EAMF-A-28B-40A	543419 EAMC-16-20-5-6
1983122 EAMM-A-P5-28B-40P	1976704 EAMF-A-28B-40P	562677 EAMC-16-20-5-8
562640 EAMM-A-P5-28B-42A	552164 EAMF-A-28B-42A	562676 EAMC-16-20-5-5
562646 EAMM-A-P6-38A-40A	562667 EAMF-A-38A-40A	558312 EAMC-30-32-6-6
2297645 EAMM-A-P6-38A-40G	1460097 EAMF-A-38A-40G	562681 EAMC-30-32-6-10
1983450 EAMM-A-P6-38A-40P	1984478 EAMF-A-38A-40P	533708 EAMC-30-32-6-8
562644 EAMM-A-P6-38A-42A	562668 EAMF-A-38A-42A	561333 EAMC-30-32-5-6
562647 EAMM-A-P6-38A-55A	558176 EAMF-A-38A-55A	551003 EAMC-30-32-6-9
562645 EAMM-A-P6-38A-57A	560692 EAMF-A-38A-57A	551002 EAMC-30-32-6-6.35
2264375 EAMM-A-P6-38A-60P	1987412 EAMF-A-38A-60P	1233256 EAMC-30-32-6-14
2297641 EAMM-A-P6-38A-67A	1490100 EAMF-A-38A-67A	551003 EAMC-30-32-6-9

Axial kits EAMM-A

Technical data

FESTO

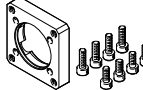
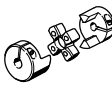
Component parts		
Axial kit	Comprising:	
	Motor flange	Coupling
		
Part No. Type	Part No. Type	Part No. Type
562652 EAMM-A-P8-38A-40A	562667 EAMF-A-38A-40A	533708 EAMC-30-32-6-8
2297646 EAMM-A-P8-38A-40G	1460097 EAMF-A-38A-40G	558029 EAMC-30-32-8-10
1986292 EAMM-A-P8-38A-40P	1984478 EAMF-A-38A-40P	543422 EAMC-30-32-8-8
562650 EAMM-A-P8-38A-42A	562668 EAMF-A-38A-42A	562678 EAMC-30-32-5-8
562653 EAMM-A-P8-38A-55A	558176 EAMF-A-38A-55A	543423 EAMC-30-32-8-9
562651 EAMM-A-P8-38A-57A	560692 EAMF-A-38A-57A	543421 EAMC-30-32-6.35-8
1987308 EAMM-A-P8-38A-60P	1987412 EAMF-A-38A-60P	562682 EAMC-30-32-8-14
2297643 EAMM-A-P8-38A-67A	1490100 EAMF-A-38A-67A	543423 EAMC-30-32-8-9
564996 EAMM-A-P8-38A-70A	558018 EAMF-A-38A-70A	551004 EAMC-30-32-8-11
564998 EAMM-A-P8-38A-87A	560693 EAMF-A-38A-87A	551004 EAMC-30-32-8-11
2297648 EAMM-A-P10-38A-40G	1460097 EAMF-A-38A-40G	2310372 EAMC-30-32-10-10
562659 EAMM-A-P10-38A-55A	558176 EAMF-A-38A-55A	562680 EAMC-30-32-9-10
562658 EAMM-A-P10-38A-57A	560692 EAMF-A-38A-57A	562679 EAMC-30-32-6.35-10
2036017 EAMM-A-P10-38A-60P	1987412 EAMF-A-38A-60P	562683 EAMC-30-32-10-14
2297644 EAMM-A-P10-38A-67A	1490100 EAMF-A-38A-67A	562680 EAMC-30-32-9-10
564997 EAMM-A-P10-38A-70A	558018 EAMF-A-38A-70A	565008 EAMC-30-32-10-11
564999 EAMM-A-P10-38A-87A	560693 EAMF-A-38A-87A	565008 EAMC-30-32-10-11

Axial kits EAMM-A

Technical data

FESTO

Dimensions and ordering data

Download CAD data → www.festo.com

ELGG-..., ELGR-...

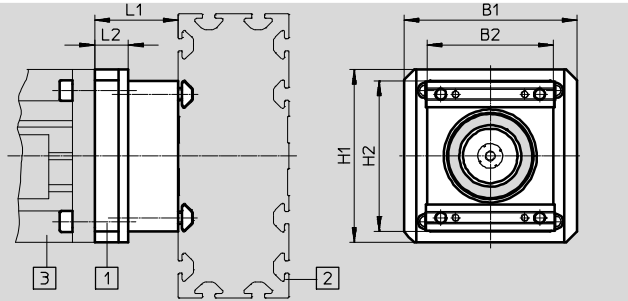

Illustration:





- 1 Axial kit
- 2 Toothed belt axis
- 3 Motor

Type	B1	B2	H1	H2	L1	L2
EAMM-A-R27-40G	55	44.5	55	48.3	26	11
EAMM-A-R27-55A	55	44.5	55	48.3	26	11
EAMM-A-R27-57A	56	44.5	56	48.3	26	11
EAMM-A-R27-67A	67	44.5	67	48.3	31	16
EAMM-A-R38-40G	60	51	60	61	37	17
EAMM-A-R38-57A	56	-	-	-	31	-
EAMM-A-R38-60G	60	51	60	61	46	26
EAMM-A-R38-60H	60	51	60	61	46	26
EAMM-A-R38-60P	61.4	51	61.4	61	41	21
EAMM-A-R38-70A	70	51	70	61	33.8	13.8
EAMM-A-R38-87A	85.8	51	85.8	61	38	18
EAMM-A-R48-60G	60	55	60	81	52.5	24.5
EAMM-A-R48-60H	60	55	60	51	52.5	24.5
EAMM-A-R48-70A	70	-	-	-	40.2	-
EAMM-A-R48-80P	81.3	55	81.3	81	54	26
EAMM-A-R48-87A	85.5	55	85.5	81	44	16
EAMM-A-R48-100A	100.5	55	100.5	81	59	31

Axial kits EAMM-A

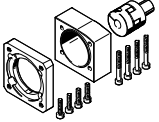
Technical data

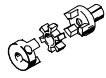
FESTO

Component parts			
Axial kit	Comprising:		
	Motor flange	Coupling	Coupling housing
			
Part No. Type	Part No. Type	Part No. Type	Part No. Type
1456622 EAMM-A-R27-40G	1460097 EAMF-A-38A-40G	557998 EAMD-19-15-10-8X10	1133397 EAMK-A-R27-38A
1133400 EAMM-A-R27-55A	558176 EAMF-A-38A-55A	557999 EAMD-19-15-9-8X10	1133397 EAMK-A-R27-38A
1133403 EAMM-A-R27-57A	560692 EAMF-A-38A-57A	561292 EAMD-16-15-6.35-8X10	1133397 EAMK-A-R27-38A
1456619 EAMM-A-R27-67A	1490100 EAMF-A-38A-67A	557999 EAMD-19-15-9-8X10	1133397 EAMK-A-R27-38A
1456623 EAMM-A-R38-40G	1460097 EAMF-A-38A-40G	1453860 EAMD-25-22-10-10X12	1133398 EAMK-A-R38-38A
1578138 EAMM-A-R38-57A	560692 EAMF-A-38A-57A	561293 EAMD-25-22-6.35-10X12	1133398 EAMK-A-R38-38A
2310075 EAMM-A-R38-60G	558017 EAMF-A-38A-60G/H	558000 EAMD-25-22-11-10X12	1133398 EAMK-A-R38-38A
1456630 EAMM-A-R38-60H	558017 EAMF-A-38A-60G/H	1453861 EAMD-28-22-14-10X12	1133398 EAMK-A-R38-38A
2224996 EAMM-A-R38-60P	1987412 EAMF-A-38A-60P	1453861 EAMD-28-22-14-10X12	1133398 EAMK-A-R38-38A
1133401 EAMM-A-R38-70A	558018 EAMF-A-38A-70A	558000 EAMD-25-22-11-10X12	1133398 EAMK-A-R38-38A
1133404 EAMM-A-R38-87A	560693 EAMF-A-38A-87A	558000 EAMD-25-22-11-10X12	1133398 EAMK-A-R38-38A
2374780 EAMM-A-R48-60G	558019 EAMF-A-48A-60G/H	558001 EAMD-32-32-11-16X20	1133399 EAMK-A-R48-48A
1456633 EAMM-A-R48-60H	558019 EAMF-A-48A-60G/H	1377840 EAMD-32-32-14-16X20	1133399 EAMK-A-R48-48A
1578139 EAMM-A-R48-70A	558025 EAMF-A-48A-70A	558001 EAMD-32-32-11-16X20	1133399 EAMK-A-R48-48A
2225090 EAMM-A-R48-80P	2043427 EAMF-A-48A-80P	558002 EAMD-42-40-19-16X25	1133399 EAMK-A-R48-48A
1133405 EAMM-A-R48-87A	560695 EAMF-A-48A-87A	558001 EAMD-32-32-11-16X20	1133399 EAMK-A-R48-48A
1133402 EAMM-A-R48-100A	558020 EAMF-A-48A-100A	558002 EAMD-42-40-19-16X25	1133399 EAMK-A-R48-48A

Axial kits EAMM-A

Technical data

FESTO

Dimensions and ordering data

Download CAD data → www.festo.com

DGEA-...

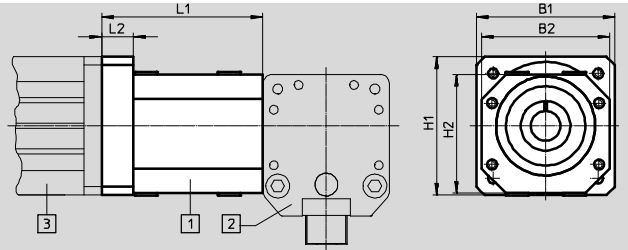

Illustration:

- 1 Axial kit
- 2 Cantilever axis
- 3 Motor

Type	B1	B2	H1	H2	L1	L2
EAMM-A-F28-40G	50	45	50	45	57.7	17.7
EAMM-A-F28-57A	56.4	45	56.4	45	52.7	12
EAMM-A-F28-60G	60	45	60	45	60.7	20
EAMM-A-F28-60H	60	45	60	45	60.7	20
EAMM-A-F28-87A	85.8	45	85.8	45	56.2	15.5
EAMM-A-F32-60G	70	65	70	60	89.4	24
EAMM-A-F32-60H	70	65	70	60	89.4	24
EAMM-A-F32-87A	85.8	65	85.8	60	82.7	17.5
EAMM-A-F40-80G	90	65	90	60	89.4	24

Component parts

Axial kit	Comprising:		
	Motor flange	Coupling	Coupling housing
Part No. Type	Part No. Type	Part No. Type	Part No. Type
1454251 EAMM-A-F28-40G	550986 EAMF-A-44A/B-40G	123050 EAMC-30-35-8-10	530468 EAMK-A-F28-44A
550956 EAMM-A-F28-57A	530081 EAMF-A-44A/B-57A	530088 EAMC-30-35-6.35-8	530468 EAMK-A-F28-44A
550957 EAMM-A-F28-60G	529944 EAMF-A-44A/B-60G	123042 EAMC-30-35-8-11	530468 EAMK-A-F28-44A
1454252 EAMM-A-F28-60H	1780430 EAMF-A-44A-60G/H	1453063 EAMC-30-35-8-14	530468 EAMK-A-F28-44A
550958 EAMM-A-F28-87A	530082 EAMF-A-44A/B-87A	123042 EAMC-30-35-8-11	530468 EAMK-A-F28-44A
550959 EAMM-A-F32-60G	550987 EAMF-A-64A/B-60G/H	530090 EAMC-40-66-11-11	530469 EAMK-A-F32-64A
1454256 EAMM-A-F32-60H	550987 EAMF-A-64A/B-60G/H	1452798 EAMC-40-66-11-14	530469 EAMK-A-F32-64A
550960 EAMM-A-F32-87A	533140 EAMF-A-64A/B-87A	530090 EAMC-40-66-11-11	530469 EAMK-A-F32-64A
550935 EAMM-A-F40-80G	533139 EAMF-A-64A/C-80G	123845 EAMC-40-66-15-20	124629 EAMK-A-F40-64A

Axial kits EAMM-A

Accessories

FESTO

Seal set

Contains PWIS (paint-wetting impairment substances)

RoHS-compliant



Ordering data						
Type	For axial kit	For electric cylinder	Ambient temperature [°C]	CRC ¹⁾	Part No.	Type
EADS-F-D32-40A	EAMM-A-D32-40A	ESBF	-25 ... +60	4	1561526	EADS-F-D32-40A
EADS-F-D32-40G	EAMM-A-D32-40G				2253500	EADS-F-D32-40G
EADS-F-D32-40P	EAMM-A-D32-40P				2207219	EADS-F-D32-40P
EADS-F-D32-60G/H	EAMM-A-D32-60G				8022150	EADS-F-D32-60G/H
	EAMM-A-D32-60H					
EADS-F-D32-60P	EAMM-A-D32-60P				2234012	EADS-F-D32-60P
EADS-F-D32-67A	EAMM-A-D32-67A				2253501	EADS-F-D32-67A
EADS-F-D32-42A	EAMM-A-D32-42A				1561527	EADS-F-D32-42A
EADS-F-D32-55A	EAMM-A-D32-55A				1561528	EADS-F-D32-55A
EADS-F-D32-57A	EAMM-A-D32-57A				1561529	EADS-F-D32-57A
EADS-F-D40-40G	EAMM-A-D40-40G				2253502	EADS-F-D40-40G
	EAMM-A-D40-55A					
EADS-F-D40-57A	EAMM-A-D40-57A				1561530	EADS-F-D40-55A
EADS-F-D40-60G/H	EAMM-A-D40-60G				1561531	EADS-F-D40-57A
	EAMM-A-D40-60H					
EADS-F-D40-60P	EAMM-A-D40-60P				2253503	EADS-F-D40-60G/H
EADS-F-D40-67A	EAMM-A-D40-67A				2151545	EADS-F-D40-60P
EADS-F-D40-70A	EAMM-A-D40-70A				2253504	EADS-F-D40-67A
EADS-F-D40-87A	EAMM-A-D40-87A				1561532	EADS-F-D40-70A
EADS-F-D50-60G/H	EAMM-A-D50-60G				1561533	EADS-F-D40-87A
	EAMM-A-D50-60H					
EADS-F-D50-70A	EAMM-A-D50-70A				2733792	EADS-F-D50-60G/H
EADS-F-D50-80G	EAMM-A-D50-80G				2733789	EADS-F-D50-70A
EADS-F-D50-80P	EAMM-A-D50-80P				2733793	EADS-F-D50-80G
EADS-F-D50-87A	EAMM-A-D50-87A				2733791	EADS-F-D50-80P
EADS-F-D50-100A	EAMM-A-D50-100A				2733788	EADS-F-D50-87A
EADS-F-D60-70A	EAMM-A-D60-70A				2733790	EADS-F-D50-100A
EADS-F-D60-80G	EAMM-A-D60-80G				8022145	EADS-F-D60-70A
EADS-F-D60-60G/H	EAMM-A-D60-60G				8022146	EADS-F-D60-80G
	EAMM-A-D60-60H					
EADS-F-D60-80P	EAMM-A-D60-80P				2253505	EADS-F-D60-60G/H
EADS-F-D60-87A	EAMM-A-D60-87A				2218523	EADS-F-D60-80P
EADS-F-D60-100A	EAMM-A-D60-100A	1561536	EADS-F-D60-87A			
EADS-F-D80-80G	EAMM-A-D80-80G	2253507	EADS-F-D60-100A			
EADS-F-D80-100A	EAMM-A-D80-100A	8022147	EADS-F-D80-80G			
EADS-F-D80-140A	EAMM-A-D80-140A	1593617	EADS-F-D80-100A			
EADS-F-D100-100A	EAMM-A-D100-100A	1593671	EADS-F-D80-140A			
EADS-F-D100-120G	EAMM-A-D100-120G	3356966	EADS-F-D100-100A			
EADS-F-D100-140A	EAMM-A-D100-140A	8022148	EADS-F-D100-120G			
		1593991	EADS-F-D100-140A			

1) Corrosion resistance class CRC 4 to Festo standard FN 940070
 Particularly high corrosion stress. Outdoor exposure under extreme corrosive conditions. Parts exposed to aggressive media, for instance in the chemical or food industries. These applications may need to be supported by special tests (→ also FN 940082) using appropriate media.

Product Range and Company Overview

A Complete Suite and Company Overview

Our experienced engineers provide complete support at every stage of your development process, including: conceptualization, analysis, engineering, design, assembly, documentation, validation, and production.



Custom Automation Components
Complete custom engineered solutions



Custom Control Cabinets
Comprehensive engineering support and on-site services



Complete Systems
Shipment, stocking and storage services

The Broadest Range of Automation Components

With a comprehensive line of more than 30,000 automation components, Festo is capable of solving the most complex automation requirements.



Electromechanical
Electromechanical actuators, motors, controllers & drivers



Pneumatics
Pneumatic linear and rotary actuators, valves, and air supply



PLCs and I/O Devices
PLC's, operator interfaces, sensors and I/O devices

Supporting Advanced Automation... As No One Else Can!

Festo is a leading global manufacturer of pneumatic and electromechanical systems, components and controls for industrial automation, with more than 16,000 employees in 60 national headquarters serving more than 180 countries. For more than 80 years, Festo has continuously elevated the state of manufacturing with innovations and optimized motion control solutions that deliver higher performing, more profitable automated manufacturing and processing equipment. Our dedication to the advancement of automation extends beyond technology to the education and development of current and future automation and robotics designers with simulation tools, teaching programs, and on-site services.

Quality Assurance, ISO 9001 and ISO 14001 Certifications

Festo Corporation is committed to supply all Festo products and services that will meet or exceed our customers' requirements in product quality, delivery, customer service and satisfaction.

To meet this commitment, we strive to ensure a consistent, integrated, and systematic approach to management that will meet or exceed the requirements of the ISO 9001 standard for Quality Management and the ISO 14001 standard for Environmental Management.



© Copyright 2013, Festo Corporation. While every effort is made to ensure that all dimensions and specifications are correct, Festo cannot guarantee that publications are completely free of any error, in particular typing or printing errors. Accordingly, Festo cannot be held responsible for the same. For Liability and Warranty conditions, refer to our "Terms and Conditions of Sale", available from your local Festo office. All rights reserved. No part of this publication may be reproduced, distributed, or transmitted in any form or by any means, electronic, mechanical, photocopying or otherwise, without the prior written permission of Festo. All technical data subject to change according to technical update.



Printed on recycled paper at New Horizon Graphic, Inc., FSC certified as an environmental friendly printing plant.

Festo North America



**1 Festo Canada
Headquarters
Festo Inc.**
5300 Explorer Drive
Mississauga, ON
L4W 5G4

2 Montréal
5600, Trans-Canada
Pointe-Claire, QC
H9R 1B6

3 Québec City
2930, rue Watt#117
Québec, QC
G1X 4G3



**4 Festo United States
Headquarters
Festo Corporation**
395 Moreland Road
Hauppauge, NY
11788

5 Appleton
North 922 Tower View Drive, Suite N
Greenville, WI
54942

7 Detroit
1441 West Long Lake Road
Troy, MI
48098

6 Chicago
85 W Algonquin - Suite 340
Arlington Heights, IL
60005

8 Silicon Valley
4935 Southfront Road, Suite F
Livermore, CA
94550

Festo Regional Contact Center

Canadian Customers

Commercial Support:
Tel: 1 877 GO FESTO (1 877 463 3786)
Fax: 1 877 FX FESTO (1 877 393 3786)
Email: festo.canada@ca.festo.com

Technical Support:
Tel: 1 866 GO FESTO (1 866 463 3786)
Fax: 1 877 FX FESTO (1 877 393 3786)
Email: technical.support@ca.festo.com

USA Customers

Commercial Support:
Tel: 1 800 99 FESTO (1 800 993 3786)
Fax: 1 800 96 FESTO (1 800 963 3786)
Email: customer.service@us.festo.com

Technical Support:
Tel: 1 866 GO FESTO (1 866 463 3786)
Fax: 1 800 96 FESTO (1 800 963 3786)
Email: product.support@us.festo.com

Subject to change

Internet: www.festo.com/us