

Radial grippers DHRS



Radial grippers DHRS

Key features

At a glance

General information

- Lateral gripper jaw support for high torque loads
- Self-centring
- Gripper jaw centring options
- Max. repetition accuracy
- Gripping force retention
- Internal fixed flow control
- Wide range of options for mounting on drive units

- Sensor technology:
 - Adaptable position sensor for the small gripper sizes
 - Integratable proximity sensors for the medium and large gripper sizes

Flexible range of applications

- Can be used as a double-acting and single-acting gripper
- Compression spring for supplementary or retaining gripping forces
- Suitable for external and internal gripping

The technology in detail

Gripper closed

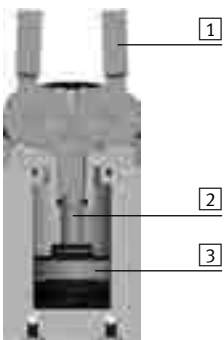

Gripper open



- 1 Gripper jaw
- 2 Slotted guide plate
- 3 Piston with magnet



Note

Gripper selection sizing software

→ www.festo.com

Position sensing/force control

With position transmitter SMAT-8M, SDAT



Analogue positional feedback possible

- Analogue output
 - 0 ... 10 V
 - 4... 20 mA

With proportional pressure regulator VPPM



Infinite adjustment of the gripping force possible

- Setpoint input
 - 0 ... 10 V
 - 4 ... 20 mA

With proximity sensor SMT-8G



Multiple positions can be sensed:

- Open
- Closed
- Workpiece gripped

Radial grippers DHRS

Key features

Supply ports

At the side

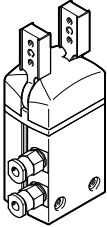

Mounting options

At the side

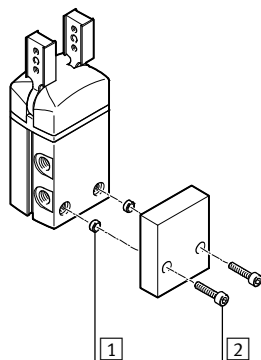
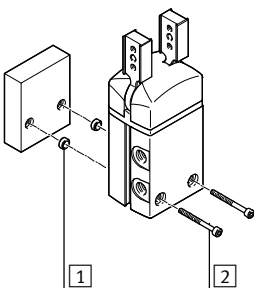

From underneath

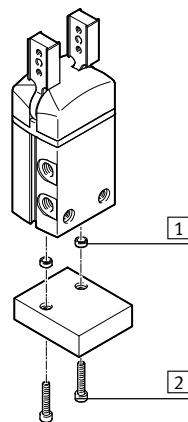

- 1 Centring sleeves
- 2 Mounting screws

Mounting options for external gripper fingers

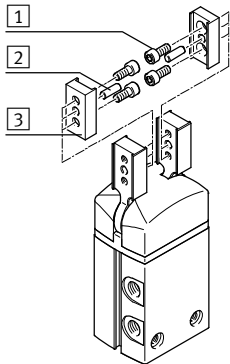

- 1 Mounting screws
- 2 Centring pins
- 3 Gripper fingers

- Note

These grippers are not designed for the following or similar sample applications:

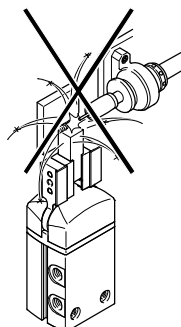

- Welding spatter

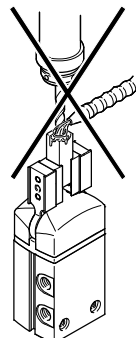

- Machining
- Aggressive media

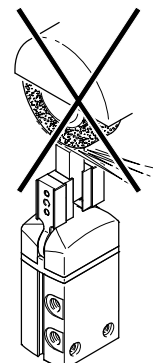

- Grinding dust

Radial grippers DHRS

Peripherals overview

Peripherals overview

DHRS-10

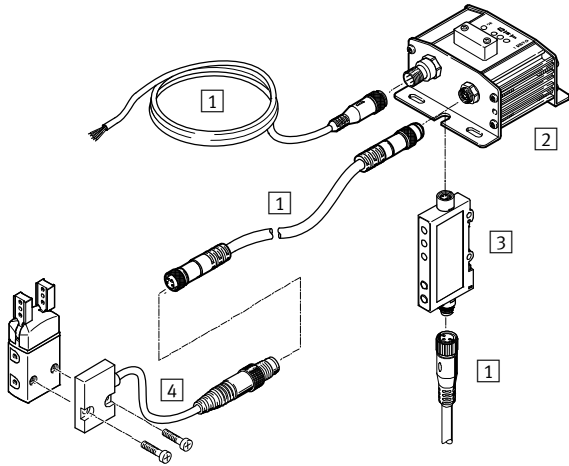

DHRS-16 ... 40

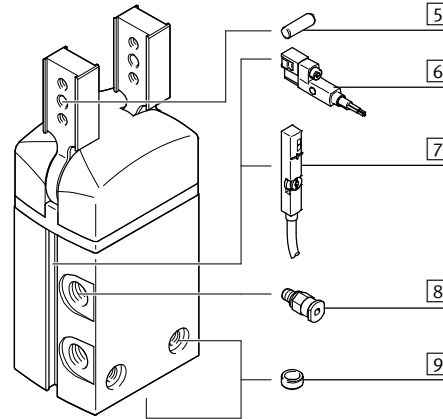

System product for handling and assembly technology

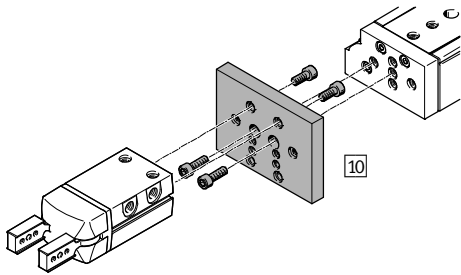

Proportional pressure regulator VPPM

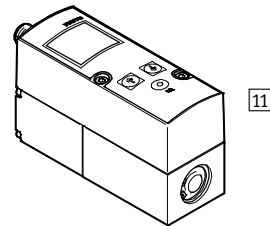

Radial grippers DHRS

Peripherals overview

Accessories				
	Type	Size	Description	→ Page/Internet
1	Connecting cable NEBU	10 ... 40	For connecting evaluation unit and signal converter	21
2	Evaluation unit SMH-AE1	10	<ul style="list-style-type: none"> For evaluating signals for position sensor SMH-S1 	21
3	Signal converter SVE4	10	<ul style="list-style-type: none"> For evaluating signals for position sensor SMH-S1 	21
4	Position sensor SMH-S1	10	<ul style="list-style-type: none"> Adaptable and integratable sensor technology, for sensing the piston position 	21
5	Centring pin	10 ... 40	For centring the gripper fingers on the gripper jaws	–
6	Proximity sensor SMT-8G	16 ... 40	<ul style="list-style-type: none"> For sensing the piston position Proximity sensor does not project past the housing at the bottom 	22
7	Position transmitter SMAT-8M	16 ... 40	<ul style="list-style-type: none"> Continuously senses the position of the piston. Has an analogue output with an output signal in proportion to the piston position 	22
	Position transmitter SDAT			
8	Push-in fitting QS	10 ... 40	For connecting compressed air tubing with standard O.D.	quick star
9	Centring sleeve ZBH	10 ... 40	<ul style="list-style-type: none"> For centring the gripper during mounting The scope of delivery of the gripper includes 2 centring sleeves 	21
10	Adapter kit DHAA, HMSV, HAPG, HAPS, HMVA	10 ... 40	Connecting plate between drive and gripper	16
11	Proportional pressure regulator VPPM	10 ... 40	For infinite adjustment of the gripping force	vppm

Radial grippers DHRS

Type codes

		DHRS	-	16	-	A	-	
Type								
DHRS	Radial gripper							
Size								
Position sensing								
A	Via proximity sensor							
Gripping force retention								
NC	Closing							

Radial grippers DHRS

Technical data

FESTO

Function
Double-acting
DHRS-...-A

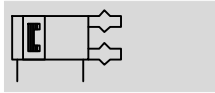

Size
10 ... 40 mm

Opening angle
180°

www.festo.com

Function – Variants
Single-acting or
with gripping force retention ...
... closing DHRS-...-NC



General technical data					
Size	10	16	25	32	40
Design	Forced motion sequence				
Mode of operation	Double-acting				
Gripper function	Radial				
Guide	Plain-bearing guide				
Gripping force retention	–	NC	NC	NC	NC
Number of gripper jaws	2				
Opening angle per gripper jaw	90				
Pneumatic connection	M3	M3	M5	G1/8	G1/8
Repetition accuracy ¹⁾	≤ 0.1				
Max. interchangeability	≤ ±0.2				
Max. operating frequency	4		3		2
Rotational symmetry	≤ ∅ 0.2				
Position sensing	Via position sensor		Via proximity sensor, position transmitter		
Type of mounting	Via through-hole and centring sleeve				
	Via female thread and centring sleeve				
Mounting position	Any				

1) End-position drift under constant conditions of use with 100 consecutive strokes in the direction of movement of the gripper jaws

Operating and environmental conditions					
Size	10	16	25	32	40
Min. operating pressure					
DHRS-...-A	[bar] 2				
DHRS-...-A-NC	[bar] –		4		
Max. operating pressure	[bar] 8				
Operating medium	Compressed air in accordance with ISO 8573-1:2010 [7:4:4]				
Note on operating/pilot medium	Operation with lubricated medium possible (in which case lubricated operation will always be required)				
Ambient temperature ¹⁾	[°C] +5 ... +60				
Corrosion resistance class CRC ²⁾	1				

1) Note operating range of proximity sensors

2) Corrosion resistance class CRC 1 to Festo standard FN 940070

Low corrosion stress. For dry indoor applications or transport and storage protection. Also applies to parts behind covers, in the non-visible interior area, and parts which are covered in the application (e.g. drive trunnions).

Weight [g]					
Size	10	16	25	32	40
DHRS-...-A	44	114	270	480	829
DHRS-...-A-NC	–	118	277	490	844

Radial grippers DHRS

Technical data

Materials

Sectional view

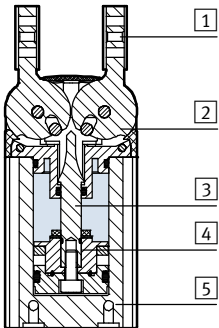

Radial gripper

1	Gripper jaw	High-alloy stainless steel
2	Cover cap	Polyamide
3	Slotted guide plate	Tempered steel
4	Piston	Polyacetal
5	Housing	Hard anodised wrought aluminium alloy
-	Seals	Nitrile rubber
-	Note on materials	Free of copper and PTFE RoHS-compliant

Total gripping torque [Ncm] at 6 bar

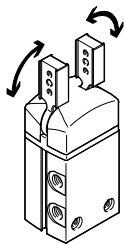

The gripping torque is not constant within the opening angle → 12.

Size	10	16	25	32	40	
DHRS-...-A	Opening	21	62	233	423	725
	Closing	15	55	215	390	660

Static characteristic load values at the gripper jaws

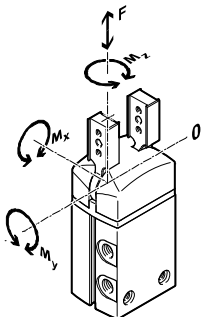

The indicated permissible forces and torques apply to a single gripper jaw. They include the lever arm, additional applied loads due to the workpiece or external gripper fingers and accelera-

tion forces occurring during movement.

The zero coordinate line (gripper jaw guide) must be taken into consideration for the calculation of torques.

Size		10	16	25	32	40
Max. permissible force F_z	[N]	30	40	75	120	200
Max. permissible torque M_x	[Nm]	0.8	1.3	3.2	6.2	14
Max. permissible torque M_y	[Nm]	0.8	1.3	3.2	6.2	14
Max. permissible torque M_z	[Nm]	0.8	1.3	3.2	6.2	14

Mass moment of inertia [$\text{kgm}^2 \times 10^{-4}$]

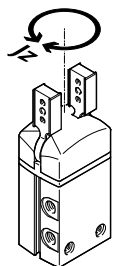

Mass moment of inertia of the radial gripper in relation to the central axis, without external gripper fingers, without load.

Size	10	16	25	32	40
DHRS-...-A	0.03	0.14	0.69	1.66	4.18
DHRS-...-A-NC	-	0.15	0.71	1.69	4.24

Radial grippers DHRS

Technical data

Opening and closing times [ms] at 6 bar

Without external gripper fingers

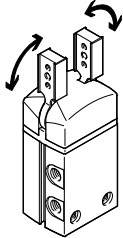

The indicated opening and closing times [ms] were measured at room temperature at an operating pressure of 6 bar with horizontally mounted grippers without additional gripper

fingers (average values). The grippers must be throttled for greater applied loads. Opening and closing times must then be adjusted accordingly.

Size		10	16	25	32	40
Without external gripper fingers						
DHRS...-A	Opening	35	61	102	111	113
	Closing	91	63	105	119	142
DHRS...-A-NC	Opening	-	75	150	131	151
	Closing	-	43	96	88	110

Opening and closing times t to be set at 6 bar as a function of mass moment of inertia of the gripper fingers

DHRS-10

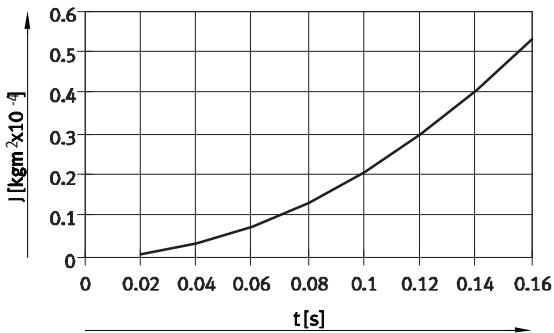

DHRS-16

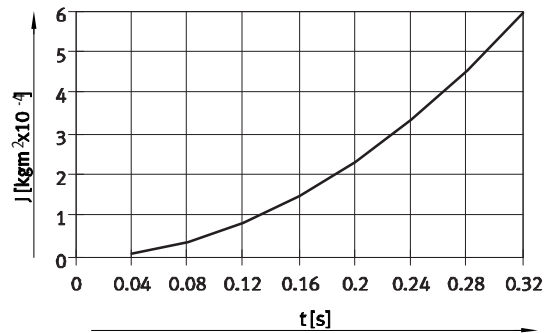

DHRS-25

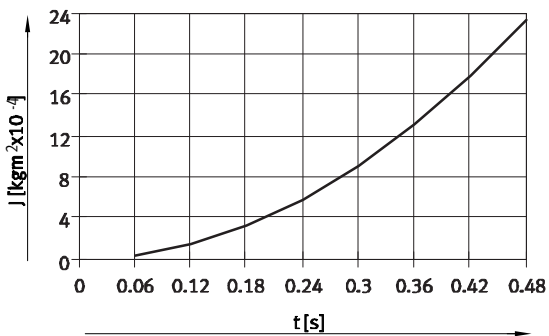

DHRS-32

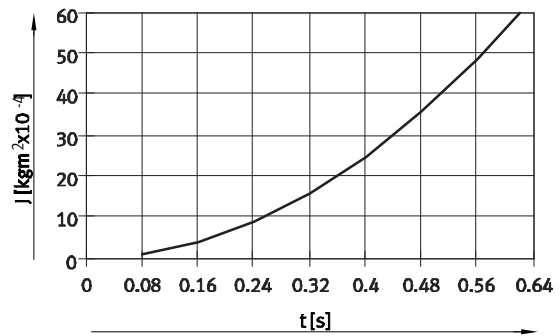

DHRS-40

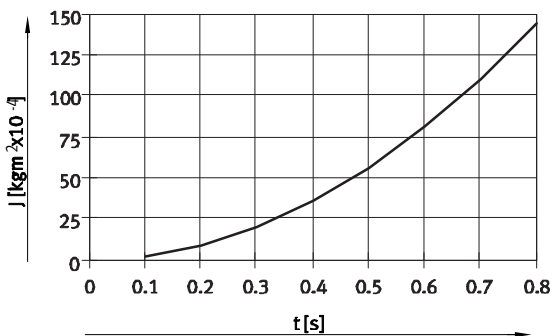

Radial grippers DHRS

Technical data

Gripping force F_H per gripper jaw as a function of operating pressure and lever arm x

The gripping forces as a function of operating pressure and lever arm can be determined from the following graphs.

The gripping torque is not constant within the opening angle $\rightarrow 12$.

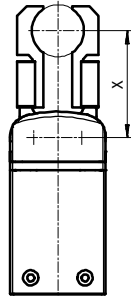

Note
Gripper selection
sizing software
www.festo.com

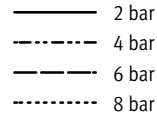

External gripping (closing)

DHRS-10

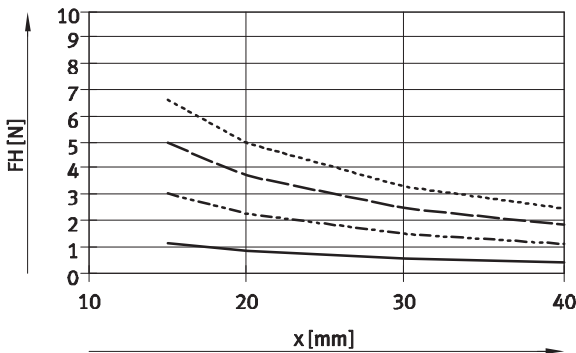

DHRS-16

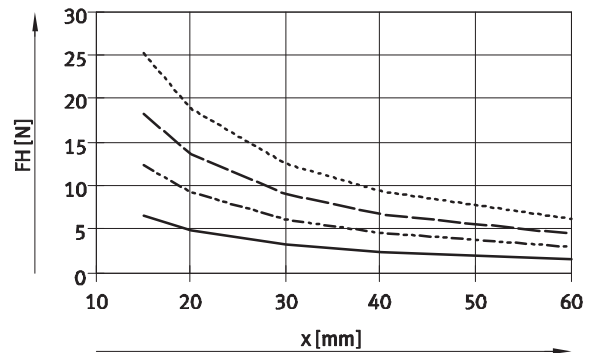

DHRS-25

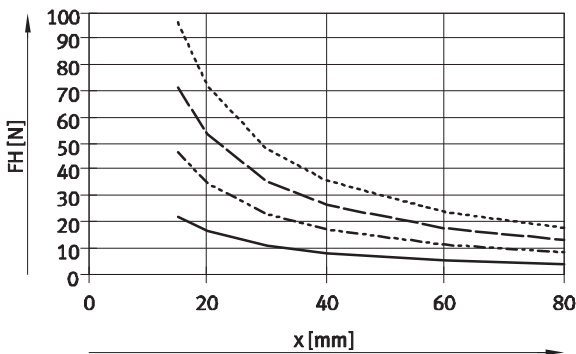

DHRS-32

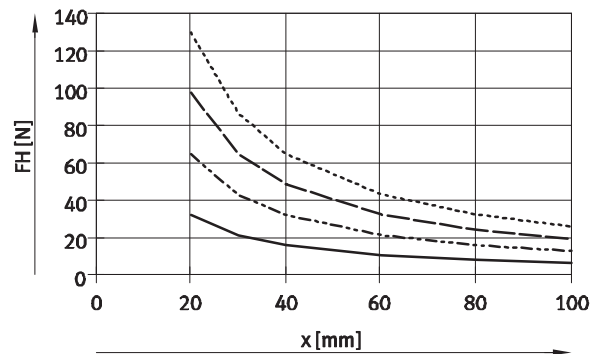

DHRS-40

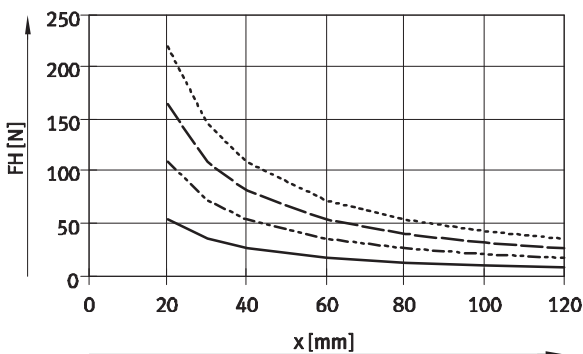

Radial grippers DHRS

Technical data

Gripping force F_H per gripper jaw as a function of operating pressure and lever arm x

The gripping forces as a function of operating pressure and lever arm can be determined from the following graphs.

The gripping torque is not constant within the opening angle → 12.

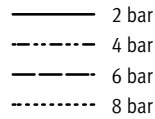
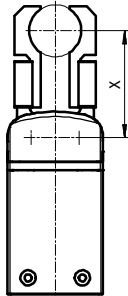

Note
Gripper selection
sizing software
→ www.festo.com

Internal gripping (opening)

DHRS-10

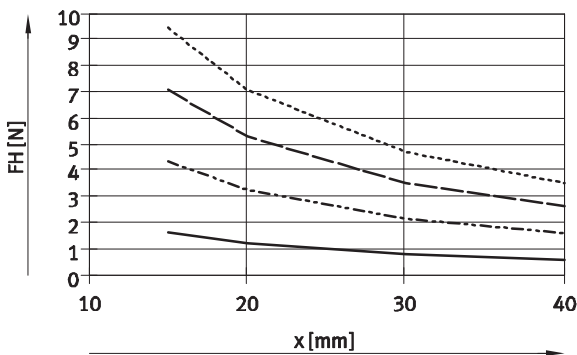

DHRS-16

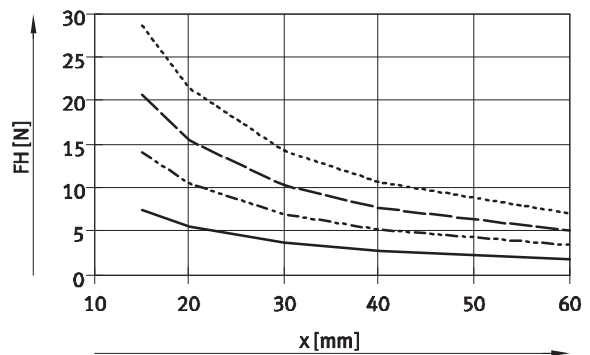

DHRS-25

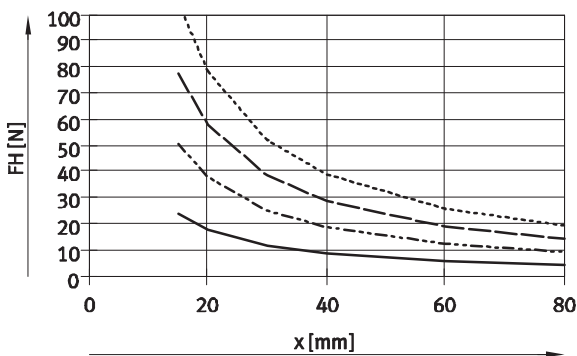

DHRS-32

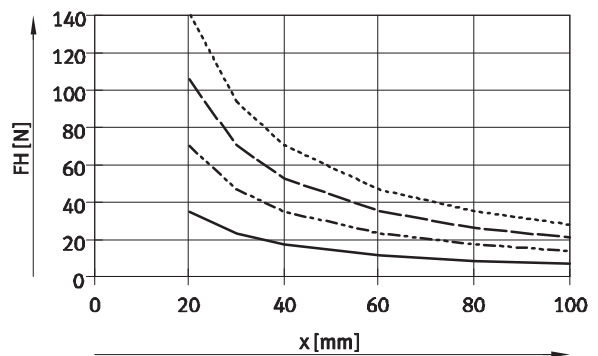

DHRS-40

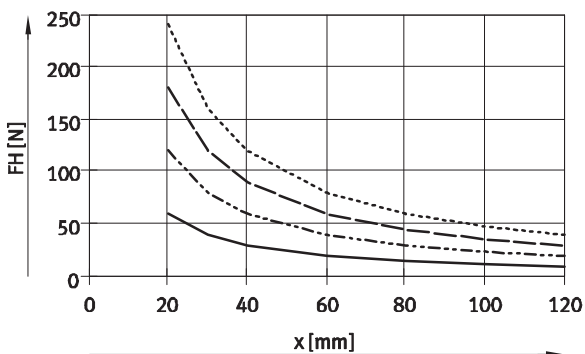

Radial grippers DHRS

Technical data

Gripping force F_H per gripper jaw at 6 bar as a function of lever arm x and eccentricity a and b

The following formula must be used to calculate the lever arm x with eccentric gripping:

$$x = \sqrt{a^2 + b^2}$$

The gripping force F_H can be read from the graphs (→ 10/11) using the calculated value x .

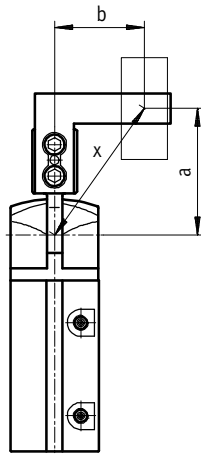

Calculation example

Given:

Distance $a = 25$ mm

Distance $b = 20$ mm

To be calculated:

The gripping force at 6 bar, with a DHRS-16, used as an external gripper

Procedure:

Calculating the lever arm x

$$x = \sqrt{25^2 + 20^2}$$

$$x = 32$$
 mm

The graph (→ 10) gives a value of F_H

= 8 N for the gripping force.

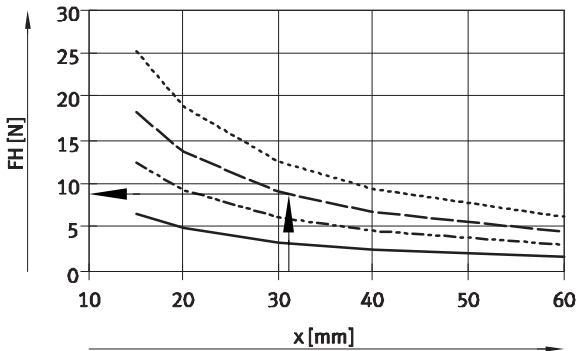

Torque curve M as a function of opening angle α

The drive principle of the gripper jaws means that the torque is not constant within the opening angle. The percentage of torque available in each case can be seen in the graph.

An opening angle of 0° means a parallel gripper jaw position.

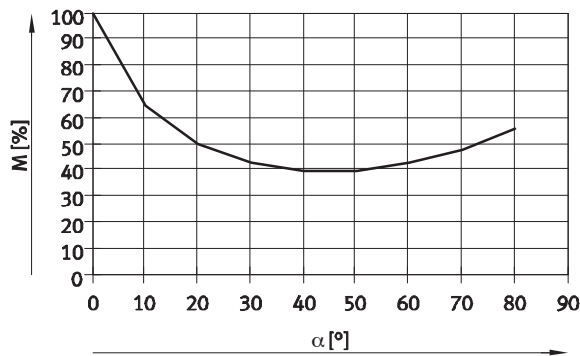

Radial grippers DHRS

Technical data

Spring torque M_F as a function of opening angle α

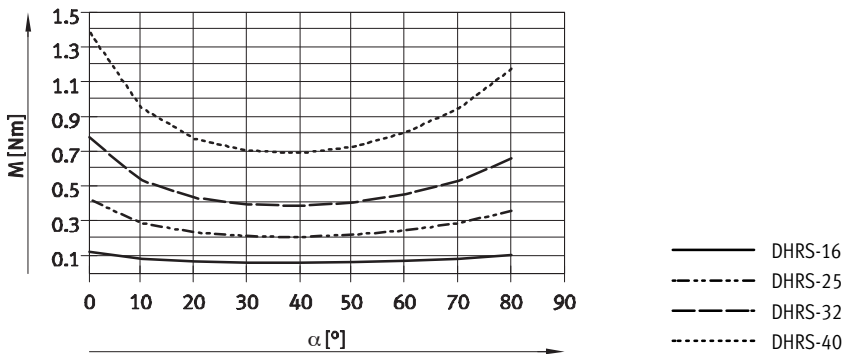

Determination of the actual gripping torques $M_{Grtotal}$ for DHRS-...-NC as a function of application

The radial gripper with integrated spring type DHRS-...-NC (closing gripping force retention) can be used as:

- single-acting grippers
- grippers with supplementary gripping force and
- grippers with gripping force retention depending on requirements.

In order to calculate the available gripping torque $M_{Grtotal}$ (per gripper jaw), the data from the graphs for the gripping force F_H (→ 10/11), the

torque curve (→ 12) and the spring torque M_F (→ 13) must be combined accordingly.

$$M_{Gr} = F_H * x * M \text{ [%]}$$

M_{Gr} Gripping torque
 F_H Gripping force
 x Lever arm
 M Torque curve

Application

Single-acting

- Gripping with spring force:
 $M_{Grtotal} = M_F$
- Gripping with pressure force:
 $M_{Grtotal} = M_{Gr} - M_F$

Supplementary gripping force

- Gripping with pressure and spring force:
 $M_{Grtotal} = M_{Gr} + M_F$

Gripping force retention

- Gripping with spring force:
 $M_{Grtotal} = M_F$

Radial grippers DHRS

Technical data

FESTO

Dimensions

Download CAD data → www.festo.com

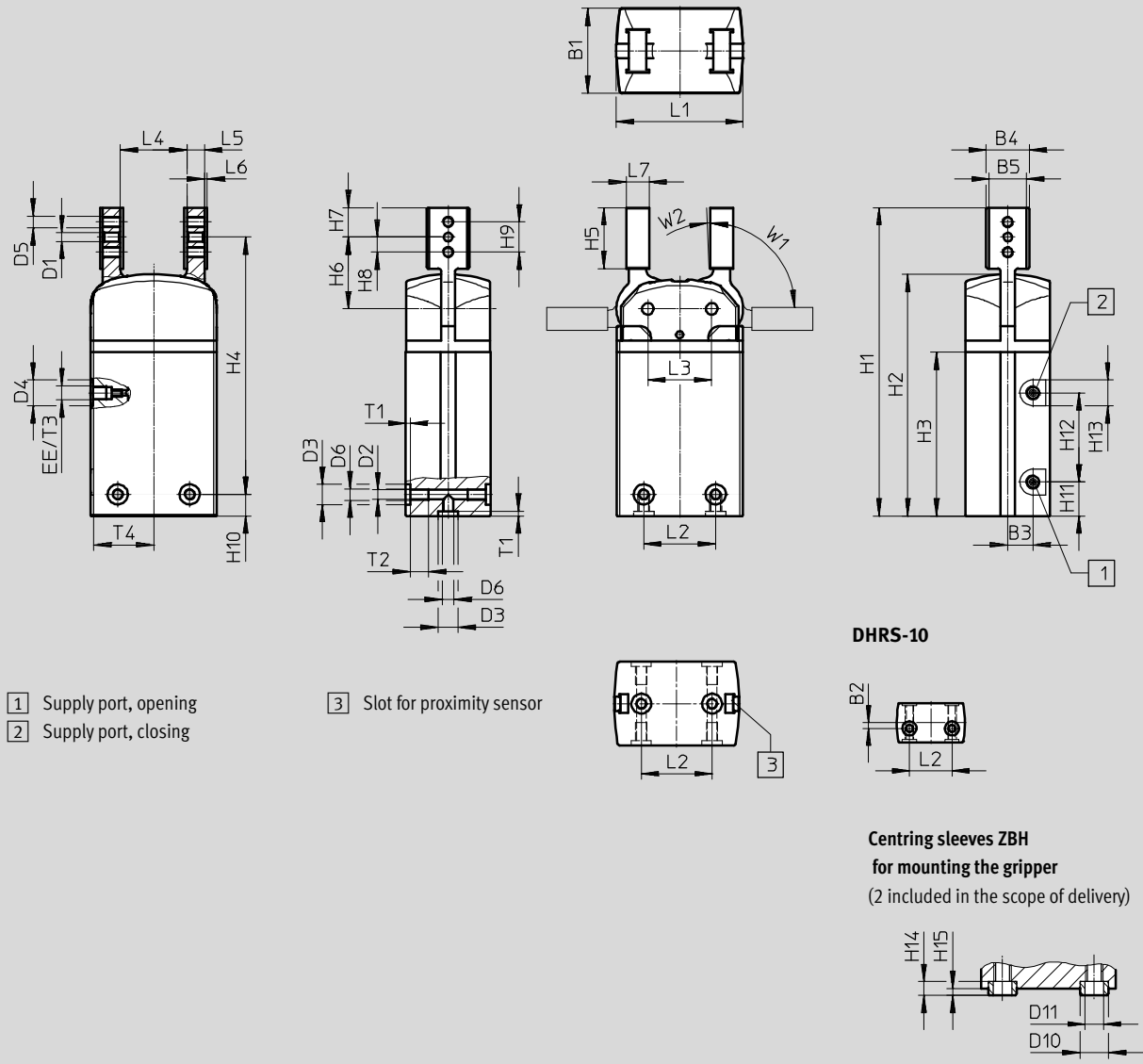

Size	B1	B2 ¹⁾	B3	B4	B5	D1	D2	D3	D4	D5	D6
[mm]	±0.05				+0.03/ +0.01	∅ H8	∅ +0.1	∅ H8/h7	∅		
10	14	2	2	8.5	6.5	2	2.4	5	7	M2.5	M3
16	19	-	5.8	14	10	2	2.5	5	-	M3	M3
25	29.5	-	8.75	15	13	3	3.3	7	9	M4	M4
32	38	-	11	16	14	4	5.1	9	15	M5	M6
40	49	-	11	24	20	5	6.4	12	15	M6	M8

Size	D10	D11	EE	H1	H2	H3	H4	H5	H6	H7
[mm]	∅ h7	∅					±0.25	±0.2	±0.05	-0.1
10	5	3.2	M3	60.8	46	30.8	42.25	13.8	14.95	6.25
16	5	3.2	M3	88.2	70.5	49	73.7	16.5	19.7	7
25	7	5.3	M5	107.2	84	57	89.45	21.2	24.95	10.25
32	9	6.4	G1/8	128.5	96.2	65	103.5	29.5	32	14
40	12	10.3	G1/8	140	108.4	71.5	108.7	29.5	33.7	13.8

1) Tolerance for centring hole ±0.02 mm; tolerance for thread ±0.1 mm

Radial grippers DHRS

Technical data

Size	H8	H9	H10 ²⁾	H11	H12	H13	H14	H15	L1	L2 ¹⁾	L3
[mm]							-0.2	-0.3	±0.05		±0.02
10	4	8	12.3	8.8	16	7	2.4	1.2	24	15	12.4
16	4	8	7.5	12.25	23	7	2.4	1.2	33.4	16	17
25	5.25	10.5	7.5	11.8	31	9	3	1.4	44	25	22.2
32	7	14	11	20	25	15	4	1.9	51	29	25.8
40	8	16	17.5	9	46	15	5	2.4	59	33	30

Size	L4	L5	L6	L7	T1	T2	T3	T4	W1	W2
[mm]		±0.05			+0.1	+1	+0.5		±2°	+3°
10	12	4	0.5	5	1.2	through	3.5	11.6	90	2
16	21	4	1	6	1.2	5.8	4.5	16	90	2
25	23.2	6	1	8	1.6	6.4	4.5	21	90	2
32	24.8	8	1	10	2.1	12.9	6.5	24	90	2
40	29.6	10	1	12	2.6	13.4	6	28.4	90	2

1) Tolerance for centring hole ±0.02 mm, tolerance for thread ±0.1 mm

2) Tolerance for centring hole -0.05 mm, tolerance for thread ±0.1 mm

Ordering data					
Size	Double-acting without compression spring		Single-acting or with gripping force retention		
	Part No.	Type	Closing		
[mm]			Part No.	Type	
10	1310159	DHRS-10-A	-		
16	1310160	DHRS-16-A	1310161	DHRS-16-A-NC	
25	1310162	DHRS-25-A	1310163	DHRS-25-A-NC	
32	1310164	DHRS-32-A	1310165	DHRS-32-A-NC	
40	1310166	DHRS-40-A	1310167	DHRS-40-A-NC	

Radial grippers DHRS



Accessories



Adapter kit
HMSV, HAPG, HAPS, HMVA, DHAA

Material:
Wrought aluminium alloy
Free of copper and PTFE
RoHS-compliant

 Note
The kit includes the individual mounting interface as well as the necessary mounting material.

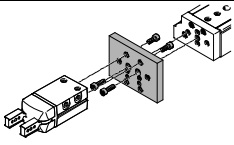
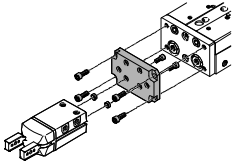
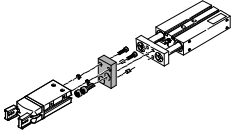
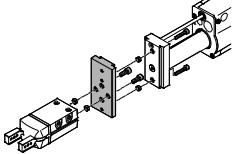
Permissible drive/gripper combinations with adapter kit						Download CAD data → www.festo.com	
Combination	Drive Size	Gripper Size	Mounting option		Adapter kit		
					CRC ¹⁾	Part No.	Type
	DGSL	DHRS			HMSV		
	8, 10	10	■	■	2	548784	HMSV-54
	12, 16	16	■	■		548785	HMSV-55
	20, 25	25, 32	■	■		548786	HMSV-56
	SLT	DHRS			HAPS		
	10	10	■	–	2	178448	HAPS-2
	16	16	■	–		178449	HAPS-3
	20	25	■	–		178450	HAPS-4
	25	32	■	–		178451	HAPS-5
	DPZ	DHRS			HAPG		
	10, 16	16	■	–	2	163250	HAPG-1
	16	25	■	–		163251	HAPG-2
	20	25	■	–		163252	HAPG-3
	25, 32	32	■	–		163253	HAPG-4
	HMP	DHRS			HMSV		
	Direct mounting				2		
	16, 20	16	■	■		177666	HMSV-20
	16, 20, 25	25	■	■		177761	HMSV-21
	16, 20, 25, 32	32	■	■		177762	HMSV-22
	25	40	■	■		177763	HMSV-23
	32	40	■	■		177764	HMSV-24
	Dovetail mounting				2		
	16, 20	16	■	■		177767	HMSV-27
	16, 20, 25	25	■	■		177768	HMSV-28
	16, 20, 25, 32	32	■	■		177769	HMSV-29
	25	40	■	■		177770	HMSV-30
	32	40	■	■		178211	HMSV-31

1) Corrosion resistance class CRC 2 to Festo standard FN 940070
Moderate corrosion stress. Indoor applications in which condensation may occur. External visible parts with primarily decorative requirements for the surface and which are in direct contact with the ambient atmosphere typical for industrial applications.

Radial grippers DHRS



Accessories



Adapter kit
HMSV, HAPG, HAPS, HMVA, DHAA

Material:
Wrought aluminium alloy
Free of copper and PTFE
RoHS-compliant

 Note
The kit includes the individual mounting interface as well as the necessary mounting material.

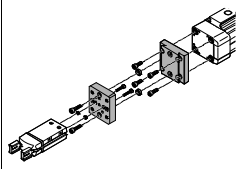
Permissible drive/gripper combinations with adapter kit					Download CAD data → www.festo.com		
Combination	Drive Size	Gripper Size	Mounting option		Adapter kit		
					CRC ¹⁾	Part No.	Type
DGP..., DGE..., DGEA/DHRS	DG...	DHRS				HMVA, HAPG, HMSV	
	Direct mounting						
	18 ²⁾ , 25 ³⁾	10	■	■	2	196788	HMVA-DLA18/25
			■	■		192706	HAPG-37-S1
	40 ³⁾	10	■	■		196790	HMVA-DLA40
			■	■		192706	HAPG-37-S1
	18 ²⁾ , 25 ³⁾	16	■	■		196788	HMVA-DLA18/25
			■	■		192705	HAPG-36-S1
	40 ³⁾	16	■	■		196790	HMVA-DLA40
			■	■		192705	HAPG-36-S1
	18 ²⁾ , 25 ³⁾	25	■	■		196788	HMVA-DLA18/25
			■	■		193922	HAPG-37-S4
	40 ³⁾	25	■	■		196790	HMVA-DLA40
			■	■		193922	HAPG-37-S4
	Dovetail mounting						
	18 ²⁾ , 25	16	■	■	2	196788	HMVA-DLA18/25
			■	■		177767	HMSV-27
	40	16	■	■		196790	HMVA-DLA40
			■	■		177767	HMSV-27
18 ²⁾ , 25	25	■	■	196788		HMVA-DLA18/25	
		■	■	177768		HMSV-28	
40	25	■	■	196790		HMVA-DLA40	
		■	■	177768		HMSV-28	
40	32	■	■	196790		HMVA-DLA40	
		■	■	177769		HMSV-29	
40	40	■	■	196790		HMVA-DLA40	
		■	■	177770		HMSV-30	

- 1) Corrosion resistance class CRC 2 to Festo standard FN 940070
Moderate corrosion stress. Indoor applications in which condensation may occur. External visible parts with primarily decorative requirements for the surface and which are in direct contact with the ambient atmosphere typical for industrial applications.
- 2) Only for DGEA-...
- 3) Only for DGE.../DGP...

Radial grippers DHRS



Accessories



Adapter kit
HMSV, HAPG, HAPS, HMVA, DHAA

Material:
Wrought aluminium alloy
Free of copper and PTFE
RoHS-compliant

 Note
The kit includes the individual mounting interface as well as the necessary mounting material.

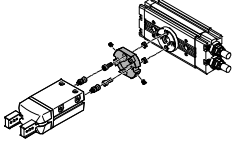
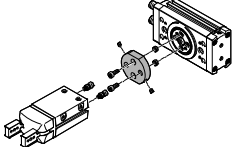
Permissible drive/gripper combinations with adapter kit					Download CAD data → www.festo.com			
Combination	Drive Size	Gripper Size	Mounting option		Adapter kit			
					CRC ¹⁾	Part No.	Type	
	DRQD-...-FW	DHRS			2	HAPG		
	6, 8, 12	10	■	■		187568	HAPG-34	
	16 ²⁾	10	■	■		187566	HAPG-SD2-12	
	16 ²⁾	16	■	■		184477	HAPG-SD2-1	
	16 ²⁾	25	■	■		184478	HAPG-SD2-2	
	20 ²⁾	25	■	■		184479	HAPG-SD2-3	
	20 ²⁾	32	■	■		184480	HAPG-SD2-4	
	25 ³⁾	25	■	■		184482	HAPG-SD2-6	
	25 ³⁾	32	■	■		184483	HAPG-SD2-7	
	32 ³⁾	32	■	■		184485	HAPG-SD2-9	
	32 ³⁾	40	■	■		184486	HAPG-SD2-10	
	40, 50	40	■	■		526027	HAPG-SD2-21	
	DRQD-...ZW	DHRS				2	HAPG	
	16	16	■	■			163267	HAPG-18
	16	25	■	■			163268	HAPG-19
	20	25	■	■			163269	HAPG-20
	20	32	■	■			163270	HAPG-21
	25	32	■	■			163271	HAPG-22
		DRRD	DHRS				2	DHAA
8		10	■	■	2816591	DHAA-G-Q11-8-B2/B3-10		
10		10	■	■	2816068	DHAA-G-Q11-10-B2/B3-10		
12		10	■	■	2814790	DHAA-G-Q11-12-B2/B3-10		
12		16	■	■	2811183	DHAA-G-Q11-12-B2/B3-16		
16		16	■	■	1979085	DHAA-G-Q11-16-B2/B3-16		
16		25	■	■	1978889	DHAA-G-Q11-16-B2/B3-25		
20		25	■	■	1978443	DHAA-G-Q11-20-B2/B3-25		
20		32	■	■	1979912	DHAA-G-Q11-20-B2/B3-32		
25		25	■	■	1801802	DHAA-G-Q11-25-B2/B3-25		
25		32	■	■	1802969	DHAA-G-Q11-25-B2/B3-32		
32		32	■	■	1979992	DHAA-G-Q11-32-B2/B3-32		
32		40	■	■	1980014	DHAA-G-Q11-32-B2/B3-40		
35, 40		40	■	■	1980059	DHAA-G-Q11-35/40-B2/B3-40		

- 1) Corrosion resistance class CRC 2 to Festo standard FN 940070
Moderate corrosion stress. Indoor applications in which condensation may occur. External visible parts with primarily decorative requirements for the surface and which are in direct contact with the ambient atmosphere typical for industrial applications.
- 2) Possible in combination with DRQD-...-E422 (flanged shaft with energy through-feed).
- 3) Possible in combination with DRQD-...-E444 (flanged shaft with energy through-feed).

Radial grippers DHRS

Accessories



Adapter kit
HMSV, HAPG, HAPS, HMVA, DHAA

Material:
Wrought aluminium alloy
Free of copper and PTFE
RoHS-compliant

 Note
The kit includes the individual mounting interface as well as the necessary mounting material.

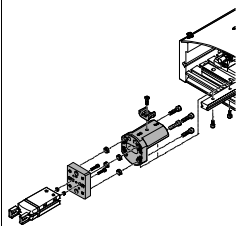
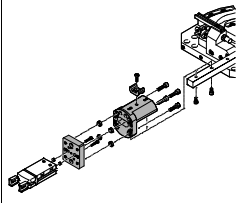
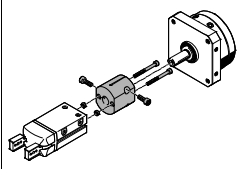
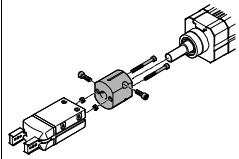
Permissible drive/gripper combinations with adapter kit						Download CAD data → www.festo.com	
Combination	Drive	Gripper	Mounting option		Adapter kit		
			Size	Size	CRC ¹⁾	Part No.	Type
	HSP	DHRS			HAPG		
	12	10	■	–	2	192709	HAPG-60-S1
						540881	HAPG-70-B
	16	10	■	–		192706	HAPG-37-S1
						540882	HAPG-71-B
	16	16	■	–		192705	HAPG-36-S1
				540882		HAPG-71-B	
	25	16	■	–	192705	HAPG-36-S1	
					540883	HAPG-72-B	
	25	25	■	–	193922	HAPG-37-S4	
					540883	HAPG-72-B	
	HSW	DHRS			HAPG		
	12, 16	10	■	–	2	192706	HAPG-37-S1
						540882	HAPG-71-B
12, 16	16	■	–	192705		HAPG-36-S1	
					540882	HAPG-71-B	
	DSM-...-FW	DHRS			HAPG		
	6, 8, 10	10	■	■	2	187568	HAPG-34
	DSM-...	DHRS			HAPG		
	12	16	■	■	2	163266	HAPG-17
	16	16	■	■		163267	HAPG-18
	16	25	■	■		163268	HAPG-19
	25	25	■	■		163269	HAPG-20
	25	32	■	■		163270	HAPG-21
32	32	■	■	163271		HAPG-22	
	DSL	DHRS			HAPG		
	16	16	■	■	2	163266	HAPG-17
	20	16	■	■		163267	HAPG-18
	20	25	■	■		163268	HAPG-19
	25	25	■	■		163269	HAPG-20
	25	32	■	■		163270	HAPG-21
	32	32	■	■		163271	HAPG-22

1) Corrosion resistance class CRC 2 to Festo standard FN 940070
Moderate corrosion stress. Indoor applications in which condensation may occur. External visible parts with primarily decorative requirements for the surface and which are in direct contact with the ambient atmosphere typical for industrial applications.

Radial grippers DHRS



Accessories



Adapter kit
HMSV, HAPG, HAPS, HMVA, DHAA

Material:
Wrought aluminium alloy
Free of copper and PTFE
RoHS-compliant

 Note
The kit includes the individual mounting interface as well as the necessary mounting material.

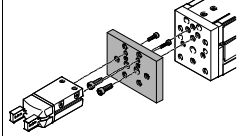
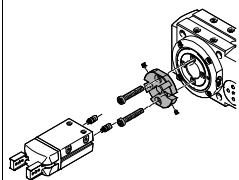
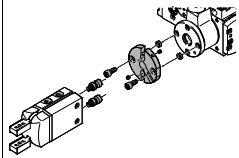
Permissible drive/gripper combinations with adapter kit						Download CAD data → www.festo.com	
Combination	Drive Size	Gripper Size	Mounting option		Adapter kit		
					CRC ¹⁾	Part No.	Type
EGSL/DHRS	EGSL	DHRS			HMSV		
	35	10	■	■	2	548784	HMSV-54
	45, 55	16	■	■		1088262	HMSV-70
	75	25, 32	■	■		548785	HMSV-55
			■	■		548786	HMSV-56
ERMB/DHRS	ERMB	DHRS			HAPG		
	20	25	■	■	2	184479	HAPG-SD2-3
	25	25	■	■		184482	HAPG-SD2-6
	20	32	■	■		184480	HAPG-SD2-4
	25	32	■	■		184483	HAPG-SD2-7
	32	32	■	■		184485	HAPG-SD2-9
	32	40	■	■		184486	HAPG-SD2-10
			■	■			
EHMB/DHRS	EHMB	DHRS			HAPG		
	20	32	■	■	2	184485	HAPG-SD2-9
	20	40	■	■		184486	HAPG-SD2-10
	25, 32	40	■	■		526027	HAPG-SD2-21
			■	■			

1) Corrosion resistance class CRC 2 to Festo standard FN 940070
Moderate corrosion stress. Indoor applications in which condensation may occur. External visible parts with primarily decorative requirements for the surface and which are in direct contact with the ambient atmosphere typical for industrial applications.

Radial grippers DHRS

Accessories

FESTO

Ordering data						
	For size [mm]	Description	Weight [g]	Part No.	Type	PU ¹⁾
Centring sleeve ZBH			Technical data → Internet: zbh			
	10, 16	For centring the gripper during mounting	1	189652	ZBH-5	10
	25		1	186717	ZBH-7	
	32		1	150927	ZBH-9	
	40		1	189653	ZBH-12	

1) Packaging unit

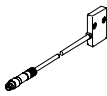

Ordering data						
Type	For size		Weight [g]	Part No.	Type	
Position sensor SMH-S1			Technical data → Internet: smh-s1			
	10		20	175712	SMH-S1-HGR10	

Signal converter/evaluation unit for position sensor SMH-S1

Signal converter SVE4

Evaluation unit SMH-AE1

- Converts analogue signals into switching points
- Switching function freely programmable with teach-in
- Threshold value, hysteresis or window comparator
- Converts analogue signals into switching points
- With 3 potentiometers for setting 3 switching points

Ordering data						
Type	For size	Input connection	Output connection	Switching output	Weight [g]	Part No. Type
Signal converter SVE4			Technical data → Internet: sve4			
	10	Socket M8x1, 4-pin	Plug M8x1, 4-pin	2x PNP	19	544216 SVE4-HS-R-HM8-2P-M8
				2x NPN		544219 SVE4-HS-R-HM8-2N-M8
Evaluation unit SMH-AE1			Technical data → Internet: smh-ae			
	10	Socket M8x1, 4-pin	Plug M12x1, 5-pin	3x PNP	170	175708 SMH-AE1-PS3-M12
				3x NPN		175709 SMH-AE1-NS3-M12

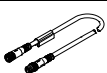
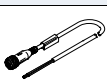
Ordering data – Connecting cables						Technical data → Internet: nebu
	Electrical connection, left	Electrical connection, right	Cable length [m]	Part No.	Type	
Connection between position sensor and signal converter/evaluation unit						
	Straight socket, M8x1, 4-pin	Straight plug, M8x1, 4-pin	2.5	554035	NEBU-M8G4-K-2.5-M8G4	
Connection between evaluation unit and controller						
	Straight socket, M12x1, 5-pin	Cable, open end, 5-wire	2.5	541330	NEBU-M12G5-K-2.5-LE5	
			5			541331



Radial grippers DHRS

Accessories

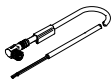
FESTO

Ordering data – Connecting cables				Technical data → Internet: nebu	
	Electrical connection, left	Electrical connection, right	Cable length [m]	Part No.	Type
Connection between signal converter and controller					
	Straight socket, M8x1, 4-pin	Cable, open end, 4-wire	2.5	541342	NEBU-M8G4-K-2.5-LE4
			5	541343	NEBU-M8G4-K-5-LE4
	Angled socket, M8x1, 4-pin	Cable, open end, 4-wire	2.5	541344	NEBU-M8W4-K-2.5-LE4
			5	541345	NEBU-M8W4-K-5-LE4

Ordering data – Proximity sensors for T-slot, magneto-resistive				Technical data → Internet: smt	
	Type of mounting	Electrical connection, connection direction	Switching output	Cable length [m]	Part No. Type
N/O contact					
	Insertable in the slot lengthwise	Cable, 3-wire, lateral	PNP	2.5	547859 SMT-8G-PS-24V-E-2,5Q-OE
		Plug M8x1, 3-pin, lateral		0.3	547860 SMT-8G-PS-24V-E-0,3Q-M8D



Ordering data – Connecting cables				Technical data → Internet: nebu	
	Electrical connection, left	Electrical connection, right	Cable length [m]	Part No.	Type
	Straight socket, M8x1, 3-pin	Cable, open end, 3-wire	2.5	541333	NEBU-M8G3-K-2.5-LE3
			5	541334	NEBU-M8G3-K-5-LE3
	Angled socket, M8x1, 3-pin	Cable, open end, 3-wire	2.5	541338	NEBU-M8W3-K-2.5-LE3
			5	541341	NEBU-M8W3-K-5-LE3

Position transmitter

The position transmitter continuously senses the position of the piston.

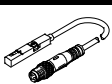
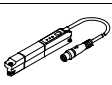
It has an analogue output with an output signal in proportion to the piston position.

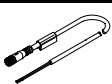
Ordering data – Position transmitters for T-slot				Technical data → Internet: position transmitter					
	For size	Position measuring range	Analogue output		Type of mounting	Electrical connection	Cable length [m]	Part No.	Type
			[V]	[mA]					
	16 ... 40	0 ... 40	0 ... 10	–	Insertable in slot from above	Plug M8x1, 4-pin, in-line	0.3	553744	SMAT-8M-U-E-0,3-M8D
	32, 40	0 ... 50	–	4 ... 20	Insertable in slot from above	Plug M8x1, 4-pin, in-line	0.3	1531265	SDAT-MHS-M50-1L-SA-E-03-M8

Ordering data – Connecting cables				Technical data → Internet: nebu	
	Electrical connection, left	Electrical connection, right	Cable length [m]	Part No.	Type
	Straight socket, M8x1, 4-pin	Cable, open end, 4-wire	2.5	541342	NEBU-M8G4-K-2.5-LE4
			5	541343	NEBU-M8G4-K-5-LE4
	Angled socket, M8x1, 4-pin	Cable, open end, 4-wire	2.5	541344	NEBU-M8W4-K-2.5-LE4
			5	541345	NEBU-M8W4-K-5-LE4

Product Range and Company Overview

A Complete Suite and Company Overview

Our experienced engineers provide complete support at every stage of your development process, including: conceptualization, analysis, engineering, design, assembly, documentation, validation, and production.



Custom Automation Components
Complete custom engineered solutions



Custom Control Cabinets
Comprehensive engineering support and on-site services



Complete Systems
Shipment, stocking and storage services

The Broadest Range of Automation Components

With a comprehensive line of more than 30,000 automation components, Festo is capable of solving the most complex automation requirements.



Electromechanical
Electromechanical actuators, motors, controllers & drivers



Pneumatics
Pneumatic linear and rotary actuators, valves, and air supply



PLCs and I/O Devices
PLC's, operator interfaces, sensors and I/O devices

Supporting Advanced Automation... As No One Else Can!

Festo is a leading global manufacturer of pneumatic and electromechanical systems, components and controls for industrial automation, with more than 16,000 employees in 60 national headquarters serving more than 180 countries. For more than 80 years, Festo has continuously elevated the state of manufacturing with innovations and optimized motion control solutions that deliver higher performing, more profitable automated manufacturing and processing equipment. Our dedication to the advancement of automation extends beyond technology to the education and development of current and future automation and robotics designers with simulation tools, teaching programs, and on-site services.

Quality Assurance, ISO 9001 and ISO 14001 Certifications

Festo Corporation is committed to supply all Festo products and services that will meet or exceed our customers' requirements in product quality, delivery, customer service and satisfaction.

To meet this commitment, we strive to ensure a consistent, integrated, and systematic approach to management that will meet or exceed the requirements of the ISO 9001 standard for Quality Management and the ISO 14001 standard for Environmental Management.



© Copyright 2013, Festo Corporation. While every effort is made to ensure that all dimensions and specifications are correct, Festo cannot guarantee that publications are completely free of any error, in particular typing or printing errors. Accordingly, Festo cannot be held responsible for the same. For Liability and Warranty conditions, refer to our "Terms and Conditions of Sale", available from your local Festo office. All rights reserved. No part of this publication may be reproduced, distributed, or transmitted in any form or by any means, electronic, mechanical, photocopying or otherwise, without the prior written permission of Festo. All technical data subject to change according to technical update.



Printed on recycled paper at New Horizon Graphic, Inc., FSC certified as an environmental friendly printing plant.

Festo North America

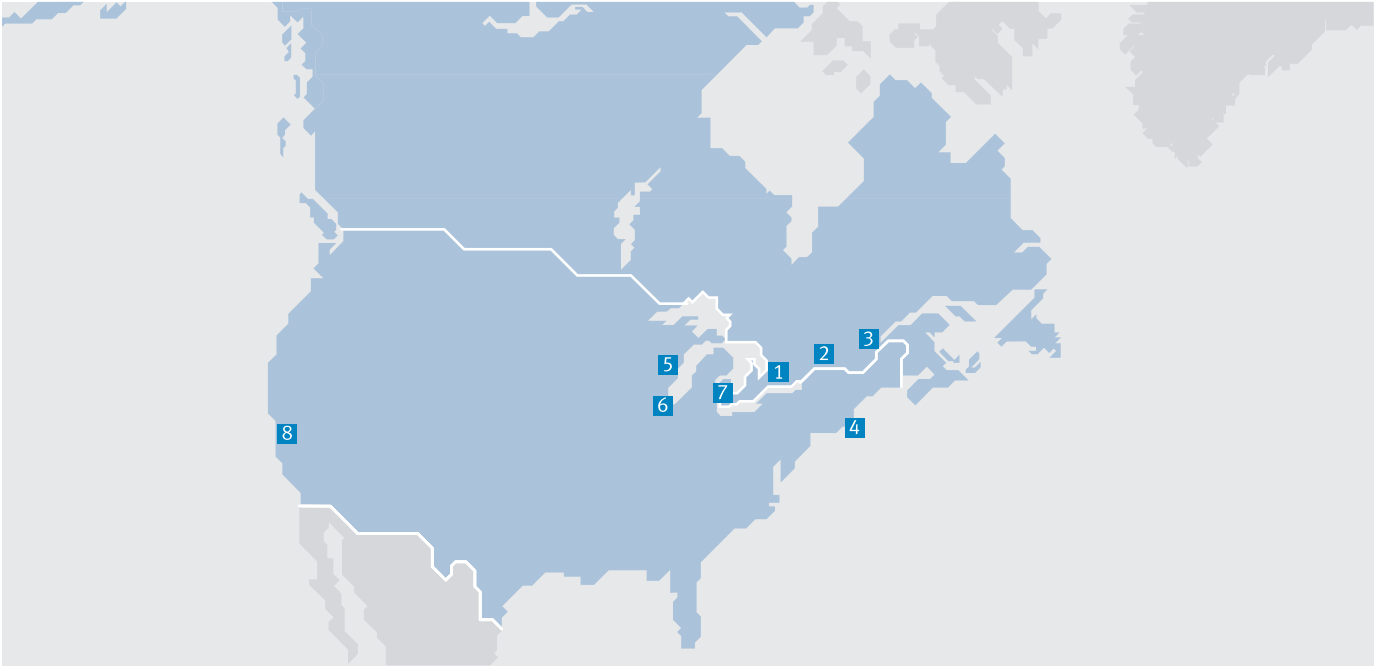

**1 Festo Canada
Headquarters
Festo Inc.**
5300 Explorer Drive
Mississauga, ON
L4W 5G4

2 Montréal
5600, Trans-Canada
Pointe-Claire, QC
H9R 1B6

3 Québec City
2930, rue Watt#117
Québec, QC
G1X 4G3



**4 Festo United States
Headquarters
Festo Corporation**
395 Moreland Road
Hauppauge, NY
11788

5 Appleton
North 922 Tower View Drive, Suite N
Greenville, WI
54942

7 Detroit
1441 West Long Lake Road
Troy, MI
48098

6 Chicago
85 W Algonquin - Suite 340
Arlington Heights, IL
60005

8 Silicon Valley
4935 Southfront Road, Suite F
Livermore, CA
94550

Festo Regional Contact Center

Canadian Customers

Commercial Support:
Tel: 1 877 GO FESTO (1 877 463 3786)
Fax: 1 877 FX FESTO (1 877 393 3786)
Email: festo.canada@ca.festo.com

Technical Support:
Tel: 1 866 GO FESTO (1 866 463 3786)
Fax: 1 877 FX FESTO (1 877 393 3786)
Email: technical.support@ca.festo.com

USA Customers

Commercial Support:
Tel: 1 800 99 FESTO (1 800 993 3786)
Fax: 1 800 96 FESTO (1 800 963 3786)
Email: customer.service@us.festo.com

Technical Support:
Tel: 1 866 GO FESTO (1 866 463 3786)
Fax: 1 800 96 FESTO (1 800 963 3786)
Email: product.support@us.festo.com