

Mini guided cylinders DFC

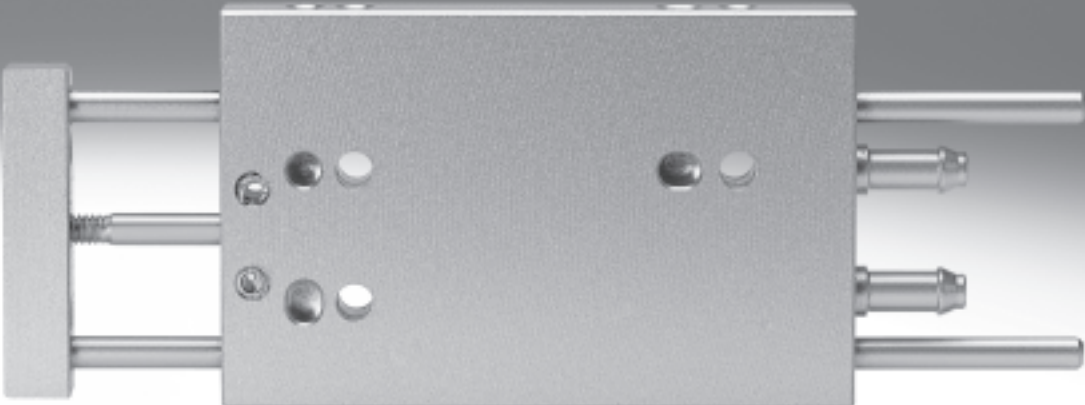

Mini guided cylinders DFC

Product range and peripherals overview

FESTO

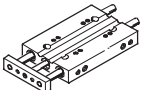
Function	Version	Type	Piston Ø [mm]	Stroke [mm]
Double-acting		DFC	4	5, 10, 15, 20
			6	5, 10, 15, 20, 25, 30
			10	5, 10, 15, 20, 25, 30

Piston Ø 4 mm

Piston Ø 6, 10 mm

Integrated push-in/threaded fitting

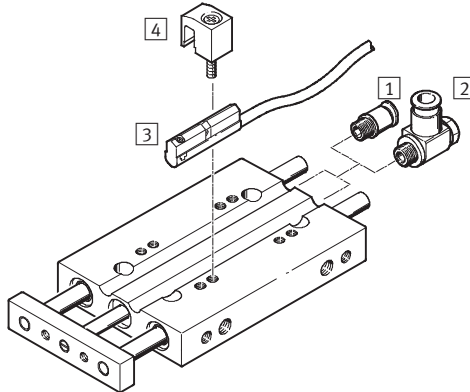
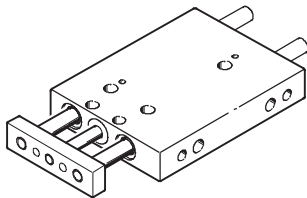

Accessories					
	Brief description	Piston Ø 4 mm	Piston Ø 6 mm	Piston Ø 10 mm	→ Page/Internet
1	Push-in/threaded fitting QSM	-	■	■	quick star
2	One-way flow control valve GRLZ	-	-	■	10
3	Proximity sensor SME/SMT-10	-	■	■	10
4	Sensor bracket	-	■	■	-

Mounting options

Horizontal mounting from above

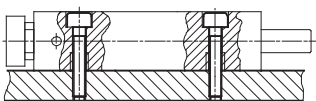

Horizontal mounting from below

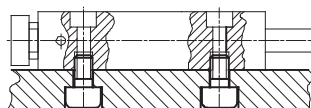

Side mounting from below

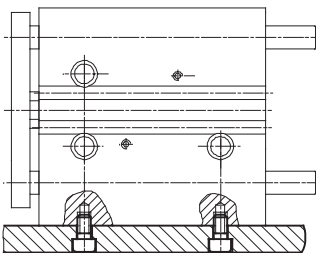

Yoke mounting

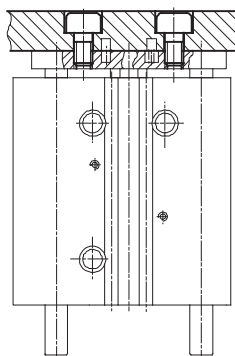

Mini guided cylinders DFC

Type code

		DFC	-	6	-	20	-	P	-	A	-	GF
Type												
Double-acting												
DFC	Mini guided cylinder											
Piston Ø [mm]												
Stroke [mm]												
Cushioning												
P	Flexible cushioning rings/plates at both ends											
Position sensing												
	No position sensing											
A	For proximity sensing											
Guide												
GF	Plain-bearing guide											
KF	Recirculating ball bearing guide											

Mini guided cylinders DFC

Technical data

FESTO

Function
DFC-...
 without end-position sensing

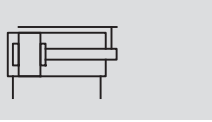

-N- Diameter
 4, 6, 10 mm
 -T- Stroke length
 5 ... 30 mm

www.festo.com/en/Spare_parts_service

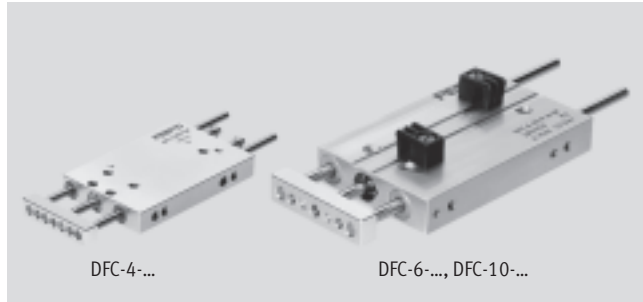

DFC-...-A-...
 with end position sensing

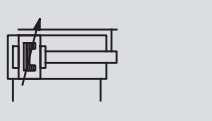

General technical data			
Piston Ø	4	6	10
Pneumatic connection	Barbed fitting PK-3 for 3 mm plastic tubing	M3	M5
Operating medium	Compressed air in accordance with ISO 8573-1:2010 [7:4:4]		
Note on operating/pilot medium	Operation with lubricated medium possible (in which case lubricated operation will always be required)		
Operating pressure [bar]	3.5 ... 7.0	1.5 ... 10.0	1.0 ... 10.0
Constructional design	Piston		
	Piston rod		
	Guide rods with yoke		
Cushioning	Flexible cushioning rings/plates at both ends		
Position sensing	-	For proximity sensing	
Type of mounting	Via through holes		
	Via female thread		
Mounting position	Any		
Protection against torsion/guide	Guide rod with yoke with plain-bearing guide		Guide rod with yoke with plain-bearing or ball bearing guide

Ambient conditions		
Variant	Plain-bearing guide GF	Recirculating ball bearing guide KF
Ambient temperature ¹⁾ [°C]	-5 ... +60	
Corrosion resistance class CRC ²⁾	2	-

1) Note operating range of proximity sensors.

2) Corrosion resistance class 2 according to Festo standard 940 070

Components requiring moderate corrosion resistance. Externally visible parts with primarily decorative surface requirements which are in direct contact with a surrounding industrial atmosphere or media such as cooling or lubricating agents.

Speeds [m/s] at maximum stroke length			
Piston Ø	4	6	10
Maximum speed	1.0	1.0	1.0
Minimum speed	0.1	0.1	0.1

Forces [N]			
Piston Ø	4	6	10
Theoretical force at 6 bar, advancing	7.5	17	47
Theoretical force at 6 bar, retracting	5.5	12.5	35

Mini guided cylinders DFC

Technical data

FESTO

Impact energy [J]			
Piston Ø	4	6	10
Max. impact energy at end positions	0.006	0.008	0.05

Permissible impact velocity:
$$v_{perm.} = \sqrt{\frac{2 \times E_{perm.}}{m_{dead} + m_{load}}}$$

$v_{perm.}$ Permissible impact velocity
 $E_{perm.}$ Max. impact energy
 m_{dead} Moving load (drive)
 m_{load} Moving work load

Note

These specifications represent the maximum values which can be reached. Note the maximum permitted impact energy.

Maximum permissible load:
$$m_{load} = \frac{2 \times E_{perm.}}{v^2} - m_{dead}$$

Maximum permissible load m as a function of the impact speed v

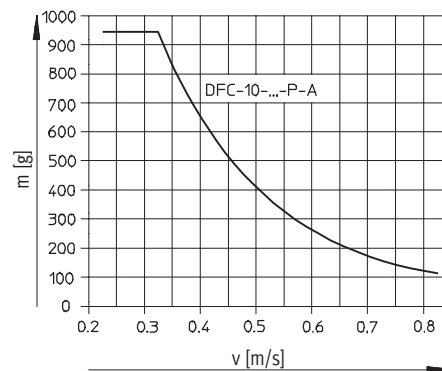
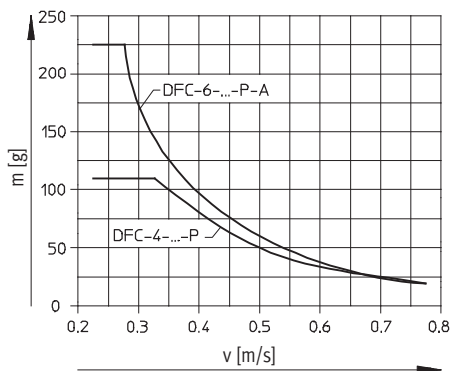

Weights [g]				
Piston Ø	4	6	10	
Product weight	at 5 mm stroke	10	28	91
	at 10 mm stroke	12	34	100
	at 15 mm stroke	15	39	108
	at 20 mm stroke	18	44	117
	at 25 mm stroke	-	49	125
	at 30 mm stroke	-	55	134
Moving load at 0 mm stroke	3.2	8.8	27.2	
Additional load per 10 mm stroke	1.3	2.8	7.2	

Materials

Sectional view

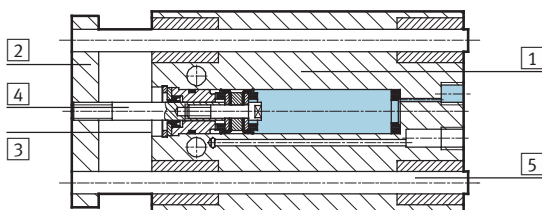

Mini guided cylinder		
1	Housing	Wrought aluminium alloy
2	Yoke plate	Wrought aluminium alloy
3	Cover	Wrought aluminium alloy
4	Piston rod	High-alloy stainless steel
5	Guide rods	High-alloy steel
-	Seals	Polyurethane, nitrile rubber

Mini guided cylinders DFC

Technical data

FESTO

Maximum effective load F [N]

Plain-bearing guide GF and recirculating ball bearing guide KF

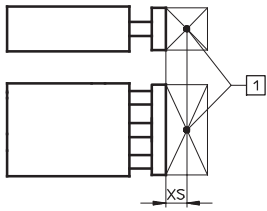

1 Centre of gravity of effective load

Piston Ø [mm]	XS [mm]	Stroke [mm]						
		5	10	15	20	25	30	
4	GF	5	1.7	1.7	1.7	1.7	-	-
	KF		-	-	-	-	-	-
6	GF	10	4.8	4.8	4.8	4.8	4.8	4.8
	KF		4.6	4.6	4.6	4.6	4.6	4.6
10	GF	15	12.2	12.2	12.2	12.2	12.2	12.2
	KF		9.8	9.8	9.8	9.8	9.8	9.8

Permissible torque load M [Nm]

Plain-bearing guide GF and recirculating ball bearing guide KF

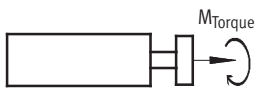

Piston Ø [mm]	Stroke [mm]	5	10	15	20	25	30
		4	GF	0.02	0.02	0.02	0.02
	KF	-	-	-	-	-	-
6	GF	0.1	0.1	0.1	0.1	0.1	0.1
	KF	0.1	0.1	0.1	0.1	0.1	0.1
10	GF	0.4	0.4	0.4	0.4	0.4	0.4
	KF	0.3	0.3	0.3	0.3	0.3	0.3

Torsional backlash p

Plain-bearing guide GF and recirculating ball bearing guide KF

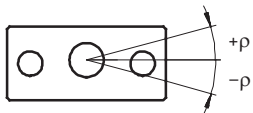

Piston Ø		4	6	10
In retracted state				
Torsional backlash [°]	GF	0.07	0.05	0.04
	KF	0.07	0.05	0.03
In advanced state with maximum stroke				
Torsional backlash [°]	GF	0.11	0.07	0.06
	KF	0.12	0.08	0.05

Mini guided cylinders DFC

Technical data

Deflection of piston rod

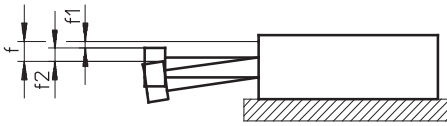

$$f = f_1 + f_2$$

f = Total deflection of piston rod

f₁ = Deflection due to bearing backlash = max. 0.02 mm

f₂ = Deflection due to lateral force

Deflection f₂ due to lateral force F as a function of the stroke

Piston Ø 4 mm

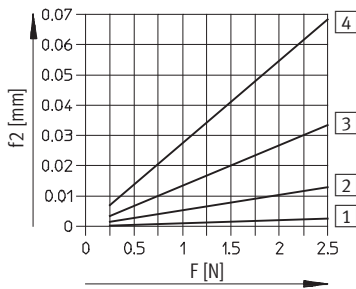

Piston Ø 6 mm

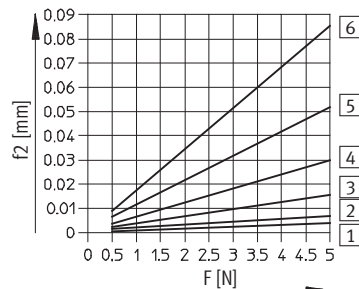

Piston Ø 10 mm

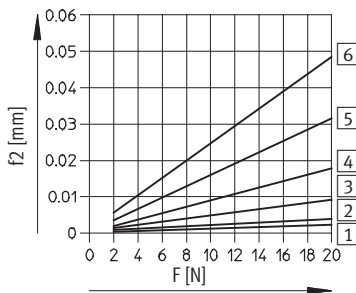

- 1 5 mm stroke
- 2 10 mm stroke
- 3 15 mm stroke
- 4 20 mm stroke
- 5 25 mm stroke
- 6 30 mm stroke

Mini guided cylinders DFC

Technical data

FESTO

Dimensions

Download CAD Data → www.festo.com/us/cad

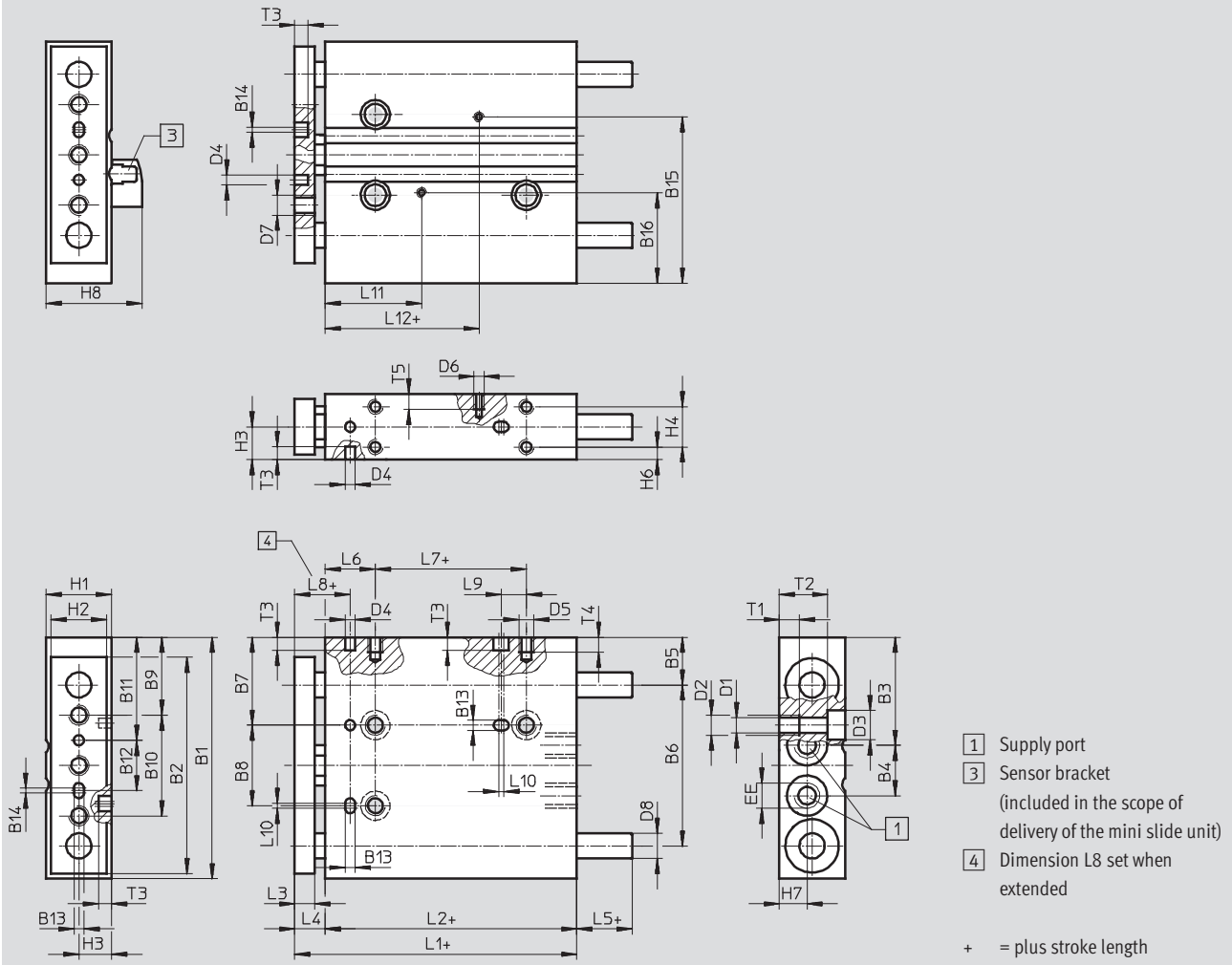

Piston Ø 4 mm

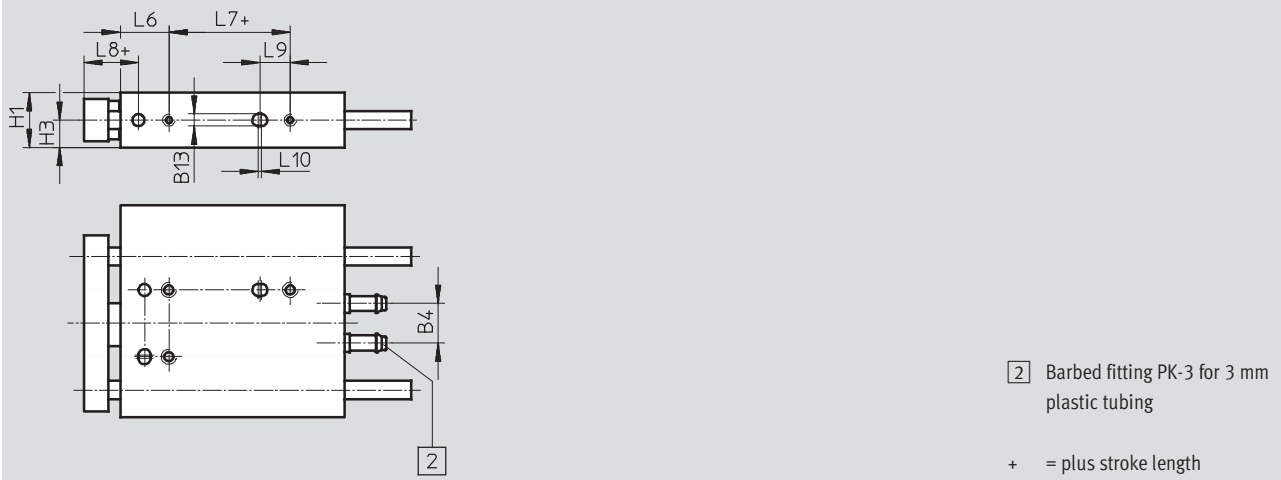

Mini guided cylinders DFC

Technical data

FESTO

∅ [mm]	B1	B2	B3	B4	B5	B6	B7	B8	B9	B10	B11	B12	B13 H8	B14	B15	B16	D1 ∅
4	24	20	9.8	7.4	6	15	9.5	8	8.5	10	11	5	2	-	-	-	2.1
6	35	29	17	6.5	8.5	22	14	11	12	15	15.75	8	2	1	26.2	12.8	2
10	48	43	21.5	10	9.5	32	17.5	16	15.5	20	20.5	10	2	1	33	18	3.2

∅ [mm]	D2	D3 ∅	D4 ∅ H8	D5	D6 ∅	D7	D8 ∅	EE	H1	H2	H3	H4	H6	H7	H8	L1	L2
4	-	-	2	M2	-	M2	2	-	5.5	4.5	2.75	-	2.75	2.75	-	24	18
6	M2.5	4	2	M2.5	M2	M2.5	3	M3	9	7	4.5	-	4.5	3.5	15	34	27
10	M4	5.8	2	M3	M2	M4	5	M5	13	11	6.5	8	2.5	5.5	19	48	40

∅ [mm]	L3	L4 +0.3 -0.9	L5	L6	L7	L8 +0.2	L9	L10	L11	L12	T1	T2	T3	T4	T5
4	4	6	1	8	3	11	3.5	0.5	-	-	-	5.5	2	4	-
6	5	7	1	8	10	10	5	0.5	16	19.35	3	6.1	2.6	5	2.5
10	6	8	1	10	20	13	5	1	22.2	25.6	4	9.6	2.6	3	3

Ordering data																	
Piston ∅ [mm]	Stroke [mm]	Plain-bearing guide GF						Recirculating ball bearing guide KF									
		Part No.		Type				Part No.		Type							
4	5	189 479	DFC-4-5-P-GF				-										
	10	189 452	DFC-4-10-P-GF														
	15	189 453	DFC-4-15-P-GF														
	20	189 454	DFC-4-20-P-GF														
6	5	189 455	DFC-6-5-P-A-GF ¹⁾				189 461	DFC-6-5-P-A-KF ¹⁾									
	10	189 456	DFC-6-10-P-A-GF ¹⁾				189 462	DFC-6-10-P-A-KF ¹⁾									
	15	189 457	DFC-6-15-P-A-GF ¹⁾				189 463	DFC-6-15-P-A-KF ¹⁾									
	20	189 458	DFC-6-20-P-A-GF ¹⁾				189 464	DFC-6-20-P-A-KF ¹⁾									
	25	189 459	DFC-6-25-P-A-GF ¹⁾				189 465	DFC-6-25-P-A-KF ¹⁾									
	30	189 460	DFC-6-30-P-A-GF ¹⁾				189 466	DFC-6-30-P-A-KF ¹⁾									
10	5	189 467	DFC-10-5-P-A-GF ¹⁾				189 473	DFC-10-5-P-A-KF ¹⁾									
	10	189 468	DFC-10-10-P-A-GF ¹⁾				189 474	DFC-10-10-P-A-KF ¹⁾									
	15	189 469	DFC-10-15-P-A-GF ¹⁾				189 475	DFC-10-15-P-A-KF ¹⁾									
	20	189 470	DFC-10-20-P-A-GF ¹⁾				189 476	DFC-10-20-P-A-KF ¹⁾									
	25	189 471	DFC-10-25-P-A-GF ¹⁾				189 477	DFC-10-25-P-A-KF ¹⁾									
	30	189 472	DFC-10-30-P-A-GF ¹⁾				189 478	DFC-10-30-P-A-KF ¹⁾									

1) Mounting kits for proximity sensors included in scope of delivery.



Mini guided cylinders DFC

Accessories

FESTO

Ordering data – Proximity sensors for C-slot, magneto-resistive						Technical data → Internet: smt	
	Type of mounting	Switch output	Electrical connection, connection direction	Cable length [m]	Part No.	Type	
N/O contact							
	Insertable in the slot from above	PNP	Plug M8x1, 3-pin, in-line	0.3	551 375	SMT-10M-PS-24V-E-0,3-L-M8D	
			Cable, 3-wire, in-line	2.5	551 373	SMT-10M-PS-24V-E-2,5-L-OE	

Ordering data – Proximity sensors for C-slot, magnetic reed						Technical data → Internet: sme	
	Type of mounting	Switch output	Electrical connection, connection direction	Cable length [m]	Part No.	Type	
N/O contact							
	Insertable in the slot lengthwise	Contacting	Plug M8x1, 3-pin, in-line	0.3	173 212	SME-10-SL-LED-24	
			Cable, 3-wire, in-line	2.5	173 210	SME-10-KL-LED-24	

Ordering data – Connecting cables					Technical data → Internet: nebu		
	Electrical connection, left		Electrical connection, right	Cable length [m]	Part No.	Type	
	Straight socket, M8x1, 3-pin		Cable, open end, 3-wire	2.5	541 333	NEBU-M8G3-K-2.5-LE3	
				5	541 334	NEBU-M8G3-K-5-LE3	
	Angled socket, M8x1, 3-pin		Cable, open end, 3-wire	2.5	541 338	NEBU-M8W3-K-2.5-LE3	
				5	541 341	NEBU-M8W3-K-5-LE3	

Ordering data – One-way flow control valves				Technical data → Internet: grlz		
	Connection		Material	Part No.	Type	
	Thread	For tubing OD				
	M5	3	Metal design	193 153	GRLZ-M5-QS-3-D	
		4		193 154	GRLZ-M5-QS-4-D	
		6		193 155	GRLZ-M5-QS-6-D	

Product Range and Company Overview

A Complete Suite of Automation Services

Our experienced engineers provide complete support at every stage of your development process, including: conceptualization, analysis, engineering, design, assembly, documentation, validation, and production.



Custom Automation Components
Complete custom engineered solutions



Custom Control Cabinets
Comprehensive engineering support and on-site services



Complete Systems
Shipment, stocking and storage services

The Broadest Range of Automation Components

With a comprehensive line of more than 30,000 automation components, Festo is capable of solving the most complex automation requirements.



Electromechanical
Electromechanical actuators, motors, controllers & drives



Pneumatics
Pneumatic linear and rotary actuators, valves, and air supply



PLCs and I/O Devices
PLC's, operator interfaces, sensors and I/O devices

Supporting Advanced Automation... As No One Else Can!

Festo is a leading global manufacturer of pneumatic and electromechanical systems, components and controls for industrial automation, with more than 12,000 employees in 56 national headquarters serving more than 180 countries. For more than 80 years, Festo has continuously elevated the state of manufacturing with innovations and optimized motion control solutions that deliver higher performing, more profitable automated manufacturing and processing equipment. Our dedication to the advancement of automation extends beyond technology to the education and development of current and future automation and robotics designers with simulation tools, teaching programs, and on-site services.

Quality Assurance, ISO 9001 and ISO 14001 Certifications

Festo Corporation is committed to supply all Festo products and services that will meet or exceed our customers' requirements in product quality, delivery, customer service and satisfaction.

To meet this commitment, we strive to ensure a consistent, integrated, and systematic approach to management that will meet or exceed the requirements of the ISO 9001 standard for Quality Management and the ISO 14001 standard for Environmental Management.



© Copyright 2008, Festo Corporation. While every effort is made to ensure that all dimensions and specifications are correct, Festo cannot guarantee that publications are completely free of any error, in particular typing or printing errors. Accordingly, Festo cannot be held responsible for the same. For Liability and Warranty conditions, refer to our "Terms and Conditions of Sale", available from your local Festo office. All rights reserved. No part of this publication may be reproduced, distributed, or transmitted in any form or by any means, electronic, mechanical, photocopying or otherwise, without the prior written permission of Festo. All technical data subject to change according to technical update.



Printed on recycled paper at New Horizon Graphic, Inc., FSC certified as an environmentally friendly printing plant.

Festo North America

Festo Regional Contact Center

5300 Explorer Drive
Mississauga, Ontario L4W 5G4
Canada

USA Customers:

For ordering assistance,

Call: 1.800.99.FESTO (1.800.993.3786)

Fax: 1.800.96.FESTO (1.800.963.3786)

Email: customer.service@us.festo.com

For technical support,

Call: 1.866.GO.FESTO (1.866.463.3786)

Fax: 1.800.96.FESTO (1.800.963.3786)

Email: product.support@us.festo.com

Canadian Customers:

Call: 1.877.GO.FESTO (1.877.463.3786)

Fax: 1.877.FX.FESTO (1.877.393.3786)

Email: festo.canada@ca.festo.com

USA Headquarters

Festo Corporation
395 Moreland Road
P.O. Box 18023
Hauppauge, NY 11788, USA
www.festo.com/us

USA Sales Offices

Appleton

North 922 Tower View Drive, Suite N
Greenville, WI 54942, USA

Boston

120 Presidential Way, Suite 330
Woburn, MA 01801, USA

Chicago

1441 East Business Center Drive
Mt. Prospect, IL 60056, USA

Dallas

1825 Lakeway Drive, Suite 600
Lewisville, TX 75057, USA

Detroit – Automotive Engineering Center

2601 Cambridge Court, Suite 320
Auburn Hills, MI 48326, USA

New York

395 Moreland Road
Hauppauge, NY 11788, USA

Silicon Valley

4935 Southfront Road, Suite F
Livermore, CA 94550, USA

United States



USA Headquarters, East: Festo Corp., 395 Moreland Road, Hauppauge, NY 11788

Phone: 1.631.435.0800; Fax: 1.631.435.8026;

Email: info@festo-usa.com

www.festo.com/us

Canada



Headquarters: Festo Inc., 5300 Explorer Drive, Mississauga, Ontario L4W 5G4

Phone: 1.905.624.9000; Fax: 1.905.624.9001;

Email: festo.canada@ca.festo.com

www.festo.ca

Mexico



Headquarters: Festo Pneumatic, S.A., Av. Ceylán 3, Col. Tequesquahuac,
54020 Tlalneantla, Edo. de México

Phone: 011 52 [55] 53 21 66 00; Fax: 011 52 [55] 53 21 66 65;

Email: festo.mexico@mx.festo.com

www.festo.com/mx

Central USA

Festo Corporation
1441 East Business
Center Drive
Mt. Prospect, IL 60056, USA
Phone: 1.847.759.2600
Fax: 1.847.768.9480



Western USA

Festo Corporation
4935 Southfront Road,
Suite F
Livermore, CA 94550, USA
Phone: 1.925.371.1099
Fax: 1.925.245.1286



Festo Worldwide

Argentina Australia Austria Belarus Belgium Brazil Bulgaria Canada Chile China Colombia Croatia Czech Republic Denmark
Estonia Finland France Germany Great Britain Greece Hong Kong Hungary India Indonesia Iran Ireland Israel Italy Japan Latvia
Lithuania Malaysia Mexico Netherlands New Zealand Norway Peru Philippines Poland Romania Russia Serbia Singapore
Slovakia Slovenia South Africa South Korea Spain Sweden Switzerland Taiwan Thailand Turkey Ukraine United States Venezuela

www.festo.com