

Modular electrical terminal CPX



Terminal CPX

Key features

FESTO

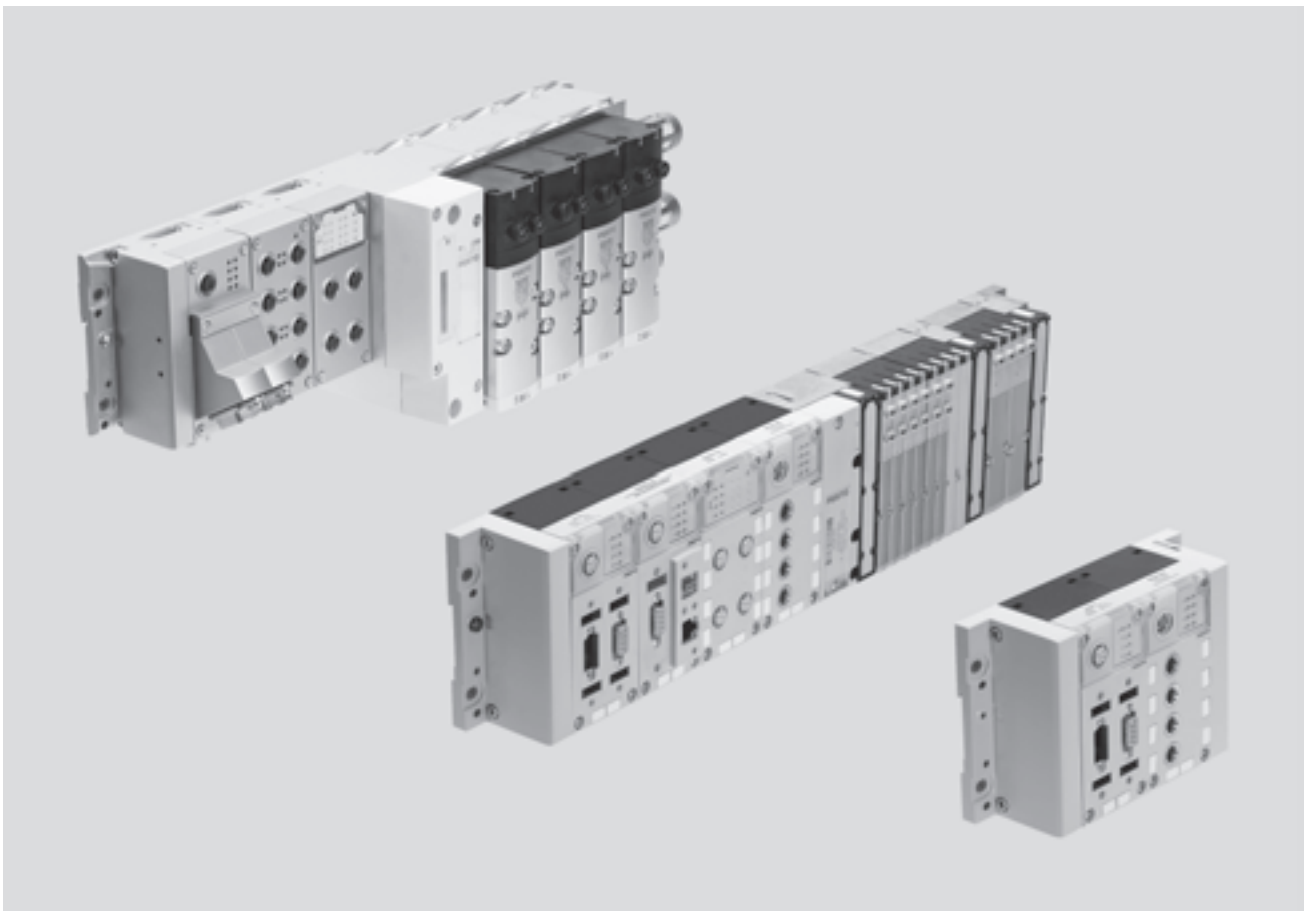

| Key features | | | |
|---|--|---|--|
| Installation concept | Electrical components | Assembly | Operation |
| <ul style="list-style-type: none"> Choice of several valve terminal types for different applications: <ul style="list-style-type: none"> CPA MPA-S Type 32 MPA/MPA-F MPA-F MPA-L Economical from the smallest configuration up to the maximum number of modules Up to 9 electrical input/output modules plus bus nodes and pneumatic interface/electronic modules for valves Extensive range of functions and connection options for the electrical modules Choice of connection technology for technically and economically optimised connections Can be used as a dedicated remote I/O module | <ul style="list-style-type: none"> High operating voltage tolerance ($\pm 25\%$) Choice of M18, 7/8" or AIDA push-pull connection for power supply Open to all fieldbus protocols and Ethernet Optional function and technology modules for preprocessing IT services and TCP/IP such as remote maintenance, remote diagnostics, web server, text message and e-mail alert Digital inputs and outputs, 4-/8-/16-way, optionally available with individual channel diagnostics Analogue inputs and outputs, 2-/4-way Pressure inputs Temperature inputs Controllers for pneumatic and electrical axes IP65 and IP67 or IP20 | <ul style="list-style-type: none"> Wall or H-rail mounting, also on mobile systems Conversions/extensions are possible at any time, individual linking with CPX metal design Modular system offering a range of configuration options Fully assembled and tested unit Lower selection, ordering, assembly and commissioning costs thanks to the central CPX terminal Choice of pneumatic components for optimised control loop system design Decentralised, subordinate CPI installation system improves cycle times by up to 30% Safe and convenient earthing thanks to earthing plate | <ul style="list-style-type: none"> Fast troubleshooting thanks to an extensive selection of LEDs (some of which are multi-coloured) on the bus node and on all I/O modules Suitable for direct machine mounting (IP65/IP67) or in a control cabinet with a terminal connection (IP20) Supports module and channel-oriented diagnostics On-the-spot diagnostics in plain text via handheld device Fieldbus/Ethernet remote diagnostics Innovative diagnostic support with integrated web server/web monitor or maintenance tool with USB adapter for PC Optimised commissioning thanks to parameterisable functions Reliability of service with connection blocks and modules that are quick to replace without changing the wiring |

Terminal CPX

Key features

FESTO

Pneumatic variants of the CPX terminal

The electrical CPX terminal is a modular peripheral system for valve terminals.

The system is specifically designed so that the valve terminal can be adapted to suit different applications.

The modular system design lets you configure the number of valves, inputs and additional outputs to suit the application.

With valve terminal – decentralised

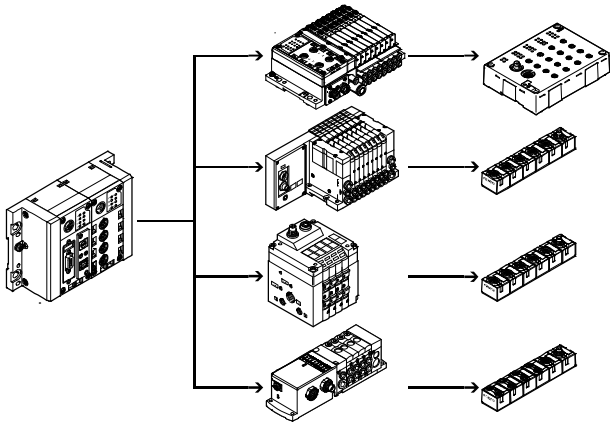

With valve terminal MPA-S – centralised

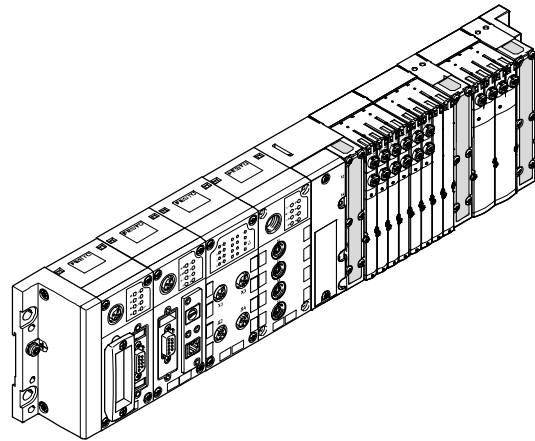

With valve terminal VTSA – centralised

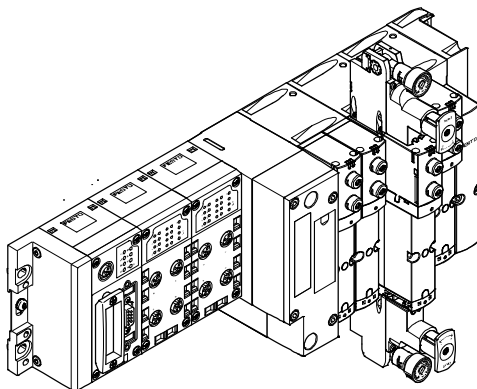

In metal design with valve terminal VTSA – centralised

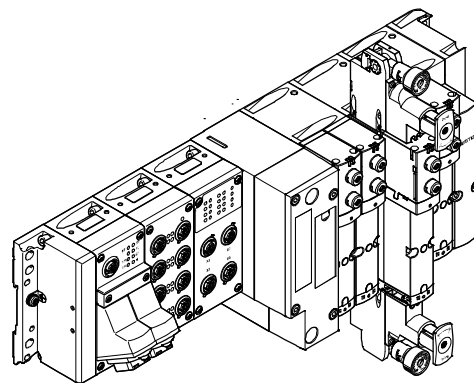

With valve terminal CPA – centralised

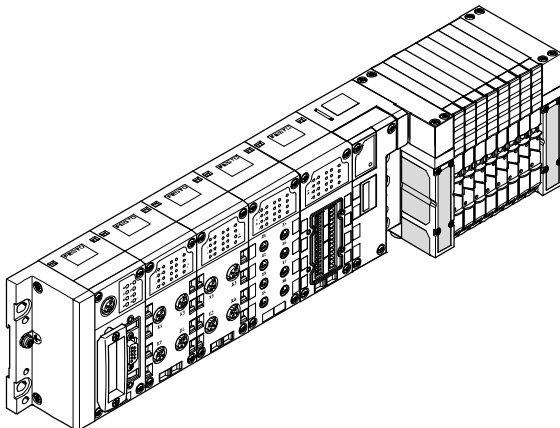

Terminal CPX

Key features

Variants of the CPX terminal controller (with bus node, without preprocessing)

Bus node

Different bus nodes are used to integrate the terminal in the control systems of various manufacturers. The CPX terminal can therefore be operated on over 90% of the most commonly used fieldbus systems:

- PROFIBUS DP
- PROFINET
- INTERBUS

- DeviceNet
- CANopen
- CC-Link

Integration in universal networks based on Ethernet opens up new possibilities. Faster data transmission, real-time capability and above all additional IT services such

as file transfer, web server, web monitor as integrated website in the CPX terminal, text message/e-mail alerts, etc. open up a wide range of synergies.

These include standardised and universal communication technology across all areas, including operating level, management level and field

level in the production environment, with protection to IP65, IP67.

The following protocols are supported:

- EtherNet/IP
- Modbus/TCP
- PROFINET
- POWERLINK
- EtherCAT
- Sercos III

Bus node

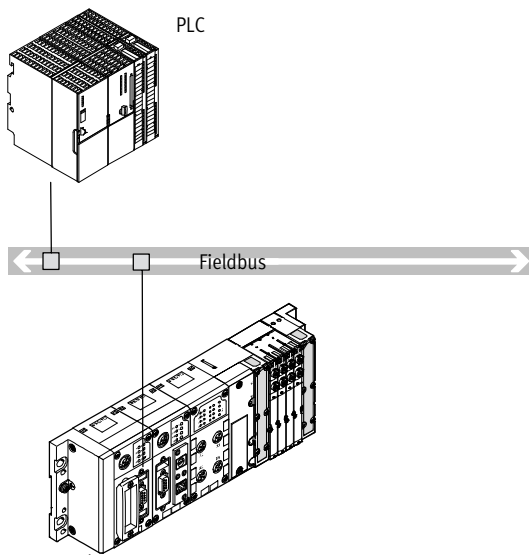

- Communication with higher-order controller via fieldbus
- No preprocessing

- Fieldbus protocol dependent on CPX bus node used
- Up to 90 I/Os, depending on the bus node used

Industrial Ethernet bus node

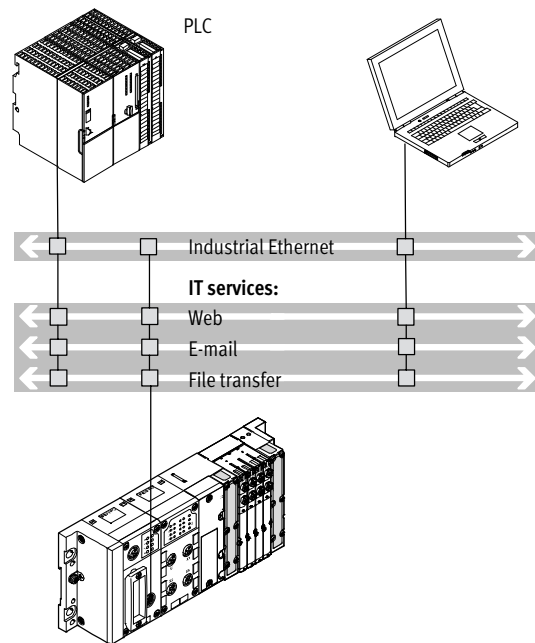

- Connection to a higher-order controller directly via EtherNet/IP, Modbus/TCP, POWERLINK, EtherCAT or PROFINET

- No preprocessing
- Monitoring via Ethernet and web applications
- Up to 300 I/Os

Note

Every electrical connection can be combined with an appropriate number of I/O modules and/or pneumatic components, depending on its address capacity.

Likewise, every pneumatic variant of the CPX terminal can be operated with every electrical connection variant.

Terminal CPX

Key features

Variants of the CPX terminal controller (with preprocessing in the control block)

Control block

The optional Front End Controllers CPX-FEC and CPX-CEC enable simultaneous access via Ethernet and an integrated web server (in the

case of CPX-FEC), in parallel with a bus node, as well as autonomous preprocessing. Access via Modbus/TCP and EasyIP is also possible.

Commissioning, programming and diagnostics using the Festo software tool FST 4.1 with hardware configurator.

With control block in stand-alone mode

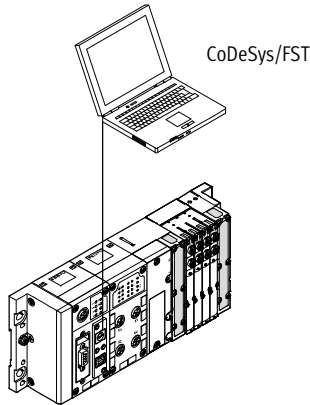

- Decentralised controller with direct machine mounting
- Interaction options via CPX-MMI or Front End Display (FED)
- Downloading of programs via Ethernet (or via the programming interface)
- Supports full expansion of all CPX peripherals
- More than 300 I/Os

Beneficial application areas:

- Stand-alone individual workstations
- Interlinked, stand-alone sub-systems
- Automation using IT technology

With control block in Festo EasyIP mode

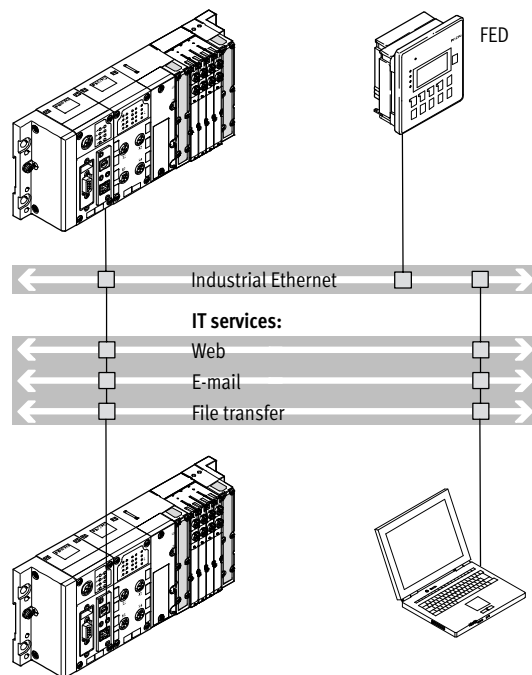

- Fast preprocessing of the CPX peripherals in the control block
- Exchange of any data between the control blocks via EasyIP
- Operation and monitoring of several control blocks via one FED
- Remote diagnostics

- No higher-order controller is required
- More than 300 I/Os per CPX control block

Terminal CPX

Key features

Variants of the CPX terminal controller (with preprocessing in the control block)

With control block as remote controller on Ethernet

Remote controller on Ethernet as the preprocessing unit for decentralised, stand-alone subsystems using IT technology.

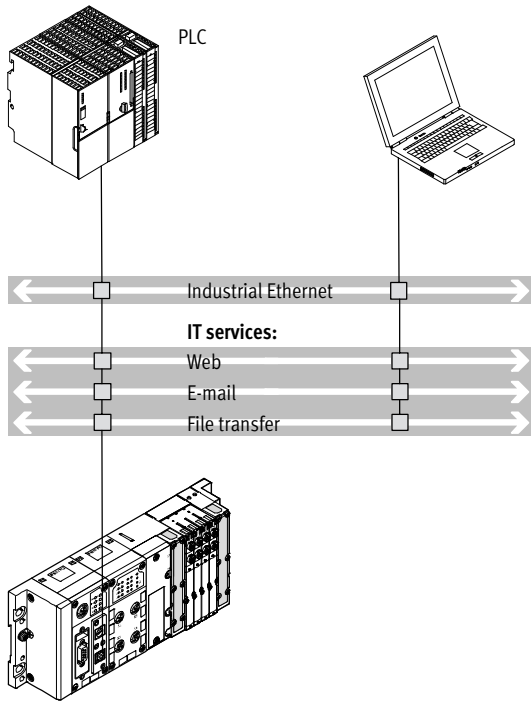

- Connection to a higher-order controller via Ethernet, no further bus node is required
- Monitoring via Ethernet and web applications
- Preprocessing of the CPX peripherals by CPX control block
- More than 300 I/Os

With control block as remote controller on the fieldbus

Fieldbus remote controller (combination with bus nodes for INTERBUS, PROFIBUS DP, PROFINET, CANopen, DeviceNet, CC-Link, POWERLINK, Sercos III or EtherCAT) as the preprocessing unit for decentralised, stand-alone subsystems.

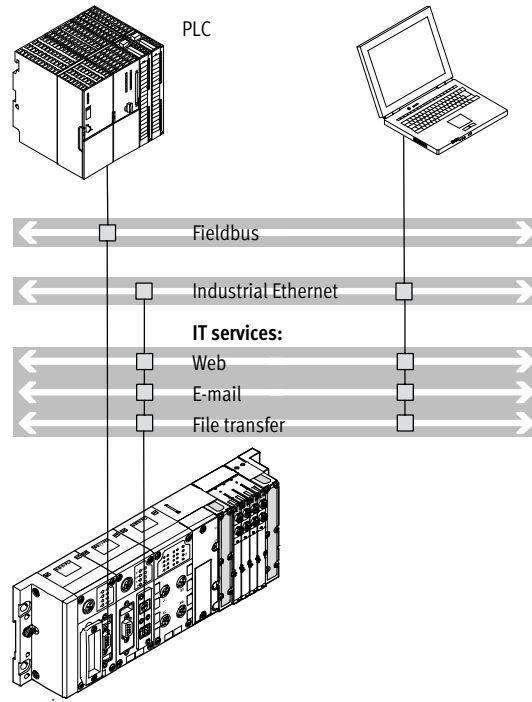

- Fast preprocessing of the CPX peripherals in the control block
- Communication with higher-order controller via fieldbus
- Optional additional monitoring via Ethernet and web applications
- Downloading of programs via programming interface
- More than 300 I/Os, bus node is only used for communication with the higher-order PLC
- Two bus nodes for redundant communication configuration

Terminal CPX

Key features

Variants of the CPX terminal controller (with preprocessing in the control block)

With control block as CANopen fieldbus master

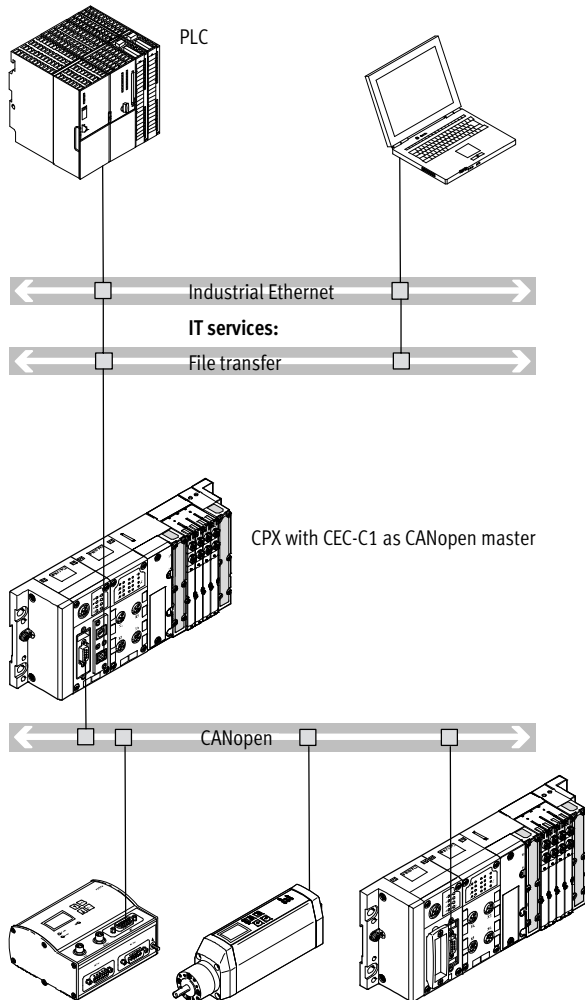

Properties:

- Connection to a higher-order controller via Ethernet, no further bus node is required
- Monitoring via Ethernet
- Preprocessing of the CPX peripherals by CPX control block
- More than 300 I/Os
- Up to 128 stations with repeater technology on CANopen

Operating modes:

- Remote controller on Ethernet
- Control block in Festo EasyIP mode

Terminal CPX

Key features



Connection of inputs and outputs to the CPX terminal

Digital and analogue CPX I/O modules

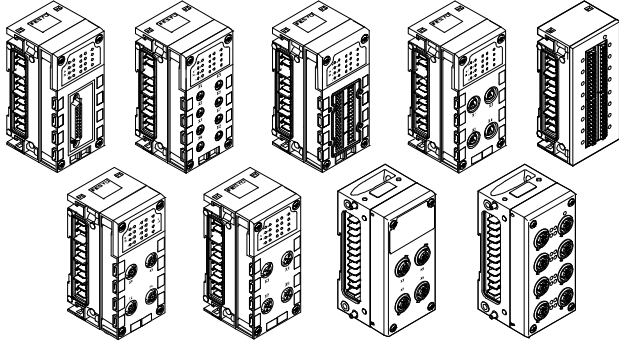

Electrical connection

The connection technology for sensors and additional actuators offers a wide range of digital and analogue input and output modules and is freely selectable – as appropriate to your standard or application. Plastic or metal connection blocks can be combined as required:

- Metal design
 - M12-5POL
- Plastic design:
 - M12-5POL
 - M12-5POL with quick lock and metal thread
 - M12-8POL
 - M8-3POL
 - M8-4POL
 - Sub-D
 - Harax®
 - CageClamp® (with cover also to IP65, IP67)

With CPX-CP interface

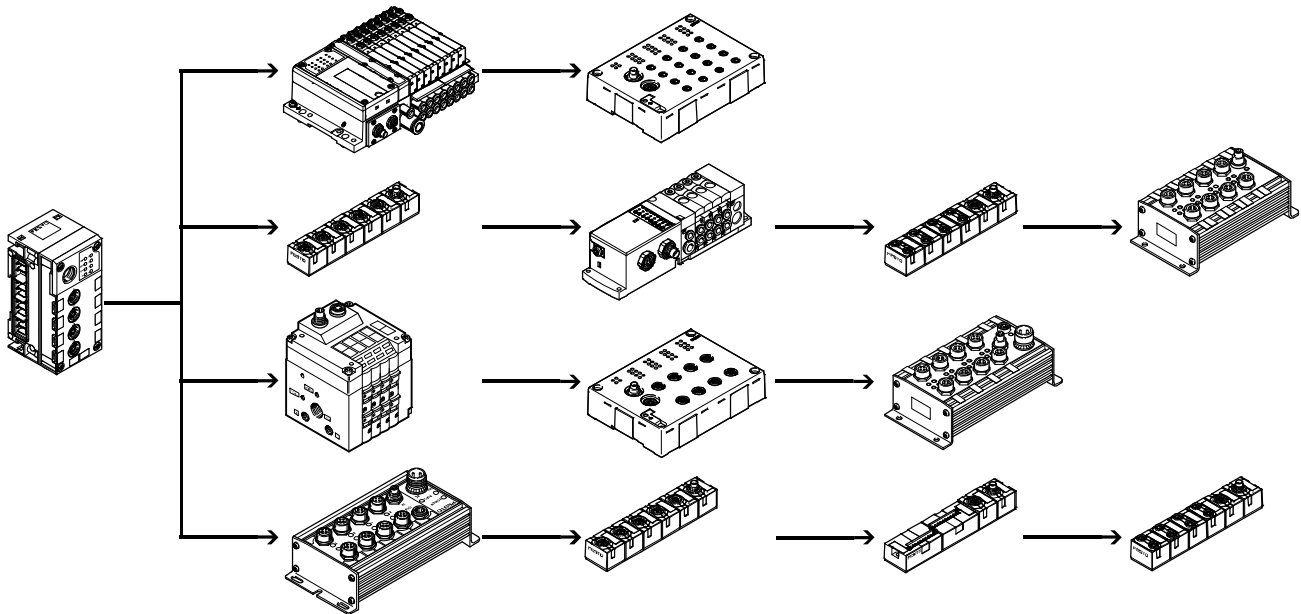

- Up to 4 strings per CP interface possible
- Up to 4 subordinate CP modules can be combined in one string
- Up to 32 I/Os can be connected per string
- Modules with M8, M12 and terminal connection
- Several CP interface modules can be combined in one CPX terminal (depending on the controller used).
- Combination of centralised CPX I/O modules and decentrally mounted I/O modules of the CPI installation system.

Combined centralised and decentralised electrical connection (valve terminal with CP interface/output module)

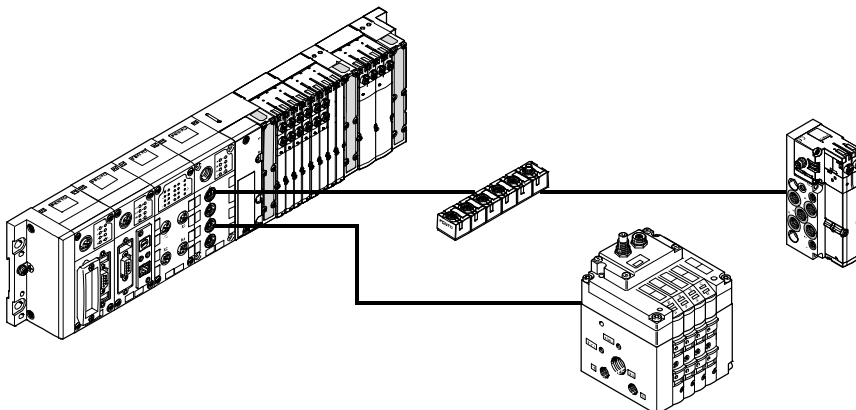

- Scalable to different requirements within a system
- One control interface in the system, reduces installation complexity with closely and widely spaced actuators
- Enables an optimum electrical and pneumatic control chain

Terminal CPX

Key features

Connection of inputs and outputs to the CPX terminal with CPX-CTEL interface

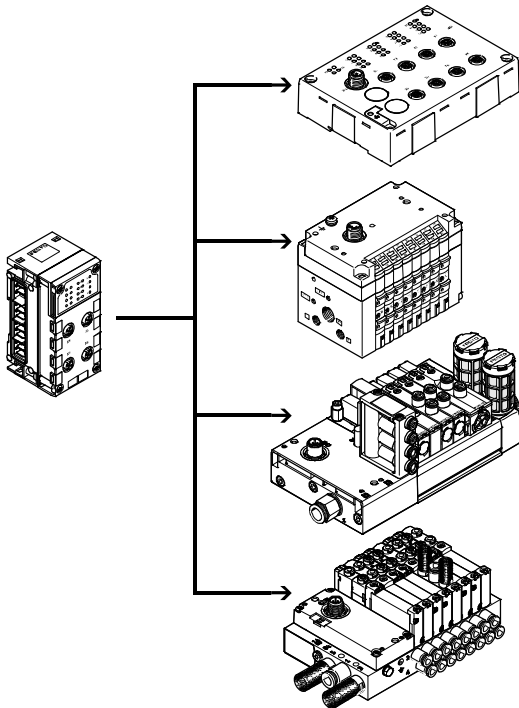

- Up to 4 devices with individual electronic fuse protection per CPX-CTEL master
- Max. 64 inputs/64 outputs per I-Port interface
- The maximum length of a string is 20 m
- Input modules with 16 digital inputs (3-pin M8 and 5-pin M12 connection technology)
- Valve terminals with I-Port interface (up to 48 solenoid coils, different valve functions)

Several CPX-CTEL masters can be combined in one CPX terminal (depending on the controller used). Combination of central CPX I/O modules and decentrally mounted I/O modules with I-Port interface.

With CPX-CTEL-2 interface

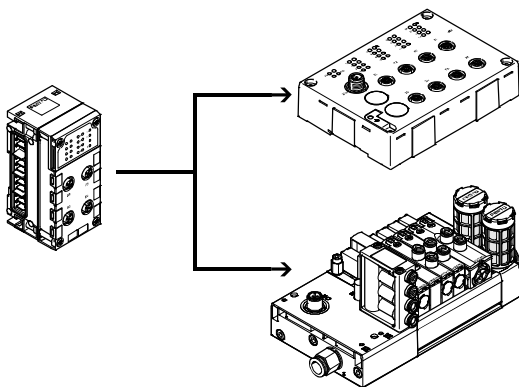

- Up to 2 individual electronically protected IO-Link devices per CPX-CTEL-2 interface
- Max. 16-byte inputs/16-byte outputs per IO-Link device
- The maximum length of a string is 20 m

Several CPX-CTEL-2 interface modules can be combined on one CPX terminal (depending on the controller used). Combination of central CPX I/O modules and decentrally mounted I/O modules with IO-Link interface.

Terminal CPX

Key features

FESTO

Connection of inputs and outputs to the CPX terminal

Electrical drives with CPX-CM-HPP axis interface

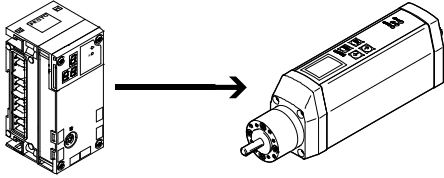

- Max. 4 individual electric axes, per CPX-CM-HPP
- No programming required
- Standardised communication with the drives via the Festo Handling and Positioning Profile (FHPP)
- The control component is independent of the bus node used
- Quick configuration and diagnostics via the operator unit CPX-MMI

Pneumatic drives with CPX-CMAX/CMPX

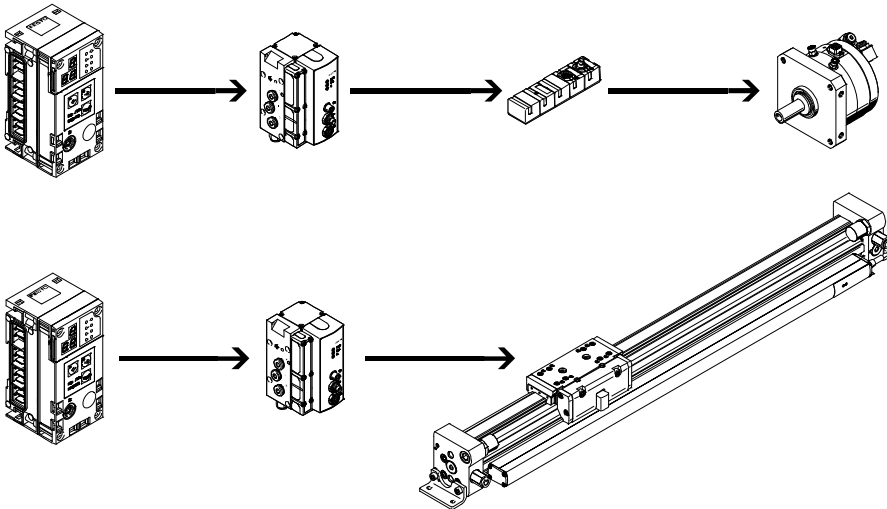

CPX-CMAX

- Position and force control, directly actuated or selected from one of 64 configurable positioning profiles.
- Configurable record continuation enables simple functional sequences to be realised.
- The auto-identification function identifies each station with its device data on the controller.
- Actuation of a brake or clamping unit via the proportional directional control valve VPWP.
- Up to 7 modules (max. 7 axes) can be operated in parallel and independently of each other.
- Commissioning via the Festo configuration software FCT or via fieldbus.

CPX-CMPX

- Fast travel between the mechanical end stops of the cylinder, stopping gently and without impact in the end position.
- Fast commissioning via control panel, fieldbus or handheld unit.
- Improved downtime control.
- Actuation of a brake or clamping unit via the proportional directional control valve VPWP.
- Max. 9 end-position controllers can be actuated depending on the fieldbus.
- All system data can be read and written via the fieldbus, including the mid positions, for example.

Terminal CPX

Key features

FESTO

Ordering

The CPX terminal with valve terminal is fully assembled according to your order specifications and individually tested. The finished valve terminal consists of the electrical peripherals including the desired actuation and the selected components of the VTSA (ISO), VTSA-F, CPA, MPA-S or MPA-L modules.

The CPX terminal with valve terminal is ordered using two separate order codes. One order code defines the electrical peripherals type CPX, while the other specifies the pneumatic components of the valve terminal. The electrical peripherals type CPX can also be configured without a valve terminal and can be used on a fieldbus. For this order, only the order code for the electrical peripherals is required.

The order lists for the pneumatic components can be found on

- ➔ Internet: vtsa (valve terminal VTSA)
- ➔ Internet: vtsa-f (valve terminal VTSA-F)
- ➔ Internet: cpa (valve terminal CPA)
- ➔ Internet: mpa-s (valve terminal MPA-S)
- ➔ Internet: mpa-l (valve terminal MPA-L)

The order lists for the CP/CPI components can be found on

- ➔ Internet: ctec (CPI installation system)

The order lists for the CTEU/CTEL components can be found on

- ➔ Internet: cteu (I-Port interface/IO-Link)

Terminal CPX

Peripherals overview

FESTO

Complete overview of modules

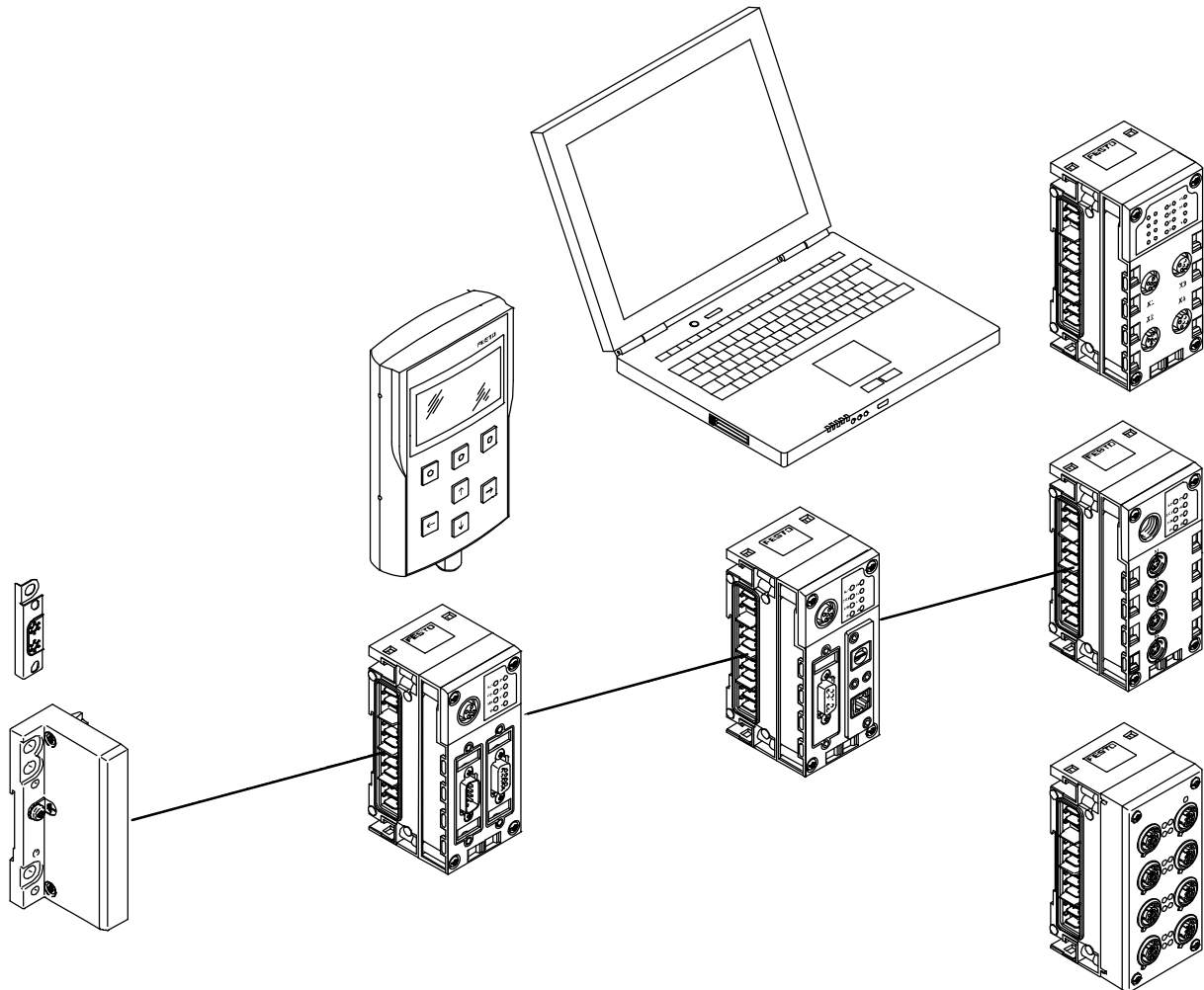

End plate

- Mounting holes for wall mounting
- Functional earth connection
- Special earthing plate for safe and easy connection to the machine bed or H-rail
- External power supply for the entire system

Bus node

- Fieldbus/Industrial Ethernet connection using various types of connection technology
- Setting of fieldbus parameters via DIL switch
- Display of fieldbus and peripheral equipment status via LED
- PROFINET to AIDA standard in metal housing, fast start-up

Operator unit

- Connection to bus nodes or control block
- Display and modification of parameter settings
- Plain-text display for texts, messages (e.g. individual channel diagnostics, condition monitoring), menus, etc.

Control block

- Pre-processing, stand-alone controller or remote unit CPX-FEC/CPX-CEC
- Connection via Ethernet TCP/IP or Sub-D programming interface
- Setting of operating modes via DIL switch and program selection via rotary switch
- CPX-CMX products for controlling axes

Web monitor

- Website integrated in the CPX terminal
- Dynamic status display
- Online diagnostics
- SMS/e-mail alert

CP interface/CTEL interface

- Interfaces for decentralised installation systems, thus optimising the pneumatic control chains (short tubes/short cycle times)
- Actuation for I/O modules and valve terminals
- Power supply and bus interface via the same cable

Input/output modules

- Combination of
- Interlinking block
 - Electronics module
 - Connection block

Terminal CPX

Peripherals overview

FESTO

Complete overview of modules

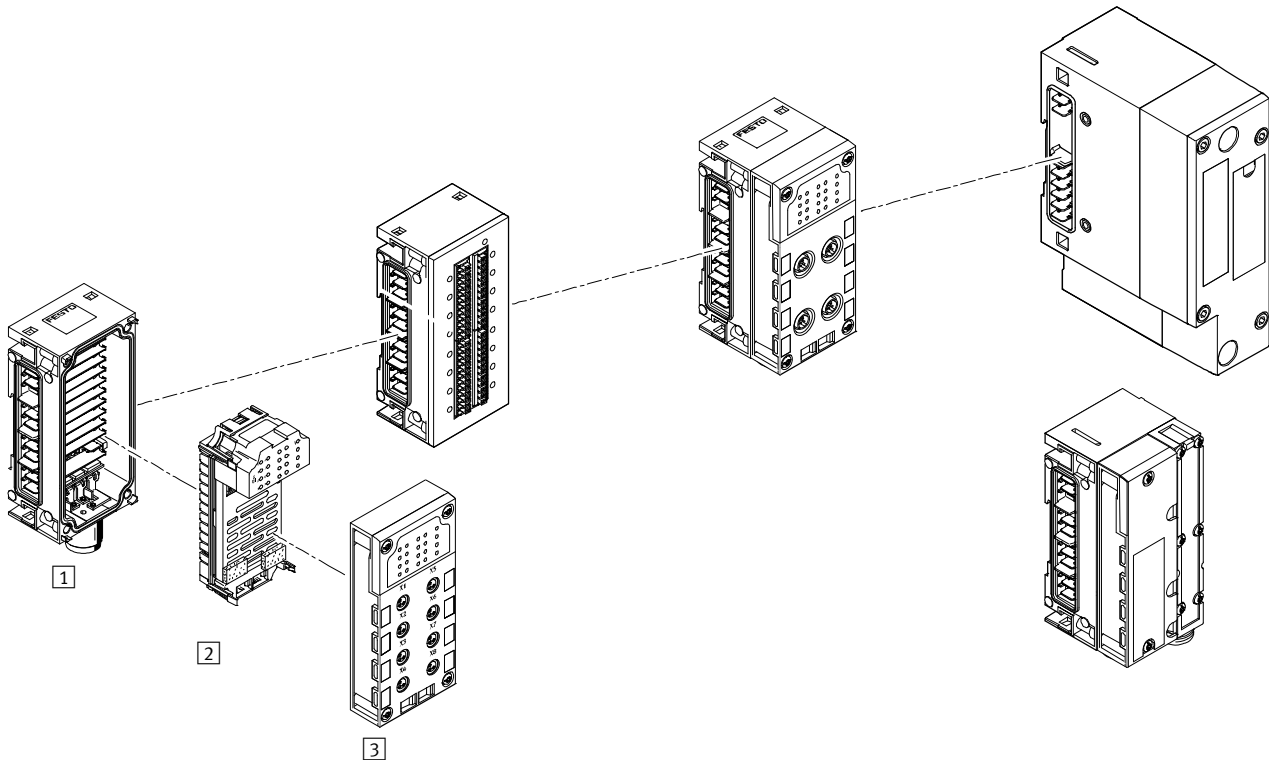

Input/output modules

1 Interlinking block

- Internal linking of the power supply and serial communication
- External power supply for the entire system
- Additional power supply for outputs or valves
- Connection accessories for M18, 7/8" or AIDA push-pull
- Plastic design: linking with tie rods
- Metal design: individual linking with M6 screws, individually expandable

2 Electronics module

- Digital inputs for connecting the sensors
- Digital outputs for activating additional actuators
- Analogue inputs
- Temperature inputs (analogue)
- Analogue outputs
- PROFIsafe input module for safety-oriented sensor technology
- PROFIsafe shut-off module with two digital outputs for shutting off the supply voltage for valves

3 Connection block

- Choice of 8 connection technology variants
- Protection class IP65, IP67 or IP20
- Can be combined with the electronics modules
- M8/M12/Sub-D/quick connection
- M8/M12/Sub-D, etc. connecting cables
- Modular system for M8/M12 connecting cables
- M12 connection technology for the metal design

Pneumatics interface

- Actuation of the solenoid coils
- MPA-S
- MPA-F
- MPA-L
- VTSA/VTSA-F
- CPA
- Actuation of pressure sensors
- Actuation of proportional pressure regulators

Terminal CPX

Peripherals overview

FESTO

Individual overview of modules

Bus node

→ 71

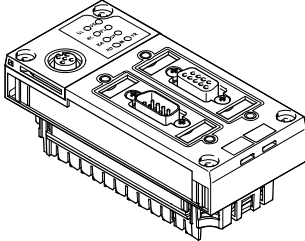

- Bus node for
- PROFIBUS DP
 - INTERBUS
 - DeviceNet
 - CANopen
 - CC-LINK

- Ethernet/IP
- PROFINET
- POWERLINK
- EtherCAT
- Sercos III

Control block

→ 59

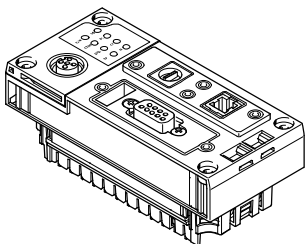

- CPX-FEC
- Programming with FST
 - Ethernet interface
 - Modbus/TCP
 - EasyIP
 - Integrated web server
 - Sub-D programming interface

- CPX-CEC
- Programming with CODESYS
 - Ethernet interface
 - Modbus/TCP
 - EasyIP
 - CANopen master

CP interface

→ 132

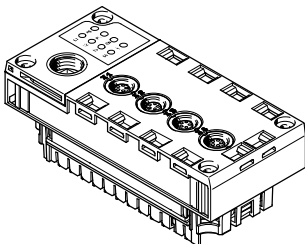

- Interface CPX-CP
- 4 CP strings
 - Max. 4 modules per string
 - 32 inputs/32 outputs per string
 - CPI functionality

CTEL interface

→ 137

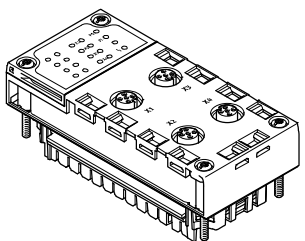

- CPX-CTEL interface
- CTEL master
 - Max. 4 devices with individual electronic fuse protection
 - Max. 64 inputs/64 outputs per I-Port interface
 - The maximum length of a string is 20 m

Electrical interface CPX-CTEL-2

→ 142

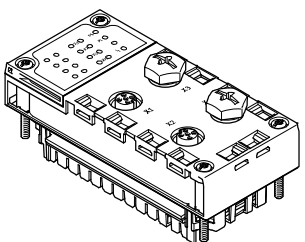

- Interface CPX-CTEL-2
- Master for IO-Link
 - Max. 2 devices with individual electronic protection
 - Process data length of the inputs and outputs is limited to 16 bytes for inputs and 16 bytes for outputs per port
 - The maximum length of a string is 20 m

Terminal CPX

Peripherals overview

FESTO

Individual overview of modules

Modules for actuating electric drive units

→ 146

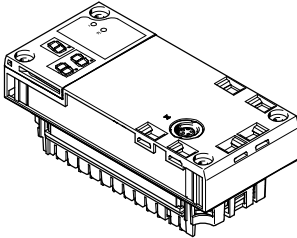

CPX-CM-HPP

- Axis interface
- CAN bus for up to 4 individual electric axes

Modules for controlling pneumatic drive units

→ 149

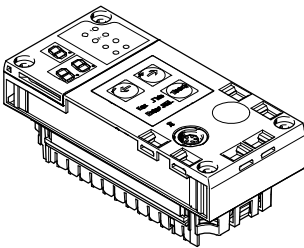

CPX-CMAX

- Axis controller
- Position and force control
- 64 configurable positioning records
- Auto-identification
- Control of a brake or clamping unit via the proportional directional control valve VPWP

CPX-CMPX

- End-position controller
- Fast travel between the mechanical end stops of the cylinder
- Smooth travel into the end position
- Improved control of downtime
- Control of a brake via the proportional directional control valve VPWP

CPX-CMIX

- Measuring module
- CAN input (Festo specification) for measuring signal
- Recording of the absolute position values or speed values of the connected drive

Plastic connection block

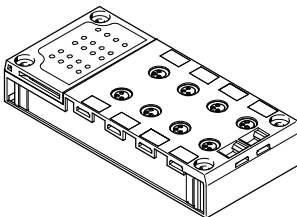

Direct machine mounting
(protection class IP65, IP67)

- M8-3POL
- M8-4POL
- M12-5POL
- M12-5POL quick lock, metal thread screened
- M12-8POL
- Sub-D
- Quick connector
- Spring-loaded terminal with cover

Protected fitting space
(protection class IP20)

- Spring-loaded terminal

Screening concept

- Optional screening plate for connection blocks with M12 connection technology

Metal manifold block

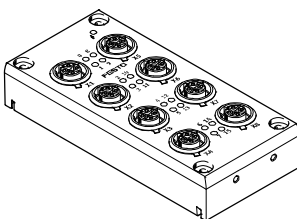

Direct machine mounting
(protection class IP65, IP67)

- M12-5POL

Connection block including electronics module and interlinking block

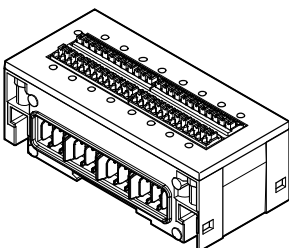

Installation in the control cabinet
(protection class IP20)

- Plastic connection block
- Spring-loaded terminal
- Digital input module with 16 inputs
- Digital I/O module with 8 inputs and 8 outputs

Terminal CPX

Peripherals overview

Individual overview of modules

Digital electronics module for inputs/outputs

→ 158

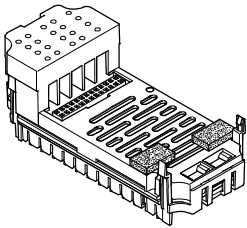

Digital inputs

- 4 digital inputs
- 8 digital inputs NPN
- 8 digital inputs PNP
- 8 digital inputs PNP with individual channel diagnostics
- 16 digital inputs
- 16 digital inputs with individual channel diagnostics

Digital outputs

- 4 digital outputs (1 A per channel, individual channel diagnostics)
- 8 digital outputs (0.5 A per channel, individual channel diagnostics)
- 8 digital outputs (2.1 A/50 W lamp load per channel pair, individual channel diagnostics)

Multi I/O modules

- 8 digital inputs and 8 digital outputs
- 2 digital inputs (counter channels, connection to various encoders) and 2 digital outputs (directly controlled by the input values)

Analogue electronics module for inputs/outputs

→ 191

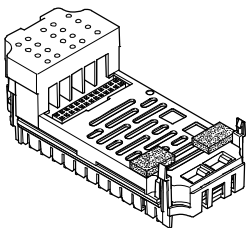

Analogue inputs

- 2 analogue inputs (0 ... 10 V DC, 0 ... 20 mA, 4 ... 20 mA)
- 4 analogue inputs (1 ... 5 V, 0 ... 10 V, -5 ... +5 V, -10 ... +10 V, 0 ... 20 mA, 4 ... 20 mA, -20 ... +20 mA)

Analogue temperature inputs

- 4 analogue inputs for temperature measurement (Pt100, Pt200, Pt500, Pt1000, Ni100, Ni120, Ni500, Ni1000)
- 4 analogue inputs for temperature measurement (thermocoupler and PT1000 sensor for cold-junction compensation)

Analogue outputs

- 2 analogue outputs (0 ... 10 V DC, 0 ... 20 mA, 4 ... 20 mA)

PROFIsafe input module



→ 163

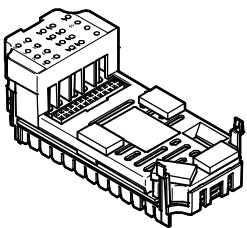

Digital inputs

- 8 digital inputs
- 11 function modes
- 5 independent clock outputs

PROFIsafe shut-off module

→ 210

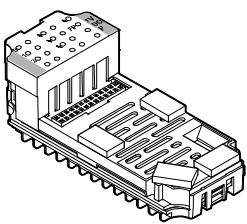

Digital outputs

- 2 digital outputs
- Supply voltage for valves can be shut off

Analogue electronics module for pressure inputs

→ 196

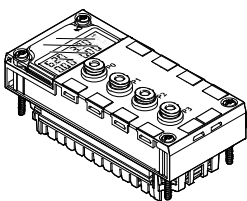

Analogue inputs

- 4 analogue supply ports (0 ... 10 bar, -1 ... +1 bar)

Terminal CPX

Peripherals overview

Individual overview of modules

Plastic interlinking block – Interlinking by means of tie rods

→ 219

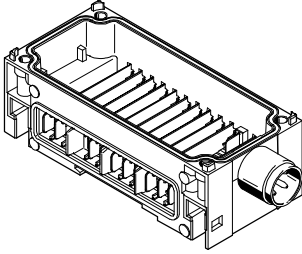

System linking

- Different voltages for supplying the modules
- Serial communication between the modules

In addition to system linking, power supply for the

- electronics plus sensors (16 A)
- valves plus actuators (16 A)

Power supply for the

- valves (16 A per supply)

Expandability

- Can be expanded using an interlinking block with tie-rod extension CPX-ZA-1-E

System supply

- M18 4-pin
- 7/8" 4-pin or 5-pin

Additional power supply

In addition to system linking, power supply for the

- actuators (16 A per supply)

Metal interlinking block – Individual linking

→ 219

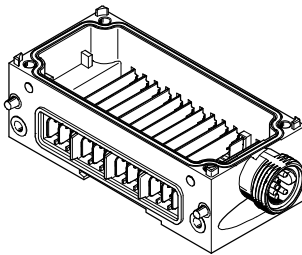

System linking

- Different voltages for supplying the modules
- Serial communication between the modules

In addition to system linking, power supply for the

- electronics plus sensors (16 A)
- valves plus actuators (16 A)

Power supply for the

- valves (16 A per supply)

Expandability

- Can be expanded as required by up to 10 interlinking blocks

System supply

- 7/8" 4-pin or 5-pin
- AIDA push-pull

Additional power supply

In addition to system linking, power supply for the

- actuators (16 A per supply)

- Note

Plastic interlinking blocks (tie rods) and metal interlinking blocks (individual linking) cannot be combined due to their different interlinking systems.

- Note

The 7/8" supply is subject to the following restriction due to the available accessories:

- 5-pin 8 A
- 4-pin 10 A

- Note

The usage of appropriate interlinking blocks (CPX-...-VL) is required for use in ATEX environments as per approval certificate (→ 46). The maximum supply is limited to 8 A for these modules.

Terminal CPX

Peripherals overview

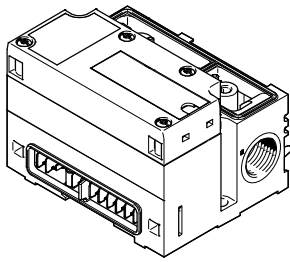

- Valve terminal
- MPA1 (360 l/min)
 - MPA2 (700 l/min)
 - Up to 128 solenoid coils
 - Up to 16 modules can be configured
 - For CPX plastic design
 - For CPX metal design
 - Actuation of pressure sensors
 - Proportional pressure regulators
 - Pressure sensors
 - Proportional pressure regulators

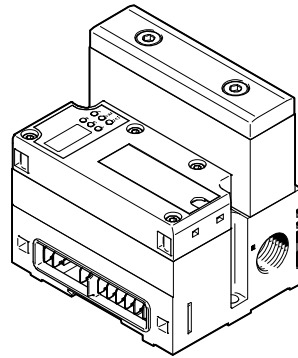

- Valve terminal
- MPAF1 (360 l/min)
 - MPAF2 (900 l/min)
 - Up to 128 solenoid coils
 - Up to 16 modules can be configured
 - With integrated pressure sensor for channel 1
 - For CPX plastic design
 - For CPX metal design

Individual overview of modules

Pneumatic interface MPA-S

→ 233

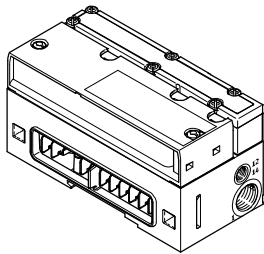

- Valve terminal
- MPA1 (360 l/min)
 - MPA2 (700 l/min)
 - Up to 128 solenoid coils
 - Up to 16 modules can be configured
 - For CPX plastic design
 - For CPX metal design
 - Actuation of pressure sensors
 - Proportional pressure regulators
 - Pressure sensors
 - Proportional pressure regulators

Pneumatic interface MPA-L

→ 235

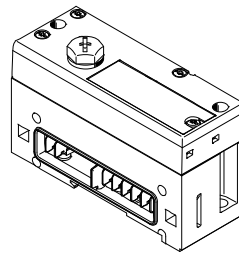

- Valve terminal
- MPA1 (360 l/min)
 - MPA14 (670 l/min)
 - MPA2 (870 l/min)
 - Up to 32 solenoid coils
 - For CPX plastic design

Pneumatic interface MPA-F

→ 236

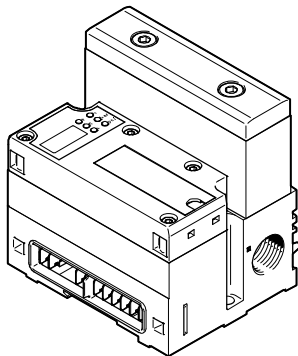

- Valve terminal
- MPAF1 (360 l/min)
 - MPAF2 (900 l/min)
 - Up to 128 solenoid coils
 - Up to 16 modules can be configured
 - With integrated pressure sensor for channel 1
 - For CPX plastic design
 - For CPX metal design

Pneumatic interface VTSA/VTSA-F

→ 238

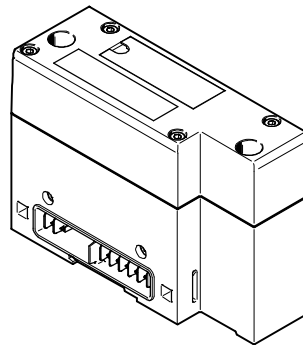

- Valve terminal (valve flow rate according to width)
- 18 mm (700 l/min)
 - 26 mm (1350 l/min)
 - 42 mm (1300 l/min)
 - 52 mm (2900 l/min)
 - 65 mm (4000 l/min)
 - Max. 32 valve positions/
max. 32 solenoid coils
 - For CPX plastic design
 - For CPX metal design

Pneumatic interface CPA

→ 241

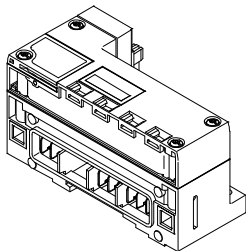

- Valve terminal
- CPA14 (600 l/min)
 - Up to 22 solenoid coils
 - Setting of the number of valves via DIL switch
 - For CPX plastic design

Terminal CPX

Peripherals overview

FESTO

Individual overview of modules

End plate for plastic/metal design

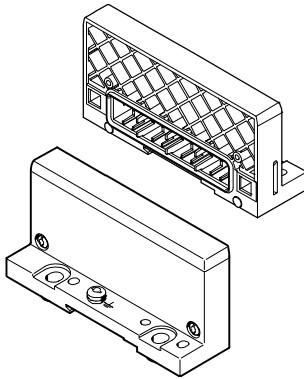

End plate

- Left-hand
- Right-hand (for using of the CPX terminal without valves)

End plate with system power supply

→ 215

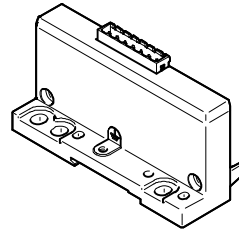

End plate

- Left-hand
- For plastic design
- Different voltages for supplying the CPX terminal

End plate with extension

→ 217

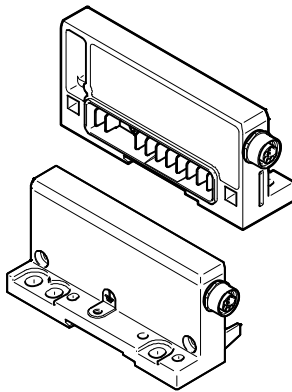

End plate

- Left-hand
- Right-hand
- Enables the CPX terminal to be separated into two interconnected units (series)
- Simplifies control cabinet installation
- For plastic or metal design

Earthing plate (for end plate for plastic design)

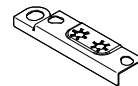

Earthing plate

- For safe and easy connection to the machine bed or H-rail, suitable for right-hand and left-hand end plate
- Assembly and earthing in a single processing step, which means:
 - 50% time saving
 - No additional material required

Terminal CPX

Peripherals overview

General basic data and guidelines

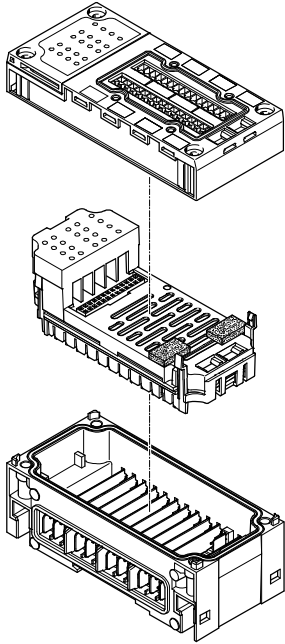

Max. 11 modules in total:

- One bus node and/or one control block, freely positionable
- Up to 9 additional input/output modules, freely positionable
- An additional pneumatic interface always positioned as the last module on the right-hand side
 - With VTSA, VTSA-F, MPA-F and CPA: fixed operating range, set using DIL switch
 - With MPA-S: 16 MPA modules can be configured
 - With MPA-L: fixed operating range, set using rotary switch
- Address capacity max. 512 inputs and 512 outputs, depending on bus node or control block
- One interlinking block with system supply
- Multiple interlinking blocks with additional power supply, always positioned to the right of the interlinking block with system supply
- The connection blocks can, with just a few exceptions, be freely combined with the electronics modules for inputs/outputs, either in metal or plastic (→ table below)
- The electronics modules for inputs/outputs can be combined with various interlinking blocks
- Plastic interlinking blocks (tie rods) and metal interlinking blocks (individual linking) cannot be combined due to their different interlinking systems

Combinations of connection blocks and digital input modules

| | Digital electronics modules | | | | | | | |
|---|-----------------------------|---------|----------|------------|--------------|-----------|----------|------------|
| | CPX-4DE | CPX-8DE | CPX-16DE | CPX-L-16DE | CPX-M-16DE-D | CPX-8DE-D | CPX-8NDE | CPX-F8DE-P |
| Connection blocks, plastic design | | | | | | | | |
| CPX-AB-8-M8-3POL | ■ | ■ | - | - | - | ■ | ■ | - |
| CPX-AB-8-M8X2-4POL | - | - | ■ | - | - | - | - | - |
| CPX-AB-4-M12x2-5POL | ■ | ■ | - | - | - | ■ | ■ | - |
| CPX-AB-4-M12x2-5POL-R | ■ | ■ | - | - | - | ■ | ■ | - |
| CPX-AB-8-M12X2-5POL  | - | - | - | - | ■ | - | - | - |
| CPX-AB-4-M12-8POL | - | - | - | - | - | - | - | - |
| CPX-AB-8-KL-4POL | ■ | ■ | ■ | - | - | ■ | ■ | ■ |
| CPX-AB-1-SUB-BU-25POL | ■ | ■ | ■ | - | - | ■ | ■ | - |
| CPX-AB-4-HAR-4POL | ■ | ■ | - | - | - | ■ | ■ | - |
| CPX-AB-ID-P | - | - | - | - | - | - | ■ | ■ |
| Connection blocks, metal design | | | | | | | | |
| CPX-M-AB-4-M12X2-5POL | ■ | ■ | - | - | - | ■ | ■ | ■ |
| CPX-M-AB-4-M12X2-5POL-T | - | - | - | - | - | - | ■ | ■ |
| CPX-M-AB-8-M12X2-5POL | - | - | - | - | ■ | - | - | - |

Terminal CPX

Peripherals overview

| Combinations of connection blocks and digital output modules/multi I/O modules | | | | | | | |
|---|-----------------------------|---------|-----------|-------------|---------------|------------|-------------|
| | Digital electronics modules | | | | | | |
| | CPX-4DA | CPX-8DA | CPX-8DA-H | CPX-8DE-8DA | CPX-L-8DE-8DA | CPX-2ZE2DA | CPX-FVDA-P2 |
| Connection blocks, plastic design | | | | | | | |
| CPX-AB-8-M8-3POL | ■ | ■ | - | - | - | - | - |
| CPX-AB-8-M8X2-4POL | ■ | ■ | ■ | - | - | - | - |
| CPX-AB-4-M12x2-5POL | ■ | ■ | - | - | - | - | - |
| CPX-AB-4-M12x2-5POL-R | ■ | ■ | ■ | - | - | - | - |
| CPX-AB-8-M12X2-5POL  | - | - | - | - | - | - | - |
| CPX-AB-4-M12-8POL | - | - | - | ■ | - | - | - |
| CPX-AB-8-KL-4POL | ■ | ■ | ■ | ■ | - | - | ■ |
| CPX-AB-1-SUB-BU-25POL | ■ | ■ | ■ | ■ | - | - | - |
| CPX-AB-4-HAR-4POL | ■ | ■ | - | - | - | - | - |
| CPX-AB-ID-P | - | - | - | - | - | - | - |
| Connection blocks, metal design | | | | | | | |
| CPX-M-AB-4-M12X2-5POL | ■ | ■ | ■ | - | - | - | ■ |
| CPX-M-AB-4-M12X2-5POL-T | - | - | - | - | - | - | - |
| CPX-M-AB-8-M12X2-5POL | - | - | - | - | - | - | - |

| Combinations of connection blocks and analogue electronics modules for inputs/outputs | | | | | | | |
|---|------------------------------|-------------|-----------|-------------|-----------|-----------|------------|
| | Analogue electronics modules | | | | | | |
| | CPX-2AE-U-I | CPX-4AE-U-I | CPX-4AE-I | CPX-2AA-U-I | CPX-4AE-P | CPX-4AE-T | CPX-4AE-TC |
| Connection blocks, plastic design | | | | | | | |
| CPX-AB-8-M8-3POL | - | - | - | - | - | - | - |
| CPX-AB-8-M8X2-4POL | - | - | - | - | - | - | - |
| CPX-AB-4-M12x2-5POL | ■ | ■ | ■ | ■ | - | ■ | ■ |
| CPX-AB-4-M12x2-5POL-R | ■ | ■ | ■ | ■ | - | ■ | ■ |
| CPX-AB-8-M12X2-5POL  | - | - | - | - | - | - | - |
| CPX-AB-4-M12-8POL | - | - | - | - | - | - | - |
| CPX-AB-8-KL-4POL | ■ | ■ | ■ | ■ | - | ■ | ■ |
| CPX-AB-1-SUB-BU-25POL | ■ | ■ | ■ | ■ | - | - | - |
| CPX-AB-4-HAR-4POL | - | - | - | - | - | ■ | - |
| CPX-AB-ID-P | - | - | - | - | - | - | - |
| Connection blocks, metal design | | | | | | | |
| CPX-M-AB-4-M12X2-5POL | ■ | ■ | ■ | ■ | - | ■ | ■ |
| CPX-M-AB-4-M12X2-5POL-T | - | - | - | - | - | - | - |
| CPX-M-AB-8-M12X2-5POL | - | - | - | - | - | - | - |

Terminal CPX

Key features – Electrical components

Electrical connection – Connection block

CPX-AB-8-M8-3POL with M8-3POL connection

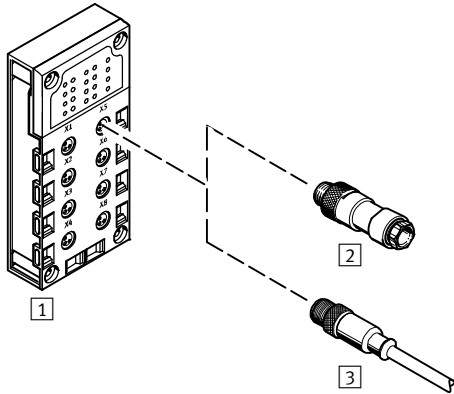

- Compact for pre-assembled individual connection
- 8 sockets
- 3-pin design for connecting 1 channel per socket



Note

Festo delivers pre-assembled M8/M12 connecting cables (NEBU modular system) on request:

- Tailored to the application
- Perfect fit
- Saves installation space

Combination of connection block and electrical connection technology

| Connection block | Connection technology | Plug connector/connecting cable | Selectable connection technology |
|--------------------|-----------------------|---|----------------------------------|
| 1 CPX-AB-8-M8-3POL | Socket, M8, 3-pin | 2 SEA-GS-M8 | Solder lugs |
| | | 2 SEA-3GS-M8-S | Screw terminals |
| | | 3 KM8-M8-GSGD-... (pre-assembled connecting cable) | Socket, M8, 3-pin |
| | | 3 NEBU-...-M8G3 (modular system for choice of connecting cables) | Socket, M5, 3-pin |
| | | | Socket, M8, 3-pin |
| | Socket, M8, 4-pin | | |
| | Socket, M12, 5-pin | | |
| | Open cable end | | |

Terminal CPX

Key features – Electrical components

Electrical connection – Connection block

CPX-AB-8-M8X2-4POL with M8-4POL connection

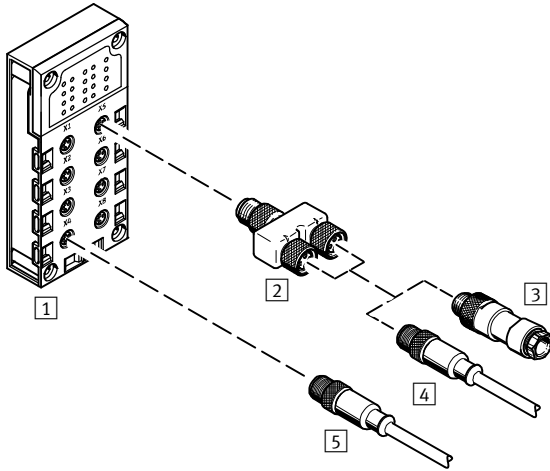

- Compact for pre-assembled individual connection
- 8 sockets
- 4-pin design for connecting 2 channels per socket

| Combination of connection block and electrical connection technology | | | | | |
|--|-----------------------|--|---|--|----------------------------------|
| Connection block | Connection technology | Plug connector/ connecting cable | Selectable connection technology | Plug connector/ connecting cable | Selectable connection technology |
| 1 CPX-AB-8-M8X2-4POL | Socket, M8, 4-pin | 4 NEBU-...-M8G4 (modular system for choice of connecting cables) | Socket, M5, 3-pin | – | – |
| | | | Socket M8, 3-pin | – | – |
| | | | Socket, M8, 4-pin | – | – |
| | | | Socket, M12, 5-pin | – | – |
| | | | Open cable end | – | – |
| | | 2 NEDU-M8D3-M8T4 (T-adapter) | 1x plug M8, 4-pin to 2x socket M8, 3-pin | 3 SEA-GS-M8 | Solder lugs |
| | | | | 3 SEA-3GS-M8-S | Screw terminals |
| | | | | 4 KM8-M8-GSGD-... (pre-assembled connecting cable) | Socket, M8, 3-pin |
| | | | | 4 NEBU-...-M8G3 (modular system for choice of connecting cables) | Socket, M5, 3-pin |
| | | | | | Socket, M8, 3-pin |
| Socket, M8, 4-pin | | | | | |
| Socket, M12, 5-pin | | | | | |
| Open cable end | | | | | |

Terminal CPX

Key features – Electrical components

FESTO

Electrical connection – Connection block

CPX-AB-4-M12x2-5POL and CPX-AB-4-M12x2-5POL-R with M12-5POL connection

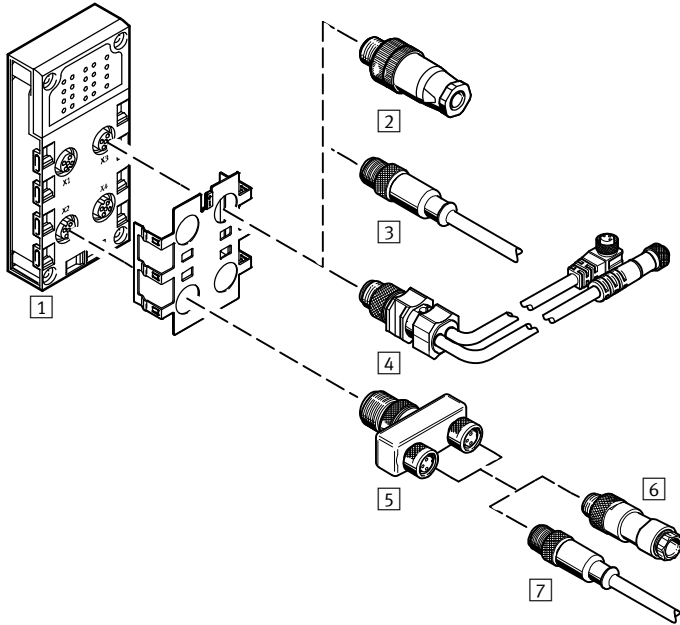

- Suitable for self-assembly and sturdy with 2 channels per connection
- 4 sockets
- 5-pin design per socket
- Version ...-R with quick lock technology and metal thread for screening
- With two channels per connection, the corresponding input signals can be easily connected via a T-adaptor and conventional connecting cables with M8 connection

Terminal CPX

Key features – Electrical components

| Combination of connection block and electrical connection technology | | | | | | | |
|---|-----------------------|--|---|-------------------------------------|-----------------------|--|---------------------------------|
| Connection block | Connection technology | Plug connector/ connecting cable | Connection technology | Plug connector/ connecting cable | Connection technology | | |
| 1 CPX-AB-4-M12x2-5POL CPX-AB-4-M12x2-5POL-R | Socket, M12, 5-pin | 2 SEA-GS-7 | Screw terminals | - | - | | |
| | | 2 SEA-4GS-7-2,5 | Screw terminals | - | - | | |
| | | 2 SEA-GS-9 | Screw terminals | - | - | | |
| | | 2 SEA-M12-5GS-PG7 | Screw terminals | - | - | | |
| | | 2 SEA-GS-11-DUO | Screw terminals, for two cables | - | - | | |
| | | 2 SEA-5GS-11-DUO | Screw terminals, for two cables | - | - | | |
| | | 3 KM12-M12-... (pre-assembled connecting cable) | Socket, M12, 4-pin | - | - | | |
| | | 3 NEBU-...-M12G4 | Socket, M5, 4-pin | - | - | | |
| | | 3 NEBU-...-M12G5 | Socket, M8, 4-pin | - | - | | |
| | | | Socket, M12, 5-pin | - | - | | |
| | | | Open cable end | - | - | | |
| | | 4 KM12-DUO-M8-... (pre-assembled connecting cable) | Plug M12, 4-pin to 2x socket M8, 3-pin | 6 SEA-GS-M8 | Solder lugs | | |
| | | 5 NEDU-M8D3-M12T4 (T-adapter) | | 6 SEA-3GS-M8-S | Screw terminals | | |
| | | 5 NEDU-M12D5-M12T4 (T-adapter) | | | | 7 KM8-M8-GSGD-... (pre-assembled connecting cable) | Socket, M8, 3-pin |
| | | | | | | 7 NEBU-...-M8G3 (modular system for choice of connecting cables) | Socket, M5, 3-pin |
| | | | | | | | Socket, M8, 3-pin |
| | | | | | | | Socket, M8, 4-pin |
| | | | | | | | Socket, M12, 5-pin |
| | | | | | | | Open cable end |
| | | | | | | 6 SEA-GS-7 | Screw terminals |
| | | | | | | 6 SEA-4GS-7-2,5 | Screw terminals |
| | | | | | | 6 SEA-GS-9 | Screw terminals |
| | | | | | | 6 SEA-M12-5GS-PG7 | Screw terminals |
| | | | | | | 6 SEA-GS-11-DUO | Screw terminals, for two cables |
| | | | | | | 6 SEA-5GS-11-DUO | Screw terminals, for two cables |
| | | | | | | 7 KM12-M12-... (pre-assembled connecting cable) | Socket, M12, 4-pin |
| 7 NEBU-...-M12G4 (modular system for choice of connecting cables) | Socket, M5, 4-pin | | | | | | |
| 7 NEBU-...-M12G5 (modular system for choice of connecting cables) | Socket, M8, 4-pin | | | | | | |
| | Socket, M12, 5-pin | | | | | | |
| | Open cable end | | | | | | |

Terminal CPX

Key features – Electrical components

Electrical connection – Connection block (metal design)

CPX-M-AB-4-M12X2-5POL and CPX-M-AB-4-M12X2-5POL-T with M12-5POL connection

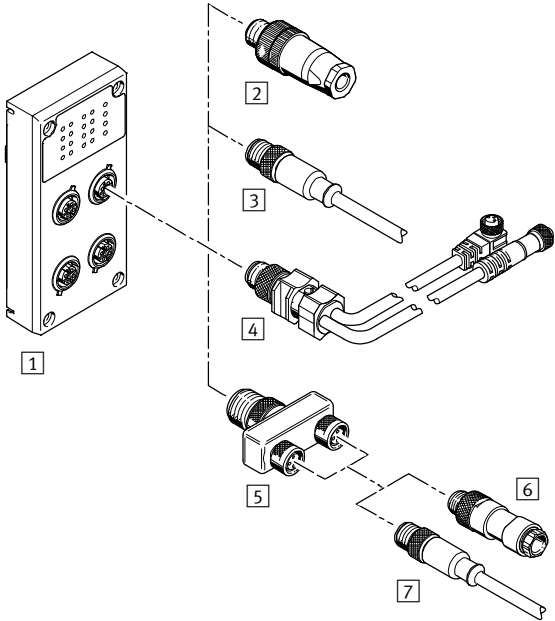

- Suitable for self-assembly and sturdy with 2 channels per connection
- 4 sockets
- 5-pin design per socket
- With two channels per connection, the corresponding input signals can be easily connected via a T-adapter and conventional connecting cables with M8 connection

CPX-M-AB-8-M12X2-5POL and CPX-AB-8-M12X2-5POL with M12-5POL connection

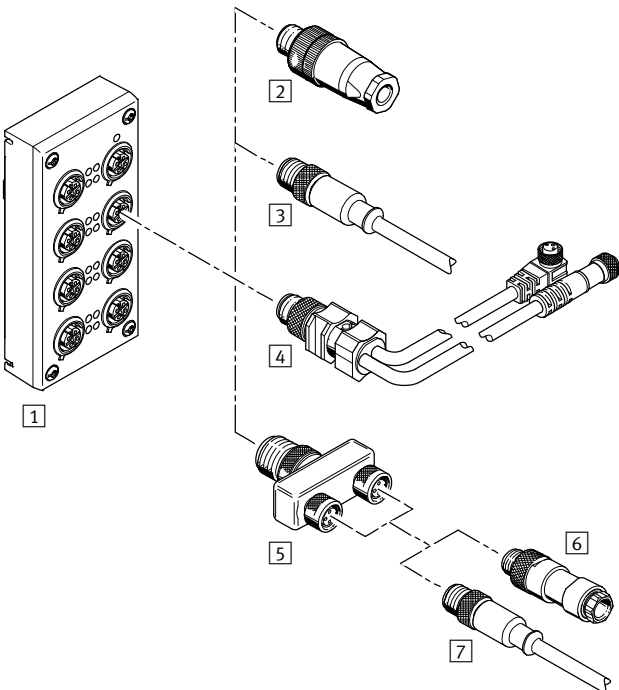

- Suitable for self-assembly and sturdy with 2 channels per connection
- 8 sockets
- 5-pin design per socket
- With two channels per connection, the corresponding input signals can be easily connected via a T-adapter and conventional connecting cables with M8 connection

 Note

Max. 4 T-adapters (NEDU) can be mounted on a connection block.

Terminal CPX

Key features – Electrical components

| Combination of connection block and electrical connection technology | | | | | |
|---|-----------------------|--|--|---|---|
| Connection block | Connection technology | Plug connector/ connecting cable | Connection technology | Plug connector/ connecting cable | Connection technology |
| 1 CPX-M-AB-4-M12X2-5POL CPX-M-AB-8-M12X2-5POL CPX-AB-8-M12X2-5POL | Socket, M12, 5-pin | 2 SEA-GS-7 | Screw terminals | - | - |
| | | 2 SEA-4GS-7-2,5 | Screw terminals | - | - |
| | | 2 SEA-GS-9 | Screw terminals | - | - |
| | | 2 SEA-M12-5GS-PG7 | Screw terminals | - | - |
| | | 2 SEA-GS-11-DUO | Screw terminals, for two cables | - | - |
| | | 2 SEA-5GS-11-DUO | Screw terminals, for two cables | - | - |
| | | 3 KM12-M12-... (pre-assembled connecting cable) | Socket, M12, 4-pin | - | - |
| | | 3 NEBU-...-M12G4 | Socket, M5, 4-pin | - | - |
| | | 3 NEBU-...-M12G5 | Socket, M8, 4-pin | - | - |
| | | | Socket, M12, 5-pin | - | - |
| | | | Open cable end | - | - |
| | | 4 KM12-DUO-M8-... (pre-assembled connecting cable) | Plug M12, 4-pin to 2x socket M8, 3-pin | 6 SEA-GS-M8 | Solder lugs |
| | | 5 NEDU-M8D3-M12T4 (T-adapter) | | 6 SEA-3GS-M8-S | Screw terminals |
| | | 5 NEDU-M12D5-M12T4 (T-adapter) | Plug M12, 4-pin to 2x socket M12, 5-pin | 7 KM8-M8-GSGD-... (pre-assembled connecting cable) | Socket, M8, 3-pin |
| | | | | 7 NEBU-...-M8G3 (modular system for choice of connecting cables) | Socket, M5, 3-pin Socket, M8, 3-pin Socket, M8, 4-pin Socket, M12, 5-pin Open cable end |
| | | | | 6 SEA-GS-7 | Screw terminals |
| | | | | 6 SEA-4GS-7-2,5 | Screw terminals |
| | | | | 6 SEA-GS-9 | Screw terminals |
| | | | | 6 SEA-M12-5GS-PG7 | Screw terminals |
| | | | | 6 SEA-GS-11-DUO | Screw terminals, for two cables |
| | | | | 6 SEA-5GS-11-DUO | Screw terminals, for two cables |
| | | | | 7 KM12-M12-... (pre-assembled connecting cable) | Socket, M12, 4-pin |
| | | | | 7 NEBU-...-M12G4 (modular system for choice of connecting cables) | Socket, M5, 4-pin |
| | | | | 7 NEBU-...-M12G5 (modular system for choice of connecting cables) | Socket, M8, 4-pin Socket, M12, 5-pin Open cable end |

Terminal CPX

Key features – Electrical components

Electrical connection – Connection block

CPX-AB-4-M12-8POL with M12-8POL connection

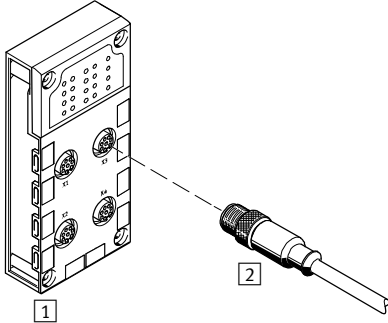

- Connection to cylinder/valve combinations with max. 3 inputs and 2 outputs
- 4 sockets
- 8-pin design per socket

Combination of connection block and electrical connection technology

| Connection block | Connection technology | Plug connector/connecting cable | Selectable connection technology |
|---------------------|-----------------------|---|----------------------------------|
| 1 CPX-AB-4-M12-8POL | Socket, M12, 8-pin | 2 KM12-8GD8GS-2-PU (pre-assembled connecting cable) | Socket, M12, 8-pin |

CPX-AB-8-KL-4POL, CPX-2ZE2DA with spring-loaded terminal connection

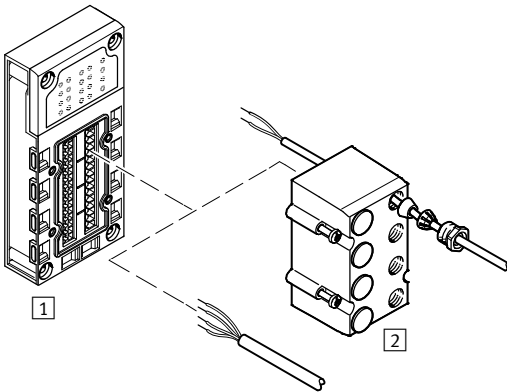

- Quick connection technology for use in control cabinets
- 32 spring-loaded terminals
- 4 spring-loaded terminals per channel
- Wire cross sections 0.05 ... 1.5 mm²
- Optional cover with fittings for IP65, IP67 connection
 - 8 through-holes M9
 - 1 through-hole M16
 - Blanking plug
 - For I/O distributors, consoles or individual sensors/actuators

Combination of connection block and electrical connection technology

| Connection block | Connection technology | Plug connector/connecting cable | Selectable connection technology |
|----------------------------------|---------------------------------|---------------------------------|----------------------------------|
| 1 CPX-AB-8-KL-4POL CPX-2ZE2DA | Spring-loaded terminals, 32-pin | 2 AK-8KL (cover) | – |

Terminal CPX

Key features – Electrical components

Electrical connection – Connection block

CPX-AB-1-SUB-BU-25POL with Sub-D connection

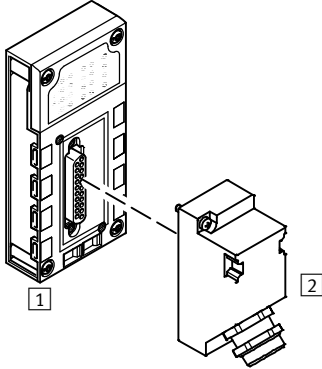

- Multi-pin plug connection for I/O distributor or console
- One socket
- 25-pin design

Combination of connection block and electrical connection technology

| Connection block | Connection technology | Plug connector/connecting cable | Selectable connection technology |
|-------------------------|-----------------------|---------------------------------|----------------------------------|
| 1 CPX-AB-1-SUB-BU-25POL | Socket, Sub-D, 25-pin | 2 SD-SUB-D-ST25 | Crimp contacts |

CPX-AB-4-HAR-4POL with quick connection

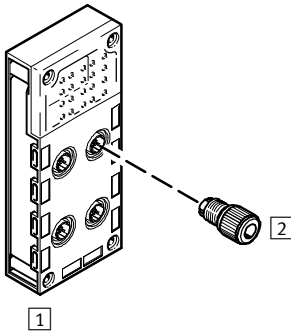

- Sturdy quick connection technology for individual connections
- 4 sockets
- 4-pin design per socket

Combination of connection block and electrical connection technology

| Connection block | Connection technology | Plug connector/connecting cable | Selectable connection technology |
|---------------------|---------------------------------|---------------------------------|------------------------------------|
| 1 CPX-AB-4-HAR-4POL | Socket, quick connection, 4-pin | 2 SEA-GS-HAR-4POL | Insulation displacement connectors |

Terminal CPX

Key features – Assembly

FESTO

Hood

Description

→ 253

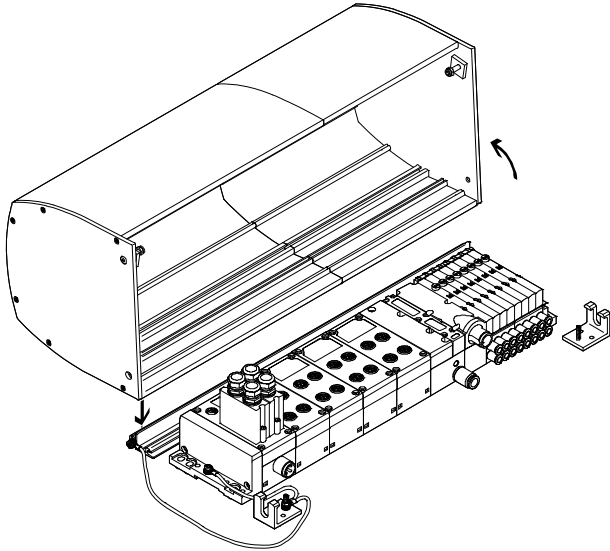

The CPX hood CAFC is a space- and cost-saving alternative to a control cabinet. It is designed as an extruded aluminium profile and is installed on a mounting plate. The valve terminal (CPX with MPA-S or MPA-L) is well protected and is quick to install without the need for complex control cabinet installation for connecting cables and tubing.

The rail and the two mounting brackets are mounted on a base plate. The hood is attached to the retaining rail and secured with two screws. There is also a stand-by position (locking of the hood in the open position). The hood is locked using two side screws (which meet the requirements for a special lock in compliance with ATEX). The CPX hood can be ordered online using the valve terminal configurator.

Advantages of the CPX hood

- Impact protection (min. 7 J) for the underlying modules in combination with a suitable mounting plate provided by the user
- Protection against electrostatic discharge through the use of electrically conductive materials and the option of connecting an earth wire
- Protection against disconnection of live plug connectors (by securing the hood with at least one special lock to EN 600079-0, 9.2 and 20)
- UV protection for the underlying CPX and MPA modules

Points to note when using the CPX hood

- Only in combination with valve terminal MPA-S and MPA-L
- No bus nodes with push-pull connection (CPX-M-FB34, CPX-M-FB35, CPX-M-FB41)
- CPX power supply via angled plugs, no T-plugs, no push-pull
- Electrical supply plate/additional power supply only possible with angled plug
- No MPA vertical stacking
- Use of larger fittings (for tubing O.D. larger than 12 mm) only possible with the angled design
- Ducted exhaust air only with elbow connector
- The permissible ambient temperature of the valve terminal is reduced by 5 °C

Note

The CPX hood has no influence on the ATEX classification of the valve terminal or of the CPX terminal.

The CPX hood has no influence on the IP protection class of the valve terminal or of the CPX terminal.

The CPX hood does not protect against the effects of the weather in installations that are not in closed spaces.

Terminal CPX

Key features – Assembly

FESTO

Hood Mounting

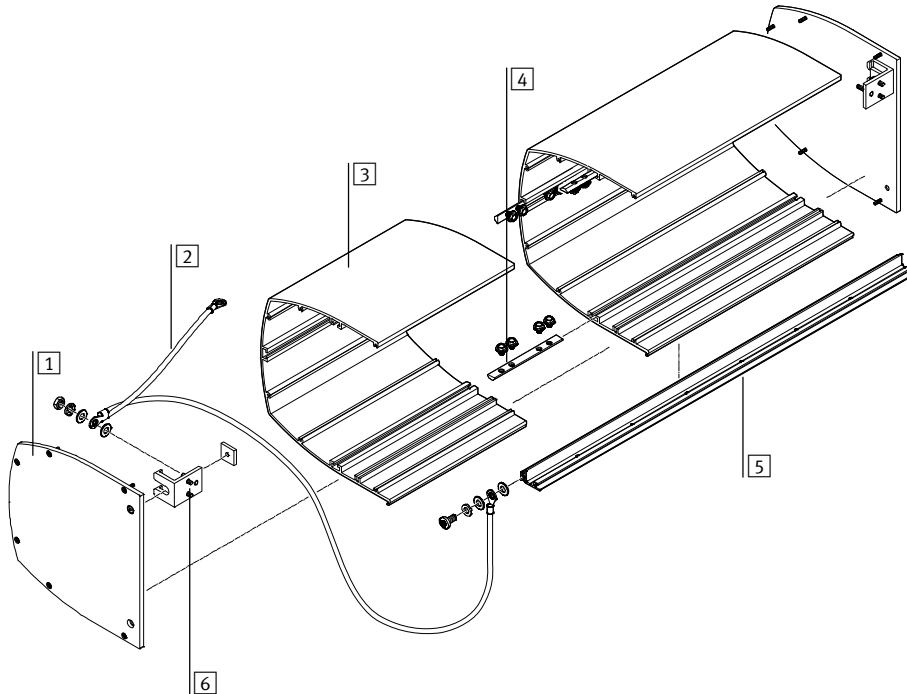

Procedure:

- Assemble the rail and mounting bracket included in the mounting kit
- Attach the earth cable
- Assemble the hood (if applicable, screw together several hood sections before attaching the side pieces)
- Attach and secure the hood

- 1 Side piece
- 2 Earth cable
- 3 Hood section
- 4 Slot nut with screws, for joining the hood sections
- 5 Rail
- 6 Mounting bracket

Technical data

Weight:

- Hood: approx. 500 g per 100 mm of length
- Mounting rail: approx. 550 g per 1000 mm of length
- Side pieces: approx. 500 g per side

- Ambient temperature $-5 \dots +50 \text{ }^{\circ}\text{C}$
- RoHS-compliant

Terminal CPX

Key features – Assembly

Extension

Functional principle

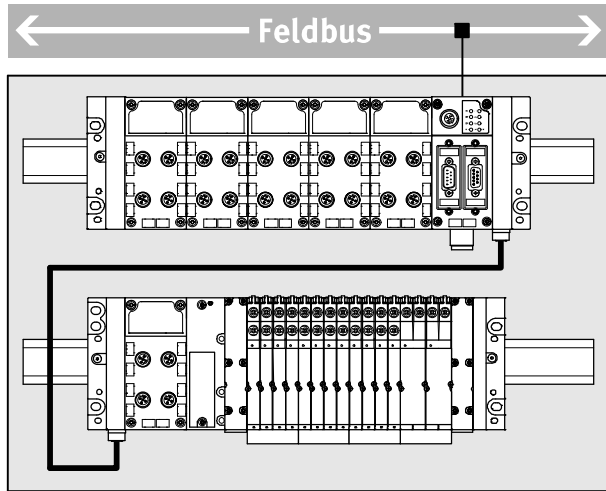

The extension enables the CPX terminal to be separated into or configured as two interconnected units (series). The two parts are controlled by a common bus node or control block. An extensive CPX terminal can fit into limited installation spaces more easily in the form of two compact units.

Applications:

- Installation in a control cabinet on two levels, one beneath the other
- Installation in two separate control cabinets
- Installation of part of the CPX terminal inside and part outside the control cabinet
- Spatial separation of electrics and pneumatics

Performance limits

- A maximum of 10 CPX modules are permitted on the first row
 - A maximum of 8 CPX modules and a pneumatic interface are permitted in the second row
- The number of CPX modules and solenoid coils is additionally limited by:
- the address space made available by the control block/bus node
 - their address requirement
 - their current consumption

Optimisation

- The maximum possible performance or maximum number of modules can only be achieved if the following conditions are observed:
- The control block/bus node is installed in the first row, on the far right, on an interlinking block with system supply
 - The connecting cable between the first and second row is max. 2 m long
 - An interlinking block with additional power supply for valves is situated in the second row

Configuration rules

- The extension limits the power supply for the sensors and electronics for the CPX terminal as a whole as follows:
- first row max. 6 A
 - second row max. 2 A
 - first and second row together, max. 6 A
- If the 3 m connecting cable is used, the following restrictions are in place:
- There can only be one CPX module in the second row
 - An additional power supply for valves is required in order to connect a valve terminal
- Positioning output modules in the second row requires a corresponding power supply in the second row:
- Install interlinking block with additional power supply for outputs in the second row to the left of the first output module

Terminal CPX

Key features – Assembly

| Extension – Permissible CPX modules | | | |
|---|--|--|-----------------|
| | Type | First row | Second row |
| Control blocks | CPX-FEC CPX-CEC | Permissible, at least one control block or bus node required | Not permissible |
| Bus node | CPX-FB CPX-M-FB | Permissible, at least one control block or bus node required | Not permissible |
| Technology modules | CPX-CP CPX-CTEL CPX-CTEL-2 CPX-CM-HPP CPX-CMAX CPX-CMPX CPX-CMIX | Permissible | Not permissible |
| Input/output modules | CPX | Permissible | Permissible |
| PROFIsafe shut-off module | CPX-FVDA-P2 | Not permissible | Not permissible |
| Interlinking block/end plate with system supply | CPX-EPL-EV-S CPX-GE-EV-S CPX-M-GE-EV-S | Permissible, at least one interlinking block/end plate with system supply required | Not permissible |
| Interlinking block with additional power supply | CPX-GE-EV-Z CPX-M-GE-EV-Z CPX-GE-EV-V | Permissible | Permissible |
| Interlinking block without supply | CPX-GE-EV CPX-M-GE-EV | Permissible | Permissible |
| Pneumatics interface | VMPA-FB | Not permissible | Permissible |
| | VMPAL-EPL-CPX | Not permissible | Permissible |
| | VMPAF-FB | Not permissible | Permissible |
| | VABA-S6-1 | Not permissible | Permissible |
| | CPX-GP-CPA | Not permissible | Not permissible |

Terminal CPX

Key features – Assembly



| Extension – Maximum number of CPX modules/solenoid coils | | |
|--|----------------|---|
| Special features of the design | First row | Second row |
| CPX terminal with valve terminal | | |
| Connecting cable 3 m | 10 CPX modules | Valve terminal MPA-S with: <ul style="list-style-type: none"> • Pneumatic interface for CPX metal interlinking module • Electrical air supply plate VMPA-FB-SP directly after the pneumatic interface • Electronics modules with galvanic isolation • 128 solenoid coils (64 valve positions) Valve terminal VTSA/VTSA-F with: <ul style="list-style-type: none"> • 1 CPX module with interlinking block with additional power supply for valves • 32 solenoid coils (32 valve positions) |
| CPX terminal without valve terminal | | |
| <ul style="list-style-type: none"> • Control block/bus node not in position on the far right of the first row | 10 CPX modules | <ul style="list-style-type: none"> • 2 ... 5 CPX modules, depending on the control block/bus node used |
| <ul style="list-style-type: none"> • Control block/bus node in position on the far right of the first row | 10 CPX modules | <ul style="list-style-type: none"> • 4 ... 8 CPX modules, depending on the control block/bus node used |
| CPX terminal with valve terminal MPA-S | | |
| – | 10 CPX modules | <ul style="list-style-type: none"> • 2 ... 5 CPX modules and manifold blocks MPA-S, depending on the control block/bus node used |
| <ul style="list-style-type: none"> • Electrical air supply plates VMPA-FB-SP • Electronics modules with galvanic isolation | 10 CPX modules | <ul style="list-style-type: none"> • 2 ... 5 CPX modules, depending on the control block/bus node used • Up to 128 solenoid coils (64 valve positions) |
| <ul style="list-style-type: none"> • Control block/bus node in position on the far right of the first row • CPX-FB11 or CPX-CEC not possible | 10 CPX modules | <ul style="list-style-type: none"> • 4 ... 5 CPX modules and manifold blocks MPA-S, depending on the control block/bus node used |
| <ul style="list-style-type: none"> • CPX-FB13 or CPX-FB36 • Control block/bus node in position on the far right of the first row • Interlinking block with system supply in position on the far right of the first row | 10 CPX modules | <ul style="list-style-type: none"> • 8 CPX modules and manifold blocks MPA-S |
| <ul style="list-style-type: none"> • CPX-FB13 or CPX-FB36 • Control block/bus node in position on the far right of the first row • Interlinking block with additional power supply for valves in position on the far right of the first row | 10 CPX modules | <ul style="list-style-type: none"> • 8 CPX modules and manifold blocks MPA-S |
| <ul style="list-style-type: none"> • CPX-FB13 or CPX-FB36 • Control block/bus node in position on the far right of the first row • Interlinking block with additional power supply for valves in second row | 10 CPX modules | <ul style="list-style-type: none"> • 8 CPX modules and manifold blocks MPA-S |

Terminal CPX

Key features – Assembly

| Extension – Maximum number of CPX modules/solenoid coils | | |
|---|----------------|--|
| Special features of the design | First row | Second row |
| CPX terminal with valve terminal MPA-F | | |
| – | 10 CPX modules | <ul style="list-style-type: none"> • 2 CPX modules • 8 manifold blocks MPA-F |
| <ul style="list-style-type: none"> • Interlinking block with additional power supply for valves in second row • Electronics modules with galvanic isolation | 10 CPX modules | <ul style="list-style-type: none"> • 2 CPX modules • 128 solenoid coils (64 valve positions) |
| <ul style="list-style-type: none"> • Electrical air supply plates VMPAF-FB-SP • Electronics modules with galvanic isolation | 10 CPX modules | <ul style="list-style-type: none"> • 2 CPX modules • 128 solenoid coils (64 valve positions) |
| CPX terminal with valve terminal MPA-L | | |
| – | 10 CPX modules | <ul style="list-style-type: none"> • 2 CPX modules (at least one CPX module required) • 16 solenoid coils (valve widths 10 mm and 14 mm) or 8 solenoid coils (valve width 20 mm) |
| <ul style="list-style-type: none"> • Interlinking block with additional power supply for valves in second row | 10 CPX modules | <ul style="list-style-type: none"> • 2 CPX modules (at least one CPX module required) • 32 solenoid coils (32 valve positions) |
| CPX terminal with valve terminal VTSA/VTSA-F | | |
| – | 10 CPX modules | <ul style="list-style-type: none"> • 2 CPX modules • 12 solenoid coils (valve widths 18 mm and 26 mm and 42 mm) or 6 solenoid coils (valve widths 52 mm and 65 mm) |
| <ul style="list-style-type: none"> • Interlinking block with additional power supply for valves in second row | 10 CPX modules | <ul style="list-style-type: none"> • 2 CPX modules • 32 solenoid coils (32 valve positions) |

Terminal CPX

Key features – Assembly

Mounting options

Valve terminals with CPX terminal support different mounting options for direct machine mounting a high

degree of high protection and control cabinet installation.

H-rail mounting

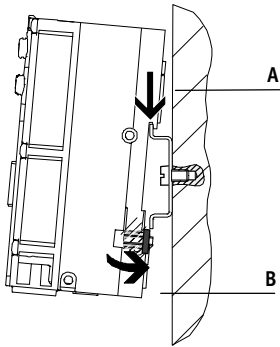

The H-rail mounting is part of the reverse profile of the CPX interlinking blocks. The CPX terminal can be attached to the H-rail using the H-rail mounting kit.

The CPX terminal is mounted on the H-rail for this purpose (see arrow A).

It is then swivelled onto the H-rail and secured in place with the clamping component (see arrow B).

The optional earthing plate enables a connection to be established to the machine potential/earth in one easy step.

For H-rail mounting you will need the following mounting kit:

- CPX-CPA-BG-NRH

This facilitates mounting of the CPX terminal on H-rails to EN 60715.

An additional mounting kit is required for combination with valve terminals.

Wall mounting, plastic design

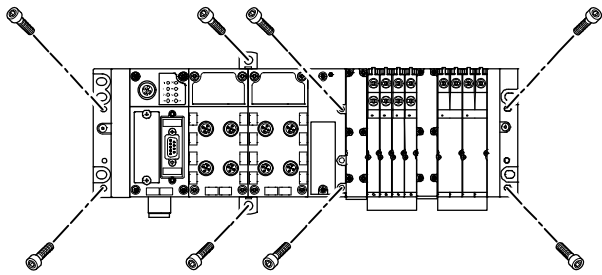

The end plates of the CPX terminal, the valve terminal and the pneumatic interface include mounting holes for wall mounting. Additional mountings for the CPX terminal are available for longer valve terminals. These mountings differ depending on the design of the CPX terminal (plastic or metal).

Wall mounting, metal design

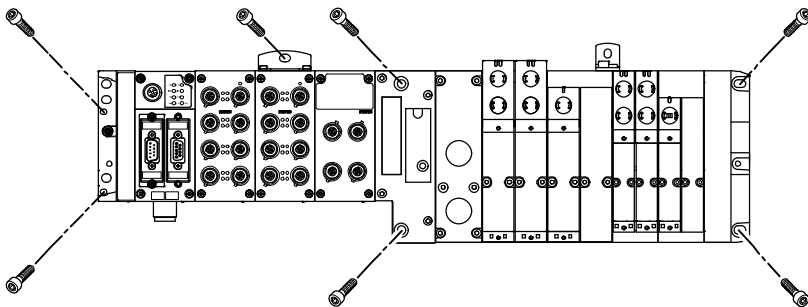

Terminal CPX

Key features – Assembly

Plastic design CPX terminal

Additional mountings

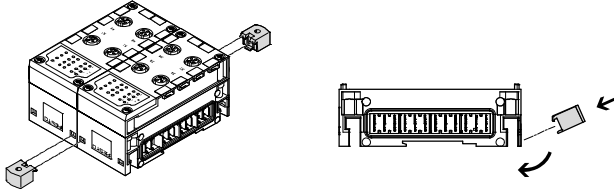

For longer valve terminals, there are additional mounting components for the CPX terminal that can be fitted between two modules.

 Note

In the case of CPX terminals with 4 and more interlinking blocks, additional mountings of the type CPX-BG-RW must be used every 100 or 150 mm. These are supplied pre-assembled.

Interlinking with tie rods

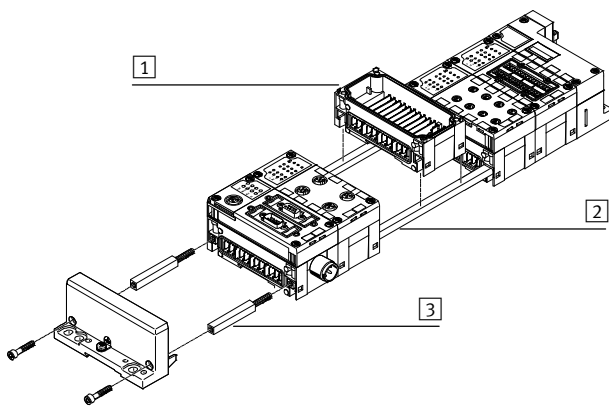

The CPX modules are mechanically connected using special tie rods **2**. Two screws in the end plates are all that are needed to assemble the entire unit.

The tie rod ensures that the unit resists high mechanical loads and is therefore the mechanical backbone of the CPX terminal.

The open design enables interlinking blocks **1** to be replaced in the assembled state.

The tie rod expansion kit **3** enables an extra module to be added to the CPX terminal.

CPX terminal in metal design

Additional mountings

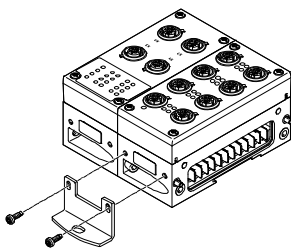

For longer valve terminals, there are additional mounting brackets for the CPX terminal that can be screwed onto the interlinking blocks.

The mounting bracket CPX-M-BG-VT-2X enables a CPX terminal with valve terminal VTSA/VTSA-F to be mounted on a support system.

 Note

In the case of CPX terminals with 4 and more interlinking blocks, additional mounting brackets of the type CPX-M-BG-RW must be used every 100 or 150 mm. These are supplied pre-assembled.

Linking with screws

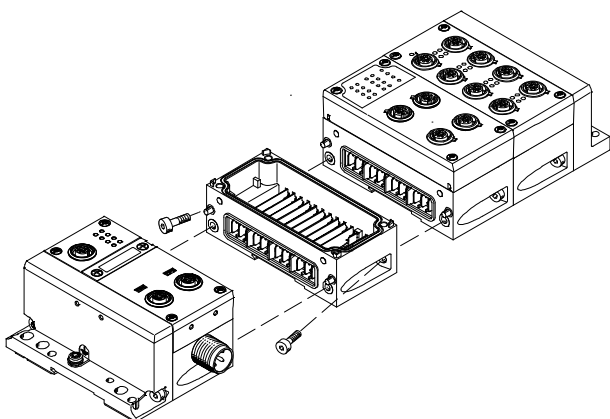

The CPX modules are mechanically connected using a special angled fitting.

The CPX terminal can thus be expanded at any time.

Terminal CPX

Key features – Power supply

Power supply concept

General

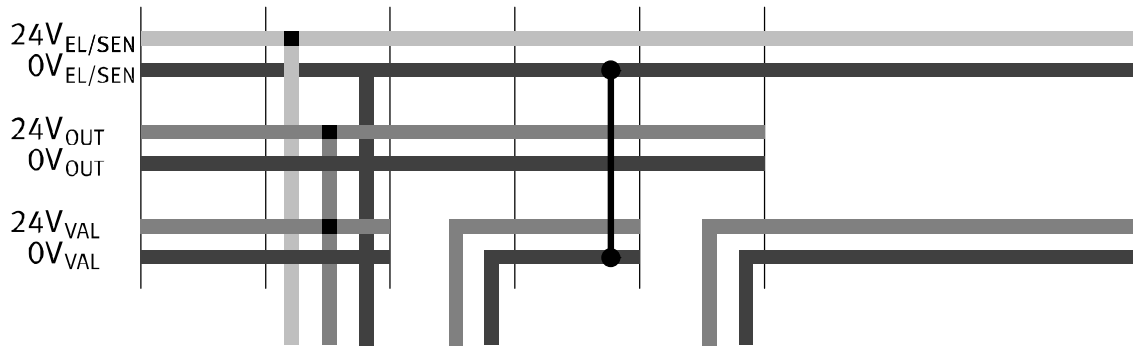
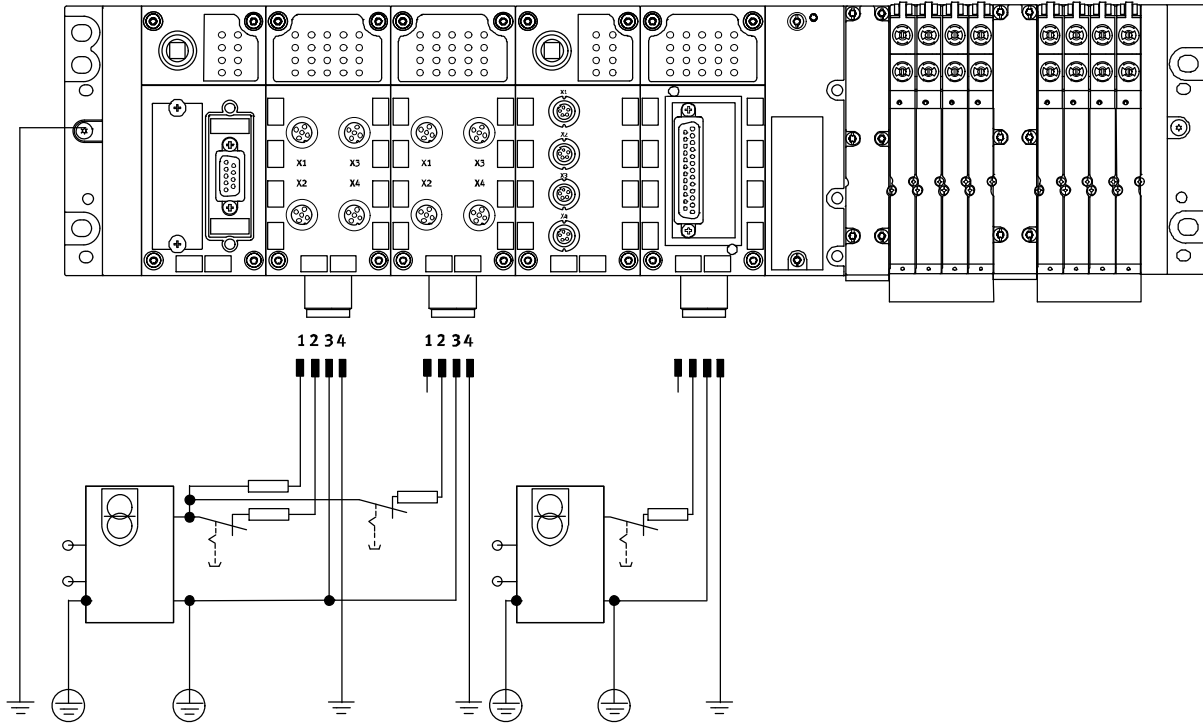

The use of decentralised devices on the fieldbus – particularly with a high degree of protection for direct machine mounting – demands a flexible power

supply concept. A valve terminal with CPX can, in principle, supply all voltages via a single connection. A distinction is made between the

supply for

- Electronics plus sensors
- Valves plus actuators

in this case.

Selectable connection technology:

- M18
- 7/8"
- AIDA push-pull

Interlinking blocks

Interlinking blocks represent the backbone of the CPX terminal with all supply lines. They provide the power supply for the modules used on them

as well as their bus connections. Many applications require the CPX terminal to be segmented into voltage zones. This applies in particular to the

separate disconnection of solenoid coils and outputs. The interlinking blocks provide either a space-saving central power supply

for the entire CPX terminal or galvanically isolated, all-pin disconnectable potential groups/voltage segments.

Terminal CPX

Key features – Power supply

Interlinking blocks

With system supply

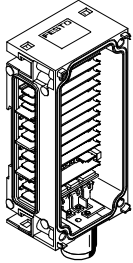

Type for plastic design

- CPX-GE-EV-S
- CPX-GE-EV-S-7/8-4POL
- CPX-GE-EV-S-7/8-5POL

Connection technology

- M18 4-pin
- 7/8" 4-pin
- 7/8" 5-pin

Power supply

- For CPX terminal modules and connected sensors
- For valves that are connected to the CPX terminal via a pneumatic interface
- For actuators that are connected to the output modules of the CPX terminal

Type for metal design

- CPX-M-GE-EV-S-7/8-CIP-4P
- CPX-M-GE-EV-S-7/8-5POL
- CPX-M-GE-EV-S-PP-5POL

Connection technology

- 7/8" 4-pin
- 7/8" 5-pin
- AIDA push-pull, 5-pin

Without power supply

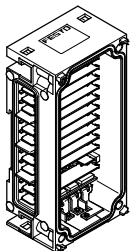

Type for plastic design

- CPX-GE-EV

–

–

Type for metal design

- CPX-M-GE-EV
- CPX-M-GE-EV-FVO

–

With additional power supply for outputs

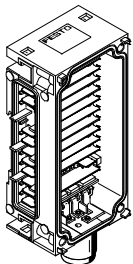

Type for plastic design

- CPX-GE-EV-Z
- CPX-GE-EV-Z-7/8-4POL
- CPX-GE-EV-Z-7/8-5POL

Connection technology

- M18 4-pin
- 7/8" 4-pin
- 7/8" 5-pin

Power supply

- For actuators that are connected to the output modules of the CPX terminal

Type for metal design

- CPX-M-GE-EV-Z-7/8-5POL
- CPX-M-GE-EV-Z-PP-5POL

Connection technology

- 7/8" 5-pin
- AIDA push-pull, 5-pin

With additional power supply for valves

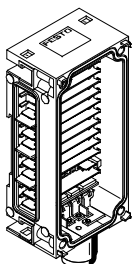

Type for plastic design

- CPX-GE-EV-V
- CPX-GE-EV-V-7/8-4POL

Connection technology

- M18 4-pin
- 7/8" 4-pin

Power supply

- For valves that are connected to the CPX terminal via a pneumatic interface

-  - Note

For 7/8":
– Commercially available accessories are often limited to max. 8 A

-  - Note

Valve terminal MPA-S has either a 7/8" 5-pin, 7/8" 4-pin, 3-pin M18 or 5-pin AIDA push-pull power supply for one or more valve voltage zones. Galvanically isolated, all pins disconnectable with voltage monitoring in the following MPA module.

-  - Note

Suitable versions of the interlinking blocks with M18 and 7/8", 5-pin connection are available (CPX-GE-EV-...-VL and CPX-M-GE-EV-...-VL) for use in ATEX environments as per certification (→ 46). The maximum current supply for these interlinking blocks is 8 A.

Terminal CPX

Key features – Diagnostics

Diagnostics

System performance

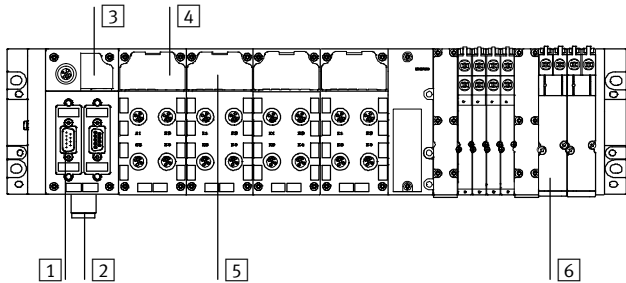

- 1 Diagnostics via bus interface
- 2 Undervoltage monitoring
- 3 Diagnostic overview LED
 - Fieldbus status
 - CPX status
- 4 Status and diagnostic LED for module and I/O channels
- 5 Module and channel-specific

- diagnostics
- 6 Valve-specific diagnostics for module and solenoid coils
- 7 MPA pressure sensor – integrated solution on the fieldbus
 - Pre-assembled for ducts 1, 3, 5 and external pressures

Detailed diagnostic functions are needed in order to quickly locate the causes of errors in the electrical installation and therefore reduce downtimes in production plants. A basic distinction is made between on-the-spot diagnostics using LEDs or an operator unit and diagnostics using a bus interface.

The CPX terminal supports on-the-spot diagnostics via a row of LEDs. This is separate from the connection area and therefore provides good visual access to status and diagnostic information.

Module and channel-specific diagnosis is supported, for example

- Undervoltage detection for outputs and valves
- Short circuit detection for sensors, outputs and valves
- Open-load detection for a missing solenoid coil
- Storage of the last 40 causes of errors with error start and error end

The diagnostic messages can be read out via the bus interface in the higher-order controller and visualised for the central recording and evaluation of error causes. This is done using the individual fieldbus-specific channels. The CPX-FEC and CPX-CEC also offer the option of access via the integrated Ethernet interface (remote maintenance via PC/web applications).

Overview of LEDs on the bus node

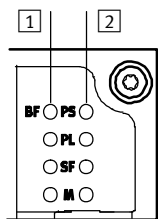

- 1 Fieldbus-specific LEDs

On each bus node, a maximum of 4 fieldbus-specific LEDs display the fieldbus communication status of the CPX terminal with the higher-order controller.

- 2 CPX-specific LEDs

A further 4 CPX-specific LEDs provide non-fieldbus-specific information about the status of the CPX terminal, for example

 - Power system
 - Power load
 - System fault
 - Modification parameters

Input/output module status and diagnostic LEDs

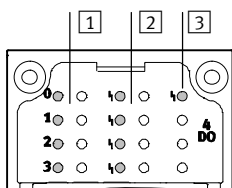

- 1 Status LEDs for the inputs and outputs

Each input and output channel is assigned a status LED.

- 2 Channel-oriented diagnostic LEDs

Depending on the module design, another diagnostic LED is available for each I/O channel

- 3 Group diagnostic LEDs

An LED displays the group diagnostics for each module

Terminal CPX

Key features – Parameterisation

Diagnostics

Display on the operator unit

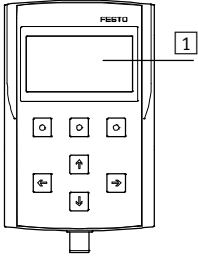

- 1 LCD graphical display for on-site plain-text diagnostics
 - Fault location and type
 - Without programming

Display on a PC

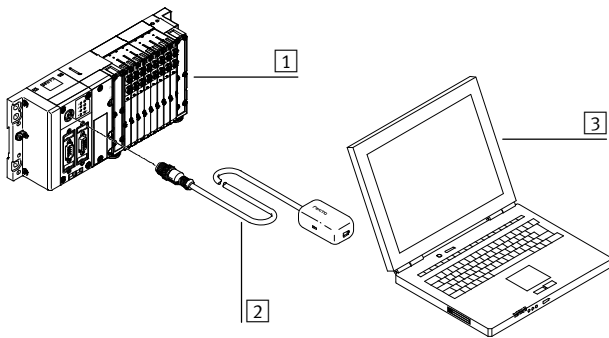

- 1 CPX terminal with valve terminal
 - Fault location and type
 - Without programming
- 2 Adapter diagnostic interface to USB
 - Storing the configuration
 - Preparing screenshots
- 3 Laptop/portable device with USB interface and installed FMT software

Parameterisation

Changes to the application are often required during commissioning. The parameterisable characteristics of the CPX modules mean that functions can be very easily changed by means of configuration software. This reduces

the number of modules needed and, consequently, the amount of storage space required.

It is therefore possible, for example, to reduce the switch-on debounce time for an input module – normally 3 ms –

to 0.1 ms on a "fast" input module for faster processes, or to set the response of a valve following a fieldbus interrupt.

Depending on the modules used, parameterisation can be performed

via the following interfaces:

- Ethernet
- Fieldbus
- Control block direct interface (programming interface)
- Operator unit CPX-MMI

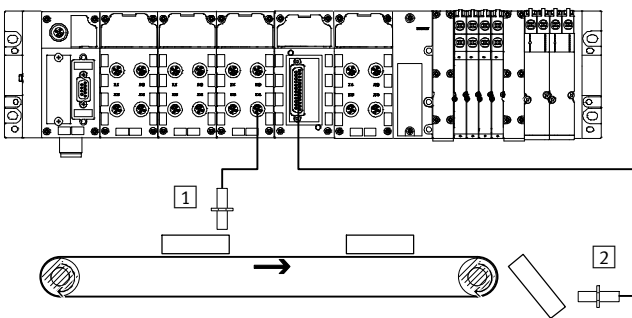

- 1 Input debounce time 3 ms
- 2 Input debounce time 0.1 ms

Terminal CPX

Key features – Addressing

Addressing

The various CPX modules occupy a different number of I/O addresses within the CPX system. The maximum address space for bus nodes depends on the performance of the fieldbus systems.

Maximum system configuration:



- 1 bus node or control block
- 9 I/O modules
- 1 pneumatic interface (e.g. pneumatic interface MPA-S with up to 16 MPA manifold blocks)

The maximum system configuration can be limited in individual cases by exceeding the address space.



Please refer to the detailed description of the configuration/addressing rules in the technical data for CPX bus nodes.

Overview – Address space for CPX bus node and control block

| | Protocol | Max. total | | Max. digital | | Max. analogue | |
|-------------|--|------------|----------|-----------------|-----------------|---------------|---------------|
| | | Inputs | Outputs | Inputs | Outputs | Inputs | Outputs |
| CPX-FEC | <ul style="list-style-type: none"> • TCP/IP • Easy IP • Modbus TCP • HTTP | 512 bits | 512 bits | 512 DI | 512 DO | 32 AI | 18 AO |
| CPX-CEC | <ul style="list-style-type: none"> • CoDeSys level 2 • TCP/IP • Easy IP • Modbus TCP | 512 bits | 512 bits | 512 DI | 512 DO | 32 AI | 18 AO |
| CPX-FB6 | INTERBUS | 96 bits | 96 bits | 96 DI | 96 DO | 6 AI | 6 AO |
| CPX-FB11 | DeviceNet | 512 bits | 512 bits | 512 DI | 512 DO | 32 AI | 18 AO |
| CPX-FB13 | PROFIBUS | 512 bits | 512 bits | 512 DI | 512 DO | 32 AI | 18 AO |
| CPX-FB14 | CANOpen | 256 bits | 256 bits | 64 DI (+ 64 DI) | 64 DO (+ 64 DO) | 8 AI (+ 8 AI) | 8 AO (+ 8 AO) |
| CPX-M-FB20 | INTERBUS (LWL) | 96 bits | 96 bits | 96 DI | 96 DO | 6 AI | 6 AO |
| CPX-M-FB21 | INTERBUS (LWL) | 96 bits | 96 bits | 96 DI | 96 DO | 6 AI | 6 AO |
| CPX-FB23-24 | CC-Link | 512 bits | 512 bits | 512 DI | 512 DO | 32 AI | 18 AO |
| CPX-FB32 | EtherNet/IP | 512 bits | 512 bits | 512 DI | 512 DO | 32 AI | 18 AO |
| CPX-FB33 | PROFINET RT | 512 bits | 512 bits | 512 DI | 512 DO | 32 AI | 18 AO |
| CPX-M-FB34 | PROFINET RT | 512 bits | 512 bits | 512 DI | 512 DO | 32 AI | 18 AO |
| CPX-M-FB35 | PROFINET RT | 512 bits | 512 bits | 512 DI | 512 DO | 32 AI | 18 AO |
| CPX-FB36 | EtherNet/IP | 512 bits | 512 bits | 512 DI | 512 DO | 32 AI | 18 AO |
| CPX-FB37 |  EtherCAT | 512 bit | 512 bit | 512 DE | 512 DA | 32 AE | 18 AA |
| CPX-FB38 | EtherCAT | 512 bits | 512 bits | 512 DI | 512 DO | 32 AI | 18 AO |
| CPX-FB39 |  Sercos III | 512 bit | 512 bit | 512 DE | 512 DA | 32 AE | 18 AA |
| CPX-FB40 |  POWERLINK | 512 bit | 512 bit | 512 DE | 512 DA | 32 AE | 18 AA |
| CPX-M-FB41 |  PROFINET RT | 512 bit | 512 bit | 512 DE | 512 DA | 32 AE | 18 AA |



The bandwidth of the bus nodes can be restricted by the choice of module and the maximum number of modules.

Example CPX-FB6 (INTERBUS)

| | Digital inputs | Digital outputs | Notes |
|-------------------------|----------------|-----------------|--|
| 3x CPX-8DE | 24 | – | <ul style="list-style-type: none"> • The address space is occupied by 7 CPX I/O modules plus pneumatic interface • No additional modules can be configured |
| 1x CPX-8DE-8DA | 8 | 8 | |
| 2x CPX-2AE | 64 | – | |
| 1x CPX-2AA | – | 32 | |
| 3x VMPA1 | – | 24 | |
| Allocated address space | 96 | 96 | |

DI = Digital inputs (1 bit)

DO = Digital outputs (1 bit)

AO = Analogue outputs (16 bits)

AI = Analogue inputs (16 bits)

Terminal CPX

Key features – Addressing

| Overview – Allocated addresses for CPX modules | | |
|--|---|---|
| | Inputs [bit] | Outputs [bit] |
| CPX-CP-4-FB | 16, 32, 48, 64, 80, 96, 128 ¹⁾ | 16, 32, 48, 64, 80, 96, 128 ¹⁾ |
| CPX-CTEL-4-M12-5POL | 0, 64, 128, 192, 256 ¹⁾ | 0, 64, 128, 192, 256 ¹⁾ |
| CPX-CTEL-2-M12-5POL-LK | 64, 128, 192, 256 ¹⁾ | 64, 128, 192, 256 ¹⁾ |
| CPX-CM-HPP | 256 | 256 |
| CPX-CMAX-C1-1 | 64 | 64 |
| CPX-CMPX-C-1-H1 | 48 | 48 |
| CPX-CMIX-M1-1 | 48 | 48 |
| CPX-4DE | 4 | – |
| CPX-8DE | 8 | – |
| CPX-8DE-D | 8 | – |
| CPX-8NDE | 8 | – |
| CPX-F8DE-P  | 48 | 56 |
| CPX-16DE | 16 | – |
| CPX-M-16DE-D | 16 | – |
| CPX-L-16DE-16-KL-3POL | 16 | – |
| CPX-4DA | – | 4 |
| CPX-8DA | – | 8 |
| CPX-8DA-H | – | 8 |
| CPX-8DE-8DA | 8 | 8 |
| CPX-L-8DE-8DA-16-KL-3POL | 8 | 8 |
| CPX-2ZE2DA | 96 | 96 |
| CPX-2AE-U-I | 2 x 16 | – |
| CPX-4AE-U-I | 4 x 16 | – |
| CPX-4AE-I | 4 x 16 | – |
| CPX-4AE-P-B2 | 4 x 16 | – |
| CPX-4AE-P-D10 | 4 x 16 | – |
| CPX-4AE-T | 4 x 16 | – |
| CPX-4AE-TC | 4 x 16 | – |
| CPX-2AA-U-I | – | 2 x 16 |
| CPX-FVDA-P2 | 48 | 48 |
| VMPA1-FB-EMS-8 | – | 8 |
| VMPA1-FB-EMG-8 | – | 8 |
| VMPA2-FB-EMS-4 | – | 4 |
| VMPA2-FB-EMG-4 | – | 4 |
| VMPA1-FB-EMS-D2-8 | – | 8 |
| VMPA1-FB-EMG-D2-8 | – | 8 |
| VMPA2-FB-EMS-D2-4 | – | 4 |
| VMPA2-FB-EMG-D2-4 | – | 4 |
| VMPA-FB-PS-1 | 16 | – |
| VMPA-FB-PS-3/5 | 16 | – |
| VMPA-FB-PS-P1 | 16 | – |
| VMPA-FB-EMG-P1 | 16 | 16 |
| VMPAL-EPL-CPX | – | 4, 8, 16, 24, 32 ¹⁾ |
| VMPAF-FB-EPL-PS | 16 | – |
| VMPAF-FB-EPLM-PS | 16 | – |
| VABA-S6-1-X1 | – | 8, 16, 24, 32 ¹⁾ |
| VABA-S6-1-X2 | – | 8, 16, 24, 32 ¹⁾ |
| VABA-S6-1-X2-D | 8, 16, 24, 32 ¹⁾ | 8, 16, 24, 32 ¹⁾ |
| CPX-GP-CPA-10 | – | 8, 16, 24 ¹⁾ |
| CPX-GP-CPA-14 | – | 8, 16, 24 ¹⁾ |

1) Dependent on the DIL switch setting on the module

Terminal CPX

Technical data

-  - Module width
50 mm



-  - Note
The data given here apply to the CPX system. If components that conform to lower values are used in the system, the specification for the entire system is reduced to the values of those components used.

Example
Protection class IP65/IP67 applies only to the fully assembled system with fitted plugs or covers (which must also conform to IP65/IP67). If components with a lower protection class are used, the protection level of the entire system is reduced to the protection class of the component with the lowest protection level, for example CageClamp connection block with IP20 protection or MPA pneumatics with IP65 protection.

| General technical data | | | |
|-----------------------------------|--|--------|--|
| Module No. | | 197330 | |
| Max. no. of modules ¹⁾ | Control block | 1 | |
| | Bus node | 1 | |
| | I/O modules/CP interface/CTEL interface/ electrical interface CPX-CTEL-2/multi-axis interface | 9 | |
| | Pneumatic interface | 1 | |
| Max. address capacity | Inputs | [byte] | 64 |
| | Outputs | [byte] | 64 |
| Internal cycle time | | [ms] | < 1 |
| Configuration support | Fieldbus-specific | | |
| LED displays | Bus node/control block | | Up to 4 LEDs, bus-specific 4 LEDs, CPX-specific • PS = Power system • PL = Power load • SF = System fault • M = Modify parameter/forcing active |
| | I/O modules | | Min. one group diagnostic LED Channel-oriented status and diagnostic LED, depending on module |
| | Pneumatic interface | | One group diagnostic LED Valve status LED on valve |
| Diagnostics | <ul style="list-style-type: none"> • Channel and module-oriented diagnostics for inputs/outputs and valves • Detection of module undervoltage for the different voltage potential values • Storage of the last 40 errors with timestamp (asynchronous access) | | |

1) A maximum of 11 modules in total can be combined (e.g. 1 control block + 9 I/O modules + 1 pneumatic interface, or 1 control block + 1 bus node + 8 I/O modules + 1 pneumatic interface)

Terminal CPX

Technical data

FESTO

| General technical data | | | |
|--|--|---|---|
| Module No. | | 197330 | |
| Parameterisation | | Module-specific and entire system, for example: <ul style="list-style-type: none"> • Diagnostic behaviour • Condition monitoring • Profile of inputs • Fail-safe response of outputs and valves | |
| Commissioning support | | Forcing of inputs and outputs | |
| Protection class to EN 60529 | | IP65, IP67 | |
| Nominal operating voltage | [V DC] | 24 | |
| Operating voltage range | [V DC] | 18 ... 30 | |
| Current supply | Interlinking block with system supply for electronics plus sensors | [A] | 16 (8/10 with 7/8" supply, 5-pin/4-pin) |
| | | [A] | 16 (8/10 with 7/8" supply, 5-pin/4-pin) |
| | Additional power supply for actuators | [A] | 16 (8/10 with 7/8" supply, 5-pin/4-pin) |
| | | [A] | 16 (10 with 7/8" supply, 4-pin) |
| Additional power supply for valves | [A] | 16 (10 with 7/8" supply, 4-pin) | |
| Current consumption | | Depending on system configuration | |
| Power failure bridging (bus electronics only) | [ms] | 10 | |
| Power supply connection | | M18, 4-pin | |
| | | 7/8", 5-pin | |
| | | 7/8", 4-pin | |
| | | AIDA push-pull, 5-pin | |
| Fuse concept | | Per module with electronic fuses | |
| Tests | Vibration test to DIN IEC 68 | <ul style="list-style-type: none"> • With wall mounting: Severity level 2 • With H-rail mounting: Severity level 1 | |
| | Shock test to DIN IEC 68 | <ul style="list-style-type: none"> • With wall mounting: Severity level 2 • With H-rail mounting: Severity level 1 | |
| PWIS classification | | PWIS-free (free of paint-wetting impairment substances) | |
| Interference immunity | | EN 61000-6-2 (industry) | |
| Interference emission | | EN 61000-6-4 (industry) | |
| Isolation test for galvanically isolated circuits to IEC 1131 Part 2 | [V DC] | 500 | |
| Galvanic isolation of electrical voltages | [V DC] | 80 | |
| Protection against direct and indirect contact | | PELV (Protective Extra-Low Voltage) | |
| Materials | | End plates: Die-cast aluminium | |
| Grid dimension | [mm] | 50 | |

| Operating and environmental conditions | | |
|--|------|-------------|
| Module No. | | 197330 |
| Ambient temperature | [°C] | -5 ... +50 |
| Storage temperature | [°C] | -20 ... +70 |

Terminal CPX

Technical data

FESTO

| Certifications – Maximum permissible values | |
|---|--|
| Module No. | 197330 |
| ATEX category gas | II 3G |
| Ex-ignition protection type gas | Ex nA IIC T4 X Gc |
| ATEX ambient temperature [°C] | -5 ≤ Ta ≤ +50 |
| CE mark (see declaration of conformity) | To EU Explosion Protection Directive (ATEX) To EU EMC Directive ¹⁾ |
| Protection class to EN 60529 | IP65, IP67 |
| Certification | c UL us - Recognized (OL) C-Tick |
| Explosion protection certification outside the EU | EPL Gc (Ru) |

1) For information about the applicability of the component see the manufacturer's EC declaration of conformity at: www.festo.com/sp → User documentation.
If the component is subject to restrictions on usage in residential, office or commercial environments or small businesses, further measures to reduce the emitted interference may be necessary.

 - Note

The values indicated represent the maximum performance limits that can be achieved with the fully assembled product. Depending on the individual components used, the value actually achieved for the overall product may be lower.

You can select e.g. the individual components required to achieve the ATEX category by choosing the corresponding features in the online product configurator: → Internet:cpX

| Weight [g] | | | | | |
|-------------------------|----------|------------|-------------------------------|--------------------------------|----------------------|
| Control block | FEC | 140.0 | Connection block | Plastic | 70.0 |
| | CEC | 155.0 | | Metal | 175.0 |
| | CEC...V3 | 135.0 | | Interlinking block, plastic | Without power supply |
| Bus node | FB6 | 125.0 | | With system supply | 125.0 |
| | FB11 | 120.0 | Interlinking block, metal | Without power supply | 162.0 |
| | FB13 | 115.0 | | With system supply, 7/8" 4-pin | 228.0 |
| | FB14 | 115.0 | | With system supply, 7/8" 5-pin | 187.0 |
| | FB20 | 1070.0 | | With system supply, Push-pull | 245.0 |
| | FB21 | 1255.0 | | Tie rod | 1-fold |
| | FB23-24 | 115.0 | 2-fold | | 32.5 ±2.5 |
| | FB32 | 125.0 | 3-fold | | 46.0 ±2.5 |
| | FB33 | 280.0 | 4-fold | | 59.5 ±2.5 |
| | FB34 | 280.0 | 5-fold | | 73.0 ±2.5 |
| | FB35 | 280.0 | 6-fold | | 86.5 ±2.5 |
| | FB36 | 125.0 | 7-fold | | 100.0 ±2.5 |
| | FB37 | 125.0 | 8-fold | | 113.5 ±2.5 |
| | FB38 | 125.0 | 9-fold | | 127.0 ±2.5 |
| | FB39 | 125.0 | 10-fold | | 140.5 ±2.5 |
| | FB40 | 125.0 | End plate for plastic version | Left-hand | 77.0 |
| | FB41 | 280.0 | | Left-hand, with system supply | 145.0 |
| | | Right-hand | | 70.0 | |
| I/O module | CPX | 38.0 | End plate for metal version | Left-hand | 113.0 |
| | CPX-L | 170.0 | | Right-hand | 113.0 |
| Counter module | 2ZE2DA | 130.0 | End plate with extension | Left-hand | 190.0 |
| CP interface | CP | 140.0 | | Right-hand | 175.0 |
| CTEL interface | CTEL | 110.0 | Pneumatic interface | MPA-S | 238.4 |
| Electrical interface | CTEL-2 | 110.0 | | MPA-F | 690.0 |
| Axis interface | CM-HPP | 140.0 | | VTSA/VTSA-F | 485.0 |
| Axis controller | CMAx | 140.0 | | CPA | 150.0 |
| End-position controller | CMPX | 140.0 | | | |
| Measuring module | CMIX | 140.0 | | | |

Terminal CPX

Accessories



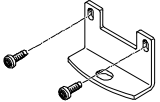
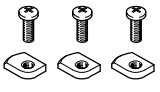
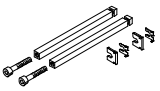
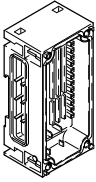
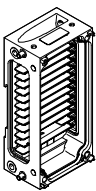

FESTO

| Ordering data – Accessories | | | |
|---|---|---|---|
| Designation | | Part No. | Type |
| Mounting | | | |
|  | Attachment for wall mounting (for long valve terminals, 10 pieces), design for plastic manifold sub-bases | 529040 | CPX-BG-RW-10x |
|  | Attachment for wall mounting, design for metal manifold sub-bases | 2 mounting brackets and 4 screws | 550217 CPX-M-BG-RW-2X |
| | | 1 mounting bracket and 2 screws | 2721419 CPX-M-BG-VT-2X |
|  | Mounting for H-rail | CPX without pneumatic components | 526032 CPX-CPA-BG-NRH |
| | | CPX-VTSA | |
| | | CPX-VTSA-F | |
| | | CPX-MPA | |
| | CPX-CPA | | |
| Tie rod | | | |
|  | Tie rod CPX | Extension 1-fold | 525418 CPX-ZA-1-E |
| | | 1-fold | 195718 CPX-ZA-1 |
| | | 2-fold | 195720 CPX-ZA-2 |
| | | 3-fold | 195722 CPX-ZA-3 |
| | | 4-fold | 195724 CPX-ZA-4 |
| | | 5-fold | 195726 CPX-ZA-5 |
| | | 6-fold | 195728 CPX-ZA-6 |
| | | 7-fold | 195730 CPX-ZA-7 |
| | | 8-fold | 195732 CPX-ZA-8 |
| | | 9-fold | 195734 CPX-ZA-9 |
| 10-fold | 195736 CPX-ZA-10 | | |
| Plastic interlinking block | | | |
|  | Without power supply | – | 195742 CPX-GE-EV |
| | With system supply | M18 | 195746 CPX-GE-EV-S |
| | | M18, for ATEX environment | 8022170 CPX-GE-EV-S-VL |
| | | 7/8□– 5-pin | 541244 CPX-GE-EV-S-7/8-5POL |
| | | 7/8□– 5-pin, for ATEX environment | 8022172 CPX-GE-EV-S-7/8-5POL-VL |
| | | 7/8□– 4-pin | 541248 CPX-GE-EV-S-7/8-4POL |
| | With additional power supply for outputs | M18 | 195744 CPX-GE-EV-Z |
| | | M18, for ATEX environment | 8022166 CPX-GE-EV-Z-VL |
| | | 7/8□– 5-pin | 541246 CPX-GE-EV-Z-7/8-5POL |
| | | 7/8□– 5-pin, for ATEX environment | 8022173 CPX-GE-EV-Z-7/8-5POL-VL |
| | | 7/8□– 4-pin | 541250 CPX-GE-EV-Z-7/8-4POL |
| | With additional power supply for valves | M18 | 533577 CPX-GE-EV-V |
| M18, for ATEX environment | | 8022171 CPX-GE-EV-V-VL | |
| 7/8□– 4-pin | | 541252 CPX-GE-EV-V-7/8-4POL | |
| Metal interlinking block | | | |
|  | Without power supply | – | 550206 CPX-M-GE-EV |
| | With system supply | 7/8□– 5-pin | 550208 CPX-M-GE-EV-S-7/8-5POL |
| | | 7/8□– 5-pin, for ATEX environment | 8022165 CPX-M-GE-EV-S-7/8-5POL-VL |
| | | 7/8□– 4-pin | 568956 CPX-M-GE-EV-S-7/8-CIP-4P |
| | | Push-pull – 5-pin | 563057 CPX-M-GE-EV-S-PP-5POL |
| | | 7/8□– 5-pin | 550210 CPX-M-GE-EV-Z-7/8-5POL |
| | With additional power supply for outputs | 7/8□– 5-pin, for ATEX environment | 8022158 CPX-M-GE-EV-Z-7/8-5POL-VL |
| | | Push-pull – 5-pin | 563058 CPX-M-GE-EV-Z-PP-5POL |

Terminal CPX

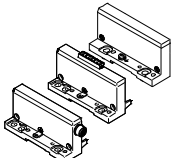
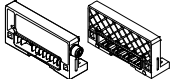
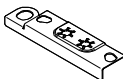
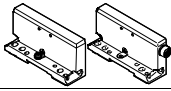
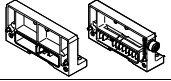
Accessories

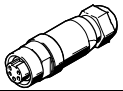
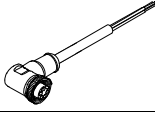
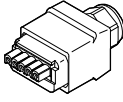

FESTO

| Ordering data – Accessories | | | | |
|---|---|--|------------------------------|-----------------------------|
| Designation | | | Part No. | Type |
| Mounting accessories | | | | |
|  | Screws for mounting the bus node/connection block on a plastic interlinking block | Bus node/metal connection block | 550218 | CPX-DPT-30X32-S-4X |
| | Screws for mounting the bus node/connection block on a metal interlinking block | Bus node/plastic connection block | 550219 | CPX-M-M3x22-4x |
| | | Bus node/metal connection block | 550216 | CPX-M-M3x22-S-4x |
| End plates for plastic version | | | | |
|  | End plate, left-hand | – | 195716 | CPX-EPL-EV |
| | | With system supply | 576315 | CPX-EPL-EV-S |
| | | With extension | 576314 | CPX-EPL-EV-X |
|  | End plate, right-hand | – | 195714 | CPX-EPR-EV |
| | | With extension | 576313 | CPX-EPR-EV-X |
|  | Earthing element for right-hand/left-hand end plate | 5 pieces | 538892 | CPX-EPFE-EV |
| End plates for metal version | | | | |
|  | End plate, left-hand | – | 550212 | CPX-M-EPL-EV |
| | | With extension | 576317 | CPX-M-EPL-EV-X |
|  | End plate, right-hand | – | 550214 | CPX-M-EPR-EV |
| | | With extension | 576316 | CPX-M-EPR-EV-X |
| Power supply | | | | |
|  | Plug socket for mains connection M18x1, straight, 4-pin | For 1.5 mm ² | 18493 | NTSD-GD-9 |
| | | For 2.5 mm ² | 18526 | NTSD-GD-13,5 |
| | Plug socket for mains connection M18x1, angled, 4-pin | For 1.5 mm ² | 18527 | NTSD-WD-9 |
| | | For 2.5 mm ² | 533119 | NTSD-WD-11 |
|  | Plug socket for mains connection 7/8", straight, 5-pin | 0.25 ... 2.0 mm ² | 543107 | NECU-G78G5-C2 |
| | | Plug socket for mains connection 7/8", straight, 4-pin | 0.25 ... 2.0 mm ² | 543108 |
|  | Plug socket for mains connection 7/8" angled, 5-pin – open cable end, 5-wire | 2 m | 573855 | NEBU-G78W5-K-2-N-LE5 |
|  | Connection socket AIDA push-pull, spring-loaded terminal | 5-pin | 563059 | NECU-M-PPG5-C1 |
|  | Straight plug, spring-loaded terminal, for end plate left-hand with system supply | 7-pin | 576319 | NECU-L3G7-C1 |

Terminal CPX

Accessories

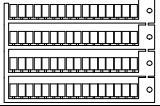
FESTO

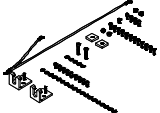
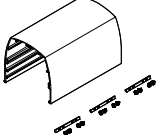
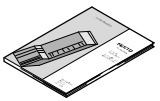
| Ordering data – Accessories | | | | |
|---|---|----------|---------------|--------------------------|
| Designation | | | Part No. | Type |
| Inscription labels | | | | |
|  | Inscription labels 6x10, 64 pieces, in frames | | 18576 | IBS-6x10 |
| Hood | | | | |
|  | Mounting rail for securing the cover | 1,000 mm | 572256 | CAFC-X1-S |
|  | Mounting kit for CPX cover | | 572257 | CAFC-X1-BE |
|  | Hood section for CPX terminal including mounting attachments for connecting several hood sections in series | 200 mm | 572258 | CAFC-X1-GAL-200 |
| | | 300 mm | 572259 | CAFC-X1-GAL-300 |
| Manual | | | | |
|  | CPX System Manual | German | 526445 | P.BE-CPX-SYS-DE |
| | | English | 526446 | P.BE-CPX-SYS-EN |
| | | Spanish | 526447 | P.BE-CPX-SYS-ES |
| | | French | 526448 | P.BE-CPX-SYS-FR |
| | | Italian | 526449 | P.BE-CPX-SYS-IT |
| | Operator unit CPX-MMI-1 | German | 534824 | P.BE-CPX-MMI-1-DE |
| | | English | 534825 | P.BE-CPX-MMI-1-EN |
| | | French | 534827 | P.BE-CPX-MMI-1-FR |
| | | Italian | 534828 | P.BE-CPX-MMI-1-IT |
| | | Spanish | 534826 | P.BE-CPX-MMI-1-ES |

Terminal CPX

Accessories

FESTO

User manuals – General information

Comprehensive user manuals are vital for the fast and reliable use of fieldbus components.

The manuals provided by Festo contain step-by-step instructions for using CPX terminals:

1. Installation
2. Commissioning and parameterisation
3. Diagnostics

Application-oriented explanations are provided for integration of the CPX terminal in the programming and configuration software of the various controller manufacturers.

Use the order code to select the language you want.

The manual for the configuration you have ordered is supplied automatically.

The documents can be quickly and easily downloaded from the Festo website.

➔ www.festo.com



Overview – User manuals

| Type | Title | Description |
|----------------------|---|--|
| Pneumatic components | | |
| P.BE-VTSA-44-... | Valve terminals with VTSA and VTSA-F pneumatics | Instructions on assembly, installation, commissioning and diagnostics of the VTSA and VTSA-F pneumatic components. |
| P.BE-CPA-... | Valve terminals with CPA pneumatics | Instructions on assembly, installation, commissioning and diagnostics of the CPA pneumatic components. |
| P.BE-MPA-... | Valve terminals with MPA-S pneumatics | Instructions on assembly, installation, commissioning and diagnostics of the MPA-S pneumatic components. |
| P.BE-MPAF-... | Valve terminals with MPA-F pneumatics | Instructions on assembly, installation, commissioning and diagnostics of the MPA-F pneumatic components. |
| P.BE-MPAL-... | Valve terminals | Instructions on assembly, installation, commissioning and diagnostics of the MPA-L pneumatic components. |

Terminal CPX

Accessories

FESTO

| Overview – User manuals | | |
|---------------------------|--|---|
| Type | Title | Description |
| Electronic components | | |
| P.BE-CPX-SYS-... | System description, installation and commissioning | Overview of the design, components and mode of operation of the CPX terminal; installation and commissioning instructions as well as basic principles of parameterisation |
| P.BE-CPX-FVDA-P2-... | PROFIsafe shut-off module | Connection technology and instructions on mounting, installing and commissioning for the PROFIsafe shut-off module of the type CPX-FVDA-P2 |
| P.BE-CPX-EA-... | CPX-EA modules, digital | Connection technology and assembly, installation and commissioning instructions for digital input and output modules of the type CPX-... as well as CPA, VTSA/VTSA-F and MPA-S/F/L pneumatic interface |
| P.BE-CPX-F8DE-P-... | Input module CPX-F8DE-P | Connection technology and assembly, installation and commissioning instructions for PROFIsafe input module of the type CPX-F8DE-P |
| P.BE-CPX-2ZE2DA-... | EA module CPX-2ZE2DA | Connection technology and instructions on mounting, installing and commissioning for the counter module of the type CPX-2ZE2DA |
| P.BE-CPX-AX-... | CPX-EA modules, analogue | Connection technology and assembly, installation and commissioning instructions for analogue input and output modules of the type CPX-... as well as pressure sensors and proportional pressure regulators. |
| P.BE-CPX-CP-... | CPX CP interface | Instructions on assembly, installation, commissioning and diagnostics of the CP interface |
| P.BE-CPX-CTEL-... | CPX CTEL interface | Instructions on assembly, installation, commissioning and diagnostics of the CPX CTEL master |
| P.BE-CPX-CTEL-LK-... | Electrical interface CPX-CTEL-2 | Instructions on assembly, installation, commissioning and diagnostics of the electrical interface CPX for IO-Link |
| P.BE-CPX-CM-HPP-... | CPX axis interface | Instructions on assembly, installation, commissioning and diagnostics of the CPX axis interface (CM-HPP) |
| P.BE-CPX-CMAX-SYS-... | CPX axis controller | Instructions on assembly, installation, commissioning and diagnostics of the CPX axis controller (CMAX) |
| P.BE-CPX-CMAX-CONTROL-... | CPX axis controller | Information on controlling, diagnosing and parameterising the axis controller via the fieldbus |
| P.BE-CPX-CMPX-SYS-... | CPX end-position controller | Instructions on assembly, installation, commissioning and diagnostics of the CPX end-position controller (CMPX) |
| P.BE-CPX-CMIX-... | CPX measuring module | Instructions on assembly, installation, commissioning and diagnostics of the CPX measuring module (CMIX) |
| P.BE-CPX-FB-... | CPX bus node | Instructions on assembly, installation, commissioning and diagnostics of the relevant bus nodes |
| P.BE-CPX-PNIO-... | CPX bus node for PROFINET | Instructions on assembly, installation, commissioning and diagnostics of the relevant bus nodes |
| P.BE-CPX-FEC-... | CPX control block | Instructions on assembly, installation, commissioning and diagnostics of the relevant control block |
| P.BE-CPX-CEC-... | CPX CoDeSys controller (control block) | Instructions on assembly, installation, commissioning and diagnostics of the relevant control block |
| P.BE-CPX-MMI-1-... | Universal handheld type CPX-MMI-1 | Instructions on assembly, installation, commissioning and diagnostics of the CPX operator unit |

User manuals – GSD, EDS, etc.

Device description files and icons are used to explain the integration of the CPX terminal in the configuration software of the various controller manufacturers.

These can be downloaded quickly and easily from www.festo.com.

Terminal CPX

Technical data – Operator unit CPX-MMI-1

FESTO

-  - Width
81 mm

The operator unit is a small, convenient commissioning and service device for the CPX terminal. It provides data polling, configuration and diagnostic functions for CPX terminals. Its extremely flexible application range means that data can be read in or out at any location. IP65 compatibility makes it suitable for use in harsh industrial environments.



Application

Functions

- Advance commissioning through the monitoring/forcing of inputs and outputs without fieldbus master/PLC
- Test function for parameter settings, for example fail-safe of the outputs or switch-on delay of the inputs
- Plain-text diagnostics of module and channel-oriented errors
- Condition monitoring: preselection/loading of counters, activation of the channels to be monitored
- Display of the last 40 error occurrences with timestamp
- Identification of sporadic causes of errors through display of the diagnostic history
- Password protection

Connection

The operator unit is connected to the CPX bus nodes or control block, as appropriate, using a M12 connecting cable.

The voltage for the operator unit is supplied by the CPX component

Communication

Once connected to the CPX terminal, the operator unit loads the available configuration for the I/O modules, valves, etc.

This ensures the availability of up-to-date texts, messages, menus and displays. Status information, diagnostic messages and parameter bits are then exchanged during operation.

Assembly

A mounting bracket for the operator unit offers the option of wall or H-rail mounting.

The mounting bracket also has an option for temporary mounting using a hanging device.

Terminal CPX

Technical data – Operator unit CPX-MMI-1

Connection

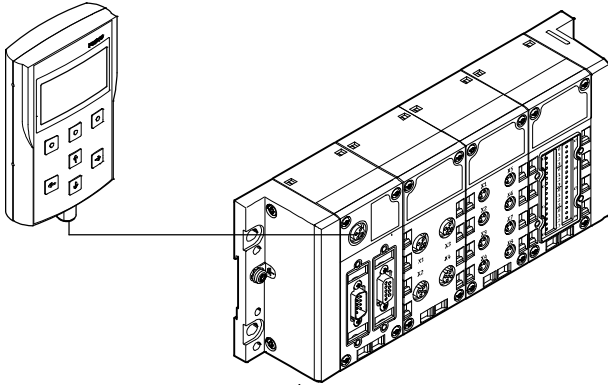

The operator unit is connected to the CPX terminal using a pre-assembled connecting cable.

Function examples

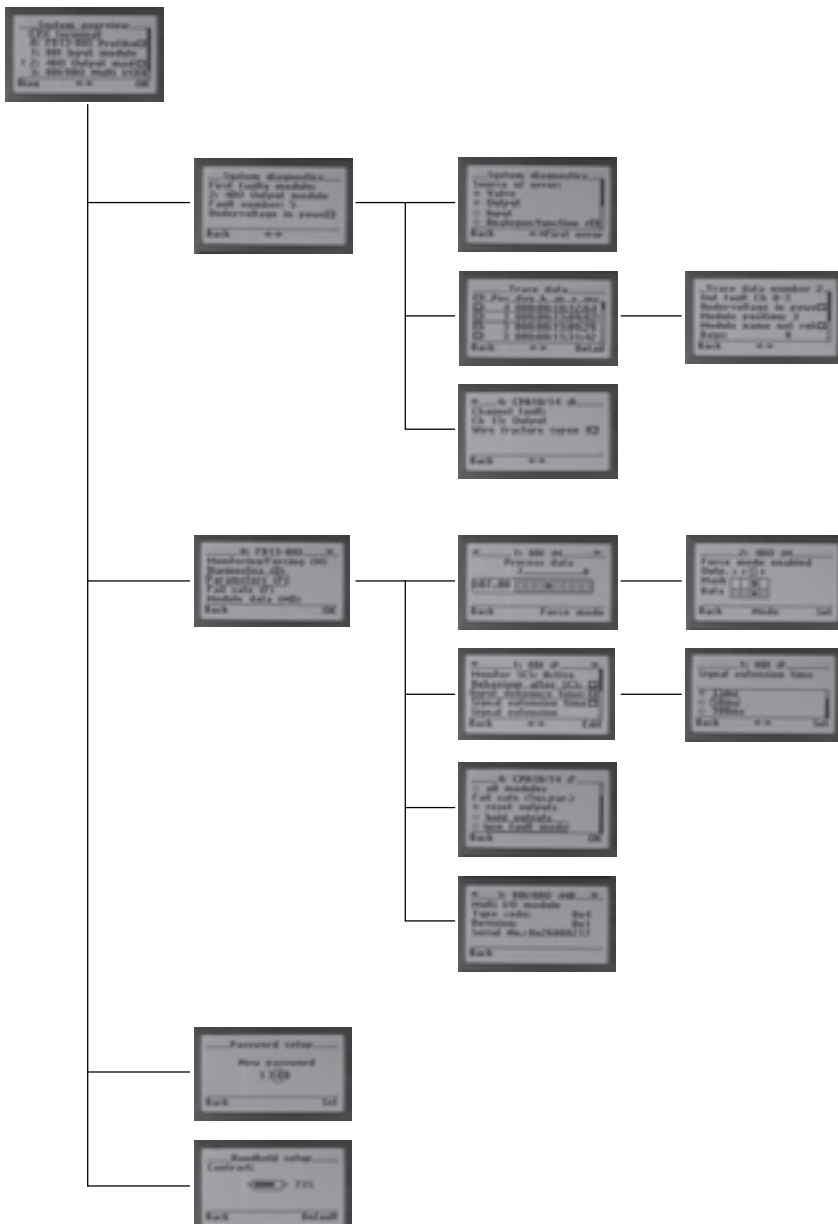

System overview

- Overview of configured modules and current diagnostic messages

Diagnostics

- Fast access to the diagnostic history and the modules with diagnostic messaging
- Display of the last 40 diagnostic messages with timestamp
- Display of the current diagnostic message for a module

Commissioning

- Selection of module-specific data and parameters
- Display and modification of the current status of the inputs and outputs of a module
- Display and modification of the current settings for module-specific parameters

Setup

- Setting of access permission (password)
- Contrast setting of the display

Terminal CPX

Technical data – Operator unit CPX-MMI-1

FESTO

| General technical data | | |
|-------------------------------|--|--------------------------------------|
| Type | CPX-MMI-1 | |
| Data interface | RS232 interface, 57.6 kBaud, M12 socket, 4-pin | |
| Display component | LCD graphical display with background illumination (128 x 64 pixels) | |
| Control elements | 7 keys: 4 arrow keys and 3 function keys, touch-sensitive keypad | |
| Electromagnetic compatibility | Interference emission tested to DIN EN 61000-6-4, industry | |
| | Interference immunity tested to DIN EN 61000-6-2, industry | |
| Nominal operating voltage | [V DC] | 24, supplied by the connected device |
| Operating voltage range | [V DC] | 18 ... 30 |
| Current consumption | [mA] | 50 ... 60 |
| Protection class to IEC 60529 | IP65 | |
| Relative air humidity | [%] | 90, non-condensing |
| Vibration resistance | Tested to DIN/IEC 68/EN 60068, Part 2-6 | |
| | <ul style="list-style-type: none"> • With wall mounting: Severity level 2 • With H-rail mounting: Severity level 1 | |
| Shock resistance | Tested to DIN/IEC 68/EN 60068, Part 2-27 | |
| | <ul style="list-style-type: none"> • With wall mounting: Severity level 2 • With H-rail mounting: Severity level 1 | |
| Materials | Reinforced PA | |
| Dimensions (W x H x D) | [mm] | 81 x 137 x 28 |
| Weight | [g] | 150 |

| Operating and environmental conditions | | |
|---|---|----------------------------|
| Ambient temperature | [°C] | 0 ... 50 |
| CE mark (see declaration of conformity) | To EU EMC Directive ¹⁾ | |
| | In accordance with EU Explosion Protection Directive (ATEX) | |
| ATEX category | Gas | II 3 G |
| | Dust | II 3 D |
| EX-ignition protection type | Gas | Ex nA IIC T6 X Gc |
| | Dust | Ex tc IIIC T60°C X Dc IP65 |
| ATEX ambient temperature | [°C] | -5 ≤ Ta ≤ +50 |

1) For information about the applicability of the component see the manufacturer's EC declaration of conformity at: www.festo.com/sp → User documentation.
If the component is subject to restrictions on usage in residential, office or commercial environments or small businesses, further measures to reduce the emitted interference may be necessary.

 Note



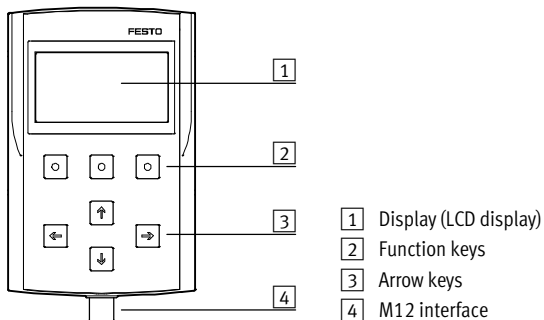

When operating device combinations in hazardous areas, the lowest common zone, temperature class and ambient temperature of the individual devices determine the possible use of the entire module.

Connection and display components

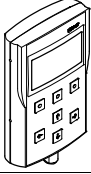

Terminal CPX

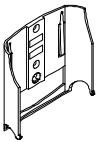
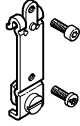
Accessories – Operator unit CPX-MMI-1

| Ordering data | | | | |
|---|---|---------|---------------|--------------------------|
| Designation | | | Part No. | Type |
| Operator unit | | | | |
|  | Provides data polling, configuration and diagnostic functions for CPX terminals | | 529043 | CPX-MMI-1 |
| Connecting cable | | | | |
|  | Connecting cable M12-M12, specially for CPX-MMI | 1.5 m | 529044 | KV-M12-M12-1,5 |
| | | 3.5 m | 530901 | KV-M12-M12-3,5 |
| Mounting | | | | |
|  | Bracket | | 534705 | CPX-MMI-1-H |
|  | Mounting for H-rail | | 536689 | CPX-MMI-1-NRH |
| User manual | | | | |
|  | User manual for operator unit CPX-MMI-1 | German | 534824 | P.BE-CPX-MMI-1-DE |
| | | English | 534825 | P.BE-CPX-MMI-1-EN |
| | | French | 534827 | P.BE-CPX-MMI-1-FR |
| | | Italian | 534828 | P.BE-CPX-MMI-1-IT |
| | | Spanish | 534826 | P.BE-CPX-MMI-1-ES |

Terminal CPX

Technical data – CPX Maintenance Tool



Function

CPX Maintenance Tool (CPX-FMT) combines service software with a connecting adapter. The service software is a tool for the design, parameterisation and online diagnostics of the CPX terminal. The USB-to-M12 adapter features built-in galvanic isolation (between CPX and PC) and enables a PC to be connected to the diagnostic interface of the CPX terminal.

- Adapter
- Software on CD-ROM



Application

Only from Festo

The CPX-FMT software enables access to CPX valve terminals via Ethernet with the control block CPX-FEC and the bus nodes EtherNet/IP (FB 32), Sercos III (FB 39) and PROFINET (FB 33, FB 34, FB 35, FB 41). The bus nodes or control block can be connected directly to the PC via a USB adapter from Festo.. Similar to the

CPX-MMI, diagnostic data such as the error trace or module diagnostics can be read out and parameters can be modified in plain text. In contrast to the CPX-MMI, the data can be used directly on a PC. There is an option, for example, to send screenshots of a configuration or the current error trace directly via e-mail. In addition,

CPX configurations can also be saved and archived directly as a CPX-FMT project. Undocumented changes can subsequently be identified using the online/offline comparison function. On-site tests such as the actuation of valves or the emulation of sensor feedback (in both cases called “forcing”), for example, can be

performed without an existing controller infrastructure. It must be noted that with both the CPX-FMT and the CPX-MMI, only local parameters on the CPX valve terminal can be changed and saved. The configuration of the networks or controller software cannot be influenced.

| General technical data | | |
|---|--|--|
| Type | NEFC-M12G5-03-U1G5 | |
| System requirements | PC | IBM-compatible |
| | Drive | CD-ROM |
| | Interfaces | USB port (specification USB 1.1 or higher) |
| | Operating system | Microsoft Windows 2000 or XP |
| Functional range | <ul style="list-style-type: none"> • Configuration and parameterisation • Reading out of system, module, channel diagnostics and error trace • Saving of the configuration as a project • Integration of plug-ins/links to self-executing programs | |
| Scope of delivery | <ul style="list-style-type: none"> • Adapter M12, 5-pin to mini USB socket • CD-ROM with installation program | |
| Type of mounting | Screw-in | |
| Electrical connection | Plug M12x1, 5-pin | |
| Adapter cable composition | 4 x 0.34 mm ² | |
| Cable length | [m] | 0.3 |
| Protection class to EN 60529 | IP20 | |
| CE mark (see declaration of conformity) | To EU EMC Directive | |
| Ambient temperature | [°C] | -5 ... +50 |
| Material | Housing | ABS |
| | Cable sheath | PUR |
| | Pin contact | Gold-plated brass |
| Note on materials | RoHS-compliant | |

Terminal CPX

Technical data – CPX Maintenance Tool

Display components

Creating a device configuration using the editor

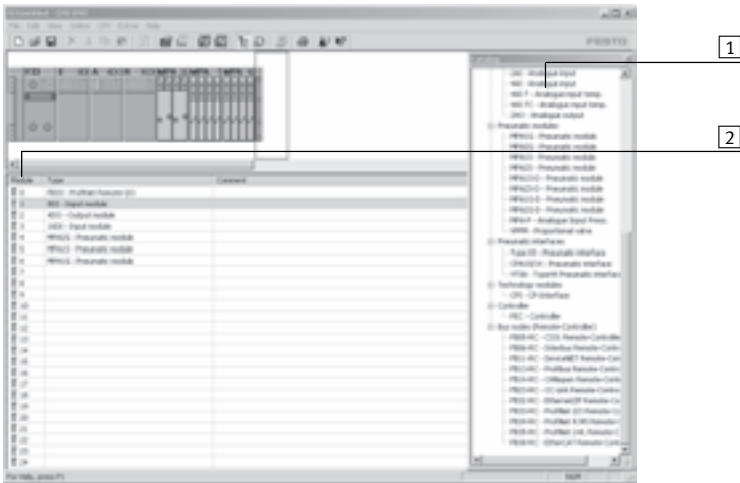

The device configuration can be conveniently generated, parameterised and saved using the drag & drop feature. You can insert and move modules.

- 1 Module numbers from the graphic system overview
- 2 Catalogue for selecting required modules

Module overview for a selected module

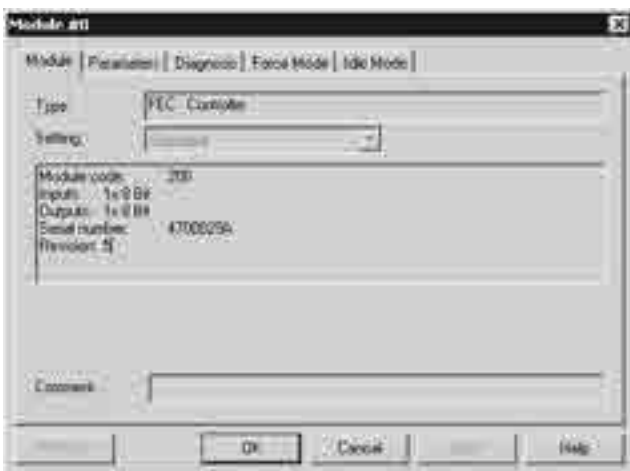

Displays important module data as well as the number of allocated inputs and outputs.

Diagnostic memory

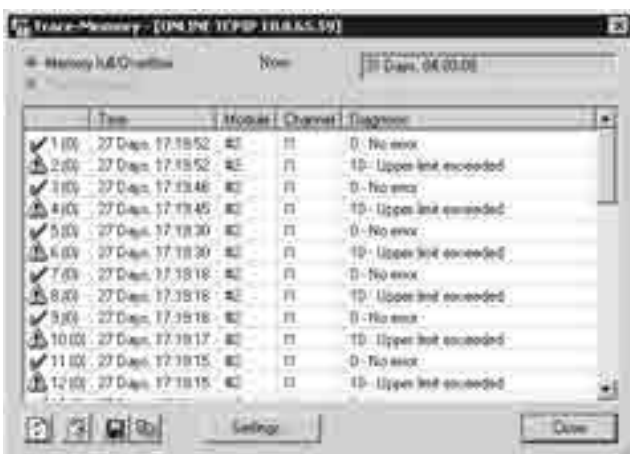

Faults which occur during operation are entered in a diagnostic memory. The first or the last 40 entries are saved, as well as the respective time measured from the moment the power supply was switched on.

Terminal CPX

Technical data – CPX Maintenance Tool

Dimensions

Download CAD data → www.festo.com

Adapter

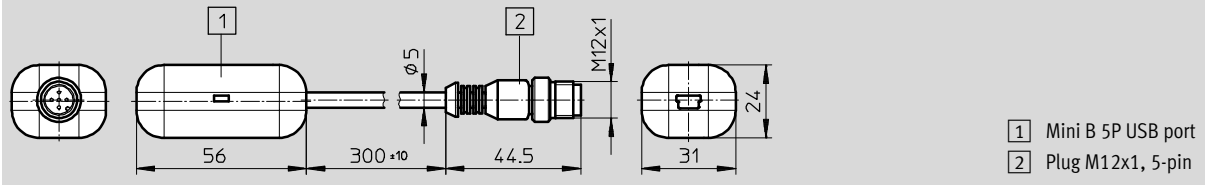

Ordering data

| Designation | Part No. | Type |
|---|---------------|---------------------------|
|  CPX Maintenance Tool (CPX-FMT), software and USB-to-M12 adapter | 547432 | NEFC-M12G5-03-U1G5 |

Terminal CPX

Technical data – Control block CPX-FEC

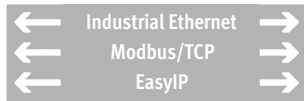

IT services:

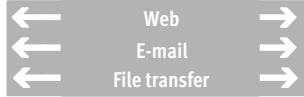

Powerful control block for pre-processing actuation of the CPX modules.

The power supply to and communication with other modules takes place via the interlinking block.

In addition to the connection for the Ethernet interface in RJ45 and a programming interface in Sub-D, LEDs are also provided for the bus status, operating status of the PLC and CPX peripherals information, as are switching elements and a diagnostic interface for CPX-MMI and CPX-FMT.



Application

| Bus connection | Modbus/TCP (code T05) |
|--|---|
| The CPX-FEC is a remote controller that can be connected to a master PLC via the bus nodes of the CPX terminal or via Ethernet. At the same time, it is possible to operate the CPX-FEC as a compact stand-alone controller directly on the machine. | Transmits data in binary format within TCP/IP packets. This ensures good data throughput. |

| Operating modes | Communication protocols |
|---|--|
| <ul style="list-style-type: none"> Stand-alone/EasyIP Fieldbus remote controller Modbus/TCP remote controller Remote I/O Modbus/TCP | <ul style="list-style-type: none"> PROFIBUS, PROFINET, DeviceNet, INTERBUS, CANopen, EtherCAT and CC-Link via CPX bus node Modbus/TCP EasyIP IP TCP UDP SMTP HTTP DHCP BootP TFTP |

| Setting options | | |
|---|--|--|
| CPX-FEC has the following interfaces for monitoring, programming and commissioning: | <ul style="list-style-type: none"> For the CPX-MMI/-FMT Serial interface RS232, for example, for a Front End Display (FED) Ethernet interface for IT applications Remote diagnostics | <p>The operating mode and fieldbus protocol are set using the DIL switch on the CPX-FEC.</p> <p>The integrated web server offers a convenient means of querying data saved in the CPX-FEC.</p> |

Terminal CPX

Technical data – Control block CPX-FEC



| General technical data | | | |
|---|--------------------|---|--------------------------------|
| Type | | CPX-FEC-1-IE | |
| Ethernet interface | | RJ45 (8-pin, socket) | |
| Data interface | | RS232 (Sub-D, 9-pin, socket) | |
| MMI/FMT interface | | M12, 5-pin, socket | |
| Baud rate | Ethernet interface | [Mbit/s] | 10/100 (to IEEE802.3, 10BaseT) |
| | Data interface | [kbit/s] | 9.6 ... 115.2 |
| | MMI/FMT interface | [kbit/s] | 56.6 |
| Protocol | | <ul style="list-style-type: none"> • TCP/IP • Easy IP • Modbus TCP • HTTP | |
| Processing time for 1,024 binary instructions | | [ms] | Approx. 1 |
| Flags | | M0.0 ... M9999, addressable as bits or words | |
| | | No. of time flags | T0 ... T255 |
| | | Time range | [s] 0.01 to 655.35 |
| | | No. of counting flags | Z0 ... Z255 |
| | | Counting range | 0 to 65535 |
| Register | | R0 ... R255, addressable as words | |
| Special FE | | FE 0 ... 255, init flag | |
| IP address setting | | BOOTP/DHCP via FST or via MMI/FMT | |
| Max. address capacity | Inputs | [byte] | 64 |
| | Outputs | [byte] | 64 |
| Program memory | User program | [kB] | 250 |
| | Web applications | [kB] | 550 |
| Programming language | | <ul style="list-style-type: none"> • IL • LD | |
| Arithmetic functions | | +, -, *, :, further functions via functional modules | |
| Functional modules | | <ul style="list-style-type: none"> • CPX diagnostic status • Copy CPX diagnostic trace • Read CPX module diagnostics • Write CPX module parameter • ... | |
| No. of programs/tasks | | P0 ... P63 | |
| LED displays (FEC-specific) | | RUN = Program is being executed/Modbus connection active STOP = Program is stopped/no Modbus connection ERR = Error in the program execution TP = Status of the Ethernet connection | |
| Device-specific diagnostics | | Module and channel-oriented diagnostics via peripherals error | |
| Parameterisation | | <ul style="list-style-type: none"> • Start-up parameterisation via FST • Parameterisation during the operating time via functional module | |
| Control elements | | <ul style="list-style-type: none"> • DIL switch for setting the operating mode • Rotary switch for program selection/program start | |
| Additional functions | | <ul style="list-style-type: none"> • Storage of the last 40 errors with timestamp (access via PCP) • 8-bit system status in image table for inputs • 2-byte inputs and 2-byte outputs, system diagnostics in image table | |

Terminal CPX

Technical data – Control block CPX-FEC

| General technical data | | | |
|---|----------------------------|--------|---------------------------------|
| Operating voltage | Nominal value | [V DC] | 24 (reverse polarity protected) |
| | Permissible range | [V DC] | 18 ... 30 |
| | Power failure buffering | [ms] | 10 |
| Residual ripple | | [Vss] | 4 |
| Current consumption | | [mA] | Max. 200 |
| Interference emission | To EN 61000-6-4 (industry) | | |
| Interference immunity | To EN 61000-6-2 (industry) | | |
| Protection class to EN 60529 | IP65, IP67 | | |
| Temperature range | Operation | [°C] | –5 ... +50 |
| | Storage/transport | [°C] | –20 ... +70 |
| Materials | Plastic | | |
| Grid dimension | | [mm] | 50 |
| Dimensions (incl. interlinking block) W x L x H | | [mm] | 50 x 107 x 55 |
| Weight | | [g] | 140 |

 Note

Please observe the general limits and guidelines for the system when configuring the electrical modules.

| Overview of the operating modes | Stand-alone | Remote controller | | Remote I/O |
|--|--|--|--------------|--|
| | | Ethernet | Fieldbus | Modbus/TCP |
| CPX-FEC function | Control | Control and communication | | Ethernet slave |
| CPX module controlled by | CPX-FEC | CPX-FEC | | Higher-order controller |
| Pre-processing of data in the FEC | Yes | Yes | | No |
| Communication with higher-order controller | No | Via Ethernet • EasyIP • Modbus/TCP | Via fieldbus | Via Ethernet • EasyIP • Modbus/TCP |
| Web server | Possible | Possible | | Possible |
| Configuration | FST 4.1 or higher | FST 4.1 or higher | | Higher-order controller |
| Parameterisation | Via FST, CPX-MMI/-FMT | Via FST, CPX-MMI/-FMT | | Via CPX-MMI/-FMT, Modbus |
| Order code | T03 | T03 | | T05 |
| Addressing | Changeable | Changeable | | Preset |
| Memory | • 250 kB for user program • 550 kB for web applications | • 250 kB for user program • 550 kB for web applications | | • 800 kB for web applications |
| CPX-MMI/-FMT | Can be connected to CPX-FEC | Can be connected to CPX-FEC | | Can be connected to CPX-FEC |

Terminal CPX

Technical data – Control block CPX-FEC

Connection and display components



Pin allocation for the programming interface (RS232)

| Pin allocation | Pin | Signal | Designation |
|---------------------|---------|----------|-------------------------------------|
| Sub-D socket | | | |
| | 1 | n.c. | Not connected |
| | 2 | RxD | Received data |
| | 3 | TxD-P | Transmitted data |
| | 4 | n.c. | Not connected |
| | 5 | GND | Data reference potential |
| | 6 | n.c. | Not connected |
| | 7 | n.c. | Not connected |
| | 8 | n.c. | Not connected |
| | 9 | n.c. | Not connected |
| | Housing | Screened | Connection to functional earth (FE) |

Pin allocation for the Ethernet interface

| Pin allocation | Pin | Signal | Designation |
|--------------------|----------|----------|-------------------|
| RJ45 socket | | | |
| | 1 | TD+ | Transmitted data+ |
| | 2 | TD- | Transmitted data- |
| | 3 | RD+ | Received data+ |
| | 4 | n.c. | Not connected |
| | 5 | n.c. | Not connected |
| | 6 | RD- | Received data- |
| | 7 | n.c. | Not connected |
| | 8 | n.c. | Not connected |
| Housing | Screened | Screened | |





Ordering data

| Designation | Part No. | Type |
|--|---------------|---------------------|
| Control block | | |
| <p>For pre-processing actuation of the CPX modules</p> | 529041 | CPX-FEC-1-IE |

Terminal CPX

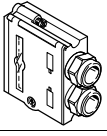
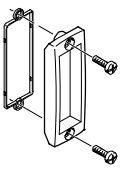
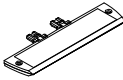
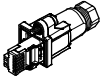
Accessories – Control block CPX-FEC

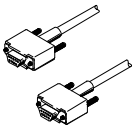
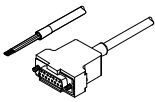
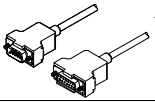
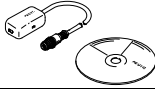

| Ordering data | | | |
|---|---|----------|------------------------|
| Designation | | Part No. | Type |
| Bus connection | | | |
|  | Sub-D plug | 534497 | FBS-SUB-9-GS-1x9POL-B |
|  | Inspection cover, transparent | 533334 | AK-SUB-9/15-B |
|  | Inscription label holder for connection block | 536593 | CPX-ST-1 |
|  | RJ45/plug | 534494 | FBS-RJ45-8-GS |
|  | Cover for RJ45 connection | 534496 | AK-RJ45 |
|  | Programming cable | 151915 | KDI-PPA-3-BU9 |
|  | Connecting cable FED | 539642 | FEC-KBG7 |
|  | Connecting cable FED | 539643 | FEC-KBG8 |
|  | Adapter from 5-pin M12 to mini USB socket and controller software | 547432 | NEFC-M12G5-0.3-U1G5 |
| User manual | | | |
|  | User manual for control block CPX-FEC | German | 538474 P.BE-CPX-FEC-DE |
| | | English | 538475 P.BE-CPX-FEC-EN |
| | | Spanish | 538476 P.BE-CPX-FEC-ES |
| | | French | 538477 P.BE-CPX-FEC-FR |
| | | Italian | 538478 P.BE-CPX-FEC-IT |
| Software | | | |
|  | Programming software | German | 537927 P.SW-FST4-CD-DE |
| | | English | 537928 P.SW-FST4-CD-EN |

Terminal CPX

Technical data – Control block CPX-CEC

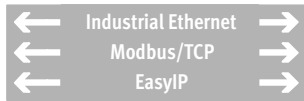

IT services:

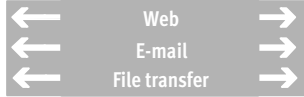

The CODESYS controller is a modern control system for CPX terminals that enables programming with CODESYS to IEC 61131-3.

The power supply to and communication with other modules takes place via the interlinking block.

In addition to network connections, LEDs are also provided for the bus status, operating status of the PLC and CPX peripherals information, as are switching elements and a diagnostic interface for CPX-MMI and CPX-FMT.



| Application | | | |
|--|--|--|---|
| Bus connection | | Communication protocols | Operating modes |
| The CPX-CEC is a remote controller that can be connected to a master PLC via the fieldbus nodes of the CPX terminal or via Ethernet. At the same | time, it is possible to operate the CPX-CEC as a compact stand-alone controller directly on the machine. | <ul style="list-style-type: none"> Fieldbus via CPX fieldbus nodes Modbus/TCP EasyIP | <ul style="list-style-type: none"> Stand-alone Remote controller, fieldbus Remote controller, Ethernet |
| Setting options | | | |
| The CPX-CEC has the following interfaces for monitoring, programming and commissioning: | <ul style="list-style-type: none"> For the CPX-MMI/-FMT Ethernet interface for IT applications Remote diagnostics | The operating mode and fieldbus protocol are set using the DIL switch on the CPX-CEC. | The integrated web server offers a convenient means of querying data saved in the CPX-CEC. |
| Features | | | |
| <ul style="list-style-type: none"> Easy actuation of valve terminal configurations with MPA, VTSA Diagnostics with flexible monitoring options for pressure, flow rate, cylinder operating time, air consumption | <ul style="list-style-type: none"> Actuation of decentralised installation systems on the basis of CPI actuation of applications in proportional pneumatics AS-Interface actuation via gateway | <ul style="list-style-type: none"> Connection to all fieldbuses as a remote controller and for pre-processing Actuation of electric drives as individual axes via CANopen (CPX-CEC-C1/-M1) | <ul style="list-style-type: none"> Early warnings and visualisation options Closed-loop pneumatic applications |

Terminal CPX

Technical data – Control block CPX-CEC



| General technical data | | |
|---|---|---------------------------------------|
| Protocol | CODESYS Level 2 | |
| | EasyIP | |
| | Modbus TCP | |
| | TCP/IP | |
| Processing time | Approx. 200 µs/1 k instruction | |
| Programming software | CODESYS provided by Festo | |
| Programming language | To IEC 61131-3 | |
| | Sequential function chart (SFC) | |
| | Instruction list (IL) | |
| | Function chart (FCH), additional continuous function chart (CFC) | |
| | Ladder diagram (LD) | |
| Programming | Operating language | German, English |
| | Support for file handling | Yes |
| Device-specific diagnostics | Diagnostic memory | |
| | Channel and module-oriented diagnostics | |
| | Undervoltage/short circuit of modules | |
| LED displays | Bus-specific | TP: Link/traffic |
| | Product-specific | RUN: PLC status |
| | | STOP: PLC status |
| | | ERR: PLC runtime error |
| | | PS: Electronics supply, sensor supply |
| | | PL: Load supply |
| | | SF: System fault |
| | | M: Modify/forcing active |
| IP address setting | DHCP | |
| | Via CODESYS | |
| | Via MMI | |
| Function blocks | CPX diagnostic status, copy CPX diagnostic trace, read CPX module diagnostics, etc. | |
| Dimensions (incl. interlinking block) W x L x H | [mm] | 50 x 107 x 55 |

| Materials | |
|-------------------|----------------|
| Housing | Reinforced PA |
| | PC |
| Note on materials | RoHS-compliant |

| Operating and environmental conditions | | |
|--|------|--------------------|
| Ambient temperature | [°C] | –5 ... +50 |
| Storage temperature | [°C] | –20 ... +70 |
| Relative air humidity | [%] | 95, non-condensing |
| Corrosion resistance class CRC ¹⁾ | | 2 |

1) Corrosion resistance class CRC 2 to Festo standard FN 940070

Moderate corrosion stress. Indoor applications in which condensation may occur. External visible parts with primarily decorative requirements for the surface and which are in direct contact with the ambient atmosphere typical for industrial applications.

| Electrical data | | | |
|--|---------------------------|--------|---------------|
| Nominal operating voltage | [V DC] | | 24 |
| Load voltage | Nominal operating voltage | [V DC] | 24 |
| | With pneumatics type CPA | [V DC] | 20.4 ... 26.4 |
| | With pneumatics type MPA | [V DC] | 18 ... 30 |
| | Without pneumatics | [V DC] | 18 ... 30 |
| Power failure buffering | [ms] | | 10 |
| Intrinsic current consumption at nominal operating voltage | [mA] | | Typically 85 |
| Degree of protection to EN 60529 | | | IP65, IP67 |

Terminal CPX

Technical data – Control block CPX-CEC



| Technical data | | | | | |
|------------------------------|--|--------|--------------------------------------|--------------------------|--|
| Type | | | CPX-CEC-C1 | CPX-CEC-C1-V3 | CPX-CEC-M1-V3 |
| Additional functions | | | Motion functions for electric drives | | SoftMotion functions for electric drives |
| CPU data | Flash | [MB] | 32 | 32 | 32 |
| | RAM | [MB] | 32 | 256 | 256 |
| | Processor | [MHz] | 400 | 800 | 800 |
| Control interface | | | CAN bus | CAN bus | CAN bus |
| Parameterisation | | | CODESYS V2.3 | CODESYS V3 | CODESYS V3 |
| Configuration support | | | CODESYS V2.3 | CODESYS V3 | CODESYS V3 |
| Program memory, user program | | [MB] | 4 | 16 | 16 |
| Flags | | | CODESYS variable concept | | |
| | Remanent data | [kB] | 30 | 28 | 28 |
| | Global data memory | [MB] | 8 | – | – |
| Control elements | | | DIL switch for CAN termination | | |
| | | | Rotary switch for RUN/STOP | | |
| Total number of axes | | | 31 | 127 | 31 |
| Ethernet | Number | | 1 | | |
| | Connection technology | | RJ45 socket, 8-pin | | |
| | Data transmission speed | [Mbps] | 10/100 | | |
| | Supported protocols | | TCP/IP, EasyIP, Modbus TCP | | |
| Fieldbus interface | Number | | 1 | | |
| | Connection technology | | Sub-D plug connector, 9-pin | | |
| | Data transmission speed, can be set via software | [kbps] | 125, 250, 500, 800, 1000 | 125, 250, 500, 800, 1000 | 125, 250, 500, 800, 1000 |
| | Supported protocols | | CAN bus | | |
| | Galvanic isolation | | Yes | | |

| Technical data | | | | |
|------------------------------|-------------------------|--------|------------------------------|---------------|
| Type | | | CPX-CEC | CPX-CEC-S1-V3 |
| CPU data | Flash | [MB] | 32 | 32 |
| | RAM | [MB] | 32 | 256 |
| | Processor | [MHz] | 400 | 800 |
| Parameterisation | | | CODESYS V2.3 | CODESYS V3 |
| Configuration support | | | CODESYS V2.3 | CODESYS V3 |
| Additional functions | | | Diagnostic functions | |
| | | | RS232 communication function | |
| Program memory, user program | | [MB] | 4 | 16 |
| Flags | | | CODESYS variable concept | |
| | Remanent data | [kB] | 30 | 28 |
| | Global data memory | [MB] | 8 | – |
| Control elements | | | Rotary switch for RUN/STOP | |
| Ethernet | Number | | 1 | |
| | Connection technology | | RJ45 socket, 8-pin | |
| | Data transmission speed | [Mbps] | 10/100 | |
| | Supported protocols | | TCP/IP, EasyIP, Modbus TCP | |
| Data interface | Number | | 1 | |
| | Connection technology | | Sub-D socket, 9-pin | |
| | Data transmission speed | [kbps] | 9.6 ... 230.4 | |
| | Supported protocols | | RS232 interface | |
| | Max. cable length | [m] | – | 30 |
| | Galvanic isolation | | Yes | |

Terminal CPX

Technical data – Control block CPX-CEC

Connection and display components CPX-CEC-C1/-M1

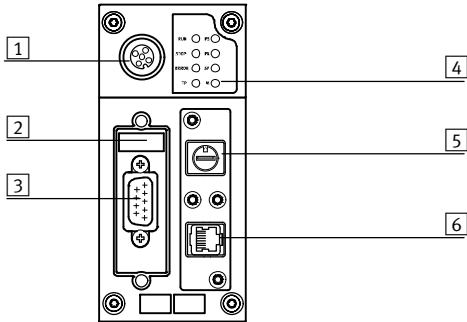

- 1 CPX-MMI connection
- 2 DIL switch
- 3 Fieldbus interface
(Sub-D plug connector, 9-pin)
- 4 Status LEDs, bus-specific and product-specific
- 5 RUN/STOP rotary switch
- 6 Ethernet interface (RJ45 socket, 8-pin)

Pin allocation – CPX-CEC-C1/-M1

| | Pin | Signal | Meaning |
|---|-----------|-----------|--|
| Fieldbus interface, Sub-D plug connector | | | |
| | 1 | n.c. | Not connected |
| | 2 | CAN_L | CAN low |
| | 3 | CAN_GND | CAN ground |
| | 4 | n.c. | Not connected |
| | 5 | CAN_SHLD | Connection to functional earth FE |
| | 6 | CAN_GND | CAN ground (optional) ¹⁾ |
| | 7 | CAN_H | CAN high |
| | 8 | n.c. | Not connected |
| | 9 | n.c. | Not connected |
| | Housing | Screening | Plug connector housing must be connected to FE |
| Ethernet interface, RJ45 plug connector | | | |
| | 1 | TD+ | Transmitted data+ |
| | 2 | TD- | Transmitted data- |
| | 3 | RD+ | Received data+ |
| | 4 | n.c. | Not connected |
| | 5 | n.c. | Not connected |
| | 6 | RD- | Received data- |
| | 7 | n.c. | Not connected |
| | 8 | n.c. | Not connected |
| Housing | Screening | Screening | |

1) If a drive controller with external power supply is connected, CAN ground (optional), pin 6, on the CPX-CEC-C1/-M1 must not be used.

Terminal CPX

Technical data – Control block CPX-CEC

Connection and display components CPX-CEC/CPX-CEC-S1-V3

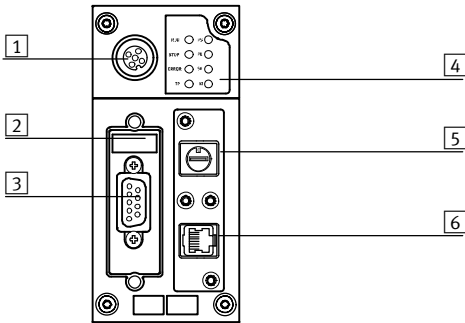







- 1 CPX-MMI connection
- 2 DIL switch
- 3 RS232 interface
(Sub-D socket, 9-pin)
- 4 Status LEDs, bus-specific and product-specific
- 5 RUN/STOP rotary switch
- 6 Ethernet interface (RJ45 socket, 8-pin)

Pin allocation – CPX-CEC/CPX-CEC-S1-V3

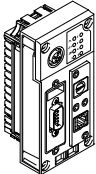
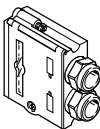
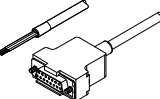
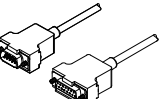
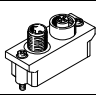
| | Pin | Signal | Meaning |
|--|-----------|-----------|--------------------------------|
| Fieldbus interface, Sub-D socket | | | |
| | 1 | n.c. | Not connected |
| | 2 | RXD | Received data |
| | 3 | TXD | Transmitted data |
| | 4 | n.c. | Not connected |
| | 5 | GND | Data reference potential |
| | 6 | n.c. | Not connected |
| | 7 | n.c. | Not connected |
| | 8 | n.c. | Not connected |
| | 9 | n.c. | Not connected |
| | Screening | Screening | Connection to functional earth |
| Ethernet interface, RJ45 plug connector | | | |
| | 1 | TD+ | Transmitted data+ |
| | 2 | TD- | Transmitted data- |
| | 3 | RD+ | Received data+ |
| | 4 | n.c. | Not connected |
| | 5 | n.c. | Not connected |
| | 6 | RD- | Received data- |
| | 7 | n.c. | Not connected |
| | 8 | n.c. | Not connected |
| Housing | Screening | Screening | |

Terminal CPX

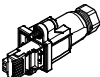
Accessories – Control block CPX-FEC

| Ordering data | | | | |
|---|--|--------------|---------------|------------------------------|
| Designation | Parameterisation | Weight [g] | Part No. | Type |
| Control block | | | | |
|  | Motion functions for electric drives | CODESYS V2.3 | 155 | 567347 CPX-CEC-C1 |
| | | CODESYS V3 | 135 | 3473128 CPX-CEC-C1-V3 |
| | SoftMotion functions for electric drives | CODESYS V3 | 135 | 3472765 CPX-CEC-M1-V3 |
| | RS232 communication function | CODESYS V2.3 | 155 | 567346 CPX-CEC |
| | | CODESYS V3 | 135 | 3472425 CPX-CEC-S1-V3 |
| Fieldbus interface | | | | |
|  | Sub-D plug connector, 9-pin, for CANopen | | 532219 | FBS-SUB-9-BU-2x5POL-B |
|  | Connecting cable FED | | 539642 | FEC-KBG7 |
|  | Connecting cable FED | | 539643 | FEC-KBG8 |
|  | Micro Style bus connection, 2xM12 for DeviceNet/CANopen | | 525632 | FBA-2-M12-5POL |
|  | Socket for Micro Style connection, M12 | | 18324 | FBSD-GD-9-5POL |
|  | Plug connector for Micro Style connection, M12 | | 175380 | FBS-M12-5GS-PG9 |
|  | Open Style bus connection for 5-pin terminal strip for DeviceNet/CANopen | | 525634 | FBA-1-SL-5POL |
|  | Terminal strip for Open Style connection, 5-pin | | 525635 | FBSD-KL-2x5POL |
| Ethernet interface | | | | |
|  | RJ45 plug connector | | 534494 | FBS-RJ45-8-GS |
|  | Cover for RJ45 connection | | 534496 | AK-Rj45 |

Terminal CPX

Accessories – Control block CPX-FEC

FESTO

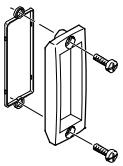
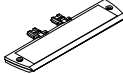
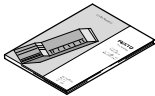
| Ordering data | | | | |
|---|---|---------------|----------------------|------------------------|
| Designation | | Part No. | Type | |
| Covers and attachments | | | | |
|  | Inspection cover, transparent, for Sub-D connection | 533334 | AK-SUB-9/15-B | |
|  | Inscription label holder for manifold block | 536593 | CPX-ST-1 | |
| User documentation | | | | |
|  | Manual for control block CPX-CEC | German | 569121 | P.BE-CPX-CEC-DE |
| | | English | 569122 | P.BE-CPX-CEC-EN |

Terminal CPX

Technical data – Bus node CPX-FB6



Bus node for handling communication between the electrical CPX terminal and a higher-order master via INTERBUS.

The bus node is provided with system supply via the interlinking block and processes communication with the I/O modules.

The status of the CPX terminal is displayed as a common message via four CPX-specific LEDs.

The fieldbus communication status is displayed via four INTERBUS-specific LEDs.



Application

Bus connection

The bus connection is established via a 9-pin Sub-D socket and a 9-pin Sub-D plug with a typical INTERBUS pin allocation.

The bus connector plugs (with IP65/IP67 protection from Festo or IP20 protection from other manufacturers) facilitate the connection of the incoming and outgoing bus cable.

The outgoing bus plug contains the typical INTERBUS RBST bridge for identification of the outgoing bus connection.

The Sub-D interfaces are designed for controlling network components with a fibre-optic cable connection.

INTERBUS implementation

The CPX-FB6 supports the INTERBUS protocol to EN 50254.

In addition to synchronous I/O exchange, the optional PCP channel can be used for parameterisation and diagnostic functions.

The PCP channel provides access to advanced system information and assigns operation parameters while the controller is running via the user program.

An example of this is access to the integrated diagnostic memory function, i.e. storage of the last 40 errors with timestamp, module, channel and error type.

With its address capacity of 96 inputs and 96 outputs, the CPX-FB6 supports a large number of I/O module configurations, including pneumatic interface.

 Note
If the PCP channel is used, the maximum number of possible process data bits is reduced by 16.

Special points in combination with CPX-FEC/CPX-CEC

When a bus node is combined with a control block (CPX-FEX, CPX-CEC, in the fieldbus remote controller operating mode), the connected I/Os and/or valves, sensors and actuators are controlled via the CPX control

block.
In this case, the bus node only provides the communication interface to the PLC.
Communication between the control block and CPX bus node is established

via the interlinking of the CPX modules and occupies an address capacity of the CPX system of:

- 8 byte outputs
- 8 byte inputs

The remaining address capacity of the control block or CPX system for actuating the peripherals is:

- 56 byte inputs
- 56 byte outputs

Terminal CPX

Technical data – Bus node CPX-FB6

FESTO

| General technical data | | | |
|---|-------------------------|---|---------------------------------|
| Type | | CPX-FB6 | |
| Fieldbus interface | | Sub-D, 9-pin, socket and pin | |
| Baud rate | [Mbit/s] | 0.5 and 2 | |
| Bus type | | Remote bus | |
| Ident. code | | 1, 2 or 3 (configuration-specific) 243 (PCP-channel activated) | |
| Profile | | 12 (I/O device) | |
| PCP channel | | Yes, 16 bit (optional via DIL switch) | |
| Configuration support | | Icons for CMD software | |
| Max. no. of process data bits | Inputs | [bit] | 96 |
| | Outputs | [bit] | 96 |
| LED displays (bus-specific) | | UL = Operating voltage for INTERBUS interface RC = Remotebus check BA = Bus active RD = Remotebus disable TR = Transmit/receive | |
| Device-specific diagnostics | | Via peripherals error | |
| Parameterisation | | <ul style="list-style-type: none"> Start-up parameterisation via user functions (CMD) Via PCP communication | |
| Additional functions | | <ul style="list-style-type: none"> Storage of the last 40 errors with timestamp (access via PCP) 8-bit system status in image table for inputs 2-byte inputs and 2-byte outputs, system diagnostics in image table | |
| Control elements | | DIL switch | |
| Operating voltage | Nominal value | [V DC] | 24 (reverse polarity protected) |
| | Permissible range | [V DC] | 18 ... 30 |
| | Power failure buffering | [ms] | 10 |
| Current consumption | | [mA] | Typically 200 |
| Protection class to EN 60529 | | IP65, IP67 | |
| Temperature range | Operation | [°C] | -5 ... +50 |
| | Storage/transport | [°C] | -20 ... +70 |
| Materials | | PA-reinforced PC | |
| Grid dimension | | [mm] | 50 |
| Dimensions (incl. interlinking block) W x L x H | | [mm] | 50 x 107 x 50 |
| Weight | | [g] | 125 |

 Note

Please observe the general limits and guidelines for the system when configuring the electrical modules.

Terminal CPX

Technical data – Bus node CPX-FB6

Connection and display components

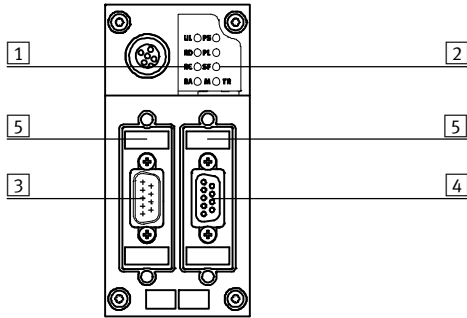

- 1 INTERBUS-specific LEDs
- 2 CPX-specific status LEDs
- 3 Fieldbus connection, incoming (9-pin Sub-D plug)
- 4 Fieldbus connection, outgoing (9-pin Sub-D socket)
- 5 DIL switch

Pin allocation for the INTERBUS interface

| Pin allocation for Sub-D | Pin | Signal | Designation | Pin | Pin allocation for M12 |
|--------------------------|---------|----------|---|---------|------------------------|
| Incoming | | | | | |
| | 1 | DO1 | Data out | 1 | |
| | 2 | DI1 | Data in | 3 | |
| | 3 | GND | Reference conductor/ground | 5 | |
| | 4 | n.c. | Not connected | 2 | |
| | 5 | n.c. | Not connected | 4 | |
| | 6 | /DO1 | Data out inverse | | |
| | 7 | /DI1 | Data in inverse | | |
| | 8 | n.c. | Not connected | | |
| | 9 | n.c. | Not connected | | |
| | Housing | Screened | Connection to FE (functional earth) via R/C combination | Housing | |
| Outgoing | | | | | |
| | 1 | DO2 | Data out | 1 | |
| | 2 | DI2 | Data in | 3 | |
| | 3 | GND | Reference conductor/ground | 5 | |
| | 4 | n.c. | Not connected | 2 | |
| | 5 | +5 V | Station detection ¹⁾ | 4 | |
| | 6 | /DO2 | Data out inverse | | |
| | 7 | /DI2 | Data in inverse | | |
| | 8 | n.c. | Not connected | | |
| | 9 | RBST | Station detection ¹⁾ | | |
| | Housing | Screened | Connection to FE (functional earth) | Housing | |





The incoming interface is galvanically isolated from the CPX peripherals. The plug housing is connected to the functional earth FE of the CPX terminal via an R/C combination.

1) The CPX terminal contains the protocol chip SUPI 3 OPC. This ensures automatic detection of additional connected INTERBUS stations. There is therefore no need for a bridge between pin 5 and pin 9.

Terminal CPX

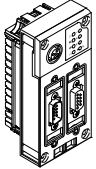
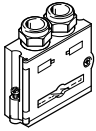
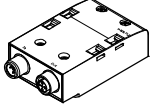
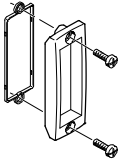
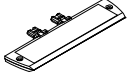
Accessories – Bus node CPX-FB6

FESTO

| Ordering data | | | | |
|---|---|----------|---------------|---------------------------|
| Designation | | | Part No. | Type |
| Bus node | | | | |
|  | INTERBUS bus node | | 195748 | CPX-FB6 |
| Bus connection | | | | |
|  | Sub-D plug | Incoming | 532218 | FBS-SUB-9-BU-IB-B |
| | | Outgoing | 532217 | FBS-SUB-9-GS-IB-B |
|  | Connection block M12 adapter (B-coded) | | 534505 | CPX-AB-2-M12-RK-IB |
|  | Inspection cover, transparent | | 533334 | AK-SUB-9/15-B |
|  | Inscription label holder for connection block | | 536593 | CPX-ST-1 |
|  | Threaded sleeve, 4 pieces | | 533000 | UNC4-40/M3x6 |
|  | Adapter from 5-pin M12 to mini USB socket and controller software | | 547432 | NEFC-M12G5-03-U1G5 |
| User manual | | | | |
|  | User manual for bus node CPX-FB6 | German | 526433 | P.BE-CPX-FB6-DE |
| | | English | 526434 | P.BE-CPX-FB6-EN |
| | | Spanish | 526435 | P.BE-CPX-FB6-ES |
| | | French | 526436 | P.BE-CPX-FB6-FR |
| | | Italian | 526437 | P.BE-CPX-FB6-IT |

Terminal CPX

Technical data – Bus node CPX-FB11



Bus node for handling communication between the electrical CPX terminal and a DeviceNet network.

The bus node is provided with system supply via the interlinking block and processes communication with the I/O modules.

The status of the CPX terminal is displayed as a common message via four CPX-specific LEDs.

The fieldbus communication status is displayed via the three DeviceNet-specific LEDs.



Application

Bus connection

The bus connection can be selected when ordering, either Micro Style as 2xM12 round connectors or OpenStyle as a terminal strip with IP20 protection.

Both connection types have the function of an integrated T-distributor with incoming and outgoing bus line.

DeviceNet implementation

The CPX-FB11 operates with the “Predefined Master/Slave Connection Set” as a “Group 2 Only Server”. The polled I/O, change of state or synchronous method is used for the transmission of synchronous I/O data. The type of transmission can be selected in the network configuration.

The device diagnostics for all bus nodes CPX-FB11 is effectively gathered via strobed I/O and displayed in the input table of the controller. In addition to synchronous data transmission, asynchronous communication is supported through explicit messaging, which enables detailed device diagnostics and parameterisation.

A comprehensive EDS file supports the display of asynchronous data. It is also possible to display system information and assign parameters while the controller is running via the user program or the configuration software.

An example of this is access to the integrated diagnostic memory function, i.e. storage of the last 40 errors with timestamp, module, channel and error type. With its address capacity of 64 byte inputs and 64 byte outputs, the CPX-FB11 supports any configuration of I/O modules, including pneumatic interface.

Special points in combination with CPX-FEC/CPX-CEC

When a bus node is combined with a control block (CPX-FEX, CPX-CEC, in the fieldbus remote controller operating mode), the connected I/Os and/or valves, sensors and actuators are controlled via the CPX control

block. In this case, the bus node only provides the communication interface to the PLC. Communication between the control block and CPX bus node is established

via the interlinking of the CPX modules and occupies an address capacity of the CPX system of:

- 8 byte outputs
- 8 byte inputs

The remaining address capacity of the control block or CPX system for actuating the peripherals is:

- 56 byte inputs
- 56 byte outputs

Terminal CPX

Technical data – Bus node CPX-FB11

| General technical data | | | |
|---|-------------------------|---|---------------|
| Type | | CPX-FB11 | |
| Fieldbus interface | | Either <ul style="list-style-type: none"> • Micro Style bus connection: 2xM12 with IP65, IP67 protection • Open Style bus connection: 5-pin terminal strip, IP20 | |
| Baud rate | [kbps] | 125, 250, 500 | |
| Addressing range | | 0 ... 63 Set using DIL switch | |
| Product | Type | Communication adapter (12 dec.) | |
| | Code | 4554 dec. | |
| Communication types | | Polled I/O, change of state/synchronous, strobed I/O and explicit messaging | |
| Configuration support | | EDS file and bitmaps | |
| Max. address capacity | Inputs | [byte] | 64 |
| | Outputs | [byte] | 64 |
| LED displays (bus-specific) | | MS = Module status NS = Network status IO = I/O status | |
| Device-specific diagnostics | | Module and channel-oriented diagnostics by means of manufacturer-specific diagnostic object | |
| Parameterisation | | <ul style="list-style-type: none"> • Module and system parameterisation via configuration interface in plain text (EDS) • Online in run or program mode | |
| Additional functions | | <ul style="list-style-type: none"> • Storage of the last 40 errors with timestamp (access via EDS) • 8-bit system status in image table for inputs • 2-byte inputs and 2-byte outputs, system diagnostics in image table | |
| Control elements | | DIL switch | |
| Operating voltage | Nominal value | [V DC] | 24 |
| | Permissible range | [V DC] | 18 ... 30 |
| | Power failure buffering | [ms] | 10 |
| Current consumption | | [mA] | Typically 200 |
| Protection class to EN 60529 | | IP65, IP67 | |
| Temperature range | Operation | [°C] | -5 ... +50 |
| | Storage/transport | [°C] | -20 ... +70 |
| Materials | | PA-reinforced PC | |
| Grid dimension | | [mm] | 50 |
| Dimensions (incl. interlinking block) W x L x H | | [mm] | 50 x 107 x 50 |
| Weight | | [g] | 120 |

 Note
Please observe the general limits and guidelines for the system when configuring the electrical modules.

Terminal CPX

Technical data – Bus node CPX-FB11

Connection and display components

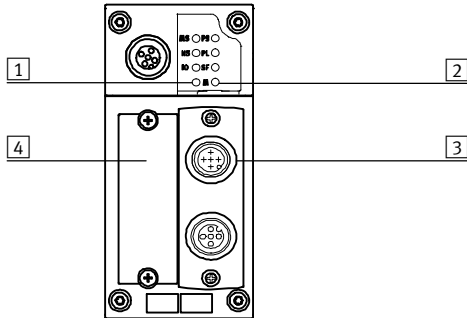

- 1 Bus-specific LEDs
- 2 CPX-specific status LEDs
- 3 Selectable fieldbus connection
Micro Style
Open Style
- 4 DIL switch cover









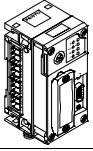
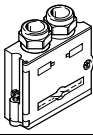

Pin allocation for the DeviceNet interface

| Pin allocation | Pin | Signal-specific core colour ¹⁾ | Signal | Designation |
|--|-----|---|-------------|----------------------------------|
| Sub-D plug | | | | |
| | 1 | – | n.c. | Not connected |
| | 2 | Blue | CAN_L | Received/transmitted data low |
| | 3 | Black | 0 V bus | 0 V CAN interface |
| | 4 | – | n.c. | Not connected |
| | 5 | Blank | Screened | Connection to housing |
| | 6 | – | n.c. | Not connected |
| | 7 | White | CAN_H | Received/transmitted data high |
| | 8 | – | n.c. | Not connected |
| | 9 | Red | 24 V DC bus | 24 V DC supply for CAN interface |
| Micro Style bus connection (M12), incoming/outgoing | | | | |
| Incoming | 1 | Blank | Screened | Connection to housing |
| | 2 | Red | 24 V DC bus | 24 V DC supply for CAN interface |
| | 3 | Black | 0 V bus | 0 V CAN interface |
| | 4 | White | CAN_H | Received/transmitted data high |
| | 5 | Blue | CAN_L | Received/transmitted data low |
| Outgoing | 1 | Blank | Screened | Connection to housing |
| | 2 | Red | 24 V DC bus | 24 V DC supply for CAN interface |
| | 3 | Black | 0 V bus | 0 V CAN interface |
| | 4 | White | CAN_H | Received/transmitted data high |
| | 5 | Blue | CAN_L | Received/transmitted data low |
| Open Style bus connection | | | | |
| | 1 | Black | 0 V bus | 0 V CAN interface |
| | 2 | Blue | CAN_L | Received/transmitted data low |
| | 3 | Blank | Screened | Connection to housing |
| | 4 | White | CAN_H | Received/transmitted data high |
| | 5 | Red | 24 V DC bus | 24 V DC supply for CAN interface |
| Bus connection 7/8" | | | | |
| | 1 | Black | Screened | Connection to housing |
| | 2 | Blue | 24 V DC | 24 V DC supply for CAN interface |
| | 3 | Blank | 0 V | 0 V CAN interface |
| | 4 | White | CAN_H | Received/transmitted data high |
| | 5 | Red | CAN_L | Received/transmitted data low |

1) Typical for DeviceNet connecting cables

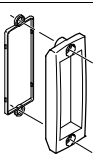
Terminal CPX

Accessories – Bus node CPX-FB11

| Ordering data | | | |
|---|---|----------|-------------------------|
| Designation | | Part No. | Type |
| Bus node | | | |
|  | DeviceNet bus node | 526172 | CPX-FB11 |
| Bus connection | | | |
|  | Sub-D plug | 532219 | FBS-SUB-9-BU-2x5POL-B |
|  | Connection block, socket Sub-D 9-pin, plug 7/8", 5-pin | 571052 | CPX-AB-1-7/8-DN |
|  | Micro Style bus connection, 2xM12 | 525632 | FBA-2-M12-5POL |
|  | Socket for MicroStyle connection, M12 | 18324 | FBSD-GD-9-5POL |
| | Plug for Micro Style connection, M12 | 175380 | FBS-M12-5GS-PG9 |
|  | Open Style bus connection for 5-pin terminal strip | 525634 | FBA-1-SL-5POL |
|  | Terminal strip for Open Style connection, 5-pin | 525635 | FBSD-KL-2x5POL |
|  | Inspection cover, transparent | 533334 | AK-SUB-9/15-B |
|  | Inscription label holder for connection block | 536593 | CPX-ST-1 |
|  | Adapter from 5-pin M12 to mini USB socket and controller software | 547432 | NEFC-M12G5-03-U1G5 |
| User manual | | | |
|  | User manual for bus node CPX-FB11 | German | 526421 P.BE-CPX-FB11-DE |
| | | English | 526422 P.BE-CPX-FB11-EN |
| | | Spanish | 526423 P.BE-CPX-FB11-ES |
| | | French | 526424 P.BE-CPX-FB11-FR |
| | | Italian | 526425 P.BE-CPX-FB11-IT |

Terminal CPX

Technical data – Bus node CPX-FB13



Bus node for handling communication between the electrical CPX terminal and a higher-order master via PROFIBUS DP.

The bus node is provided with system supply via the interlinking block and processes communication with the I/O modules.

The status of the CPX terminal is displayed as a common message via four CPX-specific LEDs.

The fieldbus communication status is displayed via the PROFIBUS-specific error LED.



Application

Bus connection

The bus connection is established via a 9-pin Sub-D socket with a typical PROFIBUS allocation (to EN 50170).

The bus connector plug (with IP65/IP67 protection from Festo or IP20 protection from other manufacturers) facilitates the connection of an incoming and an outgoing bus cable.

An active bus terminal can be connected using the DIL switch integrated in the plug.

The Sub-D interface is designed for controlling network components with a fibre-optic cable connection.

PROFIBUS DP implementation

The CPX-FB13 supports the PROFIBUS DP protocol to EN 50170 Volume 2 for synchronous I/O exchange, parameterisation and diagnostic functions (DPV0).

In addition to DPV0, asynchronous communication to the advanced specification DPV1 is supported. DPV1 provides asynchronous access to advanced system information and assigns operation parameters while the controller is running via the user program.

An example of this is access to the integrated diagnostic memory function, i.e. storage of the last 40 errors with timestamp, module, channel and error type.

With its address capacity of 64 byte inputs and 64 byte outputs, the CPX-FB13 supports any configuration of I/O modules, including pneumatic interface.

Special points in combination with CPX-FEC/CPX-CEC

When a bus node is combined with a control block (CPX-FEX, CPX-CEC, in the fieldbus remote controller operating mode), the connected I/Os and/or valves, sensors and actuators are controlled via the CPX control

block. In this case, the bus node only provides the communication interface to the PLC. Communication between the control block and CPX bus node is established

via the interlinking of the CPX modules and occupies an address capacity of the CPX system of:

- 8 byte outputs
- 8 byte inputs

The remaining address capacity of the control block or CPX system for actuating the peripherals is:

- 56 byte inputs
- 56 byte outputs

Terminal CPX

Technical data – Bus node CPX-FB13

| General technical data | | | |
|---|-------------------------|--|---------------|
| Type | | CPX-FB13 | |
| Fieldbus interface | | Sub-D socket, 9-pin (EN 50 170) Galvanically isolated 5 V | |
| Baud rate | [Mbit/s] | 0.0096 ... 12 | |
| Addressing range | | 1 ... 125 Set using DIL switch | |
| Product range | | 4: Valves | |
| Ident. number | | 0x059E | |
| Communication types | | DPV0: Synchronous communication DPV1: Asynchronous communication | |
| Configuration support | | GSD file and bitmaps | |
| Max. address capacity | Inputs | [byte] | 64 |
| | Outputs | [byte] | 64 |
| LED displays (bus-specific) | | BF: Bus fault | |
| Device-specific diagnostics | | Identifier and channel-oriented diagnostics to EN 50170 (PROFIBUS standard) | |
| Parameterisation | | <ul style="list-style-type: none"> Start-up parameterisation via configuration interface in plain text (GSD) Asynchronous parameterisation via DPV1 | |
| Additional functions | | <ul style="list-style-type: none"> Storage of the last 40 errors with timestamp (access via DPV1) 8-bit system status in image table for inputs 2-byte inputs and 2-byte outputs, system diagnostics in image table | |
| Control elements | | DIL switch | |
| Operating voltage | Nominal value | [V DC] | 24 |
| | Permissible range | [V DC] | 18 ... 30 |
| | Power failure buffering | [ms] | 10 |
| Current consumption | | [mA] | Typically 200 |
| Protection class to EN 60529 | | IP65, IP67 | |
| Temperature range | Operation | [°C] | -5 ... +50 |
| | Storage/transport | [°C] | -20 ... +70 |
| Materials | | PA-reinforced PC | |
| Grid dimension | | [mm] | 50 |
| Dimensions (incl. interlinking block) W x L x H | | [mm] | 50 x 107 x 50 |
| Weight | | [g] | 115 |

 - Note
Please observe the general limits and guidelines for the system when configuring the electrical modules.

Terminal CPX

Technical data – Bus node CPX-FB13

Connection and display components

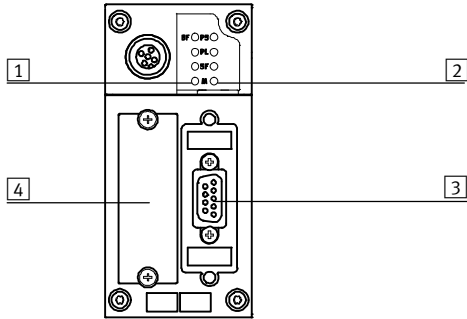

- 1 Bus status LEDs/bus fault
- 2 CPX-specific status LEDs
- 3 Fieldbus connection (9-pin Sub-D socket)
- 4 DIL switch cover

Pin allocation for PROFIBUS DP interface





| Pin allocation | Pin | Signal | Designation |
|---|-----------|----------------------|-------------------------------------|
| Sub-D socket | | | |
| | 1 | n.c. | Not connected |
| | 2 | n.c. | Not connected |
| | 3 | RxD/TxD-P | Received/transmitted data P |
| | 4 | CNTR-P ¹⁾ | Repeater control signal |
| | 5 | DGND | Data reference potential (M5V) |
| | 6 | VP | Supply voltage (P5V) |
| | 7 | n.c. | Not connected |
| | 8 | RxD/TxD-N | Received/transmitted data N |
| | 9 | n.c. | Not connected |
| | Housing | Screened | Connection to housing |
| Bus connection M12 adapter (B-coded) | | | |
| Incoming | | | |
| | 1 | n.c. | Not connected |
| | 2 | RxD/TxD-N | Received/transmitted data N |
| | 3 | n.c. | Not connected |
| | 4 | RxD/TxD-P | Received/transmitted data P |
| | 5 and M12 | Screened | Connection to FE (functional earth) |
| Outgoing | | | |
| | 1 | VP | Supply voltage (P5V) |
| | 2 | RxD/TxD-N | Received/transmitted data N |
| | 3 | DGND | Data reference potential (M5V) |
| | 4 | RxD/TxD-P | Received/transmitted data P |
| | 5 and M12 | Screened | Connection to FE (functional earth) |

1) The repeater control signal CNTR-P is realised as a TTL signal.

Terminal CPX

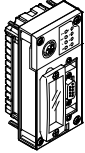
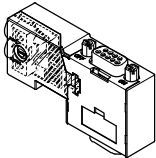

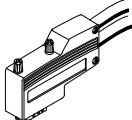
Accessories – Bus node CPX-FB13

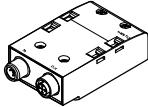
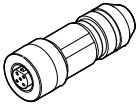
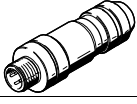
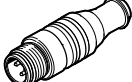
FESTO

| Ordering data | | | |
|---|--|----------|----------------------|
| Designation | | Part No. | Type |
| Bus node | | | |
|  | PROFIBUS bus node | 195740 | CPX-FB13 |
| Bus connection | | | |
|  | Sub-D straight plug connector with terminating resistor and programming interface | 574589 | NECU-S1W9-C2-APB |
|  | Sub-D plug, straight | 532216 | FBS-SUB-9-GS-DP-B |
|  | Sub-D plug, angled | 533780 | FBS-SUB-9-WS-PB-K |
|  | Bus connection M12 adapter (B-coded) | 533118 | FBA-2-M12-5POL-RK |
|  | Connection block M12 adapter (B-coded) | 541519 | CPX-AB-2-M12-RK-DP |
|  | Socket M12x1, 5-pin, straight, for self-assembly of a connecting cable for FBA-2-M12-5POL-RK and CPX-AB-2-M12-RK-DP | 1067905 | NECU-M-B12G5-C2-PB |
|  | Plug M12x1, 5-pin, straight, for self-assembly of a connecting cable for FBA-2-M12-5POL-RK and CPX-AB-2-M12-RK-DP | 1066354 | NECU-M-S-B12G5-C2-PB |
|  | Terminating resistor, M12, B-coded for PROFIBUS | 1072128 | CACR-S-B12G5-220-PB |

Terminal CPX

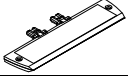
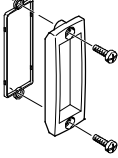
Accessories – Bus node CPX-FB13

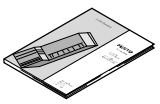
| Ordering data | | | |
|---|---|----------|-------------------------|
| Designation | | Part No. | Type |
| Bus connection | | | |
|  | Inscription label holder for connection block M12 | 536593 | CPX-ST-1 |
|  | Inspection cover, transparent | 533334 | AK-SUB-9/15-B |
|  | Adapter from 5-pin M12 to mini USB socket and controller software | 547432 | NEFC-M12G5-03-U1G5 |
| User manual | | | |
|  | User manual for bus node CPX-FB13 | German | 526427 P.BE-CPX-FB13-DE |
| | | English | 526428 P.BE-CPX-FB13-EN |
| | | Spanish | 526429 P.BE-CPX-FB13-ES |
| | | French | 526430 P.BE-CPX-FB13-FR |
| | | Italian | 526431 P.BE-CPX-FB13-IT |

Terminal CPX

Technical data – Bus node CPX-FB14



Bus node for handling communication between the electrical CPX terminal and a CANopen network master or CANopen network.

The bus node is provided with system supply via the interlinking block and processes communication with the I/O modules.

The status of the CPX terminal is displayed as a common message via four CPX-specific LEDs.

The different CANopen statuses and the fieldbus communication status are displayed via three additional LEDs.



Application

Bus connection

The bus connection is established via a 9-pin Sub-D plug (pin) as per the CAN in Automation (CiA) specification DS 102 with additional 24 V CAN transceiver supply (option as per DS 102).

The bus connector plug (with IP65/IP67 protection from Festo or IP20 protection from other manufacturers) facilitates the connection of an incoming and an outgoing bus cable.

There are four contacts available for the four wires (CAN_L, CAN_H, 24 V, 0 V) of the incoming and outgoing bus cables.

CANopen implementation

The CPX-FB14 supports the CANopen protocol in accordance with the specifications DS 301 V4.01 and DS 401 V2.0. Implementation is based on the CiA Pre-defined Connection Set. There are four PDOs available for fast I/O data exchange.

Advanced system information can also be accessed by means of SDO communication. SDO communication also facilitates parameterisation before network startup or while the controller is running via the user program. An example of this is access to the integrated diagnostic memory function, i.e. storage of the last 40 errors with timestamp, module, channel and error type.

With its address capacity, the CPX-FB14 supports a large number of I/O module configurations, including pneumatic interface. By default, 8 byte digital inputs and 8 byte digital outputs can be addressed via PDO 1.

8 analogue input channels and 8 analogue output channels can be addressed via PDO 2 and 3. Status and diagnostic information can be evaluated via PDO 4. Additional 8 byte digital inputs and outputs as well as 8 analogue input and output channels can be addressed via mapping.

Special points in combination with CPX-FEC/CPX-CEC

When a bus node is combined with a control block (CPX-FEX, CPX-CEC, in the fieldbus remote controller operating mode), the connected I/Os and/or valves, sensors and actuators are controlled via the CPX control

block. In this case, the bus node only provides the communication interface to the PLC. Communication between the control block and CPX bus node is established

via the interlinking of the CPX modules and occupies an address capacity of the CPX system of:

- 8 byte outputs
- 8 byte inputs

The remaining address capacity of the control block or CPX system for actuating the peripherals is:

- 56 byte inputs
- 56 byte outputs

Terminal CPX

Technical data – Bus node CPX-FB14

| General technical data | | | |
|---|-------------------------|--|----------------------------------|
| Type | | CPX-FB14 | |
| Fieldbus interface | | Sub-D pin, 9-pin (to DS 102) Bus interface galvanically isolated via optocoupler 24 V supply for CAN interface via bus | |
| Baud rate | [kbit/s] | 125; 250; 500 and 1,000 can be set via DIL switch | |
| Addressing range | | Node ID 1 ... 127 Set using DIL switch | |
| Product range | | Digital inputs and outputs | |
| Communication profile | | DS 301, V4.01 | |
| Device profile | | DS 401, V2.0 | |
| Number | PDO | 4 Tx/4 Rx | |
| | SDO | 1 server SDO | |
| Configuration support | | EDS file and bitmaps | |
| Max. address capacity | Inputs | [byte] | 16 digital, 16 analogue channels |
| | Outputs | [byte] | 16 digital, 16 analogue channels |
| LED displays (bus-specific) | | MS = Module status NS = Network status IO = I/O status | |
| Device-specific diagnostics | | Via emergency message Object 1001, 1002 and 1003 | |
| Parameterisation | | Via SDO | |
| Additional functions | | <ul style="list-style-type: none"> • Storage of the last 40 errors with timestamp (access via SDO) • 8-bit system status via transmit PDO 4 (default) • 2-byte inputs and 2-byte outputs, system diagnostics via PDO 4 • Minimum boot-up • Variable PDO mapping • Emergency message • Node guarding • Heart beat | |
| Control elements | | DIL switch | |
| Operating voltage | Nominal value | [V DC] | 24 |
| | Permissible range | [V DC] | 18 ... 30 |
| | Power failure buffering | [ms] | 10 |
| Current consumption | [mA] | Typically 200 | |
| Protection class to EN 60529 | | IP65, IP67 | |
| Temperature range | Operation | [°C] | -5 ... +50 |
| | Storage/transport | [°C] | -20 ... +70 |
| Materials | | PA-reinforced PC | |
| Grid dimension | | [mm] | 50 |
| Dimensions (incl. interlinking block) W x L x H | | [mm] | 50 x 107 x 50 |
| Weight | | [g] | 115 |

 Note

Please observe the general limits and guidelines for the system when configuring the electrical modules.

Terminal CPX

Technical data – Bus node CPX-FB14

Connection and display components

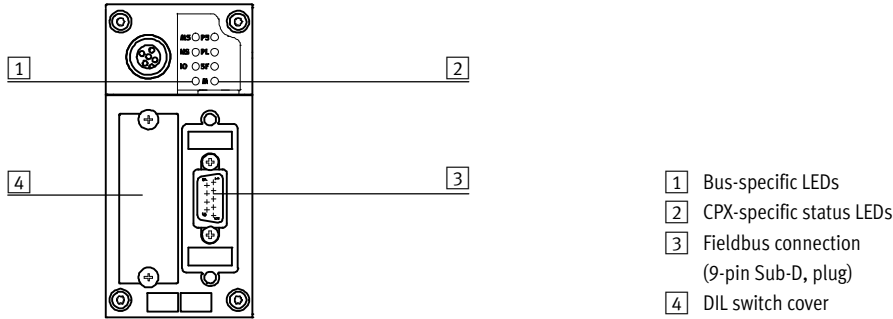





| Pin allocation for the CANopen interface | | | |
|--|---------|----------|-------------------------------------|
| Pin allocation | Pin | Signal | Designation |
| Sub-D plug | | | |
| | 1 | n.c. | Not connected |
| | 2 | CAN_L | Received/transmitted data low |
| | 3 | CAN_GND | 0 V CAN interface |
| | 4 | n.c. | Not connected |
| | 5 | CAN_Shld | Optional screened connection |
| | 6 | GND | Ground ¹⁾ |
| | 7 | CAN_H | Received/transmitted data high |
| | 8 | n.c. | Not connected |
| | 9 | CAN_V+ | 24 V DC supply for CAN interface |
| | Housing | Screened | |
| Micro Style bus connection (M12) | | | |
| Incoming | | | |
| | 1 | Screened | Connection to FE (functional earth) |
| | 2 | CAN_V+ | 24 V DC supply for CAN interface |
| | 3 | CAN_GND | 0 V CAN interface |
| | 4 | CAN_H | Received/transmitted data high |
| | 5 | CAN_L | Received/transmitted data low |
| Outgoing | | | |
| | 1 | Screened | Connection to FE (functional earth) |
| | 2 | CAN_V+ | 24 V DC supply for CAN interface |
| | 3 | CAN_GND | 0 V CAN interface |
| | 4 | CAN_H | Received/transmitted data high |
| | 5 | CAN_L | Received/transmitted data low |
| Open Style bus connection | | | |
| | 1 | CAN_GND | 0 V CAN interface |
| | 2 | CAN_L | Received/transmitted data low |
| | 3 | Screened | Connection to FE (functional earth) |
| | 4 | CAN_H | Received/transmitted data high |
| | 5 | CAN_V+ | 24 V DC supply for CAN interface |

1) Connected internally via Pin 3

Terminal CPX

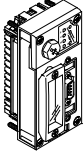
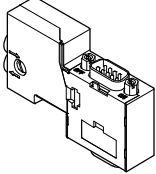
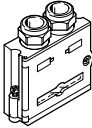
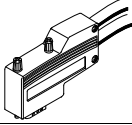
Accessories – Bus node CPX-FB14

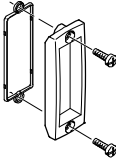
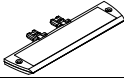
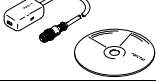
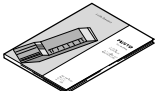

| Ordering data | | | |
|---|--|----------|-------------------------|
| Designation | | Part No. | Type |
| Bus node | | | |
|  | CANopen bus node | 526174 | CPX-FB14 |
| Bus connection | | | |
|  | Sub-D socket for CANopen with terminating resistor and programming interface | 574588 | NECU-S1W9-C2-ACO |
|  | Sub-D plug | 532219 | FBS-SUB-9-BU-2x5POL-B |
|  | Sub-D plug, angled | 533783 | FBS-SUB-9-WS-CO-K |
|  | Micro Style bus connection, 2xM12, 5-pin | 525632 | FBA-2-M12-5POL |
|  | Fieldbus socket for Micro Style connection, M12, 5-pin | 18324 | FBSD-GD-9-5POL |
| | Plug for Micro Style connection, M12, 5-pin | 175380 | FBS-M12-5GS-PG9 |
|  | Open Style bus connection | 525634 | FBA-1-SL-5POL |
|  | Terminal strip for Open Style connection, 5-pin | 525635 | FBSD-KL-2x5POL |
|  | Inspection cover, transparent | 533334 | AK-SUB-9/15-B |
|  | Inscription label holder for connection block | 536593 | CPX-ST-1 |
|  | Adapter from 5-pin M12 to mini USB socket and controller software | 547432 | NEFC-M12G5-03-U1G5 |
| User manual | | | |
|  | User manual for bus node CPX-FB14 | German | 526409 P.BE-CPX-FB14-DE |
| | | English | 526410 P.BE-CPX-FB14-EN |
| | | Spanish | 526411 P.BE-CPX-FB14-ES |
| | | French | 526412 P.BE-CPX-FB14-FR |
| | | Italian | 526413 P.BE-CPX-FB14-IT |

Terminal CPX

Technical data – Bus node CPX-M-FB20/CPX-M-FB21



Bus node for handling communication between the electrical terminal CPX and a higher-order master via INTERBUS.
 The bus node processes communication with the I/O modules.
 The status of the terminal CPX is displayed as a common message via 4 CPX-specific LEDs.
 The fieldbus communication status is displayed via 6 INTERBUS-specific LEDs.



Application

Bus connection

The bus connection is established via a socket with INTERBUS Rugged Line connection technology and the associated plug, with fibre-optic cables used for the power supply to the valve terminal and data transmission.

The bus node is used as a remote I/O. It supports processing of max. 96 inputs and 96 outputs or max. 6 analogue I/O channels.

The I/O area is divided into:

- Digital I/O
- Analogue I/O

- System status/system diagnostics (optional)
- PCP channel (optional)

INTERBUS implementation

The CPX-M-FB20 and CPX-M-FB21 support the INTERBUS protocol to EN 50254.
 In addition to cyclic I/O exchange, the optional PCP channel can be used for parameterisation and diagnostic functions.

An example of this is access to the integrated diagnostic memory function, i.e. storage of the last 40 errors with timestamp, module, channel and error type.

The PCP channel provides access to advanced system information and assigns operation parameters while the controller is running via the user program.

 Note
 If the PCP channel is used, the maximum number of possible process data bits is reduced by 16.

Special features in combination with CPX-FB20/CPX-FB21

- Remote Controller operating mode is not supported. A CPX-FEC/CPX-CEC cannot be used in combination with CPX-FB20/CPX-FB21 in a terminal CPX.

- Power is supplied via the fieldbus connection. It is therefore not possible to use an interlinking block with system supply within a terminal CPX with CPX-M-FB20/CPX-M-FB21.

- Only the valve terminals VTSA and VTSA-F with pneumatic interface VABA-S6-1-X2 can be selected as the pneumatic part.

Terminal CPX

Technical data – Bus node CPX-M-FB20/CPX-M-FB21

| General technical data | | | |
|--|-------------------|--|--|
| Type | | CPX-M-FB20/CPX-M-FB21 | |
| Fieldbus interface | | Rugged Line fibre-optic cable connection | |
| Baud rate | | [Mbit/s] | 0.5 and 2 |
| Bus type | | Remote bus | |
| Max. address capacity | Inputs | [bit] | 96 |
| | Outputs | [bit] | 96 |
| LED displays | INTERBUS-specific | | BA = Bus active FO1 = Fibre-optic cable 1 FO2 = Fibre-optic cable 2 RC = Remotebus check RD = Remotebus disable UL = Operating voltage for INTERBUS interface |
| | CPX-specific | | M = Parameterisation SF = System fault US1 = Electronics supply, sensor supply US2 = Load supply |
| Device-specific diagnostics | | <ul style="list-style-type: none"> • Diagnostic memory • Channel and module-oriented diagnostics • Module undervoltage | |
| Parameterisation | | <ul style="list-style-type: none"> • Diagnostic behaviour • Fail-safe response • Forcing of channels • Signal setup • System parameters | |
| Additional functions | | <ul style="list-style-type: none"> • Module and system parameterisation via operator units • System status can be represented using process data • Additional diagnostic interface for operator units | |
| Operating elements | | DIL switches | |
| Operating voltage | Nominal value | [V DC] | 24 (polarity-safe) |
| | Permissible range | [V DC] | 18 ... 30 |
| Intrinsic current consumption at nominal operating voltage | | [mA] | Typically 90 |
| Protection class to EN 60529 | | IP65, IP67 | |
| Temperature range | Operation | [°C] | -5 ... +50 |
| | Storage/transport | [°C] | -20 ... +70 |
| CE marking (see declaration of conformity) | | To EU EMC Directive | |
| Housing materials | | Aluminium | |
| Note on materials | | RoHS-compliant | |
| Grid dimension | | [mm] | 50 |
| Dimensions (incl. interlinking block) W x L x H | | [mm] | 100 x 110 x 130 |
| Product weight | CPX-FB20 | [g] | 1,070 |
| | CPX-FB21 | [g] | 1,255 |

 Note

Please observe the general limits and guidelines for the system when configuring the electrical modules.

Terminal CPX

Technical data – Bus node CPX-M-FB20/CPX-M-FB21

Connection and display components

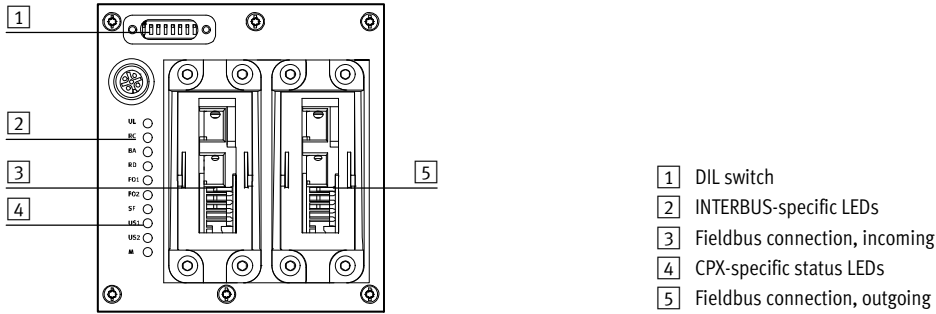

Pin allocation for INTERBUS interface

| FOC pin allocation | Pin | Wire colour | Designation |
|--------------------|-----|-----------------------------------|--|
| Incoming | | | |
| | A | Black | Transmitted data |
| | B | Orange | Received data |
| | 1 | – | 24 V supply for electronics and inputs |
| | 2 | – | 0 V supply for electronics and inputs |
| | 3 | – | 24 V supply for valves and outputs |
| 4 | – | 0 V supply for valves and outputs | |
| 5 | – | Functional earth | |
| Outgoing | | | |
| | A | Orange | Transmitted data |
| | B | Black | Received data |
| | 1 | – | 24 V supply for electronics and inputs |
| | 2 | – | 0 V supply for electronics and inputs |
| | 3 | – | 24 V supply for valves and outputs |
| 4 | – | 0 V supply for valves and outputs | |
| 5 | – | Functional earth | |

Terminal CPX

Accessories – Bus node CPX-M-FB20/CPX-M-FB21

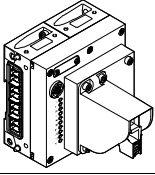
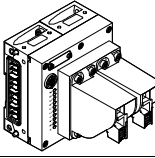
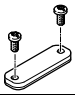
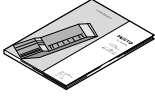
| Ordering data | | | | |
|---|--|---------|---------------|----------------------------|
| Designation | | | Part No. | Type |
| Bus node | | | | |
|  | INTERBUS bus node, incoming fieldbus connection | | 572334 | CPX-M-FB20 |
|  | INTERBUS bus node, incoming and outgoing fieldbus connection | | 572221 | CPX-M-FB21 |
| Bus connection | | | | |
|  | Blanking plate for covering the DIL switches | | 572818 | CPX-M-FB21-IB-RL |
| Manual | | | | |
|  | Manual – Bus nodes CPX-M-FB20 and CPX-M-FB21 | German | 575107 | P.BE-CPX-FB20/21-DE |
| | | English | 575108 | P.BE-CPX-FB20/21-EN |
| | | Spanish | 575109 | P.BE-CPX-FB20/21-ES |
| | | French | 575110 | P.BE-CPX-FB20/21-FR |
| | | Italian | 575111 | P.BE-CPX-FB20/21-IT |

Terminal CPX

Technical data – Bus node CPX-FB23-24



Bus node for handling communication between the electrical CPX terminal and a higher-order master for Control & Communication-Link (CC-Link) from Mitsubishi.

The bus node is provided with system supply via the interlinking block and processes communication with the I/O modules.

The status of the CPX terminal is displayed as a common message via 4 CPX-specific LEDs.

The fieldbus communication status is displayed via 4 CC-Link-specific LEDs.



Application

Bus connection

The bus connection can be selected when ordering and is established by means of a screw terminal with IP20 protection, a Sub-D plug with IP65/IP67 protection from Festo or IP20 protection from other manufacturers. Both connection types have the function of an integrated T-distributor and thus support the connection of an incoming and outgoing bus cable.

CC-Link implementation

The CPX bus node CPX-FB23-24 optionally supports the CC-Link versions 2.0 (as function module F24) and 1.1. (as function module F23). These designations are also found in the system diagram for the CPX Maintenance Tool (CPX-FMT) or in the operator unit (CPX-MMI-1) from Festo.

Function module F24 corresponds to CC-Link version 2.0 and supports a maximum of four stations per slave, up to an address capacity 64 bytes of digital I/O and 64 bytes of analogue I/O each. It is possible to optimise the configuration of the addressing in terms of either cycle time or station.

Function module F23 corresponds to CC-Link version 1.1 and supports a maximum of four stations per slave, up to an address capacity 32 bytes of digital I/O and 14 bytes of analogue I/O each.

The function module and option are set using the DIL switch on the CPX bus nodes.

Points to note in connection with CPX-FEC/CPX-CEC

When a bus node is combined with a control block (CPX-FEC, CPX-CEC, in the fieldbus remote controller operating mode), the connected I/Os and/or valves, sensors and actuators are controlled via the CPX control block.

In this case, the bus node only provides the communication interface to the PLC. Communication between the control block and CPX bus node takes place by interlinking of the CPX modules and takes up the following address capacity in the CPX system:

- 8 byte outputs
- 8 byte inputs

The following address capacity remains in the control block or CPX system for actuation of the peripherals:

- 56 byte inputs
- 56 byte outputs

Terminal CPX

Technical data – Bus node CPX-FB23-24

| General technical data | | | | |
|---|-------------------|-----|--------|--|
| Type | | | | CPX-FB23-24 |
| Fieldbus interface | | | | Either <ul style="list-style-type: none"> • Sub-D socket, 9-pin • Sub-D plug, for self-assembly • Screw terminal strip, IP20 |
| Baud rates | | | [kbps] | 156 ... 10,000 |
| Protocol | | | | CC-Link |
| Max. address capacity, inputs | FB23 | RWr | [byte] | 32 |
| | | Rx | [byte] | 14 |
| | FB24 | RWr | [byte] | 64 |
| | | Rx | [byte] | 64 |
| Max. address capacity, outputs | FB23 | RWw | [byte] | 32 |
| | | Ry | [byte] | 14 |
| | FB24 | RWw | [byte] | 64 |
| | | Ry | [byte] | 64 |
| LED displays (bus-specific) | | | | RUN = Communication status ERROR = Communication error SD = Send data RD = Receive data |
| Device-specific diagnostics | | | | <ul style="list-style-type: none"> • Diagnostic memory • Channel and module-oriented diagnostics • Module undervoltage |
| Parameterisation | | | | <ul style="list-style-type: none"> • Diagnostic behaviour • Fail-safe response • Forcing of channels • Signal setup • System parameters |
| Additional functions | | | | <ul style="list-style-type: none"> • System status can be displayed using process data • Additional diagnostic interface for operator units |
| Control elements | | | | DIL switches |
| Operating voltage | Nominal value | | [V DC] | 24 |
| | Permissible range | | [V DC] | 18 ... 30 |
| Current consumption | | | [mA] | Typically 200 |
| Protection class to EN 60529 | | | | IP65, IP67 |
| Temperature range | Operation | | [°C] | -5 ... +50 |
| | Storage/transport | | [°C] | -20 ... +70 |
| Materials | | | | PA reinforced, PC |
| Grid dimension | | | [mm] | 50 |
| Dimensions (incl. interlinking block) W x L x H | | | [mm] | 50 x 107 x 50 |
| Product weight | | | [g] | 115 |

 Note

Please observe the general limits and guidelines for the system when configuring the electrical modules.

Terminal CPX

Technical data – Bus node CPX-FB23-24

Connection and display components

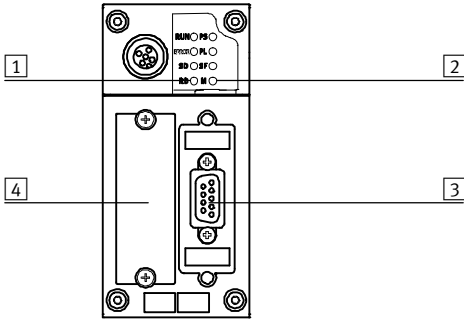





- 1 Bus-specific status LEDs
- 2 CPX-specific status LEDs
- 3 Fieldbus connection (9-pin, Sub-D socket)
- 4 DIL switch cover

Pin allocation for the CC-Link interface

| Pin allocation | Pin | Signal | Designation |
|--------------------------------------|-----|------------------|--------------------------|
| Sub-D socket | | | |
| | 1 | n.c. | Not connected |
| | 2 | DA | Data A |
| | 3 | DG | Data reference potential |
| | 4 | n.c. | Not connected |
| | 5 | FE ¹⁾ | Functional earth |
| | 6 | n.c. | Not connected |
| | 7 | DB | Data B |
| | 8 | n.c. | Not connected |
| | 9 | n.c. | Not connected |
| Screw terminal bus connection | | | |
| | 1 | FG | Functional earth/housing |
| | 2 | SLD | Screening |
| | 3 | DG | Data reference potential |
| | 4 | DB | Data B |
| | 5 | DA | Data A |

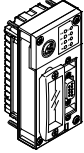
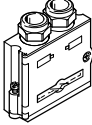
Terminal CPX

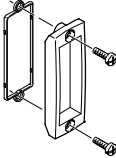
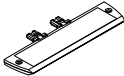
Accessories – Bus node CPX-FB23-24

| Ordering data | | | |
|---|---|----------|-----------------------------|
| Description | | Part No. | Type |
| Bus node | | | |
|  | CC-Link bus node | 526176 | CPX-FB23-24 |
| Bus connection | | | |
|  | Sub-D plug | 532220 | FBS-SUB-9-GS-2x4POL-B |
|  | Screw terminal bus connection | 197962 | FBA-1-KL-5POL |
|  | Inspection cover, transparent | 533334 | AK-SUB-9/15-B |
|  | Inscription label holder for connection block | 536593 | CPX-ST-1 |
|  | Adapter from 5-pin M12 to mini USB socket and controller software | 547432 | NEFC-M12G5-0.3-U1G5 |
| User documentation | | | |
|  | User documentation for bus node CPX-FB23-24 | German | 526403 P.BE-CPX-FB23-24-DE |
| | | English | 526404 P.BE-CPX-FB23-24-EN |
| | | Chinese | 8026069 P.BE-CPX-FB23-24-ZH |

Terminal CPX

Technical data – Bus node CPX-FB32



IT services:



Bus node for handling communication between the electrical CPX terminal and the EtherNet/IP network.

The bus node is provided with system supply via the interlinking block and processes communication with the I/O modules.

The status of the CPX terminal is displayed as a common message via four CPX-specific LEDs.



Application
Bus connection

The bus connection is established via an M12 plug, D-coded to IEC947-5-2 with IP65, IP67 protection.

EtherNet/IP is an open bus system based on the Ethernet standard and TCP/IP technology (IEEE802.3).

EtherNet/IP implementation

The CPX-FB32 supports the two remote I/O and remote controller operating modes. In remote I/O operating mode, all functions of the CPX valve terminal are

directly controlled by the EtherNet/IP master (host). In addition to actuation via a bus system, it is possible to use IT technol-

ogies. An integrated web server enables diagnostic data to be visualised via HTML. Various programs support direct access to the data of the device

from the automation network. The EtherNet/IP node for CPX supports the transmission technology that conforms to DIN EN 50173/CAT 5.

Special points in combination with CPX-FEC/CPX-CEC

When a bus node is combined with a control block (CPX-FEX, CPX-CEC, in the fieldbus remote controller operating mode), the connected I/Os and/or valves, sensors and actuators are controlled via the CPX control

block. In this case, the bus node only provides the communication interface to the PLC. Communication between the control block and CPX bus node is established

via the interlinking of the CPX modules and occupies an address capacity of the CPX system of:

- 8 byte outputs
- 8 byte inputs

The remaining address capacity of the control block or CPX system for actuating the peripherals is:

- 56 byte inputs
- 56 byte outputs

Terminal CPX

Technical data – Bus node CPX-FB32

| General technical data | | |
|---|---|--------------------------|
| Type | CPX-FB32 | |
| Fieldbus interface | Socket M12, D-coded, 4-pin | |
| Baud rate | [Mbit/s] | 10/100, full/half duplex |
| IP addressing | Via DHCP, DIL switch or network software | |
| Max. address capacity, inputs | [byte] | 64 |
| Max. address capacity, outputs | [byte] | 64 |
| LED displays (bus-specific) | MS = Module status NS = Network status IO = I/O status TP = Link/traffic | |
| Device-specific diagnostics | System, module and channel-oriented diagnostics | |
| Parameterisation | <ul style="list-style-type: none"> Start-up parameterisation Asynchronous parameterisation via Explicit Messaging | |
| Additional functions | <ul style="list-style-type: none"> Storage of the last 40 errors with timestamp (access via system diagnostics) 8-bit system status in image table for inputs 2-byte I/O, system diagnostics via image table | |
| Control elements | DIL switch | |
| Operating voltage | Nominal value | [V DC] 24 |
| | Permissible range | [V DC] 18 ... 30 |
| | Power failure buffering | [ms] 10 |
| Current consumption | [mA] | Typically 65 |
| Protection class to EN 60529 | IP65, IP67 | |
| Temperature range | Operation | [°C] – 5... +50 |
| | Storage/transport | [°C] –20 ... +70 |
| Materials | PA-reinforced PC | |
| Grid dimension | [mm] | 50 |
| Dimensions (incl. interlinking block) W x L x H | [mm] | 50 x 107 x 50 |
| Weight | [g] | 125 |

 Note

Please observe the general limits and guidelines for the system when configuring the electrical modules.

Terminal CPX

Technical data – Bus node CPX-FB32

Connection and display components

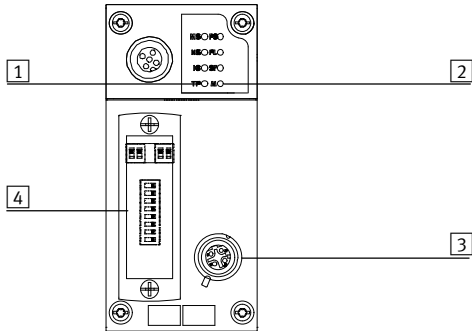

- 1 Bus-specific status LEDs
- 2 CPX-specific status LEDs
- 3 Fieldbus connection
(4-pin socket M12, D-coded)
- 4 Transparent DIL switch cover



Pin allocation for the fieldbus interface

| Pin allocation | Pin | Signal | Designation |
|---------------------|---------|--------|-------------------|
| M12 socket, D-coded | | | |
| | 1 | TD+ | Transmitted data+ |
| | 2 | RD+ | Received data+ |
| | 3 | TD- | Transmitted data- |
| | 4 | RD- | Received data- |
| | Housing | | |

Terminal CPX

Accessories – Bus node CPX-FB32

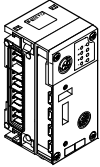
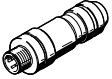
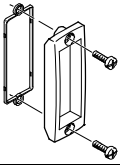
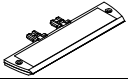

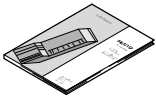
| Ordering data | | | |
|---|---|----------|-------------------------|
| Designation | | Part No. | Type |
| Bus node | | | |
|  | EtherNet/IP bus node | 541302 | CPX-FB32 |
| Bus connection | | | |
|  | Plug M12x1, 4-pin, D-coded | 543109 | NECU-M-S-D12G4-C2-ET |
|  | Inspection cover, transparent | 533334 | AK-SUB-9/15-B |
|  | Inscription label holder for connection block | 536593 | CPX-ST-1 |
|  | Adapter from 5-pin M12 to mini USB socket and controller software | 547432 | NEFC-M12G5-03-U1G5 |
| User manual | | | |
|  | User manual for bus node CPX-FB32 | German | 693134 P.BE-CPX-FB32-DE |
| | | English | 693135 P.BE-CPX-FB32-EN |
| | | Spanish | 693136 P.BE-CPX-FB32-ES |
| | | French | 693137 P.BE-CPX-FB32-FR |
| | | Italian | 693138 P.BE-CPX-FB32-IT |

Terminal CPX

Technical data – Bus node CPX-FB33



Bus node for operating the CPX valve terminal on PROFINET.
 The bus node is provided with system supply via the interlinking block and processes communication with the I/O modules.
 The status of the CPX terminal is displayed as a common message via four CPX-specific LEDs.
 The fieldbus communication status is displayed via three bus-specific LEDs.



Application

Bus connection

The bus connection is established via two M12 sockets, D-coded to IEC61076-2-101 with IP65, IP67 protection.

Both connections are equivalent 100BaseTX Ethernet ports with integrated auto MDI functionality (cross-over and patch cables can be used) that are brought together via an internal switch.

- Maximum segment length 100 m
- Transmission rate 100 Mbit/s

PROFINET implementation

The CPX-FB33 supports the PROFINET protocol on the basis of the Ethernet standard and TCP/IP technology to IEEE802.3. This guarantees a data exchange with a high data transmission rate, for example I/O data from sensors, actuators or robot controllers, PLCs or process equipment. In addition, non-real-time critical information such as diagnostic information, configuration information, etc. can be transferred. The Ethernet bandwidth is sufficient to transfer both data types (real-time and non-real-time) in parallel.

The bus node features LEDs for bus status and CPX peripheral information as well as switch elements, memory stick and a diagnostic interface. The purpose of the memory stick is to guarantee fast replacement of the bus node in the event of an error. PROFINET provides the user with access to all peripherals, diagnostic data and parameter data of the CPX valve terminal. The bus node can be used as a remote I/O or remote controller. All information relevant to the CPX can be read out and, depending on the function, changed via an MMI.

Special points in combination with CPX-FEC/CPX-CEC

When a bus node is combined with a control block (CPX-FEX, CPX-CEC, in the fieldbus remote controller operating mode), the connected I/Os and/or valves, sensors and actuators are controlled via the CPX control block. In this case, the bus node only provides the communication interface to the PLC. Communication between the control block and CPX bus node is established via the interlinking of the CPX modules and occupies an address capacity of the CPX system of:

- 8 byte outputs
- 8 byte inputs

The remaining address capacity of the control block or CPX system for actuating the peripherals is:

- 56 byte inputs
- 56 byte outputs

Terminal CPX

Technical data – Bus node CPX-FB33

| General technical data | | | |
|---|--------------------|--|---------------|
| Type | | CPX-FB33 | |
| Fieldbus interface | | 2x socket M12, D-coded, 4-pin | |
| Baud rate | [Mbit/s] | 100 | |
| Protocol | | PROFINET RT PROFINET IRT | |
| Max. address capacity | Inputs | [byte] | 64 |
| | Outputs | [byte] | 64 |
| LED displays | (bus-specific) | M/P = Maintenance/PROFenergy NF = Network fault TP1 = Network active port 1 TP2 = Network active port 2 | |
| | (product-specific) | M = Modify, parameterisation PL = Load supply PS = Electronic supply, sensor supply SF = System fault | |
| Device-specific diagnostics | | <ul style="list-style-type: none"> Channel and module-oriented diagnostics Undervoltage of modules Diagnostic memory | |
| Configuration support | | GSDML file | |
| Parameterisation | | <ul style="list-style-type: none"> System parameters Diagnostic behaviour Signal setup Fail-safe response Forcing of channels | |
| Additional functions | | <ul style="list-style-type: none"> Start-up parameterisation in plain text via fieldbus Fast startup (FSU) Channel-oriented diagnostics via fieldbus Asynchronous data access via fieldbus System status can be represented using process data Additional diagnostic interface for operator units Asynchronous data access via Ethernet | |
| Control elements | | <ul style="list-style-type: none"> DIL switch Optional memory card | |
| Operating voltage | Nominal value | [V DC] | 24 |
| | Permissible range | [V DC] | 18 ... 30 |
| Current consumption | | [mA] | Typically 120 |
| Protection class to EN 60529 | | IP65, IP67 | |
| Temperature range | Operation | [°C] | - 5... +50 |
| | Storage/transport | [°C] | -20 ... +70 |
| Materials | | Housing | |
| Grid dimension | | [mm] | 50 |
| Dimensions (incl. interlinking block) W x L x H | | [mm] | 50 x 107 x 50 |
| Weight | | [g] | 280 |

 Note
Please observe the general limits and guidelines for the system when configuring the electrical modules.

 Note
Always use screws appropriate to the interlinking block (metal or plastic):

- Self-tapping screws for plastic interlinking blocks
- Screws with metric thread for metal interlinking blocks

Terminal CPX

Technical data – Bus node CPX-FB33

Connection and display components

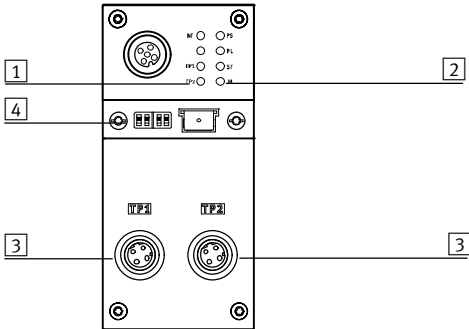

- 1 Bus-specific status LEDs
- 2 CPX-specific status LEDs
- 3 Fieldbus connection
(4-pin socket M12, D-coded)
- 4 Transparent cover for DIL switch
and memory card





Pin allocation for the fieldbus interface

| Pin allocation | Pin | Signal | Designation |
|---------------------|---------|--------|-------------------|
| M12 socket, D-coded | | | |
| | 1 | TD+ | Transmitted data+ |
| | 2 | RD+ | Received data+ |
| | 3 | TD- | Transmitted data- |
| | 4 | RD- | Received data- |
| | Housing | | |

Terminal CPX

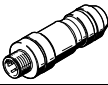
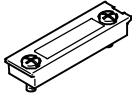
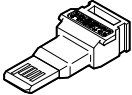
Accessories – Bus node CPX-FB33

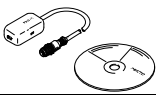

| Ordering data | | | |
|---|--|----------|-------------------------|
| Designation | | Part No. | Type |
| Bus node | | | |
|  | PROFINET bus node | 548755 | CPX-FB33 |
| Bus connection | | | |
|  | Plug M12x1, 4-pin, D-coded | 543109 | NECU-M-S-D12G4-C2-ET |
|  | Transparent cover for DIL switch and memory card | 548757 | CPX-AK-P |
|  | Memory card for PROFINET bus node, 2 MB | 568647 | CPX-SK-2 |
|  | Cover cap for sealing unused bus connections (10 pieces) | 165592 | ISK-M12 |
|  | Screws for attaching an inscription label holder to the bus node (12 pieces) | 550222 | CPX-M-M2,5X8-12X |
|  | Adapter from 5-pin M12 to mini USB socket and controller software | 547432 | NEFC-M12G5-03-U1G5 |
| User manual | | | |
|  | Electronics manual, CPX bus node, type CPX-FB33 | German | 548759 P.BE-CPX-PNIO-DE |
| | | English | 548760 P.BE-CPX-PNIO-EN |
| | | Spanish | 548761 P.BE-CPX-PNIO-ES |
| | | French | 548762 P.BE-CPX-PNIO-FR |
| | | Italian | 548763 P.BE-CPX-PNIO-IT |

Terminal CPX

Technical data – Bus node CPX-M-FB34



Bus node for operating the CPX valve terminal on PROFINET.
 The bus node is provided with system supply via the interlinking block and processes communication with the I/O modules.
 The status of the CPX terminal is displayed as a common message via four CPX-specific LEDs.
 The fieldbus communication status is displayed via three bus-specific LEDs.



Application

Bus connection

The bus connection is established via two RJ45 push-pull sockets to IEC61076-3-106 and IEC60603 with IP65, IP67 protection.

Both connections are equivalent 100BaseTX Ethernet ports with integrated auto MDI functionality (cross-over and patch cables can be used) that are brought together via an internal switch.

- Maximum segment length 100 m
- Transmission rate 100 Mbit/s

PROFINET implementation

The CPX-M-FB34 supports the PROFINET protocol based on the Ethernet standard and the TCP/IP technology to IEEE802.3. This guarantees a data exchange with a high data transmission rate, for example I/O data from sensors, actuators or robot controllers, PLCs or process equipment. In addition, non-real-time critical information such as diagnostic information, configuration information, etc. can be transferred. The Ethernet bandwidth is sufficient to transmit both data types (real-time and non-real-time) in parallel.

The bus node features LEDs for bus status and CPX peripheral information as well as switch elements, memory stick and a diagnostic interface. The purpose of the memory stick is to guarantee fast replacement of the bus node in the event of an error. PROFINET provides the user with access to all peripherals, diagnostic data and parameter data of the CPX valve terminal. The bus node can be used as a remote I/O or remote controller. All information relevant to the CPX can be read out and, depending on the function, changed via an MMI.

Special points in combination with CPX-FEC/CPX-CEC

When a bus node is combined with a control block (CPX-FEX, CPX-CEC, in the fieldbus remote controller operating mode), the connected I/Os and/or valves, sensors and actuators are controlled via the CPX control block. In this case, the bus node only provides the communication interface to the PLC. Communication between the control block and CPX bus node is established via the interlinking of the CPX modules and occupies an address capacity of the CPX system of:

- 8/16 byte outputs
- 8/16 byte inputs

The remaining address capacity of the control block or CPX system for actuating the peripherals is:

- 56/48 byte inputs
- 56/48 byte outputs

Terminal CPX

Technical data – Bus node CPX-M-FB34

| General technical data | | | |
|--|--------------------|--|---------------|
| Type | | CPX-M-FB34 | |
| Fieldbus interface | | 2x RJ45 push-pull socket, AIDA | |
| Baud rate | [Mbit/s] | 100 | |
| Protocol | | PROFINET RT PROFINET IRT | |
| Max. address capacity | Inputs | [byte] | 64 |
| | Outputs | [byte] | 64 |
| LED displays | (bus-specific) | M/P = Maintenance/PROFenergy NF = Network fault TP1 = Network active port 1 TP2 = Network active port 2 | |
| | (product-specific) | M = Modify, parameterisation PL = Load supply PS = Electronic supply, sensor supply SF = System fault | |
| Device-specific diagnostics | | <ul style="list-style-type: none"> Channel and module-oriented diagnostics Undervoltage of modules Diagnostic memory | |
| Configuration support | | GSDML file | |
| Parameterisation | | <ul style="list-style-type: none"> System parameters Diagnostic behaviour Signal setup Fail-safe response Forcing of channels | |
| Additional functions | | <ul style="list-style-type: none"> Start-up parameterisation in plain text via fieldbus Fast startup (FSU) Channel-oriented diagnostics via fieldbus Asynchronous data access via fieldbus and via Ethernet System status can be represented using process data Additional diagnostic interface for operator units | |
| Control elements | | DIL switch, optional memory card | |
| Operating voltage | Nominal value | [V DC] | 24 |
| | Permissible range | [V DC] | 18 ... 30 |
| Intrinsic current consumption at nominal operating voltage | | [mA] | Typically 120 |
| Protection class to EN 60529 | | IP65, IP67 | |
| Temperature range | Operation | [°C] | - 5... +50 |
| | Storage/transport | [°C] | -20 ... +70 |
| Material of housing | | Die-cast aluminium | |
| Grid dimension | | [mm] | 50 |
| Dimensions (incl. interlinking block) W x L x H | | [mm] | 50 x 107 x 80 |
| Weight | | [g] | 280 |

 - Note

Please observe the general limits and guidelines for the system when configuring the electrical modules.

 - Note

Always use screws appropriate to the interlinking block (metal or plastic):

- Self-tapping screws for plastic interlinking blocks

- Screws with metric thread for metal interlinking blocks

Terminal CPX

Technical data – Bus node CPX-M-FB34

Connection and display components

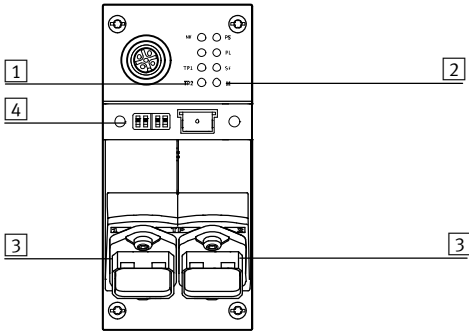

- 1 Bus-specific status LEDs
- 2 CPX-specific status LEDs
- 3 Fieldbus connection (8-pin RJ45 socket)
- 4 DIL switch and memory card







Pin allocation for the fieldbus interface

| Pin allocation | Pin | Signal | Designation |
|--------------------|----------|----------|-------------------|
| RJ45 socket | | | |
| | 1 | TD+ | Transmitted data+ |
| | 2 | TD- | Transmitted data- |
| | 3 | RD+ | Received data+ |
| | 4 | n.c. | Not connected |
| | 5 | n.c. | Not connected |
| | 6 | RD- | Received data- |
| | 7 | n.c. | Not connected |
| | 8 | n.c. | Not connected |
| Housing | Screened | Screened | Screened |

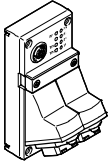
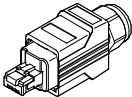
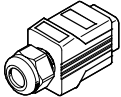
Terminal CPX

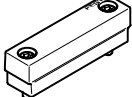
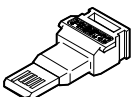
Accessories – Bus node CPX-M-FB34

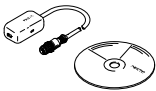

| Ordering data | | | |
|---|--|----------|-------------------------|
| Designation | | Part No. | Type |
| Bus node | | | |
|  | PROFINET bus node | 548751 | CPX-M-FB34 |
| Bus connection | | | |
|  | RJ45 plug, 8-pin, push-pull | 552000 | FBS-RJ45-PP-GS |
|  | Cover cap for bus connection | 548753 | CPX-M-AK-C |
|  | Cover cap for bus connection | 2873540 | CPX-M-AK-D |
|  | Cover for DIL switch and memory card | 548754 | CPX-M-AK-M |
|  | Memory card for PROFINET bus node, 2 MB | 568647 | CPX-SK-2 |
|  | Screws for attaching an inscription label holder to the bus node (12 pieces) | 550222 | CPX-M-M2,5X8-12X |
|  | Adapter from 5-pin M12 to mini USB socket and controller software | 547432 | NEFC-M12G5-03-U1G5 |
| User manual | | | |
|  | Electronics manual, CPX bus node, type CPX-M-FB34 | German | 548759 P.BE-CPX-PNIO-DE |
| | | English | 548760 P.BE-CPX-PNIO-EN |
| | | Spanish | 548761 P.BE-CPX-PNIO-ES |
| | | French | 548762 P.BE-CPX-PNIO-FR |
| | | Italian | 548763 P.BE-CPX-PNIO-IT |

Terminal CPX

Technical data – Bus node CPX-M-FB35/CPX-M-FB41



Bus node for operating the CPX valve terminal on PROFINET.
The bus node is provided with system supply via the interlinking block and processes communication with the I/O modules.
The status of the CPX terminal is displayed as a common message via 4 CPX-specific LEDs.
The fieldbus communication status is displayed via three bus-specific LEDs.



Application

Bus connection

The bus connection is established via SCRJ push-pull sockets to IEC61754-24 (fibre-optic cable, AIDA standard) with degree of protection to IP65, IP67.

The connections on the CPX-M-FB35 are equivalent 100BaseFX Ethernet ports that are brought together via an internal switch.

Fibre-optic cables made from plastic (POF, 980/1000 µm) are also suitable for transmission.

- Maximum segment length 50 m
- Transmission rate 100 Mbps
- Supports LLDP and SNMP

PROFINET implementation

The CPX-M-FB35/CPX-M-FB41 supports the PROFINET protocol based on the Ethernet standard and TCP/IP technology to IEEE802.3. This guarantees a data exchange with a high data transmission rate, for example I/O data from sensors, actuators or robot controllers, PLCs or

process equipment. Furthermore, non real-time critical information such as diagnostic information, configuration information, etc. can be transferred. The Ethernet bandwidth is sufficient to transmit both data types (real-time and non real-time) in parallel.

The bus node features LEDs for bus status and CPX peripheral information as well as switch elements, memory stick and a diagnostic interface. The purpose of the memory stick is to guarantee fast replacement of the bus node in the event of an error. PROFINET provides the user with

access to all peripheral, diagnostic and parameter data for the CPX valve terminal. The bus node can be used as a remote I/O or remote controller. All information relevant to the CPX can be read out and, depending on the function, changed via an MMI.

Points to note in connection with CPX-FEC/CPX-CEC

When a bus node is combined with a control block (CPX-FEC, CPX-CEC, in the fieldbus remote controller operating mode), the connected I/Os and/or valves, sensors and actuators are controlled via the CPX control block.

In this case, the bus node only provides the communication interface to the PLC. Communication between the control block and CPX bus node takes place

by interlinking the CPX modules and takes up the following address capacity in the CPX system:

- 8/16 byte outputs
- 8/16 byte inputs

The following address capacity remains in the control block or CPX system for activating the peripherals:

- 56/48 byte inputs
- 56/48 byte outputs

Terminal CPX

Technical data – Bus node CPX-M-FB35/CPX-M-FB41

| General technical data | | | | |
|--|--------------------|--------|---|---|
| Type | | | CPX-M-FB35 | CPX-M-FB41 |
| Fieldbus interface | | | 2x SCRJ push-pull socket, AIDA | 1x SCRJ push-pull socket, AIDA |
| Baud rate | [Mbps] | | 100 | |
| Protocol | | | PROFINET RT | PROFINET RT |
| | | | PROFINET IRT | – |
| Max. address capacity | Inputs | [byte] | 64 | |
| | Outputs | [byte] | 64 | |
| LED displays | (bus-specific) | | M/P = Maintenance/PROFenergy NF = Network fault TP1 = Network active port 1 TP2 = Network active port 2 | NF = Network fault TP1 = Network active port 1 |
| | (product-specific) | | M = Modify, parameterisation PL = Load supply PS = Electronic supply, sensor supply SF = System fault | |
| Device-specific diagnostics | | | <ul style="list-style-type: none"> • Channel and module-oriented diagnostics • Undervoltage of modules • Diagnostic memory | |
| Configuration support | | | GSDML file | |
| Parameterisation | | | <ul style="list-style-type: none"> • System parameters • Diagnostic behaviour • Signal setup • Fail-safe response • Forcing of channels | |
| Additional functions | | | <ul style="list-style-type: none"> • Start-up parameterisation in plain text via fieldbus • Fast start-up (FSU) • Channel-oriented diagnostics via fieldbus • Acyclic data access via fieldbus and via Ethernet • System status can be displayed using process data • Additional diagnostic interface for operator unit | |
| Control elements | | | DIL switch, optional memory card | |
| Operating voltage | Nominal value | [V DC] | 24 | |
| | Permissible range | [V DC] | 18 ... 30 | |
| Intrinsic current consumption at nominal operating voltage | | [mA] | Typically 150 | Typically 125 |
| Degree of protection to EN 60529 | | | IP65, IP67 | |
| Temperature range | Operation | [°C] | – 5... +50 | |
| | Storage/transport | [°C] | –20 ... +70 | |
| Housing material | | | Die-cast aluminium | |
| Note on materials | | | RoHS-compliant | |
| Grid dimension | | [mm] | 50 | |
| Dimensions (incl. interlinking block) W x L x H | | [mm] | 50 x 107 x 80 | |
| Product weight | | [g] | 280 | |

 **Note**

Please observe the general limits and guidelines for the system when configuring the electrical modules.

 **Note**

Always use the correct screws for the interlinking block; this depends on whether the block is made of metal or polymer:

- Self-tapping screws for polymer interlinking blocks

- Screws with metric thread for metal interlinking blocks

Terminal CPX

Technical data – Bus node CPX-M-FB35/CPX-M-FB41

Connection and display components

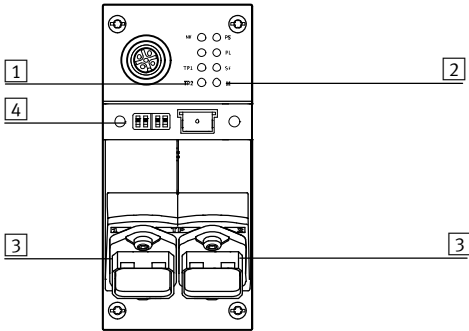







- 1 Bus-specific status LEDs
- 2 CPX-specific status LEDs
- 3 Fieldbus connection (SCRJ socket, 2-pin)
- 4 DIL switch and memory card

Pin allocation for the fieldbus interface

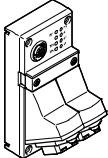
| Terminal allocation | Pin | Signal | Designation |
|---------------------|-----|--------|-------------|
| SCRJ socket | | | |
| | 1 | TX | Outgoing |
| | 2 | RX | Incoming |

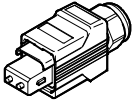
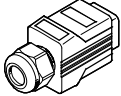
Terminal CPX

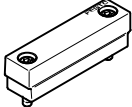
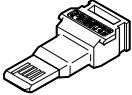
Accessories – Bus node CPX-M-FB35/CPX-M-FB41

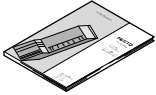
| Ordering data | | | | |
|---|---|--------------------------------|----------------|---|
| Description | | | Part No. | Type |
| Bus node | | | | |
|  | PROFINET bus node | 2x SCRJ push-pull socket, AIDA | 548749 | CPX-M-FB35 |
| | | 1x SCRJ push-pull socket, AIDA | 3228960 | CPX-M-FB41  |
| Bus connection | | | | |
|  | SCRJ plug, 2-pin, push-pull | | 571017 | FBS-SCRJ-PP-GS |
|  | Cover cap for bus connection | | 548753 | CPX-M-AK-C |
|  | Cover cap for bus connection | | 2873540 | CPX-M-AK-D |
|  | Cover for DIL switch and memory card | | 548754 | CPX-M-AK-M |
|  | Memory card for PROFINET bus node, 2MB | | 568647 | CPX-SK-2 |
|  | Screws for attaching an inscription label to the bus node (12 pieces) | | 550222 | CPX-M-M2,5X8-12X |
|  | 5-pin M12 adapter for mini USB socket and controller software | | 547432 | NEFC-M12G5-0.3-U1G5 |
| User documentation | | | | |
|  | Electronics manual, CPX bus node, type CPX-M-FB35/CPX-M-FB41 | German | 548759 | P.BE-CPX-PNIO-DE |
| | | English | 548760 | P.BE-CPX-PNIO-EN |
| | | Spanish | 548761 | P.BE-CPX-PNIO-ES |
| | | French | 548762 | P.BE-CPX-PNIO-FR |
| | | Italian | 548763 | P.BE-CPX-PNIO-IT |

Terminal CPX

Technical data – Bus node CPX-FB36



Bus node for handling communication between the electrical terminal CPX and the EtherNet/IP network.

The bus node is provided with system supply via the interlinking block and processes communication with the I/O modules.

The status of the terminal CPX is displayed as a common message via 4 CPX-specific LEDs.



Application

Bus connection

The bus connection is established via an M12 plug, D-coded to IEC947-5-2 with IP65, IP67 protection.

EtherNet/IP is an open bus system based on the Ethernet standard and TCP/IP technology (IEEE802.3).

EtherNet/IP implementation

The CPX-FB36 supports the two operating modes: remote I/O and remote controller. In remote I/O operating mode, all functions of the CPX valve terminal are

directly controlled by the EtherNet/IP master (host). In addition to actuation via a bus system, it is possible to use IT technologies. An integrated web server

enables diagnostic data to be visualised via HTML. Various programs support direct access to the data of the device from the automation

network. The EtherNet/IP node for CPX supports the transmission technology that conforms to DIN EN 50173/CAT 5.

Points to note in connection with CPX-FEC/CPX-CEC

When combining a bus node with a control block (CPX-FEC, CPX-CEC, in fieldbus remote controller operating mode), the connected I/Os or valves, sensors and actuators are controlled via the CPX control block.

In this case, the bus node only provides the communication interface to the PLC. Communication between the control block and CPX bus node takes place via interlinking of the CPX modules

and takes up the following address capacity in the CPX system:

- 8 byte outputs
- 8 byte inputs

The following address capacity

remains in the control block or CPX system for actuation of the peripherals:

- 56 byte inputs
- 56 byte outputs

Terminal CPX

Technical data – Bus node CPX-FB36

| General technical data | | | |
|---|--|---------------|-------------|
| Type | CPX-FB36 | | |
| Fieldbus interface | 2x M12x1 socket, D-coded, 4-pin | | |
| Baud rates | [Mbit/s] | 10/100 | |
| Protocol | EtherNet/IP Modbus TCP | | |
| Max. address capacity, inputs | [byte] | 64 | |
| Max. address capacity, outputs | [byte] | 64 | |
| LED displays (bus-specific) | MS = Module status NS = Network status TP1 = Network active port 1 TP2 = Network active port 2 | | |
| Device-specific diagnostics | <ul style="list-style-type: none"> • Module and channel-oriented diagnostics • Module undervoltage • Diagnostic memory | | |
| Configuration support | <ul style="list-style-type: none"> • EDS file • L5K export with CPX-FMT | | |
| Parameterisation | <ul style="list-style-type: none"> • Diagnostic behaviour • Fail-safe response • Forcing of channels • Idle mode characteristics • Signal setup • System parameters | | |
| Additional functions | <ul style="list-style-type: none"> • EtherNet/IP Quickconnect • Ring topology (DLR) • Acyclic data access via "Explicit Message" and Ethernet • Integrated switch • IP addressing via DHCP, DIL switch or operator unit • Channel-oriented diagnostics via fieldbus • Start-up parameterisation in plain text via fieldbus • System status can be represented using process data • Additional diagnostic interface for operator units | | |
| Control elements | DIL switches | | |
| Operating voltage | Nominal value | [V DC] | 24 |
| | Permissible range | [V DC] | 18 ... 30 |
| Current consumption (at nominal voltage, without MMI) | [mA] | Typically 100 | |
| Protection class to EN 60529 | IP65, IP67 | | |
| Temperature range | Operation | [°C] | -5 ... +50 |
| | Storage/transport | [°C] | -20 ... +70 |
| Materials | PA reinforced | | |
| Note on materials | RoHS-compliant | | |
| Grid dimension | [mm] | 50 | |
| Dimensions (incl. interlinking block) W x L x H | [mm] | 50 x 107 x 50 | |
| Product weight | [g] | 125 | |

 Note

Please observe the general limits and guidelines for the system when configuring the electrical modules.

Terminal CPX

Technical data – Bus node CPX-FB36

Connection and display components

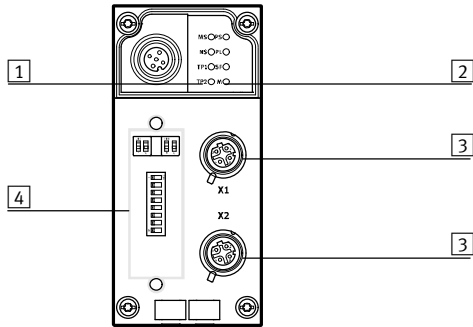



- 1 Bus-specific status LEDs
- 2 CPX-specific status LEDs
- 3 Fieldbus connection (4-pin socket M12, D-coded)
- 4 Transparent DIL switch cover

Pin allocation for the fieldbus interface

| Pin allocation | Pin | Signal | Designation |
|---------------------|---------|--------|-------------------|
| M12 socket, D-coded | | | |
| | 1 | TD+ | Transmitted data+ |
| | 2 | RD+ | Received data+ |
| | 3 | TD- | Transmitted data- |
| | 4 | RD- | Received data- |
| | Housing | FE | Screening |

Terminal CPX

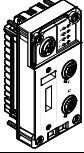
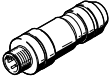
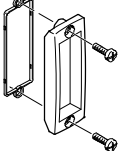
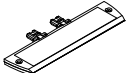
Accessories – Bus node CPX-FB36

| Ordering data | | | | |
|---|--|----------------|-----------------------------|-------------------------|
| Designation | | Part No. | Type | |
| Bus node | | | | |
|  | EtherNet/IP bus node | 1912451 | CPX-FB36 | |
| Bus connection | | | | |
|  | Plug M12x1, 4-pin, D-coded | 543109 | NECU-M-S-D12G4-C2-ET | |
|  | Inspection cover, transparent | 533334 | AK-SUB-9/15-B | |
|  | Inscription label holder for connection block | 536593 | CPX-ST-1 | |
|  | 5-pin M12 to mini USB socket adapter and controller software | 547432 | NEFC-M12G5-03-U1G5 | |
| Manual | | | | |
|  | Electronics manual, CPX bus node, type CPX-FB36 | German | 8024074 | P.BE-CPX-FB36-DE |
| | | English | 8024075 | P.BE-CPX-FB36-EN |
| | | Spanish | 8024076 | P.BE-CPX-FB36-ES |
| | | French | 8024077 | P.BE-CPX-FB36-FR |
| | | Italian | 8024078 | P.BE-CPX-FB36-IT |
| | | Chinese | 8024079 | P.BE-CPX-FB36-ZH |

Terminal CPX

Technical data – Bus node CPX-FB37



Bus node for operating the CPX valve terminal on EtherCAT.
 The bus node is provided with system supply via the interlinking block and processes communication with the I/O modules.
 The status of the terminal CPX is displayed as a common message via 4 CPX-specific LEDs.
 The fieldbus communication status is displayed via 4 bus-specific LEDs.



Application

Bus connection

The bus connection is established via two M12x1 sockets, D-coded to IEC61076-2-101 with degree of protection to IP65, IP67.

Both connections are equivalent 100BaseTX Ethernet ports with integrated auto MDI functionality (cross-over and patch cable can be used) that are brought together via an internal switch.

- Maximum segment length 100 m
- Transmission rate 100 Mbps

EtherCAT implementation

The CPX-FB37 supports the EtherCAT protocol based on the Ethernet standard and TCP/IP technology to IEEE802.3. This guarantees a data exchange with a high data transmission rate, for example I/O data from sensors, actuators or robot controllers, PLCs or process equipment. Furthermore, non real-time critical information such as diagnostic information, configuration information, etc. can be transferred.

The data bandwidth is sufficient to transmit both data types (real-time and non-real-time) in parallel. The bus node features LEDs for bus status and CPX peripheral information as well as switch elements and a diagnostic interface. The bus node can be used as a remote I/O or remote controller. All information relevant to the CPX can be read out and, dependent on the function, changed via an MMI/FMT.

The functions MDP (modular device profile) and CoE (CAN over EtherCAT) enable easy access to parameters and diagnostic data via EtherCAT.

Specific EtherCAT functions:

- CoE (parameters and diagnostics or fail-safe mode): all module parameters can be set
- FoE (file over EtherCAT) makes it possible to download firmware easily
- EoE (Ethernet over EtherCAT): diagnostic data can be retrieved easily using a browser
- MDP (modular device profile): easy configuration using a module selection box
- Hot Connect, easy replacement of an EtherCAT CPX terminal
- DC (distributed clocks), time-synchronised data transmission

Points to note in connection with CPX-FEC/CPX-CEC

When a bus node is combined with a control block (CPX-FEC, CPX-CEC, in the fieldbus remote controller operating mode), the connected I/Os and/or valves, sensors and actuators are controlled via the CPX control block.

In this case, the bus node only provides the communication interface to the PLC. Communication between the control block and CPX bus node takes place by interlinking the CPX modules and takes up the following address capacity in the CPX system:

- 8/16 byte outputs
- 8/16 byte inputs

The following address capacity remains in the control block or CPX system for activating the peripherals:

- 56/48 byte inputs
- 56/48 byte outputs

Terminal CPX

Technical data - Bus node CPX-FB37

| General technical data | | | |
|---|-------------------|--|---|
| Type | | CPX-FB37 | |
| Fieldbus interface | | 2x M12x1 socket, 4-pin, D-coded | |
| Baud rates | | [Mbps] | 100 |
| Protocol | | EtherCAT | |
| Max. address capacity | Inputs | [byte] | 64 |
| | Outputs | [byte] | 64 |
| LED displays | Bus-specific | | Error = Communication error L/A1 = Network active port 1 L/A2 = Network active port 2 Run = Communication status |
| | Product-specific | | M = Modify, parameterisation PL = Load supply PS = Electronic supply, sensor supply SF = System fault |
| Device-specific diagnostics | | <ul style="list-style-type: none"> Channel and module-oriented diagnostics Undervoltage of modules Diagnostic memory | |
| Configuration support | | ESI file | |
| Parameterisation | | <ul style="list-style-type: none"> System parameters Diagnostic behaviour Signal setup Fail-safe response Forcing of channels | |
| Additional functions | | <ul style="list-style-type: none"> System status can be displayed using process data Additional diagnostic interface for operator units Emergency message Acyclic data access via fieldbus Diagnostic object Compatibility mode for the CPX-FB38 Modular device profile (MDP) Variable PDO mapping | |
| Control elements | | DIL switches | |
| Operating voltage | Nominal value | [V DC] | 24 |
| | Permissible range | [V DC] | 18 ... 30 |
| Current consumption | | [mA] | Typically 100 |
| Degree of protection to EN 60529 | | IP65, IP67 | |
| Temperature range | Operation | [°C] | -5 ... +50 |
| | Storage/transport | [°C] | -20 ... +70 |
| Materials | | Housing | |
| Note on materials | | Reinforced PA | |
| Note on materials | | RoHS-compliant | |
| Grid dimension | | [mm] | 50 |
| Dimensions (incl. interlinking block) W x L x H | | [mm] | 50 x 107 x 50 |
| Product weight | | [g] | 125 |

 **Note**

Please observe the general limits and guidelines for the system when configuring the electrical modules.

 **Note**

Always use the correct screws for the interlinking block; this depends on whether the block is made of metal or polymer:

- Self-tapping screws for polymer interlinking blocks

- Screws with metric thread for metal interlinking blocks

Terminal CPX

Technical data – Bus node CPX-FB37

Connection and display components

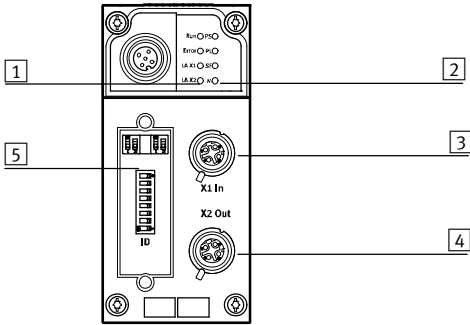

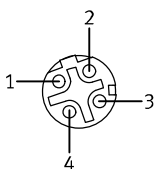

- 1 Bus-specific status LEDs
- 2 CPX-specific status LEDs
- 3 Fieldbus connection, input (M12x1 socket, 4-pin, D-coded)
- 4 Fieldbus connection, output (M12x1 socket, 4-pin, D-coded)
- 5 DIL switch

Pin allocation for the fieldbus interface

| Terminal allocation | Pin | Signal | Designation |
|---|---------|--------|-------------------|
| M12x1 socket, D-coded | | | |
|  | 1 | TD+ | Transmitted data+ |
| | 2 | RD+ | Received data+ |
| | 3 | TD- | Transmitted data- |
| | 4 | RD- | Received data- |
| | Housing | FE | Screening |

Terminal CPX

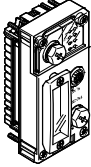
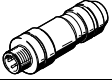
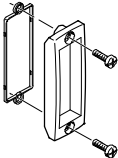
Accessories – Bus node CPX-FB37

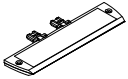
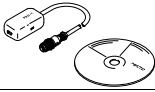
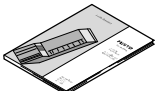
| Ordering data | | | |
|---|---|----------------|---------------------------------|
| Description | | Part No. | Type |
| Bus node | | | |
|  | EtherCAT bus node | 2735960 | CPX-FB37 |
| Bus connection | | | |
|  | Plug connector M12x1, 4-pin, D-coded | 543109 | NECU-M-S-D12G4-C2-ET |
|  | Inspection cover, transparent | 533334 | AK-SUB-9/15-B |
|  | Cover cap for sealing unused bus connections (10 pieces) | 165592 | ISK-M12 |
|  | Inscription label holder for connection block | 536593 | CPX-ST-1 |
|  | 5-pin M12 adapter for mini USB socket and controller software | 547432 | NEFC-M12G5-03-U1G5 |
| User documentation | | | |
|  | Electronics manual, CPX bus node, type CPX-FB37 | German | 8029674 P.BE-CPX-FB37-DE |
| | | English | 8029675 P.BE-CPX-FB37-EN |
| | | Spanish | 8029676 P.BE-CPX-FB37-ES |
| | | French | 8029677 P.BE-CPX-FB37-FR |
| | | Italian | 8029678 P.BE-CPX-FB37-IT |
| | | Chinese | 8029679 P.BE-CPX-FB37-ZH |

Terminal CPX

Technical data – Bus node CPX-FB38



Bus node for operating the CPX valve terminal on EtherCAT.
 The bus node is provided with system supply via the interlinking block and processes communication with the I/O modules.
 The status of the CPX terminal is displayed as a common message via four CPX-specific LEDs.
 The fieldbus communication status is displayed via four bus-specific LEDs.



Application

Bus connection

The bus connection is established via two M12 sockets, D-coded to IEC61076-2-101 with IP65, IP67 protection.

Both connections are equivalent 100BaseTX Ethernet ports with integrated auto MDI functionality (cross-over and patch cables can be used) that are brought together via an internal switch.

- Maximum segment length 100 m
- Transmission rate 100 Mbit/s

EtherCAT implementation

The CPX-FB38 supports the EtherCAT protocol based on the Ethernet standard and the TCP/IP technology to IEEE802.3. This guarantees a data exchange with a high data transmission rate, for example I/O data from sensors, actuators or robot controllers, PLCs or process equipment. In addition, non-real-time critical information such as diagnostic information, configuration information, etc. can be transferred.

The data bandwidth is sufficient to transmit both data types (real-time and non-real-time) in parallel.

The bus node features LEDs for bus status and CPX peripheral information as well as switch elements and a diagnostic interface. The bus node can be used as a remote I/O or remote controller. All information relevant to the CPX can be read out and, dependent on the function, changed via an MMI/FMT.

Special points in combination with CPX-FEC/CPX-CEC

When a bus node is combined with a control block (CPX-FEX, CPX-CEC, in the fieldbus remote controller operating mode), the connected I/Os and/or valves, sensors and actuators are controlled via the CPX control block.

In this case, the bus node only provides the communication interface to the PLC.

Communication between the control block and CPX bus node is established via the interlinking of the CPX modules and occupies an address capacity of the CPX system of:

- 8 byte outputs
- 8 byte inputs

The remaining address capacity of the control block or CPX system for actuating the peripherals is:

- 56 byte inputs
- 56 byte outputs

Terminal CPX

Technical data – Bus node CPX-FB38

| General technical data | | | |
|---|--|---|---------------|
| Type | CPX-FB38 | | |
| Fieldbus interface | 2x M12x1 socket, 4-pin, D-coded | | |
| Baud rate | [Mbit/s] | 100 | |
| Max. address capacity, inputs | [byte] | 64 | |
| Max. address capacity, outputs | [byte] | 64 | |
| LED displays | (bus-specific) | Error = Communication error L/A1 = Network active port 1 L/A2 = Network active port 2 Run = Communication status | |
| | (product-specific) | M = Modify, parameterisation PL = Load supply PS = Electronic supply, sensor supply SF = System fault | |
| Device-specific diagnostics | <ul style="list-style-type: none"> Channel and module-oriented diagnostics Undervoltage of modules Diagnostic memory | | |
| Configuration support | XML file | | |
| Parameterisation | <ul style="list-style-type: none"> System parameters Diagnostic behaviour Signal setup Fail-safe response Forcing of channels | | |
| Additional functions | <ul style="list-style-type: none"> System status can be represented using process data Additional diagnostic interface for operator units | | |
| Control elements | DIL switch | | |
| Operating voltage | Nominal value | [V DC] | 24 |
| | Permissible range | [V DC] | 18 ... 30 |
| | Power failure buffering | [ms] | 10 |
| Current consumption | [mA] | | Typically 100 |
| Protection class to EN 60529 | IP65, IP67 | | |
| Temperature range | Operation | [°C] | -5 ... +50 |
| | Storage/transport | [°C] | -20 ... +70 |
| Materials | Housing | Reinforced PA | |
| Grid dimension | [mm] | 50 | |
| Dimensions (incl. interlinking block) W x L x H | [mm] | 50 x 107 x 50 | |
| Weight | [g] | 125 | |

 Note

Please observe the general limits and guidelines for the system when configuring the electrical modules.

 Note

Always use screws appropriate to the interlinking block (metal or plastic):

- Self-tapping screws for plastic interlinking blocks

- Screws with metric thread for metal interlinking blocks

Terminal CPX

Technical data – Bus node CPX-FB38

Connection and display components

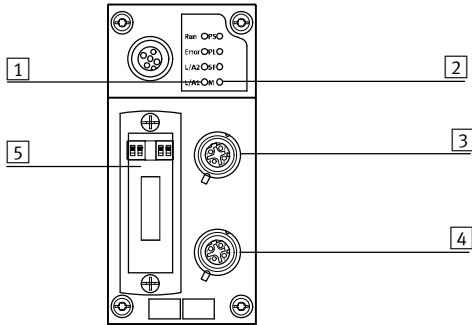

- 1 Bus-specific status LEDs
- 2 CPX-specific status LEDs
- 3 Fieldbus connection, output
(4-pin socket M12x1, D-coded)
- 4 Fieldbus connection, input
(4-pin socket M12x1, D-coded)
- 5 Transparent DIL switch cover



Pin allocation for the fieldbus interface

| Pin allocation | Pin | Signal | Designation |
|-----------------------|---------|--------|-------------------|
| M12x1 socket, D-coded | | | |
| | 1 | TD+ | Transmitted data+ |
| | 2 | RD+ | Received data+ |
| | 3 | TD- | Transmitted data- |
| | 4 | RD- | Received data- |
| | Housing | | |

Terminal CPX

Accessories – Bus node CPX-FB38

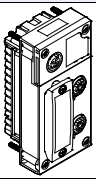
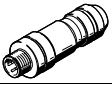
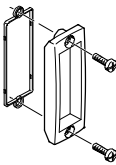

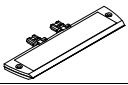
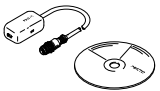
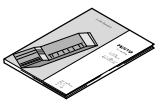
| Ordering data | | | |
|---|---|---------------|--------------------------------|
| Designation | | Part No. | Type |
| Bus node | | | |
|  | EtherCAT bus node | 552046 | CPX-FB38 |
| Bus connection | | | |
|  | M12x1 plug, 4-pin, D-coded | 543109 | NECU-M-S-D12G4-C2-ET |
|  | Inspection cover, transparent | 533334 | AK-SUB-9/15-B |
|  | Cover cap for sealing unused bus connections (10 pieces) | 165592 | ISK-M12 |
|  | Inscription label holder for connection block | 536593 | CPX-ST-1 |
|  | Adapter from 5-pin M12 to mini USB socket and controller software | 547432 | NEFC-M12G5-0.3-U1G5 |
| User manual | | | |
|  | Electronics manual, CPX bus node, type CPX-FB38 | German | 562524 P.BE-CPX-FB38-DE |
| | | English | 562525 P.BE-CPX-FB38-EN |
| | | Spanish | 562526 P.BE-CPX-FB38-ES |
| | | French | 562527 P.BE-CPX-FB38-FR |
| | | Italian | 562528 P.BE-CPX-FB38-IT |

Terminal CPX

Technical data – Bus node CPX-FB39

← Sercos →

IT services:

← Web →

Bus node for handling communication between the electrical CPX terminal and the Sercos III network.

The bus node is provided with system supply via the interlinking block and processes communication with the I/O modules.

The status of the CPX terminal is displayed as a common message via 4 CPX-specific LEDs.



Application
Bus connection

The bus connection is established via two M12x1 plug connectors, D-coded to IEC947-5-2 with degree of protection to IP65, IP67. The connections are equipped with automatic detection for the incoming and outgoing connection.

The Sercos III bus node can be used to connect the CPX valve terminal to the standardised Sercos III bus. Sercos II uses the Ethernet standard (IEEE802.3) and TCP/IP technology for communication in an industrial

environment. Industry-compatible Sercos III devices enable data to be exchanged with a higher data transmission rate, such as data from sensors, actuators or controllers. You can also transmit

information that is not real-time critical, such as diagnostics or configuration information.

Web servers

In addition to activation via a bus system, it is possible to use IT

technologies. An integrated web server enables diagnostic data to be

visualised via HTML. Various programs support direct access to the device

data from the automation network.

Points to note in connection with CPX-FEC/CPX-CEC

The CPX-FB39 supports the operating modes remote I/O and remote controller. In remote I/O operating mode, all functions of the CPX valve terminal are directly controlled by the Sercos controller.

When a bus node is combined with a control block (CPX-FEC, CPX-CEC, in the fieldbus remote controller operating mode), the connected I/Os and/or valves, sensors and actuators are controlled via the CPX control block. In this case, the bus node only

provides the communication interface to the PLC. Communication between the control block and CPX bus node takes place by interlinking the CPX modules and takes up the following address capacity in the CPX system:

- 8/16 byte outputs
 - 8/16 byte inputs
- The following address capacity remains in the control block or CPX system for activating the peripherals:
- 56/48 byte inputs
 - 56/48 byte outputs

Terminal CPX

Technical data – Bus node CPX-FB39

| General technical data | | | |
|---|-------------------|---|---|
| Type | | CPX-FB39 | |
| Fieldbus interface | | 2x M12x1 socket, D-coded, 4-pin | |
| Baud rates | | [Mbps] | 100 full/half duplex |
| Protocol | | Sercos III | |
| Max. address capacity | Inputs | [byte] | 64 |
| | Outputs | [byte] | 64 |
| LED displays | Bus-specific | | S = Sercos LED SD = Sercos sub-device LED TP1 = Network active port 1 TP2 = Network active port 2 |
| | Product-specific | | M = Modify, parameterisation PL = Load supply PS = Electronics supply, sensor supply SF = System fault |
| Device-specific diagnostics | | <ul style="list-style-type: none"> Module and channel-oriented diagnostics Undervoltage of modules Diagnostic memory | |
| Configuration support | | SDDML file | |
| Parameterisation | | <ul style="list-style-type: none"> Diagnostic behaviour Fallback output data Forcing of channels Signal setup System parameters | |
| Additional functions | | <ul style="list-style-type: none"> Acyclic and cyclic data access via Sercos IP addressing via Sercos parameters or operator unit Channel-oriented diagnostics via fieldbus Start-up parameterisation in plain text via fieldbus System status can be displayed using process data Additional diagnostic interface for operator units | |
| Control elements | | DIL switches | |
| Operating voltage | Nominal value | [V DC] | 24 |
| | Permissible range | [V DC] | 18 ... 30 |
| Current consumption (at nominal voltage, without MMI) | | [mA] | Typically 100 |
| Degree of protection to EN 60529 | | IP65, IP67 | |
| Temperature range | Operation | [°C] | - 5 ... +50 |
| | Storage/transport | [°C] | -20 ... +70 |
| Materials | | PA reinforced | |
| Note on materials | | RoHS compliant | |
| Grid dimension | | [mm] | 50 |
| Dimensions (incl. interlinking block) W x L x H | | [mm] | 50 x 107 x 50 |
| Product weight | | [g] | 125 |

 Note

Please observe the general limits and guidelines for the system when configuring the electrical modules.

Terminal CPX

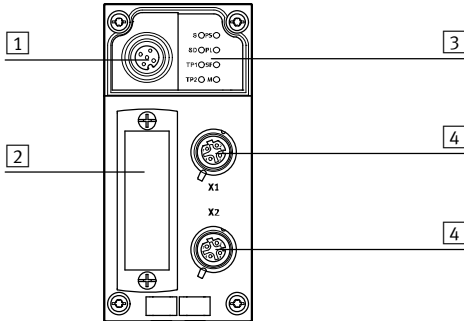

Technical data – Bus node CPX-FB39

Connection and display components





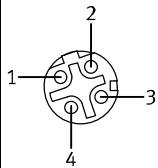

- 1 Service interface for operator unit CPX-MMI or PC with CPX maintenance tool NEFC-M12G5-Q3-U1G5
- 2 Transparent DIL switch cover
- 3 Status LED, bus-specific and CPX-specific
- 4 Fieldbus connection (M12x1 socket, 4-pin, D-coded)

Pin allocation for the fieldbus interface

| Terminal allocation | Pin | Signal | Designation |
|--|---------|--------|-------------------|
| M12x1 socket, D-coded | | | |
|  | 1 | TD+ | Transmitted data+ |
| | 2 | RD+ | Received data+ |
| | 3 | TD- | Transmitted data- |
| | 4 | RD- | Received data- |
| | Housing | FE | Screening |
|  Note The CPX-FB39 has the capability for auto-matic detection of transmit and receive cables (Auto-MDI/MDI-X Auto-Crossover). RD and TD signal pairs are automatically swapped if required. | | | |

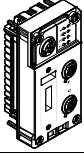
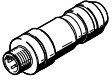
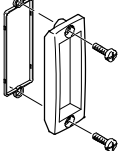
Terminal CPX

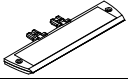
Accessories – Bus node CPX-FB39

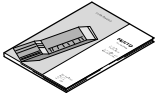
| Ordering data | | | |
|---|--|----------------|---------------------------------|
| Description | Part No. | Type | |
| Bus node | | | |
|  | Ethernet Sercos III bus node | 2093101 | CPX-FB39 |
| Bus connection | | | |
|  | Plug connector M12x1, 4-pin, D-coded | 543109 | NECU-M-S-D12G4-C2-ET |
|  | Inspection cover, transparent | 533334 | AK-SUB-9/15-B |
|  | Cover cap for sealing unused bus connections (10 pieces) | 165592 | ISK-M12 |
|  | Inscription label holder for connection block | 536593 | CPX-ST-1 |
|  | 5-pin M12 to mini USB socket adapter and controller software | 547432 | NEFC-M12G5-03-U1G5 |
| User Documentation | | | |
|  | User Documentation for bus node CPX-FB39 | German | 8028632 P.BE-CPX-FB39-DE |
| | | English | 8028633 P.BE-CPX-FB39-EN |
| | | Spanish | 8028634 P.BE-CPX-FB39-ES |
| | | French | 8028635 P.BE-CPX-FB39-FR |
| | | Italian | 8028636 P.BE-CPX-FB39-IT |
| | | Chinese | 8028637 P.BE-CPX-FB39-ZH |

Terminal CPX

Technical data – Bus node CPX-FB40

← Ethernet POWERLINK →

IT services:

← Web →

Bus node for handling communication between the electrical CPX terminal and the Ethernet POWERLINK network. The bus node is provided with system supply via the interlinking block and processes communication with the I/O modules. The status of the CPX terminal is displayed as a common message via 4 CPX-specific LEDs.



Application
Bus connection

| | | | |
|--|--|--|--|
| <p>The bus connection is established via an M12x1 plug connector, D-coded to IEC947-5-2 with degree of protection to IP65, IP67.</p> | <p>Ethernet POWERLINK uses the Ethernet standards and TCP/IP technology (IEEE802.3) for communication in an industrial environment and integrates all CANopen mechanisms. It includes all the key features of standard Ethernet, including</p> | <p>internode communication, hotplug capability and free selection of network topology. Ethernet POWERLINK fulfils the real-time requirements using a mix of timeslot and polling procedures. In other words, defined times are</p> | <p>reserved on the Ethernet lines exclusively for transferring real-time data. Only network participants which have previously been polled by the controller are able to transmit data during these timeslots.</p> |
|--|--|--|--|

Ethernet POWERLINK implementation

| | | | |
|---|---|--|---|
| <p>The CPX-FB40 supports the two operating modes: remote I/O and remote controller. In remote I/O operating mode, all functions of the CPX valve terminal are</p> | <p>directly controlled by the Ethernet POWERLINK master (host). In addition to activation via a bus system, it is possible to use IT technologies. An integrated web server enables</p> | <p>diagnostic data to be visualised via HTML. Various programs support direct access to the device data from the automation network.</p> | <p>The Ethernet POWERLINK node for CPX supports the transmission technology that conforms to DIN EN 50173/CAT 5 as an integrated interface.</p> |
|---|---|--|---|

Points to note in connection with CPX-FEC/CPX-CEC

| | | | |
|---|--|---|--|
| <p>When a bus node is combined with a control block (CPX-FEC, CPX-CEC, in the fieldbus remote controller operating mode), the connected I/Os and/or valves, sensors and actuators are controlled via the CPX control block.</p> | <p>In this case, the bus node only provides the communication interface to the PLC. Communication between the control block and CPX bus node takes place</p> | <p>by interlinking the CPX modules and takes up the following address capacity in the CPX system:</p> <ul style="list-style-type: none"> • 8 byte outputs • 8 byte inputs | <p>The following address capacity remains in the control block or CPX system for activating the peripherals:</p> <ul style="list-style-type: none"> • 56 byte inputs • 56 byte outputs |
|---|--|---|--|

Terminal CPX

Technical data – Bus node CPX-FB40

| General technical data | | | |
|---|---------------------------------------|---|--|
| Type | | CPX-FB40 | |
| Fieldbus interface | | 2x M12x1 socket, D-coded, 4-pin | |
| Baud rates | | [Mbps] | 100 |
| Protocol | | Ethernet POWERLINK V2 | |
| Max. address capacity | Inputs | [byte] | 64 |
| | Outputs | [byte] | 64 |
| LED displays | Bus-specific | | BE = POWERLINK error BS = POWERLINK status L/A1 = Link/activity port 1 L/A2 = Link/activity port 2 |
| | Product-specific | | M = Modify, parameterisation PL = Load supply PS = Electronic supply, sensor supply SF = System fault |
| Device-specific diagnostics | | <ul style="list-style-type: none"> Module and channel-oriented diagnostics Undervoltage of modules Diagnostic memory | |
| Configuration support | | <ul style="list-style-type: none"> XDC file XDD file | |
| Parameterisation | | <ul style="list-style-type: none"> Diagnostic behaviour Fail-safe response Forcing of channels Signal setup System parameters | |
| Additional functions | | <ul style="list-style-type: none"> Acyclic data access via "SDO" and Ethernet Integrated hub IP addressing via DHCP, DIL switch or operator unit Channel-oriented diagnostics via fieldbus Start-up parameterisation in plain text via fieldbus System status can be displayed using process data Additional diagnostic interface for operator units | |
| Control elements | | DIL switches | |
| Operating voltage | Nominal value | [V DC] | 24 |
| | Permissible range | [V DC] | 18 ... 30 |
| | Protection against incorrect polarity | | For operating voltage |
| Current consumption (at nominal voltage, without MMI) | | [mA] | Typically 100 |
| Degree of protection to EN 60529 | | IP65, IP67 | |
| Temperature range | Operation | [°C] | -5 ... +50 |
| | Storage/transport | [°C] | -20 ... +70 |
| Materials | | PA reinforced | |
| Note on materials | | RoHS-compliant | |
| Grid dimension | | [mm] | 50 |
| Dimensions (incl. interlinking block) W x L x H | | [mm] | 50 x 107 x 50 |
| Product weight | | [g] | 125 |

 **Note**

Please observe the general limits and guidelines for the system when configuring the electrical modules.

Terminal CPX

Technical data – Bus node CPX-FB40

Connection and display components

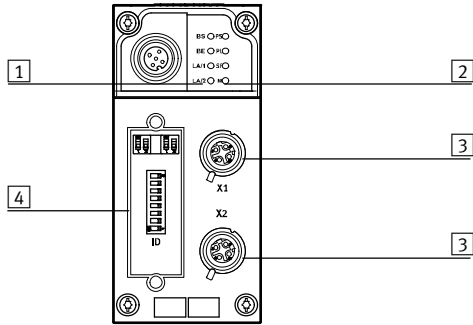

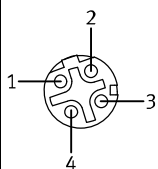

- 1 Bus-specific status LEDs
- 2 CPX-specific status LEDs
- 3 Fieldbus connection (M12x1 socket, 4-pin, D-coded)
- 4 Transparent DIL switch cover

Pin allocation for the fieldbus interface

| Terminal allocation | Pin | Signal | Designation |
|---|---------|--------|-------------------|
| M12x1 socket, D-coded | | | |
|  | 1 | TD+ | Transmitted data+ |
| | 2 | RD+ | Received data+ |
| | 3 | TD- | Transmitted data- |
| | 4 | RD- | Received data- |
| | Housing | FE | Screening |

Terminal CPX

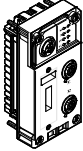
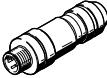
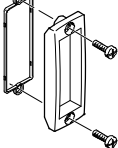
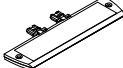
Accessories – Bus node CPX-FB40

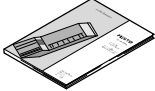
| Ordering data | | | | |
|---|---|----------------|-----------------------------|-------------------------|
| Description | | Part No. | Type | |
| Bus node | | | | |
|  | Ethernet POWERLINK bus node | 2474896 | CPX-FB40 | |
| Bus connection | | | | |
|  | M12x1 plug connector, 4-pin, D-coded | 543109 | NECU-M-S-D12G4-C2-ET | |
|  | Inspection cover, transparent | 533334 | AK-SUB-9/15-B | |
|  | Inscription label holder for connection block | 536593 | CPX-ST-1 | |
|  | 5-pin M12 adapter for mini USB socket and controller software | 547432 | NEFC-M12G5-03-U1G5 | |
| User documentation | | | | |
|  | User documentation for bus node CPX-FB40 | German | 8028650 | P.BE-CPX-FB40-DE |
| | | English | 8028651 | P.BE-CPX-FB40-EN |
| | | Spanish | 8028652 | P.BE-CPX-FB40-ES |
| | | French | 8028653 | P.BE-CPX-FB40-FR |
| | | Italian | 8028654 | P.BE-CPX-FB40-IT |
| | | Chinese | 8028655 | P.BE-CPX-FB40-ZH |

Terminal CPX

Technical data – CPX-CP interface

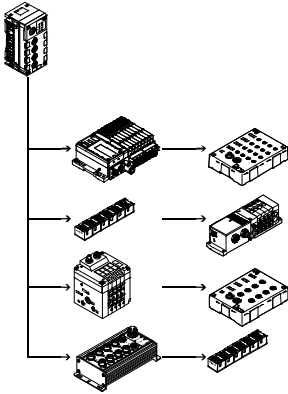

The CPX-CP electrical interface establishes the connection to CP modules of the CPI installation system via prefabricated connecting cables. The I/O data of the connected valve terminals with CP string extension and CP input and output modules are transferred to the connected CPX bus node and thus via fieldbus to the higher-order controller. This enables modular centralised and compact decentralised concepts to be established with one system. The CP electrical interface is supported by all CPX bus nodes and the CPX-FEC.



Application

CP connection

As well as transmitting the communication data, the max. four CP strings of a CPX-CP interface also transmit the supply voltage to the connected sensors and the load supply to the valves (or outputs). Both circuits are

supplied separately with 24 V, but with a common reference potential. The valve terminals with CP string extension (or outputs) are supplied with voltage for the electronics and valves by the interlinking block.

The following combinations are made possible by the CP interface:

- Centralised analogue and digital inputs and outputs of the CPX terminal
- Decentralised digital inputs and outputs of the CP installation system
- Valve/valve terminals that can be connected both centrally and decentrally

Configuration example – CP interface with CP modules

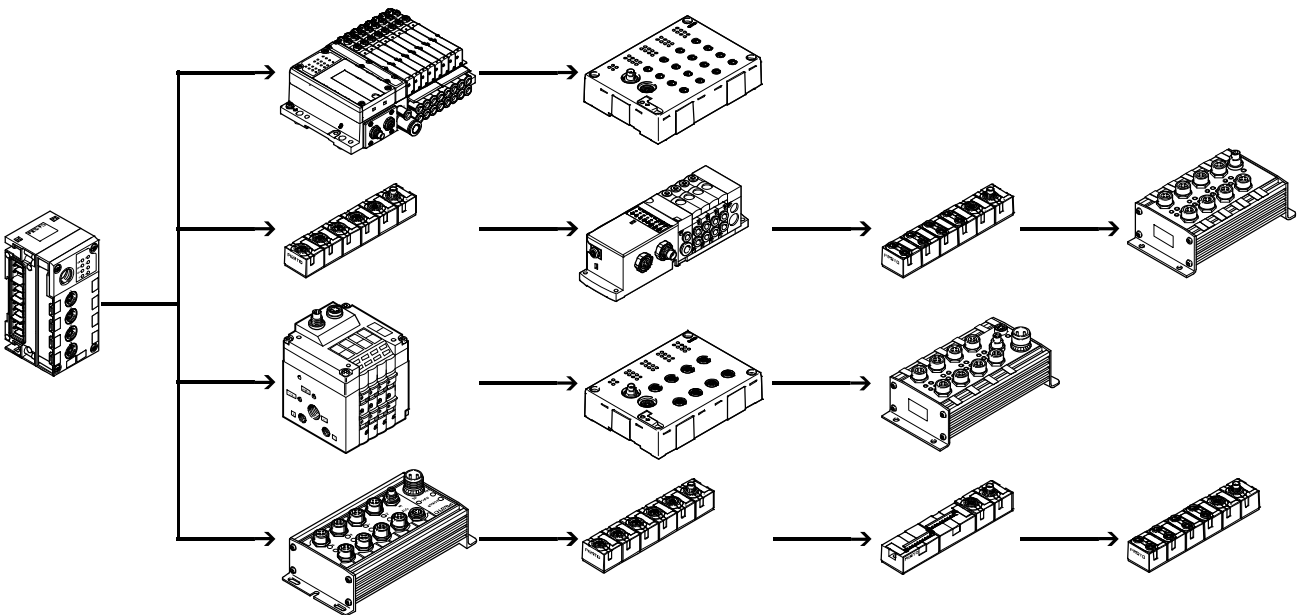

Terminal CPX

Technical data – CPX-CP interface

Implementation

The CPX-CP interface supports the CPI system:

- Max. 4 individual electronically protected CP strings
- Max. 4 CP modules per string
- Max. 32 inputs/32 outputs per string
- The maximum length of a string is 10 m. If the CP interface is positioned centrally, the CP system can cover an area of 20 m in diameter
- Modules with CPI functionality

The following CP module variants are available:

- Input modules with 8 or 16 digital inputs (connection technology M8, M12 and CageClamp)
- Output modules with 4 or 8 digital outputs (connection technology M12)
- Valve terminals with CP string extension (up to 32 solenoid coils, different valve functions)

CPI modules support the following functions:

- Module-oriented diagnostics
- Module/channel-oriented parameterisation
- Support for all functions by the CPX-MMI or CPX-FMT operator unit
- Module can be positioned anywhere within the string

Several CP interface modules can be combined in one CPX terminal, depending on the address capacity of the bus node.

Example:

- CPX-FB13 (512 I/O)
- Max. 4 CP interface modules (128 I/O each) possible



Note

When arranging the CP modules it should be taken into consideration that CP input modules without CPI functionality should always be placed at the end of a string.

Configuration

The following rules apply for a string of a CPX-CP interface:

- Max. one output module or one valve terminal without CPI functionality
- Max. one output module without CPI functionality or one valve terminal with CP string extension
- Any number of CP modules with CPI functionality, up to the maximum limit of 4 modules and/ or 32 inputs/32 outputs per string

Maximum extension:

- 4 input modules and 4 valve terminals/output modules without CPI functionality
- 16 CP modules with CPI functionality

The configuration of the strings with respect to the module type and position of the modules in the string is entered by activating the SAVE key in the CPX-CP interface and saved there permanently.

Saved data are retained even when the CP interface is isolated from the voltage supply.

The representation of the CP interface within a CPX terminal and thus at the fieldbus is dependent on the characteristics of the relevant fieldbus system. In addition to input and output addressing, this also applies to the representation of the diagnostics and parameterisation of the CP module and the characteristics of the CPI system.

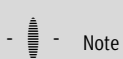

Note

The remanent saving of configuration data means that changes in the configuration or faulty modules are still displayed even after a voltage failure.

Terminal CPX

Technical data – CPX-CP interface

FESTO

| General technical data | | | |
|---|--------------------------------------|--|---------------------------------|
| Type | | CPX-CP-4-FB | |
| Brief description | | CP interface | |
| Max. number of | CP strings | 4 | |
| | CP modules per string | 4 | |
| | Outputs per string | 32 | |
| | Inputs per string | 32 | |
| CP connection | | M9 socket, 5-pin | |
| Baud rate | | [kbit/s] | 1,000 |
| Cycle time | CP modules without CPI functionality | [ms] | 4 |
| | CP modules with CPI functionality | [ms] | 2 |
| LED displays | | L1 ... 4 = Status of the CP string 1 ... 4 PS = Electronic supply, sensor supply PL = Load supply RN = Status of the CP system SF = System fault | |
| Device-specific diagnostics | | Via bus node | |
| Operating voltage | Nominal value | [V DC] | 24 (reverse polarity protected) |
| | Permissible range | [V DC] | 18 ... 30 |
| | Power failure buffering | [ms] | 20 |
| Supply voltage of sensors | | [V DC] | 24 ±25% coming from bus node |
| Load voltage of actuators | | [V DC] | 24 ±10% coming from bus node |
| Current consumption | Without CP modules | [A] | Max. 0.2 |
| | Per CP string | [A] | Max. 1.6 |
| Protection class to EN 60529 | | IP65, IP67 | |
| Temperature range | Operation | [°C] | -5 ... +50 |
| | Storage/transport | [°C] | -20 ... +70 |
| Materials | | PA | |
| Grid dimension | | [mm] | 50 |
| Dimensions (incl. interlinking block) W x L x H | | [mm] | 50 x 107 x 45 |
| Weight | | [g] | 140 |

-  - Note

Please observe the general limits and guidelines for the system when configuring the electrical modules.

Terminal CPX

Accessories CPX-CP interface

Connection and display components

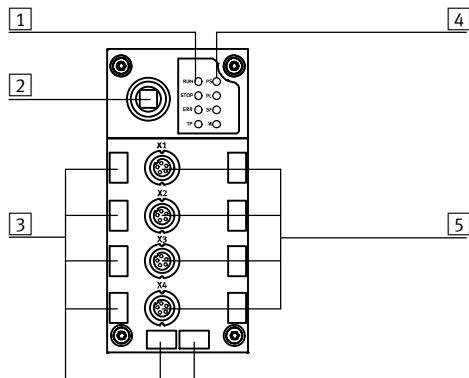

- 1 CP string LEDs
- 2 SAVE key
- 3 Holders for inscription labels (IBS 6x10)
- 4 CPX-specific status LEDs
- 5 CP connections for up to 4 strings (0 ... 3)

Power supply

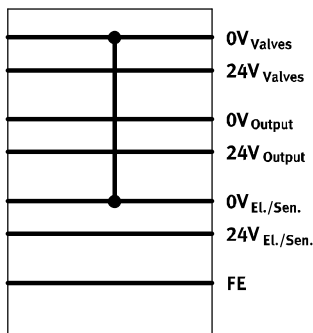







The module combines the 0 V potential of the power supply for electronics and sensors with the 0 V potential of the power supply for valves.

If all poles of the valves of a pneumatic interface connected to the right of the CP interface are to be switched off, an appropriate interlinking block with additional power supply must be used to the right of the CP interface.

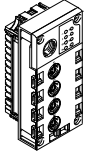
Terminal CPX

Accessories CPX-CP interface

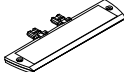
FESTO

| Ordering data | | | | |
|---|---|---------|---------------|----------------------------|
| Designation | | | Part No. | Type |
| CP interface | | | | |
|  | Interface for max. 16 I/O modules and valve terminals of the CPI system | | 526705 | CPX-CP-4-FB |
| Bus connection | | | | |
|  | Cover cap | M12 | 165592 | ISK-M12 |
|  | Connecting cable, angled plug, angled socket | 0.25 m | 540327 | KVI-CP-3-WS-WD-0,25 |
| | | 0.5 m | 540328 | KVI-CP-3-WS-WD-0,5 |
| | | 2 m | 540329 | KVI-CP-3-WS-WD-2 |
| | | 5 m | 540330 | KVI-CP-3-WS-WD-5 |
| | | 8 m | 540331 | KVI-CP-3-WS-WD-8 |
|  | Connecting cable, straight plug, straight socket | 2 m | 540332 | KVI-CP-3-GS-GD-2 |
| | | 5 m | 540333 | KVI-CP-3-GS-GD-5 |
| | | 8 m | 540334 | KVI-CP-3-GS-GD-8 |
|  | Inscription label holder for connection block | | 536593 | CPX-ST-1 |
| User manual | | | | |
|  | User manual for CPX-CP interface | German | 539293 | P.BE-CPX-CP-DE |
| | | English | 539294 | P.BE-CPX-CP-EN |
| | | Spanish | 539295 | P.BE-CPX-CP-ES |
| | | French | 539296 | P.BE-CPX-CP-FR |
| | | Italian | 539297 | P.BE-CPX-CP-IT |

Terminal CPX

Technical data – Interface CPX-CTEL

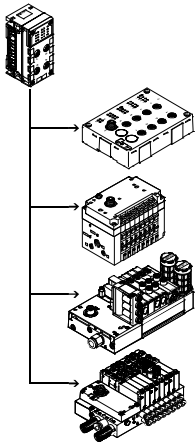

The electrical interface CPX-CTEL master establishes the connection to modules with I-Port interface (device) from the CTEL/CTEU series. The I/O data from the connected devices is transferred to the connected CPX bus node and therefore transferred to the higher-level controller via fieldbus. A maximum of 4 devices can be connected to a CPX-CTEL master via appropriate M12- interfaces.



Application

I-Port interface

As well as transmitting the communication data, the I-Port interfaces of a CPX-CTEL master also transmit the power supply for the

connected sensors and the load supply for the valves (or outputs). Both circuits are supplied separately

with 24 V, with a separate reference potential. The connecting cables used must

meet the increased requirements resulting from their double function as a signal line and power supply cable.

Sample configuration – CPX-CTEL master with CTEL modules

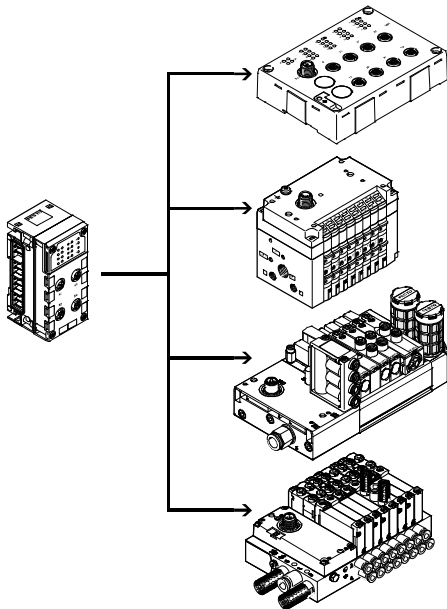

The CPX-CTEL master provides four I-Port interfaces to which one device each can be connected. I-Port is an interface for exchanging serial data for connecting decentralised modules or valve terminals from Festo. The I-Port interface is based on IO-Link and is compatible with it in certain areas. The connection type corresponds to a star topology. In other words, only one module or valve terminal can be connected to each I-Port.

The restrictions compared to IO-Link include:

- Permanently set baud rate of 230.4 kbit/s
- SIO mode is not supported
- Max. 32 bytes of input data and 32 bytes of output data
- Only one dump of the master commands is used
- Configuration via IODD is not supported

Terminal CPX

Technical data – Interface CPX-CTEL

Implementation

| | | | |
|---|---|---|---|
| <p>The CPX-CTEL master from Festo enables modules with an I-Port interface to be connected to a CPX system:</p> <ul style="list-style-type: none"> • Max. 4 devices with individual electronic fuse protection • Max. 64 inputs/64 outputs per I-Port interface • The maximum length of a string is 20 m | <p>The following device variants are available:</p> <ul style="list-style-type: none"> • Input modules with 16 digital inputs (3-pin M8 and 5-pin M12 connection technology) • Valve terminals with I-Port interface (up to 48 solenoid coils, different valve functions) | <p>The decentralised arrangement of the modules and valve terminals with I-Port enables them to be mounted near the cylinders and actuators/sensors to be controlled. This allows the use of shorter air supply lines and sensor connecting cables or possibly smaller valves, which saves costs.</p> | <p>Several CPX-CTEL masters can be combined in one CPX terminal, depending on the address capacity of the bus node.</p> <p>Example:</p> <ul style="list-style-type: none"> • CPX-FB13 (512 I/O) • Max. 2 CPX-CTEL masters (256 I/O each) possible |
|---|---|---|---|

Configuration

| Setting | Manual configuration | Automatic configuration |
|--|---|--|
| <p>The precise number of I/O bytes made available is geared towards the requirements of the connected devices and the selected operating mode.</p> <p>The operating mode and configuration presetting of the CPX-CTEL master can be defined by the user.</p> <p>DIL switches are used for selecting the operating mode and making the setting for manual configuration. These DIL switches are not required during operation and are only accessible in unassembled condition.</p> | <p>With manual configuration (tool change mode), the number of inputs and outputs in the process image of the CPX system or higher-level fieldbus can be manually defined via the DIL switches.</p> | <p>The process image then always has the same number of bytes, regardless of the connected devices. The defined I/O length always applies to all four I-Ports (max. 8 bytes per I-Port).</p> |

Power supply for I-Port devices

| | | | |
|--|--|--|--|
| <p>The CPX-CTEL master provides two separate power supplies for the connected devices:</p> <ul style="list-style-type: none"> • One for operating the device and the inputs connected to it • One for outputs and valves connected to the device | <p>The power supply for devices and inputs comes from the power supply for the electronics and sensors of the CPX terminal.</p> <p>The power supply for outputs and valves comes from the power supply</p> | <p>for the valves of the CPX terminal. The interlinking block with additional power supply enables a separate voltage supply for valves and outputs. This allows this supply voltage to be</p> | <p>switched off separately. In other words, the valves and outputs of the connected I-Port devices can be switched off separately without having to switch off the devices themselves.</p> |
|--|--|--|--|

Terminal CPX

Technical data – Interface CPX-CTEL

| General technical data | | | |
|--|-------------------------|--|---------------------------------|
| Type | | CPX-CTEL-4-M12-5POL | |
| Protocol | | I-Port | |
| Max. address capacity | Outputs | [bit] | 256 |
| | Inputs | [bit] | 256 |
| I-Port connection | | 4x M12 socket, 5-pin, A-coded | |
| Number of I-Port interfaces | | 4 | |
| Max. cable length | | [m] | 20 |
| Internal cycle time | | [ms] | 1 per 8 bits of user data |
| Electrical isolation | Channel – channel | No | |
| | Channel – internal bus | Yes, using an intermediate supply | |
| LED displays | | X1 ... 4 = Status of the I-Port interface 1 ... 4 PS = Electronics supply PL = Load supply - L - = Module fault | |
| Diagnostics | | <ul style="list-style-type: none"> • Communication error • Module short circuit • Module-oriented diagnostics • Undervoltage | |
| Parameterisation | | <ul style="list-style-type: none"> • Diagnostic behaviour • Failsafe per channel • Forces per channel • Idle mode per channel • Module parameters • Tool change mode | |
| Additional functions | | Tool change mode | |
| Operating elements | | DIL switch | |
| Operating voltage | Nominal value | [V DC] | 24 (reverse polarity protected) |
| | Permissible range | [V DC] | 18 ... 30 |
| | Power failure buffering | [ms] | 10 |
| Intrinsic current consumption at nominal operating voltage | | [mA] | Typically 65 |
| Max. power supply per channel | | [A] | 4x 1.6 |
| Max. residual output current per channel | | [A] | 4x 1.6 |
| Protection class to EN 60529 | | IP65, IP67 | |
| Temperature range | Operating | [°C] | -5 ... +50 |
| | Storage/transport | [°C] | -20 ... +70 |
| Materials | | PA reinforced, PC | |
| Note on materials | | RoHS-compliant | |
| Grid dimension | | [mm] | 50 |
| Dimensions (incl. interlinking block) W x L x H | | [mm] | 50 x 107 x 55 |
| Product weight | | [g] | 110 |

 Note

Please observe the general limits and guidelines for the system when configuring the electrical modules.

Terminal CPX

Technical data – Interface CPX-CTEL

Connection and display components

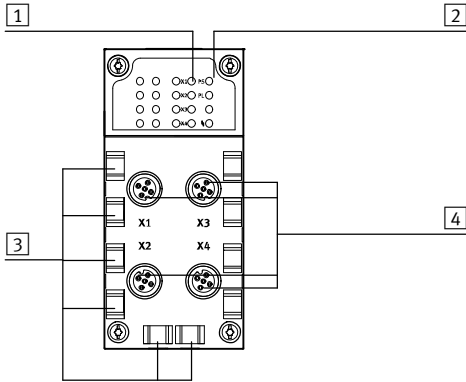

- 1 Status LEDs for I-Port interfaces
- 2 CPX-specific status LEDs
- 3 Holders for inscription labels (IBS 6x10)
- 4 I-Port interfaces for up to 4 devices

Pin allocation – I-Port interface

| Pin allocation | Pin | Signal | Designation |
|----------------|-----|-----------------------|--|
| | 1 | 24 V _{SEN} | 24 V DC supply voltage for electronics and inputs |
| | 2 | 24 V _{VAL} | 24 V DC load voltage supply for valves and outputs |
| | 3 | 0 V _{SEN} | 0 V DC supply voltage for electronics and sensors |
| | 4 | C/Q _{I-Port} | Communication signal C/Q, data cable |
| | 5 | 0 V _{VALVES} | 0 V DC load voltage supply for valves and outputs |

Dimensions



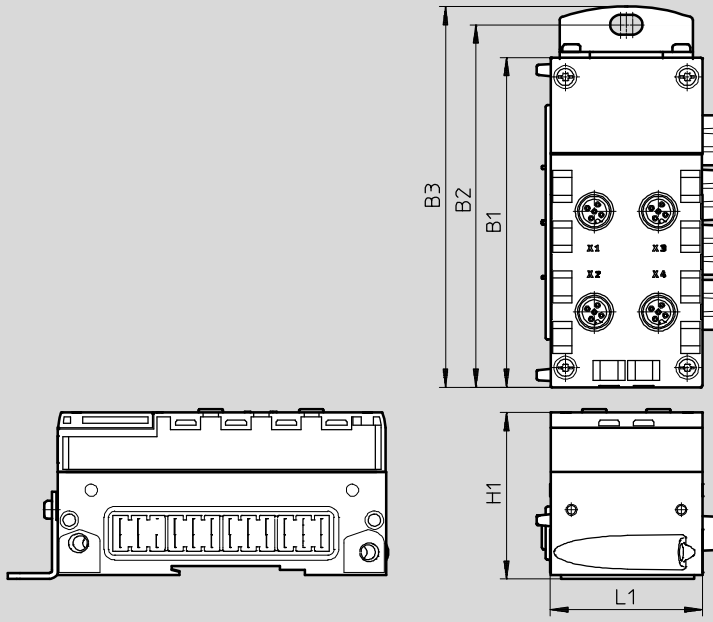

Download CAD data → www.festo.com

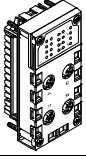

| Type | B1 | B2 | B3 | H1 | L1 |
|---------------------|-------|-------|-------|------|----|
| CPX-CTEL-4-M12-5POL | 108.1 | 118.9 | 124.9 | 55.1 | 50 |

Terminal CPX

Accessories – Interface CPX-CTEL

| Ordering data | | | | |
|---|--|---------|----------------|-----------------------------------|
| Designation | | | Part No. | Type |
| CPX-CTEL master | | | | |
|  | Interface for max. 4 I/O modules and valve terminals with I-Port interface (devices) | | 1577012 | CPX-CTEL-4-M12-5POL |
| Bus connection | | | | |
|  | Cover cap | M12 | 165592 | ISK-M12 |
|  | Inscription label holder for manifold block | | 536593 | CPX-ST-1 |
| Connecting cable | | | | |
|  | - | | 574321 | NEBU-M12G5-E-5-Q8N-M12G5 |
| | | | 574322 | NEBU-M12G5-E-7.5-Q8N-M12G5 |
| | | | 574323 | NEBU-M12G5-E-10-Q8N-M12G5 |
| Manual | | | | |
|  | Manual CPX-CTEL master | German | 574600 | P.BE-CPX-CTEL-DE |
| | | English | 574601 | P.BE-CPX-CTEL-EN |
| | | Spanish | 574602 | P.BE-CPX-CTEL-ES |
| | | French | 574603 | P.BE-CPX-CTEL-FR |
| | | Italian | 574604 | P.BE-CPX-CTEL-IT |

Terminal CPX

Technical data – Interface CPX-CTEL-2

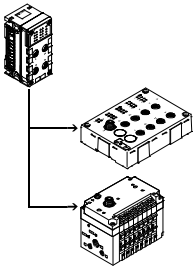

The electrical interface CPX-CTEL-2... enables the connection of modules with IO-Link interface (IO-Link device) to the CPX terminal. The I/O data of the connected devices are transmitted to the connected CPX bus node and thus to the higher-order controller via fieldbus.

A maximum of two IO-Link devices can be connected to an electrical interface CPX-CTEL-2... via the corresponding M12 interfaces.



Application

IO-Link interface

The communication system IO-Link is used to exchange serial data from decentralised function modules (devices) at the field level. The electrical interface CPX-CTEL-2... provides two IO-Link interfaces to the outside, on each of which one device

can be connected. The connection type corresponds to a star topology, which means that only one device can be connected to each port. The address space that the module

makes available and assigns accordingly in the CPX system can be configured according to various presettings. Selection of the operating mode and the setting for manual configuration

takes place via the DIL switches. These DIL switches are not required during continuous operation and are only accessible in the disassembled state.

Restrictions

The interfaces (ports) of electrical interface CPX-CTEL-2... support the connection of IO-Link devices with few limitations.

- The process data length of the inputs and outputs is limited to 16 bytes per port for inputs and outputs

- The driver strength on the C/Q line is limited to 250 mA

- SIO mode is not supported

Power supply for devices

The electrical interface CPX-CTEL-2... provides two separate power supplies for the connected devices:

- For the operation of the device and the inputs connected to it
- For the outputs and valves that are connected to the device

The power supply for the devices and the inputs is supplied by the power supply for the electronics and sensors of the CPX terminal. The power supply for the outputs and valves is supplied by the power supply

for the valves of the CPX terminal. The interlinking block with additional supply ensures a separate the supply voltage for the valves and outputs. This means it is possible to disconnect this supply voltage

separately. The valves and outputs of the connected I-Port devices can therefore be disconnected separately without disconnecting the devices.

Terminal CPX

Technical data – Interface CPX-CTEL-2

| General technical data | | | |
|--|-------------------------|---|---------------------------|
| Type | | CPX-CTEL-2-M12-5POL-LK | |
| Protocol | | IO-Link, master version V 1.0 | |
| Max. address capacity | Outputs | [bit] | 256 |
| | Inputs | [bit] | 256 |
| I-Port connection | | 2x socket M12, 5-pin, A-coded | |
| Number of IO-Link interfaces | | 2 | |
| Max. cable length | | [m] | 20 |
| Internal cycle time | | [ms] | 1 per 8 bits of user data |
| Electrical isolation | Channel – channel | No | |
| | Channel – internal bus | Yes, using an intermediate supply | |
| LED displays | | X1 ... 2 = status of the IO-Link interface 1 ... 2 PS = Electronic supply PL = Load supply  = Module error | |
| Diagnostics | | <ul style="list-style-type: none"> • Communication error • Module short circuit • Module-oriented diagnostics • Undervoltage | |
| Parameterisation | | <ul style="list-style-type: none"> • Diagnostic behaviour • Fail-safe mode per channel • Forcing per channel • Idle mode per channel • Module parameters | |
| Additional functions | | – | |
| Control elements | | DIL switches | |
| Operating voltage | Nominal value | [V DC] | 24 (polarity-safe) |
| | Permissible range | [V DC] | 18 ... 30 |
| | Power failure buffering | [ms] | 10 |
| Intrinsic current consumption at nominal operating voltage | | [mA] | Typically 65 |
| Max. power supply per channel | | [A] | 2 x 1.6 |
| Max. residual current of outputs per channel | | [A] | 2x 1.6 |
| Degree of protection to EN 60529 | | IP65, IP67 | |
| Temperature range | Operation | [°C] | –5 ... +50 |
| | Storage/transport | [°C] | –20 ... +70 |
| Materials | | PA reinforced, PC | |
| Note on materials | | RoHS-compliant | |
| Grid dimension | | [mm] | 50 |
| Dimensions (incl. interlinking block) W x L x H | | [mm] | 50 x 107 x 55 |
| Product weight | | [g] | 110 |

 Note

Please observe the general limits and guidelines for the system when configuring the electrical modules.

Terminal CPX

Technical data – Interface CPX-CTEL-2

Connection and display components

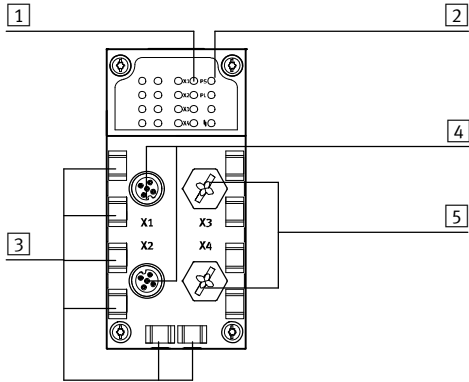

- 1 Status LEDs for I-Port interfaces
- 2 CPX-specific status LEDs
- 3 Holders for inscription labels (IBS 6x10)
- 4 IO-Link interfaces for up to 2 devices
- 5 Unoccupied connections

Pin allocation of IO-Link interface

| Pin allocation | Pin | Signal | Designation |
|----------------|-----|-----------------------|--|
| | 1 | 24 V _{SEN} | 24 V DC supply voltage for electronics and inputs |
| | 2 | 24 V _{VAL} | 24 V DC load voltage supply for valves and outputs |
| | 3 | 0 V _{SEN} | 0 V DC supply voltage for electronics and sensors |
| | 4 | C/Q _{I-PORT} | Communication signal C/Q, data cable |
| | 5 | 0 V _{VALVES} | 0 V DC load voltage supply for valves and outputs |

Dimensions

Download CAD data → www.festo.com

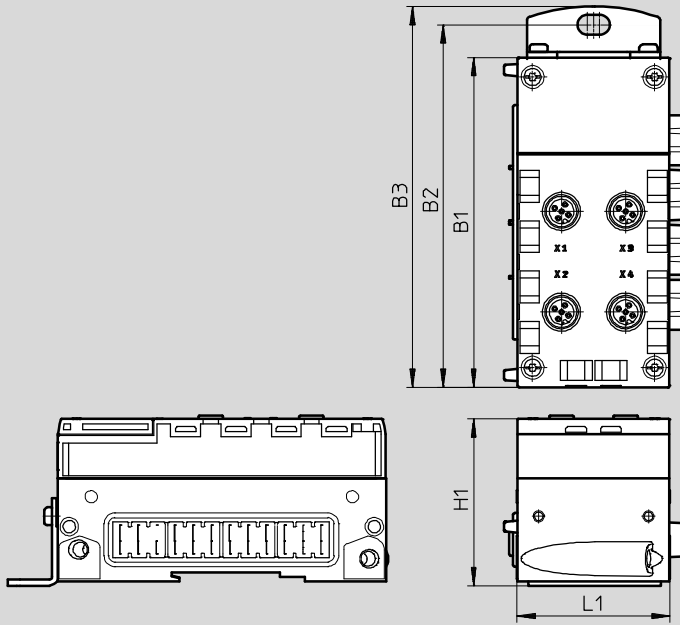



| Type | B1 | B2 | B3 | H1 | L1 |
|------------------------|-------|-------|-------|------|----|
| CPX-CTEL-2-M12-5POL-LK | 108.1 | 118.9 | 124.9 | 55.1 | 50 |

Terminal CPX

Interface accessories CPX-CTEL-2

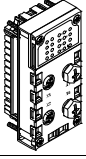
FESTO

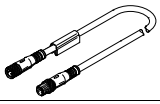
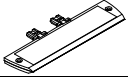
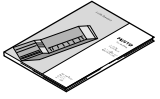
| Ordering data | | | | |
|--|---|---------|----------------|-----------------------------------|
| Designation | | | Part No. | Type |
| CPX CTEL-Master, IO-Link | | | | |
|  | Interface for max. 2 I/O modules and valve terminals with IO-Link interface (devices) | | 2900543 | CPX-CTEL-2-M12-5POL-LK |
| Bus connection | | | | |
|  | Cover cap | M12 | 165592 | ISK-M12 |
|  | Connecting cable M12-M12, 5-pin, straight plug-straight socket | 5 m | 574321 | NEBU-M12G5-E-5-Q8N-M12G5 |
| | | 7.5 m | 574322 | NEBU-M12G5-E-7.5-Q8N-M12G5 |
| | | 10 m | 574323 | NEBU-M12G5-E-10-Q8N-M12G5 |
|  | Inscription label holder for connection block | | 536593 | CPX-ST-1 |
| User documentation | | | | |
|  | User documentation for CPX CTEL-Master | German | 8034115 | P.BE-CPX-CTEL-LK-DE |
| | | English | 8034116 | P.BE-CPX-CTEL-LK-EN |
| | | Spanish | 8034117 | P.BE-CPX-CTEL-LK-ES |
| | | French | 8034118 | P.BE-CPX-CTEL-LK-FR |
| | | Italian | 8034119 | P.BE-CPX-CTEL-LK-IT |
| | | Swedish | 8034120 | P.BE-CPX-CTEL-LK-ZH |

Control block CPX-CM-HPP

Technical data



The control block CPX-CM-HPP is a module in the CPX terminal for controlling electric drives. The control component is independent of the bus node used. This means that Festo's electric drive technology is compatible with all industrial communication interfaces. The control block does not need to be programmed.

- Max. 4 individual electric axes can be controlled via CAN bus
- No programming required
- Standardised communication with the drives via the Festo Handling and Positioning Profile (FHPP)
- Quick configuration and diagnostics via the operator unit CPX-MMI
- Simple, flexible and cost-effective

| General technical data | | |
|--|--------|---|
| Fieldbus interface | | 1x socket M9, 5-pin |
| Protocol | | FHPP |
| Max. address volume for inputs | [byte] | 32 |
| Max. address volume for outputs | [byte] | 32 |
| LED display (product-specific) | Error: | Error |
| | PL: | Power supply |
| Device-specific diagnostics | | Diagnostic memory |
| | | Channel and module-oriented diagnostics |
| | | Undervoltage/short circuit of modules |
| Parameterisation | | Forcing of channels |
| | | System parameters |
| Configuration support | | Operator unit CPX-MMI |
| Total number of axes | | 4 |
| Nominal operating voltage | [V DC] | 24 |
| Operating voltage range | [V DC] | 18 ... 30 |
| Power failure buffering | [ms] | 10 |
| Intrinsic current consumption at nominal operating voltage | [mA] | Typically 80 |
| Protection class to EN 60529 (plug connector plugged in) | | IP65, IP67 |
| Dimensions W x L x H (incl. interlinking block) | [mm] | 50 x 107 x 55 |
| Product weight (without interlinking block) | [g] | 140 |
| Materials | | |
| Housing | | PA, reinforced |
| | | PC |
| Note on materials | | RoHS-compliant |

| Technical data – Interfaces | | |
|-----------------------------|--------|---------|
| Interface | | |
| Control interface | | CAN-Bus |
| Baud rate | [Mbps] | 1 |

| Operating and environmental conditions | | |
|---|------|-----------------------------|
| Ambient temperature | [°C] | -5 ... +50 |
| Storage temperature | [°C] | -20 ... +70 |
| CE mark (see declaration of conformity) | | To EU Low Voltage Directive |

Control block CPX-CM-HPP

Technical data

Connection and display components

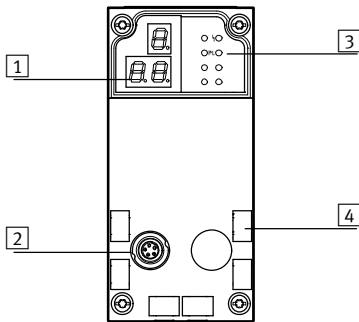

- 1 3-digit display
- 2 Control interface
- 3 LED display, product-specific
- 4 Inscription labels

Pin allocation – Control interface

| | Pin | Signal | Meaning |
|----------------|----------|---|---------------|
| Plug M9, 5-pin | | | |
| | 1 | n.c. | Not connected |
| | 2 | n.c. | Not connected |
| | 3 | CAN_GND | CAN ground |
| | 4 | CAN_H | CAN high |
| | 5 | CAN_L | CAN low |
| Housing | Screened | Cable screen must be connected to functional earth (FE) | |



Permitted bus nodes/FEC

| Bus node/FEC | Protocol | Max. no. of CPX-CM-HPP modules |
|--------------|-------------------|--------------------------------|
| CPX-FEC | – | 2 |
| CPX-CEC... | – | 0 |
| CPX-FB6 | INTERBUS | 0 |
| CPX-FB11 | DeviceNet | 2 |
| CPX-FB13 | PROFIBUS | 2 |
| CPX-FB14 | CANopen | 1 |
| CPX-M-FB20 | INTERBUS | 0 |
| CPX-M-FB21 | INTERBUS | 0 |
| CPX-FB23-24 | CC-Link | 1 (function module F23) |
| | | 0 (function module F24) |
| CPX-FB32 | EtherNet/IP | 2 |
| CPX-FB33 | PROFINET RT, M12 | 2 |
| CPX-M-FB34 | PROFINET RT, RJ45 | 2 |
| CPX-M-FB35 | PROFINET RT, SCRJ | 2 |
| CPX-FB36 | EtherNet/IP | 2 |
| CPX-FB37 | EtherCAT | 2 |
| CPX-FB38 | EtherCAT | 2 |
| CPX-FB39 | Sercos III | 2 |
| CPX-FB40 | POWERLINK | 2 |
| CPX-M-FB41 | PROFINET RT | 2 |

Control block CPX-CM-HPP

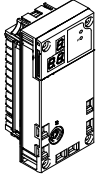
Accessories

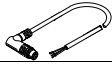
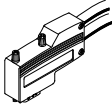
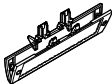
| Ordering data | | Part No. | Type |
|---|---|----------|------------|
| Designation | | | |
| Control block | | | |
|  | Max. 4 individual electric axes can be controlled via CAN bus | 562214 | CPX-CM-HPP |

| Ordering data – Bus connection | | | |
|---|---|----------|----------------------------|
| Designation | | Part No. | Type |
| Connecting cable | | | |
|  | Connecting cable | 2 m | 563711 NEBC-M9W5-K-2-N-LE3 |
| | | 5 m | 563712 NEBC-M9W5-K-5-N-LE3 |
|  | Plug for CAN bus interface, Sub-D, 9-pin, without terminating resistor | 533783 | FBS-SUB-9-WS-CO-K |
| Inscription label | | | |
|  | Inscription label holder for manifold block | 536593 | CPX-ST-1 |
| Documentation | | | |
|  | Manual – Control block CPX-CM-HPP | German | 568683 P.BE-CPX-CM-HPP-DE |
| | | English | 568684 P.BE-CPX-CM-HPP-EN |

Axis controllers CPX-CMAX

Technical data

The axis controller CPX-CMAX is intended exclusively for valve terminals CPX.



| General technical data | | | |
|--|---------|-----------------------------|-----|
| Operating voltage | | | |
| Operating voltage range | [V DC] | 18 ... 30 | |
| Nominal operating voltage | [V DC] | 24 | |
| Current consumption at nominal operating voltage | [mA] | 200 | |
| Fuse protection (short circuit) | | Electronic | |
| Power failure bridging | [ms] | 10 | |
| | | | |
| Load voltage | | | |
| Load voltage range | [V DC] | 20 ... 30 | |
| Nominal load voltage | [V DC] | 24 | |
| Perm. load current | [A] | 2.5 | |
| Fuse protection (short circuit) | | Electronic | |
| | | | |
| Number of axis strings | | 1 | |
| Axes per string | | 1 | |
| Length of connecting cable to axis | [m] | ≤ 30 | |
| Max. no. of modules | | 7 | |
| Display | | 7-segment display | |
| Assigned addresses | Outputs | [bit] | 8x8 |
| | Inputs | [bit] | 8x8 |
| Operating modes | | Record Select mode | |
| | | Direct mode | |
| Controller types | | Position control | |
| | | Force control | |
| Diagnostics | | Module-orientated | |
| | | Via local 7-segment display | |
| Status display | | Module status | |
| | | Power Load | |
| | | Display/Error Axis X | |
| | | MC Axis X | |
| | | | |
| Control interface | | | |
| Data | | CAN bus with Festo protocol | |
| | | Digital | |
| Electrical connection | | 5-pin | |
| | | M9 | |
| | | Socket | |
| | | | |
| Materials: Housing | | Reinforced PA | |
| Note on materials | | RoHS-compliant | |
| Product weight | [g] | 140 | |
| Dimensions | Length | [mm] | 107 |
| | Width | [mm] | 50 |
| | Height | [mm] | 55 |

Axis controllers CPX-CMAX

Technical data

| Operating and environmental conditions | | |
|--|------|--------------------------|
| Ambient temperature | [°C] | -5 ... +50 |
| Relative air humidity | [%] | 5 ... 95, non-condensing |
| Protection class to IEC 60529 | | IP65 |

Connection and display components

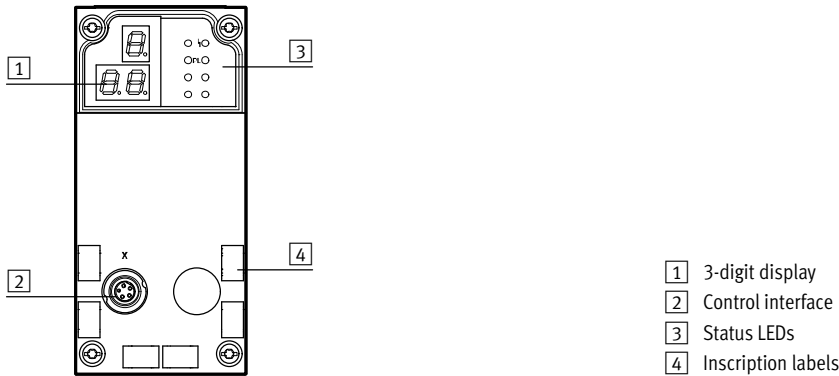

- 1 3-digit display
- 2 Control interface
- 3 Status LEDs
- 4 Inscription labels

Pin allocation – plug 2

| | Pin | Signal | Designation |
|--|---------|----------|---------------------------|
| | 1 | +24 V | Nominal operating voltage |
| | 2 | +24 V | Load voltage |
| | 3 | 0 V | Ground |
| | 4 | CAN_H | CAN high |
| | 5 | CAN_L | CAN low |
| | Housing | Screened | Cable screening |

Permitted bus nodes/FEC

| Bus node/FEC | Protocol | Max. no. of CMAX modules |
|--------------|-------------------------|--------------------------|
| CPX-FEC | - | 8 |
| CPX-CEC... | - | 8 |
| CPX-FB6 | INTERBUS | 1 |
| CPX-FB11 | DeviceNet ¹⁾ | 8 |
| CPX-FB13 | PROFIBUS ²⁾ | 8 |
| CPX-FB14 | CANopen | 4 |
| CPX-M-FB20 | INTERBUS | 1 |
| CPX-M-FB21 | INTERBUS | 1 |
| CPX-FB23-24 | CC-Link | 4 (function module F23) |
| | | 8 (function module F24) |
| CPX-FB32 | EtherNet/IP | 8 |
| CPX-FB33 | PROFINET RT, M12 | 8 |
| CPX-M-FB34 | PROFINET RT, RJ45 | 8 |
| CPX-M-FB35 | PROFINET RT, SCRJ | 8 |
| CPX-FB36 | EtherNet/IP | 8 |
| CPX-FB37 | EtherCAT | 8 |
| CPX-FB38 | EtherCAT | 8 |
| CPX-FB39 | Sercos III | 8 |
| CPX-FB40 | POWERLINK | 8 |
| CPX-M-FB41 | PROFINET RT | 8 |

1) With Revision 20 (R20)
 2) With Revision 23 (R23)

PROFIBUS®, DeviceNet®, CANopen®, INTERBUS®, CC-LINK®, EtherCAT®, PROFINET®, Sercos®, EtherNet/IP® is a registered trademark of its respective trademark holder in certain countries.

Axis controllers CPX-CMAX

Accessories

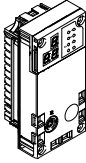
| Ordering data – Axis controllers | | | |
|---|---|---------------|----------------------|
| | Brief description | Part No. | Type |
|  | Order code in the CPX configurator: T21 | 548932 | CPX-CMAX-C1-1 |

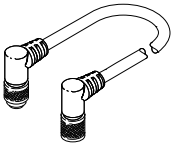
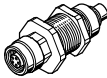
| Ordering data – Connecting cables | | | |
|---|---|--------------------------------|-----------------------------------|
| | Brief description | Cable length [m] | Part No. Type |
|  | Connecting cable with angled plug and angled socket | 0.25 | 540327 KVI-CP-3-WS-WD-0,25 |
| | | 0.5 | 540328 KVI-CP-3-WS-WD-0,5 |
| | | 2 | 540329 KVI-CP-3-WS-WD-2 |
| | | 5 | 540330 KVI-CP-3-WS-WD-5 |
| | | 8 | 540331 KVI-CP-3-WS-WD-8 |
| | Connecting cable with straight plug and straight socket | 2 | 540332 KVI-CP-3-GS-GD-2 |
| 5 | | 540333 KVI-CP-3-GS-GD-5 | |
| 8 | | 540334 KVI-CP-3-GS-GD-8 | |
|  | Connector for control cabinet through-feed | – | 543252 KVI-CP-3-SSD |

| Ordering data – Screws | | | |
|---|--|---------------|-----------------------|
| | Brief description | Part No. | Type |
|  | For mounting on the metal interlinking block | 550219 | CPX-M-M3X22-4X |

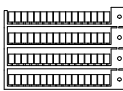
| Ordering data – Inscription labels | | | |
|---|------------------------------------|--------|-----------------------|
| | Brief description | Number | Part No. Type |
|  | Inscription labels 6x10, in frames | 64 | 18576 IBS-6X10 |

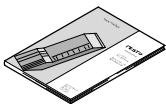
| Documentation ¹⁾ | | | |
|---|----------|---------------|-----------------------------|
| | Language | Part No. | Type |
|  | DE | 559750 | P.BE-CPX-CMAX-SYS-DE |
| | EN | 559751 | P.BE-CPX-CMAX-SYS-EN |
| | ES | 559752 | P.BE-CPX-CMAX-SYS-ES |
| | FR | 559753 | P.BE-CPX-CMAX-SYS-FR |
| | IT | 559754 | P.BE-CPX-CMAX-SYS-IT |

1) Manual in paper form is not included in the scope of delivery.

End-position controllers CPX-CMPX

Technical data

The end-position controller CPX-CMPX is intended exclusively for use in valve terminals CPX.



| General technical data | | | |
|--|---------|-----------------------------|-----|
| Operating voltage | | | |
| Operating voltage range | [V DC] | 18 ... 30 | |
| Nominal operating voltage | [V DC] | 24 | |
| Current consumption at nominal operating voltage | [mA] | 80 | |
| Load voltage | | | |
| Load voltage range | [V DC] | 20 ... 30 | |
| Nominal load voltage | [V DC] | 24 | |
| Perm. load current | [A] | 2.5 | |
| Number of axes per module | | | |
| | | 1 | |
| Length of connecting cable to axis | [m] | ≤ 30 | |
| Max. no. of modules | | | |
| | | 9 | |
| Display | | | |
| | | 7-segment display | |
| Control elements | | | |
| | | 3 keys | |
| Assigned addresses | Outputs | [bit] | 6x8 |
| | Inputs | [bit] | 6x8 |
| Diagnostics | | | |
| | | Module-orientated | |
| | | Via local 7-segment display | |
| | | Via operator unit CPX-MMI-1 | |
| Status display | | | |
| | | Module status | |
| | | Power Load | |
| Control interface | | | |
| Data | | | |
| | | CAN bus with Festo protocol | |
| | | Digital | |
| Electrical connection | | | |
| | | 5-pin | |
| | | M9 | |
| | | Socket | |
| Materials: Housing | | | |
| | | Reinforced PA | |
| Product weight | | | |
| | | [g] | 240 |
| Dimensions | | | |
| Length | | [mm] | 107 |
| Width | | [mm] | 50 |
| Height | | [mm] | 55 |

End-position controllers CPX-CMPX

Technical data

| Operating and environmental conditions | | |
|---|------|--------------------------|
| Ambient temperature | [°C] | -5 ... +50 |
| Relative air humidity | [%] | 5 ... 95, non-condensing |
| Protection class to IEC 60529 | | IP65 |
| CE mark (see declaration of conformity) | | To EU EMC Directive |

Connection and display components

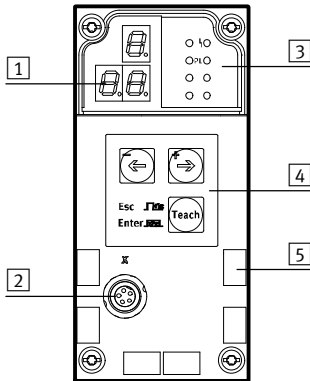

- 1 3-digit display
- 2 Control interface
- 3 Status LEDs
- 4 Operating buttons
- 5 Inscription labels

Pin allocation – plug 2

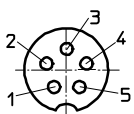

| Pin | Signal | Designation |
|---------|----------|---------------------------|
| 1 | +24 V | Nominal operating voltage |
| 2 | +24 V | Load voltage |
| 3 | 0 V | Ground |
| 4 | CAN_H | CAN high |
| 5 | CAN_L | CAN low |
| Housing | Screened | Cable screening |

Permitted bus nodes/FEC

| Bus node/FEC | Protocol | Max. no. of CMPX modules |
|--------------|-------------------------|--------------------------|
| CPX-FEC | - | 9 |
| CPX-CEC... | - | 9 |
| CPX-FB6 | INTERBUS | 2 |
| CPX-FB11 | DeviceNet ¹⁾ | 9 |
| CPX-FB13 | PROFIBUS ²⁾ | 9 |
| CPX-FB14 | CANopen | 5 |
| CPX-M-FB20 | INTERBUS | 2 |
| CPX-M-FB21 | INTERBUS | 2 |
| CPX-FB23-24 | CC-Link | 5 (function module F23) |
| | | 9 (function module F24) |
| CPX-FB32 | EtherNet/IP | 9 |
| CPX-FB33 | PROFINET RT, M12 | 9 |
| CPX-M-FB34 | PROFINET RT, RJ45 | 9 |
| CPX-M-FB35 | PROFINET RT, SCRJ | 9 |
| CPX-FB36 | EtherNet/IP | 9 |
| CPX-FB37 | EtherCAT | 9 |
| CPX-FB38 | EtherCAT | 9 |
| CPX-FB39 | Sercos III | 9 |
| CPX-FB40 | POWERLINK | 9 |
| CPX-M-FB41 | PROFINET RT | 9 |

1) With Revision 20 (R20)

2) With Revision 23 (R23)

PROFIBUS®, DeviceNet®, CANopen®, INTERBUS®, CC-LINK®, EtherCAT®, PROFINET®, Sercos®, EtherNet/IP® is a registered trademark of its respective trademark holder in certain countries.

End-position controllers CPX-CMPX

Accessories

FESTO

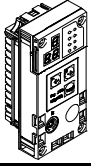
| Ordering data – End-position controllers | | | |
|---|---|---------------|------------------------|
| | Brief description | Part No. | Type |
|  | Order code in the CPX configurator: T20 | 548931 | CPX-CMPX-C-1-H1 |

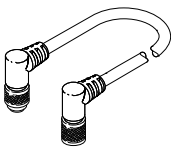
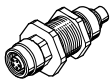
| Ordering data – Connecting cables | | | |
|--|---|---|-----------------------------------|
| | Brief description | Cable length [m] | Part No. Type |
|  | Connecting cable with angled plug and angled socket | 0.25 | 540327 KVI-CP-3-WS-WD-0,25 |
| | | 0.5 | 540328 KVI-CP-3-WS-WD-0,5 |
| | | 2 | 540329 KVI-CP-3-WS-WD-2 |
| | | 5 | 540330 KVI-CP-3-WS-WD-5 |
| | | 8 | 540331 KVI-CP-3-WS-WD-8 |
| | | Connecting cable with straight plug and straight socket | 2 |
| 5 | 540333 KVI-CP-3-GS-GD-5 | | |
| 8 | 540334 KVI-CP-3-GS-GD-8 | | |
|  | Connector for control cabinet through-feed | – | 543252 KVI-CP-3-SSD |

| Ordering data – Screws | | | |
|---|--|---------------|-----------------------|
| | Brief description | Part No. | Type |
|  | For mounting on the metal interlinking block | 550219 | CPX-M-M3X22-4X |

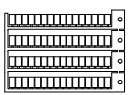
| Ordering data – Inscription labels | | | |
|---|------------------------------------|--------|-----------------------|
| | Brief description | Number | Part No. Type |
|  | Inscription labels 6x10, in frames | 64 | 18576 IBS-6X10 |

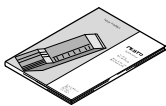
| Documentation ¹⁾ | | | |
|---|----------|---------------|-----------------------------|
| | Language | Part No. | Type |
|  | DE | 555479 | P.BE-CPX-CMPX-SYS-DE |
| | EN | 555480 | P.BE-CPX-CMPX-SYS-EN |
| | ES | 555481 | P.BE-CPX-CMPX-SYS-ES |
| | FR | 555482 | P.BE-CPX-CMPX-SYS-FR |
| | IT | 555483 | P.BE-CPX-CMPX-SYS-IT |

1) Manual in paper form is not included in the scope of delivery

Measuring modules CPX-CMIX

Technical data

The measuring module CPX-CMIX is intended exclusively for use in valve terminals CPX.



| General technical data | | | |
|--|---------|--------|----------------------------------|
| Operating voltage | | | |
| Operating voltage range | | [V DC] | 18 ... 30 |
| Nominal operating voltage | | [V DC] | 24 |
| Current consumption at nominal operating voltage | | [mA] | 80 |
| Protection against short circuit | | | Yes |
| Power failure bridging | | [ms] | 10 |
| | | | |
| No. of axis strings | | | 1 |
| Axes per string | | | 1 |
| Length of connecting cable to axis | | [m] | ≤ 30 |
| Max. no. of modules | | | 9 |
| Display | | | 7-segment display |
| Assigned addresses | Outputs | [bit] | 6x8 |
| | Inputs | [bit] | 6x8 |
| Diagnostics | | | Channel and module-oriented |
| | | | Via local 7-segment display |
| | | | Undervoltage of modules |
| | | | Undervoltage of measuring system |
| Status display | | | Power Load |
| | | | Error |
| | | | |
| Control interface | | | |
| Data | | | CAN bus with Festo protocol |
| | | | Digital |
| Electrical connection | | | 5-pin |
| | | | M9 |
| | | | Socket |
| | | | |
| Materials: Housing | | | Reinforced PA |
| Note on materials | | | RoHS-compliant |
| Product weight | | [g] | 140 |
| Dimensions | Length | [mm] | 107 |
| | Width | [mm] | 50 |
| | Height | [mm] | 55 |

Measuring modules CPX-CMIX

Technical data

FESTO

| Operating and environmental conditions | | |
|--|------|--------------------------|
| Ambient temperature | [°C] | -5 ... +50 |
| Relative air humidity | [%] | 5 ... 95, non-condensing |
| Protection class to IEC 60529 | | IP65 |

Connection and display components

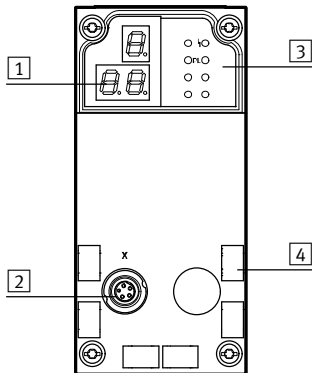

- 1 3-digit display
- 2 Control interface
- 3 Status LEDs
- 4 Inscription labels

Pin allocation – Plug 2

| | Pin | Signal | Designation |
|--|---------|----------|---------------------------|
| | 1 | +24 V | Nominal operating voltage |
| | 2 | +24 V | Load voltage |
| | 3 | 0 V | Ground |
| | 4 | CAN_H | CAN high |
| | 5 | CAN_L | CAN low |
| | Housing | Screened | Cable screening |

Permitted bus nodes/FEC

| Bus node/FEC | Protocol | Max. no. of CMIX modules |
|--------------|-------------------------|--------------------------|
| CPX-FEC | - | 9 |
| CPX-CEC... | - | 9 |
| CPX-FB6 | INTERBUS | 2 |
| CPX-FB11 | DeviceNet ¹⁾ | 9 |
| CPX-FB13 | PROFIBUS ²⁾ | 9 |
| CPX-FB14 | CANopen | 5 |
| CPX-M-FB20 | INTERBUS | 2 |
| CPX-M-FB21 | INTERBUS | 2 |
| CPX-FB23-24 | CC-Link | 5 (function module F23) |
| | | 9 (function module F24) |
| CPX-FB32 | EtherNet/IP | 9 |
| CPX-FB33 | PROFINET RT, M12 | 9 |
| CPX-M-FB34 | PROFINET RT, RJ45 | 9 |
| CPX-M-FB35 | PROFINET RT, SCRJ | 9 |
| CPX-FB36 | EtherNet/IP | 9 |
| CPX-FB37 | EtherCAT | 9 |
| CPX-FB38 | EtherCAT | 9 |
| CPX-FB39 | Sercos III | 9 |
| CPX-FB40 | POWERLINK | 9 |
| CPX-M-FB41 | PROFINET RT | 9 |

1) With Revision 20 (R20)

2) With Revision 23 (R23)

PROFIBUS®, DeviceNet®, CANopen®, INTERBUS®, CC-LINK®, EtherCAT®, PROFINET®, Sercos®, EtherNet/IP® is a registered trademark of its respective trademark holder in certain countries.

Measuring modules CPX-CMIX

Accessories

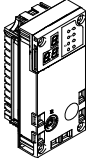
| Ordering data – Measuring module | | | |
|---|---|----------|---------------|
| | Description | Part No. | Type |
|  | Order code in the CPX configurator: T23 | 567417 | CPX-CMIX-M1-1 |

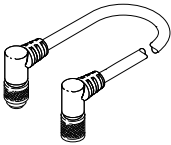
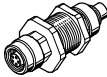
| Ordering data – Connecting cables | | | |
|---|---|-------------------------|----------------------------|
| | Description | Cable length [m] | Part No. Type |
|  | Connecting cable with angled plug and angled socket | 0.25 | 540327 KVI-CP-3-WS-WD-0,25 |
| | | 0.5 | 540328 KVI-CP-3-WS-WD-0,5 |
| | | 2 | 540329 KVI-CP-3-WS-WD-2 |
| | | 5 | 540330 KVI-CP-3-WS-WD-5 |
| | | 8 | 540331 KVI-CP-3-WS-WD-8 |
| | Connecting cable with straight plug and straight socket | 2 | 540332 KVI-CP-3-GS-GD-2 |
| 5 | | 540333 KVI-CP-3-GS-GD-5 | |
| 8 | | 540334 KVI-CP-3-GS-GD-8 | |
|  | Connector for control cabinet through-feed | – | 543252 KVI-CP-3-SSD |

| Connection between displacement encoder MME and measuring module CPX-CMIX | | | |
|---|------------------------------|---|----------------------------|
|  | For displacement encoder MME | 2 | 575898 NEBP-M16W6-K-2-M9W5 |

| Ordering data – Screws | | | |
|---|--|----------|----------------|
| | Description | Part No. | Type |
|  | For mounting on the metal interlinking block | 550219 | CPX-M-M3X22-4X |

| Ordering data – Inscription labels | | | |
|---|------------------------------------|--------|----------------|
| | Description | Number | Part No. Type |
|  | Inscription labels 6x10, in frames | 64 | 18576 IBS-6X10 |

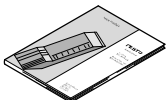
| Documentation ¹⁾ | | | |
|---|----------|----------|------------------|
| | Language | Part No. | Type |
|  | DE | 567053 | P.BE-CPX-CMIX-DE |
| | EN | 567054 | P.BE-CPX-CMIX-EN |
| | ES | 567055 | P.BE-CPX-CMIX-ES |
| | FR | 567056 | P.BE-CPX-CMIX-FR |
| | IT | 567057 | P.BE-CPX-CMIX-IT |

1) Manual in paper form is not included in the scope of delivery

Terminal CPX

Technical data – Input module, digital

Function

Digital input modules enable the connection of two-wire and three-wire sensors (proximity sensors, inductive or capacitive sensors, etc). Depending on the connection block selected, the module supports various connection concepts with different numbers of sockets (single or double allocation).

Applications

- Input modules for 24 V DC sensor supply voltage
- PNP or NPN logic
- Supports connection blocks with M12, M8, Sub-D, Harax and terminal connection
- Module features can be parameterised
- The input module receives the voltage supply for the electronics and the sensors from the interlinking block
- Module protection and diagnostics through integrated electronic fuse protection



| General technical data | | | | | |
|--|------------------------|---|--|---|--|
| Type | | CPX-4DE | CPX-8DE | CPX-8DE-D | CPX-8NDE |
| No. of inputs | | 4 | 8 | 8 | 8 |
| Max. residual current of inputs per module | [A] | 0.7 | 1 | 0.7 | 0.7 |
| Fuse protection | | Internal electronic fuse for each module | Internal electronic fuse for each module | Internal electronic fuse for each channel | Internal electronic fuse for each module |
| Intrinsic current consumption at operating voltage | [mA] | Typically 15 | | | |
| Operating voltage | Nominal value | 24 | | | |
| | Permissible range | 18 ... 30 | | | |
| Electrical isolation | Channel – channel | No | | | |
| | Channel – internal bus | No | | | |
| Switching level | Signal 0 | [V DC] | ≤ 5 | | ≥ 11 |
| | Signal 1 | [V DC] | ≥ 11 | | ≤ 5 |
| Input debounce time | [ms] | 3 (0.1, 10, 20 parameterisable) | | | |
| Input characteristic curve | | IEC 1131 Part 2 | | | |
| Switching logic | | Positive logic (PNP) | | | Negative logic (NPN) |
| LED displays | Group diagnostics | 1 | 1 | 1 | 1 |
| | Channel diagnostics | – | – | 8 | – |
| | Channel status | 4 | 8 | 8 | 8 |
| Diagnostics | | Short circuit/overload per channel | | | |
| Parameterisation | | <ul style="list-style-type: none"> • Module monitoring • Behaviour after short circuit • Input debounce time • Signal stretching time | | | |
| Protection class to EN 60529 | | Depending on connection block | | | |
| Temperature range | Operation | [°C] | –5 ... +50 | | |
| | Storage/transport | [°C] | –20 ... +70 | | |
| Materials | | Reinforced PA, PC | | | |
| Grid dimension | [mm] | 50 | | | |
| Dimensions (incl. interlinking block and connection block) W x L x H | [mm] | 50 x 107 x 50 | | | |
| Weight | [g] | 38 | | | |

Terminal CPX

Technical data – Input module, digital

Connection and display components

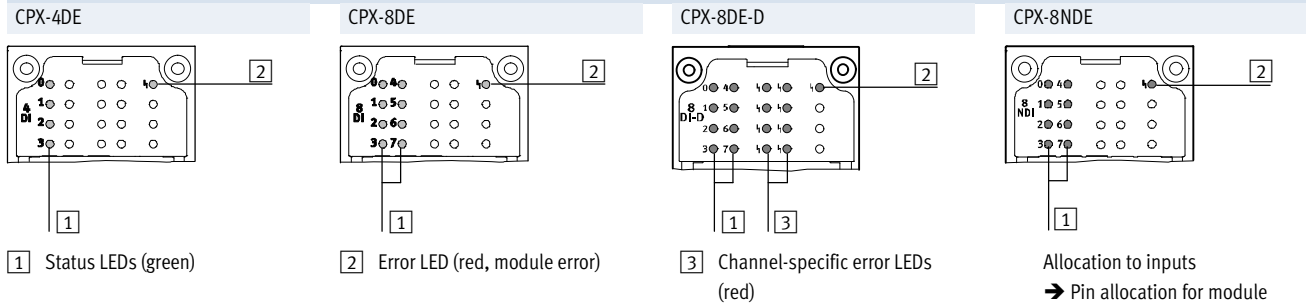

Connection block/digital input module combinations

| Connection blocks | Part No. | Digital input modules | | | |
|-----------------------|----------|-----------------------|---------|-----------|----------|
| | | CPX-4DE | CPX-8DE | CPX-8DE-D | CPX-8NDE |
| CPX-AB-8-M8-3POL | 195706 | ■ | ■ | ■ | ■ |
| CPX-AB-4-M12X2-5POL | 195704 | ■ | ■ | ■ | ■ |
| CPX-AB-4-M12X2-5POL-R | 541254 | ■ | ■ | ■ | ■ |
| CPX-AB-8-KL-4POL | 195708 | ■ | ■ | ■ | ■ |
| CPX-AB-1-SUB-BU-25POL | 525676 | ■ | ■ | ■ | ■ |
| CPX-AB-4-HAR-4POL | 525636 | ■ | ■ | ■ | ■ |
| CPX-M-AB-4-M12x2-5POL | 549367 | ■ | ■ | ■ | ■ |

Pin allocation

| Connection block inputs | CPX-4DE | CPX-8DE, CPX-8DE-D and CPX-8NDE | | | |
|--|---------|--|--|---|---|
| CPX-AB-8-M8-3POL | | <p>X1.1: 24 V_{SEN} X1.3: 0 V_{SEN} X1.4: Input x</p> <p>X2.1: 24 V_{SEN} X2.3: 0 V_{SEN} X2.4: Input x+1</p> <p>X3.1: 24 V_{SEN} X3.3: 0 V_{SEN} X3.4: Input x+1</p> <p>X4.1: 24 V_{SEN} X4.3: 0 V_{SEN} X4.4: n.c.</p> | <p>X5.1: 24 V_{SEN} X5.3: 0 V_{SEN} X5.4: Input x+2</p> <p>X6.1: 24 V_{SEN} X6.3: 0 V_{SEN} X6.4: Input x+3</p> <p>X7.1: 24 V_{SEN} X7.3: 0 V_{SEN} X7.4: Input x+3</p> <p>X8.1: 24 V_{SEN} X8.3: 0 V_{SEN} X8.4: n.c.</p> | <p>X1.1: 24 V_{SEN} x X1.3: 0 V_{SEN} x X1.4: Input x</p> <p>X2.1: 24 V_{SEN} x+1 X2.3: 0 V_{SEN} x+1 X2.4: Input x+1</p> <p>X3.1: 24 V_{SEN} x+2 X3.3: 0 V_{SEN} x+2 X3.4: Input x+2</p> <p>X4.1: 24 V_{SEN} x+3 X4.3: 0 V_{SEN} x+3 X4.4: Input x+3</p> | <p>X5.1: 24 V_{SEN} x+4 X5.3: 0 V_{SEN} x+4 X5.4: Input x+4</p> <p>X6.1: 24 V_{SEN} x+5 X6.3: 0 V_{SEN} x+5 X6.4: Input x+5</p> <p>X7.1: 24 V_{SEN} x+6 X7.3: 0 V_{SEN} x+6 X7.4: Input x+6</p> <p>X8.1: 24 V_{SEN} x+7 X8.3: 0 V_{SEN} x+7 X8.4: Input x+7</p> |
| CPX-AB-4-M12X2-5POL, CPX-AB-4-M12X2-5POL-R ¹⁾ and CPX-M-AB-4-M12X2-5POL | | <p>X1.1: 24 V_{SEN} X1.2: Input x+1 X1.3: 0 V_{SEN} X1.4: Input x X1.5: FE</p> <p>X2.1: 24 V_{SEN} X2.2: n.c. X2.3: 0 V_{SEN} X2.4: Input x+1 X2.5: FE</p> | <p>X3.1: 24 V_{SEN} X3.2: Input x+3 X3.3: 0 V_{SEN} X3.4: Input x+2 X3.5: FE</p> <p>X4.1: 24 V_{SEN} X4.2: n.c. X4.3: 0 V_{SEN} X4.4: Input x+3 X4.5: FE</p> | <p>X1.1: 24 V_{SEN} x X1.2: Input x+1 X1.3: 0 V_{SEN} x X1.4: Input x X1.5: FE</p> <p>X2.1: 24 V_{SEN} x+2 X2.2: Input x+3 X2.3: 0 V_{SEN} x+2 X2.4: Input x+2 X2.5: FE</p> | <p>X3.1: 24 V_{SEN} x+4 X3.2: Input x+5 X3.3: 0 V_{SEN} x+4 X3.4: Input x+4 X3.5: FE</p> <p>X4.1: 24 V_{SEN} x+6 X4.2: Input x+7 X4.3: 0 V_{SEN} x+6 X4.4: Input x+6 X4.5: FE</p> |

1) Speedcon quick lock, screening additionally on metal thread

Terminal CPX

Technical data – Input module, digital







| Pin allocation | | | | | |
|------------------------------|--|--|--|--|--|
| Connection block inputs | | CPX-4DE | CPX-8DE, CPX-8DE-D and CPX-8NDE | | |
| CPX-AB-8-KL-4POL | | | | | |
| | | X1.0: 24 V _{SEN} X1.1: 0 V _{SEN} X1.2: Input x X1.3: FE X2.0: 24 V _{SEN} X2.1: 0 V _{SEN} X2.2: Input x+1 X2.3: FE X3.0: 24 V _{SEN} X3.1: 0 V _{SEN} X3.2: Input x+1 X3.3: FE X4.0: 24 V _{SEN} X4.1: 0 V _{SEN} X4.2: n.c. X4.3: FE | X5.0: 24 V _{SEN} X5.1: 0 V _{SEN} X5.2: Input x+2 X5.3: FE X6.0: 24 V _{SEN} X6.1: 0 V _{SEN} X6.2: Input x+3 X6.3: FE X7.0: 24 V _{SEN} X7.1: 0 V _{SEN} X7.2: Input x+3 X7.3: FE X8.0: 24 V _{SEN} X8.1: 0 V _{SEN} X8.2: n.c. X8.3: FE | X1.0: 24 V _{SEN x} X1.1: 0 V _{SEN x} X1.2: Input x X1.3: FE X2.0: 24 V _{SEN x+1} X2.1: 0 V _{SEN x+1} X2.2: Input x+1 X2.3: FE X3.0: 24 V _{SEN x+2} X3.1: 0 V _{SEN x+2} X3.2: Input x+2 X3.3: FE X4.0: 24 V _{SEN x+3} X4.1: 0 V _{SEN x+3} X4.2: Input x+3 X4.3: FE | X5.0: 24 V _{SEN x+4} X5.1: 0 V _{SEN x+4} X5.2: Input x+4 X5.3: FE X6.0: 24 V _{SEN x+5} X6.1: 0 V _{SEN x+5} X6.2: Input x+5 X6.3: FE X7.0: 24 V _{SEN x+6} X7.1: 0 V _{SEN x+6} X7.2: Input x+6 X7.3: FE X8.0: 24 V _{SEN x+7} X8.1: 0 V _{SEN x+7} X8.2: Input x+7 X8.3: FE |
| CPX-AB-1-SUB-BU-25POL | | | | | |
| | | 1: Input x 2: Input x+1 3: Input x+1 4: n.c. 5: 24 V _{SEN} 6: 0 V _{SEN} 7: 24 V _{SEN} 8: 0 V _{SEN} 9: 24 V _{SEN} 10: 24 V _{SEN} 11: 0 V _{SEN} 12: 0 V _{SEN} 13: FE | 14: Input x+2 15: Input x+3 16: Input x+3 17: n.c. 18: 24 V _{SEN} 19: 24 V _{SEN} 20: 24 V _{SEN} 21: 24 V _{SEN} 22: 0 V _{SEN} 23: 0 V _{SEN} 24: 0 V _{SEN} 25: FE Housing: FE | 1: Input x 2: Input x+1 3: Input x+2 4: Input x+3 5: 24 V _{SEN x+1} 6: 0 V _{SEN x+1} 7: 24 V _{SEN x+3} 8: 0 V _{SEN x+3} 9: 24 V _{SEN x} 10: 24 V _{SEN x+2} 11: 0 V _{SEN x} 12: 0 V _{SEN x+2} 13: FE | 14: Input x+4 15: Input x+5 16: Input x+6 17: Input x+7 18: 24 V _{SEN x+4} 19: 24 V _{SEN x+5} 20: 24 V _{SEN x+6} 21: 24 V _{SEN x+7} 22: 0 V _{SEN x+2 and 3} 23: 0 V _{SEN x+2 and 3} 24: 0 V _{SEN x+2 and 3} 25: FE Housing: FE |
| CPX-AB-4-HAR-4POL | | | | | |
| | | X1.1: 24 V _{SEN} X1.2: Input x+1 X1.3: 0 V _{SEN} X1.4: Input x X2.1: 24 V _{SEN} X2.2: n.c. X2.3: 0 V _{SEN} X2.4: Input x+1 X3.1: 24 V _{SEN} X3.2: Input x+3 X3.3: 0 V _{SEN} X3.4: Input x+2 X4.1: 24 V _{SEN} X4.2: n.c. X4.3: 0 V _{SEN} X4.4: Input x+3 | X1.1: 24 V _{SEN x} X1.2: Input x+1 X1.3: 0 V _{SEN x} X1.4: Input x X2.1: 24 V _{SEN x+2} X2.2: Input x+3 X2.3: 0 V _{SEN x+2} X2.4: Input x+2 X3.1: 24 V _{SEN x+4} X3.2: Input x+5 X3.3: 0 V _{SEN x+4} X3.4: Input x+4 X4.1: 24 V _{SEN x+6} X4.2: Input x+7 X4.3: 0 V _{SEN x+6} X4.4: Input x+6 | | |

Terminal CPX

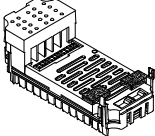
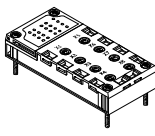
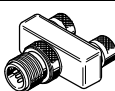
Accessories – Input module, digital

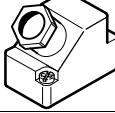
FESTO

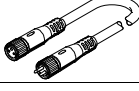
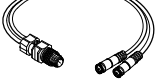
| Ordering data | | | |
|---|--|--|--|
| Designation | | Part No. | Type |
| Input module, digital | | | |
|  | 4 digital inputs, positive logic (PNP) | 195752 | CPX-4DE |
| | 8 digital inputs, positive logic (PNP) | 195750 | CPX-8DE |
| | 8 digital inputs, positive logic (PNP), advanced diagnostic function | 541480 | CPX-8DE-D |
| | 8 digital inputs, negative logic (NPN) | 543813 | CPX-8NDE |
| Connection block | | | |
|  | Plastic | 8x socket, M8, 3-pin | 195706 CPX-AB-8-M8-3POL |
| | | 4x socket, M12, 5-pin | 195704 CPX-AB-4-M12X2-5POL |
| | | 4x socket, M12 with quick-lock technology, 5-pin | 541254 CPX-AB-4-M12X2-5POL-R |
| | | Spring clip terminal, 32-pin | 195708 CPX-AB-8-KL-4POL |
| | | 1x Sub-D socket, 25-pin | 525676 CPX-AB-1-SUB-BU-25POL |
| | | 4x socket, quick connection, 4-pin | 525636 CPX-AB-4-HAR-4POL |
| | Metal | 4x socket, M12, 5-pin | 549367 CPX-M-AB-4-M12X2-5POL |
| Plug | | | |
|  | Push-in T-connector | 2x socket, M12, 5-pin 1x plug, M12, 4-pin | 541596 NEDU-M12D5-M12T4 |
| | | 2x socket, M8, 3-pin 1x plug, M12, 4-pin | 541597 NEDU-M8D3-M12T4 |
|  | Plug | M8, 3-pin, solderable | 18696 SEA-GS-M8 |
| | | M8, 3-pin, screw-in | 192009 SEA-3GS-M8-S |
| | | M12, 4-pin, PG7 | 18666 SEA-GS-7 |
| | | M12, PG7, 4-pin for cable Ø 2.5 mm | 192008 SEA-4GS-7-2,5 |
| | | M12, 4-pin, PG9 | 18778 SEA-GS-9 |
| | | M12, 4 pin for 2 cables | 18779 SEA-GS-11-DUO |
| | | M12 for 2 cables, 5-pin | 192010 SEA-5GS-11-DUO |
|  | HARAX plug, 4-pin | M12, 5-pin | 175487 SEA-M12-5GS-PG7 |
| | | | 525928 SEA-GS-HAR-4POL |
|  | Sub-D plug, 25-pin | | 527522 SD-SUB-D-ST25 |
| Connecting cable | | | |
|  | Connecting cable M8-M8 | 0.5 m | 175488 KM8-M8-GSGD-0,5 |
| | | 1.0 m | 175489 KM8-M8-GSGD-1 |
| | | 2.5 m | 165610 KM8-M8-GSGD-2,5 |
| | | 5.0 m | 165611 KM8-M8-GSGD-5 |
| | Connecting cable M12-M12 | 2.5 m | 18684 KM12-M12-GSGD-2,5 |
| | | 5.0 m | 18686 KM12-M12-GSGD-5 |
| 1.0 m | | 185499 KM12-M12-GSWD-1-4 | |
|  | Modular system for connecting cables | – | NEBU-... → Info 322 → Internet: nebu |
|  | DUO cable M12 | 2x straight socket | 18685 KM12-DUO-M8-GDGD |
| | | 2x straight/angled socket | 18688 KM12-DUO-M8-GDWD |
| | | 2x angled socket | 18687 KM12-DUO-M8-WDWD |

Terminal CPX

Accessories – Input module, digital

FESTO

| Ordering data | | | |
|-----------------|--|---------------|------------------------------|
| Designation | | Part No. | Type |
| Cover | | | |
| | Cover for CPX-AB-8-KL-4POL (IP65, IP67) – 8 cable through-feeds M9 – 1 cable through-feed for multi-pin plug | 538219 | AK-8KL |
| | Fittings kit | 538220 | VG-K-M9 |
| Screening plate | | | |
| | Screening plate for M12 connections | 526184 | CPX-AB-S-4-M12 |
| User manual | | | |
| | User manual | German | 526439 P.BE-CPX-EA-DE |
| | | English | 526440 P.BE-CPX-EA-EN |
| | | Spanish | 526441 P.BE-CPX-EA-ES |
| | | French | 526442 P.BE-CPX-EA-FR |
| | | Italian | 526443 P.BE-CPX-EA-IT |

Terminal CPX

Technical data – PROFIsafe input module

Function

The PROFIsafe input module has 8 input channels whose signal status is detected for safety-reasons, with the information transmitted to a suitable safety controller using the PROFIsafe safety protocol in combination with the appropriate fieldbus (PROFINET or PROFIBUS). This function is exclusively available for safety controllers using the PROFIsafe protocol, profile version 2.4.

Scope of application

- Input module for 24 V DC sensor supply voltage
- Supports connection blocks with M12 and terminal connection
- Module features can be parameterised
- Input module receives the voltage supply for the electronics and the sensors from the interlinking block
- Module protection and diagnostics through integrated electronic fuse protection



| Description | | | |
|--|---|---|--|
| Module-based passivation | | Channel-by-channel passivation | |
| While channel-by-channel passivation is disabled, the input module, in accordance with PROFIsafe specifica- | tion, switches all information in the input image to the safe status, even when there is only one channel error. | In the case of channel-by-channel passivation, when a channel error occurs, the input module switches the input information of the affected channel pair to 0, depending on the function mode. | <ul style="list-style-type: none"> • The input information for unaffected channel pairs does not change. • The input module remains integrated. • The input module indicates the current channel error status to the control unit via the input image. |
| Applications | | | |
| The inputs on the PROFIsafe input module can be combined for multi-channel sensor applications. Every two inputs form a channel pair, which is set separately with one of 11 function modes. | The function mode has an influence on the evaluation of the input signals, and optionally on the generation of clock signals. | There are five independent clock outputs available for safe operation of passive sensors; the pulse patterns are used in some operating modes to detect crossovers in the signal paths. | The input module is designed to ensure that the input channels provide either secure data or no data at all, even when a fault is present in the system. |
| Range of applications | | | |
| <ul style="list-style-type: none"> • Use as an input module for a higher-order safety controller. Several input modules can be used together and these monitor mutually independent sensors | <ul style="list-style-type: none"> • Use of multi-channel sensor applications with up to 8 secure inputs, which can be grouped and are suitable for configuration with the help of 11 different function modes | <ul style="list-style-type: none"> • Connection of different switches and sensors within the safety chain • Output of an identifier coded by DIL switch in the connection block CPX-AB-ID-P | <p> Note</p> <p>The safety integrity level, Performance Level and category for the system as a whole correspond to that of the component in the safety chain with the lowest characteristic value.</p> |
| Application examples | | | |
| <ul style="list-style-type: none"> • Two-hand circuit for starting a function • Emergency stop switch for incidents | <ul style="list-style-type: none"> • Operating mode selector switch with four positions • Rotary indexing table | <ul style="list-style-type: none"> • Light curtain • Acknowledge button with request | <ul style="list-style-type: none"> • End-position switches • Protective door with two NO switches |

Terminal CPX

Technical data – PROFIsafe input module

| General technical data | | | |
|--|--------------------------|-------------------|--|
| Type | | | CPX-F8DE-P |
| Number of inputs | | | 8 |
| Safety function | | | Reliable detection and evaluation of input statuses |
| Max. address capacity | Inputs | [byte] | 6 |
| | Outputs | [byte] | 7 |
| Max. cable length | | [m] | 200 |
| Max. power supply | | Per module | [A] |
| | | | 3 |
| Current consumption of module | | | [mA] |
| | | | Typ. 35 (power supply for electronics) |
| Operating voltage | Nominal value | | [V DC] |
| | Permissible range | | [V DC] |
| | | | 24 |
| | | | 20.4 ... 28.8 |
| Voltage drop per channel | | | [V] |
| | | | 0.6 |
| Residual ripple | | | [Vss] |
| | | | 2 within voltage range |
| Electrical isolation | | Channel – channel | |
| | | | No |
| Input characteristic | | | To IEC 61131-2, type 2 |
| Switching logic | | Inputs | |
| | | | PNP (positive switching) |
| Safety integrity level | As per EN62061 | | Reliable detection and evaluation of input statuses up to SIL CL3 |
| | As per EN61508 | | Reliable detection and evaluation of input statuses up to SIL 3 |
| Performance Level | | As per ISO13849 | |
| | | | Reliable detection and evaluation of input statuses up to Cat 4 and PL e |
| Failure rate per hour (PFH) | | | 1.0×10^{-9} |
| Certificate issuing authority | | | 01/205/5444.00/15 |
| LED displays | Group diagnostics | | 1 |
| | Channel diagnostics | | 8 |
| | Channel status | | 8 |
| | Failsafe protocol active | | 1 |
| Diagnostics | | | <ul style="list-style-type: none"> • Short circuit per channel • Undervoltage • Overvoltage • Excessive temperature • Crossover per channel • Wire break per channel • Communication • Process data error • Self test |
| Control elements | | | DIL switches |
| Degree of protection to EN 60529 | | | Depending on connection block |
| Grid dimension | | [mm] | 50 |
| Dimensions (incl. interlinking block and connection block) W x L x H | | | [mm] |
| | | | 50 x 107 x 55 |

Terminal CPX

Technical data – PROFIsafe input module

| Materials | |
|-------------------|----------------|
| Note on materials | RoHS compliant |

| Operating and environmental conditions | | |
|--|------|---------------------------|
| Ambient temperature | [°C] | -5 ... +50 |
| Storage temperature | [°C] | -20 ... +70 |
| CE marking (see declaration of conformity) | | To EC Machinery Directive |
| Approval certificate | | c UL us Recognised (OL) |

Connection and display components

CPX-F8DE-P

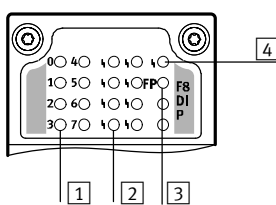

- 1 Channel-related status LEDs (green):
- 2 Channel-related error LEDs (red)
- 3 Fail-safe protocol active (green)
- 4 Error LED (red, module error)

| Combinations of bus nodes/control blocks with PROFIsafe input module | | |
|--|---------------|------------------------|
| Bus node/control block | Part No. | PROFIsafe input module |
| | | CPX-F8DE-P |
| CPX-FB13 | 195740 | ■ |
| CPX-FB33 | 548755 | ■ |
| CPX-M-FB34 | 548751 | ■ |
| CPX-M-FB35 | 548749 | ■ |



Note

The PROFIsafe input module CPX-F8DE-P can only be interfaced as of software release 21 or release 30 (in the case of CPX-FB13).

Terminal CPX

Technical data – PROFIsafe input module

| Connection block/PROFIsafe input module combinations | | |
|--|----------------|------------------------|
| Connection blocks | Part No. | PROFIsafe input module |
| | | CPX-F8DE-P |
| CPX-M-AB-4-M12X2-5POL | 549367 | ■ |
| CPX-M-AB-4-M12X2-5POL-T | 2639560 | ■ |
| CPX-AB-8-KL-4POL | 195708 | ■ |
| CPX-AB-ID-P | 2639571 | ■ |

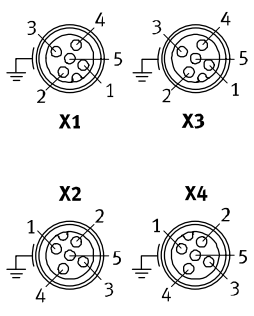
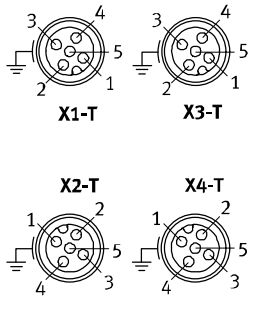
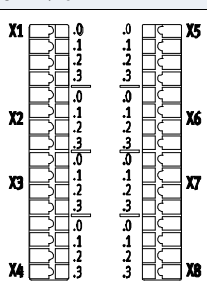
| Pin allocation | | |
|--|---|---|
| Connection block inputs | CPX-F8DE-P | |
| CPX-M-AB-4-M12X2-5POL | | |
|  <p>X1 X3 X2 X4</p> | <p>X1.1: 24 V_{SEN} X1.2: Input x+1 X1.3: 0 V_{SEN} X1.4: Input x X1.5: FE</p> <p>X2.1: 24 V_{SEN} X2.2: Input x+3 X2.3: 0 V_{SEN} X2.4: Input x+2 X2.5: FE</p> | <p>X3.1: 24 V_{SEN} X3.2: Input x+5 X3.3: 0 V_{SEN} X3.4: Input x+4 X3.5: FE</p> <p>X4.1: 24 V_{SEN} X4.2: Input x+7 X4.3: 0 V_{SEN} X4.4: Input x+6 X4.5: FE</p> |
| CPX-M-AB-4-M12X2-5POL-T | | |
|  <p>X1-T X3-T X2-T X4-T</p> | <p>X1-T.1: 24 V_{SEN x} X1-T.2: Input x+1 X1-T.3: 0 V_{SEN} X1-T.4: Input x X1-T.5: 24 V_{SEN x+1}</p> <p>X2.1: 24 V_{SEN x+2} X2.2: Input x+3 X2.3: 0 V_{SEN} X2.4: Input x+2 X2.5: 24 V_{SEN x+3}</p> | <p>X3.1: 24 V_{SEN x+4} X3.2: Input x+5 X3.3: 0 V_{SEN} X3.4: Input x+4 X3.5: 24 V_{SEN x+5}</p> <p>X4.1: 24 V_{SEN x+6} X4.2: Input x+7 X4.3: 0 V_{SEN} X4.4: Input x+6 X4.5: 24 V_{SEN x+7}</p> |
| CPX-AB-8-KL-4POL | | |
|  <p>X1 X5 X2 X6 X3 X7 X4 X8</p> | <p>X1.0: 24 V_{SEN} X1.1: 0 V_{SEN} X1.2: Input x X1.3: FE</p> <p>X2.0: 24 V_{SEN x} X2.1: 24 V_{SEN x+1} X2.2: Input x+1 X2.3: FE</p> <p>X3.0: 24 V_{SEN} X3.1: 0 V_{SEN} X3.2: Input x+2 X3.3: FE</p> <p>X4.0: 24 V_{SEN x+2} X4.1: 24 V_{SEN x+3} X4.2: Input x+3 X4.3: FE</p> | <p>X5.0: 24 V_{SEN} X5.1: 0 V_{SEN} X5.2: Input x+4 X5.3: FE</p> <p>X6.0: 24 V_{SEN x+4} X6.1: 24 V_{SEN x+5} X6.2: Input x+5 X6.3: FE</p> <p>X7.0: 24 V_{SEN} X7.1: 0 V_{SEN} X7.2: Input x+6 X7.3: FE</p> <p>X8.0: 24 V_{SEN x+6} X8.1: 24 V_{SEN x+7} X8.2: Input x+7 X8.3: FE</p> |





Terminal CPX

Technical data – PROFIsafe input module

| Interlinking block/PROFIsafe input module combinations | | | |
|--|----------|------------------------|---|
| Interlinking blocks | Part No. | PROFIsafe input module | |
| | | CPX-F8DE-P | |
| CPX-GE-EV-S | 195746 | | - |
| CPX-GE-EV-S-7/8-4POL | 541248 | | - |
| CPX-GE-EV-S-7/8-5POL | 541244 | | - |
| CPX-M-GE-EV-S-7/8-CIP-4P | 568956 | | ■ |
| CPX-M-GE-EV-S-7/8-5POL | 550208 | | ■ |
| CPX-M-GE-EV-S-PP-5POL | 563057 | | ■ |
| CPX-GE-EV | 195742 | | - |
| CPX-M-GE-EV | 550206 | | ■ |
| CPX-M-GE-EV-FVO | 567806 | | - |
| CPX-GE-EV-Z | 195744 | | - |
| CPX-GE-EV-Z-7/8-4POL | 541250 | | - |
| CPX-GE-EV-Z-7/8-5POL | 541246 | | - |
| CPX-M-GE-EV-Z-7/8-5POL | 550210 | | ■ |
| CPX-M-GE-EV-Z-PP-5POL | 563058 | | ■ |
| CPX-GE-EV-V | 533577 | | - |
| CPX-GE-EV-V-7/8-4POL | 541252 | | - |

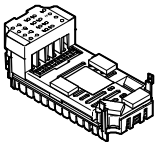
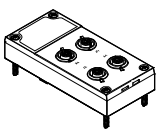
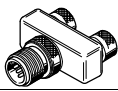
Terminal CPX

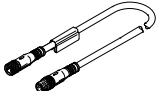
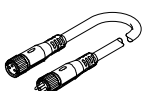
Accessories – PROFIsafe input module

| Ordering data | | | | Part No. | Type |
|---|---|---|------------------------|---------------------------|-------------------------------------|
| Description | | | | | |
| PROFIsafe input module | | | | | |
|  | 8 digital inputs, positive logic (PNP), for reliable detection and evaluation of input statuses | | 2597424 | | CPX-F8DE-P |
| Connection block | | | | | |
|  | Polymer | Spring-loaded terminal, 32-pin | | 195708 | CPX-AB-8-KL-4POL |
| | | 8-way DIL switch | | 2639571 | CPX-AB-ID-P |
| | Metal | 4x socket M12, 5-pin | Unlocked sensor supply | 549367 | CPX-M-AB-4-M12X2-5POL |
| | | | Clocked sensor supply | 2639560 | CPX-M-AB-4-M12X2-5POL-T |
| Plug connector | | | | | |
|  | Push-in T-connector | 2x socket, M12, 5-pin 1x plug connector M12, 4-pin | | 541596 | NEDU-M12D5-M12T4 |
|  | Plug connector | M12, PG7 | | 18666 | SEA-GS-7 |
| | | M12, PG7, 4-pin for cable Ø 2.5mm | | 192008 | SEA-4GS-7-2,5 |
| | | M12, PG9 | | 18778 | SEA-GS-9 |
| | | M12 for 2 cables | | 18779 | SEA-GS-11-DUO |
| | | M12 for 2 cables, 5-pin | | 192010 | SEA-5GS-11-DUO |
| | | M12, 5-pin | 175487 | SEA-M12-5GS-PG7 | |
| Connecting cable | | | | | |
|  | Connecting cable M12-M12 | Straight plug connector – straight socket | 2.5 m | 18684 | KM12-M12-GSGD-2,5 |
| | | | 5.0 m | 18686 | KM12-M12-GSGD-5 |
| | | Straight plug connector – angled socket | 1.0 m | 185499 | KM12-M12-GSWD-1-4 |
|  | Modular system for all types of connecting cable | | | – | NEBU-... → Internet: nebu |
|  | DUO cable M12 | 2x straight socket | | 18685 | KM12-DUO-M8-GDGD |
| | | 2x straight/angled socket | | 18688 | KM12-DUO-M8-GDWD |
| | | 2x angled socket | | 18687 | KM12-DUO-M8-WDWD |
| User documentation | | | | | |
|  | User documentation for PROFIsafe input module | German | 8035496 | P.BE-CPX-F8DE-P-DE | |
| | | English | 8035497 | P.BE-CPX-F8DE-P-EN | |
| | | Spanish | 8035498 | P.BE-CPX-F8DE-P-ES | |
| | | French | 8035499 | P.BE-CPX-F8DE-P-FR | |
| | | Italian | 8035500 | P.BE-CPX-F8DE-P-IT | |
| | | Chinese | 8035501 | P.BE-CPX-F8DE-P-ZH | |

Terminal CPX

Technical data – Input module, digital, 16 inputs

Function

Digital input modules enable the connection of two-wire and three-wire sensors (proximity sensors, inductive or capacitive sensors, etc.).

Depending on the connection block selected, the module supports various connection concepts with different numbers of sockets (single or double allocation).

Application

- Input modules for 24 V DC sensor supply voltage
- PNP logic
- Module features can be parameterised
- The input module receives the voltage supply for the electronics and the sensors from the interlinking block
- Module protection and diagnostics through integrated electronic fuse protection



| General technical data | | | | |
|--|------------------------|--|---|-------------------------------------|
| Type | | CPX-16DE | CPX-M-16DE-D | CPX-L-16DE |
| Number of inputs | | 16 | 16 | 16 |
| Max. residual current of inputs per module | [A] | 1.8 | 1.8 | 1.8 |
| Intrinsic current consumption at operating voltage | [mA] | Typically 15 | Typically 34 | Typically 15 |
| Fuse protection | | Internal electronic fuse per module | Internal electronic fuse per channel pair, additional safety fuse | Internal electronic fuse per module |
| Nominal operating voltage | [V DC] | 24 | 24 | 24 |
| Operating voltage range | [V DC] | 18 ... 30 | 18 ... 30 | 18 ... 30 |
| Electrical isolation | Channel – channel | No | No | No |
| | Channel – internal bus | No | No | No |
| Switching level | Signal 0 | [V DC] ≤ 5 | ≤ 5 | ≤ 5 |
| | Signal 1 | [V DC] ≥ 11 | ≥ 11 | ≥ 15 |
| Input debounce time | [ms] | 3 (0.1 ms, 10 ms, 20 ms parameterisable) | | |
| Input characteristic | | IEC 1131-T2 | IEC 1131-T2 | IEC 1131-T2, type 01 |
| Switching logic | | Positive logic (PNP) | Positive logic (PNP) | Positive logic (PNP) |
| LED displays | Group diagnostics | 1 | 1 | 1 |
| | Channel diagnostics | – | 16 | – |
| | Channel status | 16 | 16 | 16 |
| Diagnostics | | Short circuit/overload per channel | | |
| Parameterisation | | <ul style="list-style-type: none"> • Module monitoring • Behaviour after short circuit • Input debounce time • Signal extension time | | |
| Protection class to EN 60529 | | Depending on connection block | Depending on connection block | IP20 |
| Temperature range | Operation | [°C] –5 ... +50 | –5 ... +50 | –5 ... +50 |
| | Storage/transport | [°C] –20 ... +70 | –20 ... +70 | –20 ... +70 |
| Materials | | Reinforced PA, PC | Reinforced PA, PC | Reinforced PA |
| Note on materials | | – | – | RoHS-compliant |
| Grid dimension | [mm] | 50 | 50 | 50 |
| Dimensions (incl. interlinking block and connection block) W x L x H | [mm] | 50 x 107 x 50 | 50 x 107 x 50 | 50 x 107 x 41 |
| Product weight | [g] | 38 | 38 | Approx. 170 |

Terminal CPX

Technical data – Input module, digital, 16 inputs

Connection and display components

CPX-16DE

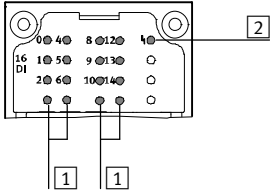

- 1 Status LEDs (green)
For allocation to inputs
→ pin allocation for module
- 2 Error LED (red, module error)

CPX-M-16DE-D

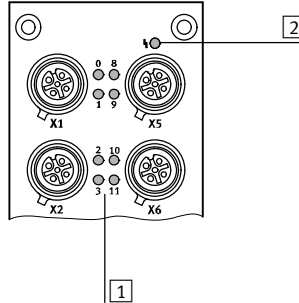

- 1 Common status LEDs
(green)/error LEDs (red) for each
input signal
- 2 Error LED (red, module error)

CPX-L-16DE

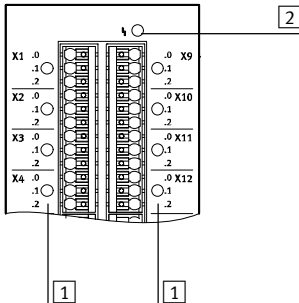

- 1 Status LEDs (green)
for each input signal
- 2 Error LED (red, module error)

Connection block/digital input module combinations

| Connection blocks | Part No. | Digital input modules | | |
|-----------------------|----------|-----------------------|--------------|------------|
| | | CPX-16DE | CPX-M-16DE-D | CPX-L-16DE |
| CPX-AB-8-M8X2-4POL | 541256 | ■ | – | – |
| CPX-AB-8-M12X2-5POL | 3606900 | – | ■ | – |
| CPX-AB-8-KL-4POL | 195708 | ■ | – | – |
| CPX-AB-1-SUB-BU-25POL | 525676 | ■ | – | – |
| CPX-M-AB-8-M12X2-5POL | 549335 | – | ■ | – |

Terminal CPX

Technical data – Input module, digital, 16 inputs

| Pin allocation | | |
|------------------------------|---|---|
| Connection block inputs | CPX-16DE | |
| CPX-AB-8-M8x2-4POL | | |
| | <p>X1.1: 24 V_{SEN} X1.2: Input x+1 X1.3: 0 V_{SEN} X1.4: Input x</p> <p>X2.1: 24 V_{SEN} X2.2: Input x+3 X2.3: 0 V_{SEN} X2.4: Input x+2</p> <p>X3.1: 24 V_{SEN} X3.2: Input x+5 X3.3: 0 V_{SEN} X3.4: Input x+4</p> <p>X4.1: 24 V_{SEN} X4.2: Input x+7 X4.3: 0 V_{SEN} X4.4: Input x+6</p> | <p>X5.1: 24 V_{SEN} X5.2: Input x+9 X5.3: 0 V_{SEN} X5.4: Input x+8</p> <p>X6.1: 24 V_{SEN} X6.2: Input x+11 X6.3: 0 V_{SEN} X6.4: Input x+10</p> <p>X7.1: 24 V_{SEN} X7.2: Input x+13 X7.3: 0 V_{SEN} X7.4: Input x+12</p> <p>X8.1: 24 V_{SEN} X8.2: Input x+15 X8.3: 0 V_{SEN} X8.4: Input x+14</p> |
| CPX-AB-8-KL-4POL | | |
| | <p>X1.0: Input x+8 X1.1: 24 V_{SEN} X1.2: Input x X1.3: FE</p> <p>X2.0: Input x+9 X2.1: 24 V_{SEN} X2.2: Input x+1 X2.3: FE</p> <p>X3.0: Input x+10 X3.1: 24 V_{SEN} X3.2: Input x+2 X3.3: FE</p> <p>X4.0: Input x+11 X4.1: 24 V_{SEN} X4.2: Input x+3 X4.3: FE</p> | <p>X5.0: Input x+12 X5.1: 0 V_{SEN} X5.2: Input x+4 X5.3: FE</p> <p>X6.0: Input x+13 X6.1: 0 V_{SEN} X6.2: Input x+5 X6.3: FE</p> <p>X7.0: Input x+14 X7.1: 0 V_{SEN} X7.2: Input x+6 X7.3: FE</p> <p>X8.0: Input x+15 X8.1: 0 V_{SEN} X8.2: Input x+7 X8.3: FE</p> |
| CPX-AB-1-SUB-BU-25POL | | |
| | <p>1: Input x 2: Input x+1 3: Input x+2 4: Input x+3 5: Input x+9 6: 24 V_{SEN} 7: Input x+11 8: 24 V_{SEN} 9: Input x+8 10: Input x+10 11: 24 V_{SEN} 12: 24 V_{SEN} 13: FE</p> | <p>14: Input x+4 15: Input x+5 16: Input x+6 17: Input x+7 18: Input x+12 19: Input x+13 20: Input x+14 21: Input x+15 22: 0 V_{SEN} 23: 0 V_{SEN} 24: 0 V_{SEN} 25: FE Housing: FE</p> |

Terminal CPX

Technical data – Input module, digital, 16 inputs

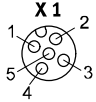
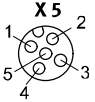
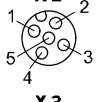
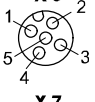
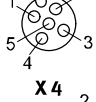
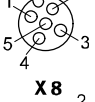
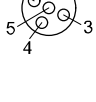
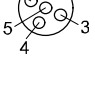
| Pin allocation | | CPX-M-16DE-D | |
|---|---|--|--|
| CPX-M-AB-8-M12X2-5POL and CPX-AB-8-M12X2-5POL | | | |
|  <p>X 1</p> |  <p>X 5</p> | <p>X1.1: 24 V_{Sx} X1.2: Input x+1 X1.3: 0 V_{Sx} X1.4: Input x X1.5: FE</p> | <p>X5.1: 24 V_{Sx+8} X5.2: Input x+9 X5.3: 0 V_{Sx+8} X5.4: Input x+8 X5.5: FE</p> |
|  <p>X 2</p> |  <p>X 6</p> | <p>X2.1: 24 V_{Sx+2} X2.2: Input x+3 X2.3: 0 V_{Sx+2} X2.4: Input x+2 X2.5: FE</p> | <p>X6.1: 24 V_{Sx+10} X6.2: Input x+11 X6.3: 0 V_{Sx+10} X6.4: Input x+10 X6.5: FE</p> |
|  <p>X 3</p> |  <p>X 7</p> | <p>X3.1: 24 V_{Sx+4} X3.2: Input x+5 X3.3: 0 V_{Sx+4} X3.4: Input x+4 X3.5: FE</p> | <p>X7.1: 24 V_{Sx+12} X7.2: Input x+13 X7.3: 0 V_{Sx+12} X7.4: Input x+12 X7.5: FE</p> |
|  <p>X 4</p> |  <p>X 8</p> | <p>X4.1: 24 V_{Sx+6} X4.2: Input x+7 X4.3: 0 V_{Sx+6} X4.4: Input x+6 X4.5: FE</p> | <p>X8.1: 24 V_{Sx+14} X8.2: Input x+15 X8.3: 0 V_{Sx+14} X8.4: Input x+14 X8.5: FE</p> |







Terminal CPX

Technical data – Input module, digital, 16 inputs

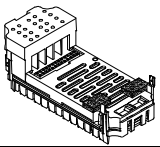
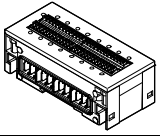
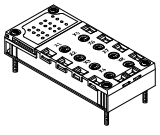
| Pin allocation | | CPX-L-16DE | |
|-------------------------|---|--|--|
| Connection block inputs | | | |
| | <p>X1.0: 24 V_{SEN}</p> <p>X1.1: Input x</p> <p>X1.2: 0 V_{SEN}</p> <p>X2.0: 24 V_{SEN}</p> <p>X2.1: Input x+1</p> <p>X2.2: 0 V_{SEN}</p> <p>X3.0: 24 V_{SEN}</p> <p>X3.1: Input x+2</p> <p>X3.2: 0 V_{SEN}</p> <p>X4.0: 24 V_{SEN}</p> <p>X4.1: Input x+3</p> <p>X4.2: 0 V_{SEN}</p> <p>X5.0: 24 V_{SEN}</p> <p>X5.1: Input x+4</p> <p>X5.2: 0 V_{SEN}</p> <p>X6.0: 24 V_{SEN}</p> <p>X6.1: Input x+5</p> <p>X6.2: 0 V_{SEN}</p> <p>X7.0: 24 V_{SEN}</p> <p>X7.1: Input x+6</p> <p>X7.2: 0 V_{SEN}</p> <p>X8.0: 24 V_{SEN}</p> <p>X8.1: Input x+7</p> <p>X8.2: 0 V_{SEN}</p> | <p>X9.0: 24 V_{SEN}</p> <p>X9.1: Input x+8</p> <p>X9.2: 0 V_{SEN}</p> <p>X10.0: 24 V_{SEN}</p> <p>X10.1: Input x+9</p> <p>X10.2: 0 V_{SEN}</p> <p>X11.0: 24 V_{SEN}</p> <p>X11.1: Input x+10</p> <p>X11.2: 0 V_{SEN}</p> <p>X12.0: 24 V_{SEN}</p> <p>X12.1: Input x+11</p> <p>X12.2: 0 V_{SEN}</p> <p>X13.0: 24 V_{SEN}</p> <p>X13.1: Input x+12</p> <p>X13.2: 0 V_{SEN}</p> <p>X14.0: 24 V_{SEN}</p> <p>X14.1: Input x+13</p> <p>X14.2: 0 V_{SEN}</p> <p>X15.0: 24 V_{SEN}</p> <p>X15.1: Input x+14</p> <p>X15.2: 0 V_{SEN}</p> <p>X16.0: 24 V_{SEN}</p> <p>X16.1: Input x+15</p> <p>X16.2: 0 V_{SEN}</p> | |

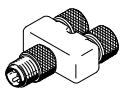
Terminal CPX

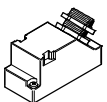
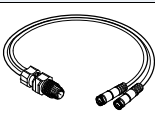
Accessories – Input module, digital, 16 inputs

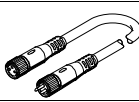
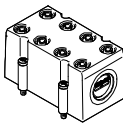
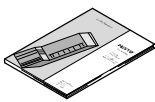
| Ordering data | | | | | | |
|---|--|--------------------------------|-----------------------|--|--------------------------------------|------------------------|
| Designation | | | Part No. | Type | | |
| Input module, digital | | | | | | |
|  | 16 digital inputs, internal electronic fuse per module | | 543815 | CPX-16DE | | |
| | 16 digital inputs, internal electronic fuse per channel pair, for CPX in metal | | 550202 | CPX-M-16DE-D | | |
|  | 16 digital inputs, internal electronic fuse per module, for CPX in plastic, including interlinking block and connection block with spring-loaded terminals | | 572606 | CPX-L-16DE-16-KL-3POL | | |
| Connection block | | | | | | |
|  | Plastic | 8x socket, M8, 4-pin | 541256 | CPX-AB-8-M8X2-4POL | | |
| | | 8x socket, M12, 5-pin | 3606900 | CPX-AB-8-M12X2-5POL  | | |
| | | Spring-loaded terminal, 32-pin | 195708 | CPX-AB-8-KL-4POL | | |
| | | 1x socket, Sub-D, 25-pin | 525676 | CPX-AB-1-SUB-BU-25POL | | |
| | Metal | 8x socket, M12, 5-pin | 549335 | CPX-M-AB-8-M12X2-5POL | | |
| Plug | | | | | | |
|  | Push-in T-connector | 2x socket, M8, 3-pin | 544391 | NEDU-M8D3-M8T4 | | |
| | | 1x plug, M8, 4-pin | | | | |
|  | Plug, M8, 3-pin | Solderable | 18696 | SEA-GS-M8 | | |
| | | Screw-in | 192009 | SEA-3GS-M8-S | | |
|  | Plug, Sub-D, 25-pin | | 527522 | SD-SUB-D-ST25 | | |
| Connecting cable | | | | | | |
|  | DUO cable M8-2xM8, 4-pin/2x3-pin | | 2x straight socket | 574591 | NEDU-L2R1-M8G3-K-1L1-1L2-M8G4 | |
| | Connecting cable M8-M8 | | | | | |
|  | | | | 0.5 m | 175488 | KM8-M8-GSGD-0,5 |
| | | | | 1.0 m | 175489 | KM8-M8-GSGD-1 |
| | | | | 2.5 m | 165610 | KM8-M8-GSGD-2,5 |
| | | | | 5.0 m | 165611 | KM8-M8-GSGD-5 |
|  | Modular system for connecting cables | | – | NEBU... | → Internet: nebu | |
| Cover | | | | | | |
|  | Cover for CPX-AB-8-KL-4POL (IP65, IP67) – 8 cable through-feeds M9 – 1 cable through-feed for multi-pin plug | | 538219 | AK-8KL | | |
| | Fittings kit | | 538220 | VG-K-M9 | | |
| Manual | | | | | | |
|  | Manual | | German | 526439 | P.BE-CPX-EA-DE | |
| | | | English | 526440 | P.BE-CPX-EA-EN | |
| | | | Spanish | 526441 | P.BE-CPX-EA-ES | |
| | | | French | 526442 | P.BE-CPX-EA-FR | |
| | | | Italian | 526443 | P.BE-CPX-EA-IT | |

Terminal CPX

Technical data – Output module, digital

Function

Digital outputs control actuators such as individual valves, hydraulic valves, heating controllers and many more. Separate circuits are created using an additional power supply. Parallel connection of the outputs of a module enables consuming devices to be controlled with up to 4 A.

Applications

- Output module for 24 V DC supply voltage
- PNP logic
- Module features can be parameterised
- The output module receives the voltage supply for the electronics and the outputs from the interlinking block
- Module protection and diagnostics through integrated electronic fuse protection in each channel



| General technical data | | | CPX-4DA | CPX-8DA | CPX-8DA-H |
|--|------------------------|--------|---|---|--|
| Type | | | | | |
| No. of outputs | | | 4 | 8 | 8 |
| Max. power supply | Per module | [A] | 4 | | 8.4 |
| | Per channel | [A] | 1 (24 W lamp load, 4 channels can be connected in parallel) | 0.5 (12 W lamp load, 8 channels can be connected in parallel) | 2.1 (50 W lamp load), per channel pair |
| Fuse protection (short circuit) | | | Internal electronic fuse for each channel | | |
| Module current consumption (voltage supply for electronics) | | [mA] | Typically 16 | | Typically 34 |
| Operating voltage | Nominal value | [V DC] | 24 | | |
| | Permissible range | [V DC] | 18 ... 30 | | |
| Electrical isolation | Channel – channel | | No | | |
| | Channel – internal bus | | Yes, using an intermediate supply | | |
| Output characteristic curve | | | To IEC 1131-2 | | |
| Switching logic | | | Positive logic (PNP) | | |
| LED displays | Group diagnostics | | 1 | 1 | 1 |
| | Channel diagnostics | | 4 | 8 | 8 |
| | Channel status | | 4 | 8 | 8 |
| Diagnostics | | | <ul style="list-style-type: none"> • Short circuit/overload, channel x • Undervoltage of outputs | | |
| Parameterisation | | | <ul style="list-style-type: none"> • Module monitoring • Behaviour after short circuit • Fail-safe channel x • Forcing channel x • Idle mode channel x | | |
| Protection class to EN 60529 | | | Depending on connection block | | |
| Temperature range | Operation | [°C] | –5 ... +50 | | |
| | Storage/transport | [°C] | –20 ... +70 | | |
| Materials | | | Reinforced PA, PC | | |
| Grid dimension | | [mm] | 50 | | |
| Dimensions (incl. interlinking block and connection block) W x L x H | | [mm] | 50 x 107 x 50 | | |
| Weight | | [g] | 38 | | |

Terminal CPX

Technical data – Output module, digital

Connection and display components

CPX-4DA

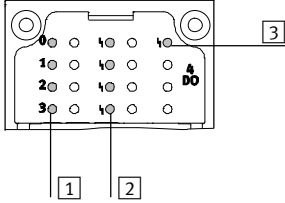

CPX-8DA

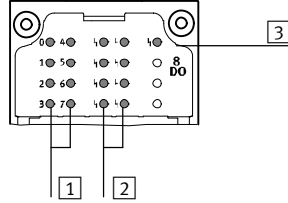

- 1 Status LEDs (yellow)
Allocation to outputs
→ Pin allocation for module
- 2 Channel-specific error LEDs (red)
- 3 Error LED (red, module error)

Connection block/digital output module combinations

| Connection blocks | Part No. | Digital output module | | |
|-----------------------|----------|-----------------------|---------|-----------|
| | | CPX-4DA | CPX-8DA | CPX-8DA-H |
| CPX-AB-8-M8-3POL | 195706 | ■ | ■ | – |
| CPX-AB-8-M8X2-4POL | 541256 | ■ | ■ | ■ |
| CPX-AB-4-M12X2-5POL | 195704 | ■ | ■ | – |
| CPX-AB-4-M12X2-5POL-R | 541254 | ■ | ■ | ■ |
| CPX-AB-8-KL-4POL | 195708 | ■ | ■ | ■ |
| CPX-AB-1-SUB-BU-25POL | 525676 | ■ | ■ | ■ |
| CPX-AB-4-HAR-4POL | 525636 | ■ | ■ | – |
| CPX-M-AB-4-M12X2-5POL | 549367 | ■ | ■ | ■ |

Pin allocation

| Connection block outputs | CPX-4DA | CPX-8DA |
|--------------------------|---|---|
| CPX-AB-8-M8-3POL | | |
| | <p>X1.1: n.c. X1.3: 0 V_{OUT} X1.4: Output x</p> <p>X2.1: n.c. X2.3: 0 V_{OUT} X2.4: Output x+1</p> <p>X3.1: n.c. X3.3: 0 V_{OUT} X3.4: Output x+1</p> <p>X4.1: n.c. X4.3: 0 V_{OUT} X4.4: n.c.</p> | <p>X5.1: n.c. X5.3: 0 V_{OUT} X5.4: Output x+2</p> <p>X6.1: n.c. X6.3: 0 V_{OUT} X6.4: Output x+3</p> <p>X7.1: n.c. X7.3: 0 V_{OUT} X7.4: Output x+3</p> <p>X8.1: n.c. X8.3: 0 V_{OUT} X8.4: n.c.</p> |
| | | <p>X1.1: n.c. X1.3: 0 V_{OUT} X1.4: Output x</p> <p>X2.1: n.c. X2.3: 0 V_{OUT} X2.4: Output x+1</p> <p>X3.1: n.c. X3.3: 0 V_{OUT} X3.4: Output x+2</p> <p>X4.1: n.c. X4.3: 0 V_{OUT} X4.4: Output x+3</p> |
| | | <p>X5.1: n.c. X5.3: 0 V_{OUT} X5.4: Output x+4</p> <p>X6.1: n.c. X6.3: 0 V_{OUT} X6.4: Output x+5</p> <p>X7.1: n.c. X7.3: 0 V_{OUT} X7.4: Output x+6</p> <p>X8.1: n.c. X8.3: 0 V_{OUT} X8.4: Output x+7</p> |

Terminal CPX

Technical data – Output module, digital



| Pin allocation | | | | | |
|--|--|--|--|--|--|
| Connection block outputs | | CPX-4DA | | CPX-8DA and CPX-8DA-H | |
| CPX-AB-8-M8X2-4POL | | | | | |
| | | X1.1: 0 V _{OUT} X1.2: Output x+1 X1.3: 0 V _{OUT} X1.4: Output x X2.1: 0 V _{OUT} X2.2: n.c. X2.3: 0 V _{OUT} X2.4: Output x+1 X3.1: 0 V _{OUT} X3.2: Output x+3 X3.3: 0 V _{OUT} X3.4: Output x+2 X4.1: 0 V _{OUT} X4.2: n.c. X4.3: 0 V _{OUT} X4.4: Output x+3 | X5.1: 0 V _{OUT} X5.2: n.c. X5.3: 0 V _{OUT} X5.4: n.c. X6.1: 0 V _{OUT} X6.2: n.c. X6.3: 0 V _{OUT} X6.4: n.c. X7.1: 0 V _{OUT} X7.2: n.c. X7.3: 0 V _{OUT} X7.4: n.c. X8.1: 0 V _{OUT} x+1 X8.2: n.c. X8.3: 0 V _{OUT} x+3 X8.4: n.c. | X1.1: 0 V _{OUT} X1.2: Output x+1 X1.3: 0 V _{OUT} X1.4: Output x X2.1: 0 V _{OUT} X2.2: Output x+3 X2.3: 0 V _{OUT} X2.4: Output x+2 X3.1: 0 V _{OUT} X3.2: Output x+5 X3.3: 0 V _{OUT} X3.4: Output x+4 X4.1: 0 V _{OUT} X4.2: Output x+7 X4.3: 0 V _{OUT} X4.4: Output x+6 | X5.1: 0 V _{OUT} X5.2: n.c. X5.3: 0 V _{OUT} X5.4: n.c. X6.1: 0 V _{OUT} X6.2: n.c. X6.3: 0 V _{OUT} X6.4: n.c. X7.1: 0 V _{OUT} X7.2: n.c. X7.3: 0 V _{OUT} X7.4: n.c. X8.1: 0 V _{OUT} X8.2: n.c. X8.3: 0 V _{OUT} X8.4: n.c. |
| CPX-AB-4-M12X2-5POL¹⁾ and CPX-AB-4-M12X2-5POL-R²⁾ | | | | | |
| | | X1.1: n.c. X1.2: Output x+1 X1.3: 0 V _{OUT} X1.4: Output x X1.5: FE X2.1: n.c. X2.2: n.c. X2.3: 0 V _{OUT} X2.4: Output x+1 X2.5: FE | X3.1: n.c. X3.2: Output x+3 X3.3: 0 V _{OUT} X3.4: Output x+2 X3.5: FE X4.1: n.c. X4.2: n.c. X4.3: 0 V _{OUT} X4.4: Output x+3 X4.5: FE | X1.1: n.c. X1.2: Output x+1 X1.3: 0 V _{OUT} X1.4: Output x X1.5: FE X2.1: n.c. X2.2: Output x+3 X2.3: 0 V _{OUT} X2.4: Output x+2 X2.5: FE | X3.1: n.c. X3.2: Output x+5 X3.3: 0 V _{OUT} X3.4: Output x+4 X3.5: FE X4.1: n.c. X4.2: Output x+7 X4.3: 0 V _{OUT} X4.4: Output x+6 X4.5: FE |
| CPX-AB-8-KL-4POL | | | | | |
| | | X1.0: n.c. X1.1: 0 V _{OUT} X1.2: Output x X1.3: FE X2.0: n.c. X2.1: 0 V _{OUT} X2.2: Output x+1 X2.3: FE X3.0: n.c. X3.1: 0 V _{OUT} X3.2: Output x+1 X3.3: FE X4.0: n.c. X4.1: 0 V _{OUT} X4.2: n.c. X4.3: FE | X5.0: n.c. X5.1: 0 V _{OUT} X5.2: Output x+2 X5.3: FE X6.0: n.c. X6.1: 0 V _{OUT} X6.2: Output x+3 X6.3: FE X7.0: n.c. X7.1: 0 V _{OUT} X7.2: Output x+3 X7.3: FE X8.0: n.c. X8.1: 0 V _{OUT} X8.2: n.c. X8.3: FE | X1.0: n.c. X1.1: 0 V _{OUT} X1.2: Output x X1.3: FE X2.0: n.c. X2.1: 0 V _{OUT} X2.2: Output x+1 X2.3: FE X3.0: n.c. X3.1: 0 V _{OUT} X3.2: Output x+2 X3.3: FE X4.0: n.c. X4.1: 0 V _{OUT} X4.2: Output x+3 X4.3: FE | X5.0: n.c. X5.1: 0 V _{OUT} X5.2: Output x+4 X5.3: FE X6.0: n.c. X6.1: 0 V _{OUT} X6.2: Output x+5 X6.3: FE X7.0: n.c. X7.1: 0 V _{OUT} X7.2: Output x+6 X7.3: FE X8.0: n.c. X8.1: 0 V _{OUT} X8.2: Output x+7 X8.3: FE |

1) Not suitable for CPX-8DA-H.

2) Speedcon quick lock, screening additionally on metal thread

Terminal CPX

Technical data – Output module, digital







| Pin allocation | | | | |
|---------------------------------------|---|---|---|---|
| Connection block outputs | CPX-4DA | | CPX-8DA and CPX-8DA-H | |
| CPX-AB-1-SUB-BU-25POL | | | | |
| | 1: Output x 2: Output x+1 3: Output x+1 4: n.c. 5: n.c. 6: 0 V _{OUT} 7: n.c. 8: 0 V _{OUT} 9: n.c. 10: n.c. 11: 0 V _{OUT} 12: 0 V _{OUT} 13: FE | 14: Output x+2 15: Output x+3 16: Output x+3 17: n.c. 18: n.c. 19: n.c. 20: n.c. 21: n.c. 22: 0 V _{OUT} 23: 0 V _{OUT} 24: 0 V _{OUT} 25: FE Housing: FE | 1: Output x 2: Output x+1 3: Output x+2 4: Output x+3 5: n.c. 6: 0 V _{OUT} 7: n.c. 8: 0 V _{OUT} 9: n.c. 10: n.c. 11: 0 V _{OUT} 12: 0 V _{OUT} 13: FE | 14: Output x+4 15: Output x+5 16: Output x+6 17: Output x+7 18: n.c. 19: n.c. 20: n.c. 21: n.c. 22: 0 V _{OUT} 23: 0 V _{OUT} 24: 0 V _{OUT} 25: FE Housing: FE |
| CPX-AB-4-HAR-4POL¹⁾ | | | | |
| | X1.1: n.c. X1.2: Output x+1 X1.3: 0 V _{OUT} X1.4: Output x X2.1: n.c. X2.2: n.c. X2.3: 0 V _{OUT} X2.4: Output x+1 | X3.1: n.c. X3.2: Output x+3 X3.3: 0 V _{OUT} X3.4: Output x+2 X4.1: n.c. X4.2: n.c. X4.3: 0 V _{OUT} X4.4: Output x+3 | X1.1: n.c. X1.2: Output x+1 X1.3: 0 V _{OUT} X1.4: Output x X2.1: n.c. X2.2: Output x+3 X2.3: 0 V _{OUT} X2.4: Output x+2 | X3.1: n.c. X3.2: Output x+5 X3.3: 0 V _{OUT} X3.4: Output x+4 X4.1: n.c. X4.2: Output x+7 X4.3: 0 V _{OUT} X4.4: Output x+6 |

1) Not suitable for CPX-8DA-H.

Terminal CPX

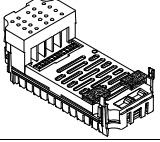
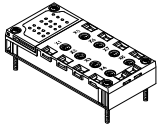
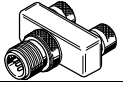
Accessories – Output module, digital

FESTO

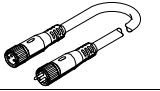
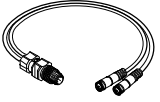
| Ordering data | | | | | | |
|---|---|--|--------|----------------------|-------------------------------|-----------------------|
| Designation | | | | Part No. | Type | |
| Output module, digital | | | | | | |
|  | 4 digital outputs, power supply 1 A per channel | | | 195754 | CPX-4DA | |
| | 8 digital outputs, power supply 0.5 A per channel | | | 541482 | CPX-8DA | |
| | 8 digital outputs, power supply 2.1 A per channel pair | | | 550204 | CPX-8DA-H | |
| Connection block | | | | | | |
|  | Plastic | 8x socket, M8, 3-pin | | 195706 | CPX-AB-8-M8-3POL | |
| | | 8x socket, M8, 4-pin | | 541256 | CPX-AB-8-M8X2-4POL | |
| | | 4x socket, M12, 5-pin | | 195704 | CPX-AB-4-M12X2-5POL | |
| | | 4x socket, M12 with quick-lock technology, 5-pin | | 541254 | CPX-AB-4-M12X2-5POL-R | |
| | | Spring clip terminal, 32-pin | | 195708 | CPX-AB-8-KL-4POL | |
| | | 1x Sub-D socket, 25-pin | | 525676 | CPX-AB-1-SUB-BU-25POL | |
| | | 4x socket, quick connection, 4-pin | | 525636 | CPX-AB-4-HAR-4POL | |
| | Metal | 4x socket, M12, 5-pin | | 549367 | CPX-M-AB-4-M12X2-5POL | |
| Plug | | | | | | |
|  | Push-in T-connector | 1x plug M8, 4-pin | | 2x socket M8, 3-pin | 544391 NEDU-M8D3-M8T4 | |
| | | 1x plug M12, 4-pin | | 2x socket M12, 5-pin | 541596 NEDU-M12D5-M12T4 | |
| | | | | 2x socket M8, 3-pin | 541597 NEDU-M8D3-M12T4 | |
|  | Plug | M8, 3-pin | | Solderable | 18696 SEA-GS-M8 | |
| | | | | Screw-in | 192009 SEA-3GS-M8-S | |
| | | M12, PG7 | | | | 18666 SEA-GS-7 |
| | | M12, PG7, 4-pin for cable Ø 2.5 mm | | | | 192008 SEA-4GS-7-2,5 |
| | | M12, PG9 | | | | 18778 SEA-GS-9 |
| | | M12 for 2 cables | | | | 18779 SEA-GS-11-DUO |
| | | M12 for 2 cables, 5-pin | | | | 192010 SEA-5GS-11-DUO |
|  | HARAX plug, 4-pin | | | | 175487 SEA-M12-5GS-PG7 | |
| | | | | | 525928 SEA-GS-HAR-4POL | |
| | Sub-D plug, 25-pin | | | | 527522 SD-SUB-D-ST25 | |
| Connecting cable | | | | | | |
|  | Connecting cable M8-M8 | | 0.5 m | 175488 | KM8-M8-GSGD-0,5 | |
| | | | 1.0 m | 175489 | KM8-M8-GSGD-1 | |
| | | | 2.5 m | 165610 | KM8-M8-GSGD-2,5 | |
| | | | 5.0 m | 165611 | KM8-M8-GSGD-5 | |
| | Connecting cable M12-M12 | | 2.5 m | 18684 | KM12-M12-GSGD-2,5 | |
| | | | 5.0 m | 18686 | KM12-M12-GSGD-5 | |
| 1.0 m | | | 185499 | KM12-M12-GSWD-1-4 | | |
|  | Modular system for connecting cables | | | - | NEBU-... → Internet: nebu | |
| |  | DUO cable M12-2xM8, 4-pin/2x3-pin | | 2x straight socket | 18685 | KM12-DUO-M8-GDGD |
| 1x straight | | | | 18688 | KM12-DUO-M8-GDWD | |
| 1x angled socket | | | | | | |
| 2x angled socket | | | | 18687 | KM12-DUO-M8-WDWD | |
| 2x straight socket | | | | 574591 | NEDU-L2R1-M8G3-K-1L1-1L2-M8G4 | |

Terminal CPX

Accessories – Output module, digital

FESTO

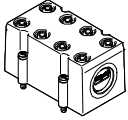
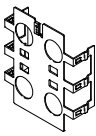
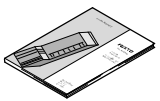
| Ordering data | | | |
|---|--|---------------|-------------------------------------|
| Designation | | Part No. | Type |
| Cover | | | |
|  | Cover for CPX-AB-8-KL-4POL (IP65, IP67) – 8 cable through-feeds M9 – 1 cable through-feed for multi-pin plug | 538219 | AK-8KL |
| | Fittings kit | 538220 | VG-K-M9 |
| Screening plate | | | |
|  | Screening plate for M12 connections | 526184 | CPX-AB-S-4-M12 |
| User manual | | | |
|  | User manual | German | 526439 P.BE-CPX-EA-DE |
| | | English | 526440 P.BE-CPX-EA-EN |
| | | Spanish | 526441 P.BE-CPX-EA-ES |
| | | French | 526442 P.BE-CPX-EA-FR |
| | | Italian | 526443 P.BE-CPX-EA-IT |

Terminal CPX

Technical data – Input/output module, digital

Application

- Digital multi I/O module for 24 V DC supply voltage
- Supports connection blocks with Sub-D, terminal connection and M12 connection (8-pin)
- As CPX-L with connection via spring-loaded terminals
- Module features can be parameterised
- The inputs receive the voltage supply for the electronics and the sensors from the interlinking block
- The outputs receive the voltage supply for the electronics and the outputs from the interlinking block
- Module protection and diagnostics through integrated electronic fuse protection for the sensor power supply and integrated electronic fuse protection in each output channel

Function

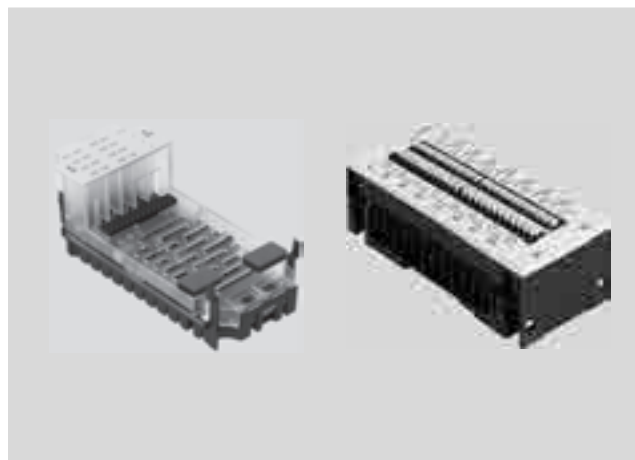
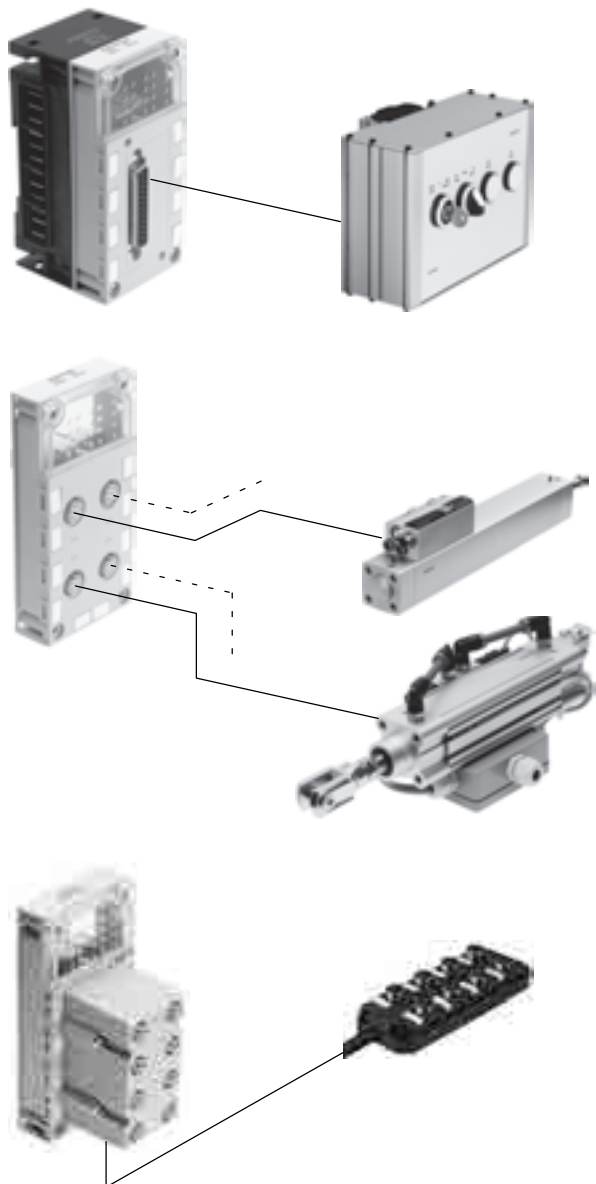

The multi I/O module controls devices with a high number of inputs and outputs per connection point. Since the module supports Sub-D connection blocks, consoles with pushbuttons and lamps can be connected to the terminal CPX using a minimal amount of installation space.

Up to 8 inputs and 8 outputs can be connected to one connection point with high protection to IP65.

Since the module supports the M12 connection block (8-pin), up to 4 cylinder/valve combinations with integrated sensors can be connected. Each cylinder/valve combination is supported by 2 inputs and 2 outputs per connection. It is therefore possible to control max. 2 solenoid coils and record signals from 2 sensors with a pre-assembled connecting cable.

Two inputs on 2 connections are bridged to provide support for the diagnostic module of the cylinder/valve combination. This means that 3 inputs and 2 outputs are available at 2 connections.

As an alternative to the Sub-D and M12 connection block (8-pin) for installation with high protection to IP65, the terminal connection block produces an identical result for installation with IP20 protection – or with IP65/IP67 protection with additional cover.

Subordinate I/O modules with multi-pin plug connection (Sub-D plug or multi-pin connecting cable for self-assembly) support the cost-effective and space-saving integration of critical installation areas such as energy chains or upstream functions.

Terminal CPX

Technical data – Input/output module, digital

| General technical data | | | |
|--|--------------------------|---|----------------------|
| Type | | CPX-8DE-8DA | CPX-L-8DE-8DA |
| Number | Inputs | 8 | 8 |
| | Outputs | 8 | 8 |
| Max. power supply per module | Sensor supply [A] | 0.7 | 1.8 |
| | Outputs [A] | 4 | 2 |
| Max. power supply per channel | [A] | 0.5 (12 W lamp load, channels 00 ... 003 can be connected in parallel to 04 ... 07) | 0.25 (6 W lamp load) |
| Fuse protection (short circuit) | | Internal electronic fuse per channel | |
| Intrinsic current consumption at nominal operating voltage | [mA] | Typically 22 | Typically 15 |
| Operating voltage | Nominal value [V DC] | 24 | 24 |
| | Permissible range [V DC] | 18 ... 30 | 18 ... 30 |
| Electrical isolation, inputs | Channel – channel | No | No |
| | Channel – internal bus | No | No |
| Electrical isolation, outputs | Channel – channel | No | No |
| | Channel – internal bus | Yes, using an intermediate supply | No |
| Characteristic | Inputs | IEC 1131-T2 | IEC 1131-T2, type 01 |
| | Outputs | IEC 1131-T2 | IEC 1131-T2 |
| Switching level, inputs | Signal 0 [V DC] | ≤ 5 | ≤ 5 |
| | Signal 1 [V DC] | ≥ 11 | ≥ 15 |
| Input debounce time | [ms] | 3 (01 ms, 10 ms, 20 ms parameterisable) | |
| Switching logic | | Positive logic (PNP) | Positive logic (PNP) |
| LED displays | Group diagnostics | 1 | 1 |
| | Channel diagnostics | – | – |
| | Channel status | 16 | 16 |
| Diagnostics | | <ul style="list-style-type: none"> • Short circuit/overload per channel • Undervoltage at outputs | |
| Parameterisation | | <ul style="list-style-type: none"> • Input debounce time • Failsafe per channel • Forces per channel • Idle mode per channel • Signal extension time • Module monitoring • Behaviour after short circuit | |
| Protection class to EN 60529 | | Depending on connection block | IP20 |
| Temperature range | Operation [°C] | –5 ... +50 | –5 ... +50 |
| | Storage/transport [°C] | –20 ... +70 | –20 ... +70 |
| Materials | | Reinforced PA, PC | Reinforced PA |
| Note on materials | | – | RoHS-compliant |
| Grid dimension | [mm] | 50 | 50 |
| Dimensions (incl. interlinking block and connection block) | [mm] | 50 x 107 x 50 | 50 x 107 x 41 |
| W x L x H | | | |
| Product weight | [g] | 38 | Approx. 170 |

Terminal CPX

Technical data – Input/output module, digital

Connection and display components

CPX-8DE-8DA

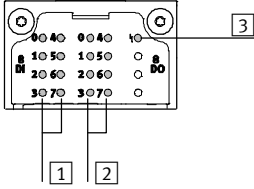

- 1 Status LEDs (green)
For allocation to inputs
→ pin allocation for module
- 2 Status LEDs (yellow)
For allocation to outputs
→ pin allocation for module
- 3 Error LED (red)
(module error)

CPX-L-8DE-8DA

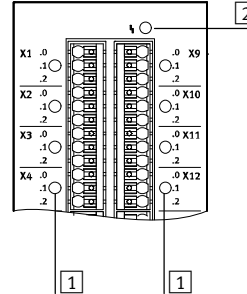

- 1 Status LEDs (green)
for each input signal
- 2 Error LED (red, module error)

Connection block/digital I/O module combinations

| Connection blocks | Part No. | Digital I/O module | |
|-----------------------|----------|--------------------|---------------|
| | | CPX-8DE-8DA | CPX-L-8DE-8DA |
| CPX-AB-4-M12-8POL | 526178 | ■ | – |
| CPX-AB-8-KL-4POL | 195708 | ■ | – |
| CPX-AB-1-SUB-BU-25POL | 525676 | ■ | – |

Pin allocation

Connection block inputs/outputs

CPX-8DE-8DA

CPX-AB-4-M12-8POL

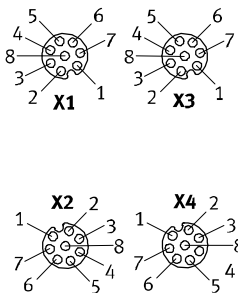

- X1.1: 24 V_{SEN}
- X1.2: Input x
- X1.3: Input x+1
- X1.4: 0 V_{SEN}
- X1.5: Output x
- X1.6: Output x+1
- X1.7: Input x+4
- X1.8: 0 V_{OUT}
- X2.1: 24 V_{SEN}
- X2.2: Input x+2
- X2.3: Input x+3
- X2.4: 0 V_{SEN}
- X2.5: Output x+2
- X2.6: Output x+3
- X2.7: Input x+6
- X2.8: 0 V_{OUT}

- X3.1: 24 V_{SEN}
- X3.2: Input x+4
- X3.3: Input x+5
- X3.4: 0 V_{SEN}
- X3.5: Output x+4
- X3.6: Output x+5
- X3.7: n.c.
- X3.8: 0 V_{OUT}
- X4.1: 24 V_{SEN}
- X4.2: Input x+6
- X4.3: Input x+7
- X4.4: 0 V_{SEN}
- X4.5: Output x+6
- X4.6: Output x+7
- X4.7: n.c.
- X4.8: 0 V_{OUT}

Terminal CPX

Technical data – Input/output module, digital

| Pin allocation | | CPX-8DE-8DA | |
|-----------------------|---|---|--|
| CPX-AB-8-KL-4POL | | | |
| | <p>X1.0: 24 V_{SEN} X1.1: 0 V_{SEN} X1.2: Input x X1.3: FE</p> <p>X2.0: Input x+4 X2.1: Input x+5 X2.2: Input x+1 X2.3: FE</p> <p>X3.0: 24 V_{SEN} X3.1: 0 V_{SEN} X3.2: Input x+2 X3.3: FE</p> <p>X4.0: Input x+6 X4.1: Input x+7 X4.2: Input x+3 X4.3: FE</p> | <p>X5.0: Output x+4 X5.1: 0 V_{OUT} X5.2: Output x X5.3: FE</p> <p>X6.0: Output x+5 X6.1: 0 V_{OUT} X6.2: Output x+1 X6.3: FE</p> <p>X7.0: Output x+6 X7.1: 0 V_{OUT} X7.2: Output x+2 X7.3: FE</p> <p>X8.0: Output x+7 X8.1: 0 V_{OUT} X8.2: Output x+3 X8.3: FE</p> | |
| CPX-AB-1-SUB-BU-25POL | | | |
| | <p>1: Input x 2: Input x+1 3: Input x+2 4: Input x+3 5: Input x+4 6: Input x+5 7: Input x+6 8: Input x+7 9: 24 V_{SEN} 10: 24 V_{SEN} 11: 0 V_{SEN} 12: 0 V_{SEN} 13: FE</p> | <p>14: Output x 15: Output x+1 16: Output x+2 17: Output x+3 18: Output x+4 19: Output x+5 20: Output x+6 21: Output x+7 22: 0 V_{OUT} 23: 0 V_{OUT} 24: 0 V_{OUT} 25: FE Housing: FE</p> | |

Terminal CPX



Technical data – Input/output module, digital

| Pin allocation | | |
|-------------------------|---|--|
| Connection block inputs | CPX-L-8DE-8DA | |
| | <p>X1.0: 24 V_{SEN} X1.1: Input x X1.2: 0 V_{SEN+out}</p> <p>X2.0: 24 V_{SEN} X2.1: Input x+1 X2.2: 0 V_{SEN+out}</p> <p>X3.0: 24 V_{SEN} X3.1: Input x+2 X3.2: 0 V_{SEN+out}</p> <p>X4.0: 24 V_{SEN} X4.1: Input x+3 X4.2: 0 V_{SEN+out}</p> <p>X5.0: 24 V_{SEN} X5.1: Input x+4 X5.2: 0 V_{SEN+out}</p> <p>X6.0: 24 V_{SEN} X6.1: Input x+5 X6.2: 0 V_{SEN+out}</p> <p>X7.0: 24 V_{SEN} X7.1: Input x+6 X7.2: 0 V_{SEN+out}</p> <p>X8.0: 24 V_{SEN} X8.1: Input x+7 X8.2: 0 V_{SEN+out}</p> | <p>X9.0: 24 V_{SEN} X9.1: Output x X9.2: 0 V_{SEN+out}</p> <p>X10.0: 24 V_{SEN} X10.1: Output x+1 X10.2: 0 V_{SEN+out}</p> <p>X11.0: 24 V_{SEN} X11.1: Output x+2 X11.2: 0 V_{SEN+out}</p> <p>X12.0: 24 V_{SEN} X12.1: Output x+3 X12.2: 0 V_{SEN+out}</p> <p>X13.0: 24 V_{SEN} X13.1: Output x+4 X13.2: 0 V_{SEN+out}</p> <p>X14.0: 24 V_{SEN} X14.1: Output x+5 X14.2: 0 V_{SEN+out}</p> <p>X15.0: 24 V_{SEN} X15.1: Output x+6 X15.2: 0 V_{SEN+out}</p> <p>X16.0: 24 V_{SEN} X16.1: Output x+7 X16.2: 0 V_{SEN+out}</p> |
| Interlinking block | CPX-L-8DE-8DA | |
| | <p>The module combines the 0 V potential of the power supply for electronics and sensors with the 0 V potential of the power supply for outputs in the CPX interlinking module.</p> | <p>If all poles of the outputs of an output module connected to the right of the input/output module are to be switched off, an appropriate interlinking block with additional power supply for outputs must be used to the right of the input/output module.</p> |

Terminal CPX

Accessories – Input/output module, digital

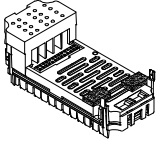
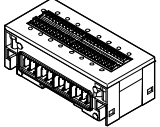
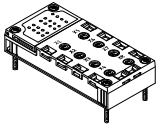
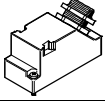
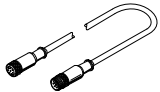
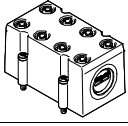
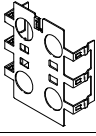
FESTO

| Ordering data | | | |
|---|---|--------------------------------|------------------------------|
| Designation | | Part No. | Type |
| Input/output module, digital | | | |
|  | 8 digital inputs, 8 digital outputs | 526257 | CPX-8DE-8DA |
|  | 8 digital inputs, 8 digital outputs, for CPX in plastic, including interlinking block and connection block with spring-loaded terminals | 572607 | CPX-L-8DE-8DA-16-KL-3POL |
| Connection block | | | |
|  | Plastic | 4x socket, M12, 8-pin | 526178 CPX-AB-4-M12-8POL |
| | | Spring-loaded terminal, 32-pin | 195708 CPX-AB-8-KL-4POL |
| | | 1x socket, Sub-D, 25-pin | 525676 CPX-AB-1-SUB-BU-25POL |
| Plug | | | |
|  | Plug, Sub-D, 25-pin | 527522 | SD-SUB-D-ST25 |
| Connecting cable | | | |
|  | Connecting cable M12 | 525617 | KM12-8GD8GS-2-PU |
| Cover | | | |
|  | Cover for CPX-AB-8-KL-4POL (IP65, IP67) – 8 cable through-feeds M9 – 1 cable through-feed for multi-pin plug | 538219 | AK-8KL |
| | Fittings kit | 538220 | VG-K-M9 |
| Screening plate | | | |
|  | Screening plate for M12 connections | 526184 | CPX-AB-S-4-M12 |
| Manual | | | |
|  | Manual | German | 526439 P.BE-CPX-EA-DE |
| | | English | 526440 P.BE-CPX-EA-EN |
| | | Spanish | 526441 P.BE-CPX-EA-ES |
| | | French | 526442 P.BE-CPX-EA-FR |
| | | Italian | 526443 P.BE-CPX-EA-IT |

Terminal CPX

Technical data – Counter module, digital

Function

The counter module has two channels. Depending on the parameterisation, these can independently be used as counter inputs or as incremental value encoder inputs or SSI. The counter module additionally has one output per channel. The outputs can either be controlled by a counter channel or an incremental value encoder channel, i.e. through an event such as "Comparative value reached". Alternatively, outputs can also be controlled via process data.

Application

- Continuous counting
- One-off counting to count limit
- One-off counting to count limit, return to load value
- Periodic counting
- Measurement of frequencies
- Measurement of rotational speeds
- Measurement of duty cycle
- Measurement of position
- Measurement of speed
- Measurement with pulse generators
- Measurement with pulse generators and direction encoders
- Measurement with incremental encoders
- Measurement with SSI absolute encoders



Description

Applications

- | | | | |
|---|--|--|---|
| <ul style="list-style-type: none">• Recording travel and speed of a conveyor• Position and speed synchronisation of conveyors and pick & place applications• Counting goods e.g. in packaging installations | <ul style="list-style-type: none">• Systems for filling by weight and volume• Monitoring motor speeds• Measuring equipment for determining the position of axis systems (linear, rotational) | <ul style="list-style-type: none">• Control of fast-switching valves• Control of the opening time of a valve• Activation of semiconductor relays | <ul style="list-style-type: none">• Temperature monitoring and rotational speed control for drives• Change of direction in fast drives• Control of motors with pulse-width modulation (PWM) |
|---|--|--|---|

Supported devices

- | | | | |
|---|--|---|--|
| <ul style="list-style-type: none">• 5 V incremental encoder, single-ended or differential, with two 90° phase offset tracks | <ul style="list-style-type: none">• 24 V incremental encoder, single-ended, with two 90° phase offset tracks | <ul style="list-style-type: none">• 24 V pulse generator with or without direction level• 24 V direct current motors | <ul style="list-style-type: none">• Absolute encoder with SSI interface (13 bits to 25 bits) |
|---|--|---|--|

Terminal CPX

Technical data – Counter module, digital

FESTO

| General technical data | | | |
|---|--|--------|--|
| Type | CPX-2ZE2DA | | |
| Number | Inputs | | 2 |
| | Outputs | | 2 |
| Max. power supply per module | Inputs | [A] | 2 |
| | Outputs | [A] | 10 |
| Max. power supply per channel | | [A] | 5 (adjustable, 20 W lamp load) |
| Max. cable length | | [m] | 30 |
| Fuse protection (short circuit) | Internal electronic fuse per channel | | |
| Intrinsic current consumption at nominal operating voltage | | [mA] | Typically 35 |
| Operating voltage | Nominal value | [V DC] | 24 |
| | Permissible range | [V DC] | 18 ... 30 |
| Electrical isolation, inputs | Channel – channel | | No |
| | Channel – internal bus | | No |
| Electrical isolation, outputs | Channel – channel | | No |
| | Channel – internal bus | | Yes, using an intermediate supply |
| Characteristic curve | Inputs | | To IEC 1131-2, Type 02 |
| | Outputs | | IEC 1131-T2 |
| Switching level | Signal 0 | [V DC] | ≤ 5 |
| | Signal 1 | [V DC] | ≥ 11 |
| Input debounce time | | [μs] | 0.1 (0.2 μs, 0.4 μs, 0.8 μs, 1 μs, 2 μs, 4 μs, 8 μs, 10 μs, 50 μs, 100 μs, 500 μs, 1 ms, 3 ms, 10 ms, 20 ms parameterisable) |
| Switching logic | Inputs | | Positive logic (PNP) |
| | Outputs | | <ul style="list-style-type: none"> • Negative logic (NPN) • Positive logic (PNP) • Push-pull driver |
| LED displays | Group diagnostics | | 1 |
| | Channel diagnostics | | 2 |
| | Channel status | | 10 |
| | Module diagnostics | | 2 |
| Diagnostics | Operating mode-dependent diagnostics | | |
| Parameterisation | <ul style="list-style-type: none"> • Switch-on/off delay • Frequency output • Speed measurement • Pulse output • Pulse train • Rotational speed measurement • Frequency measurement • Duty cycle measurement • Engine operating mode • Determination of position • Pulse width modulation • One-off counting • Continuous counting • Periodic counting | | |
| Protection class to EN 60529 | IP65, IP67 | | |
| Temperature range | Operation | [°C] | –5 ... +50 |
| | Storage/transport | [°C] | –20 ... +70 |
| Certification | c UL us - Recognized (OL) | | |
| Housing material information | Plastic | | |
| Note on materials | RoHS-compliant | | |
| Grid dimension | | [mm] | 50 |
| Dimensions (incl. interlinking block and connection block) W x L x H | | [mm] | 50 x 107 x 50 |
| Product weight | | [g] | 130 |

Terminal CPX

Technical data – Counter module, digital

Connection and display components

CPX-2ZE2DA

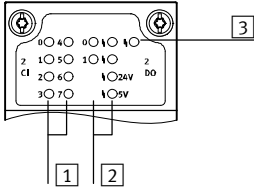

- 1 Status LEDs (green)
For allocation to inputs
→ Pin allocation for module
- 2 Status LEDs (yellow, red)
For allocation to outputs
→ Pin allocation for module
- 3 Error LED (red)
(module error)

Pin allocation

| Inputs/outputs | CPX-2ZE2DA | |
|----------------|---|---|
| | Channel 0 | Channel 1 |
| | <p>X1.0: Input X1.1: Input X1.2: Input X1.3: Input</p> <p>X2.0: Input X2.1: Input X2.2: 5 V DC X2.3: 0 V</p> <p>X3.0: 24 V DC X3.1: 0 V X3.2: 24 V DC for digital input DI X3.3: Digital input DI</p> <p>X4.0: 0 V for digital input DI X4.1: Digital output DO X4.2: Reference potential for DO X4.3: FE</p> | <p>X5.0: Input X5.1: Input X5.2: Input X5.3: Input</p> <p>X6.0: Input X6.1: Input X6.2: 5 V DC X6.3: 0 V</p> <p>X7.0: 24 V DC X7.1: 0 V X7.2: 24 V DC for digital input DI X7.3: Digital input DI</p> <p>X8.0: 0 V for digital input DI X8.1: Digital output DO X8.2: Reference potential for DO X8.3: FE</p> |



Note

The allocation and designation of inputs differs fundamentally depending on which type of encoder is connected. Appropriate allocation diagrams can be found in the user documentation for the counter module.

Terminal CPX

Accessories – Counter module, digital

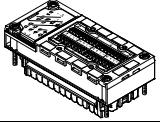
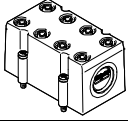

| Ordering data | | | | |
|---|--|---------|----------------|---------------------------|
| Description | | | Part No. | Type |
| Counter module, digital | | | | |
|  | 2 digital inputs, 2 digital outputs | | 576046 | CPX-2ZE2DA |
| Cover | | | | |
|  | Cover for CPX-2ZE2DA (IP65, IP67) – 8 cable through-feeds M9 – 1 cable through-feed for multi-pin plug | | 538219 | AK-8KL |
| | Fittings kit | | 538220 | VG-K-M9 |
| Manual | | | | |
|  | Manual counter module CPX-2ZE2DA | German | 8035733 | P.BE-CPX-2ZE2DA-DE |
| | | English | 8035734 | P.BE-CPX-2ZE2DA-EN |
| | | Spanish | 8035735 | P.BE-CPX-2ZE2DA-ES |
| | | French | 8035736 | P.BE-CPX-2ZE2DA-FR |
| | | Italian | 8035737 | P.BE-CPX-2ZE2DA-IT |
| | | Chinese | 8035738 | P.BE-CPX-2ZE2DA-ZH |

Terminal CPX

Technical data – Analogue module for inputs

Function

Analogue modules control devices with a standardised analogue interface such as sensors for pressure, temperature, flow rate, filling level, etc.

The analogue module supports various connection concepts with different numbers of sockets or terminals as appropriate to the connection block selected.

Application

- Analogue module for 0 ... 10 V, 0 ... 20 mA or 4 ... 20 mA
- Supports connection blocks with Sub-D, terminal connection and M12 connection
- Analogue module features can be parameterised
- Different data formats available
- Operation with and without galvanic isolation possible
- The analogue module receives the voltage supply for the electronics and the sensors from the interlinking block
- Analogue module protection and diagnostics through integrated electronic fuse protection



| General technical data | | | | | |
|---|--------------------------|----------------------------|---|--|----------------------------|
| Type | CPX-2AE-U-I | | CPX-4AE-U-I | | CPX-4AE-I |
| | Voltage input | Current input | Voltage input | Current input | Current input |
| No. of analogue inputs | 2 | | 4 | | 2 or 4 |
| Max. power supply per module [A] | 0.7 | | | | |
| Fuse protection | Internal electronic fuse | | | | |
| Current consumption from 24 V sensor supply (quiescent current) [mA] | Typically 50 | | | | |
| Current consumption from 24 V sensor supply (at full load) [A] | Max. 0.7 | | | | |
| Nominal operating voltage, load voltage [V DC] | 24 ±2% | | | | |
| Nominal operating voltage [V DC] | 24 | | | | |
| Operating voltage range [V DC] | 18 ... 30 | | | | |
| Signal range (parameterisable for each channel by means of DIL switch or software) | 0 ... 10 V | 0 ... 20 mA 4 ... 20 mA | 1 ... 5 V 0 ... 10 V -5 ... +5 V -10 ... +10 V | 0 ... 20 mA 4 ... 20 mA -20 ... +20 mA | 0 ... 20 mA 4 ... 20 mA |
| Operational error limit [%] | ±0.5 | – | ±0.3 | ±0.3 | ±0.6 |
| Basic error limit (at 25 °C) [%] | ±0.3 | – | ±0.2 | ±0.2 | ±0.5 |
| Repetition accuracy (at 25 °C) [%] | 0.15 | 0.15 | 0.1 | 0.1 | 0.15 |
| Input resistance | 100 kΩ | ≤ 100 Ω | 100 kΩ | ≤ 100 Ω | ≤ 100 Ω |
| Max. permissible input voltage [V DC] | 30 | – | -30 ... +30 | – | – |
| Max. permissible input current [mA] | – | 40 | – | Internally limited to 60 | 40 |
| Conversion time per channel [μs] | Typically 150 | | | | |
| Cycle time (module) [ms] | ≤ 4 | | ≤ 0.5 | | ≤ 10 |
| Data format | 12 bit + prefix | | 15 bit + prefix | | 12 bit + prefix |
| | Scalable to 15 bit | | Scalable to 15 bit | | Scalable to 15 bit |
| Cable length [m] | Max. 30 (shielded) | | | | |

Terminal CPX

Technical data – Analogue module for inputs

| General technical data | | | | | |
|--|------------------------------------|---|-----------------------------|---|----|
| Type | | CPX-2AE-U-I | CPX-4AE-U-I | CPX-4AE-I | |
| Electrical isolation | Channel – channel | No | | | |
| | Channel – internal bus | Yes, with external sensor supply | | | |
| LED displays | Group diagnostics | 1 | | | |
| | Channel diagnostics | Via flashing frequency of group diagnostics | 4 | Via flashing frequency of group diagnostics | |
| Diagnostics | Wire break per channel | | | | |
| | Limit value violation per channel | | | | |
| | Parameterisation error | | | | |
| | Short circuit, input signal | Overload at input | Short circuit, input signal | | |
| | – | Overflow/underflow | – | | |
| | – | Short circuit in sensor supply | – | | |
| Parameterisation | Data format | | | | |
| | Forces per channel | | | | |
| | Limit value monitoring per channel | | | | |
| | Measured value smoothing | | | | |
| | Signal range per channel | | | | |
| | Wire break monitoring per channel | | | | |
| | Behaviour after short circuit | | | | |
| | – | Behaviour after overload at input | – | | |
| | – | Sensor supply active | – | | |
| Protection class to EN 60529 | Depending on connection block | | | | |
| Temperature range | Operation | [°C] | –5 ... +50 | | |
| | Storage/transport | [°C] | –20 ... +70 | | |
| Materials | Reinforced PA, PC | | | | |
| Note on materials | – | | RoHS-compliant | – | |
| Grid dimension | [mm] | | 50 | | |
| Dimensions (incl. interlinking block and connection block) W x L x H | [mm] | | 50 x 107 x 50 | | |
| Product weight | [g] | | 38 | 46 | 38 |

Internal structure, basic representation

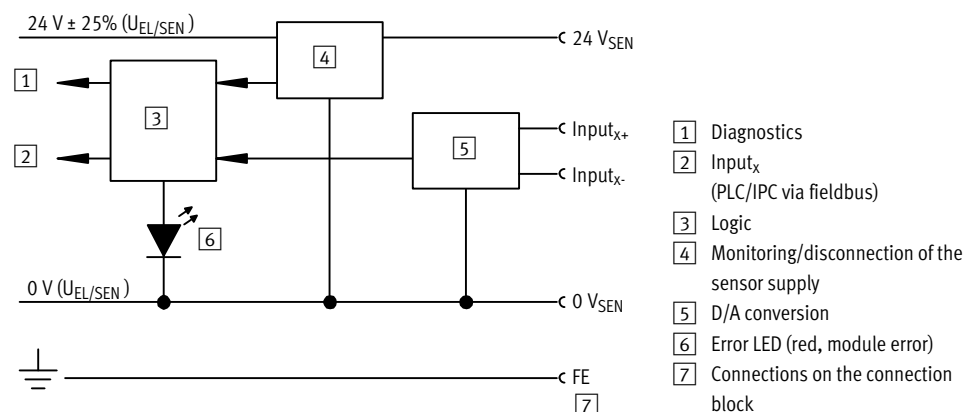

Terminal CPX

Technical data – Analogue module for inputs

Connection and display components

CPX-2AE-U-I and CPX-4AE-I

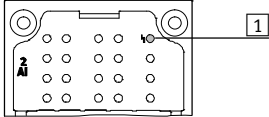

1 Error LED (red, module error)

CPX-4AE-U-I

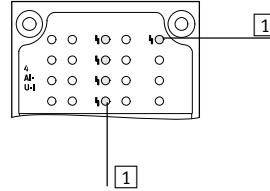

1 Error LED (red, module error)
2 Channel-related error LEDs (red)

Connection block/analogue module combinations

| Connection blocks | Part No. | Analogue module | | |
|-----------------------|----------|-----------------|-------------|-----------|
| | | CPX-2AE-U-I | CPX-4AE-U-I | CPX-4AE-I |
| CPX-AB-4-M12X2-5POL | 195704 | ■ | ■ | ■ |
| CPX-AB-4-M12X2-5POL-R | 541254 | ■ | ■ | ■ |
| CPX-AB-8-KL-4POL | 195708 | ■ | ■ | ■ |
| CPX-AB-1-SUB-BU-25POL | 525676 | ■ | ■ | ■ |
| CPX-M-AB-4-M12X2-5POL | 549367 | ■ | ■ | ■ |

Pin allocation

| Connection block inputs | CPX-2AE-U-I | CPX-4AE-U-I | CPX-4AE-I |
|--|---|---|---|
| CPX-AB-4-M12X2-5POL, CPX-AB-4-M12X2-5POL-R ¹⁾ and CPX-M-AB-4-M12X2-5POL | | | |
| | <p>X1.1: 24 V_{SEN} X1.2: Input U0+ X1.3: 0 V_{SEN} X1.4: Input U0- X1.5: FE²⁾</p> <p>X2.1: 24 V_{SEN} X2.2: Input I0+ X2.3: 0 V_{SEN} X2.4: Input I0- X2.5: FE²⁾</p> | <p>X3.1: 24 V_{SEN} X3.2: Input U1+ X3.3: 0 V_{SEN} X3.4: Input U1- X3.5: FE²⁾</p> <p>X4.1: 24 V_{SEN} X4.2: Input I1+ X4.3: 0 V_{SEN} X4.4: Input I1- X4.5: FE²⁾</p> | <p>X1.1: 24 V_{SEN} X1.2: Input 0+ X1.3: 0 V_{SEN} X1.4: Input 0- X1.5: FE²⁾</p> <p>X2.1: 24 V_{SEN} X2.2: Input 1+ X2.3: 0 V_{SEN} X2.4: Input 1- X2.5: FE²⁾</p> <p>X3.1: 24 V_{SEN} X3.2: Input 2+ X3.3: 0 V_{SEN} X3.4: Input 2- X3.5: FE²⁾</p> <p>X4.1: 24 V_{SEN} X4.2: Input 3+ X4.3: 0 V_{SEN} X4.4: Input 3- X4.5: FE²⁾</p> <p>X1.1: 24 V_{SEN} X1.2: Input I0+ X1.3: 0 V_{SEN} X1.4: Input I0- X1.5: FE²⁾</p> <p>X2.1: 24 V_{SEN} X2.2: Input I1+ X2.3: 0 V_{SEN} X2.4: Input I1- X2.5: FE²⁾</p> <p>X3.1: 24 V_{SEN} X3.2: Input I2+ X3.3: 0 V_{SEN} X3.4: Input I2- X3.5: FE²⁾</p> <p>X4.1: 24 V_{SEN} X4.2: Input I3+ X4.3: 0 V_{SEN} X4.4: Input I3- X4.5: FE²⁾</p> |
| CPX-AB-8-KL-4POL | | | |
| | <p>X1.0: 24 V_{SEN} X1.1: 0 V_{SEN} X1.2: Input U0- X1.3: FE</p> <p>X2.0: n.c. X2.1: n.c. X2.2: Input U0+ X2.3: FE</p> <p>X3.0: 24 V_{SEN} X3.1: 0 V_{SEN} X3.2: Input I0- X3.3: FE</p> <p>X4.0: n.c. X4.1: n.c. X4.2: Input I0+ X4.3: FE</p> | <p>X5.0: 24 V_{SEN} X5.1: 0 V_{SEN} X5.2: Input U1- X5.3: FE</p> <p>X6.0: n.c. X6.1: n.c. X6.2: Input U1+ X6.3: FE</p> <p>X7.0: 24 V_{SEN} X7.1: 0 V_{SEN} X7.2: Input I1- X7.3: FE</p> <p>X8.0: n.c. X8.1: n.c. X8.2: Input I1+ X8.3: FE</p> | <p>X1.0: 24 V_{SEN} X1.1: 0 V_{SEN} X1.2: Input 0- X1.3: FE</p> <p>X2.0: n.c. X2.1: n.c. X2.2: Input 0+ X2.3: FE</p> <p>X3.0: 24 V_{SEN} X3.1: 0 V_{SEN} X3.2: Input 1- X3.3: FE</p> <p>X4.0: n.c. X4.1: n.c. X4.2: Input 1+ X4.3: FE</p> <p>X5.0: 24 V_{SEN} X5.1: 0 V_{SEN} X5.2: Input 2- X5.3: FE</p> <p>X6.0: n.c. X6.1: n.c. X6.2: Input 2+ X6.3: FE</p> <p>X7.0: 24 V_{SEN} X7.1: 0 V_{SEN} X7.2: Input 3- X7.3: FE</p> <p>X8.0: n.c. X8.1: n.c. X8.2: Input 3+ X8.3: FE</p> <p>X1.0: 24 V_{SEN} X1.1: 0 V_{SEN} X1.2: Input I0- X1.3: FE</p> <p>X2.0: n.c. X2.1: n.c. X2.2: Input I0+ X2.3: FE</p> <p>X3.0: 24 V_{SEN} X3.1: 0 V_{SEN} X3.2: Input I1- X3.3: FE</p> <p>X4.0: n.c. X4.1: n.c. X4.2: Input I1+ X4.3: FE</p> <p>X5.0: 24 V_{SEN} X5.1: 0 V_{SEN} X5.2: Input I2- X5.3: FE</p> <p>X6.0: n.c. X6.1: n.c. X6.2: Input I2+ X6.3: FE</p> <p>X7.0: 24 V_{SEN} X7.1: 0 V_{SEN} X7.2: Input I3- X7.3: FE</p> <p>X8.0: n.c. X8.1: n.c. X8.2: Input I3+ X8.3: FE</p> |

1) Speedcon quick lock, shield additionally on metal thread
2) FE/shield additionally on metal thread

Terminal CPX

Technical data – Analogue module for inputs

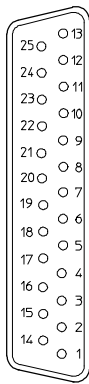
| Pin allocation | | | | | | | |
|---|--------------------------|-------------------------|--------------------------|-------------------------|--------------------------|-------------------------|--|
| Connection block inputs | CPX-2AE-U-I | | CPX-4AE-U-I | | CPX-4AE-I | | |
| CPX-AB-1-SUB-BU-25POL | | | | | | | |
|  | 1: Input U0- | 14: Input U1- | 1: Input 0- | 14: Input 2- | 1: Input I0- | 14: Input I2- | |
| | 2: Input U0+ | 15: Input U1+ | 2: Input 0+ | 15: Input 2+ | 2: Input I0+ | 15: Input I2+ | |
| | 3: Input I0- | 16: Input I1- | 3: Input 1- | 16: Input 3- | 3: Input I1- | 16: Input I3- | |
| | 4: Input I1+ | 17: Input I1+ | 4: Input 1+ | 17: Input 3+ | 4: Input I1+ | 17: Input I3+ | |
| | 5: n.c. | 18: 24 V _{SEN} | 5: n.c. | 18: 24 V _{SEN} | 5: n.c. | 18: 24 V _{SEN} | |
| | 6: n.c. | 19: n.c. | 6: n.c. | 19: n.c. | 6: n.c. | 19: n.c. | |
| | 7: n.c. | 20: 24 V _{SEN} | 7: n.c. | 20: 24 V _{SEN} | 7: n.c. | 20: 24 V _{SEN} | |
| | 8: n.c. | 21: n.c. | 8: n.c. | 21: n.c. | 8: n.c. | 21: n.c. | |
| | 9: 24 V _{SEN} | 22: 0 V _{SEN} | 9: 24 V _{SEN} | 22: 0 V _{SEN} | 9: 24 V _{SEN} | 22: 0 V _{SEN} | |
| | 10: 24 V _{SEN} | 23: 0 V _{SEN} | 10: 24 V _{SEN} | 23: 0 V _{SEN} | 10: 24 V _{SEN} | 23: 0 V _{SEN} | |
| | 11: 0 V _{SEN} | 24: 0 V _{SEN} | 11: 0 V _{SEN} | 24: 0 V _{SEN} | 11: 0 V _{SEN} | 24: 0 V _{SEN} | |
| | 12: 0 V _{SEN} | 25: FE | 12: 0 V _{SEN} | 25: FE | 12: 0 V _{SEN} | 25: FE | |
| | 13: Shield ¹⁾ | Housing: FE | 13: Shield ¹⁾ | Housing: FE | 13: Shield ¹⁾ | Housing: FE | |

1) Connect shield to functional earth FE

Terminal CPX

Accessories – Analogue module for inputs

FESTO

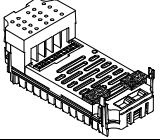
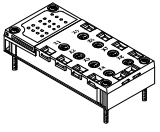
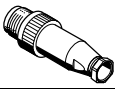
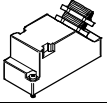
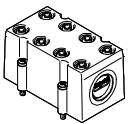
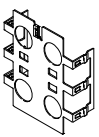
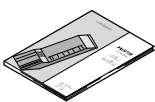
| Ordering data | | Part No. | Type |
|---|--|--|------------------------------|
| Input module, analogue | | | |
|  | 2 analogue current or voltage inputs | 526168 | CPX-2AE-U-I |
| | 4 analogue current or voltage inputs | 573710 | CPX-4AE-U-I |
| | 2 or 4 analogue current inputs | 541484 | CPX-4AE-I |
| Connection block | | | |
|  | Plastic | 4x socket, M12, 5-pin | 195704 CPX-AB-4-M12X2-5POL |
| | | 4x socket, M12 with quick-lock technology, 5-pin | 541254 CPX-AB-4-M12X2-5POL-R |
| | | Spring-loaded terminal, 32-pin | 195708 CPX-AB-8-KL-4POL |
| | | 1x socket, Sub-D, 25-pin | 525676 CPX-AB-1-SUB-BU-25POL |
| | Metal | 4x socket, M12, 5-pin | 549367 CPX-M-AB-4-M12X2-5POL |
| Plug | | | |
|  | Plug, M12, 5 pin | 175487 | SEA-M12-5GS-PG7 |
|  | Plug, Sub-D, 25-pin | 527522 | SD-SUB-D-ST25 |
| Cover | | | |
|  | Cover for CPX-AB-8-KL-4POL (IP65, IP67) – 8 cable through-feeds M9 – 1 cable through-feed for multi-pin plug | 538219 | AK-8KL |
| | Fittings kit | 538220 | VG-K-M9 |
| Screening plate | | | |
|  | Screening plate for M12 connections | 526184 | CPX-AB-S-4-M12 |
| Manual | | | |
|  | Manual | German | 526415 P.BE-CPX-AX-DE |
| | | English | 526416 P.BE-CPX-AX-EN |
| | | Spanish | 526417 P.BE-CPX-AX-ES |
| | | French | 526418 P.BE-CPX-AX-FR |
| | | Italian | 526419 P.BE-CPX-AX-IT |

Terminal CPX

Technical data – Analogue input module with pressure sensors



Function

The pressure input modules enable a maximum of four pressures to be processed. The internal measured value of the sensor (analogue value with 10 bit resolution) is converted into an internal numerical format as appropriate to the parameterisation and made available to the bus node as an image table. It is also possible to combine two channels into one differential pressure channel.

Applications

- Measuring range 0 ... 10 bar or -1 ... +1 bar
- Choice of units of measurement
- Processing of max. four pressures per module
- Pressure indication via LCD display
- Direct connection via QS4 push-in connectors
- Error message via CPX
- Channel-oriented diagnostics



| General technical data | | | |
|---|---|---------------|---------------|
| Type | CPX-4AE-P-B2 | | CPX-4AE-P-D10 |
| No. of analogue inputs | 4 | | |
| Pneumatic connection | QS-4 | | |
| Nominal operating voltage | [V DC] | 24 | |
| Operating voltage range | [V DC] | 18...30 | |
| Intrinsic current consumption | [mA] | Typically 50 | |
| Measured variable | 4x relative or 2x differential pressure measurement | | |
| Displayable units | <ul style="list-style-type: none"> • kPa • mbar • psi | | |
| Pressure measuring range | Starting value | [bar] | -1 |
| | Final value | [bar] | 1 |
| | | | 0 |
| | | | 10 |
| Internal cycle time | [ms] | 5 | |
| Data format | <ul style="list-style-type: none"> • 15 bits + prefix • Binary representation in mbar, kPa, psi | | |
| LED displays | Group diagnostics | | |
| Diagnostics | <ul style="list-style-type: none"> • Limit value violation per channel • Parameterisation error • Sensor limit per channel | | |
| Parameterisation | <ul style="list-style-type: none"> • Diagnostic delay per channel • Hysteresis per module • Unit of measurement • Measured value smoothing per channel • Limit value monitoring per channel • Sensor limit per channel • Measurement of relative/differential pressure | | |
| Protection class to EN 60529 | IP65, IP67 | | |
| Operating medium | Compressed air in accordance with ISO 8573-1:2010 [7:4:4] | | |
| Note on operating/pilot medium | Operation with lubricated medium possible (in which case lubricated operation will always be required) | | |
| Ambient temperature | [°C] | -5 ... 50 | |
| Storage temperature | [°C] | -20 ... 70 | |
| Temperature of medium | [°C] | 0 ... 50 | |
| Note on materials | RoHS-compliant | | |
| Materials | Reinforced PA, PC | | |
| Grid dimension | [mm] | 50 | |
| Dimensions (incl. interlinking block) W x L x H | [mm] | 50 x 107 x 55 | |
| Weight | [g] | 112 | |

- - Note

Extreme pneumatic conditions, for example high cycle frequency with large pressure amplitudes, can damage the sensors.

Terminal CPX

Accessories – Analogue input module with pressure sensors

Connection and display components

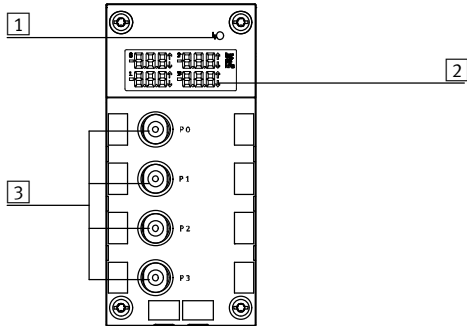

- 1 Error LED (red, module error)
- 2 LCD display with permanent display of the four measured pressures, unit of measurement and if applicable limit value violation
- 3 QS connections

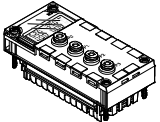
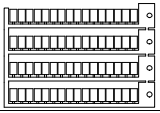
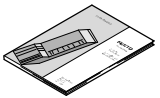
| Ordering data | | Part No. | Type |
|---|--|----------|-----------------------|
| Designation | | | |
| Input module, analogue | | | |
|  | 4 analogue pressure inputs, pressure range -1 ... +1 bar | 560361 | CPX-4AE-P-B2 |
| | 4 analogue pressure inputs, pressure range 0 ... 10 bar | 560362 | CPX-4AE-P-D10 |
| Inscription labels | | | |
|  | Inscription labels 6x10, 64 pieces, in frames | 18576 | IBS-6x10 |
| User manual | | | |
|  | User manual | German | 526415 P.BE-CPX-AX-DE |
| | | English | 526416 P.BE-CPX-AX-EN |
| | | Spanish | 526417 P.BE-CPX-AX-ES |
| | | French | 526418 P.BE-CPX-AX-FR |
| | | Italian | 526419 P.BE-CPX-AX-IT |

Terminal CPX

Technical data – Analogue module for temperature inputs

Function

The CPX-PT100 analogue input module with 4 channels for temperature measurement enables the connection of up to 4 temperature sensors of the type PT100-PT1000, Ni100-Ni1000, etc. The temperature module supports various connection concepts with different numbers of sockets or terminals as appropriate to the connection block selected.

Applications

- Temperature module for temperature sensors PT100, PT200, PT500, PT1000, Ni100, Ni120, Ni500, Ni1000
- Supports connection blocks with M12, Harax and terminal connection
- Temperature module features can be parameterised
- 2-wire, 3-wire and 4-wire connection
- The temperature module is provided with voltage supply for the electronics and the sensors via the interlinking block
- Temperature module protection and diagnostics through integrated electronic fuse protection



| General technical data | | | |
|---|-------------|--|---------------|
| Type | | CPX-4AE-T | |
| | | Temperature input | |
| No. of analogue inputs | | Choice of 2 or 4 | |
| Max. power supply per module | | [A] | 0.7 |
| Fuse protection | | Internal electronic fuse for sensor supply | |
| Current consumption from 24 V sensor supply (quiescent current) | | [mA] | Typically 50 |
| Supply voltage of sensors | | [V DC] | 24 ±25% |
| Sensor type (parameterisable for each channel by means of DIL switch) | | PT100, PT200, PT500, PT1000 Ni100, Ni120, Ni500, Ni1000 | |
| Temperature range | Pt standard | [°C] | -200 ... +850 |
| | Pt climatic | [°C] | -120 ... +130 |
| | Ni | [°C] | -60 ... +180 |
| Sensor connection technology | | 2-wire, 3-wire and 4-wire technology | |
| Resolution | | 15 bit + prefix | |
| Operating error limit relative to input range | | [%] | ±0.06 |
| Basic error limit (25 °C) | Standard | [K] | ±0.6 |
| | Pt climatic | [K] | ±0.2 |
| Temperature errors relative to input range | | [%] | ±0.001 |
| Linearity errors (no software scaling) | | [%] | ±0.02 |
| Repetition accuracy (at 25 °C) | | [%] | ±0.05 |
| Max. line resistance per wire | | [Ω] | 10 |
| Max. permissible input voltage | | [V] | ±30 |
| Cycle time (module) | | [ms] | ≤ 250 |

Terminal CPX

Technical data – Analogue module for temperature inputs

| General technical data | | |
|--|------------------------|---|
| Data format | | 15 bit + prefix, complement of two, binary notation in tenths of a degree |
| Cable length | [m] | Max. 200 (screened) |
| Electrical isolation | Channel – channel | No |
| | Channel – internal bus | Yes |
| LED displays | Group diagnostics | 1 |
| | Channel diagnostics | 4 |
| Diagnostics | | <ul style="list-style-type: none"> • Short circuit/overload, channel • Parameterisation error • Value falling below nominal range/full-scale value • Value exceeding nominal range/full-scale value • Wire break |
| Parameterisation | | <ul style="list-style-type: none"> • Unit of measurement and interference frequency suppression • Diagnostic message in the event of a wire break or short circuit • Limit monitoring per channel • Sensor connection technology • Sensor type/temperature coefficient, temperature range • Limit value per channel • Measured value smoothing |
| Protection class to EN 60529 | | Depending on connection block |
| Temperature range | Operation | [°C] –5 ... +50 |
| | Storage/transport | [°C] –20 ... +70 |
| Materials | | Reinforced PA, PC |
| Grid dimension | [mm] | 50 |
| Dimensions (incl. interlinking block and connection block) W x L x H | [mm] | 50 x 107 x 50 |
| Weight | [g] | 38 |

Connection and display components

CPX-4AE-T

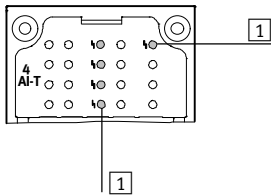

- 1 Error LED (red, module error)
- 2 Channel-specific error LEDs (red)

| Connection block/analogue module combinations | | |
|---|----------|--------------------|
| Connection blocks | Part No. | Temperature module |
| | | CPX-4AE-T |
| CPX-AB-4-M12X2-5POL | 195704 | ■ |
| CPX-AB-4-M12X2-5POL-R | 541254 | ■ |
| CPX-AB-8-KL-4POL | 195708 | ■ |
| CPX-AB-4-HAR-4POL | 525636 | ■ |
| CPX-M-AB-4-M12X2-5POL | 549367 | ■ |

Terminal CPX

Technical data – Analogue module for temperature inputs

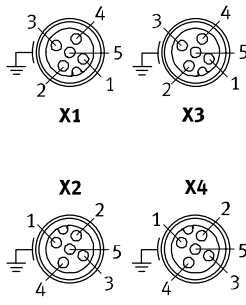
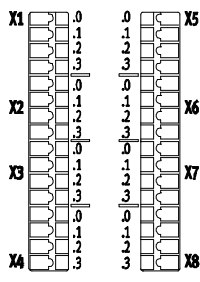
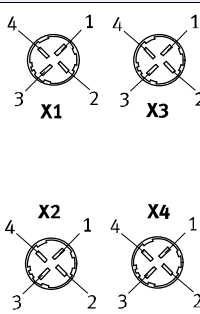

| Pin allocation | | |
|---|---|--|
| Connection block inputs | | CPX-4AE-T |
| CPX-AB-4-M12X2-5POL, CPX-AB-4-M12X2-5POL-R ¹⁾ and CPX-M-AB-4-M12X2-5POL | | |
|  | <p>X1.1: Input I0+ X1.2: Input U0+ X1.3: Input I0- X1.4: Input U0- X1.5: FE²⁾</p> <p>X2.1: Input I1+ X2.2: Input U1+ X2.3: Input I1- X2.4: Input U1- X2.5: FE²⁾</p> | <p>X3.1: Input I2+ X3.2: Input U2+ X3.3: Input I2- X3.4: Input U2- X3.5: FE²⁾</p> <p>X4.1: Input I3+ X4.2: Input U3+ X4.3: Input I3- X4.4: Input U3- X4.5: FE²⁾</p> |
| CPX-AB-8-KL-4POL | | |
|  | <p>X1.0: Input I0+ X1.1: Input I0- X1.2: Input U0- X1.3: FE</p> <p>X2.0: n.c. X2.1: n.c. X2.2: Input U0+ X2.3: FE</p> <p>X3.0: Input I1+ X3.1: Input I1- X3.2: Input U1- X3.3: FE</p> <p>X4.0: n.c. X4.1: n.c. X4.2: Input U1+ X4.3: FE</p> | <p>X5.0: Input I2+ X5.1: Input I2- X5.2: Input U2- X5.3: FE</p> <p>X6.0: n.c. X6.1: n.c. X6.2: Input U12+ X6.3: FE</p> <p>X7.0: Input I3+ X7.1: Input I3- X7.2: Input U3- X7.3: FE</p> <p>X8.0: n.c. X8.1: n.c. X8.2: Input U3+ X8.3: FE</p> |
| CPX-AB-4-HAR-4POL | | |
|  | <p>X1.1: Input I0+ X1.2: Input U0+ X1.3: Input I0- X1.4: Input U0-</p> <p>X2.1: Input I1+ X2.2: Input U1+ X2.3: Input I1- X2.4: Input U1-</p> | <p>X3.1: Input I2+ X3.2: Input U2+ X3.3: Input I2- X3.4: Input U2-</p> <p>X4.1: Input I3+ X4.2: Input U3+ X4.3: Input I3- X4.4: Input U3-</p> |

1) Speedcon quick lock, screening additionally on metal thread

2) FE/screening additionally on metal thread

Terminal CPX

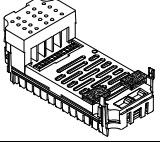
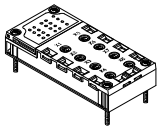
Accessories – Analogue module for temperature inputs

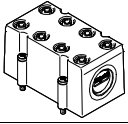
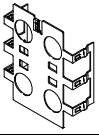
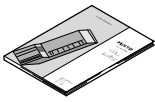
| Ordering data | | | |
|---|--|--|------------------------------|
| Designation | | Part No. | Type |
| Input module, analogue | | | |
|  | 2 or 4 analogue temperature inputs | 541486 | CPX-4AE-T |
| Connection block | | | |
|  | Plastic | 4x socket, M12, 5-pin | 195704 CPX-AB-4-M12X2-5POL |
| | | 4x socket, M12 with quick-lock technology, 5-pin | 541254 CPX-AB-4-M12X2-5POL-R |
| | | Spring clip terminal, 32-pin | 195708 CPX-AB-8-KL-4POL |
| | | 4x socket, quick connection, 4-pin | 525636 CPX-AB-4-HAR-4POL |
| | Metal | 4x socket, M12, 5-pin | 549367 CPX-M-AB-4-M12X2-5POL |
| Plug | | | |
|  | M12 plug, 5-pin | 175487 | SEA-M12-5GS-PG7 |
|  | HARAX plug, 4-pin | 525928 | SEA-GS-HAR-4POL |
| Cover | | | |
|  | Cover for CPX-AB-8-KL-4POL (IP65, IP67) – 8 cable through-feeds M9 – 1 cable through-feed for multi-pin plug | | 538219 AK-8KL |
| | Fittings kit | | 538220 VG-K-M9 |
| Screening plate | | | |
|  | Screening plate for M12 connections | 526184 | CPX-AB-S-4-M12 |
| User manual | | | |
|  | User manual | German | 526415 P.BE-CPX-AX-DE |
| | | English | 526416 P.BE-CPX-AX-EN |
| | | Spanish | 526417 P.BE-CPX-AX-ES |
| | | French | 526418 P.BE-CPX-AX-FR |
| | | Italian | 526419 P.BE-CPX-AX-IT |

Terminal CPX

Technical data – Analogue module for thermocoupler

Function

The CPX-4AE-TC analogue input module with four channels for temperature measurement enables up to four thermocoupler sensors to be connected. The channels feature wire break and short circuit detection. If no cold junction compensation sensor is being used, an internal theoretical value of 25 °C can be used (accuracy is impaired).

Applications

- Supports connection blocks with M12 and terminal connection
- Temperature module features can be parameterised
- 2-wire connection
- 2-wire connection for a PT1000 sensor for cold junction compensation
- The temperature module is provided with voltage supply for the electronics and the sensors via the interlinking block
- Temperature module protection and diagnostics through integrated electronic fuse protection



| General technical data | | |
|---|---|-----------|
| Type | CPX-4AE-TC | |
| | Temperature input | |
| No. of analogue inputs | 4 | |
| Fuse protection (short circuit) | Internal electronic fuse for each channel | |
| Nominal operating voltage | [V DC] | 24 |
| Operating voltage range | [V DC] | 18 ... 30 |
| Sensor type (parameterisable for each channel by means of software) | <ul style="list-style-type: none"> • Type B +400 ... +1,820 °C, 8 µV/°C • Type E -270 ... +900 °C, 60 µV/°C • Type J -200 ... +1,200 °C, 51 µV/°C • Type K -200 ... +1,370 °C, 40 µV/°C • Type N -200 ... +1,300 °C, 38 µV/°C • Type R 0 ... +1,760 °C, 12 µV/°C • Type S 0 ... +1,760 °C, 11 µV/°C • Type T -200 ... +400 °C, 40 µV/°C | |
| Sensor connection technology | 2-wire technology | |
| Operating error limit relative to ambient temperature | [%] | Max. ±0.6 |
| Basic error limit (at 25 °C) | [%] | Max. ±0.4 |
| Repetition accuracy (at 25 °C) | [%] | ±0.05 |
| Max. line resistance per wire | [Ω] | 10 |
| Max. residual current per module | [mA] | 30 |
| Max. permissible input voltage | [V] | ±30 |
| Internal cycle time (module) | [ms] | 250 |

Terminal CPX

Technical data – Analogue module for thermocoupler

| General technical data | | |
|--|------------------------|---|
| Data format | | <ul style="list-style-type: none"> • 15 bit + prefix, complement of two • Binary notation in tenths of a degree |
| Cable length | [m] | Max. 50 (screened) |
| Electrical isolation | Channel – channel | No |
| | Channel – internal bus | Yes |
| LED displays | Group diagnostics | 1 |
| | Channel diagnostics | 4 |
| Diagnostics | | <ul style="list-style-type: none"> • Parameterisation error • Wire break per channel • Limit value violation per channel |
| Parameterisation | | <ul style="list-style-type: none"> • Wire break monitoring per channel • Unit of measurement • Cold junction compensation • Sensor type per channel • Limit value monitoring per channel • Measured value smoothing |
| Protection class to EN 60529 | | Depending on connection block |
| Temperature range | Operation [°C] | -5 ... +50 |
| | Storage/transport [°C] | -20 ... +70 |
| Materials | | Reinforced PA, PC |
| Grid dimension | [mm] | 50 |
| Dimensions (incl. interlinking block and connection block) W x L x H | [mm] | 50 x 107 x 50 |
| Weight | [g] | 38 |

Connection and display components

CPX-4AE-TC

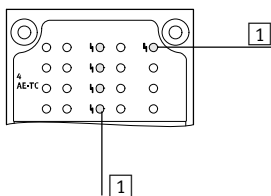

- 1 Error LED (red, module error)
- 2 Channel-specific error LEDs (red)

| Connection block/analogue module combinations | | |
|---|----------|--------------------|
| Connection blocks | Part No. | Temperature module |
| | | CPX-4AE-TC |
| CPX-AB-4-M12X2-5POL | 195704 | ■ |
| CPX-AB-4-M12X2-5POL-R | 541254 | ■ |
| CPX-AB-8-KL-4POL | 195708 | ■ |
| CPX-M-AB-4-M12x2-5POL | 549367 | ■ |

Terminal CPX

Technical data – Analogue module for thermocoupler

| Pin allocation | | |
|--|---|--|
| Connection block inputs | CPX-4AE-TC | |
| CPX-AB-4-M12X2-5POL, CPX-AB-4-M12X2-5POL-R ¹⁾ and CPX-M-AB-4-M12X2-5POL | | |
| | <p>X1.1: Input I0+</p> <p>X1.2: Input U0+</p> <p>X1.3: Input I0-</p> <p>X1.4: Input U0-</p> <p>X1.5: FE²⁾</p> <p>X2.1: Input I1+</p> <p>X2.2: Input U1+</p> <p>X2.3: Input I1-</p> <p>X2.4: Input U1-</p> <p>X2.5: FE²⁾</p> | <p>X3.1: Input I2+</p> <p>X3.2: Input U2+</p> <p>X3.3: Input I2-</p> <p>X3.4: Input U2-</p> <p>X3.5: FE²⁾</p> <p>X4.1: Input I3+</p> <p>X4.2: Input U3+</p> <p>X4.3: Input I3-</p> <p>X4.4: Input U3-</p> <p>X4.5: FE²⁾</p> |
| CPX-AB-8-KL-4POL | | |
| | <p>X1.0: Input I0+</p> <p>X1.1: Input I0-</p> <p>X1.2: Input U0-</p> <p>X1.3: FE</p> <p>X2.0: n.c.</p> <p>X2.1: n.c.</p> <p>X2.2: Input U0+</p> <p>X2.3: FE</p> <p>X3.0: Input I1+</p> <p>X3.1: Input I1-</p> <p>X3.2: Input U1-</p> <p>X3.3: FE</p> <p>X4.0: n.c.</p> <p>X4.1: n.c.</p> <p>X4.2: Input U1+</p> <p>X4.3: FE</p> | <p>X5.0: Input I2+</p> <p>X5.1: Input I2-</p> <p>X5.2: Input U2-</p> <p>X5.3: FE</p> <p>X6.0: n.c.</p> <p>X6.1: n.c.</p> <p>X6.2: Input U12+</p> <p>X6.3: FE</p> <p>X7.0: Input I3+</p> <p>X7.1: Input I3-</p> <p>X7.2: Input U3-</p> <p>X7.3: FE</p> <p>X8.0: n.c.</p> <p>X8.1: n.c.</p> <p>X8.2: Input U3+</p> <p>X8.3: FE</p> |

1) Speedcon quick lock, screening additionally on metal thread
 2) FE/screening additionally on metal thread

Terminal CPX

Accessories – Analogue module for thermocoupler

FESTO

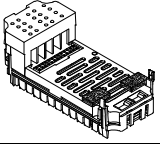
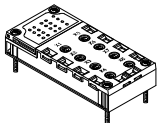
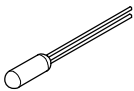
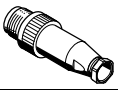
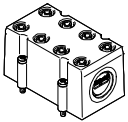
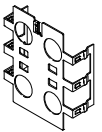
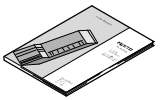
| Ordering data | | | |
|---|--|--|-------------------------------------|
| Designation | | Part No. | Type |
| Input module, analogue | | | |
|  | 4 analogue temperature inputs, with 2-wire connection for a PT1000 sensor for cold junction compensation | | 553594 CPX-4AE-TC |
| Connection block | | | |
|  | Plastic | 4x socket, M12, 5-pin | 195704 CPX-AB-4-M12X2-5POL |
| | | 4x socket, M12 with quick-lock technology, 5-pin | 541254 CPX-AB-4-M12X2-5POL-R |
| | | Spring clip terminal, 32-pin | 195708 CPX-AB-8-KL-4POL |
| | Metal | 4x socket, M12, 5-pin | 549367 CPX-M-AB-4-M12X2-5POL |
| Cold junction compensation | | | |
|  | PT1000 temperature sensor for cold junction compensation | | 553596 CPX-W-PT1000 |
| Plug | | | |
|  | M12 plug, 5-pin | | 175487 SEA-M12-5GS-PG7 |
| Cover | | | |
|  | Cover for CPX-AB-8-KL-4POL (IP65, IP67) – 8 cable through-feeds M9 – 1 cable through-feed for multi-pin plug | | 538219 AK-8KL |
| | Fittings kit | | 538220 VG-K-M9 |
| Screening plate | | | |
|  | Screening plate for M12 connections | | 526184 CPX-AB-S-4-M12 |
| User manual | | | |
|  | User manual | German | 526415 P.BE-CPX-AX-DE |
| | | English | 526416 P.BE-CPX-AX-EN |
| | | Spanish | 526417 P.BE-CPX-AX-ES |
| | | French | 526418 P.BE-CPX-AX-FR |
| | | Italian | 526419 P.BE-CPX-AX-IT |

Terminal CPX

Technical data – Analogue module for outputs

Function

Analogue modules control devices with a standard analogue interface such as proportional valves, etc. The analogue module supports various connection concepts with different numbers of sockets or terminals as appropriate to the connection block selected.

Applications

- Analogue module for 0 ... 10 V, 0 ... 20 mA or 4 ... 20 mA
- Supports connection blocks with M12, Sub-D and terminal connection
- Analogue module features can be parameterised
- Different data formats available
- Operation with and without galvanic isolation possible
- The analogue module receives the voltage supply for the electronics and the actuators from the interlinking block
- Analogue module protection and diagnostics through integrated electronic fuse protection



| General technical data | | | | |
|---|--|--|----------------------------|----------|
| Type | | CPX-2AA-U-I | | |
| | | Voltage output | Current output | |
| No. of analogue outputs | | 2 | | |
| Max. actuator supply per module | [A] | 2.8 | | |
| Fuse protection | | Internal electronic fuse for actuator supply | | |
| Current consumption from 24 V sensor supply (at full load) | [mA] | Max. 150 | | |
| Current consumption from 24 V actuator supply (at full load) | [A] | 4 ... 10 | | |
| Supply voltage of actuators | [V DC] | 24 ±25% | | |
| Signal range (parameterisable for each channel by means of DIL switch or software) | | 0 ... 10 V DC | 0 ... 20 mA 4 ... 20 mA | |
| Resolution | [bit] | 12 | | |
| No. of units | | 4,096 | | |
| Absolute accuracy | [%] | ±0.6 | | |
| Linearity errors (no software scaling) | [%] | ±0.1 | | |
| Repetition accuracy (at 25 °C) | [%] | 0.05 | | |
| Encoder selection | Load resistance for ohmic load | [kΩ] | Min. 1 | Max. 0.5 |
| | Load resistance for capacitive load | [μF] | Max. 1 | – |
| | Load resistance for inductive load | [mH] | – | Max. 1 |
| | Short circuit protection analogue output | | Yes | – |
| | Short circuit current analogue output | [mA] | Approx. 20 | – |
| | Open circuit voltage | [V DC] | – | 18 |
| | Destruction limit against externally applied voltage | [V DC] | 15 | |
| | Actuator connection | | 2 wires | |
| Cycle time (module) | [ms] | ≤ 4 | | |

Terminal CPX

Technical data – Analogue module for outputs

| General technical data | | | | |
|--|--|------|--|----------------|
| Type | | | CPX-2AA-U-I | |
| | | | Voltage output | Current output |
| Response time | For ohmic load | [ms] | 0.1 | 0.1 |
| | For capacitive load | [ms] | 0.7 | – |
| | For inductive load | [ms] | – | 0.5 |
| Data format | 15 bit + prefix, linear scaling 12 bit right-justified 12 bit left-justified, S7 compatible 12 bit left-justified, S5 compatible | | | |
| Cable length | | [m] | Max. 30 (screened) | |
| LED displays | Group diagnostics | | 1 | |
| | Channel diagnostics | | Yes, by means of flashing frequency of group diagnostics | |
| Diagnostics | <ul style="list-style-type: none"> • Short circuit/overload, actuator supply • Parameterisation error • Value falling below nominal range/full-scale value • Value exceeding nominal range/full-scale value • Wire break | | | |
| Parameterisation | <ul style="list-style-type: none"> • Short circuit monitoring, actuator supply • Short circuit monitoring, analogue output • Behaviour after short circuit, actuator supply • Data format • Lower limit value/full-scale value • Upper limit value/full-scale value • Monitoring of value falling below nominal range/full-scale value • Monitoring of value exceeding nominal range/full-scale value • Wire break monitoring • Signal range | | | |
| Protection class to EN 60529 | Depending on connection block | | | |
| Temperature range | Operation | [°C] | –5 ... +50 | |
| | Storage/transport | [°C] | –20 ... +70 | |
| Materials | Reinforced PA, PC | | | |
| Grid dimension | | [mm] | 50 | |
| Dimensions (incl. interlinking block and connection block) W x L x H | | [mm] | 50 x 107 x 50 | |
| Weight | | [g] | 38 | |

Connection and display components

CPX-2AA-U-I

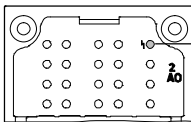

1 Error LED (red, module error)

| Connection block/analogue module combinations | | | |
|---|----------|-----------------|---|
| Connection blocks | Part No. | Analogue module | |
| | | CPX-2AA-U-I | |
| CPX-AB-4-M12X2-5POL | 195704 | | ■ |
| CPX-AB-4-M12X2-5POL-R | 541254 | | ■ |
| CPX-AB-8-KL-4POL | 195708 | | ■ |
| CPX-AB-1-SUB-BU-25POL | 525676 | | ■ |
| CPX-M-AB-4-M12X2-5POL | 549367 | | ■ |

Terminal CPX

Technical data – Analogue module for outputs



| Pin allocation | | |
|--|---|---|
| Connection block outputs | CPX-2AA-U-I | |
| CPX-AB-4-M12X2-5POL, CPX-AB-4-M12X2-5POL-R ¹⁾ and CPX-M-AB-4-M12X2-5POL | | |
| | <p>X1.1: 24 V_{OUT} X1.2: Output U₀₊ X1.3: 0 V_{OUT} X1.4: Output GND X1.5: FE²⁾</p> <p>X2.1: 24 V_{OUT} X2.2: Output I₀₊ X2.3: 0 V_{OUT} X2.4: Output GND X2.5: FE²⁾</p> | <p>X3.1: 24 V_{OUT} X3.2: Output U₁₊ X3.3: 0 V_{OUT} X3.4: Output GND X3.5: FE²⁾</p> <p>X4.1: 24 V_{OUT} X4.2: Output I₁₊ X4.3: 0 V_{OUT} X4.4: Output GND X4.5: FE²⁾</p> |
| CPX-AB-8-KL-4POL | | |
| | <p>X1.0: 24 V_{OUT} X1.1: 0 V_{OUT} X1.2: Output GND X1.3: FE</p> <p>X2.0: n.c. X2.1: n.c. X2.2: Output U₀₊ X2.3: FE</p> <p>X3.0: 24 V_{OUT} X3.1: 0 V_{OUT} X3.2: Output GND X3.3: FE</p> <p>X4.0: n.c. X4.1: n.c. X4.2: Output I₀₊ X4.3: FE</p> | <p>X5.0: 24 V_{OUT} X5.1: 0 V_{OUT} X5.2: Output GND X5.3: FE</p> <p>X6.0: n.c. X6.1: n.c. X6.2: Output U₁₊ X6.3: FE</p> <p>X7.0: 24 V_{OUT} X7.1: 0 V_{OUT} X7.2: Output GND X7.3: FE</p> <p>X8.0: n.c. X8.1: n.c. X8.2: Output I₁₊ X8.3: FE</p> |
| CPX-AB-1-SUB-BU-25POL | | |
| | <p>1: Output GND 2: Output U₀₊ 3: Output GND 4: Output I₀₊ 5: n.c. 6: n.c. 7: n.c. 8: n.c. 9: 24 V_{OUT} 10: 24 V_{OUT} 11: 0 V_{OUT} 12: 0 V_{OUT} 13: Screening³⁾</p> | <p>14: Output GND 15: Output U₁₊ 16: Output GND 17: Output I₁₊ 18: 24 V_{OUT} 19: n.c. 20: 24 V_{OUT} 21: n.c. 22: 0 V_{OUT} 23: 0 V_{OUT} 24: 0 V_{OUT} 25: FE Housing: FE</p> |

1) Speedcon quick lock, screening additionally on metal thread
 2) FE/screening additionally on metal thread
 3) Connect screening to functional earth FE

Terminal CPX

Accessories – Analogue module for outputs

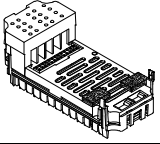
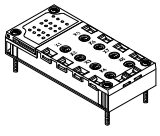
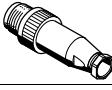
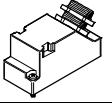
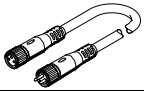
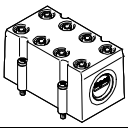
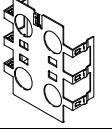
FESTO

| Ordering data | | | |
|---|--|--|------------------------------|
| Designation | | Part No. | Type |
| Output module, analogue | | | |
|  | 2 analogue current or voltage outputs | 526170 | CPX-2AA-U-I |
| Connection block | | | |
|  | Plastic | 4x socket, M12, 5-pin | 195704 CPX-AB-4-M12X2-5POL |
| | | 4x socket, M12 with quick-lock technology, 5-pin | 541254 CPX-AB-4-M12X2-5POL-R |
| | | Spring clip terminal, 32-pin | 195708 CPX-AB-8-KL-4POL |
| | | 1x Sub-D socket, 25-pin | 525676 CPX-AB-1-SUB-BU-25POL |
| | Metal | 4x socket, M12, 5-pin | 549367 CPX-M-AB-4-M12X2-5POL |
| Plug | | | |
|  | M12 plug, 5-pin | 175487 | SEA-M12-5GS-PG7 |
|  | Sub-D plug, 25-pin | 527522 | SD-SUB-D-ST25 |
| Connecting cable | | | |
|  | Modular system for connecting cables | – | NEBU-... → Internet: nebu |
| Cover | | | |
|  | Cover for CPX-AB-8-KL-4POL (IP65, IP67) – 8 cable through-feeds M9 – 1 cable through-feed for multi-pin plug | 538219 | AK-8KL |
| | Fittings kit | 538220 | VG-K-M9 |
| Screening plate | | | |
|  | Screening plate for M12 connections | 526184 | CPX-AB-S-4-M12 |
| User manual | | | |
|  | User manual | German | 526415 P.BE-CPX-AX-DE |
| | | English | 526416 P.BE-CPX-AX-EN |
| | | Spanish | 526417 P.BE-CPX-AX-ES |
| | | French | 526418 P.BE-CPX-AX-FR |
| | | Italian | 526419 P.BE-CPX-AX-IT |

Terminal CPX

Technical data – PROFIsafe shut-off module

Function

The PROFIsafe shut-off module interrupts the contact rails of the interlinking block for valves and outputs. The supply voltage for valves can be switched by the module within the CPX terminal and via a connection block to two consuming devices. Actuation takes place via the fieldbus node (PROFINET) of the CPX terminal.

Scope of application

- Output module for 24 V DC supply voltage
- Shut-off module for supply voltage for valves
- Can only be used with PROFINET or PROFIBUS bus node
- The shut-off module is supplied with voltage for the electronics and the outputs by the interlinking block
- The outputs are supplied from the power supply for valves (V_{Valves})

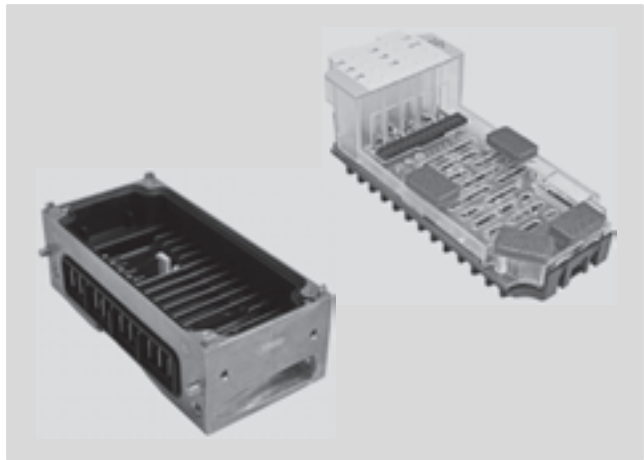

| General technical data | | | |
|--|--------------------------|---|---|
| Type | | CPX-FVDA-P2 | |
| Number of outputs | | 2 | |
| Note on outputs | | 1 internal channel for shutting off the supply voltage for valves 2 external outputs | |
| Max. power supply | Per module | [A] | 5 |
| | Per channel | [A] | 1.5 |
| Fuse protection (short circuit) | | Internal electronic fuse for each channel | |
| Current consumption of module | | [mA] | Typ. 65 (power supply for valves) Typ. 25 (power supply for electronics) |
| Operating voltage | Nominal value | [V DC] | 24 |
| | Permissible range | [V DC] | 20.4 ... 28.8 |
| Voltage drop per channel | | [V] | 0.6 |
| Residual ripple | | [Vss] | 2 within voltage range |
| Load capacity to FE | | [nF] | 400 |
| Max. response time to shut-off command | | [ms] | 23 |
| Electrical isolation | Channel – channel | No | |
| | Channel – internal bus | Yes, using an intermediate supply | |
| Switching logic | Outputs | P-M switching | |
| Safety integrity level | | Safe shut off, SIL 3 | |
| Performance level | | Safe shut off/category 3, performance level e | |
| Failure rate per hour (PFH) | | 1.0x10 ⁻⁹ | |
| Certificate issuing authority | | 01/205/50294/13 | |
| LED displays | Group diagnostics | 1 | |
| | Channel diagnostics | 3 | |
| | Channel status | 3 | |
| | Failsafe protocol active | 1 | |
| Diagnostics | | <ul style="list-style-type: none"> • Short circuit/overload per channel • Undervoltage of valves • Cross circuit • Wire break per channel | |
| Parameterisation | | <ul style="list-style-type: none"> • Wire break monitoring per channel • Diagnostic behaviour | |
| Protection class to EN 60529 | | Depending on connection block | |
| Materials | | PA reinforced, PC | |
| Note on materials | | RoHS-compliant | |
| Grid dimension | | [mm] | 50 |
| Dimensions (incl. interlinking block and connection block) W x L x H | | [mm] | 50 x 107 x 55 |

Terminal CPX

Technical data – PROFIsafe shut-off module

| Operating and environmental conditions | | |
|---|------|---------------------------|
| Ambient temperature | [°C] | -5 ... +50 |
| Storage temperature | [°C] | -20 ... +70 |
| CE mark (see declaration of conformity) | | To EU Machinery Directive |
| Certification | | c UL us - Recognized (OL) |

Connection and display components

CPX-FVDA-P2

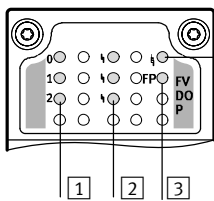

- 1 Status LEDs (yellow):
0: Supply voltage for valves
1: X1
2: X2
- 2 Channel-specific error LEDs (red)
- 3 Failsafe protocol active (green)
- 4 Error LED (red, module error)

| Combinations of bus nodes/control blocks and PROFIsafe shut-off module | | |
|--|----------|---------------------------|
| Bus node/control block | Part No. | PROFIsafe shut-off module |
| | | CPX-FVDA-P2 |
| CPX-FB13 | 195740 | ■ |
| CPX-FB33 | 548755 | ■ |
| CPX-M-FB34 | 548751 | ■ |
| CPX-M-FB35 | 548749 | ■ |

 Note
The PROFIsafe shut-off module CPX-FVDA-P2 can only be interfaced as of software release 21 or release 30 (CPX-FB13).

Terminal CPX

Technical data – PROFIsafe shut-off module

FESTO

| Combinations of connection blocks and PROFIsafe shut-off module | | |
|---|----------|---------------------------|
| Connection blocks | Part No. | PROFIsafe shut-off module |
| | | CPX-FVDA-P2 |
| CPX-M-AB-4-M12X2-5POL | 549367 | ■ |
| CPX-AB-8-KL-4POL | 195708 | ■ |

| Pin allocation | | |
|--------------------------|---|---|
| Connection block outputs | CPX-FVDA-P2 | |
| CPX-M-AB-4-M12X2-5POL | | |
| | <p>X1.1: 0 V_{OUT} 1 (cannot be shut off)</p> <p>X1.2: 24 V_{OUT} 1 (cannot be shut off)</p> <p>X1.3: 0 V_{OUT} 1 (can be shut off via fieldbus)</p> <p>X1.4: 24 V_{OUT} 1 (can be shut off via fieldbus)</p> <p>X1.5: FE (earth)</p> <p>X2.1: 0 V_{OUT} 2 (cannot be shut off)</p> <p>X2.2: 24 V_{OUT} 2 (cannot be shut off)</p> <p>X2.3: 0 V_{OUT} 2 (can be shut off via fieldbus)</p> <p>X2.4: 24 V_{OUT} 2 (can be shut off via fieldbus)</p> <p>X2.5: FE (earth)</p> | <p>X3.1: n.c.</p> <p>X3.2: n.c.</p> <p>X3.3: n.c.</p> <p>X3.4: n.c.</p> <p>X3.5: FE (earth)</p> <p>X4.1: n.c.</p> <p>X4.2: n.c.</p> <p>X4.3: n.c.</p> <p>X4.4: n.c.</p> <p>X4.5: FE (earth)</p> |
| CPX-AB-8-KL-4POL | | |
| | <p>X1.0: 0 V_{OUT} 1 (cannot be shut off)</p> <p>X1.1: 0 V_{OUT} 1 (can be shut off via fieldbus)</p> <p>X1.2: 24 V_{OUT} 1 (can be shut off via fieldbus)</p> <p>X1.3: FE (earth)</p> <p>X2.0: n.c.</p> <p>X2.1: n.c.</p> <p>X2.2: 24 V_{OUT} 1 (cannot be shut off)</p> <p>X2.3: FE (earth)</p> <p>X3.0: 0 V_{OUT} 2 (cannot be shut off)</p> <p>X3.1: 0 V_{OUT} 2 (can be shut off via fieldbus)</p> <p>X3.2: 24 V_{OUT} 2 (can be shut off via fieldbus)</p> <p>X3.3: FE (earth)</p> <p>X4.0: n.c.</p> <p>X4.1: n.c.</p> <p>X4.2: 24 V_{OUT} 2 (cannot be shut off)</p> <p>X4.3: FE (earth)</p> | <p>X5.0: n.c.</p> <p>X5.1: n.c.</p> <p>X5.2: n.c.</p> <p>X5.3: n.c.</p> <p>X6.0: n.c.</p> <p>X6.1: n.c.</p> <p>X6.2: n.c.</p> <p>X6.3: n.c.</p> <p>X7.0: n.c.</p> <p>X7.1: n.c.</p> <p>X7.2: n.c.</p> <p>X7.3: n.c.</p> <p>X8.0: n.c.</p> <p>X8.1: n.c.</p> <p>X8.2: n.c.</p> <p>X8.3: n.c.</p> |

Terminal CPX

Technical data – PROFIsafe shut-off module

| Combinations of interlinking blocks and PROFIsafe shut-off module | | |
|---|----------|---------------------------|
| Interlinking blocks | Part No. | PROFIsafe shut-off module |
| | | CPX-FVDA-P2 |
| CPX-GE-EV-S | 195746 | - |
| CPX-GE-EV-S-7/8-4POL | 541248 | - |
| CPX-GE-EV-S-7/8-5POL | 541244 | - |
| CPX-M-GE-EV-S-7/8-CIP-4P | 568956 | - |
| CPX-M-GE-EV-S-7/8-5POL | 550208 | - |
| CPX-M-GE-EV-S-PP-5POL | 563057 | - |
| CPX-GE-EV | 195742 | - |
| CPX-M-GE-EV | 550206 | - |
| CPX-M-GE-EV-FVO | 567806 | ■ |
| CPX-GE-EV-Z | 195744 | - |
| CPX-GE-EV-Z-7/8-4POL | 541250 | - |
| CPX-GE-EV-Z-7/8-5POL | 541246 | - |
| CPX-M-GE-EV-Z-7/8-5POL | 550210 | - |
| CPX-M-GE-EV-Z-PP-5POL | 563058 | - |
| CPX-GE-EV-V | 533577 | - |
| CPX-GE-EV-V-7/8-4POL | 541252 | - |



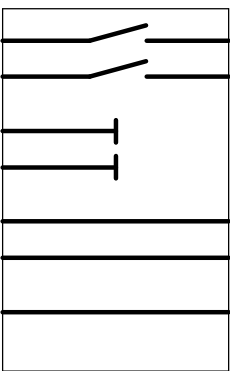

| General technical data | | |
|--|--------|-------------------------------|
| Type | | CPX-M-GE-EV-FVO |
| Nominal operating voltage | [V DC] | 24 |
| Acceptable current load (per contact/contact rail) | [A] | 16 |
| Protection class to EN 60529 | | Depending on connection block |
| Ambient temperature | [°C] | -5 ... +50 |
| Material declaration | | RoHS-compliant |
| Note on materials | | Die-cast aluminium |
| Type of mounting | | Angled fitting |
| Grid dimension | [mm] | 50 |
| Dimensions W x L x H | [mm] | 50 x 107 x 35 |
| Product weight | [g] | 170 |

| Pin allocation | | | |
|--|--|-----|------------|
| Circuitry | | Pin | Allocation |
|  <p>0V Valves 24V Valves 0V Output 24V Output 0V El./Sen. 24V El./Sen. FE</p> | | - | - |
| | | - | - |
| | | - | - |
| | | - | - |
| | | | |
| | | | |
| | | | |
| | | | |
| | | | |
| | | | |

Terminal CPX

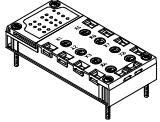
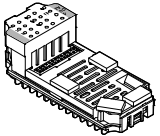
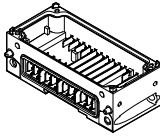
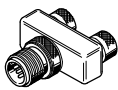
Accessories – PROFIsafe shut-off module

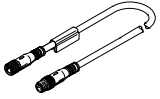
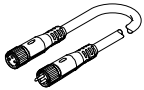
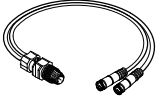
FESTO

| Ordering data | | Description | Part No. | Type | |
|---|---|--|----------------|-------------------------------------|--------------------------|
| PROFIsafe shut-off module | | | | | |
|  | Metal connection block | 4x socket, M12, 5-pin | 549367 | CPX-M-AB-4-M12X2-5POL | |
| | Plastic connection block | Spring-loaded terminal, 32-pin | 195708 | CPX-AB-8-KL-4POL | |
|  | Electronics module (can only be used with CPX-M-GE-EV-FVO) | PROFINET, PROFIBUS | 1971599 | CPX-FVDA-P2 | |
|  | Metal interlinking block (only for CPX-FVDA-P2) | | 567806 | CPX-M-GE-EV-FVO | |
| Plug | | | | | |
|  | Push-in T-connector | 2x socket M12, 5-pin 1x plug M12, 4-pin | 541596 | NEDU-M12D5-M12T4 | |
| |  | Plug | M12, PG7 | 18666 | SEA-GS-7 |
| M12, PG7, 4-pin for cable Ø 2.5 mm | | | 192008 | SEA-4GS-7-2,5 | |
| M12, PG9 | | | 18778 | SEA-GS-9 | |
| M12 for 2 cables | | | 18779 | SEA-GS-11-DUO | |
| M12 for 2 cables, 5-pin | | | 192010 | SEA-5GS-11-DUO | |
| | | M12, 5-pin | 175487 | SEA-M12-5GS-PG7 | |
| Connecting cable | | | | | |
|  | Connecting cable M12-M12 | Straight plug – straight socket | 2.5 m | 18684 | KM12-M12-GSGD-2,5 |
| | | | 5.0 m | 18686 | KM12-M12-GSGD-5 |
| | | Straight plug – angled socket | 1.0 m | 185499 | KM12-M12-GSWD-1-4 |
|  | Modular system for connecting cables | | – | NEBU-... → Internet: nebu | |
|  | DUO cable M12 | 2x straight socket | 18685 | KM12-DUO-M8-GDGD | |
| | | 2x straight/angled socket | 18688 | KM12-DUO-M8-GDWD | |
| | | 2x angled socket | 18687 | KM12-DUO-M8-WDWD | |
| Manual | | | | | |
|  | Manual for PROFIsafe shut-off module | German | 8022606 | P.BE-CPX-FVDA-P2-DE | |
| | | English | 8022607 | P.BE-CPX-FVDA-P2-EN | |
| | | Spanish | 8022608 | P.BE-CPX-FVDA-P2-ES | |
| | | French | 8022609 | P.BE-CPX-FVDA-P2-FR | |
| | | Italian | 8022610 | P.BE-CPX-FVDA-P2-IT | |
| | | Chinese | 8022611 | P.BE-CPX-FVDA-P2-ZH | |

Terminal CPX

Technical data – End plate with system power supply

Function

End plates form the outer edge of the CPX terminal.

The earth connection and mounting holes for wall or H-rail mounting are located on the left end plate.

The end plate with system power supply has contact rails from which the other CPX components on the interlinking modules are supplied with power.

Application

- 24 V DC supply voltage for the electronics of the CPX terminal
- 24 V DC supply voltage for inputs
- 24 V DC supply voltage for valves
- 24 V DC supply voltage for outputs

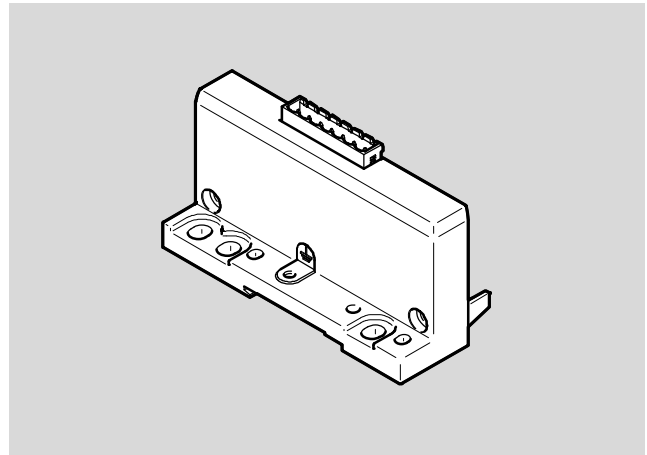

| General technical data | | |
|------------------------|-----|---------------------|
| Electrical connection | | Plug, 7-pin |
| Type of mounting | | Tie rod |
| Power supply | | System power supply |
| Maximum power supply | [A] | 12 |
| Product weight | [g] | 145 |



| Materials | |
|-------------------|-----------------------------|
| Housing | Die-cast aluminium, painted |
| Note on materials | RoHS-compliant |

| Operating and environmental conditions | |
|--|-----------------------|
| Approval certificate | cULus Recognized (OL) |

| Pin allocation | | | | | | | | | | | | | | | | | |
|---|-----|-----|--|---|----|---|-----|---|----|---|-----|---|----|---|--|---|-----------------------------|
| Circuitry | | Pin | Allocation | | | | | | | | | | | | | | |
| Plug, 7-pin | | | | | | | | | | | | | | | | | |
| <table border="1"> <tr><td>0V</td><td>1</td></tr> <tr><td>24V</td><td>2</td></tr> <tr><td>0V</td><td>3</td></tr> <tr><td>24V</td><td>4</td></tr> <tr><td>0V</td><td>5</td></tr> <tr><td>24V</td><td>6</td></tr> <tr><td>FE</td><td>7</td></tr> </table> | 0V | 1 | 24V | 2 | 0V | 3 | 24V | 4 | 0V | 5 | 24V | 6 | FE | 7 | | 1 | 0 V power supply for valves |
| | 0V | 1 | | | | | | | | | | | | | | | |
| | 24V | 2 | | | | | | | | | | | | | | | |
| | 0V | 3 | | | | | | | | | | | | | | | |
| | 24V | 4 | | | | | | | | | | | | | | | |
| | 0V | 5 | | | | | | | | | | | | | | | |
| | 24V | 6 | | | | | | | | | | | | | | | |
| FE | 7 | | | | | | | | | | | | | | | | |
| | | 2 | 24 V DC load voltage supply for valves | | | | | | | | | | | | | | |
| | | 3 | 0 V power supply for outputs | | | | | | | | | | | | | | |
| | | 4 | 24 V DC load voltage supply for outputs | | | | | | | | | | | | | | |
| | | 5 | 0 V power supply for electronics and sensors | | | | | | | | | | | | | | |
| | | 6 | 24 V DC power supply for electronics and sensors | | | | | | | | | | | | | | |
| | | 7 | FE | | | | | | | | | | | | | | |

Terminal CPX

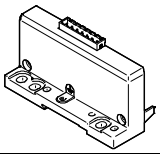
Accessories – End plate with system power supply

| Ordering data | | Part No. | Type |
|---|--|------------------------|-----------------------------------|
| End plate with system power supply | | | |
|  | End plate for CPX terminal in plastic design | 576315 | CPX-EPL-EV-S |
| Terminal strip | | | |
|  | Plug, 7-pin, straight | Spring-loaded terminal | 576319 NECU-L3G7-C1 |

Terminal CPX

Technical data – End plate with extension

Function

End plates form the outer edge of the CPX terminal.

The earth connection and mounting holes for wall or H-rail mounting are located on the left end plates.

The end plates with extension enable the CPX terminal to be separated into two interconnected terminals. Control is provided via a common bus node or control block.

Application

- Separation of long CPX terminals into two shorter units
- Adaptation for installation in a control cabinet

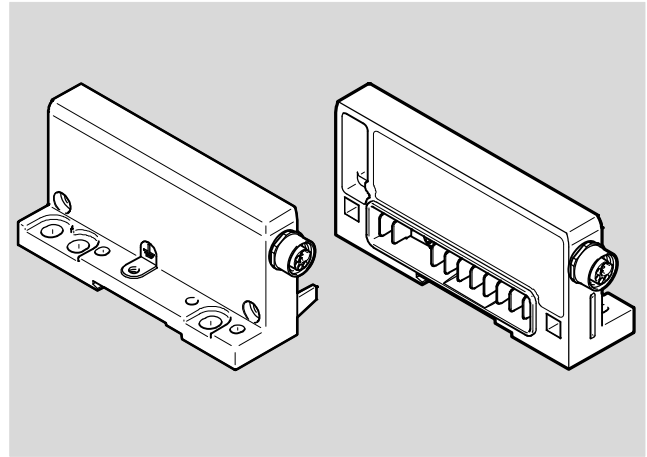

| General technical data | | |
|--------------------------|-----------|----------------|
| Type | CPX-EP... | CPX-M-EP... |
| Type of mounting | Tie rod | Angled fitting |
| Maximum power supply [A] | 6 | 6 |

| Materials | | |
|-------------------|-----------------------------|--------------------|
| Type | CPX-EP... | CPX-M-EP... |
| Housing | Die-cast aluminium, painted | Die-cast aluminium |
| Note on materials | RoHS-compliant | RoHS-compliant |

| Operating and environmental conditions | |
|--|-----------------------|
| Approval certificate | cULus Recognized (OL) |

Terminal CPX

Technical data – End plate with extension

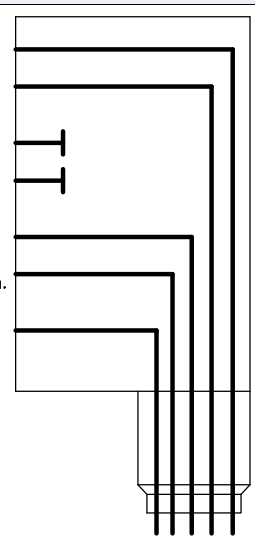
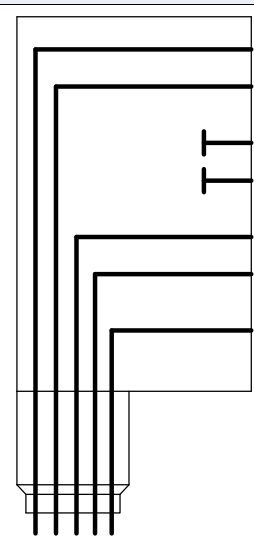
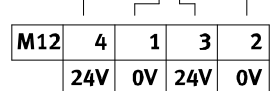
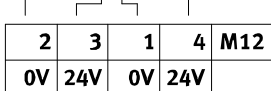
| Pin allocation – End plate with extension | | | | |
|--|--------------------------|--|---------|--|
| Circuitry | Pin | Allocation | Pin | Circuitry |
| Right-hand end plate | Round plug, 8-pin M12 | | | Left-hand end plate |
|  | 1 | 0 V DC supply voltage for electronics and sensors | 1 |  |
| | 2 | 0 V DC load voltage supply for valves | 2 | |
| | 3 | 24 V DC load voltage supply for valves | 3 | |
| | 4 | 24 V DC supply voltage for electronics and sensors | 4 | |
| | 5 | Bus signal | 5 | |
| | 6 | Bus signal | 6 | |
| | 7 | Bus signal | 7 | |
| | 8 | Bus signal | 8 | |
| | Housing | FE | Housing | |
|  | | | |  |

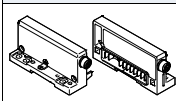
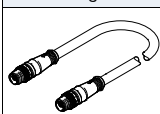
| Ordering data | | | | Weight [g] | Part No. | Type |
|---|------------------------------------|------------|-----|------------|---------------------------|------|
| End plate with extension | | | | | | |
|  | For CPX terminal in plastic design | Left-hand | 190 | 576313 | CPX-EPR-EV-X | |
| | | Right-hand | 175 | 576314 | CPX-EPL-EV-X | |
| | For CPX terminal in metal design | Left-hand | 190 | 576316 | CPX-M-EPR-EV-X | |
| | | Right-hand | 175 | 576317 | CPX-M-EPL-EV-X | |
| Connecting cable | | | | | | |
|  | 8-pin | 2 m | – | 576015 | NEBC-F12G8-KH-2-N-S-F12G8 | |
| | | 3 m | – | 576636 | NEBC-F12G8-KH-3-N-S-F12G8 | |

Terminal CPX

Technical data – Interlinking block with system supply

Function

Interlinking blocks ensure the electrical supply of all other CPX modules. They have contact rails, from which the other CPX components on the interlinking modules are supplied with current.

Internal division of the power supply makes it possible to switch off specific areas of the sensors and actuators individually.

Applications

- 24 V DC supply voltage for electronics of the CPX terminal
- 24 V DC supply voltage for inputs
- 24 V DC supply voltage for valves
- 24 V DC supply voltage for outputs



| General technical data | | |
|------------------------------|--------|-------------------------------|
| Nominal operating voltage | [V DC] | 24 |
| Protection class to EN 60529 | | Depending on connection block |
| Ambient temperature | [°C] | -5 ... +50 |
| Note on materials | | RoHS-compliant |
| Grid dimension | [mm] | 50 |
| Dimensions W x L x H | [mm] | 50 x 107 x 35 |

| Technical data – Plastic interlinking blocks | | | | | | | |
|--|-------------------------|-----|----------------|--------|-------------|-------------|--------------|
| Type | | | CPX-GE-EV-S | | | | |
| | | | | -VL | -7/8-4POL | -7/8-5POL | -7/8-5POL-VL |
| Electrical connection | | | M18 | M18 | 7/8", 4-pin | 7/8", 5-pin | 7/8", 5-pin |
| Current supply | Sensors and electronics | [A] | Max. 16 | Max. 8 | Max. 10 | Max. 8 | Max. 8 |
| | Valves and outputs | [A] | Max. 16 | Max. 8 | Max. 10 | Max. 8 | Max. 8 |
| Materials | | | PA, reinforced | | | | |
| Product weight | | | [g] 125 | | | | |

| Technical data – Metal interlinking blocks | | | | | | | |
|--|-------------------------|-----|--------------------|-------------|--------------|-----------------------|--|
| Type | | | CPX-M-GE-EV-S | | | | |
| | | | -7/8-CIP-4P | -7/8-5POL | -7/8-5POL-VL | -PP-5POL | |
| Electrical connection | | | 7/8", 4-pin | 7/8", 5-pin | 7/8", 5-pin | AIDA push-pull, 5-pin | |
| Current supply | Sensors and electronics | [A] | Max. 10 | Max. 8 | Max. 8 | Max. 16 | |
| | Valves and outputs | [A] | Max. 10 | Max. 8 | Max. 8 | Max. 16 | |
| Materials | | | Die-cast aluminium | | | | |
| Product weight | | | [g] 187 | 187 | 187 | 245 | |

-  - Note

Note the following points about the interlinking block

CPX-M-GE-EV-S-7/8-CIP-4P:

- Must be mounted as the first module to the right of the left-hand end plate
- Only permitted as an interlinking block to a bus node
- The functional earth (FE) must be connected via the left-hand plate



Terminal CPX

Technical data – Interlinking block with system supply

| Pin allocation – Plastic interlinking blocks | | Pin | Allocation | | | | | | | | | | | | | | | |
|---|--|------|--|--|-----|------|---|----|----|----|-----|-----|-----|----|----|--|--|--|
| Circuitry | | | | | | | | | | | | | | | | | | |
| Round connector, 4-pin | | | | | | | | | | | | | | | | | | |
| | <p>0V Valves</p> <p>24V Valves</p> <p>0V Output</p> <p>24V Output</p> <p>0V El./Sen.</p> <p>24V El./Sen.</p> <p>FE</p> | M18 | | | | | | | | | | | | | | | | |
| | | | 1 | 24 V DC supply voltage for electronics and sensors | | | | | | | | | | | | | | |
| | | 2 | 24 V DC load voltage supply for valves and outputs | | | | | | | | | | | | | | | |
| | | 3 | 0 V | | | | | | | | | | | | | | | |
| | | 4 | FE | | | | | | | | | | | | | | | |
| 7/8" | | | | | | | | | | | | | | | | | | |
| | | | A | 24 V DC supply voltage for electronics and sensors | | | | | | | | | | | | | | |
| | | | B | 24 V DC load voltage supply for valves and outputs | | | | | | | | | | | | | | |
| | | | C | FE | | | | | | | | | | | | | | |
| | | | D | 0V | | | | | | | | | | | | | | |
| <table border="1"> <tr> <td>M18</td> <td>1</td> <td>2</td> <td>3</td> <td>4</td> </tr> <tr> <td>7/8"</td> <td>A</td> <td>B</td> <td>D</td> <td>C</td> </tr> <tr> <td></td> <td>24V</td> <td>24V</td> <td>0V</td> <td>FE</td> </tr> </table> | M18 | 1 | 2 | 3 | 4 | 7/8" | A | B | D | C | | 24V | 24V | 0V | FE | | | |
| M18 | 1 | 2 | 3 | 4 | | | | | | | | | | | | | | |
| 7/8" | A | B | D | C | | | | | | | | | | | | | | |
| | 24V | 24V | 0V | FE | | | | | | | | | | | | | | |
| Round connector, 5-pin | | | | | | | | | | | | | | | | | | |
| | <p>0V Valves</p> <p>24V Valves</p> <p>0V Output</p> <p>24V Output</p> <p>0V El./Sen.</p> <p>24V El./Sen.</p> <p>FE</p> | 7/8" | | | | | | | | | | | | | | | | |
| | | | 1 | 0 V valves and outputs | | | | | | | | | | | | | | |
| | | 2 | 0 V electronics and sensors | | | | | | | | | | | | | | | |
| | | 3 | FE | | | | | | | | | | | | | | | |
| | | 4 | 24 V DC supply voltage for electronics and sensors | | | | | | | | | | | | | | | |
| | | 5 | 24 V DC load voltage supply for valves and outputs | | | | | | | | | | | | | | | |
| <table border="1"> <tr> <td>7/8"</td> <td>1</td> <td>2</td> <td>3</td> <td>4</td> <td>5</td> </tr> <tr> <td></td> <td>0V</td> <td>0V</td> <td>FE</td> <td>24V</td> <td>24V</td> </tr> </table> | 7/8" | 1 | 2 | 3 | 4 | 5 | | 0V | 0V | FE | 24V | 24V | | | | | | |
| 7/8" | 1 | 2 | 3 | 4 | 5 | | | | | | | | | | | | | |
| | 0V | 0V | FE | 24V | 24V | | | | | | | | | | | | | |

Terminal CPX

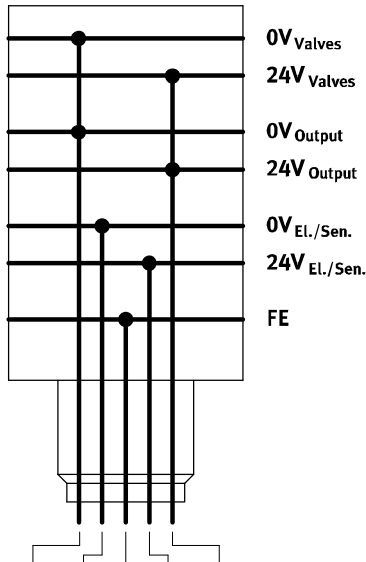
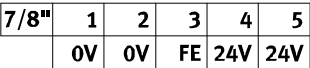
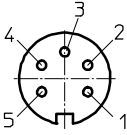
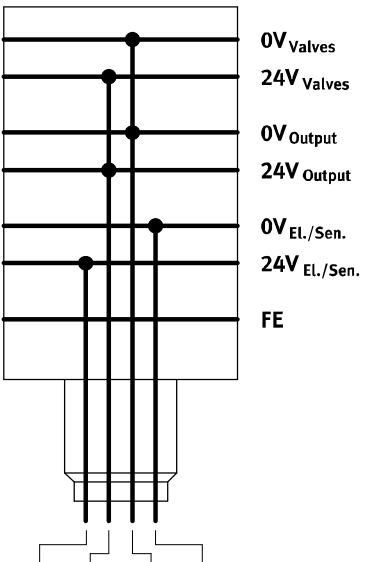
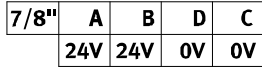
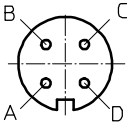
Technical data – Interlinking block with system supply

| Pin allocation – Metal interlinking blocks | | Pin | Allocation |
|---|---|---|--|
| Circuitry | | | |
| Round connector, 5-pin | | | |
|  | 7/8□ | | |
| |  |  | 1 |
| | | 2 | 0 V electronics and sensors |
| | | 3 | FE |
| | | 4 | 24 V DC supply voltage for electronics and sensors |
| | | 5 | 24 V DC load voltage supply for valves and outputs |
| Round connector, 4-pin | | | |
|  | 7/8□ | | |
| |  |  | A |
| | | B | 24 V DC load voltage supply for valves and outputs |
| | | C | 0 V DC supply voltage for electronics and sensors |
| | | D | 0 V DC load voltage supply for valves and outputs |
| | | -  - Note The functional earth (FE) must be connected via the left-hand end plate | |

Terminal CPX

Technical data – Interlinking block with system supply

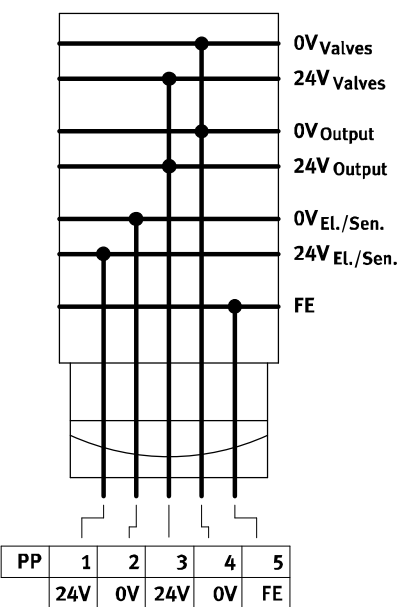
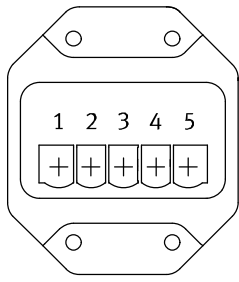
| Pin allocation – Metal interlinking blocks | | Pin | Allocation | | | | | | | | | | | | |
|--|-----|-----|--|----|----|---|--|-----|----|-----|----|----|--|--|--|
| Circuitry | | | | | | | | | | | | | | | |
| Push-pull plug, 5-pin | | | | | | | | | | | | | | | |
|  <table border="1" data-bbox="159 974 446 1041"> <tr> <td>PP</td> <td>1</td> <td>2</td> <td>3</td> <td>4</td> <td>5</td> </tr> <tr> <td></td> <td>24V</td> <td>0V</td> <td>24V</td> <td>0V</td> <td>FE</td> </tr> </table> | PP | 1 | 2 | 3 | 4 | 5 | | 24V | 0V | 24V | 0V | FE | Plug pattern to PROFINET specification  | | |
| | PP | 1 | 2 | 3 | 4 | 5 | | | | | | | | | |
| | 24V | 0V | 24V | 0V | FE | | | | | | | | | | |
| | | 1 | 24 V DC supply voltage for electronics and sensors | | | | | | | | | | | | |
| | | 2 | 0 V electronics and sensors | | | | | | | | | | | | |
| | | 3 | 24 V DC load voltage supply for valves and outputs | | | | | | | | | | | | |
| | | 4 | 0 V valves and outputs | | | | | | | | | | | | |
| | | 5 | FE | | | | | | | | | | | | |

Terminal CPX

Accessories – Interlinking block with system supply

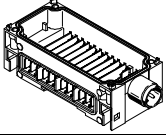
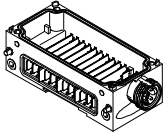
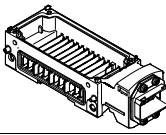
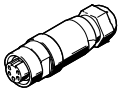
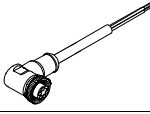
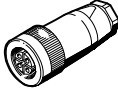
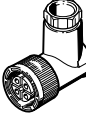
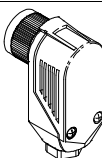
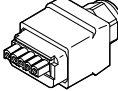
| Ordering data | | | | | |
|---|--|----------------------|----------------------|----------------------------------|---------------------------------|
| Designation | | | | Part No. | Type |
| Interlinking block with system supply | | | | | |
|  | Connection M18, plastic interlinking block | 4-pin | – | 195746 | CPX-GE-EV-S |
| | | | For ATEX environment | 8022170 | CPX-GE-EV-S-VL |
|  | Connection 7/8", plastic interlinking block | 4-pin | – | 541248 | CPX-GE-EV-S-7/8-4POL |
| | | | 5-pin | – | 541244 |
| | | For ATEX environment | – | 8022172 | CPX-GE-EV-S-7/8-5POL-VL |
| | | | – | 568956 | CPX-M-GE-EV-S-7/8-CIP-4P |
| Connection 7/8", metal interlinking block | 4-pin | – | 550208 | CPX-M-GE-EV-S-7/8-5POL | |
| | 5-pin | – | 8022165 | CPX-M-GE-EV-S-7/8-5POL-VL | |
| | For ATEX environment | – | 563057 | CPX-M-GE-EV-S-PP-5POL | |
|  | Connection push-pull plug (AIDA), metal interlinking block | 5-pin | – | | |
| 7/8" connection sockets | | | | | |
|  | Power supply socket | 5-pin | | 543107 | NECU-G78G5-C2 |
| | | 4-pin | | 543108 | NECU-G78G4-C2 |
|  | Angled socket, 5-pin – Open cable end, 5-wire | 2 m | | 573855 | NEBU-G78W5-K-2-N-LE5 |
| M18 connection sockets | | | | | |
|  | Straight socket, screw terminal | 4-pin | PG9 | 18493 | NTSD-GD-9 |
| | | 4-pin | PG13.5 | 18526 | NTSD-GD-13,5 |
|  | Angled socket, screw terminal | 4-pin | PG9 | 18527 | NTSD-WD-9 |
|  | Angled socket, screw terminal | 4-pin | PG11 | 533119 | NTSD-WD-11 |
| Connection socket AIDA push-pull | | | | | |
|  | Socket, spring-loaded terminal | 5-pin | | 563059 | NECU-M-PPG5-C1 |

Terminal CPX

Accessories – Interlinking block with system supply

| Ordering data | | | | |
|---|---|-----------------------------------|---------------|---------------------------|
| Designation | | | Part No. | Type |
| Mounting accessories | | | | |
|  | Screws for mounting the bus node/connection block on a plastic interlinking block | Bus node/metal connection block | 550218 | CPX-DPT-30X32-S-4X |
| | Screws for mounting the bus node/connection block on a metal interlinking block | Bus node/plastic connection block | 550219 | CPX-M-M3x22-4x |
| | | Bus node/metal connection block | 550216 | CPX-M-M3x22-S-4x |

Terminal CPX

Technical data – Interlinking block

Function

Interlinking blocks ensure the electrical supply of all other CPX modules. They have contact rails, from which the other CPX components on the interlinking modules are supplied with current.

Internal division of the power supply makes it possible to switch off specific areas of the sensors and actuators individually.

Applications

- All voltages are fed through to the next module by means of an interlinking system.
- The connected electronics module for inputs/outputs or bus node taps off the required voltage.





| General technical data | | |
|--|-------------------------------|-------------|
| Type | CPX-GE-EV | CPX-M-GE-EV |
| Electrical connection | – | – |
| Nominal operating voltage | [V DC] 24 | 24 |
| Acceptable current load (per contact/contact rail) | [A] 16 | 8 |
| Protection class to EN 60529 | Depending on connection block | |
| Ambient temperature | [°C] –5 ... +50 | |
| Note on materials | RoHS-compliant | |
| Materials | Reinforced PA | Aluminium |
| Grid dimension | [mm] 50 | |
| Dimensions W x L x H | [mm] 50 x 107 x 35 | |
| Weight | [g] 100 | 162 |

| Pin allocation | | | | | | | | | | | | | |
|--|---|-----|------------|--|--|--|--|--|--|--|-----------|---|---|
| Circuitry | | Pin | Allocation | | | | | | | | | | |
| <table border="1" style="display: inline-table; vertical-align: middle;"> <tr><td> </td></tr> <tr><td> </td></tr> <tr><td> </td></tr> <tr><td> </td></tr> <tr><td> </td></tr> <tr><td> </td></tr> <tr><td> </td></tr> <tr><td> </td></tr> <tr><td> </td></tr> <tr><td> </td></tr> </table> | | | | | | | | | | | 0V Valves | – | – |
| | | | | | | | | | | | | | |
| | | | | | | | | | | | | | |
| | | | | | | | | | | | | | |
| | | | | | | | | | | | | | |
| | | | | | | | | | | | | | |
| | | | | | | | | | | | | | |
| | | | | | | | | | | | | | |
| | | | | | | | | | | | | | |
| | | | | | | | | | | | | | |
| | | | | | | | | | | | | | |
| 24V Valves | – | – | | | | | | | | | | | |
| 0V Output | – | – | | | | | | | | | | | |
| 24V Output | – | – | | | | | | | | | | | |
| 0V El./Sen. | | | | | | | | | | | | | |
| 24V El./Sen. | | | | | | | | | | | | | |
| FE | | | | | | | | | | | | | |
| | | | | | | | | | | | | | |
| | | | | | | | | | | | | | |
| | | | | | | | | | | | | | |

Terminal CPX

Accessories – Interlinking block

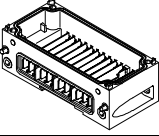
FESTO

| Ordering data – Mounting accessories | | | |
|---|---|-----------------------------------|---------------------------|
| Designation | | Part No. | Type |
| Interlinking block without supply | | | |
|  | Plastic interlinking block | 195742 | CPX-GE-EV |
| | Metal interlinking block | 550206 | CPX-M-GE-EV |
| Mounting accessories | | | |
|  | Screws for mounting the bus node/connection block on a plastic interlinking block | Bus node/metal connection block | 550218 CPX-DPT-30X32-S-4X |
| | Screws for mounting the bus node/connection block on a metal interlinking block | Bus node/plastic connection block | 550219 CPX-M-M3x22-4x |
| | | Bus node/metal connection block | 550216 CPX-M-M3x22-S-4x |

Terminal CPX

Technical data – Interlinking block with additional power supply for outputs

Function

Interlinking blocks ensure the electrical supply of all other CPX modules. They have contact rails, from which the other CPX components on the interlinking modules are supplied with current.

Internal division of the power supply makes it possible to switch off specific areas of the sensors and actuators individually.

Applications

- 24 V DC supply voltage for outputs



| General technical data | | |
|------------------------------|--------|-------------------------------|
| Nominal operating voltage | [V DC] | 24 |
| Protection class to EN 60529 | | Depending on connection block |
| Ambient temperature | [°C] | -5 ... +50 |
| Note on materials | | RoHS-compliant |
| Grid dimension | [mm] | 50 |
| Dimensions W x L x H | [mm] | 50 x 107 x 35 |

| Technical data – Plastic interlinking blocks | | | | | | |
|--|---------------|-----|-------------|-------------|--------------|--------|
| Type | CPX-GE-EV-Z | | | | | |
| | | -VL | -7/8-4POL | -7/8-5POL | -7/8-5POL-VL | |
| Electrical connection | M18 | M18 | 7/8", 4-pin | 7/8", 5-pin | 7/8", 5-pin | |
| Current supply | Outputs | [A] | Max. 16 | Max. 8 | Max. 10 | Max. 8 |
| Materials | PA reinforced | | | | | |
| Product weight | [g] | 125 | | | | |

| Technical data – Metal interlinking blocks | | | |
|--|--------------------|--------------|-----------------------|
| Type | CPX-M-GE-EV-Z | | |
| | -7/8-5POL | -7/8-5POL-VL | -PP-5POL |
| Electrical connection | 7/8", 5-pin | 7/8", 5-pin | AIDA push-pull, 5-pin |
| Current supply | Outputs | [A] | Max. 8 |
| Materials | Die-cast aluminium | | |
| Product weight | [g] | 187 | 187 |
| | | | 245 |

Terminal CPX

Technical data – Interlinking block with additional power supply for outputs

| Pin allocation – Plastic interlinking blocks | | Pin | Allocation | | | | | | | | | | | | | | | |
|--|------------|------|---|---|-----|------|---|----|------|----|------|------|-----|----|----|--|--|--|
| Circuitry | | | | | | | | | | | | | | | | | | |
| Round connector, 4-pin | | | | | | | | | | | | | | | | | | |
| | 0V Valves | | 1 | n.c. | | | | | | | | | | | | | | |
| | 24V Valves | | 2 | 24 V DC load voltage supply for outputs | | | | | | | | | | | | | | |
| 0V Output | 0V Output | 3 | 0 V | | | | | | | | | | | | | | | |
| 24V Output | 24V Output | 4 | FE | | | | | | | | | | | | | | | |
| 7/8" | | | | | | | | | | | | | | | | | | |
| 0V EL./Sen. | | A | n.c. | | | | | | | | | | | | | | | |
| 24V EL./Sen. | | B | 24 V DC load voltage supply for outputs | | | | | | | | | | | | | | | |
| FE | | C | FE | | | | | | | | | | | | | | | |
| | | D | 0V | | | | | | | | | | | | | | | |
| <table border="1"> <tr> <td>M18</td> <td>1</td> <td>2</td> <td>3</td> <td>4</td> </tr> <tr> <td>7/8"</td> <td>A</td> <td>B</td> <td>D</td> <td>C</td> </tr> <tr> <td></td> <td>n.c.</td> <td>24V</td> <td>0V</td> <td>FE</td> </tr> </table> | M18 | 1 | 2 | 3 | 4 | 7/8" | A | B | D | C | | n.c. | 24V | 0V | FE | | | |
| M18 | 1 | 2 | 3 | 4 | | | | | | | | | | | | | | |
| 7/8" | A | B | D | C | | | | | | | | | | | | | | |
| | n.c. | 24V | 0V | FE | | | | | | | | | | | | | | |
| Round connector, 5-pin | | | | | | | | | | | | | | | | | | |
| | 0V Valves | | 1 | 0 V outputs | | | | | | | | | | | | | | |
| | 24V Valves | | 2 | n.c. | | | | | | | | | | | | | | |
| 0V Output | 0V Output | 3 | FE | | | | | | | | | | | | | | | |
| 24V Output | 24V Output | 4 | n.c. | | | | | | | | | | | | | | | |
| 0V EL./Sen. | | 5 | 24 V DC load voltage supply for outputs | | | | | | | | | | | | | | | |
| 24V EL./Sen. | | | | | | | | | | | | | | | | | | |
| FE | | | | | | | | | | | | | | | | | | |
| <table border="1"> <tr> <td>7/8"</td> <td>1</td> <td>2</td> <td>3</td> <td>4</td> <td>5</td> </tr> <tr> <td></td> <td>0V</td> <td>n.c.</td> <td>FE</td> <td>n.c.</td> <td>24V</td> </tr> </table> | 7/8" | 1 | 2 | 3 | 4 | 5 | | 0V | n.c. | FE | n.c. | 24V | | | | | | |
| 7/8" | 1 | 2 | 3 | 4 | 5 | | | | | | | | | | | | | |
| | 0V | n.c. | FE | n.c. | 24V | | | | | | | | | | | | | |





Terminal CPX

Technical data – Interlinking block with additional power supply for outputs

| Pin allocation – Metal interlinking blocks | | Pin | Allocation | | | | | | | | | | | | | | | | | | | | | | |
|---|---|------|------------|------|-----|---|--|------|------|-----|------|-----|---|---|-------------|---|------|---|---|---|-------------|---|---|--|--|
| Circuitry | | | | | | | | | | | | | | | | | | | | | | | | | |
| Round connector, 5-pin | | | | | | | | | | | | | | | | | | | | | | | | | |
| <table border="1" style="margin-top: 10px;"> <tr> <td>7/8"</td> <td>1</td> <td>2</td> <td>3</td> <td>4</td> <td>5</td> </tr> <tr> <td></td> <td>0V</td> <td>n.c.</td> <td>FE</td> <td>n.c.</td> <td>24V</td> </tr> </table> | 7/8" | 1 | 2 | 3 | 4 | 5 | | 0V | n.c. | FE | n.c. | 24V | <p>7/8□</p> <table border="1" style="margin-top: 10px;"> <tr> <td>1</td> <td>0 V outputs</td> </tr> <tr> <td>2</td> <td>n.c.</td> </tr> <tr> <td>3</td> <td>FE</td> </tr> <tr> <td>4</td> <td>n.c.</td> </tr> <tr> <td>5</td> <td>24 V DC load voltage supply for outputs</td> </tr> </table> | 1 | 0 V outputs | 2 | n.c. | 3 | FE | 4 | n.c. | 5 | 24 V DC load voltage supply for outputs | | |
| | 7/8" | 1 | 2 | 3 | 4 | 5 | | | | | | | | | | | | | | | | | | | |
| | 0V | n.c. | FE | n.c. | 24V | | | | | | | | | | | | | | | | | | | | |
| 1 | 0 V outputs | | | | | | | | | | | | | | | | | | | | | | | | |
| 2 | n.c. | | | | | | | | | | | | | | | | | | | | | | | | |
| 3 | FE | | | | | | | | | | | | | | | | | | | | | | | | |
| 4 | n.c. | | | | | | | | | | | | | | | | | | | | | | | | |
| 5 | 24 V DC load voltage supply for outputs | | | | | | | | | | | | | | | | | | | | | | | | |
| Push-pull plug, 5-pin | | | | | | | | | | | | | | | | | | | | | | | | | |
| <table border="1" style="margin-top: 10px;"> <tr> <td>PP</td> <td>1</td> <td>2</td> <td>3</td> <td>4</td> <td>5</td> </tr> <tr> <td></td> <td>n.c.</td> <td>n.c.</td> <td>24V</td> <td>0V</td> <td>FE</td> </tr> </table> | PP | 1 | 2 | 3 | 4 | 5 | | n.c. | n.c. | 24V | 0V | FE | <p>Plug pattern to PROFINET specification</p> <table border="1" style="margin-top: 10px;"> <tr> <td>1</td> <td>n.c.</td> </tr> <tr> <td>2</td> <td>n.c.</td> </tr> <tr> <td>3</td> <td>24 V DC load voltage supply for outputs</td> </tr> <tr> <td>4</td> <td>0 V outputs</td> </tr> <tr> <td>5</td> <td>FE</td> </tr> </table> | 1 | n.c. | 2 | n.c. | 3 | 24 V DC load voltage supply for outputs | 4 | 0 V outputs | 5 | FE | | |
| | PP | 1 | 2 | 3 | 4 | 5 | | | | | | | | | | | | | | | | | | | |
| | n.c. | n.c. | 24V | 0V | FE | | | | | | | | | | | | | | | | | | | | |
| 1 | n.c. | | | | | | | | | | | | | | | | | | | | | | | | |
| 2 | n.c. | | | | | | | | | | | | | | | | | | | | | | | | |
| 3 | 24 V DC load voltage supply for outputs | | | | | | | | | | | | | | | | | | | | | | | | |
| 4 | 0 V outputs | | | | | | | | | | | | | | | | | | | | | | | | |
| 5 | FE | | | | | | | | | | | | | | | | | | | | | | | | |

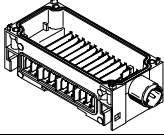
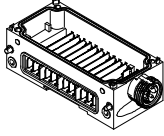
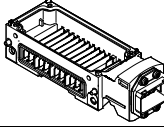
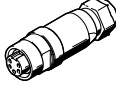
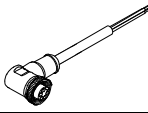
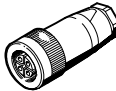
Terminal CPX

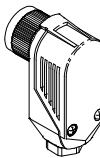
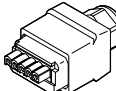
Accessories – Interlinking block with additional power supply for outputs

| Ordering data | | | | | |
|---|---|-----------------------------------|----------------------|----------|---------------------------|
| Designation | | | | Part No. | Type |
| Interlinking block with additional power supply for outputs | | | | | |
|  | Connection M18, plastic interlinking block | 4-pin | – | 195744 | CPX-GE-EV-Z |
| | | | For ATEX environment | 8022166 | CPX-GE-EV-Z-VL |
|  | Connection 7/8", plastic interlinking block | 4-pin | – | 541250 | CPX-GE-EV-Z-7/8-4POL |
| | | 5-pin | – | 541246 | CPX-GE-EV-Z-7/8-5POL |
| | Connection 7/8", metal interlinking block | 5-pin | – | 550210 | CPX-M-GE-EV-Z-7/8-5POL |
| | | | For ATEX environment | 8022158 | CPX-M-GE-EV-Z-7/8-5POL-VL |
|  | Connection push-pull plug (AIDA), metal interlinking block | 5-pin | – | 563058 | CPX-M-GE-EV-Z-PP-5POL |
| 7/8" connection sockets | | | | | |
|  | Power supply socket | 5-pin | | 543107 | NECU-G78G5-C2 |
| | | 4-pin | | 543108 | NECU-G78G4-C2 |
|  | Angled socket, 5-pin – Open cable end, 5-wire | 2 m | | 573855 | NEBU-G78W5-K-2-N-LE5 |
| M18 connection sockets | | | | | |
|  | Straight socket, screw terminal | 4-pin | PG9 | 18493 | NTSD-GD-9 |
| | | | PG13.5 | 18526 | NTSD-GD-13,5 |
|  | Angled socket, screw terminal | 4-pin | PG9 | 18527 | NTSD-WD-9 |
|  | Angled socket, screw terminal | 4-pin | PG11 | 533119 | NTSD-WD-11 |
| Connection socket AIDA push-pull | | | | | |
|  | Socket, spring-loaded terminal | 5-pin | | 563059 | NECU-M-PPG5-C1 |
| Mounting accessories | | | | | |
|  | Screws for mounting the bus node/connection block on a plastic interlinking block | Bus node/metal connection block | | 550218 | CPX-DPT-30X32-S-4X |
| | | Bus node/plastic connection block | | 550219 | CPX-M-M3x22-4x |
| | Screws for mounting the bus node/connection block on a metal interlinking block | Bus node/metal connection block | | 550216 | CPX-M-M3x22-S-4x |

Terminal CPX

Technical data – Interlinking block with additional power supply for valves

Function

Interlinking blocks ensure the electrical supply of all other CPX modules. They have contact rails, from which the other CPX components on the interlinking modules are supplied with current.

Internal division of the power supply makes it possible to switch off specific areas of the sensors and actuators individually.

Applications

- 24 V DC supply voltage for valves







| General technical data | | | | |
|--|--------|-------------------------------|----------------|----------------------|
| Type | | CPX-GE-EV-V | CPX-GE-EV-V-VL | CPX-GE-EV-V-7/8-4POL |
| Electrical connection | | M18 | | 7/8", 4-pin |
| Nominal operating voltage | [V DC] | 24 | | |
| Acceptable current load (per contact/contact rail) | [A] | 16 | 8 | 10 |
| Protection class to EN 60529 | | Depending on connection block | | |
| Ambient temperature | [°C] | -5 ... +50 | | |
| Note on materials | | RoHS-compliant | | |
| Materials | | Reinforced PA | | |
| Grid dimension | [mm] | 50 | | |
| Dimensions W x L x H | [mm] | 50 x 107 x 35 | | |
| Weight | [g] | 125 | | |

| Pin allocation – Plastic interlinking blocks | | | | | | | | | | | | | | | | | | |
|--|--|------|--|----|------|------|--|---|-----|---|----|------|-----|----|----|--|--|--|
| Circuitry | | Pin | Allocation | | | | | | | | | | | | | | | |
| Round connector, 4-pin | | | | | | | | | | | | | | | | | | |
| | M18 | | <table border="1"> <tr><td>1</td><td>n.c.</td></tr> <tr><td>2</td><td>24 V DC load voltage supply for valves</td></tr> <tr><td>3</td><td>0 V</td></tr> <tr><td>4</td><td>FE</td></tr> </table> | 1 | n.c. | 2 | 24 V DC load voltage supply for valves | 3 | 0 V | 4 | FE | | | | | | | |
| | 1 | n.c. | | | | | | | | | | | | | | | | |
| 2 | 24 V DC load voltage supply for valves | | | | | | | | | | | | | | | | | |
| 3 | 0 V | | | | | | | | | | | | | | | | | |
| 4 | FE | | | | | | | | | | | | | | | | | |
| | 7/8" | | <table border="1"> <tr><td>A</td><td>n.c.</td></tr> <tr><td>B</td><td>24 V DC load voltage supply for valves</td></tr> <tr><td>C</td><td>FE</td></tr> <tr><td>D</td><td>0V</td></tr> </table> | A | n.c. | B | 24 V DC load voltage supply for valves | C | FE | D | 0V | | | | | | | |
| A | n.c. | | | | | | | | | | | | | | | | | |
| B | 24 V DC load voltage supply for valves | | | | | | | | | | | | | | | | | |
| C | FE | | | | | | | | | | | | | | | | | |
| D | 0V | | | | | | | | | | | | | | | | | |
| <table border="1"> <tr> <td>M18</td> <td>1</td> <td>2</td> <td>3</td> <td>4</td> </tr> <tr> <td>7/8"</td> <td>A</td> <td>B</td> <td>D</td> <td>C</td> </tr> <tr> <td></td> <td>n.c.</td> <td>24V</td> <td>0V</td> <td>FE</td> </tr> </table> | M18 | 1 | 2 | 3 | 4 | 7/8" | A | B | D | C | | n.c. | 24V | 0V | FE | | | |
| M18 | 1 | 2 | 3 | 4 | | | | | | | | | | | | | | |
| 7/8" | A | B | D | C | | | | | | | | | | | | | | |
| | n.c. | 24V | 0V | FE | | | | | | | | | | | | | | |

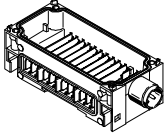
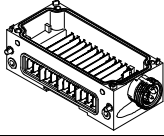
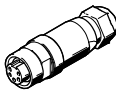
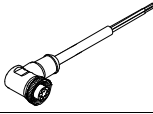
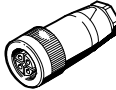
Terminal CPX

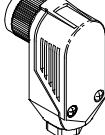
Accessories – Interlinking block with additional power supply for valves

| Ordering data | | | | | |
|---|---|---------------------------------|----------------------|----------|----------------------|
| Designation | | | | Part No. | Type |
| Interlinking block with additional power supply for valves | | | | | |
|  | Connection M18, plastic interlinking block | 4-pin | – | 533577 | CPX-GE-EV-V |
| | | | For ATEX environment | 8022171 | CPX-GE-EV-V-VL |
|  | Connection 7/8", plastic interlinking block | 4-pin | – | 541252 | CPX-GE-EV-V-7/8-4POL |
| 7/8" connection sockets | | | | | |
|  | Power supply socket | 5-pin | | 543107 | NECU-G78G5-C2 |
| | | 4-pin | | 543108 | NECU-G78G4-C2 |
|  | Angled socket, 5-pin – Open cable end, 5-wire | 2 m | | 573855 | NEBU-G78W5-K-2-N-LE5 |
| M18 connection sockets | | | | | |
|  | Straight socket, screw terminal | 4-pin | PG9 | 18493 | NTSD-GD-9 |
| | | 4-pin | PG13.5 | 18526 | NTSD-GD-13,5 |
|  | Angled socket, screw terminal | 4-pin | PG9 | 18527 | NTSD-WD-9 |
|  | Angled socket, screw terminal | 4-pin | PG11 | 533119 | NTSD-WD-11 |
| Mounting accessories | | | | | |
|  | Screws for mounting the bus node/connection block on a plastic interlinking block | Bus node/metal connection block | | 550218 | CPX-DPT-30X32-S-4X |

Terminal CPX

Technical data – Pneumatic interface VMPA-FB

Function

The pneumatic interface VMPA-FB establishes the electromechanical connection between the CPX terminal and the valve terminal MPA-S. The signals from the bus node are forwarded to the control electronics in the electrical modules of the valve terminal MPA-S via the integrated CPX bus. The bus signal for activation of the solenoid coils is converted in the electronics module for max. 8 coils. From a technical point of view, the individual MPA pneumatic modules each represent a separate electrical module with digital outputs. Valves, which are galvanically isolated, can be supplied with power via the interlinking block CPX-GE-EV-V.

Applications

- Interface to the valve terminal MPA-S
- Max. 128 solenoid coils
- Features of the electronics module of the valve terminal MPA-S can be parameterised, for example status of the solenoid coils in the event of fieldbus communication being interrupted (fail-safe), individual channel diagnostics can be activated, condition monitoring can be activated individually for each valve
- The pneumatic interface receives the voltage for the electronics and the supply voltage for the valves from the left-hand interlinking block and feeds them through to the electronics modules of the valve terminal MPA-S
- Electronics modules of the valve terminal MPA-S:
 - Undervoltage of valves
 - Short circuit of valves
 - Open load of valves
 - Counter preset reached in condition monitoring



| General technical data | | |
|----------------------------------|---------------|--------------------|
| Type | VMPA-FB-EPL-G | VMPA-FB-EPL-E |
| No. of solenoid coils | 128 | |
| Pilot air supply | Internal | External |
| Pilot air connection 12/14 | – | M7 |
| Pneumatic connection 1 | G1/4 | G1/4 |
| Operating pressure [bar] | 3 ... 8 | –0.9 ... 10 |
| Pilot pressure [bar] | 3 ... 8 | 3 ... 8 |
| Nominal operating voltage [V DC] | 24 | |
| Protection class to EN 60529 | IP65 | |
| Ambient temperature [°C] | –5 ... +50 | |
| Materials | Cover | PA |
| | Housing | Die-cast aluminium |
| Weight [g] | Approx. 320 | |

Terminal CPX

Accessories – Pneumatic interface VMPA-FB

FESTO

Overview – Pneumatic interface VMPA-FB

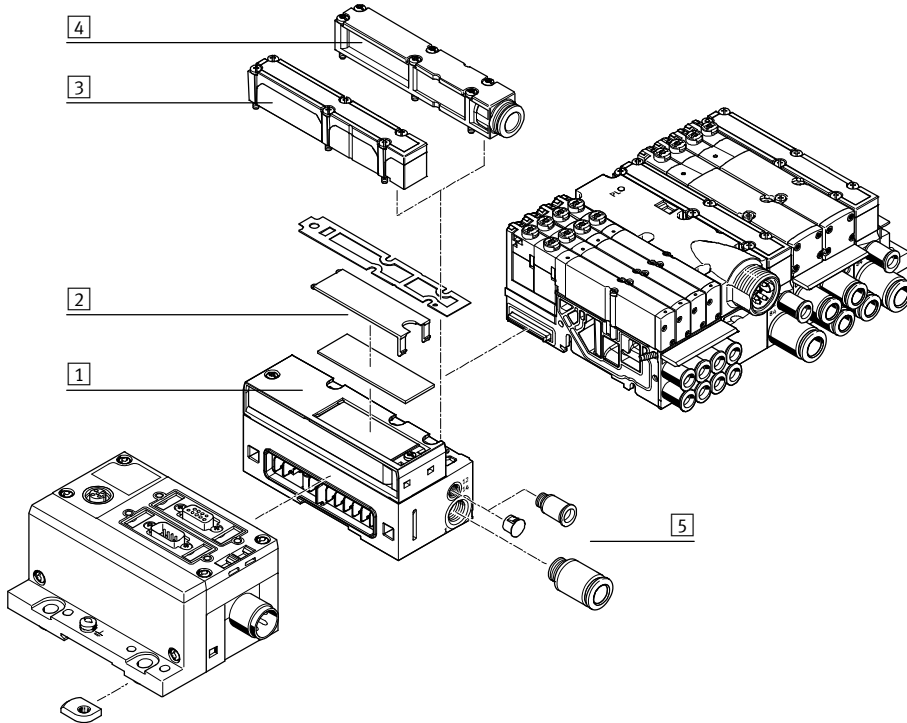

- 1 Pneumatic interface VMPA-FB
- 2 Inscription label
- 3 Flat plate silencer
- 4 Exhaust plate for ducted exhaust air
- 5 Fittings

Ordering data

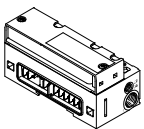
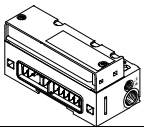
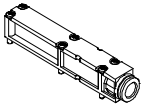
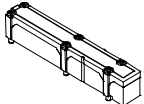
| Designation | Part No. | Type |
|---|--|------------------------|
| Pneumatic interface for CPX plastic interlinking module | | |
|  | Ducted exhaust air, internal pilot air | 533370 VMPA-FB-EPL-G |
| | Ducted exhaust air, external pilot air | 533369 VMPA-FB-EPL-E |
| | Flat plate silencer, internal pilot air | 533372 VMPA-FB-EPL-GU |
| | Flat plate silencer, external pilot air | 533371 VMPA-FB-EPL-EU |
| Pneumatic interface for CPX metal interlinking module | | |
|  | Ducted exhaust air, internal pilot air | 552286 VMPA-FB-EPLM-G |
| | Ducted exhaust air, external pilot air | 552285 VMPA-FB-EPLM-E |
| | Flat plate silencer, internal pilot air | 552288 VMPA-FB-EPLM-GU |
| | Flat plate silencer, external pilot air | 552287 VMPA-FB-EPLM-EU |
| Exhaust plate | | |
|  | For ducted exhaust air, with 10 mm push-in connector | 533375 VMPA-AP |
| | For ducted exhaust air, with QS-3/8 connector | 541629 VMPA-AP-3/8 |
|  | Flat plate silencer | 533374 VMPA-APU |

Terminal CPX

Technical data – Pneumatic interface VMPAL

Function

The pneumatic interface VMPAL establishes the electromechanical connection between the terminal CPX and the valve terminal MPA-L.

The bus signal for actuating the solenoid coils is converted in the pneumatic interface for the entire valve terminal.

The interlinking within the valve terminal is identical with the interlinking with multi-pin plug connections.

Application

- Actuation of the valve terminal MPA-L
- Max. 32 solenoid coils
- The pneumatic interface receives the voltage for the electronics and the supply voltage for the valves from the left-hand interlinking block and feeds them through to the electric modules of the valve terminal MPA-L



| General technical data | | VMPAL-EPL-CPX |
|------------------------------|--------|----------------|
| Type | | VMPAL-EPL-CPX |
| Number of solenoid coils | | 32 |
| Operating pressure | [bar] | -0.9 ... 10 |
| Pilot pressure | [bar] | 3 ... 8 |
| Nominal operating voltage | [V DC] | 24 |
| Protection class to EN 60529 | | IP67 |
| Ambient temperature | [°C] | -5 ... +50 |
| Note on materials | | RoHS-compliant |

Overview – Pneumatic interface VMPAL

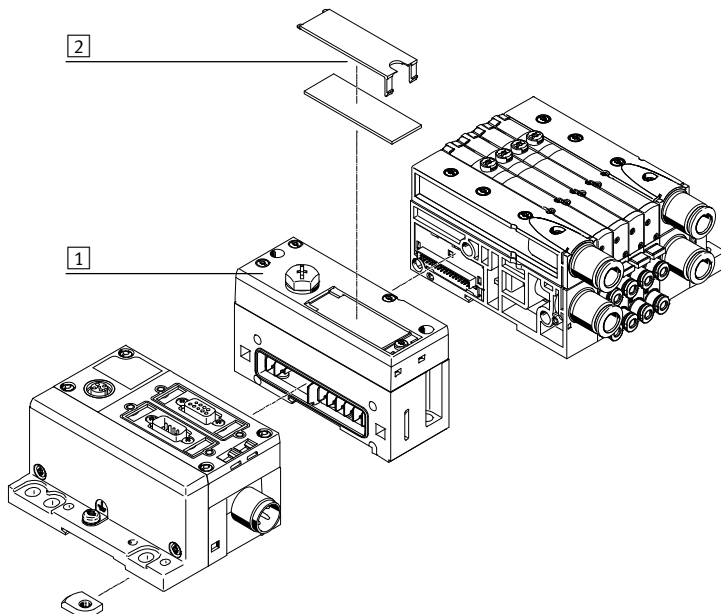

- 1 Pneumatic interface VMPAL
- 2 Inscription label

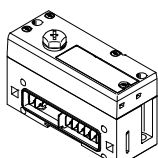
| Ordering data | | |
|---|----------|---------------|
| Designation | Part No. | Type |
|  Pneumatic interface for CPX plastic interlinking module | 570783 | VMPAL-EPL-CPX |

Terminal CPX

Technical data – Pneumatic interface VMPAF

Function

The pneumatic interface VMPAF establishes the electromechanical connection between the CPX terminal and the valve terminal MPA-F. The signals from the bus node are forwarded to the control electronics in the electrical modules of the valve terminal MPA-F via the integrated CPX bus. The bus signal for activation of the solenoid coils is converted in the electronics module for max. 8 coils. From a technical point of view, the individual MPA-F pneumatic modules each represent a separate electrical module with digital outputs. Valves, which are galvanically isolated, can be supplied with power via the interlinking block CPX-GE-EV-V.

Applications

- Interface to the valve terminal MPA-F
- Max. 128 solenoid coils
- Electronics module can be parameterised, for example status of the solenoid coils in the event of fieldbus communication being interrupted (fail-safe), individual channel diagnostics, condition monitoring can be activated individually for each valve
- In the version with pressure sensor, display of the numerical pressure value, unit and adherence to setpoint value. Parameterisation via PLC or handheld unit (CPX-MMI)
- Voltage for electronics and valves supplied from the left-hand interlinking block
- Electronics modules of the valve terminal MPA-F:
 - Undervoltage of valves
 - Short circuit of valves
 - Open load of valves
 - Counter preset reached in condition monitoring



| General technical data | | |
|---|---------------------|---|
| Type | VMPAF-FB-EPL | VMPAF-FB-EPL-PS |
| Version | – | With integrated pressure sensor for channel 1 |
| No. of solenoid coils | 128 | |
| Pneumatic connection 1 | G $\frac{1}{2}$ | |
| Operating pressure | [bar] –0.9 ... 10 | 0 ... 10 |
| Accuracy FS | [%] – | 2.5 |
| Nominal operating voltage | [V DC] 24 | |
| Protection class to EN 60529 | IP65 | |
| Ambient temperature | [°C] –5 ... +50 | |
| CE mark (see declaration of conformity) | To EU EMC Directive | |
| Note on materials | RoHS-compliant | |
| Weight | [g] 690 | |



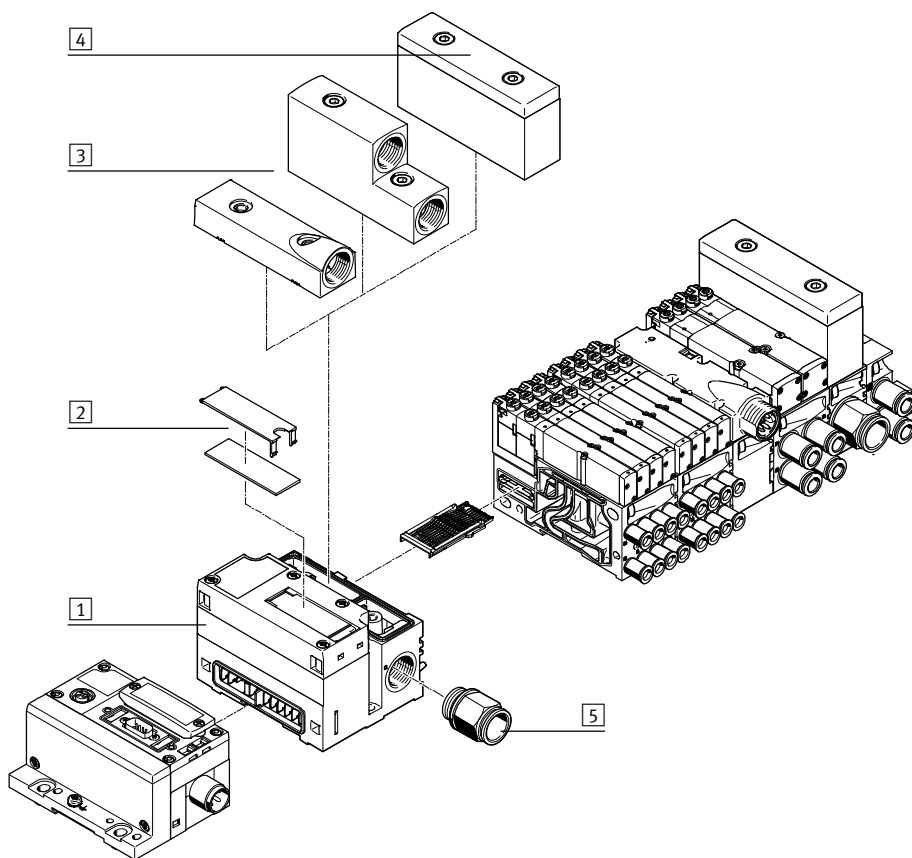

Terminal CPX

Accessories – Pneumatic interface VMPAF

Overview – Pneumatic interface VMPAF

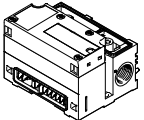
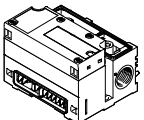

- 1 Pneumatic interface VMPAF
- 2 Inscription label
- 3 Exhaust plate for ducted exhaust air
- 4 Flat plate silencer
- 5 Fittings

| Ordering data | | |
|---|---|-------------------------|
| Designation | Part No. | Type |
| Pneumatic interface for CPX plastic interlinking module | | |
|  | Without exhaust plate, without flat plate silencer | 544399 VMPAF-FB-EPL |
| | Without exhaust plate, without flat plate silencer, with integrated pressure sensor for channel 1 | 547491 VMPAF-FB-EPL-PS |
| Pneumatic interface for CPX metal interlinking module | | |
|  | Without exhaust plate, without flat plate silencer | 552279 VMPAF-FB-EPLM |
| | Without exhaust plate, without flat plate silencer, with integrated pressure sensor for channel 1 | 552280 VMPAF-FB-EPLM-PS |
| Exhaust plate | | |
|  | For ducted exhaust air, ducts 3/5 common | 544411 VMPAF-AP-1 |
|  | For ducted exhaust air, duct 3 and duct 5 separated | 544412 VMPAF-AP-2 |
|  | Flat plate silencer | 544410 VMPAF-APU |

Terminal CPX

Technical data – Pneumatic interface VTSA/VTSA-F

Function

The pneumatic interface VTSA provides the electromechanical connection between the terminal CPX and valve terminal VTSA/VTSA-F.

A complete pneumatic control loop system (FB-valve-drive-sensor-FB) can therefore be connected to the fieldbus using the input modules of the terminal CPX.

Different circuits for valves and electrical outputs are implemented using an additional power supply. The integrated valve diagnostic functions enable the causes of errors to be found quickly, therefore increasing system availability.

Application

- Interface to the valve terminal VTSA and VTSA-F
- Max. 32 solenoid coils
- Address space allocation (configuration) of valve terminals can be set using integrated DIL switches
- Properties of the pneumatic interface can be parameterised, e.g. status of the solenoid coil when fieldbus communication is interrupted (failsafe)
- The pneumatic interface receives the voltage for the electronics and the supply voltage for the valves from the left-hand interlinking block
- Detection of missing solenoid coils and short circuit monitoring for the valves



| General technical data | | | |
|--|-----------------------|--|---------------|
| Number of solenoid coils | | 32 | |
| Electrical actuation | | Fieldbus | |
| Electrical connection | | Via CPX | |
| Diagnostics | | Undervoltage at valves | |
| Parameterisation | | <ul style="list-style-type: none"> • Failsafe per channel • Forces per channel • Idle mode per channel • Module monitoring | |
| LED displays | | <ul style="list-style-type: none"> • 1 Group diagnostics • Channel status (on each valve) | |
| Fuse protection (short circuit) | | Internal electronic fuse per valve output | |
| Electrical isolation channel – internal bus | | Yes, when using an additional power supply for the valves | |
| Nominal operating voltage | | [V DC] | 24 |
| Operating voltage range | | [V DC] | 21.6 ... 26.4 |
| Intrinsic current consumption at nominal operating voltage | Electronic components | [mA] | Typically 15 |
| | Valves | [mA] | Typically 50 |
| Max. power supply per channel | | [A] | 0.2 |
| Max. residual current per module | | [A] | 4 |
| Protection class | | <ul style="list-style-type: none"> • IP65 (to EN 60529) • NEMA 4 | |
| Ambient temperature | | [°C] | -5 ... +50 |
| Materials | Housing | Die-cast aluminium | |
| | Bearing and end cap | PA | |
| Note on materials | | RoHS-compliant | |
| Product weight | | [g] | 590 |

| Ordering data | | | | |
|---------------|--------------------------------|-----------------------------|---------------------|-----------------------|
| Designation | | Part No. | Type | |
| | For plastic interlinking block | 543416 | VABA-S6-1-X1 | |
| | For metal interlinking block | Diagnostics via fieldbus | 550663 | VABA-S6-1-X2 |
| | | Diagnostics via image table | 573613 | VABA-S6-1-X2-D |

Terminal CPX

Technical data – Pneumatic interface MIDI/MAXI

Function

The pneumatic interface MIDI/MAXI connects the valve terminal MIDI/MAXI to the supported fieldbus protocols of the CPX terminal. A complete pneumatic control loop system (FB-valve-drive-sensor-FB) can therefore be connected to the fieldbus using the input modules of the CPX terminal. Different circuits for valves and electrical outputs are implemented using an additional power supply. The integrated valve diagnostic functions enable the causes of errors to be found quickly, therefore increasing system availability.

Applications

- Interface to valve terminals MIDI/MAXI
- Max. 26 solenoid coils
- Address space allocation (configuration) of valve terminals can be set using integrated DIL switches
- Pneumatic interface features can be parameterised, for example status of the solenoid coils in the event of fieldbus communication being interrupted (fail-safe)
- The pneumatic interface receives the voltage for the electronics and the supply voltage for the valves from the left-hand interlinking block



| General technical data | | | CPX-GP-03-4,0 | CPX-M-GP-03-4,0 |
|--|------------------------|--------|---|-----------------|
| Type | | | Plastic | Metal |
| Connection for CPX interlinking blocks made of | | | | |
| No. of solenoid coils | | | 26 | |
| Max. power supply | Per module | [A] | 4 | |
| | Per channel | [A] | 0.2 | |
| Fuse protection | | | Internal electronic fuse for each valve output | |
| Current consumption of modules for electronics | | [mA] | Typically 15 | |
| Current consumption of modules for valves | | [mA] | Typically 30 | |
| Nominal operating voltage | | [V DC] | 24 | |
| Operating voltage range | | [V DC] | 21.6 ... 26.4 | |
| Electrical isolation | Channel – channel | | No | |
| | Channel – internal bus | | Yes, using an additional power supply for valves | |
| LED displays | Group diagnostics | | 1 | |
| | Channel diagnostics | | – | |
| | Channel status | | – (on valves) | |
| Diagnostics | | | <ul style="list-style-type: none"> • Undervoltage of valves | |
| Parameterisation | | | <ul style="list-style-type: none"> • Module monitoring • Fail-safe behaviour, channel x | |
| Protection class to EN 60529 | | | IP65 | |
| Ambient temperature | | [°C] | –5 ... +50 | |
| Materials | Cover | | Steel | |
| | | | Die-cast aluminium | |
| Grid dimension | | [mm] | 50 | |
| Dimensions W x L x H | | [mm] | 50 x 132 x 55 | |
| Weight | | [g] | 390 | |

Terminal CPX

Accessories – Pneumatic interface MIDI/MAXI

FESTO

Connection and display components

CPX-GP-03-4,0

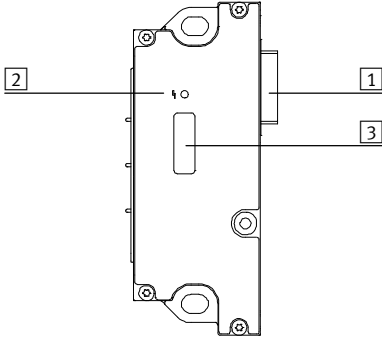

- 1 Connecting plug to valves
- 2 Error LED (red)
- 3 DIL switch under transparent cover

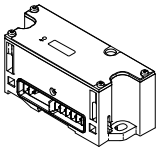
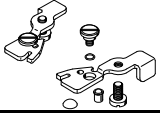
| Ordering data | | | |
|---|---|----------|-----------------|
| Designation | | Part No. | Type |
| Pneumatic interface MIDI/MAXI | | | |
|  | For plastic interlinking block | 195738 | CPX-GP-03-4,0 |
| | For metal interlinking block | 556775 | CPX-M-GP-03-4,0 |
| H-rail mounting | | | |
|  | For mounting CPX terminal and valve terminal MIDI on H-rail | 526033 | CPX-03-4,0 |
| | For mounting CPX terminal and valve terminal MAXI on H-rail | 526034 | CPX-03-7,0 |

Terminal CPX

Technical data – Pneumatic interface CPA

Function

The pneumatic interface CPA connects the valve terminal CPA to the supported fieldbus protocols of the CPX terminal. A complete pneumatic control loop system (FB-valve-drive-sensor-FB) can therefore be connected to the fieldbus using the input modules of the CPX terminal. Different circuits for valves and electrical outputs are implemented using an additional power supply. The integrated valve diagnostic functions enable the causes of errors to be found quickly, therefore increasing system availability.

Applications

- Interface to valve terminals CPA14
- Max. 22 solenoid coils
- Address space allocation (configuration) of valve terminals can be set using integrated DIL switches
- Pneumatic interface features can be parameterised, for example status of the solenoid coils in the event of fieldbus communication being interrupted (fail-safe)
- The pneumatic interface receives the voltage for the electronics and the supply voltage for the valves from the left-hand interlinking block
- Detection of missing solenoid coils and short circuit monitoring for the valves



| General technical data | | | |
|--|------------------------|--------|--|
| No. of solenoid coils | | | 22 |
| Max. power supply | Per module | [A] | 4 |
| | Per channel | [A] | 0.2 |
| Fuse protection | | | Internal electronic fuse for each valve output |
| Current consumption of module from electronics/sensor supply | | [mA] | Typically 15 |
| Supply voltage for valves | | [V DC] | 24 +10% –15% |
| Electrical isolation | Channel – channel | | No |
| | Channel – internal bus | | Yes, using an additional power supply for valves (in preparation) |
| LED displays | Group diagnostics | | 1 |
| | Channel diagnostics | | – |
| | Channel status | | – (on valves) |
| Diagnostics | | | <ul style="list-style-type: none"> • Load voltage of valves • Short circuit, solenoid coils (channel-oriented) • Wire break, solenoid coils (channel-oriented quiescent current detection for solenoid coils) |
| Parameterisation | | | <ul style="list-style-type: none"> • Module monitoring • Wire break monitoring, channel x • Fail-safe behaviour, channel x |
| Protection class to EN 60529 | | | IP65 |
| Temperature range | Operation | [°C] | –5 ... +50 |
| | Storage/transport | [°C] | –20 ... +70 |
| Materials | | | Reinforced PA |
| Grid dimension | | [mm] | 50 |
| Dimensions W x L x H | | [mm] | 50 x 110 x 58 |
| Weight | | [g] | 150 |

- 1 - Type discontinued
Available up until 2018

FESTO

Terminal CPX

Accessories – Pneumatic interface CPA

Connection and display components

CPX-GP-CPA-...

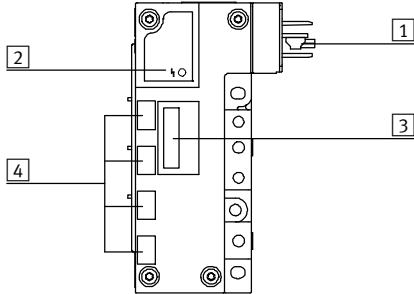

- 1 Connecting plug to valves
- 2 Error LED (red)
- 3 DIL switch under transparent cover
- 4 Inscription fields for addresses

Ordering data

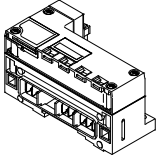
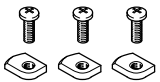
| Designation | | Part No. | Type |
|---|--|----------|----------------|
| Pneumatic interface CPA | | | |
|  | For CPA in 14 mm width | 195712 | CPX-GP-CPA-14 |
| H-rail mounting | | | |
|  | For mounting CPX terminal and valve terminal CPA on H-rail | 526032 | CPX-CPA-BG-NRH |

Terminal CPX

Technical data

FESTO

Dimensions – Plastic interlinking module

Download CAD data → www.festo.com

With bus nodes and connection blocks

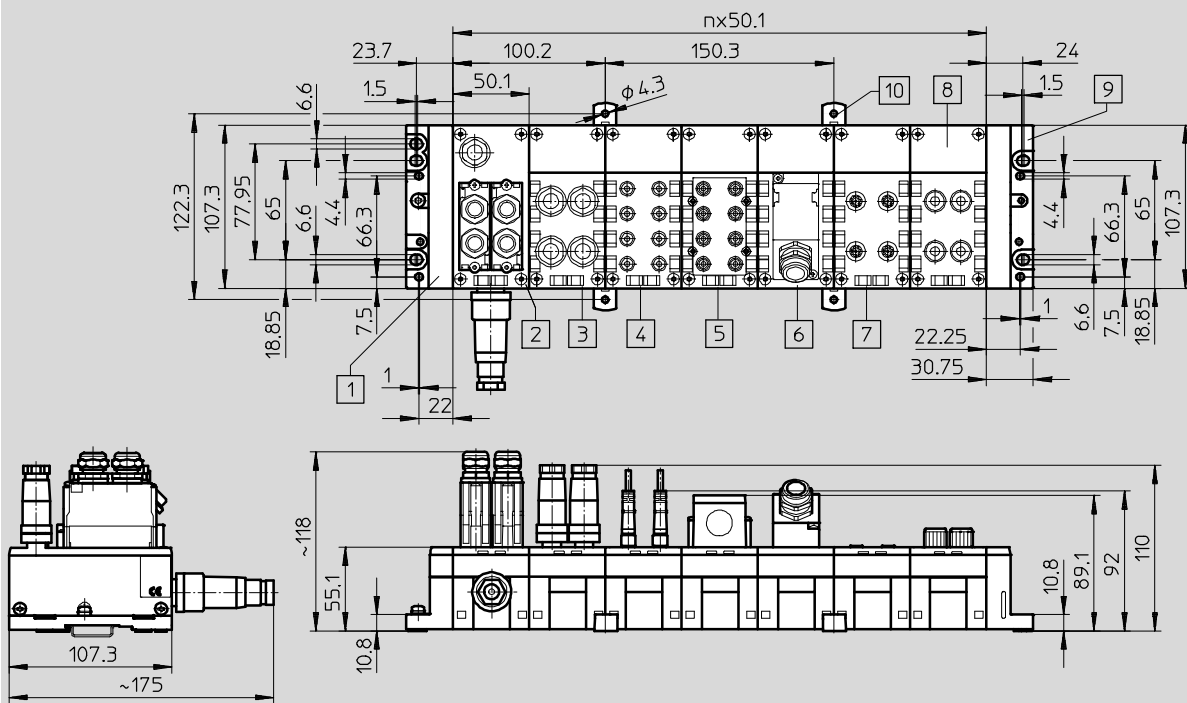

- | | | | |
|--|---|---|--|
| 1 Left-hand end plate (earthing plate optional) | 5 Connection block CPX-AB-8-KL-4POL | 8 Connection block CPX-AB-4-M12x2-5POL | n Number of bus nodes and connection blocks for CPX |
| 2 Bus nodes | 6 Connection block CPX-AB-1-SUB-BU-25POL | 9 Right-hand end plate | |
| 3 Connection block CPX-AB-4-M12-8POL | 7 Connection block CPX-AB-4-HAR-4POL | 10 Mounting clip for wall mounting (required every 2 ... 3 connection blocks) | |
| 4 Connection block CPX-AB-8-M8-3POL | | | |

Terminal CPX

Technical data

FESTO

Dimensions – Metal interlinking block
With bus nodes and connection blocks

Download CAD data → www.festo.com

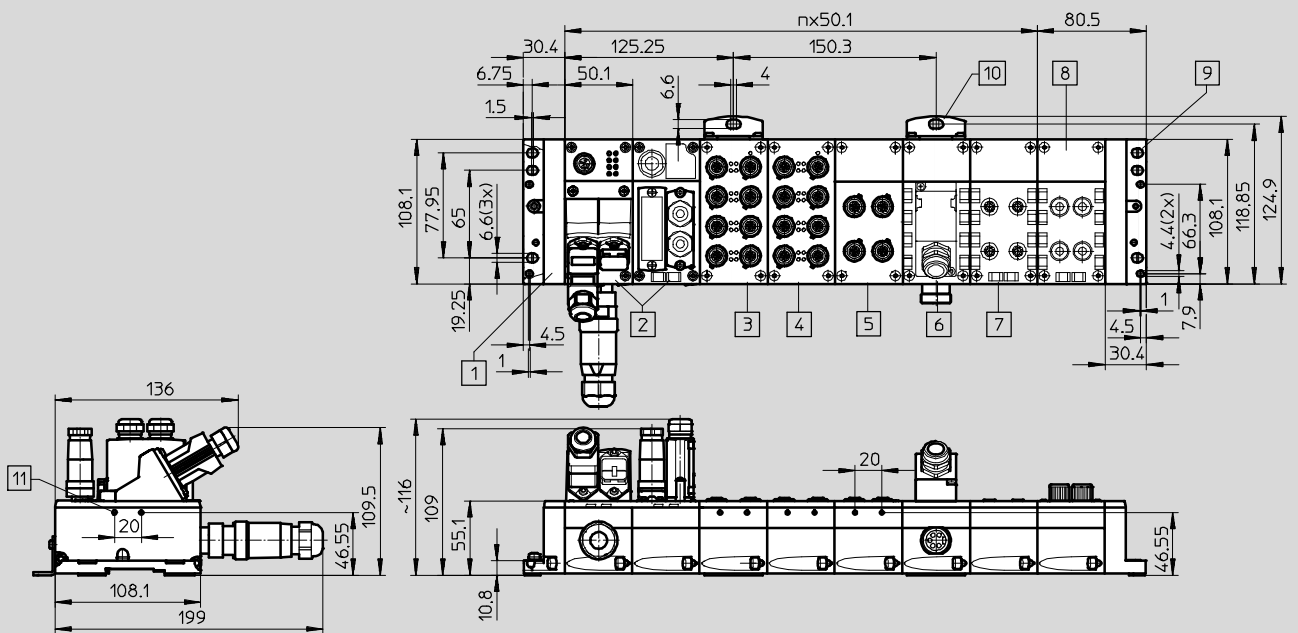

- | | | | | | | | |
|---|---|---|---|----|---------------------------------------|---|--|
| 1 | Left-hand end plate | 6 | Connection block CPX-AB-1-SUB-BU-25POL | 9 | Right-hand end plate | n | Number of bus nodes and connection blocks for CPX |
| 2 | Bus nodes | 7 | Connection block CPX- AB-4-M12-8POL | 10 | Mounting bracket for wall mounting | | |
| 3 | Connection block CPX-M-AB-8-M12X2-5POL | 8 | Connection block CPX-AB-4-HAR-4POL | 11 | Hole for self-tapping screw M2.5 | | |
| 4 | Connection block CPX-M-AB-8-M12X2-5POL | | | | | | |
| 5 | Connection block CPX-M-AB-4-M12X2-5POL | | | | | | |

Terminal CPX

Technical data

Dimensions

Download CAD data → www.festo.com

With bus nodes and valve terminal VTSA

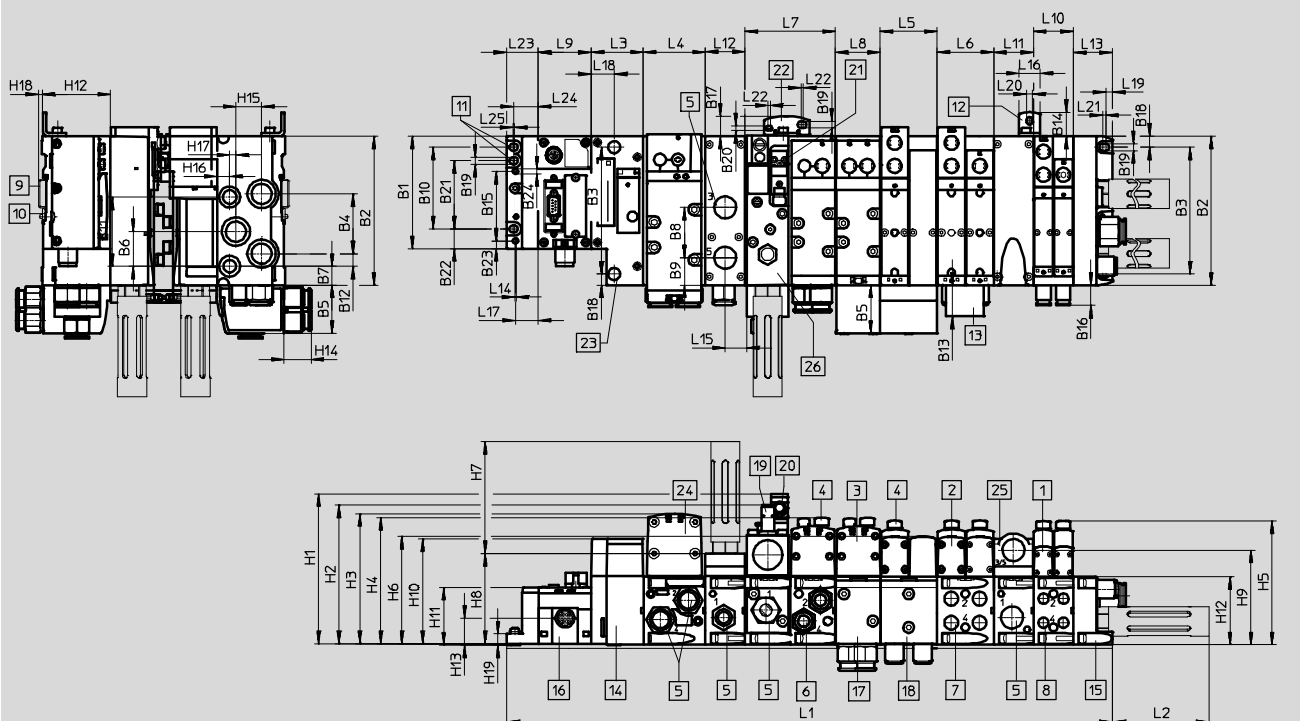

- | | | | |
|---------------------------------------|--|---|---|
| 1 Solenoid valve, width 18 mm | 10 H-rail mounting | 20 Plug socket M12x1 | n02 Number of manifold sub-bases 38 mm |
| 2 Solenoid valve, width 26 mm | 11 Mounting hole | 21 Electrical connection to EN 175301-803, type C | n01 Number of manifold sub-bases 54 mm |
| 3 Solenoid valve, width 42 mm | 12 Additional mounting bracket | 22 Additional mounting bracket | n1 Number of manifold sub-bases 43 mm |
| 4 Cover cap/manual override | 13 Inscription label holder | 23 Hole for additional mounting, diameter 6.4 2x | n2 Number of manifold sub-bases 59 mm |
| 5 Threaded connection G $\frac{3}{2}$ | 14 Pneumatic interface CPX | 24 Solenoid valve, width 52 mm | n Number of supply plates (only with end plate with pilot air selector) |
| 6 Threaded connection G $\frac{3}{8}$ | 15 End plate | 25 Supply plate | m Number of CPX modules |
| 7 Threaded connection G $\frac{1}{4}$ | 16 CPX module/bus node | 26 Soft-start valve | |
| 8 Threaded connection G $\frac{1}{8}$ | 17 90° connection plate 43 mm, G $\frac{3}{8}$ | | |
| 9 H-rail | 18 90° connection plate 54 mm, G $\frac{1}{4}$ | | |
| | 19 Proximity sensor M12x1 | | |

| Dim. | B1 | B2 | B3 | B4 | B5 | B6 | B7 | B8 | B9 | B10 | B11 | B12 | B13 | B14 | B16 | B18 | B19 | B20 | B21 | B22 | B23 | B24 |
|------|-------|-----|-----|----|----|----|----|----|----|-----|-----|-----|------|-----|------|------|-----|-----|-----|------|-----|-----|
| [mm] | 107.3 | 142 | 121 | 57 | 46 | 33 | 18 | 48 | 26 | 78 | 66 | 12 | 29.6 | 23 | 19.5 | 10.5 | 6.6 | 4.5 | 65 | 18.9 | 7.5 | 4.4 |

| Dim. | L2 | L3 | L4 | L5 | L6 | L7 | L8 | L9 | L10 | L11 | L12 | L13 | L14 | L15 | L16 | L17 | L18 | L19 | L20 | L21 | L22 |
|------|------|----|-------|--------|----|-------|----|-------|--------|------|-----|------|-----|------|-----|-----|-----|-----|-----|-----|-----|
| [mm] | 92.4 | 50 | n2x59 | n01x54 | 54 | n1x43 | 43 | mx201 | n02x38 | nx38 | 38 | 37.3 | 1 | 20.5 | 20 | 22 | 22 | 6.3 | 5.5 | 3 | 2 |

| Dim. | L23 | L24 | L25 | H1 | H2 | H3 | H4 | H5 | H6 | H7 | H8 | H9 | H10 | H11 | H12 | H13 | H14 | H15 | H16 | H17 | H18 | H19 |
|------|------|------|-----|-------|-------|-----|-------|-------|-----|-------|----|------|-------|------|-----|------|------|------|-----|-----|-----|------|
| [mm] | 30.4 | 23.7 | 1.5 | 143.9 | 133.3 | 125 | 121.3 | 118.2 | 103 | 106.8 | 87 | 90.3 | 101.4 | 55.1 | 65 | 25.8 | 25.7 | 24.5 | 12 | 6 | 3.5 | 10.8 |

| Width | L1 |
|--|---|
| 18 mm | $30.4 + m \times 501 + 50 + n02 \times 38 + n \times 38 + 37.3$ |
| 26 mm | $30.4 + m \times 501 + 50 + n01 \times 54 + n \times 38 + 37.3$ |
| 42 mm | $30.4 + m \times 501 + 50 + n1 \times 43 + n \times 38 + 37.3$ |
| 52 mm | $30.4 + m \times 501 + 50 + n2 \times 59 + n \times 38 + 37.3$ |
| Mixture of 18 mm, 26 mm, 42 mm and 52 mm | $30.4 + m \times 501 + 50 + n02 \times 38 + n01 \times 54 + n1 \times 43 + n2 \times 59 + n \times 38 + 37.3$ |

Note: This product conforms to ISO 1179-1 and to ISO 228-1

Terminal CPX

Technical data

FESTO

Dimensions

Download CAD data → www.festo.com

With bus nodes and valve terminal VTSA-F

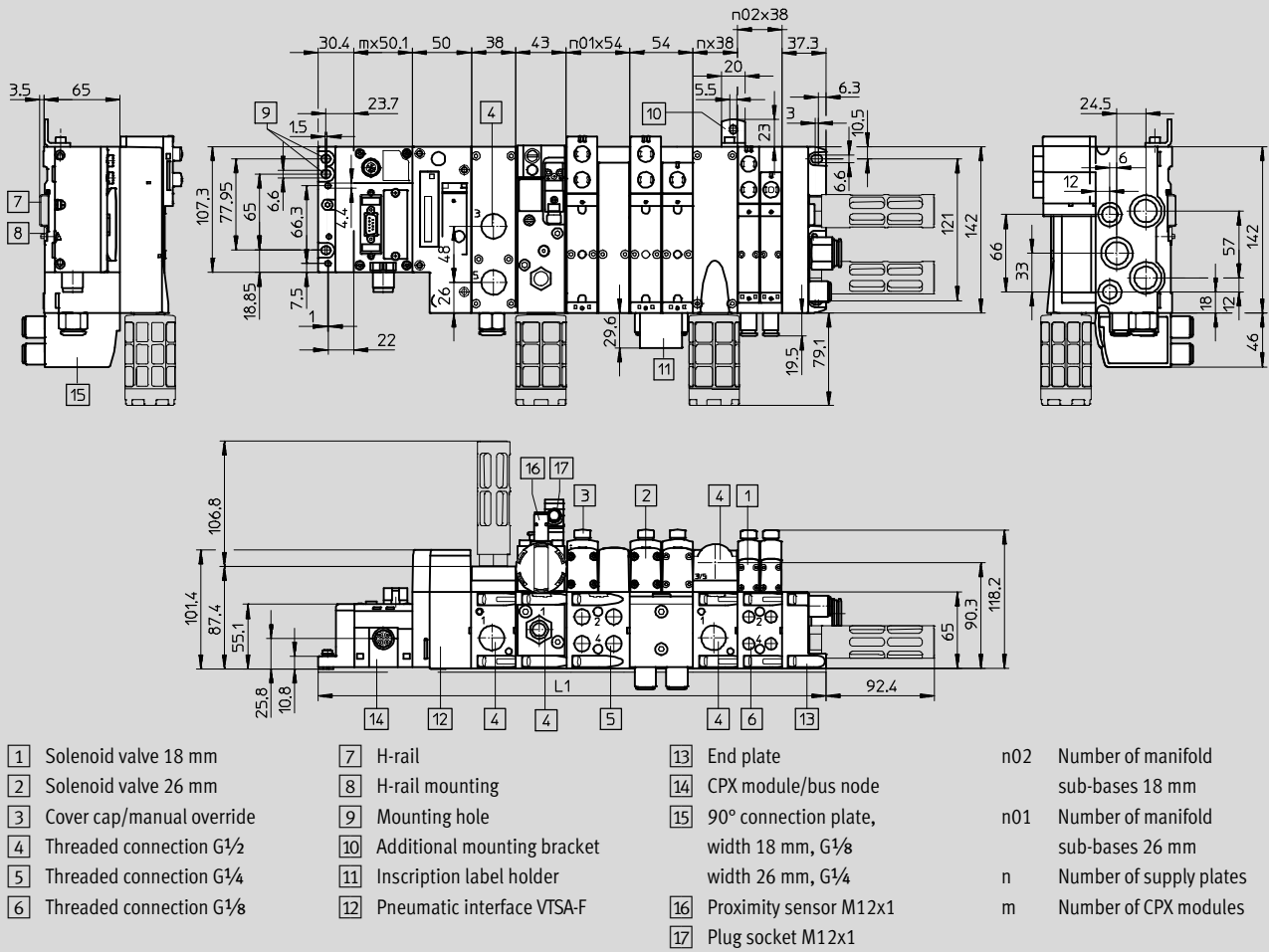

| Width | L1 |
|----------------------------|--|
| 18 mm | $30.4 + m \times 50.1 + 50 + n02 \times 38 + n \times 38 + 37.3$ |
| 26 mm | $30.4 + m \times 50.1 + 50 + n01 \times 54 + n \times 38 + 37.3$ |
| Mixture of 18 mm and 26 mm | $30.4 + m \times 50.1 + 50 + n02 \times 38 + n01 \times 54 + n \times 38 + 37.3$ |

Terminal CPX

Technical data

Dimensions

Download CAD data → www.festo.com

With bus nodes, connection blocks and valve terminal CPA

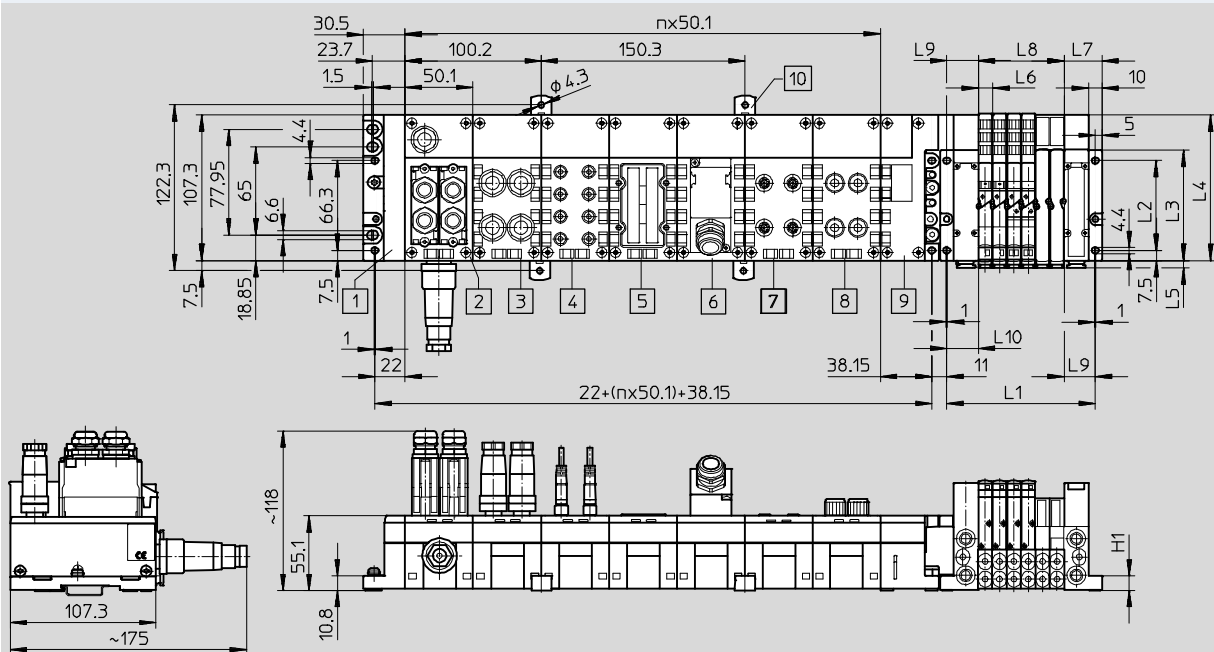

- | | | | |
|---|---|---|--|
| 1 Left-hand end plate | 6 Connection block CPX-AB-1-SUB-BU-25POL | 9 Pneumatic interface CPA | n Number of bus nodes and connection blocks for CPX |
| 2 Bus nodes | 7 Connection block CPX-AB-4-HAR-4POL | 10 Mounting clip for wall mounting (required every 2 ... 3 connection blocks) | |
| 3 Connection block CPX-AB-4-M12-8POL | 8 Connection block CPX-AB-4-M12x2-5POL | | |
| 4 Connection block CPX-AB-8-M8-3POL | | | |
| 5 Connection block CPX-AB-8-KL-4POL | | | |

| Type | L1 ¹⁾ | L2 ±0.1 | L3 | L4 | L5 | L6 | L7 | L8 ¹⁾ | L9 ±0.1 | H1 |
|-------|------------------|------------|------|-------|-----|------|----|------------------|------------|----|
| CPA14 | 51 + (m x 14.6) | 76.1 | 91.1 | 118.1 | 6.5 | 14.6 | 31 | m x 14.6 | 26 | 13 |

1) m = Number of valves

Terminal CPX

Technical data

FESTO

Dimensions

Download CAD data → www.festo.com

With bus nodes and valve terminal MPA-S

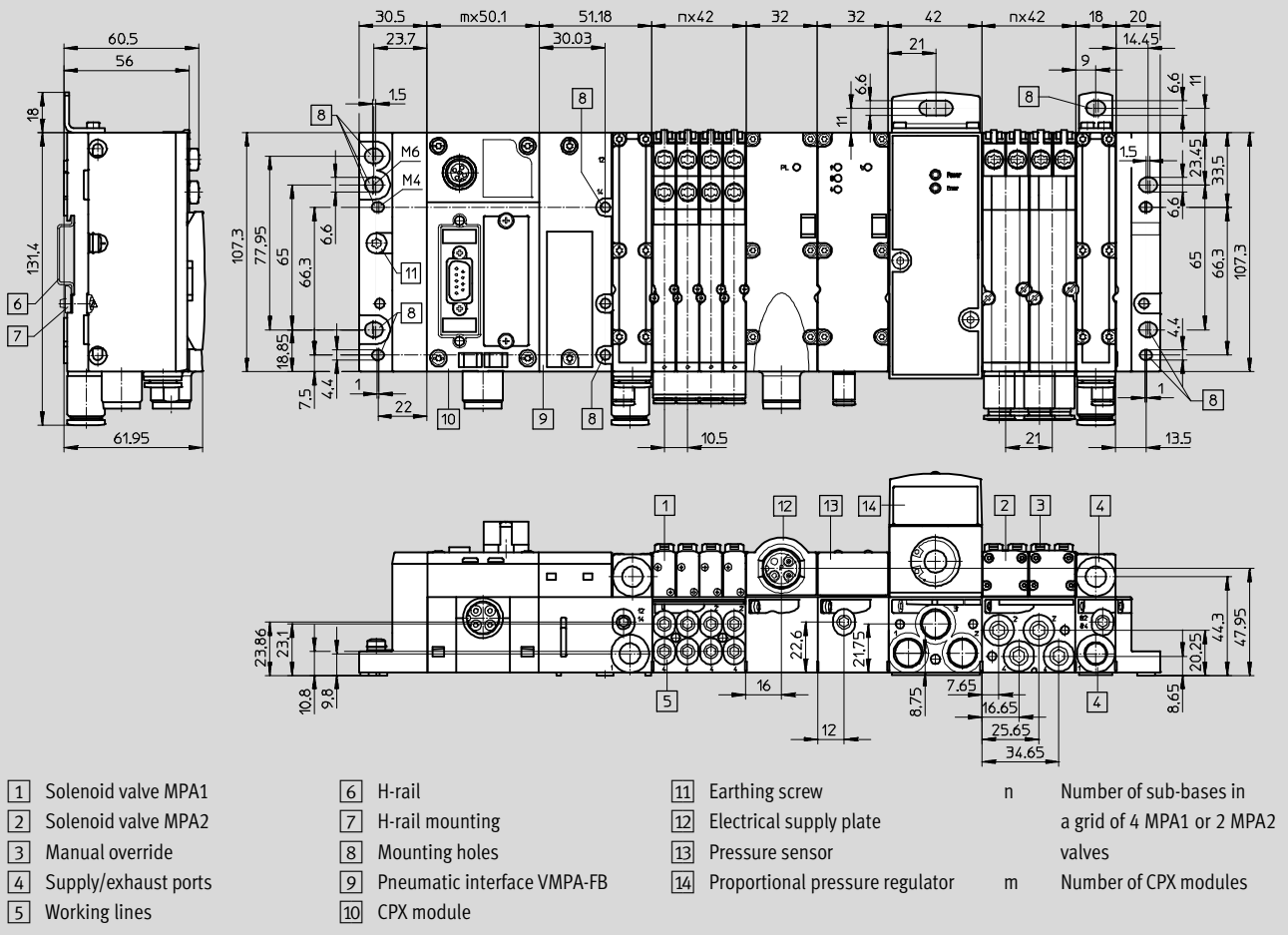

Terminal CPX

Technical data

Dimensions

Download CAD data → www.festo.com

With bus node and valve terminal MPA-L

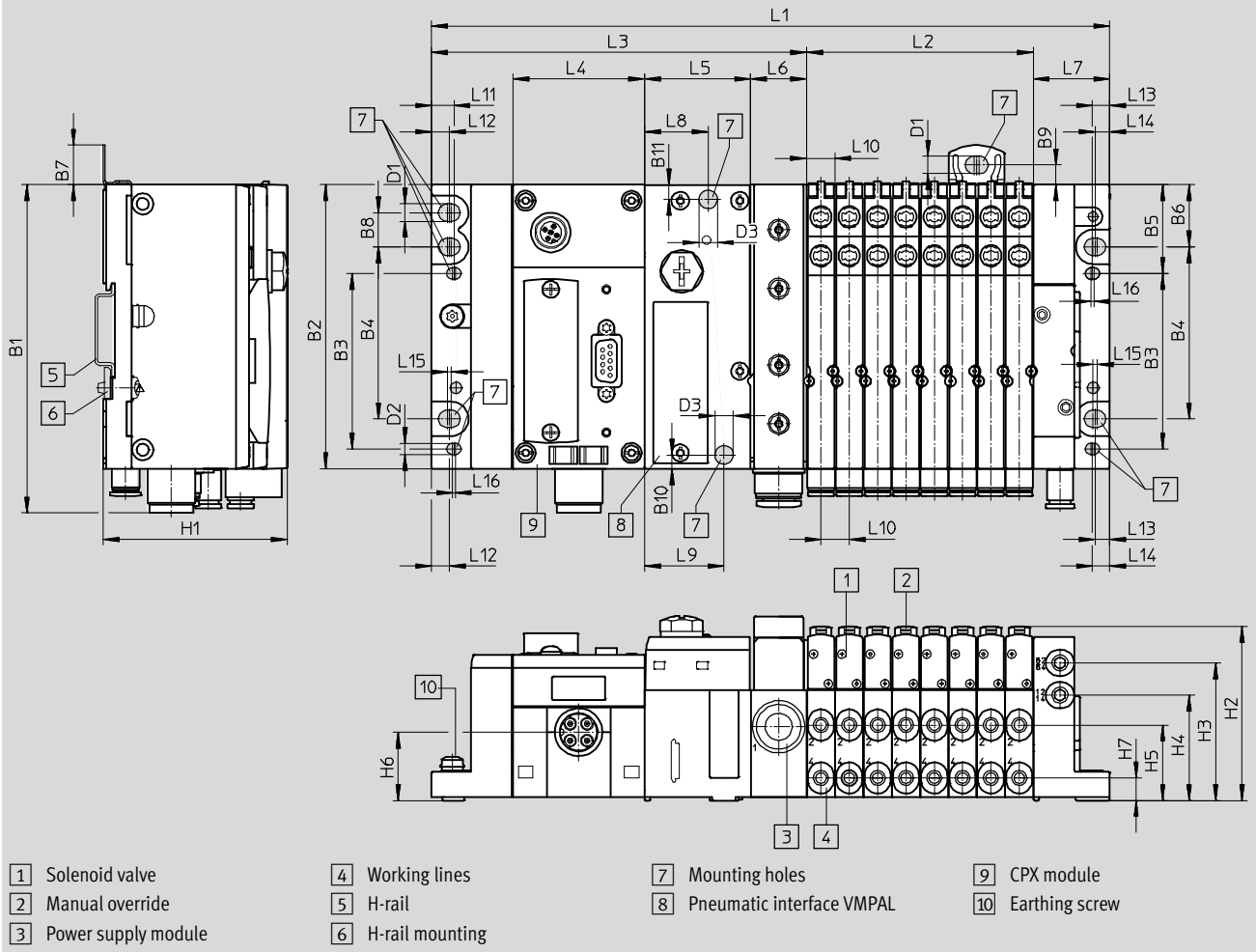

| Type | L1 ¹⁾ | L2 ¹⁾ | L3 | L4 | L5 | L6 | L7 | L8 | L9 | L10 | L11 | L12 | L13 | L14 | D1 | D2 | D3 |
|-------|-------------------|------------------|-------|----|------|------|------|----|----|------|-----|-----|-----|-----|-----|-----|----|
| MPA-L | 170.9 + n x 10.70 | n x 10.70 | 142.1 | 50 | 40.1 | 21.2 | 28.8 | 24 | 30 | 10.7 | 8.5 | 6.8 | 5.6 | 6.5 | 6.6 | 4.4 | 7 |

| Type | B1 | B2 | B3 | B4 | B5 | B6 | B7 | B8 | B9 | B10 | B11 | H1 | H2 | H3 | H4 | H5 | H6 | H7 |
|-------|-----|-------|------|----|------|------|----|----|-----|-----|-----|------|------|----|------|------|------|-----|
| MPA-L | 124 | 107.3 | 66.3 | 65 | 33.5 | 23.5 | 15 | 13 | 7.5 | 5.3 | 5.5 | 69.6 | 65.7 | 52 | 39.8 | 28.5 | 25.8 | 8.5 |

1) n = Number of sub-bases/valve positions

-  - Type discontinued
Available up until 2019

Terminal CPX

Technical data

FESTO

Dimensions

Download CAD data → www.festo.com



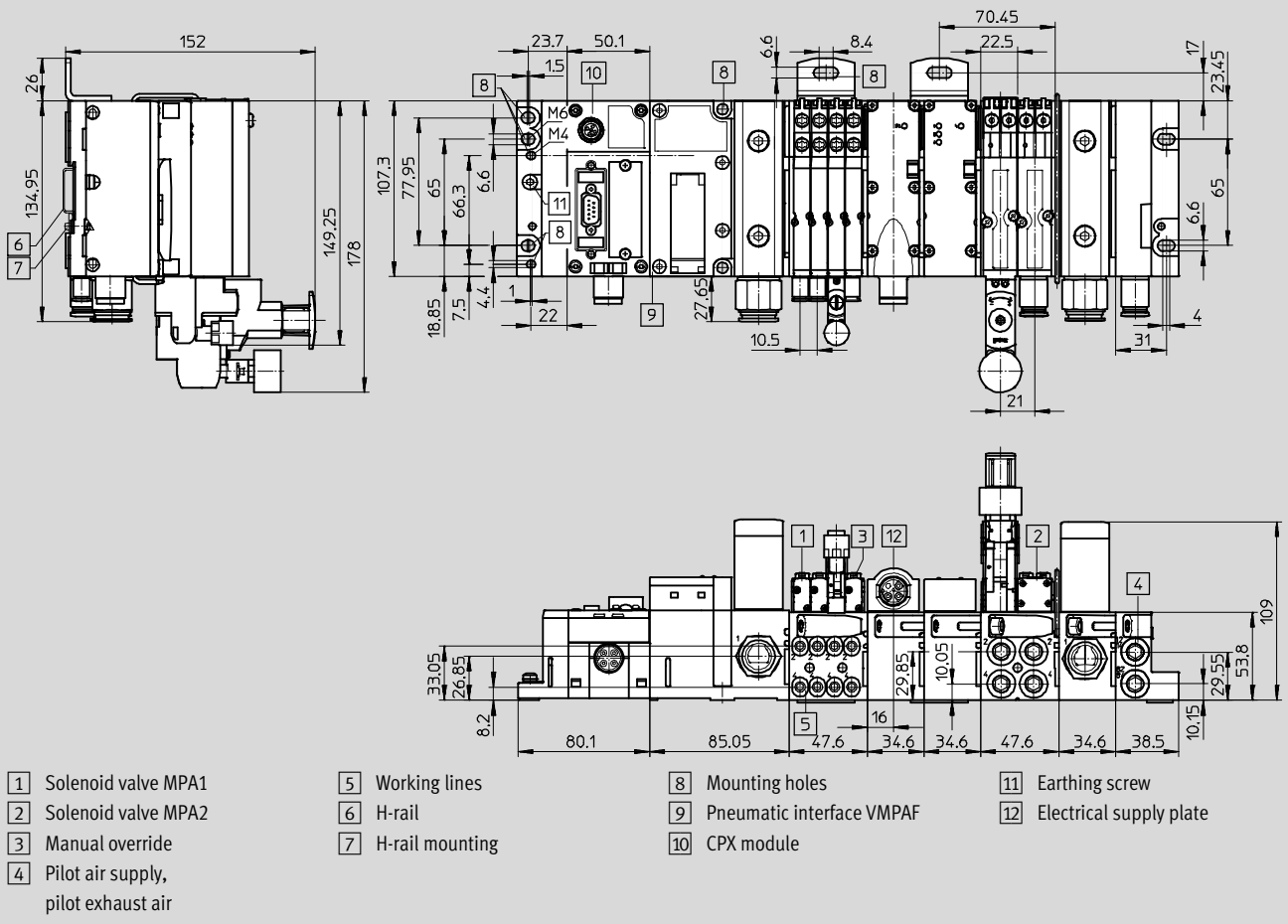





With bus nodes and valve terminal MPA-F

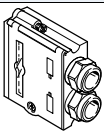

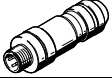
Terminal CPX

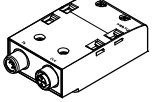
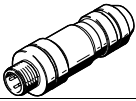
Accessories



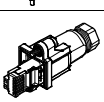
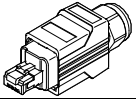
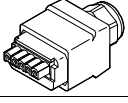
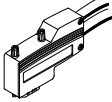
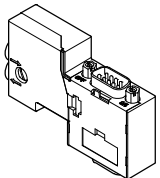

FESTO

| Ordering data – Accessories | | | | |
|---|--|-----------------|-----------------|-----------------------|
| Designation | | | Part No. | Type |
| Plug connectors and accessories | | | | |
|  | Sub-D plug for INTERBUS | Incoming | 532218 | FBS-SUB-9-BU-IB-B |
| | | Outgoing | 532217 | FBS-SUB-9-GS-IB-B |
| | Sub-D plug for DeviceNet/CANopen | | 532219 | FBS-SUB-9-BU-2x5POL-B |
| | Sub-D plug for PROFIBUS DP | | 532216 | FBS-SUB-9-GS-DP-B |
| | Sub-D plug for CC-Link | | 532220 | FBS-SUB-9-GS-2x4POL-B |
|  | Sub-D plug | | 534497 | FBS-SUB-9-GS-1x9POL-B |
| | Bus connection M12 adapter (B-coded) for PROFIBUS DP | | 533118 | FBA-2-M12-5POL-RK |
|  | Micro Style bus connection, 2xM12 for DeviceNet/CANopen | | 525632 | FBA-2-M12-5POL |
| | For Micro Style connection, M12 | Socket | 18324 | FBSD-GD-9-5POL |
| Plug | | 175380 | FBS-M12-5GS-PG9 | |
|  | M12x1 bus connection, 4-pin (D-coded) for Ethernet | | 543109 | NECU-M-S-D12G4-C2-ET |
|  | Connection block, Sub-D socket, 9-pin, plug 7/8", 5-pin for DeviceNet | | 571052 | CPX-AB-1-7/8-DN |
|  | Connection block M12 adapter (B-coded) | For PROFIBUS DP | 541519 | CPX-AB-2-M12-RK-DP |
| | | For INTERBUS | 534505 | CPX-AB-2-M12-RK-IB |
|  | For self-assembly of a connecting cable for FBA-2-M12-5POL-RK and CPX-AB-2-M12-RK-DP, M12x1, 5-pin, straight | Socket | 1067905 | NECU-M-B12G5-C2-PB |
| | | Plug | 1066354 | NECU-M-S-B12G5-C2-PB |
|  | Open Style bus connection for 5-pin terminal strip for DeviceNet/CANopen | | 525634 | FBA-1-SL-5POL |
|  | Terminal strip for Open Style connection, 5-pin | | 525635 | FBSD-KL-2x5POL |
|  | Screw terminal bus connection for CC-Link | | 197962 | FBA-1-KL-5POL |
|  | RJ45/plug | | 534494 | FBS-RJ45-8-GS |
|  | RJ45 plug, 8-pin, push-pull | | 552000 | FBS-RJ45-PP-GS |
| | SCRJ plug, 2-pin, push-pull, for CPX-M-FB35 | | 571017 | FBS-SCRJ-PP-GS |
|  | Socket/spring-loaded terminal, 5-pin, AIDA push-pull | | 563059 | NECU-M-PPG5-C1 |
|  | Plug for CAN-Bus interface, Sub-D, 9-pin, without terminating resistor | | 533783 | FBS-SUB-9-WS-CO-K |
|  | Sub-D socket with terminating resistor and programming interface | | 574588 | NECU-S1W9-C2-ACO |
| | Sub-D straight plug connector with terminating resistor and programming interface | | 574589 | NECU-S1W9-C2-APB |

Terminal CPX

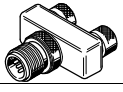
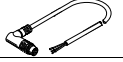
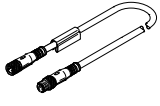
Accessories



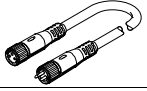
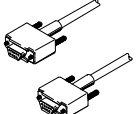
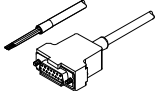
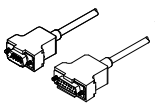

FESTO

| Ordering data – Accessories | | | | |
|---|---|---|--|---|
| Designation | | Part No. | Type | |
| Connecting cables | | | | |
|  | DUO cable M12-2xM8, 4-pin/2x3-pin | 2x straight socket | 18685 KM12-DUO-M8-GDGD | |
| | | 1x straight socket 1x angled socket | 18688 KM12-DUO-M8-GDWD | |
| | | 2x angled socket | 18687 KM12-DUO-M8-WDWD | |
| | | DUO cable M8-2xM8, 4-pin/2x3-pin | 2x straight socket | 574591 NEDU-L2R1-M8G3-K-1L1-1L2-M8G4 |
|  | Push-in T-connector | 1x plug M8, 4-pin | 2x socket M8, 3-pin | 544391 NEDU-M8D3-M8T4 |
| | | 1x plug M12, 4-pin | 2x socket M8, 3-pin | 541597 NEDU-M8D3-M12T4 |
| | | | 2x socket M12, 5-pin | 541596 NEDU-M12D5-M12T4 |
|  | Connecting cable M9, 5-pin, angled plug-open cable end 3-pin | 2 m | 563711 NEBC-M9W5-K-2-N-LE3 | |
| | | 5 m | 563712 NEBC-M9W5-K-5-N-LE3 | |
|  | Connecting cable M8-M8, straight plug-straight socket | 0.5 m | 175488 KM8-M8-GSGD-0,5 | |
| | | 1.0 m | 175489 KM8-M8-GSGD-1 | |
| | | 2.5 m | 165610 KM8-M8-GSGD-2,5 | |
| | | 5.0 m | 165611 KM8-M8-GSGD-5 | |
| | Connecting cable M12-M12, 4-pin, straight plug-straight socket | 2.5 m | 18684 KM12-M12-GSGD-2,5 | |
| | | 5.0 m | 18686 KM12-M12-GSGD-5 | |
| | Connecting cable M12-M12, 5-pin, straight plug-straight socket | 1.5 m | 529044 KV-M12-M12-1,5 | |
| | | 3.5 m | 530901 KV-M12-M12-3,5 | |
| | Connecting cable for CPX-CTEL, M12-M12, 5-pin, straight plug-straight socket | 5 m | 574321 NEBU-M12G5-E-5-Q8N-M12G5 | |
| | | 7.5 m | 574322 NEBU-M12G5-E-7.5-Q8N-M12G5 | |
| 10 m | | 574323 NEBU-M12G5-E-10-Q8N-M12G5 | | |
| Connecting cable M12-M12, 8-pin, straight plug-straight socket | 2.0 m | 525617 KM12-8GD8GS-2-PU | | |
|  | Connecting cable M12-M12, 4-pin, straight plug-angled socket | 1.0 m | 185499 KM12-M12-GSWD-1-4 | |
| | | | | |
|  | Connecting cable M9, angled plug-angled socket | 0.25 m | 540327 KVI-CP-3-WS-WD-0,25 | |
| | | 0.5 m | 540328 KVI-CP-3-WS-WD-0,5 | |
| | | 2 m | 540329 KVI-CP-3-WS-WD-2 | |
| | | 5 m | 540330 KVI-CP-3-WS-WD-5 | |
| | | 8 m | 540331 KVI-CP-3-WS-WD-8 | |
|  | Connecting cable M9, straight plug-straight socket | 2 m | 540332 KVI-CP-3-GS-GD-2 | |
| | | 5 m | 540333 KVI-CP-3-GS-GD-5 | |
| | | 8 m | 540334 KVI-CP-3-GS-GD-8 | |
|  | Modular system for connecting cables | - | NEBU-... → Internet: nebu | |
|  | Programming cable | 151915 | KDI-PPA-3-BU9 | |
|  | Connecting cable FED (for CPX-CEC) | 539642 | FEC-KBG7 | |
|  | Connecting cable FED (for CPX-CEC) | 539643 | FEC-KBG8 | |

Terminal CPX

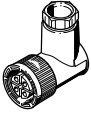
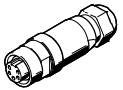
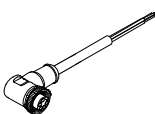
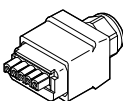
Accessories

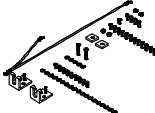
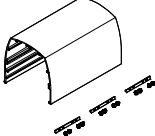



FESTO

| Ordering data – Accessories | | | | | |
|---|---|---|-----------------------------------|----------------------|------------------|
| Designation | | | Part No. | Type | |
| Plug connectors and accessories – Power supply | | | | | |
|  | Plug socket for mains connection M18, straight | For 1.5 mm ² | 18493 | NTSD-GD-9 | |
| | | For 2.5 mm ² | 18526 | NTSD-GD-13.5 | |
| | Plug socket for mains connection M18, angled | For 1.5 mm ² | 18527 | NTSD-WD-9 | |
| | | For 2.5 mm ² | 533119 | NTSD-WD-11 | |
|  | Power supply socket | 7/8" connection, 5-pin | 543107 | NECU-G78G5-C2 | |
| | | 7/8" connection, 4-pin | 543108 | NECU-G78G4-C2 | |
|  | Angled socket, 5-pin – Open cable end, 5-wire | 2 m | 573855 | NEBU-G78W5-K-2-N-LE5 | |
|  | Connection socket AIDA push-pull, spring-loaded terminal | 5-pin | 563059 | NECU-M-PPG5-C1 | |
|  | Straight plug, spring-loaded terminal, for end plate left-hand with system supply | 7-pin | 576319 | NECU-L3G7-C1 | |
| Hood | | | | | |
|  | Mounting rail for securing the cover | 1,000 mm | 572256 | CAFC-X1-S | |
|  | Mounting kit for CPX cover | | 572257 | CAFC-X1-BE | |
|  | Hood section for CPX terminal including mounting attachments for connecting several hood sections in series | 200 mm | 572258 | CAFC-X1-GAL-200 | |
| | | 300 mm | 572259 | CAFC-X1-GAL-300 | |
| Screws | | | | | |
|  | Screws for mounting the bus node/connection block on a plastic interlinking block | Bus node/metal connection block | 550218 | CPX-DPT-30X32-S-4X | |
| | | Screws for mounting the bus node/connection block on a metal interlinking block | Bus node/plastic connection block | 550219 | CPX-M-M3x22-4x |
| | | | Bus node/metal connection block | 550216 | CPX-M-M3x22-S-4x |
|  | Screws for attaching an inscription label holder to the bus node (CPX-FB33, CPX-M-FB34, CPX-M-FB35) | 12 pieces | 550222 | CPX-M-M2,5X8-12X | |

Terminal CPX

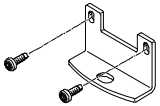
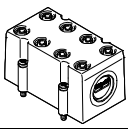
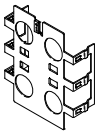
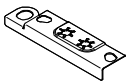
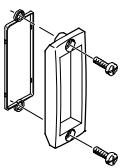
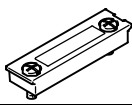
Accessories

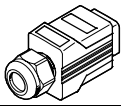

FESTO

| Ordering data – Accessories | | | |
|---|--|---------------------------------------|--------------------------------|
| Designation | | Part No. | Type |
| Mounting | | | |
|  | Attachment for wall mounting (for long valve terminals, 10 pieces) | Design for plastic manifold sub-bases | 529040 CPX-BG-RW-10x |
|  | Attachment for wall mounting, design for metal manifold sub-bases | 2 mounting brackets and 4 screws | 550217 CPX-M-BG-RW-2X |
| | | 1 mounting bracket and 2 screws | 2721419 CPX-M-BG-VT-2X |
| Covers and attachments | | | |
|  | Cover for CPX-AB-8-KL-4POL (IP65, IP67) – 8 cable through-feeds M9 – 1 cable through-feed for multi-pin plug | | 538219 AK-8KL |
| | Fittings kit | | 538220 VG-K-M9 |
|  | Screening plate for M12 connections | | 526184 CPX-AB-S-4-M12 |
|  | Earthing component (5 pieces), for right-hand/left-hand plastic end plate (interlinking blocks made from polymer material) | | 538892 CPX-EPFE-EV |
|  | Inspection cover, transparent | | 533334 AK-SUB-9/15-B |
|  | Transparent cover for DIL switch and memory card | | 548757 CPX-AK-P |
| | Cover for DIL switch and memory card | | 548754 CPX-M-AK-M |
|  | Blanking plate for covering the DIL switches of CPX-M-FB20/CPX-M-FB21 | | 572818 CPX-M-FB21-IB-RL |
|  | Cover for RJ45 connection | | 534496 AK-Rj45 |
|  | Cover for RJ45 push-pull connection | | 548753 CPX-M-AK-C |
|  | Cover cap for bus connection | | 2873540 CPX-M-AK-D |
|  | Cover cap for sealing unused connections (10 pieces) | For M8 connections | 177672 ISK-M8 |
| | | For M12 connections | 165592 ISK-M12 |

Terminal CPX

Accessories

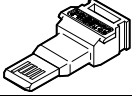
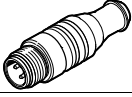
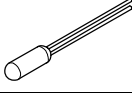
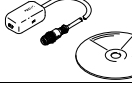
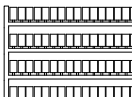
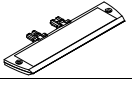
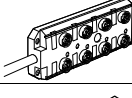
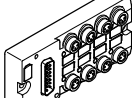
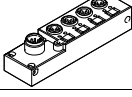
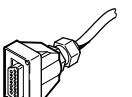
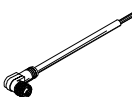
FESTO

| Ordering data – Accessories | | | |
|---|--|----------------------|------------------------------|
| Designation | | Part No. | Type |
| Functional modules | | | |
|  | Memory card for PROFINET bus node (CPX-FB33, CPX-M-FB34, CPX-M-FB35), 2 MB | 568647 | CPX-SK-2 |
|  | Terminating resistor, M12, B-coded for PROFIBUS | 1072128 | CACR-S-B12G5-220-PB |
|  | PT1000 temperature sensor for cold junction compensation | 553596 | CPX-W-PT1000 |
|  | Adapter from 5-pin M12 to mini USB socket and controller software | 547432 | NEFC-M12G5-03-U1G5 |
| Inscription labels | | | |
|  | Inscription labels 6x10, 64 pieces, in frames | 18576 | IBS-6x10 |
|  | Inscription label holder for connection block | 536593 | CPX-ST-1 |
| Multi-pin plug distributors | | | |
|  | Open cable end, 11-pin | 8x socket M12, 5-pin | 177671 MPV-E/A08-M12 |
|  | Sub-D plug, 15-pin | 8x socket M8, 3-pin | 177669 MPV-E/A08-M8 |
| | | 12x socket M8, 3-pin | 177670 MPV-E/A12-M8 |
|  | Plug M12, 8-pin | 4x socket M8, 3-pin | 574586 NEDU-L4R1-M8G3L-M12G8 |
| | | 6x socket M8, 3-pin | 574587 NEDU-L6R1-M8G3L-M12G8 |
| Connecting cable for multi-pin plug distributors | | | |
|  | Sub-D socket, 15-pin, open cable end, 15-wire | 5 m | 177673 KMPV-SUB-D-15-5 |
| | | 10 m | 177674 KMPV-SUB-D-15-10 |
|  | Angled socket M12, 8-pin, open cable end, 8-wire | Length 2 m | 542256 NEBU-M12W8-2-N-LE8 |
| | | Length 5 m | 542257 NEBU-M12W8-5-N-LE8 |
| | | Length 10 m | 570007 NEBU-M12W8-10-N-LE8 |
| | Straight socket M12, 8-pin, open cable end, 8-wire | Length 2 m | 525616 SIM-M12-8GD-2-PU |
| | | Length 5 m | 525618 SIM-M12-8GD-5-PU |
| | | Length 10 m | 570008 SIM-M12-8GD-10-PU |
| Software | | | |
|  | Programming software | German | 537927 P.SW-FST4-CD-DE |
| | | English | 537928 P.SW-FST4-CD-EN |

Product Range and Company Overview

A Complete Suite and Company Overview

Our experienced engineers provide complete support at every stage of your development process, including: conceptualization, analysis, engineering, design, assembly, documentation, validation, and production.



Custom Automation Components
Complete custom engineered solutions



Custom Control Cabinets
Comprehensive engineering support and on-site services

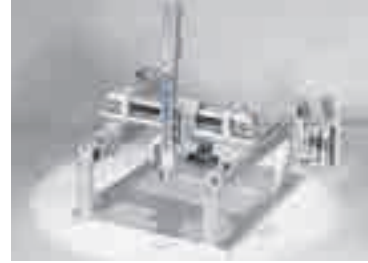

Complete Systems
Shipment, stocking and storage services

The Broadest Range of Automation Components

With a comprehensive line of more than 30,000 automation components, Festo is capable of solving the most complex automation requirements.



Electromechanical
Electromechanical actuators, motors, controllers & drivers



Pneumatics
Pneumatic linear and rotary actuators, valves, and air supply



PLCs and I/O Devices
PLC's, operator interfaces, sensors and I/O devices

Supporting Advanced Automation... As No One Else Can!

Festo is a leading global manufacturer of pneumatic and electromechanical systems, components and controls for industrial automation, with more than 16,000 employees in 60 national headquarters serving more than 180 countries. For more than 80 years, Festo has continuously elevated the state of manufacturing with innovations and optimized motion control solutions that deliver higher performing, more profitable automated manufacturing and processing equipment. Our dedication to the advancement of automation extends beyond technology to the education and development of current and future automation and robotics designers with simulation tools, teaching programs, and on-site services.

Quality Assurance, ISO 9001 and ISO 14001 Certifications

Festo Corporation is committed to supply all Festo products and services that will meet or exceed our customers' requirements in product quality, delivery, customer service and satisfaction.

To meet this commitment, we strive to ensure a consistent, integrated, and systematic approach to management that will meet or exceed the requirements of the ISO 9001 standard for Quality Management and the ISO 14001 standard for Environmental Management.



© Copyright 2013, Festo Corporation. While every effort is made to ensure that all dimensions and specifications are correct, Festo cannot guarantee that publications are completely free of any error, in particular typing or printing errors. Accordingly, Festo cannot be held responsible for the same. For Liability and Warranty conditions, refer to our "Terms and Conditions of Sale", available from your local Festo office. All rights reserved. No part of this publication may be reproduced, distributed, or transmitted in any form or by any means, electronic, mechanical, photocopying or otherwise, without the prior written permission of Festo. All technical data subject to change according to technical update.



Printed on recycled paper at New Horizon Graphic, Inc., FSC certified as an environmental friendly printing plant.

Festo North America

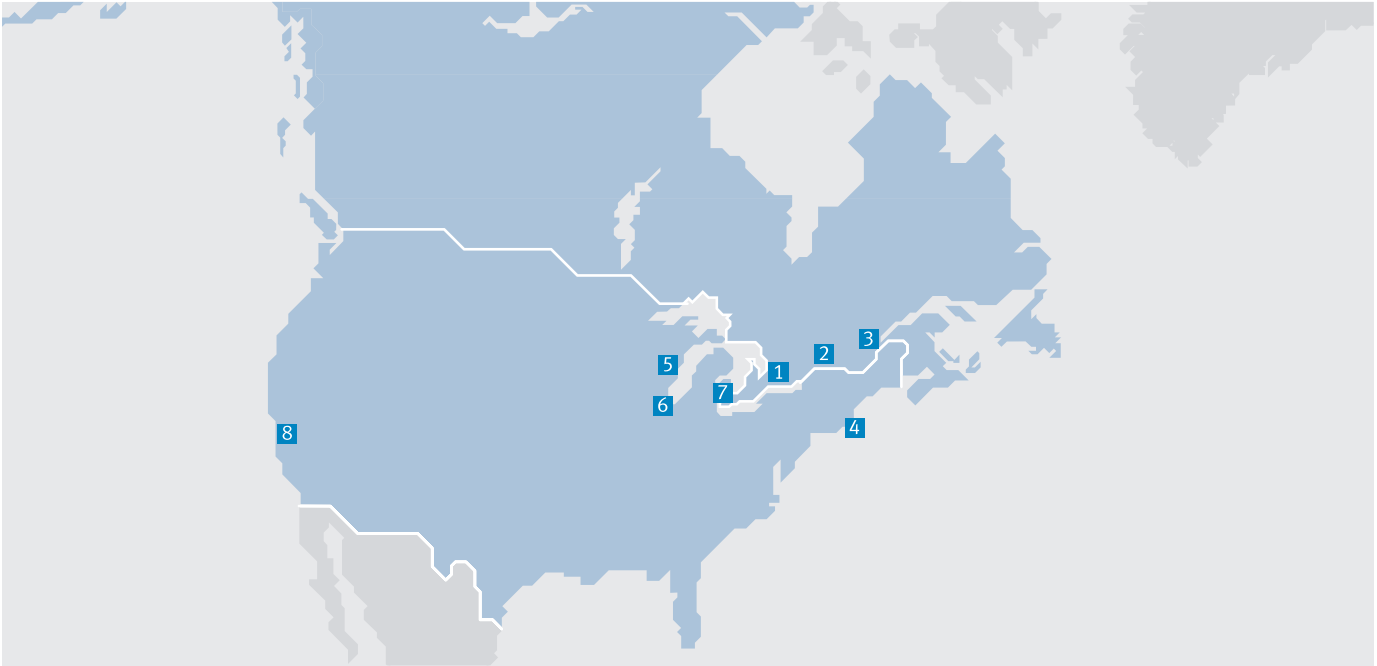

**1 Festo Canada
Headquarters
Festo Inc.**
5300 Explorer Drive
Mississauga, ON
L4W 5G4

2 Montréal
5600, Trans-Canada
Pointe-Claire, QC
H9R 1B6

3 Québec City
2930, rue Watt#117
Québec, QC
G1X 4G3



**4 Festo United States
Headquarters
Festo Corporation**
395 Moreland Road
Hauppauge, NY
11788

5 Appleton
North 922 Tower View Drive, Suite N
Greenville, WI
54942

7 Detroit
1441 West Long Lake Road
Troy, MI
48098

6 Chicago
85 W Algonquin - Suite 340
Arlington Heights, IL
60005

8 Silicon Valley
4935 Southfront Road, Suite F
Livermore, CA
94550

Festo Regional Contact Center

Canadian Customers

Commercial Support:
Tel: 1 877 GO FESTO (1 877 463 3786)
Fax: 1 877 FX FESTO (1 877 393 3786)
Email: festo.canada@ca.festo.com

Technical Support:

Tel: 1 866 GO FESTO (1 866 463 3786)
Fax: 1 877 FX FESTO (1 877 393 3786)
Email: technical.support@ca.festo.com

USA Customers

Commercial Support:
Tel: 1 800 99 FESTO (1 800 993 3786)
Fax: 1 800 96 FESTO (1 800 963 3786)
Email: customer.service@us.festo.com

Technical Support:

Tel: 1 866 GO FESTO (1 866 463 3786)
Fax: 1 800 96 FESTO (1 800 963 3786)
Email: product.support@us.festo.com