

Universal valves CPE

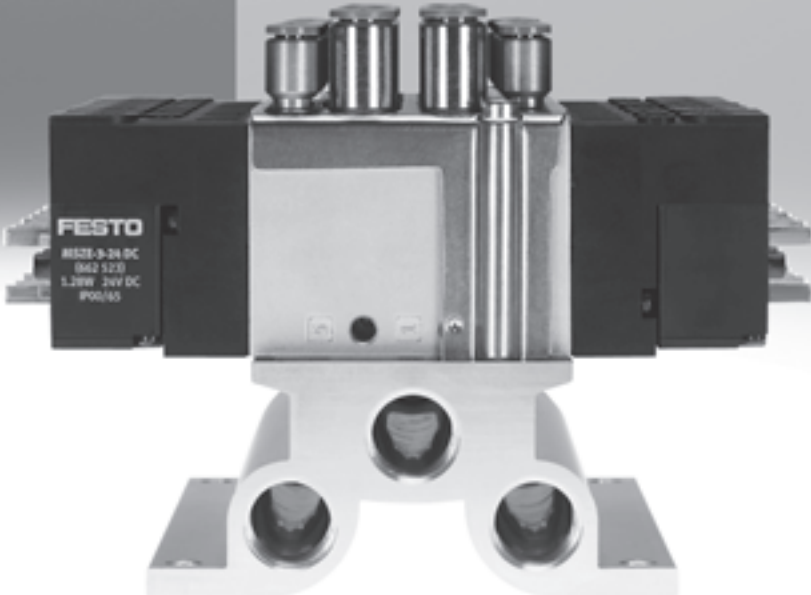

Solenoid valves CPE, Compact Performance

Key features

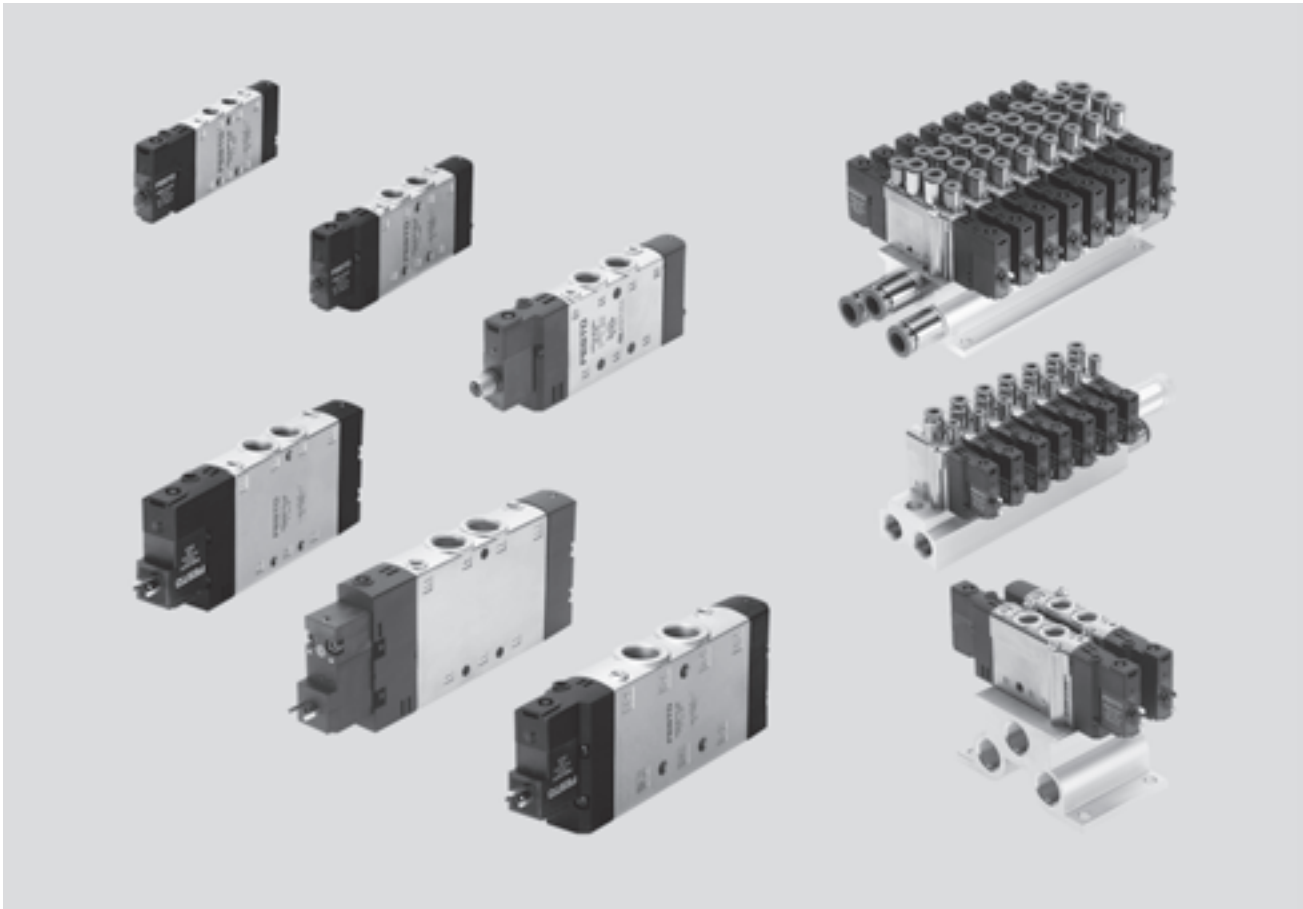

Variants

Functions (selection)

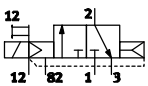

3/2-way valve with external pilot air supply, normally closed

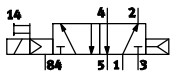

5/2-way single solenoid valve with internal pilot air supply

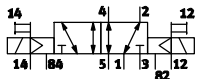

5/2-way double solenoid valve with external pilot air supply

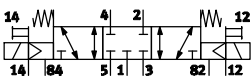

5/3-way valve with external pilot air supply, normally closed

Parameters

- - Width
10 mm
14 mm
18 mm
24 mm

- - Flow rate
180 ... 3,200 l/min

- - Note

The 5/3-way solenoid valve remains in the previous switching position if both solenoid coils are energised simultaneously.

The valve moves to its mid-position by means of spring force if neither solenoid coil is energised.

Advantages

Performance optimised sizes:
The solenoid valves CPE, Compact Performance are distinguished by their minimal width and low power consumption at high flow rates.

Can be mounted right in the "front line":

- On cylinders
- On moving system components
- Flexible installation through individual mounting

Short tubing lengths requiring minimal air volume:

- Short switching times
- Short response times

Optimised installations:

- Shorter machine cycles
- Larger quantities
- Lower power consumption

Convenient manual override.

CPE10, CPE14 and CPE18:
Simple manifold structure consisting of fixed-grid manifold blocks made from stable aluminium with 2 to 10 valve positions or modular manifold blocks made from durable plastic.

The sockets KMYZ-9 for sizes CPE10 and CPE14 feature integrated current reduction.

All CPE valves therefore have a duty cycle of 100%.

Solenoid valves CPE, Compact Performance

Key features

Solenoid valves with square plug

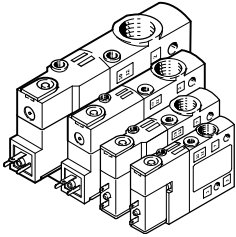

- Widths 10 mm, 14 mm, 18 mm and 24 mm
- 3/2, 5/2 and 5/3-way valves
- Internal or external pilot air supply available
- 24 V DC for all widths
- 110 or 220 V AC for widths 18 and 24
- Manual override, non-detenting and detenting using tool
- Width 10 mm available with M5 insert
- All widths available with QS fittings in 2 sizes

Solenoid valves with round plug

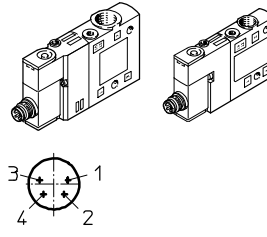

- Widths 10 mm and 14 mm
- 3/2, 5/2 and 5/3-way valves
- Internal or external pilot air supply available
- 24 V DC
- Manual override, non-detenting and detenting via tool
- Round plug, M8x1, 4-pin

CPE18 basic valves with interface to ISO 15218

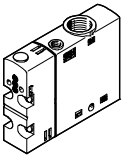

- Width 18 mm
- 3/2, 5/2 and 5/3-way valves
- Internal or external pilot air supply available

Pilot valve with interface to ISO 15218

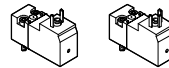

- For 12, 24 V DC and 24 V AC without protective earth conductor
- For 110 and 220 V AC with protective earth conductor
- 3/2-way valve
- Manual override, non-detenting

Adapter VAVE



- Compatible with ZC solenoid coils for CPE10/CPE14

Combination of basic valve CPE18 with pilot valve

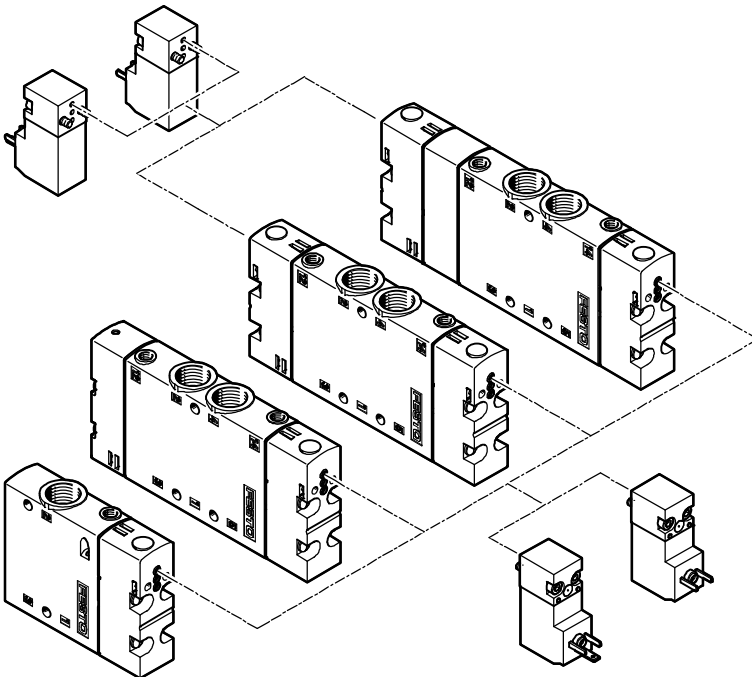

Solenoid valves CPE, Compact Performance

Key features

FESTO

Manifold block for fixed-grid manifold

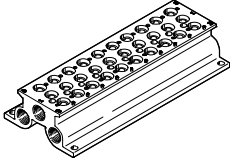

- For valve widths 10, 14 and 18 mm
- For 5/2 and 5/3-way valves
- 2 to 10 valve positions

Manifold block for fixed-grid manifold

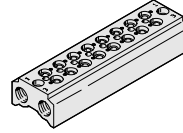

- For valve widths 10, 14 and 18 mm
- For 3/2-way valves
- 2 to 10 valve positions

Retainer set

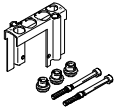

- Retainer for 5/2 or 5/3-way valve

Retainer set

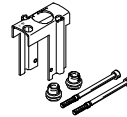

- Retainer for 3/2-way valve

Blanking plate for vacant positions



- Vacant position cover for 5/2 or 5/3-way valve

Blanking plate for vacant positions



- Vacant position cover for 3/2-way valve

Manifold block with air supply

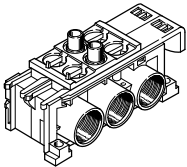

- 2 valve positions
- For CPE10, CPE14 or CPE18
- For 5/2 and 5/3-way valves
- Ducts 1, 3 and 5 can have closed or open ends
- Ducts closed when the manifold is full or when pressure zones are being used

Manifold block for expansion

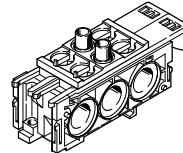

- 2 valve positions
- For CPE10, CPE14 or CPE18
- For 5/2 and 5/3-way valves
- Ducts 1, 3 and 5 can have closed or open ends

Manifold block with air supply

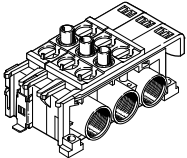

- 3 valve positions
- For CPE10, CPE14 or CPE18
- For 5/2 and 5/3-way valves
- Ducts 1, 3 and 5 can have closed or open ends
- Ducts closed when the manifold is full or when pressure zones are being used

End plate for additional air supply

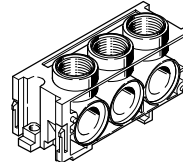

- For CPE10, CPE14 or CPE18
- Required for manifolds with more than 6 valves or separate pressure zones
- Ports 1, 3 and 5 at rear and on top

Blanking plate for vacant positions

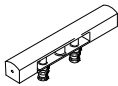

- Versions
- Vacant position cover for 5/2 or 5/3-way valve

Modular manifold with blanking plate

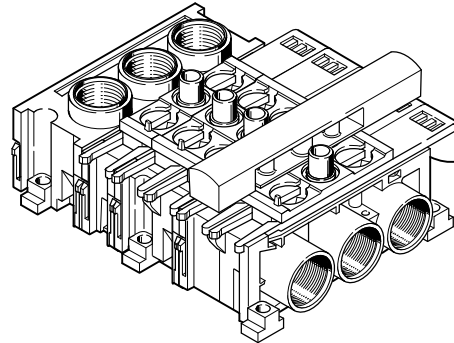

Solenoid valves CPE, Compact Performance

Key features

FESTO

Mounting on fixed-grid manifold block for CPE10, CPE14 and CPE18

- Simple structure comprising compact valve manifolds with in-line valves
- Mounting with stable retainer and special moulded seal guarantee leak-free assembly
- 2 to 10 valve positions
- Aluminium mounting rail provides high stability
- High flow rates with air supply on both sides for duct 1
- High exhaust capacity with output on both sides for ducts 3 and 5
- Different pressure and exhaust zones can be created using separators, which are clamped at the separation points in ducts 1, 3 and 5

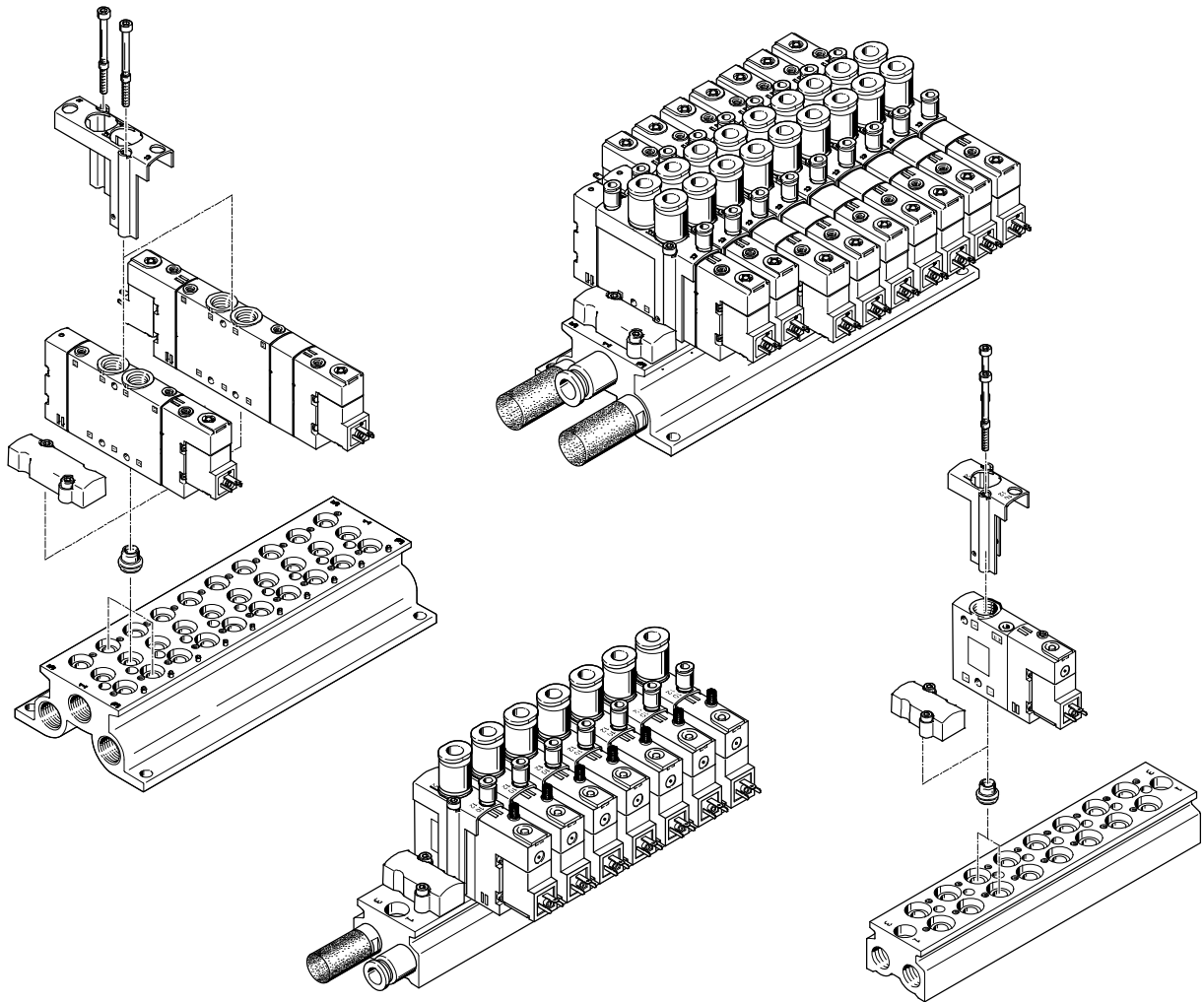

Solenoid valves CPE, Compact Performance

Key features

FESTO

Manifold assembly for CPE10, CPE14 and CPE18 with modular manifold blocks

- Construction of a valve manifold with modular manifold blocks made from high impact, glass fibre reinforced polyamide
- Different pressure zones can be created using basic and expansion blocks with closed supply and exhaust ducts
- Air supply and exhaust can be connected on both sides using an additional end block
- Air supply and exhaust can be connected at the end block, at the rear and at the top
- No screws required for mounting thanks to slides and clips

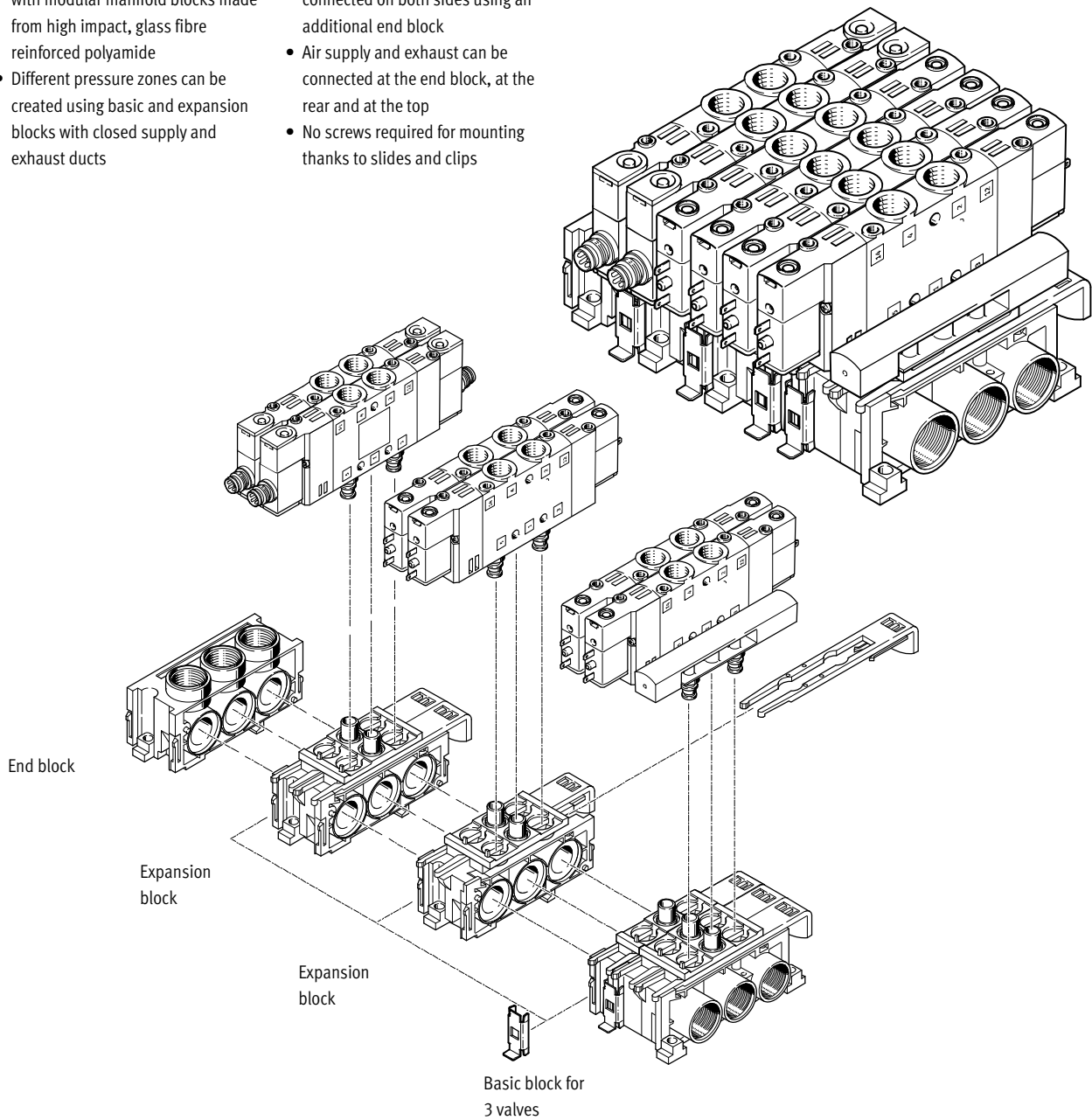

Solenoid valves CPE, Compact Performance

Product range overview – Widths 10 mm and 14 mm

Width	Circuit symbol	Type	Connector plug		Operating voltage		Working port												→ Page/ Internet
			Square	Round	[V DC]	[V AC]	M			G			QS						
							5	7	1/8	1/4	3/8	4	6	8	10	12			
10 mm		3/2-way single solenoid valve, normally closed																	
		CPE10-M1BH-3GL...	■	-	24	-	■	■	-	-	-	■	■	-	-	-	24		
	CPE10-M1CH-3GL...	-	■	24	-	-	■	-	-	-	-	-	-	-	-	-			
		3/2-way single solenoid valve, normally open																	
		CPE10-M1BH-3OL...	■	-	24	-	■	■	-	-	-	■	■	-	-	-	24		
	CPE10-M1CH-3OL...	-	■	24	-	-	■	-	-	-	-	-	-	-	-	-			
		5/2-way single solenoid valve																	
		CPE10-M1BH-5L...	■	-	24	-	■	■	-	-	-	■	■	-	-	-	24		
	CPE10-M1CH-5L...	-	■	24	-	-	■	-	-	-	-	-	-	-	-	-			
		5/2-way double solenoid valve																	
		CPE10-M1BH-5J...	■	-	24	-	■	■	-	-	-	■	■	-	-	-	24		
	CPE10-M1CH-5J...	-	■	24	-	-	■	-	-	-	-	-	-	-	-	-			
		5/3-way single solenoid valve, normally closed, mid-position valve																	
		CPE10-M1BH-5/3G...	■	-	24	-	■	■	-	-	-	■	■	-	-	-	25		
	CPE10-M1CH-5/3G...	-	■	24	-	-	■	-	-	-	-	-	-	-	-	-			
		5/3-way single solenoid valve, normally open, mid-position valve																	
		CPE10-M1BH-5/3B...	■	-	24	-	■	■	-	-	-	■	■	-	-	-	25		
	CPE10-M1CH-5/3B...	-	■	24	-	-	■	-	-	-	-	-	-	-	-	-			
	5/3-way single solenoid valve, normally exhausted, mid-position valve																		
	CPE10-M1BH-5/3E...	■	-	24	-	■	■	-	-	-	■	■	-	-	-	25			
CPE10-M1CH-5/3E...	-	■	24	-	-	■	-	-	-	-	-	-	-	-	-				
14 mm		3/2-way single solenoid valve, normally closed																	
		CPE14-M1BH-3GL...	■	-	24	-	-	-	■	-	-	-	■	■	-	-	41		
	CPE14-M1CH-3GL...	-	■	24	-	-	-	■	-	-	-	-	-	-	-	-			
		3/2-way single solenoid valve, normally open																	
		CPE14-M1BH-3OL...	■	-	24	-	-	-	■	-	-	-	■	■	-	-	41		
	CPE14-M1CH-3OL...	-	■	24	-	-	-	■	-	-	-	-	-	-	-	-			
		5/2-way single solenoid valve																	
		CPE14-M1BH-5L...	■	-	24	-	-	-	■	-	-	-	■	■	-	-	41		
	CPE14-M1CH-5L...	-	■	24	-	-	-	■	-	-	-	-	-	-	-	-			
		5/2-way double solenoid valve																	
		CPE14-M1BH-5J...	■	-	24	-	-	-	■	-	-	-	■	■	-	-	41		
	CPE14-M1CH-5J...	-	■	24	-	-	-	■	-	-	-	-	-	-	-	-			
		5/3-way single solenoid valve, normally closed, mid-position valve																	
		CPE14-M1BH-5/3G...	■	-	24	-	-	-	■	-	-	-	■	■	-	-	42		
	CPE14-M1CH-5/3G...	-	■	24	-	-	-	■	-	-	-	-	-	-	-	-			
		5/3-way single solenoid valve, normally open, mid-position valve																	
		CPE14-M1BH-5/3B...	■	-	24	-	-	-	■	-	-	-	■	■	-	-	42		
	CPE14-M1CH-5/3B...	-	■	24	-	-	-	■	-	-	-	-	-	-	-	-			
	5/3-way single solenoid valve, normally exhausted, mid-position valve																		
	CPE14-M1BH-5/3E...	■	-	24	-	-	-	■	-	-	-	■	■	-	-	42			
CPE14-M1CH-5/3E...	-	■	24	-	-	-	■	-	-	-	-	-	-	-	-				

Solenoid valves CPE, Compact Performance

Product range overview – Width 18 mm

Width	Circuit symbol	Type	Operating voltage		Working port										→ Page/ Internet	
			[V DC]	[V AC]	M		G			QS						
					5	7	1/8	1/4	3/8	4	6	8	10	12		
18 mm		3/2-way single solenoid valve, normally closed														
		CPE18-M1H-3GL...	24	–	–	–	–	■	–	–	–	–	■	■	–	56
		CPE18-M2H-3GL...	–	110	–	–	–	■	–	–	–	–	■	■	–	
		CPE18-M3H-3GL...	–	220	–	–	–	■	–	–	–	–	■	■	–	
	CPE18-P1-3GL...1/4	χ ¹⁾	Υ ²⁾	–	–	–	■	–	–	–	–	–	–	–	63	
		3/2-way single solenoid valve, normally open														
		CPE18-M1H-3OL...	24	–	–	–	–	■	–	–	–	–	■	■	–	56
		CPE18-M2H-3OL...	–	110	–	–	–	■	–	–	–	–	■	■	–	
		CPE18-M3H-3OL...	–	220	–	–	–	■	–	–	–	–	■	■	–	
	CPE18-P1-3OL...1/4	χ ¹⁾	Υ ²⁾	–	–	–	■	–	–	–	–	–	–	–	63	
		5/2-way single solenoid valve														
		CPE18-M1H-5L...	24	–	–	–	–	■	–	–	–	–	■	■	–	57
		CPE18-M2H-5L...	–	110	–	–	–	■	–	–	–	–	■	■	–	
		CPE18-M3H-5L...	–	220	–	–	–	■	–	–	–	–	■	■	–	
	CPE18-P1-5L...1/4	χ ¹⁾	Υ ²⁾	–	–	–	■	–	–	–	–	–	–	–	63	
		5/2-way double solenoid valve														
		CPE18-M1H-5J...	24	–	–	–	–	■	–	–	–	–	■	■	–	57
		CPE18-M2H-5J...	–	110	–	–	–	■	–	–	–	–	■	■	–	
		CPE18-M3H-5J...	–	220	–	–	–	■	–	–	–	–	■	■	–	
	CPE18-P1-5J...1/4	χ ¹⁾	Υ ²⁾	–	–	–	■	–	–	–	–	–	–	–	63	
		5/3-way single solenoid valve, normally closed, mid-position valve														
		CPE18-M1H-5/3G...	24	–	–	–	–	■	–	–	–	–	■	■	–	58
		CPE18-M2H-5/3G...	–	110	–	–	–	■	–	–	–	–	■	■	–	
		CPE18-M3H-5/3G...	–	220	–	–	–	■	–	–	–	–	■	■	–	
	CPE18-P1-5/3G...1/4	χ ¹⁾	Υ ²⁾	–	–	–	■	–	–	–	–	–	–	–	63	
		5/3-way single solenoid valve, normally open, mid-position valve														
		CPE18-M1H-5/3B...	24	–	–	–	–	■	–	–	–	–	■	■	–	58
		CPE18-M2H-5/3B...	–	110	–	–	–	■	–	–	–	–	■	■	–	
		CPE18-M3H-5/3B...	–	220	–	–	–	■	–	–	–	–	■	■	–	
	CPE18-P1-5/3B...1/4	χ ¹⁾	Υ ²⁾	–	–	–	■	–	–	–	–	–	–	–	63	
		5/3-way single solenoid valve, normally exhausted, mid-position valve														
		CPE18-M1H-5/3E...	24	–	–	–	–	■	–	–	–	–	■	■	–	58
		CPE18-M2H-5/3E...	–	110	–	–	–	■	–	–	–	–	■	■	–	
		CPE18-M3H-5/3E...	–	220	–	–	–	■	–	–	–	–	■	■	–	
	CPE18-P1-5/3E...1/4	χ ¹⁾	Υ ²⁾	–	–	–	■	–	–	–	–	–	–	–	63	

1) X = 12 V DC or 24 V DC pilot valve can be ordered
 2) Y = 24 V AC, 110 V AC or 230 V AC pilot valve can be ordered

Solenoid valves CPE, Compact Performance

Product range overview – Width 24 mm

Width	Circuit symbol	Type	Operating voltage		Working port										→ Page/ Internet
			[V DC]	[V AC]	M			G			QS				
					5	7	1/8	1/4	3/8	4	6	8	10	12	
24 mm		3/2-way single solenoid valve, normally closed													77
		CPE24-M1H-3GL...	24	-	-	-	-	-	■	-	-	-	■	■	
		CPE24-M2H-3GL...	-	110	-	-	-	-	■	-	-	-	■	■	
		CPE24-M3H-3GL...	-	220	-	-	-	-	■	-	-	-	■	■	
		3/2-way single solenoid valve, normally open													77
		CPE24-M1H-3OL...	24	-	-	-	-	-	■	-	-	-	■	■	
		CPE24-M2H-3OL...	-	110	-	-	-	-	■	-	-	-	■	■	
		CPE24-M3H-3OL...	-	220	-	-	-	-	■	-	-	-	■	■	
		5/2-way single solenoid valve													78
		CPE24-M1H-5L...	24	-	-	-	-	-	■	-	-	-	■	■	
		CPE24-M2H-5L...	-	110	-	-	-	-	■	-	-	-	■	■	
		CPE24-M3H-5L...	-	220	-	-	-	-	■	-	-	-	■	■	
		5/2-way double solenoid valve													78
		CPE24-M1H-5J...	24	-	-	-	-	-	■	-	-	-	■	■	
		CPE24-M2H-5J...	-	110	-	-	-	-	■	-	-	-	■	■	
		CPE24-M3H-5J...	-	220	-	-	-	-	■	-	-	-	■	■	
		5/3-way single solenoid valve, normally closed, mid-position valve													79
		CPE24-M1H-5/3G...	24	-	-	-	-	-	■	-	-	-	■	■	
		CPE24-M2H-5/3G...	-	110	-	-	-	-	■	-	-	-	■	■	
		CPE24-M3H-5/3G...	-	220	-	-	-	-	■	-	-	-	■	■	
		5/3-way single solenoid valve, normally open, mid-position valve													79
		CPE24-M1H-5/3B...	24	-	-	-	-	-	■	-	-	-	■	■	
		CPE24-M2H-5/3B...	-	110	-	-	-	-	■	-	-	-	■	■	
		CPE24-M3H-5/3B...	-	220	-	-	-	-	■	-	-	-	■	■	
		5/3-way single solenoid valve, normally exhausted, mid-position valve													79
		CPE24-M1H-5/3E...	24	-	-	-	-	-	■	-	-	-	■	■	
		CPE24-M2H-5/3E...	-	110	-	-	-	-	■	-	-	-	■	■	
	CPE24-M3H-5/3E...	-	220	-	-	-	-	■	-	-	-	■	■		

Solenoid valves CPE, Compact Performance

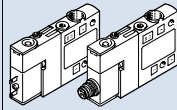
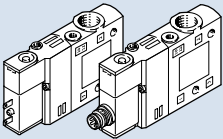
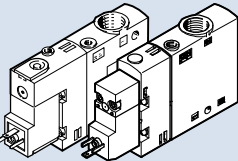
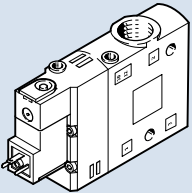
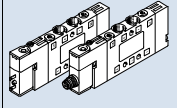
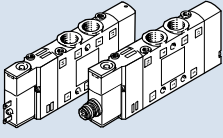
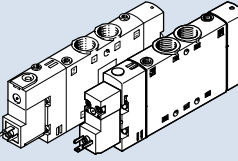
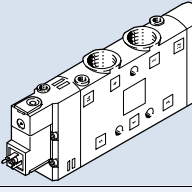

Product range overview – Functions

3/2-way valves					
Type		CPE10	CPE14	CPE18	CPE24
Width		10 mm	14 mm	18 mm	24 mm
Standard nominal flow rate [l/min]					
Thread	M5	190	-	-	-
	M7	400	-	-	-
	G1/8	-	900	-	-
	G1/4	-	-	1,300	-
	G3/8	-	-	-	2,500
Plug connector	QS-4	190	-	-	-
	QS-6	300	510	-	-
	QS-8	-	810	850	-
	QS-10	-	-	1,000	1,250
QS-12	-	-	-	1,650	
5/2-way single solenoid valves					
					
Type		CPE10	CPE14	CPE18	CPE24
Width		10 mm	14 mm	18 mm	24 mm
Standard nominal flow rate [l/min]					
Thread	M5	180	-	-	-
	M7	350	-	-	-
	G1/8	-	800	-	-
	G1/4	-	-	1,300	-
	G3/8	-	-	-	2,900
Plug connector	QS-4	180	-	-	-
	QS-6	320	400	-	-
	QS-8	-	680	850	-
	QS-10	-	-	1,000	1,250
QS-12	-	-	-	1,650	
Operating voltage					
12 V DC		-	-	■	-
24 V DC/AC		■/-	■/-	■/■	■/-
110 V AC		-	-	■	■
230 V AC		-	-	■	■
Technical data →		18	33	50	71

Solenoid valves CPE, Compact Performance

Product range overview – Functions

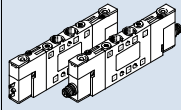
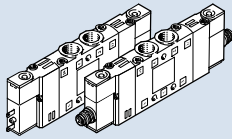
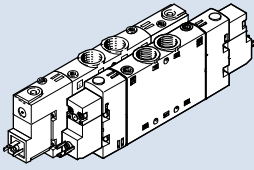
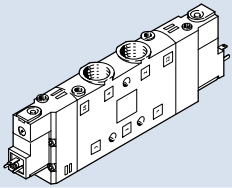
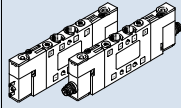
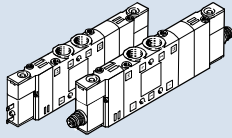
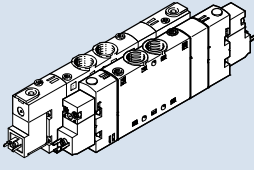
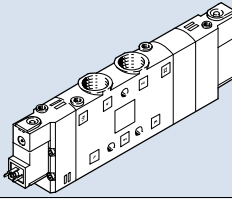
5/2-way double solenoid valves					
					
Type	CPE10	CPE14	CPE18	CPE24	
Width	10 mm	14 mm	18 mm	24 mm	
Standard nominal flow rate [l/min]					
Thread	M5	180	-	-	-
	M7	350	-	-	-
	G $\frac{1}{8}$	-	800	-	-
	G $\frac{1}{4}$	-	-	1,300	-
	G $\frac{3}{8}$	-	-	-	3,200
Plug connector	QS-4	180	-	-	-
	QS-6	320	400	-	-
	QS-8	-	680	850	-
	QS-10	-	-	1,000	1,250
	QS-12	-	-	-	1,650
5/3-way valves					
					
Type	CPE10	CPE14	CPE18	CPE24	
Width	10 mm	14 mm	18 mm	24 mm	
Standard nominal flow rate [l/min]					
Thread	M5	180	-	-	-
	M7	250 ... 350	-	-	-
	G $\frac{1}{8}$	-	700 ... 750	-	-
	G $\frac{1}{4}$	-	-	1,200 ... 1,450	-
	G $\frac{3}{8}$	-	-	-	2,600 ... 3,000
Plug connector	QS-4	180	-	-	-
	QS-6	250 ... 300	370 ... 410	-	-
	QS-8	-	570 ... 720	780 ... 850	-
	QS-10	-	-	1,000 ... 1,050	1,250
	QS-12	-	-	-	1,600 ... 1,650
Operating voltage					
12 V DC	-	-	■	-	
24 V DC/AC	■/-	■/-	■/■	■/-	
110 V AC	-	-	■	■	
230 V AC	-	-	■	■	
Technical data →	18	33	50	71	

Solenoid valves CPE, Compact Performance

Peripherals overview

FESTO

Individual valve

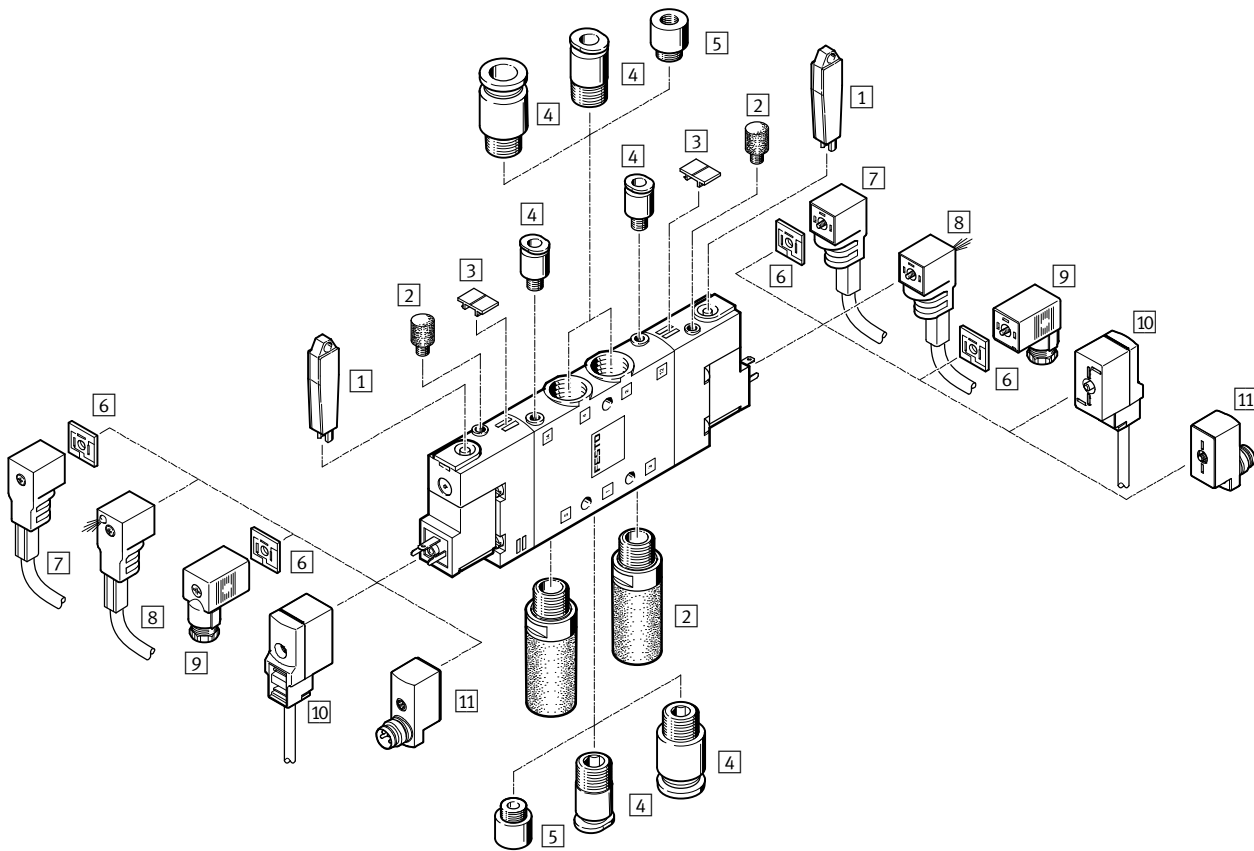

Accessories – Individual valve

	Type	Brief description	CPE10	CPE14	CPE18	CPE24	→ Page/Internet
1	Manual override tool	AHB...	■	■	■	■	83
2	Silencer	U... or UC...	■	■	■	■	83
3	Inscription labels	IBS-6x10	■	■	■	■	83
4	Push-in fittings	QS...	■	■	■	■	–
5	M7 to M5 reducer	–	■	–	–	–	–
6	Illuminating seal	MEB...LD	–	–	■	■	82
7	Plug socket with cable	KMEB...	–	–	■	■	82
8	Plug socket with cable	KMEB...	–	–	■	■	82
9	Standard plug socket	MSSD-EB...	–	–	■	■	82
10	Connecting cable	KMYZ-9...	■	■	–	–	81
11	Adapter	VAVE	■	■	–	–	–

Solenoid valves CPE, Compact Performance

System overview

Fixed-grid manifold assembly

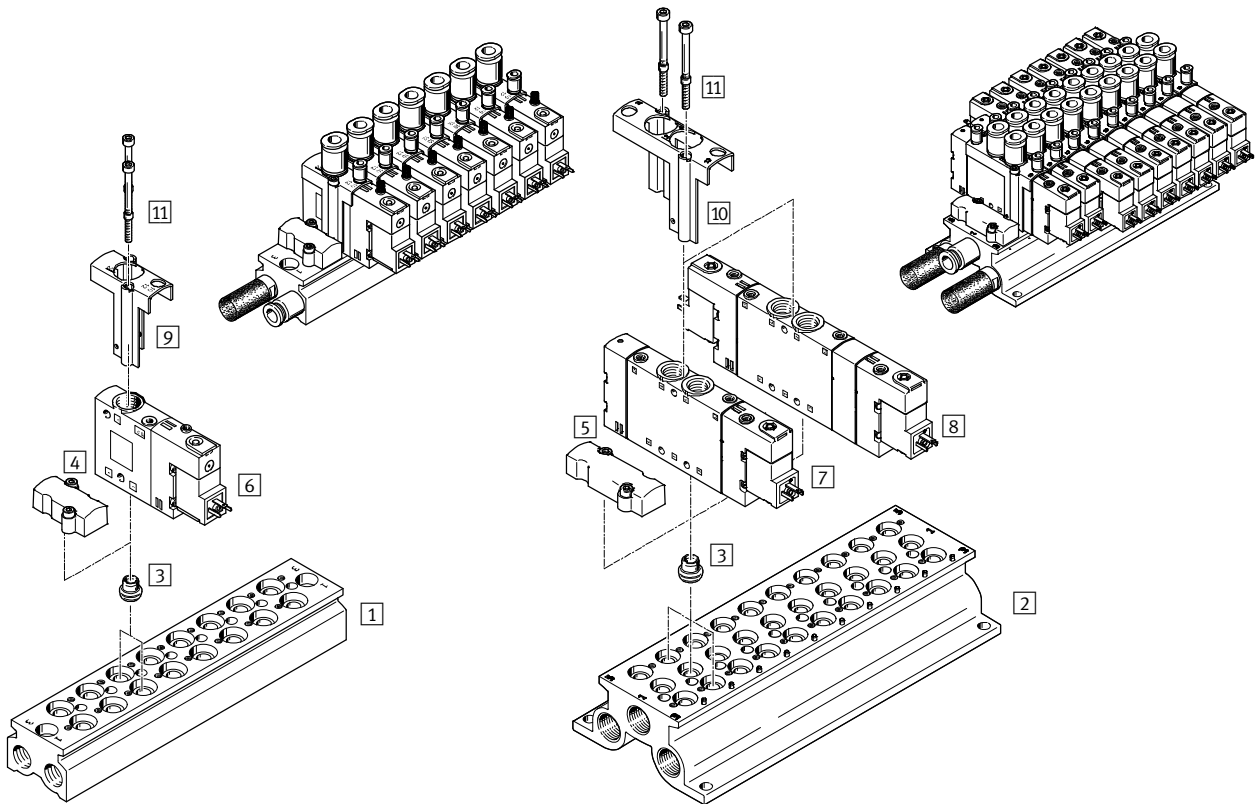

Example of manifold assembly – CPE18

	Type	Brief description	→ Page/Internet
1	CPE18-3/2-PRS-3/8-8	Manifold block for 3/2-way valves	66
2	CPE18-PRS-3/8-10	Manifold block for 5/2 and 5/3-way valves	64
3	CPV18-VI-P. 1/4-150	–	64
4	CPE18-RP3	Blanking plate for unused/vacant position	66
5	CPE18-RP	Blanking plate for unused/vacant position	64
6	CPE18...	–	56
7	CPE18...	–	57
8	CPE18...	–	58
9	CPE18-H3-50	Retainer for 3/2-way valve	66
10	CPE18-H5-50	Retainer for 5/2 and 5/3-way valve	64
11	M4X65-8.8-VS-100	–	64

Solenoid valves CPE, Compact Performance

Peripherals overview

FESTO

Accessories

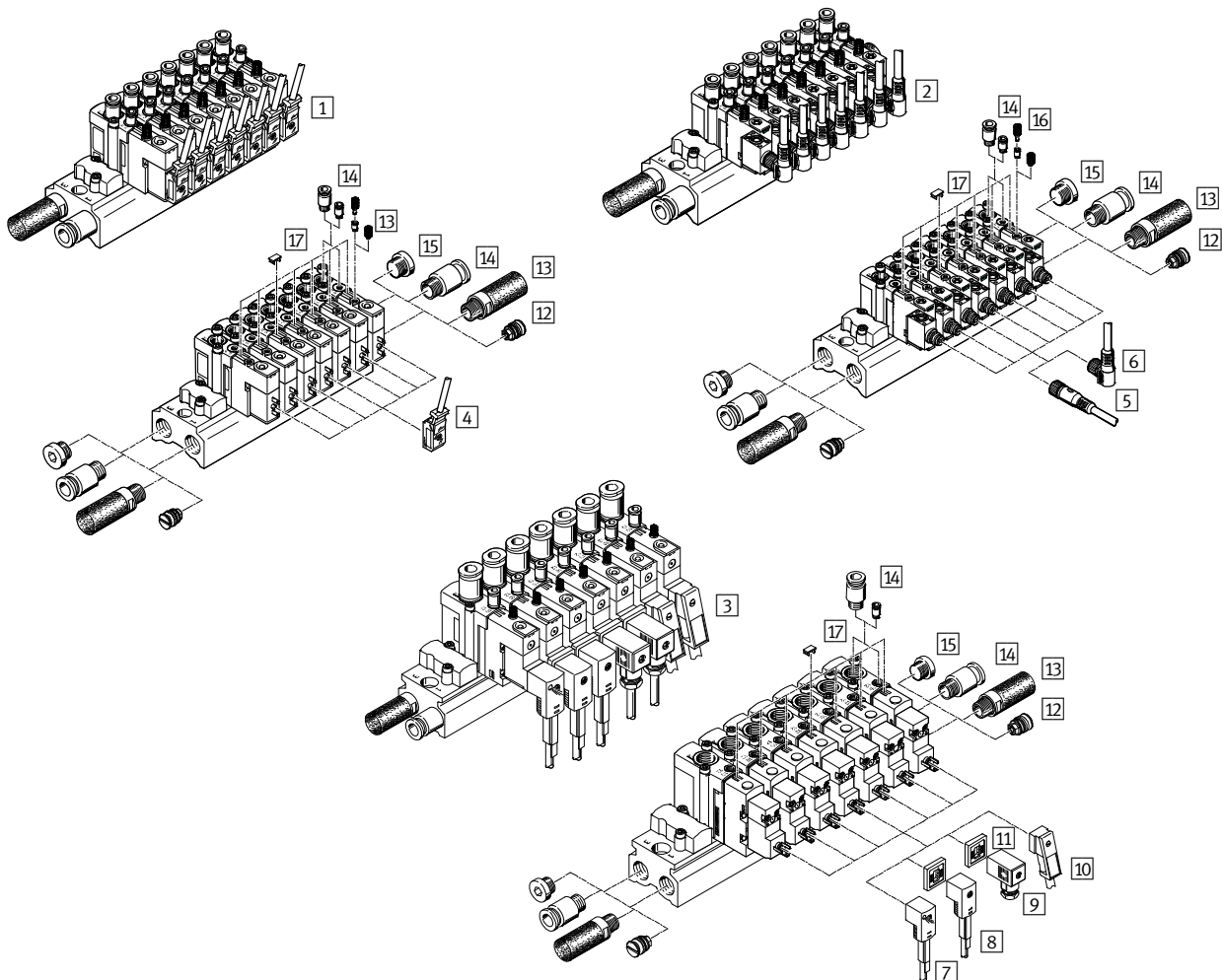

Accessories				
	Type	Brief description	→ Page/Internet	
1	Valve manifold CPE10	Equipped with 3/2-way valves with square plug	-	
2	Valve manifold CPE10	Equipped with 3/2-way valves with round plug	-	
3	Valve manifold CPE18	Equipped with 3/2-way basic valves plus pilot valve with square plug as required	-	
4	Connecting cable	KMYZ-9...-LED	For CPE10 and CPE14, integrated current reduction and LED	81
5	Connecting cable	SIM..., NEBU...	For CPE10 and CPE14 with round plug M8x1, straight	81
6	Connecting cable	SIM..., NEBU...	For CPE10 and CPE14 with round plug M8x1, straight	81
7	Plug socket with cable	KMEB-1...-LED	With PVC cable and integrated LED	82
8	Plug socket with cable	KMEB-1...	With PVC cable	82
9	Plug socket	MSSD-EB...	-	82
10	Plug socket with cable	KMEB-2...-LED	With PUR cable and integrated LED	82
11	Illuminating seal	MEB-LD...	For signal display with LED	82
12	Separator	VABD..., PRSV...	For pressure zones in aluminium manifold blocks	83
13	Silencer	U..., UC...	With thread	83
14	Push-in fittings	QS...	For tubing (included in scope of delivery for QS types)	-
15	Blanking plug	B...	-	83
16	Silencer	UC...-H	With push-in sleeve	83
17	Inscription label	IBS...	-	83

Solenoid valves CPE, Compact Performance

Peripherals overview

Accessories – CPE18 and CPE24

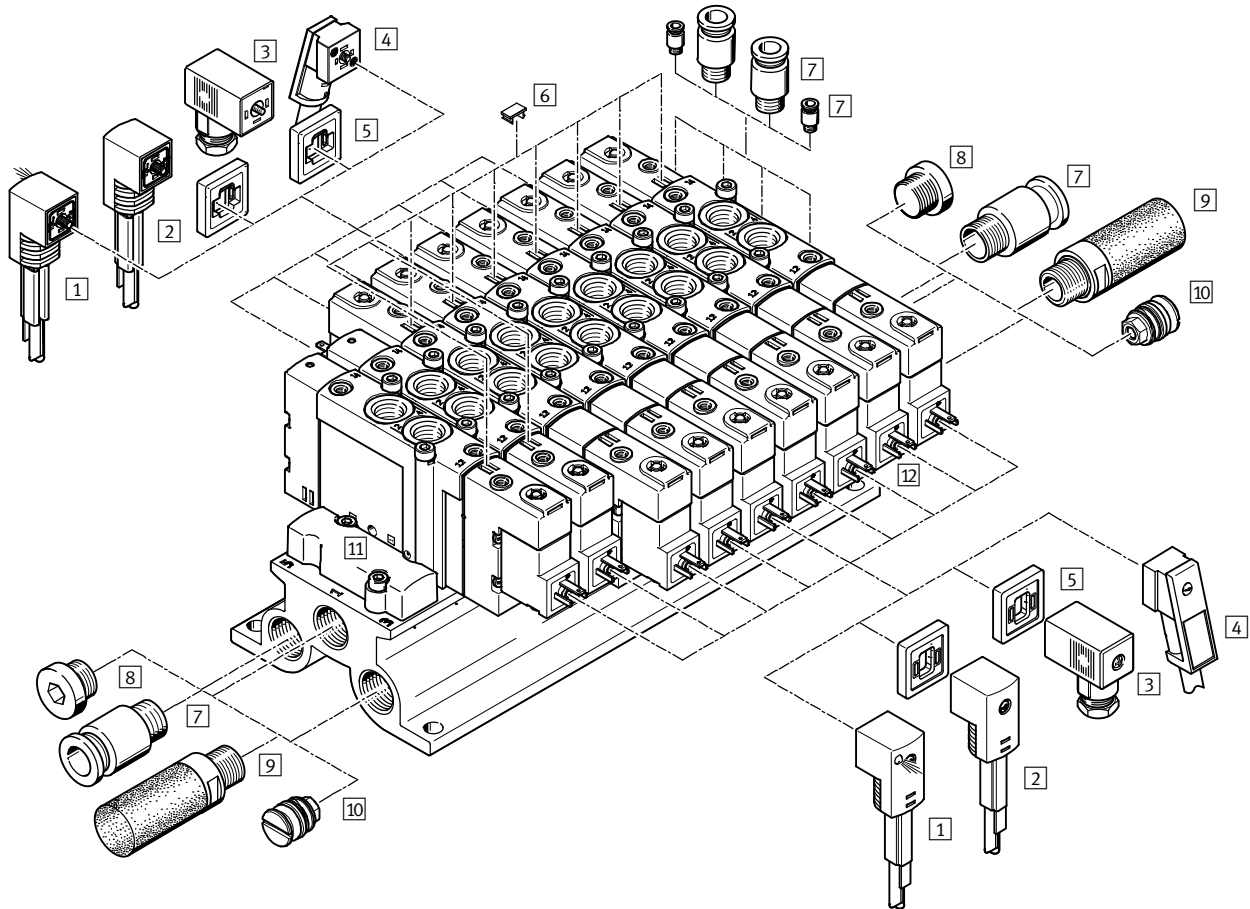

Accessories – Mounting on manifold block

	Type	Brief description	→ Page/Internet	
1	Plug socket with cable	KMEB-1...	With LED for 24 V DC	82
2	Plug socket with cable	KMEB-1...	For 0 ... 230 V AC	82
3	Standard plug socket	MSSD-EB...	–	82
4	Plug socket with cable	KMEB-2...	For 0 ... 230 V AC	82
5	Illuminating seal	MEB-LD...	–	82
6	Inscription label	IBS-6x10	–	83
7	Push-in fittings	QS...	For tubing	–
8	Blanking plug	B...	–	83
9	Silencer	U... or UC...	For fitting on exhaust ports	83
10	Separator for pressure zones	VABD..., PRSV...	For fitting on the manifold block	83
11	Blanking plate	CPE...-RP	For fitting on unused valve positions	–
12	Manifold block	CPE...-PRS	–	–

Solenoid valves CPE, Compact Performance

System overview

FESTO

Manifold assembly with modular manifold blocks

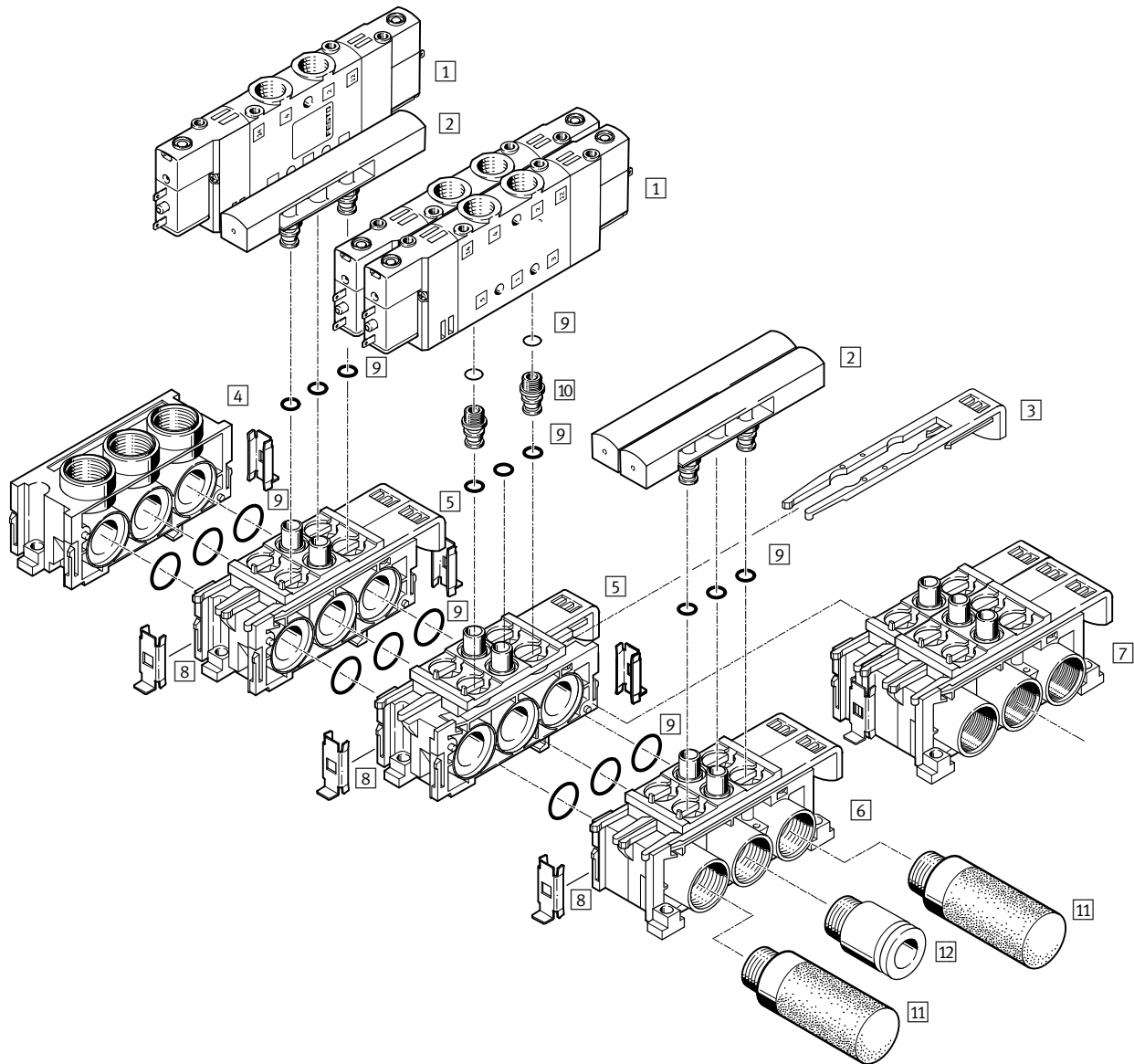

Accessories – Manifold assembly			
	Type	Brief description	→ Page/Internet
1	Solenoid valve	CPE...	–
2	Blanking plate	CPE...-RP	For sealing vacant positions
3	Slide	–	For attaching the valve
4	End plate	CPE...-PRS-EP	–
5	Expansion block	CPE...-PRSE-2	For 2 valves
6	Manifold block	CPE...-PRSG-2	For 2 valves
7	Manifold block	CPE...-PRSG-3	For 3 valves
8	Connecting piece	–	For connecting the blocks
9	Seal	–	Included in scope of delivery
10	Fitting	–	Included in scope of delivery
11	Silencer	U or UC	–
12	Push-in fitting	QS...	For tubing

Solenoid valves CPE, Compact Performance

Order codes

CPE		-	M	-				-		-	
-----	--	---	---	---	--	--	--	---	--	---	--

Type	
CPE	Solenoid valve, Compact Performance

Width	
10	10 mm
14	14 mm
18	18 mm
24	24 mm

Operating voltage	
Square plug	
M1BH	24 V DC for CPE10 and CPE14
M1H	24 V DC for CPE18 and CPE24
M2H	110 V AC for CPE18 and CPE24
M3H	230 V AC for CPE18 and CPE24
Round plug	
M1CH	24 V DC for CPE10 and CPE14

Valve function	
3	3/2-way
5L	5/2-way, single solenoid, pneumatic spring return
5J	5/2-way, double solenoid
5/3	5/3-way, single solenoid

Normal position	
GL	Closed, pneumatic reset for 3/2
OL	Open, pneumatic reset
B	Open
E	Exhausted
G	Closed

Pilot air supply	
	Internal
S	External



Pneumatic connection	
Female thread	
M5	M5 for CPE10, not with round plug
M7	M7 for CPE10
1/8	G1/8 for CPE14
1/4	G1/4 for CPE18
3/8	G3/8 for CPE24
Plug connector for standard O.D. tubing, not with round plug CPE10 and CPE14	
QS-4	Tubing O.D. 4 mm for CPE10
QS-6	Tubing O.D. 6 mm for CPE10 and CPE14
QS-8	Tubing O.D. 8 mm for CPE14 and CPE18
QS-10	Tubing O.D. 10 mm for CPE18 and CPE24
QS-12	Tubing O.D. 12 mm for CPE24

Generation	
B	B series for CPE10 5/3 way valve

Solenoid valves CPE10

Technical data

Function
 3/2G, 3/2O
 5/2-way single solenoid
 5/2-way double solenoid
 5/3G, 5/3B, 5/3E

-  - Width 10 mm
-  - Flow rate
180 ... 400 l/min
-  - Voltage
24 V DC

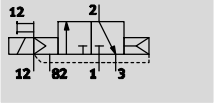

3/2-way valve with external pilot air supply, normally closed

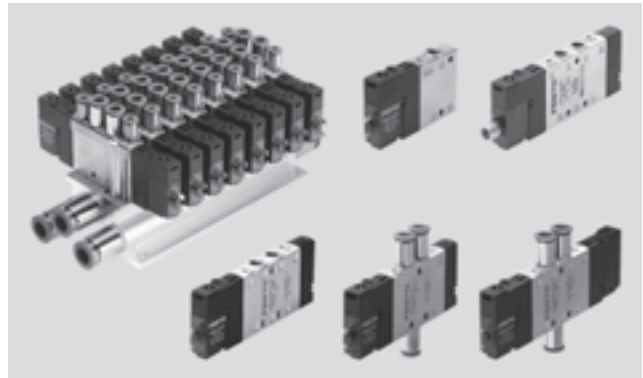

General technical data							
Valve function	3/2		5/2		5/3		
Normal position	G ¹⁾	O ²⁾	-		G ¹⁾	B ²⁾	E ³⁾
Memory stability	Single solenoid			Double solenoid	Single solenoid		
Pneumatic spring reset method	Yes			-	No		
Mechanical spring reset method	No			-	Yes		
Design	Piston spool						
Sealing principle	Soft						
Actuation type	Electric						
Control type	Piloted						
Pilot air supply	Internal or external						
Direction of flow	-		Reversible with external pilot air supply				
Exhaust function	-		Flow control				
Manual override	Non-detenting, detenting with accessory						
Type of mounting	Using through holes						
Mounting position	Any						
Pneumatic connection	1, 2, 4	Threaded connection: M5, M7; QS connection: Ø 4 or Ø 6 mm					
	3, 5	Threaded connection: M7					
	12, 14	Threaded connection: M3; QS connection: Ø 3					
	82, 84	Threaded connection: M3					
Nominal diameter	[mm]	4					
Standard nominal flow rate	M5	[l/min]	190	180			
	M7	[l/min]	400	350	300	250	
	QS4	[l/min]	190	180			
	QS6	[l/min]	300	350	320	300	250
Switching time on/off	[ms]	14/14	16/20	-	16/20		
Changeover time	[ms]	-			8	-	
Duty cycle	[%]	100					
Width	[mm]	10					
Corrosion resistance class	CRC	2 ⁴⁾					

1) G = Normally closed
 2) O, B = Normally open
 3) E = Normally exhausted
 4) Corrosion resistance class 2 as per Festo standard 940 070
 Components subject to moderate corrosion stress. Externally visible parts with primarily decorative surface requirements which are in direct contact with a normal industrial environment or media such as coolants or lubricating agents.

Solenoid valves CPE10

Technical data

Operating and environmental conditions				
Valve function			3/2	5/2 single solenoid 5/2 double solenoid 5/3
Operating medium	Compressed air in accordance with ISO 8573-1:2010 [7:4:4]			
Pilot medium	Compressed air in accordance with ISO 8573-1:2010 [7:4:4]			
Note on operating/pilot medium	Operation with lubricated medium possible (in which case lubricated operation will always be required)			
Operating pressure	Internal pilot air supply	[bar]	2.5 ... 8	3 ... 8
	External pilot air supply	[bar]	-0.9 ... +10	
Pilot pressure		[bar]	2.5 ... 8	3 ... 8
Ambient temperature		[°C]	-5 ... +50	
Temperature of medium		[°C]	-5 ... +50	
Certification for solenoid valves	c UL us - Recognised (OL), Germanischer Lloyd			

Electrical data				
Operating voltage	M1BH, M1CH	[V DC]	24 +10/-15%	
Power consumption	M1BH, M1CH	[W]	1.28	
Protection class with plug socket	IP65 (EN 60529)			
Max. tightening torque of plug socket M8x1	M1CH	[Nm]	0.4	

Materials

Sectional view

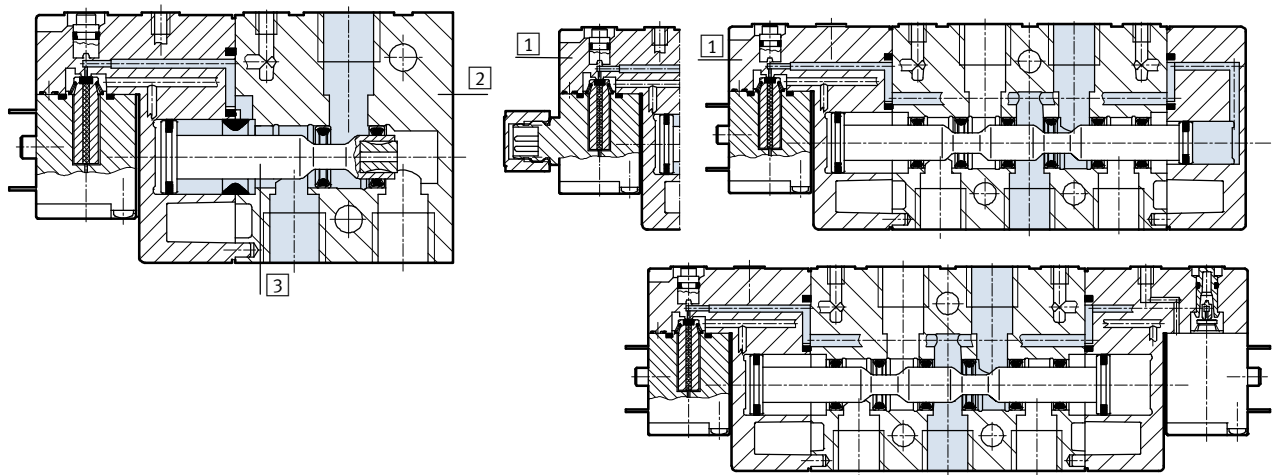

1	Cover	Polyamide
2	Housing	Die-cast aluminium
3	Piston spool	Steel
-	Seals	Nitrile rubber
	Note on materials	RoHS-compliant

Solenoid valves CPE10

Technical data

FESTO

Dimensions – 3/2-way valve

Download CAD data → www.festo.com

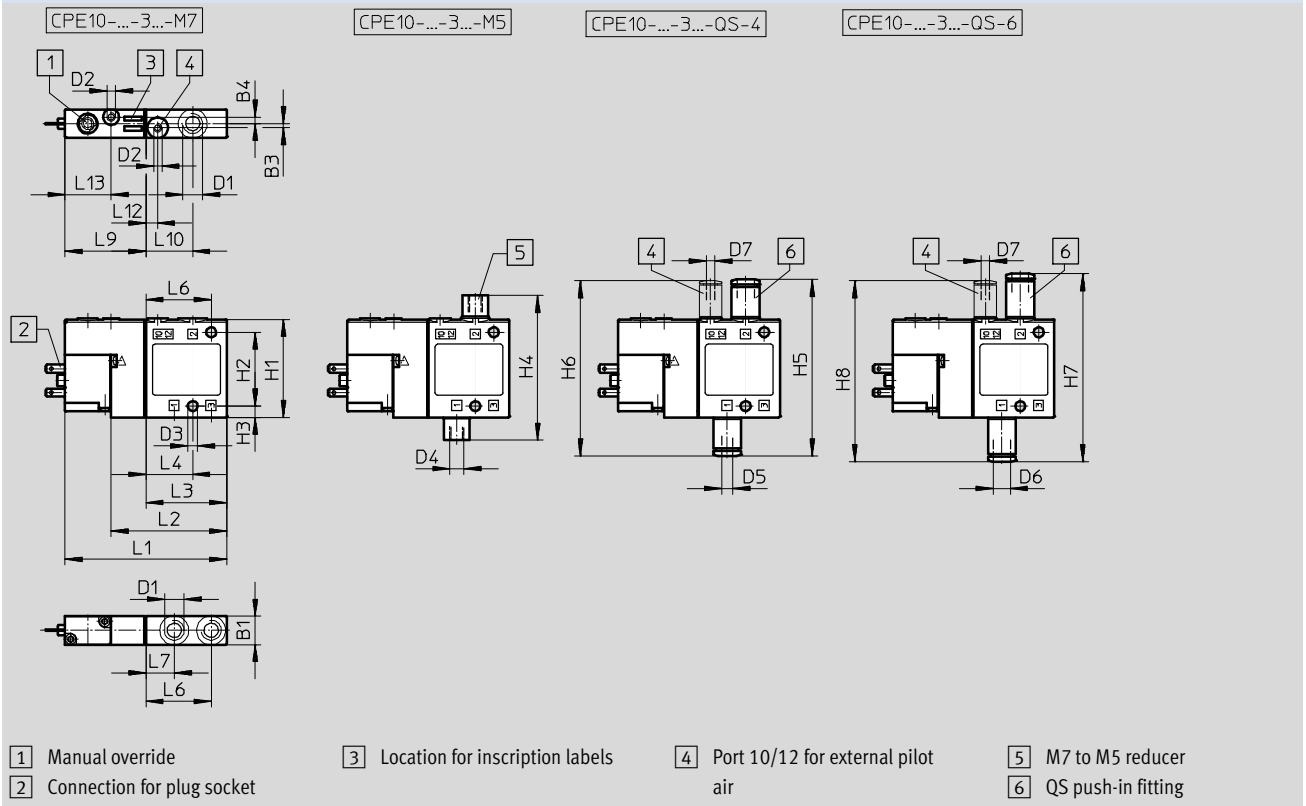

Type	B1	B3	B4	D1	D2	D3 ∅	D4	D5 ∅	D6 ∅	D7 ∅	H1	H2	H3	H4	H5	H6	H7	H8
CPE10-M1H-3...	10	1.5	2.3	M7	M3	3.5	M5	4	6	3	35	26	4	51	62.2	61.7	66.2	63.7

Type	L1	L2	L3	L4	L6	L7	L9	L10	L12	L13
CPE10-M1H-3...	57	40.8	28.5	16.5	23	10	28.5	16.5	4.2	16.3

Solenoid valves CPE10

Technical data

Dimensions – 5/2-way single solenoid valve

Download CAD data → www.festo.com

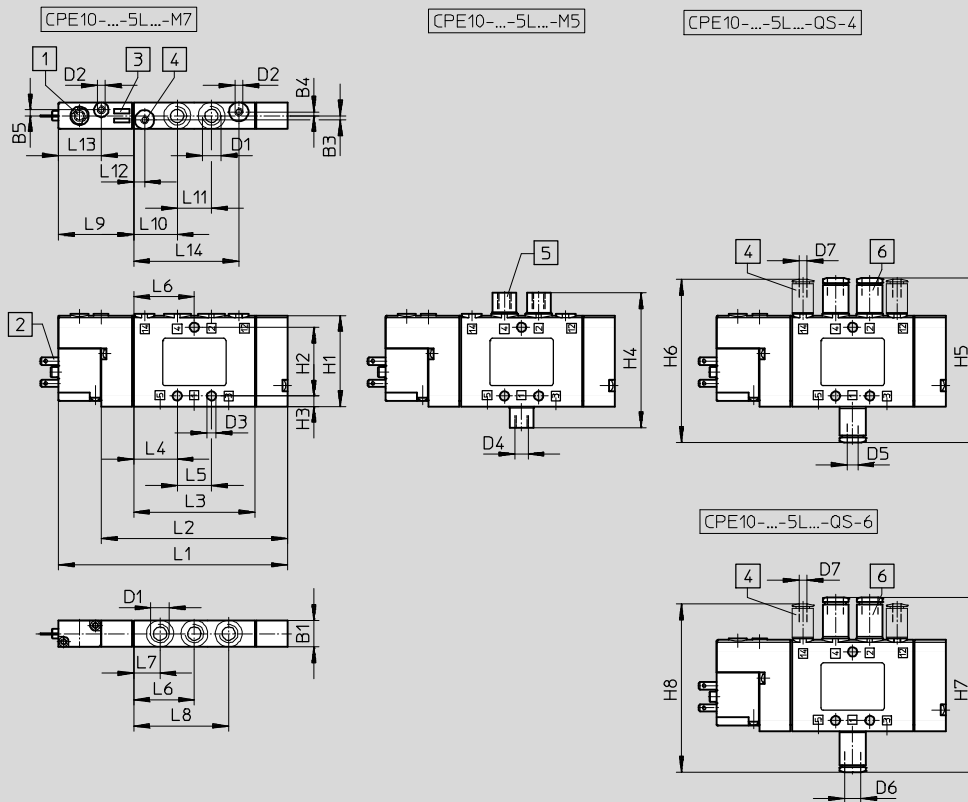

- 1 Manual override
- 2 Connection for plug socket
- 3 Location for inscription labels
- 4 Port 12/14 for external pilot air
- 5 M7 to M5 reducer
- 6 QS push-in fitting

Type	B1	B3	B4	B5	D1	D2	D3 Ø	D4	D5 Ø	D6 Ø	D7 Ø	H1	H2	H3	H4	H5	H6	H7	H8
CPE10-M1H-5L...	10	1.5	1.5	2.3	M7	M3	3.5	M5	4	6	3	35	26	4	51	62.2	61.7	66.2	63.7

Type	L1	L2	L3	L4	L5	L6	L7	L8	L9	L10	L11	L12	L13	L14
CPE10-M1H-5L...	86.8	70.6	46	16.5	13	23	10	36	28.5	16.5	13	4.2	16.3	39.8

Solenoid valves CPE10

Technical data



Dimensions – 5/2-way double solenoid valve and 5/3-way valve

Download CAD data → www.festo.com

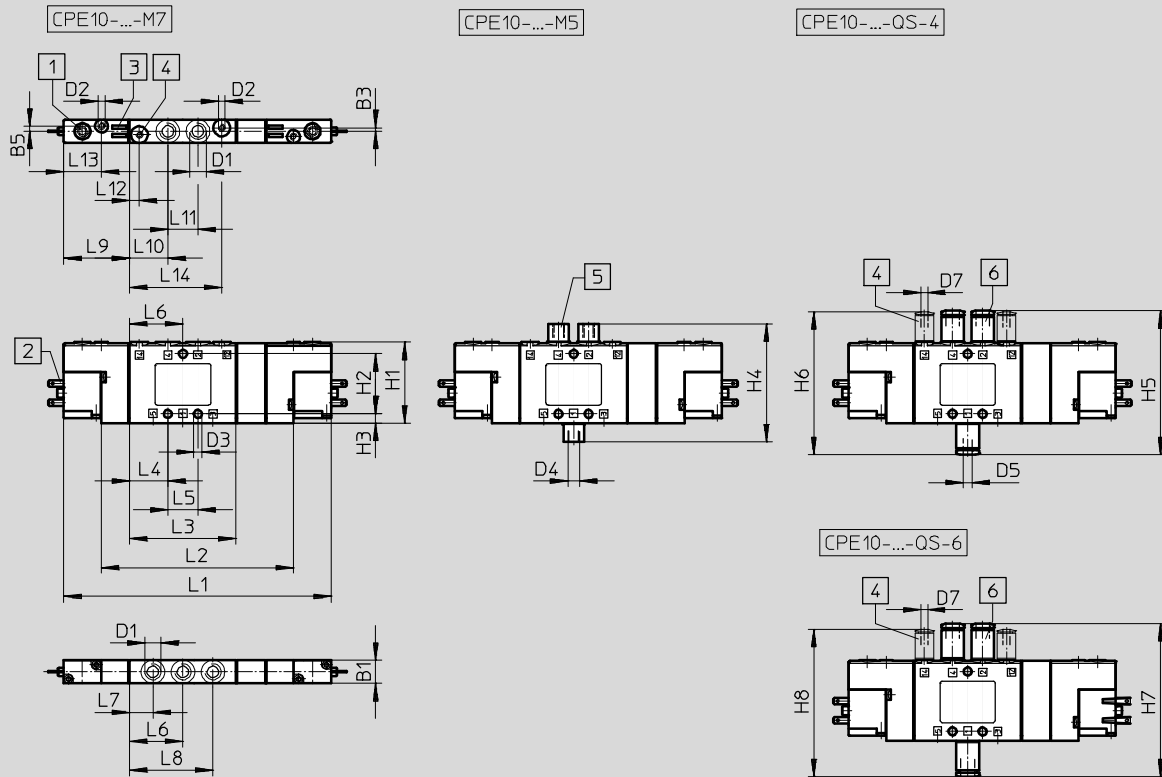

- 1 Manual override
- 2 Connection for plug socket
- 3 Location for inscription labels
- 4 Port 12/14 for external pilot air
- 5 M7 to M5 reducer
- 6 QS push-in fitting

Type	B1	B3	B5	D1	D2	D3 Ø	D4	D5 Ø	D6 Ø	D7 Ø	H1	H2	H3	H4	H5	H6	H7	H8
CPE-10-...-5]	10	1.5	2.3	M7	M3	3.5	M5	4	6	3	35	26	4	51	62.2	61.7	66.2	63.7
CPE-10-...-5/3																		

Type	L1	L2	L3	L4	L5	L6	L7	L8	L9	L10	L11	L12	L13	L14
CPE-10-...-5]	103	70.6	46	16.5	13	23	10	36	28.5	16.5	13	4.2	16.3	39.8
CPE-10-...-5/3	115.6	83.2												

Solenoid valves CPE10

Technical data

Dimensions – Solenoid valves with round plug M8x1

Download CAD data → www.festo.com

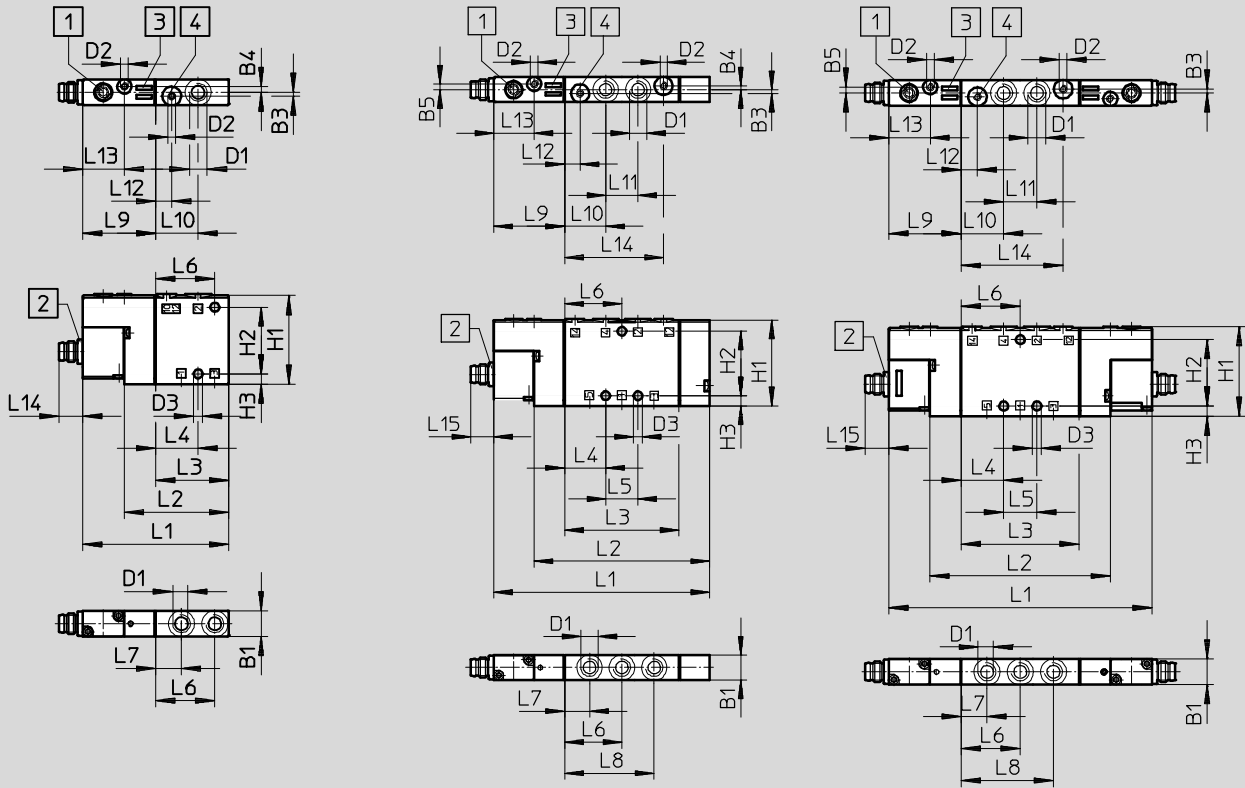

- 1 Manual override
- 2 Connection for plug socket M8x1
- 3 Location for inscription labels
- 4 Port 12/14 for external pilot air

Type	B1	B3	B4	B5	D1	D2	D3 Ø	H1	H2	H3
CPE-10-M1CH-3...	10	1.5	2.3	–	M7	M3	3.5	35	26	4
CPE-10-M1CH-5L...			1.5	2.3						
CPE-10-M1CH-5J...			–	–						

Type	L1	L2	L3	L4	L5	L6	L7	L8	L9	L10	L11	L12	L13	L14	L15
CPE-10-M1CH-3...	57	40.8	28.5	16.5	–	23	10	–	28.5	16.5	–	6.2	16.3	9.2	–
CPE-10-M1CH-5L...	86.8	70.6	46	–	13	–	–	36	–	–	13	–	–	39.82	9.2
CPE-10-M1CH-5J...	103	–	–	–	–	–	–	–	–	–	–	–	–	–	–

Solenoid valves CPE10

FESTO

Ordering data

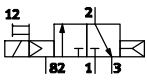
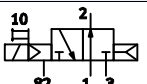
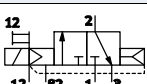
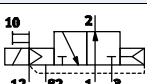
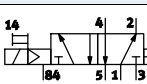
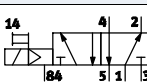
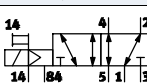
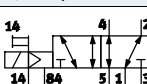
Ordering data							
Circuit symbol	Pilot air supply	Plug socket	Voltage	Connection	Weight [g]	Part No.	Type
3/2-way valve, normally closed							
	Internal	Square	24 V DC	M5	–	196845	CPE10-M1BH-3GL-M5
				M7	40	196915	CPE10-M1BH-3GL-M7
				QS-4	–	196846	CPE10-M1BH-3GL-QS-4
				QS-6	–	196847	CPE10-M1BH-3GL-QS-6
		M8x1		M7	40	550233	CPE10-M1CH-3GL-M7
3/2-way valve, normally open							
	Internal	Square	24 V DC	M5	–	196851	CPE10-M1BH-3OL-M5
				M7	40	196917	CPE10-M1BH-3OL-M7
				QS-4	–	196852	CPE10-M1BH-3OL-QS-4
				QS-6	–	196853	CPE10-M1BH-3OL-QS-6
		M8x1		M7	40	550235	CPE10-M1CH-3OL-M7
3/2-way valve, normally closed							
	External	Square	24 V DC	M5	–	196848	CPE10-M1BH-3GLS-M5
				M7	40	196916	CPE10-M1BH-3GLS-M7
				QS-4	–	196849	CPE10-M1BH-3GLS-QS-4
				QS-6	–	196850	CPE10-M1BH-3GLS-QS-6
		M8x1		M7	40	550234	CPE10-M1CH-3GLS-M7
3/2-way valve, normally open							
	External	Square	24 V DC	M5	–	196854	CPE10-M1BH-3OLS-M5
				M7	40	196918	CPE10-M1BH-3OLS-M7
				QS-4	–	196855	CPE10-M1BH-3OLS-QS-4
				QS-6	–	196856	CPE10-M1BH-3OLS-QS-6
		M8x1		M7	40	550236	CPE10-M1CH-3OLS-M7
5/2-way single solenoid valve							
	Internal	Square	24 V DC	M5	–	196881	CPE10-M1BH-5L-M5
				M7	56	196927	CPE10-M1BH-5L-M7
				QS-4	–	196882	CPE10-M1BH-5L-QS-4
				QS-6	–	196883	CPE10-M1BH-5L-QS-6
		M8x1		M7	56	550223	CPE10-M1CH-5L-M7
5/2-way double solenoid valve							
	Internal	Square	24 V DC	M5	–	196875	CPE10-M1BH-5J-M5
				M7	68	196925	CPE10-M1BH-5J-M7
				QS-4	–	196876	CPE10-M1BH-5J-QS-4
				QS-6	–	196877	CPE10-M1BH-5J-QS-6
		M8x1		M7	68	550225	CPE10-M1CH-5J-M7
5/2-way single solenoid valve							
	External	Square	24 V DC	M5	–	196884	CPE10-M1BH-5LS-M5
				M7	56	196928	CPE10-M1BH-5LS-M7
				QS-4	–	196885	CPE10-M1BH-5LS-QS-4
				QS-6	–	196886	CPE10-M1BH-5LS-QS-6
		M8x1		M7	56	550224	CPE10-M1CH-5LS-M7
5/2-way double solenoid valve							
	External	Square	24 V DC	M5	–	196878	CPE10-M1BH-5JS-M5
				M7	68	196926	CPE10-M1BH-5JS-M7
				QS-4	–	196879	CPE10-M1BH-5JS-QS-4
				QS-6	–	196880	CPE10-M1BH-5JS-QS-6
		M8x1		M7	68	550226	CPE10-M1CH-5JS-M7

Solenoid valves CPE10

Ordering data

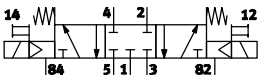
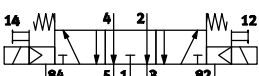
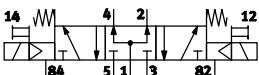
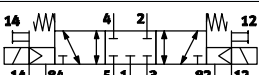
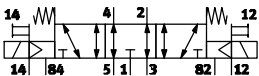
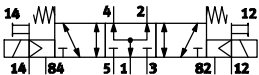
Ordering data							
Circuit symbol	Pilot air supply	Plug socket	Voltage	Connection	Weight [g]	Part No.	Type
5/3-way mid-position valve, normally closed							
	Internal	Square	24 V DC	M5	–	533159	CPE10-M1BH-5/3G-M5-B
				M7	68	533141	CPE10-M1BH-5/3G-M7-B
				QS-4	–	533147	CPE10-M1BH-5/3G-QS-4-B
				QS-6	–	533153	CPE10-M1BH-5/3G-QS-6-B
		M8x1		M7	68	550227	CPE10-M1CH-5/3G-M7
5/3-way mid-position valve, normally exhausted							
	Internal	Square	24 V DC	M5	–	533161	CPE10-M1BH-5/3E-M5-B
				M7	68	533143	CPE10-M1BH-5/3E-M7-B
				QS-4	–	533149	CPE10-M1BH-5/3E-QS-4-B
				QS-6	–	533155	CPE10-M1BH-5/3E-QS-6-B
		M8x1		M7	68	550229	CPE10-M1CH-5/3E-M7
5/3-way mid-position valve, normally open							
	Internal	Square	24 V DC	M5	–	533163	CPE10-M1BH-5/3B-M5-B
				M7	68	533145	CPE10-M1BH-5/3B-M7-B
				QS-4	–	533151	CPE10-M1BH-5/3B-QS-4-B
				QS-6	–	533157	CPE10-M1BH-5/3B-QS-6-B
		M8x1		M7	68	550231	CPE10-M1CH-5/3B-M7
5/3-way mid-position valve, normally closed							
	External	Square	24 V DC	M5	–	533160	CPE10-M1BH-5/3GS-M5-B
				M7	68	533142	CPE10-M1BH-5/3GS-M7-B
				QS-4	–	533148	CPE10-M1BH-5/3GS-QS-4-B
				QS-6	–	533154	CPE10-M1BH-5/3GS-QS-6-B
		M8x1		M7	68	550228	CPE10-M1CH-5/3GS-M7
5/3-way mid-position valve, normally exhausted							
	External	Square	24 V DC	M5	–	533162	CPE10-M1BH-5/3ES-M5-B
				M7	68	533144	CPE10-M1BH-5/3ES-M7-B
				QS-4	–	533150	CPE10-M1BH-5/3ES-QS-4-B
				QS-6	–	533156	CPE10-M1BH-5/3ES-QS-6-B
		M8x1		M7	68	550230	CPE10-M1CH-5/3ES-M7
5/3-way mid-position valve, normally open							
	External	Square	24 V DC	M5	–	533164	CPE10-M1BH-5/3BS-M5-B
				M7	68	533146	CPE10-M1BH-5/3BS-M7-B
				QS-4	–	533152	CPE10-M1BH-5/3BS-QS-4-B
				QS-6	–	533158	CPE10-M1BH-5/3BS-QS-6-B
		M8x1		M7	68	550232	CPE10-M1CH-5/3BS-M7

Manifold blocks CPE10

Technical data – Manifold block



Manifold block CPE...-PRS

Material:
Wrought aluminium alloy



Dimensions – Fixed-grid manifold 5/2 and 5/3

Download CAD data → www.festo.com

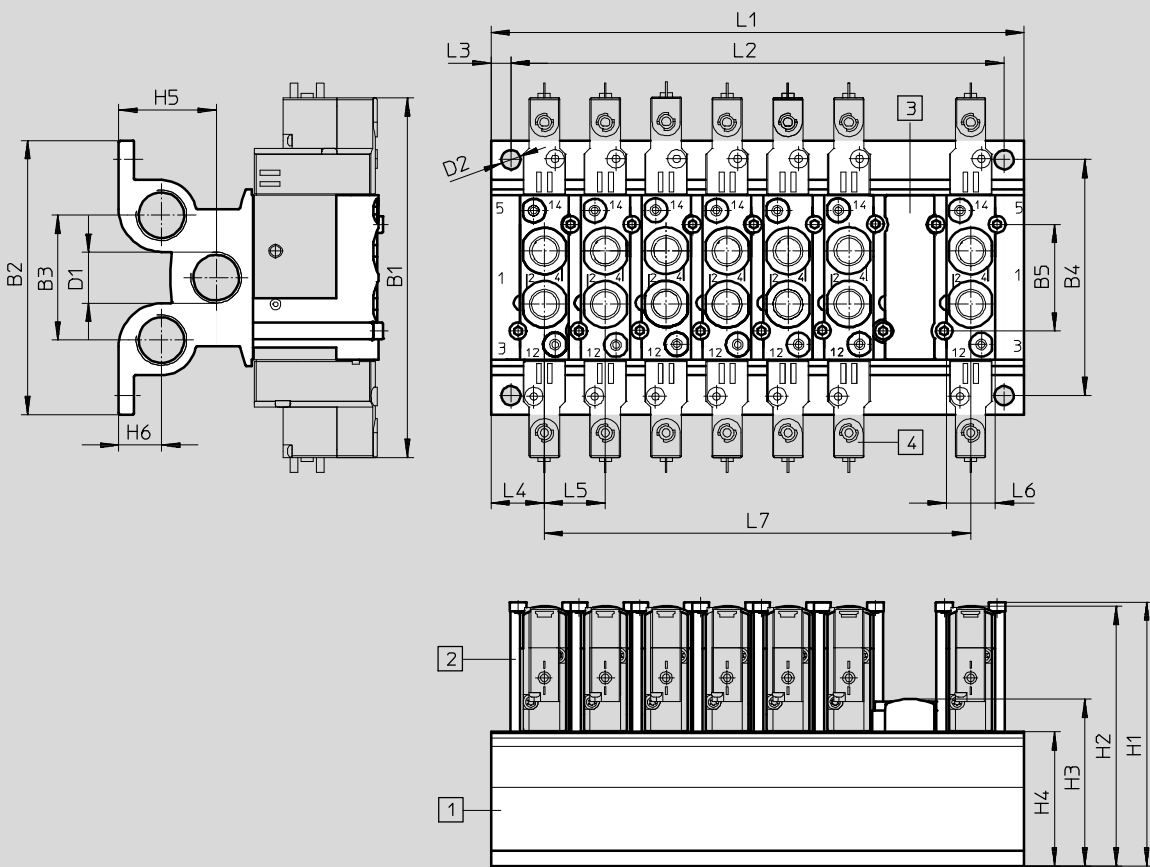

- 1 Manifold block
- 2 Retainer
- 3 Blanking plate
- 4 Valves

Type	B1	B2	B3	B4	B5	D1	D2	H1	H2	H3	H4	H5
CPE10-PRS...	103	79	35	67.5	26	G $\frac{1}{4}$	5.3 ∅	72	69.5	44.8	34	23.5

Type	H6	L1	L2	L3	L4	L5	L6	L7
CPE10-PRS...	11	28 + (n-1) x 16	L1 - 11 ± 0.1	5.5	14	16	13.4	(n-1) x 16

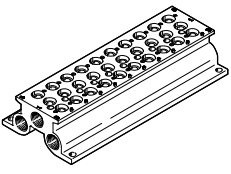

Manifold blocks CPE10

Ordering data – Fixed-grid manifold block

Ordering data						
	Valve positions	CRC	Max. tightening torque [Nm]	Weight [g]	Part No.	Type
Manifold block for 5/2 and 5/3-way valves						
	2	2 ¹⁾	1.2	131	543821	CPE10-PRS-1/4-2
	3			179	543822	CPE10-PRS-1/4-3
	4			227	543823	CPE10-PRS-1/4-4
	5			275	543824	CPE10-PRS-1/4-5
	6			323	543825	CPE10-PRS-1/4-6
	7			371	543826	CPE10-PRS-1/4-7
	8			419	543827	CPE10-PRS-1/4-8
	9			467	543828	CPE10-PRS-1/4-9
	10			515	543829	CPE10-PRS-1/4-10

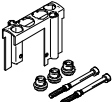
1) Corrosion resistance class 2 as per Festo standard 940 070
 Components subject to moderate corrosion stress. Externally visible parts with primarily decorative surface requirements which are in direct contact with a normal industrial environment or media such as coolants or lubricating agents.

Ordering data			
	Material	Part No.	Type
Blanking plate for vacant positions			
	Polyamide	544479	CPE10-RP
Retainer set			
	Retainer: High-alloy stainless steel Screws: Galvanised steel Seals: Nitrile rubber	544394	CPE10-H5-SET

Ordering data			
	Material	Part No.	Type
Retainer			
	Retainer: High-alloy stainless steel (Packaging unit 50 pieces)	547045	CPE10-H5-50
Screws			
	Galvanised steel (Packaging unit 100 pieces)	547048	M3X40-8.8-VS-100
Seals			
	Nitrile rubber (Packaging unit 150 pieces)	547051	CPV10-VI-P.M7-150

Manifold blocks CPE10

Technical data – Fixed-grid manifold block



Manifold block
for CPE10 3/2

Material:
Wrought aluminium alloy
RoHS-compliant



Dimensions – Fixed-grid manifold 3/2

Download CAD data → www.festo.com

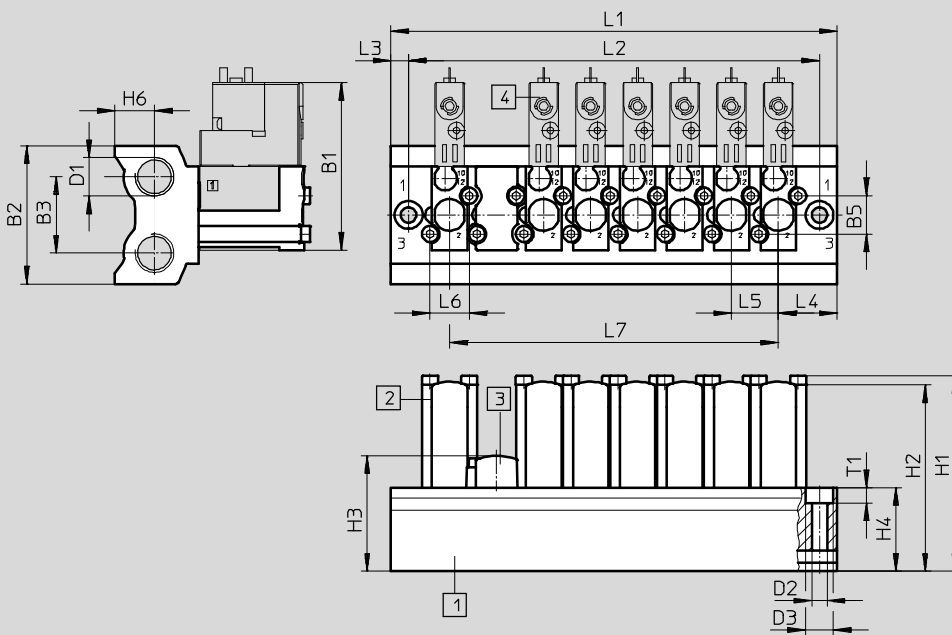

- 1 Manifold block
- 2 Retainer
- 3 Blanking plate
- 4 Valves

Type	B1	B2	B3	B5	D1	D2 ∅	D3 ∅	H1	H2	H3	H4	H6
CPE10-3/2-PRS...	57	47	26	13	G1/4	5.3	9.5	66.5	63.5	39.3	28.5	13.5



Type	L1	L2	L3	L4	L5	L6	L7	T1
CPE10-3/2-PRS...	$40 + (n-1) \times 16$	$28 + (n-1) \times 16$	6	20	16	13.4	$(n-1) \times 16$	5.3

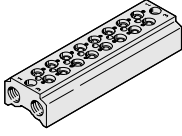

Manifold blocks CPE10

Ordering data – Fixed-grid manifold block

Ordering data						
	Valve positions	CRC	Max. tightening torque of valve mounting [Nm]	Weight [g]	Part No.	Type
Manifold block for 3/2-way valves						
	2	2 ¹⁾	1.2	128	550550	CPE10-3/2-PRS-1/4-2
	3			164	550551	CPE10-3/2-PRS-1/4-3
	4			201	550552	CPE10-3/2-PRS-1/4-4
	5			237	550553	CPE10-3/2-PRS-1/4-5
	6			274	550554	CPE10-3/2-PRS-1/4-6
	7			310	550555	CPE10-3/2-PRS-1/4-7
	8			347	550556	CPE10-3/2-PRS-1/4-8
	9			383	550557	CPE10-3/2-PRS-1/4-9
	10			420	550558	CPE10-3/2-PRS-1/4-10

1) Corrosion resistance class 2 as per Festo standard 940 070
 Components subject to moderate corrosion stress. Externally visible parts with primarily decorative surface requirements which are in direct contact with a normal industrial environment or media such as coolants or lubricating agents.

Ordering data			
	Material	Part No.	Type
Blanking plate			
	Polyamide RoHS-compliant	550580	CPE10-RP3
Retainer set			
	Retainer: High-alloy stainless steel Screws: Galvanised steel Seals: Nitrile rubber RoHS-compliant	550577	CPE10-H3-SET

Ordering data			
	Material	Part No.	Type
Retainer			
	Retainer: High-alloy stainless steel (Packaging unit 50 pieces)	551490	CPE10-H3-50
Screws			
	Galvanised steel (Packaging unit 100 pieces)	547048	M3X40-8.8-VS-100
Seals			
	Nitrile rubber (Packaging unit 150 pieces)	547051	CPV10-VI-P.M7-150

1) Packaging unit quantity

Manifold blocks CPE10

Technical data – Modular manifold



Modular manifold block
for CPE18 5/2 and 5/3

Material:
Reinforced polyamide

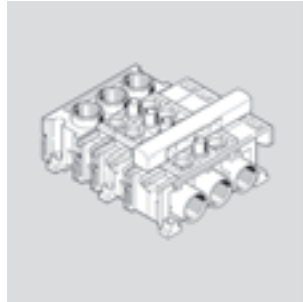

Dimensions – Modular manifold block

Download CAD data → www.festo.com

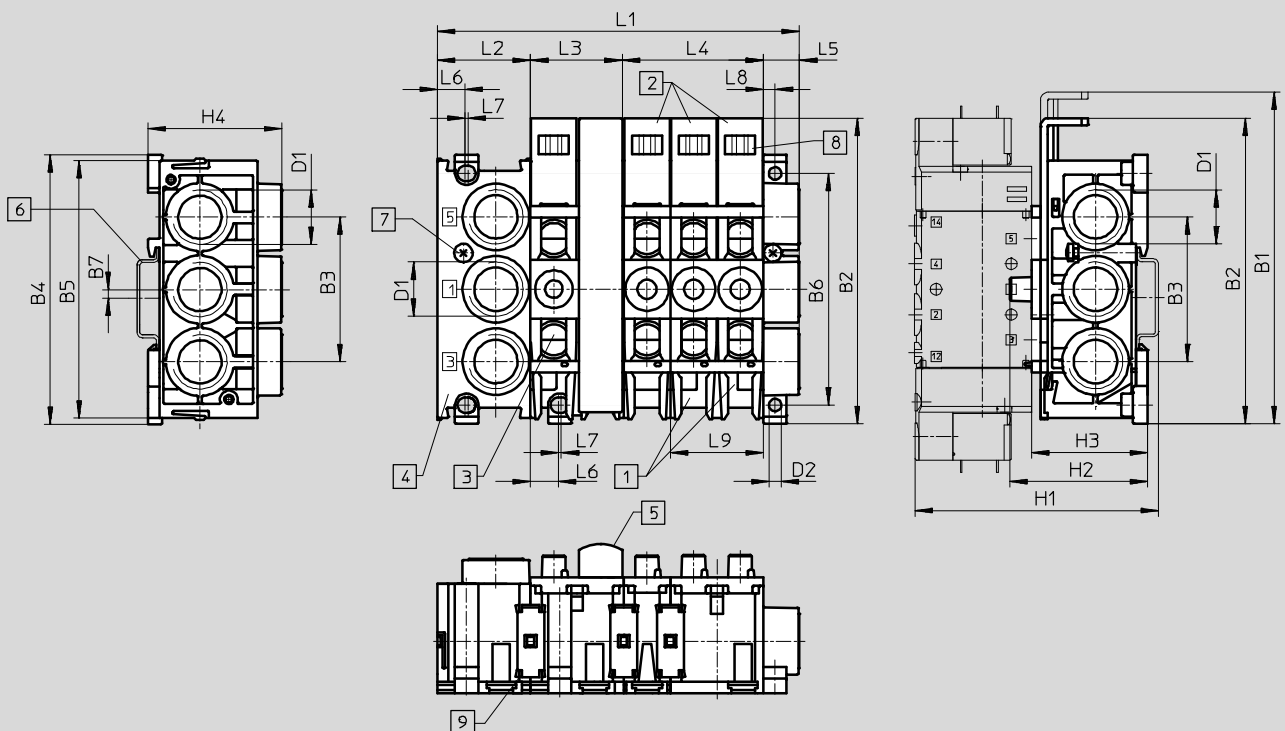

- | | | | |
|--|---|---------------------------------------|--|
| 1) Manifold block
CPE...-PRSG...-2 for 2 valves | 3) Expansion block
CPE...-PRSE...-2 for 2 valves | 6) H-rail to EN 50002
for mounting | 8) Location for inscription label
type IBS 6 x 10 |
| 2) Manifold block
CPE...-PRSG...-3 for 3 valves | 4) End block CPE...-PRS-EP | 7) Locking screw for H-rail | 9) Connecting piece |
| 5) Blanking plate CPE...-PRSB | | | |

Size	B1	B2	B3	B4	B5	B6	B7	D1	D2 ∅	H1	H2	H3
CPE10	93.5	87	37	73	71	60	7	G¼	3.3	~72	~40	~34

Size	H4	L1 ¹⁾	L2	L3	L4	L5	L6	L7	L8	L9
CPE10	37	24+(n×12)+11.4	24	24	36	11.4	9.6	–	3.2	24

1) n = Number of valve positions

Manifold blocks CPE10

Technical data – Modular manifold

Possible combinations			
Number of valve positions	One pressure zone	Two pressure zones	
		Variant 1	Variant 2
2	1x CPE...-PRSG-2	–	–
3	1x CPE...-PRSG-3	–	–
4	1x CPE...-PRSGO-2 1x CPE...-PRSE-2	1x CPE...-PRSG-2 1x CPE...-PRSEO-2 1x CPE...-PRS-EP	–
5	1x CPE...-PRSGO-3 1x CPE...-PRSE-2	1x CPE...-PRSG-3 1x CPE...-PRSEO-2 1x CPE...-PRS-EP	–
6	1x CPE...-PRSGO-2 1x CPE...-PRSE-2 1x CPE...-PRSE-2	1x CPE...-PRSG-2 2x CPE...-PRSEO-2 1x CPE...-PRS-EP	1x CPE...-PRSGO-2 1x CPE...-PRSE-2 1x CPE...-PRSE-2 1x CPE...-PRS-EP
7	1x CPE...-PRSGO-3 2x CPE...-PRSE-2 1x CPE...-PRS-EP	1x CPE...-PRSG-3 2x CPE...-PRSEO-2 1x CPE...-PRS-EP	1x CPE...-PRSGO-3 1x CPE...-PRSE-2 1x CPE...-PRSE-2 1x CPE...-PRS-EP
8	1x CPE...-PRSGO-2 3x CPE...-PRSE-2 1x CPE...-PRS-EP	1x CPE...-PRSG-2 3x CPE...-PRSEO-2 1x CPE...-PRS-EP	1x CPE...-PRSGO-2 1x CPE...-PRSE-2 2x CPE...-PRSE-2 1x CPE...-PRS-EP
9	1x CPE...-PRSGO-3 3x CPE...-PRSE-2 1x CPE...-PRS-EP	1x CPE...-PRSG-3 3x CPE...-PRSEO-2 1x CPE...-PRS-EP	1x CPE...-PRSGO-3 1x CPE...-PRSE-2 2x CPE...-PRSE-2 1x CPE...-PRS-EP
10	1x CPE...-PRSGO-2 4x CPE...-PRSE-2 1x CPE...-PRS-EP	1x CPE...-PRSG-2 4x CPE...-PRSEO-2 1x CPE...-PRS-EP	1x CPE...-PRSGO-2 1x CPE...-PRSE-2 3x CPE...-PRSE-2 1x CPE...-PRS-EP
11	1x CPE...-PRSGO-3 4x CPE...-PRSE-2 1x CPE...-PRS-EP	1x CPE...-PRSG-3 4x CPE...-PRSEO-2 1x CPE...-PRS-EP	1x CPE...-PRSGO-3 1x CPE...-PRSE-2 3x CPE...-PRSE-2 1x CPE...-PRS-EP
12	1x CPE...-PRSGO-2 5x CPE...-PRSE-2 1x CPE...-PRS-EP	1x CPE...-PRSG-2 5x CPE...-PRSEO-2 1x CPE...-PRS-EP	1x CPE...-PRSGO-2 1x CPE...-PRSE-2 4x CPE...-PRSE-2 1x CPE...-PRS-EP

 Note

A maximum of 6 valve positions are possible per air supply.
Use valve manifold blocks only in combination with 5/2-way and 5/3-way valves.

Manifold blocks CPE10

Ordering data – Modular manifold

FESTO

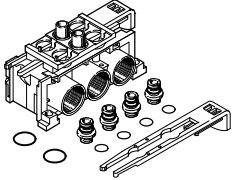
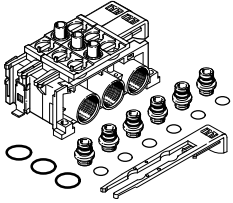
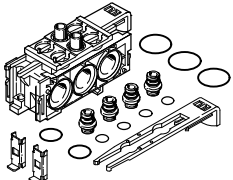
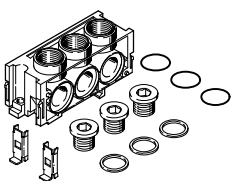
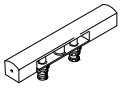
Ordering data					
	Ports 1, 3, 5	PRS ducts	Weight [g]	Part No.	Type
Manifold block PRSG for 2 valves					
	G $\frac{1}{4}$	Closed	50	164960	CPE10-PRSG-2
	G $\frac{1}{4}$	Open	50	187827	CPE10-PRSGO-2
Manifold block PRSG for 3 valves					
	G $\frac{1}{4}$	Closed	70	187823	CPE10-PRSG-3
	G $\frac{1}{4}$	Open	70	187819	CPE10-PRSGO-3
Manifold block PRSE for 2 valves					
	-	Closed	40	164962	CPE10-PRSE-2
	-	Open	40	187828	CPE10-PRSEO-2
End plate for manifold					
	G $\frac{1}{4}$	-	70	164964	CPE10-PRS-EP
Blanking plate for vacant positions					
	-	-	10	164963	CPE10-PRSB

Solenoid valves CPE14

Technical data

Function

3/2G, 3/2O

5/2-way single solenoid

5/2-way double solenoid

5/3G, 5/3B, 5/3E

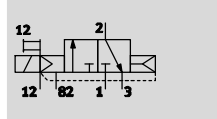

3/2-way valve with external pilot air supply, normally closed

 Width 14 mm

 Flow rate
370 ... 900 l/min

 Voltage
24 V DC

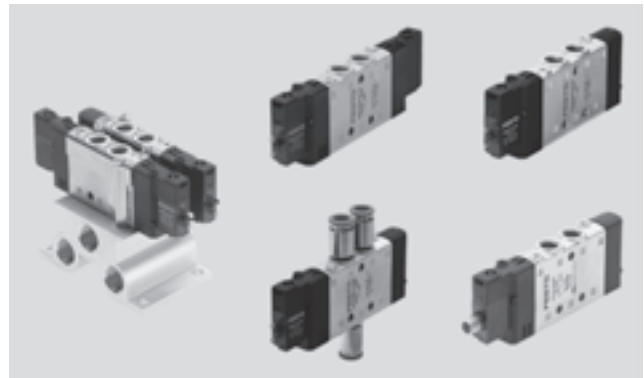

General technical data							
Valve function	3/2		5/2		5/3		
Normal position	G ¹⁾	O ²⁾	-	-	G ¹⁾	B ²⁾	E ³⁾
Memory stability	Single solenoid			Double solenoid	Single solenoid		
Pneumatic spring reset method	Yes			-	No		
Mechanical spring reset method	No			-	Yes		
Design	Piston spool						
Sealing principle	Soft						
Actuation type	Electric						
Control type	Piloted						
Pilot air supply	Internal or external						
Direction of flow	-		Reversible with external pilot air supply				
Exhaust function	-		Flow control				
Manual override	Non-detenting, detenting via accessory						
Type of mounting	Using through holes						
Mounting position	Any						
Pneumatic connection	1, 2, 4	Threaded connection: G1/8; QS connection: Ø 6 or Ø 8 mm					
	3, 5	Threaded connection: G1/8					
	12, 14	Threaded connection: M3; QS connection: Ø 3					
	82, 84	Threaded connection: M3					
Nominal diameter	[mm]	6					
Standard nominal flow rate	G1/8	[l/min]	900	800	750	700	
Standard nominal flow rate	QS6	[l/min]	510	400	410	370	
Standard nominal flow rate	QS8	[l/min]	810	680	720	650	570
Switching time on/off	[ms]	16/27		24/32	-	20/42	
Changeover time	[ms]	-			12	-	
Duty cycle	[%]	100					
Width	[mm]	14					
Corrosion resistance class	CRC	2 ⁴⁾					

1) G = Normally closed

2) O, B = Normally open

3) E = Normally exhausted

4) Corrosion resistance class 2 as per Festo standard 940 070

Components subject to moderate corrosion stress. Externally visible parts with primarily decorative surface requirements which are in direct contact with a normal industrial environment or media such as coolants or lubricating agents.

Solenoid valves CPE14

Technical data

Operating and environmental conditions						
Valve function		3/2	5/2 single solenoid	5/2 double solenoid	5/3	
Operating medium	Compressed air in accordance with ISO 8573-1:2010 [7:4:4]					
Pilot medium	Compressed air in accordance with ISO 8573-1:2010 [7:4:4]					
Note on operating/pilot medium	Operation with lubricated medium possible (in which case lubricated operation will always be required)					
Operating pressure	Internal pilot air supply	[bar]	2.5 ... 8	3 ... 8	2 ... 8	3 ... 8
	External pilot air supply	[bar]	-0.9 ... +10			
Pilot pressure	[bar]	2.5 ... 8	3 ... 8	2 ... 8	3 ... 8	
Ambient temperature	[°C]	-5 ... +50				
Temperature of medium	[°C]	-5 ... +50				
Certification for solenoid valves	c UL us - Recognised (OL), Germanischer Lloyd					

Electrical data			
Operating voltage	M1BH, M1CH	[V DC]	24 +10/-15%
Power consumption	M1BH, M1CH	[W]	1.28
Protection class with plug socket	IP65 (EN 60529)		
Max. tightening torque of plug socket M8x1	M1CH	[Nm]	0.4

Materials

Sectional view

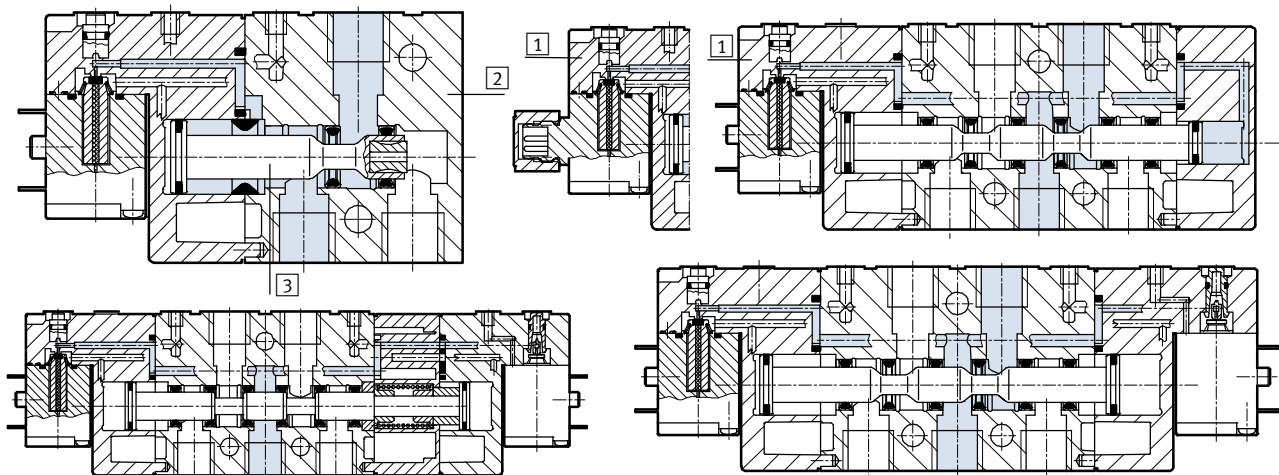

1	Cover	Polyamide
2	Housing	Die-cast aluminium
3	Piston spool	Steel
-	Seals	Nitrile rubber
	Note on materials	RoHS-compliant

Solenoid valves CPE14

Technical data

Dimensions – 3/2-way valve

Download CAD data → www.festo.com

CPE14-...-1/8

CPE14-...-QS-6

CPE14-...-QS-8

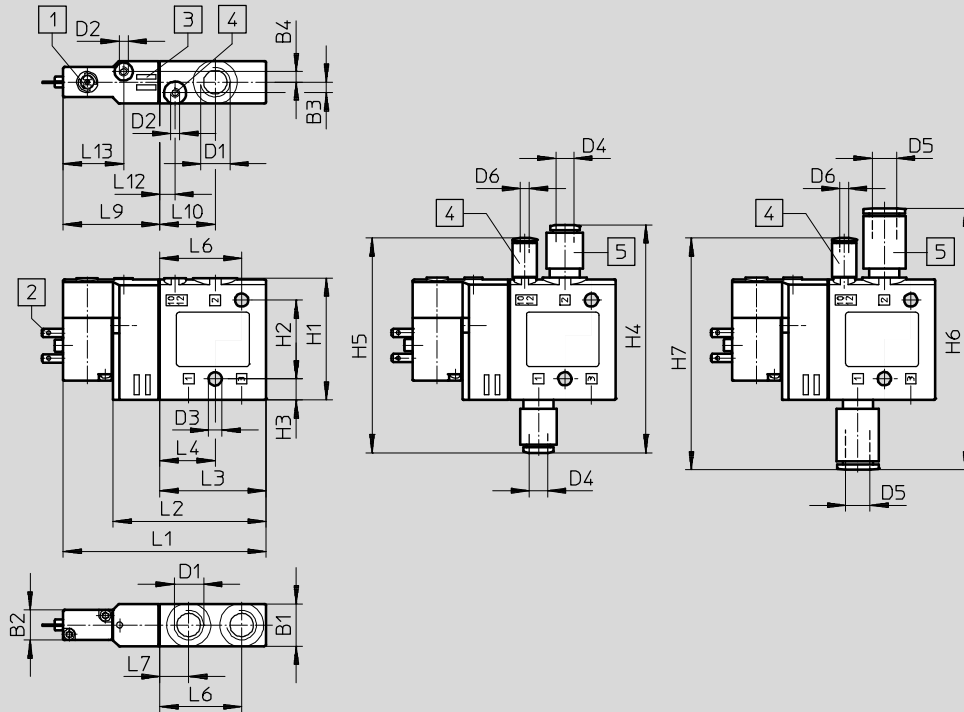

- 1 Manual override facility
- 2 Connection for plug socket

- 3 Location for inscription labels

- 4 Port 12/14 for external pilot air

- 5 QS push-in fitting

Type	B1	B2	B3	B4	D1	D2	D3	D4	D5	D6	H1	H2	H3	H4	H5	H6	H7
CPE14-M1H-3...	14	10	3.5	3.5	G1/8	M3	4.4	6	8	3	40.3	26	7	75.3	70.9	86.3	76.4

Type	L1	L2	L3	L4	L6	L7	L9	L10	L12	L13
CPE14-M1H-3...	67	50.5	35	18.3	27	9.5	32	18	5	20

Solenoid valves CPE14

Technical data

Dimensions – 5/2-way single solenoid valve

Download CAD data → www.festo.com

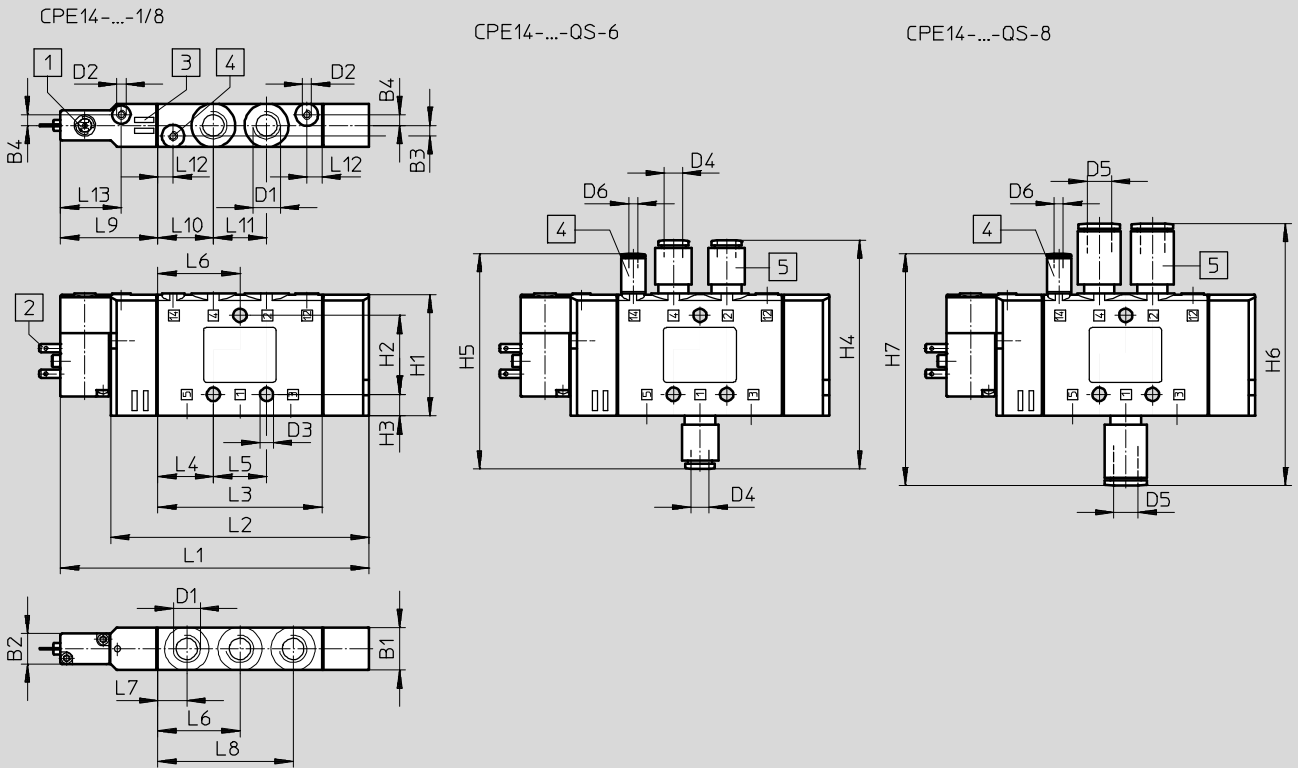

- 1 Manual override facility
- 2 Connection for plug socket
- 3 Location for inscription labels
- 4 Port 10/12 for external pilot air
- 5 QS push-in fitting

Type	B1	B2	B3	B4	D1	D2	D3	D4	D5	D6	H1	H2	H3	H4	H5	H6	H7
CPE14-M1H-5L...	14	10	3.5	3.5	G1/8	M3	4.4	6	8	3	40.3	26	7	75.3	70.9	86.3	76.4

Type	L1	L2	L3	L4	L5	L6	L7	L8	L9	L10	L11	L12	L13
CPE14-M1H-5L...	101.5	85	54	18.3	17.5	27	9.5	44.5	32	18.3	17.5	5	20

Solenoid valves CPE14

Technical data

Dimensions – 5/2-way double solenoid valve

Download CAD data → www.festo.com

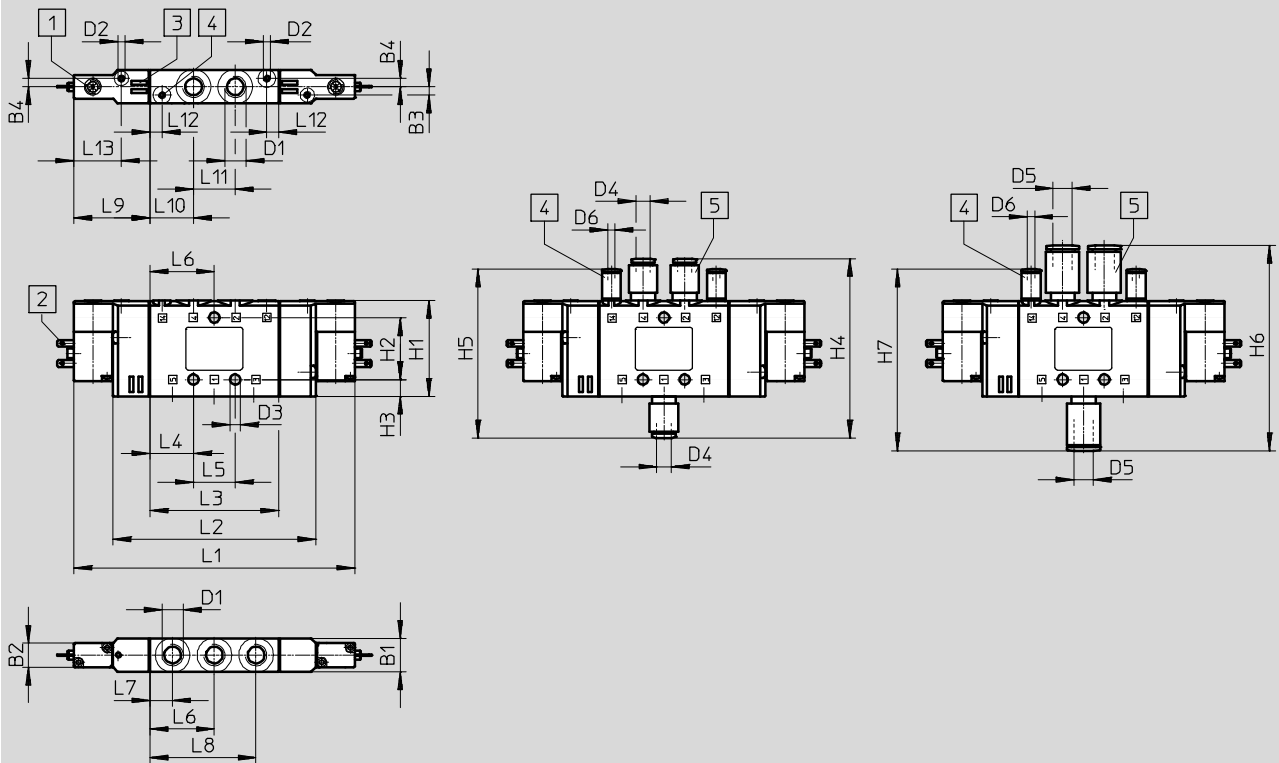

- 1 Manual override facility
- 2 Connection for plug socket
- 3 Location for inscription labels
- 4 Port 12/14 for external pilot air
- 5 QS push-in fitting

Type	B1	B2	B3	B4	D1	D2	D3	D4	D5	D6	H1	H2	H3	H4	H5	H6	H7
CPE14-...-5J-1/8	14	10	3.5	3.5	G1/8	M3	4.4	6	8	3	40.3	26	7	75.3	70.9	86.3	76.4

Type	L1	L2	L3	L4	L5	L6	L7	L8	L9	L10	L11	L12	L13
CPE14-...-5J-1/8	118	85	54	18.3	17.5	27	9.5	44.5	32	18.3	17.5	5	20

Solenoid valves CPE14

Technical data



Dimensions – 5/3-way valve

Download CAD data → www.festo.com

CPE14-...-1/8

CPE14-...-QS-6

CPE14-...-QS-8

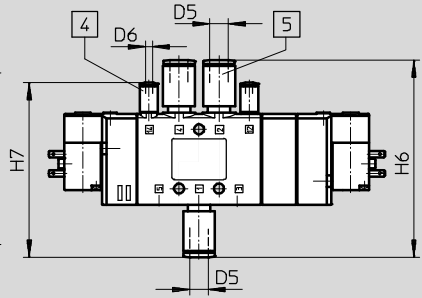
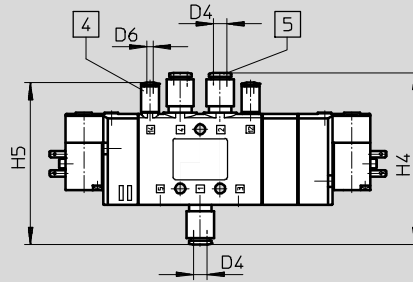
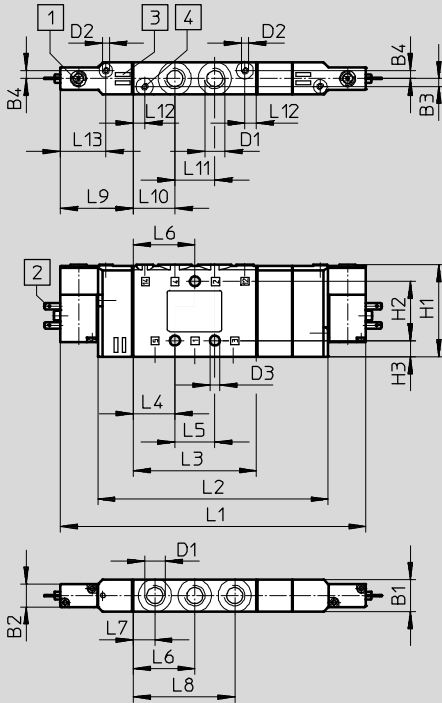

- 1 Manual override facility
- 2 Connection for plug socket
- 3 Location for inscription labels
- 4 Port 12/14 for external pilot air
- 5 QS push-in fitting

Type	B1	B2	B3	B4	D1	D2	D3	D4	D5	D6	H1	H2	H3	H4	H5	H6	H7
CPE14-M1H...-5]	14	10	3.5	3.5	G1/8	M3	4.4	6	8	3	40.3	26	7	75.3	70.9	86.3	76.4
CPE14-M1H...-5/3																	

Type	L1	L2	L3	L4	L5	L6	L7	L8	L9	L10	L11	L12	L13
CPE14-M1H...-5]	118	85	46	18.3	17.5	27	9.5	44.5	32	18.3	17.5	5	20
CPE14-M1H...-5/3	134	101											

Solenoid valves CPE14

Technical data

Dimensions – Solenoid valves with round plug M8x1

Download CAD data → www.festo.com

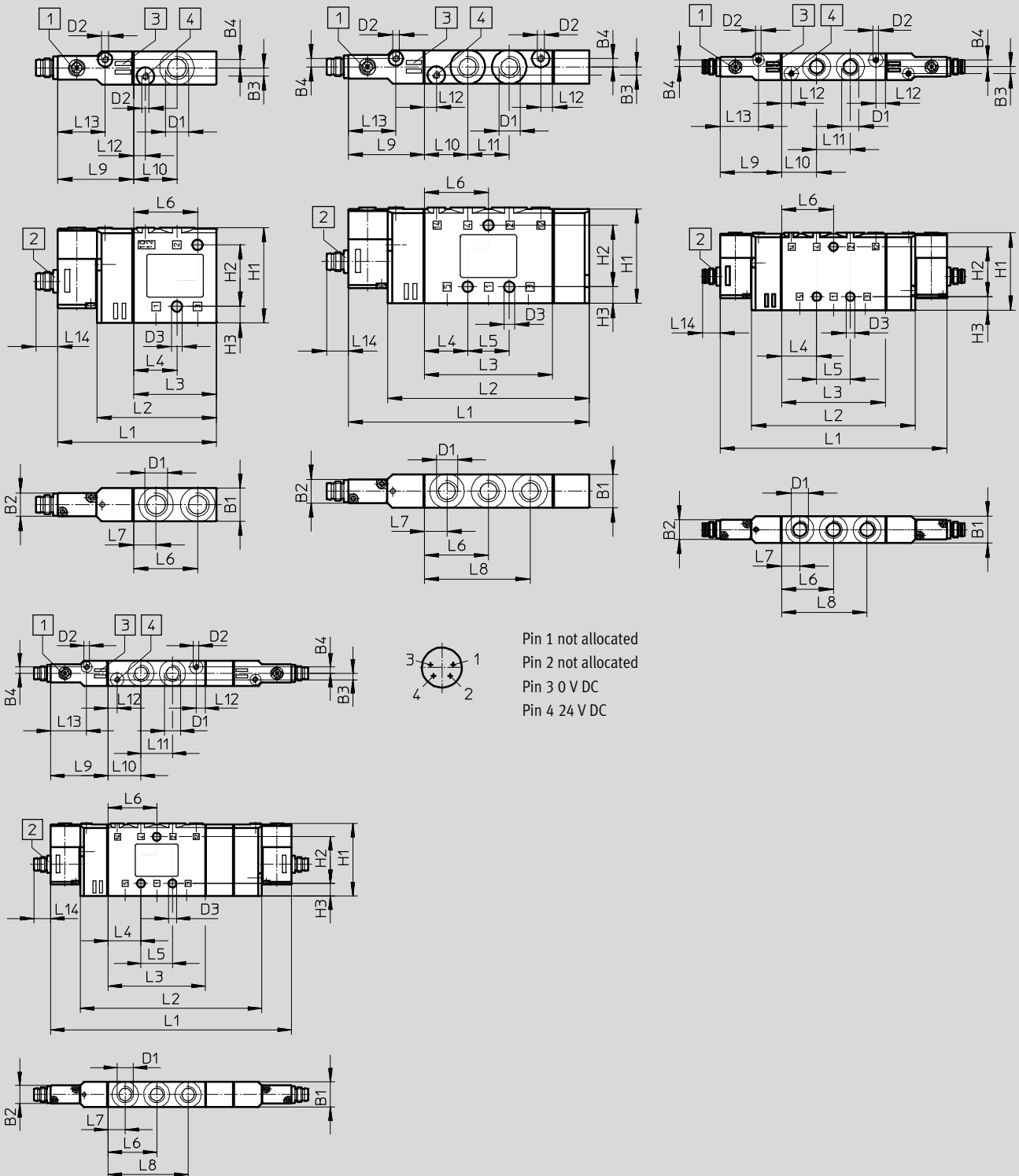

Pin 1 not allocated
 Pin 2 not allocated
 Pin 3 0 V DC
 Pin 4 24 V DC

- 1 Manual override facility
- 2 Connection for plug socket M8x1
- 3 Location for inscription labels
- 4 Port 12/14 for external pilot air

Solenoid valves CPE14



Technical data

Type	B1	B2	B3	B4	D1	D2	D3 ∅	H1	H2	H3
CPE14-M1CH-3...	14	10	3.5	3.5	G $\frac{1}{8}$	M3	4.4	40.3	26	7
CPE14-M1CH-5L...								40.4		
CPE14-M1CH-5J...								40.3		
CPE14-M1H-5J										
CPE14-M1H-5/3										

Type	L1	L2	L3	L4	L5	L6	L7	L8	L9	L10	L11	L12	L13	L14
CPE14-M1CH-3...	67	50.5	35	18.3	–	27	9.5	–	32	18.3	–	5	20	9.2
CPE14-M1CH-5L...	101.5	85	54	18.3	17.5	27	9.5	44.5	32	18.3	17.5	5	20	9.2
CPE14-M1CH-5J...	118													
CPE14-M1H-5J...														
CPE14-M1H-5/3...	134	101												

Solenoid valves CPE14

Ordering data

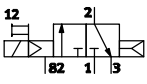
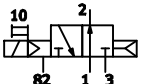
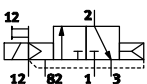
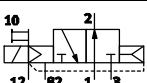
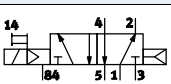
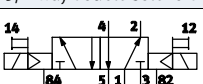
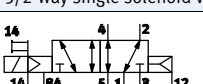
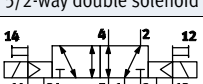
Ordering data							
Circuit symbol	Pilot air supply	Plug socket	Voltage	Connection	Weight [g]	Part No.	Type
3/2-way valve, normally closed							
	Internal	Square	24 V DC	G $\frac{1}{8}$	60	196929	CPE14-M1BH-3GL- $\frac{1}{8}$
				QS-6	-	196887	CPE14-M1BH-3GL-QS-6
		QS-8		-	196888	CPE14-M1BH-3GL-QS-8	
		M8x1		G $\frac{1}{8}$	60	550247	CPE14-M1CH-3GL- $\frac{1}{8}$
3/2-way valve, normally open							
	Internal	Square	24 V DC	G $\frac{1}{8}$	60	196931	CPE14-M1BH-3OL- $\frac{1}{8}$
				QS-6	-	196891	CPE14-M1BH-3OL-QS-6
		QS-8		-	196892	CPE14-M1BH-3OL-QS-8	
		M8x1		G $\frac{1}{8}$	60	550249	CPE14-M1CH-3OL- $\frac{1}{8}$
3/2-way valve, normally closed							
	External	Square	24 V DC	G $\frac{1}{8}$	60	196930	CPE14-M1BH-3GLS- $\frac{1}{8}$
				QS-6	-	196889	CPE14-M1BH-3GLS-QS-6
		QS-8		-	196890	CPE14-M1BH-3GLS-QS-8	
		M8x1		G $\frac{1}{8}$	60	550248	CPE14-M1CH-3GLS- $\frac{1}{8}$
3/2-way valve, normally open							
	External	Square	24 V DC	G $\frac{1}{8}$	60	196932	CPE14-M1BH-3OLS- $\frac{1}{8}$
				QS-6	-	196893	CPE14-M1BH-3OLS-QS-6
		QS-8		-	196894	CPE14-M1BH-3OLS-QS-8	
		M8x1		G $\frac{1}{8}$	60	550250	CPE14-M1CH-3OLS- $\frac{1}{8}$
5/2-way single solenoid valve							
	Internal	Square	24 V DC	G $\frac{1}{8}$	95	196941	CPE14-M1BH-5L- $\frac{1}{8}$
				QS-6	-	196911	CPE14-M1BH-5L-QS-6
		QS-8		-	196912	CPE14-M1BH-5L-QS-8	
		M8x1		G $\frac{1}{8}$	95	550237	CPE14-M1CH-5L- $\frac{1}{8}$
5/2-way double solenoid valve							
	Internal	Square	24 V DC	G $\frac{1}{8}$	115	196939	CPE14-M1BH-5J- $\frac{1}{8}$
				QS-6	-	196907	CPE14-M1BH-5J-QS-6
		QS-8		-	196908	CPE14-M1BH-5J-QS-8	
		M8x1		G $\frac{1}{8}$	115	550239	CPE14-M1CH-5J- $\frac{1}{8}$
5/2-way single solenoid valve							
	External	Square	24 V DC	G $\frac{1}{8}$	95	196942	CPE14-M1BH-5LS- $\frac{1}{8}$
				QS-6	-	196913	CPE14-M1BH-5LS-QS-6
		QS-8		-	196914	CPE14-M1BH-5LS-QS-8	
		M8x1		G $\frac{1}{8}$	95	550238	CPE14-M1CH-5LS- $\frac{1}{8}$
5/2-way double solenoid valve							
	External	Square	24 V DC	G $\frac{1}{8}$	115	196940	CPE14-M1BH-5JS- $\frac{1}{8}$
				QS-6	-	196909	CPE14-M1BH-5JS-QS-6
		QS-8		-	196910	CPE14-M1BH-5JS-QS-8	
		M8x1		G $\frac{1}{8}$	115	550240	CPE14-M1CH-5JS- $\frac{1}{8}$

Solenoid valves CPE14

Ordering data

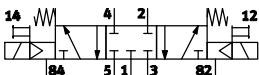
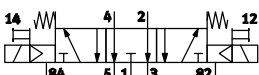
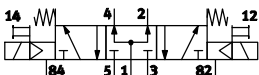
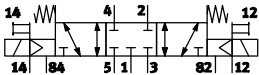
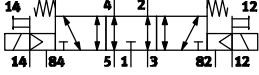
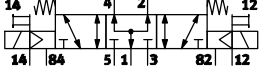
Ordering data							
Circuit symbol	Pilot air supply	Plug socket	Voltage	Connection	Weight [g]	Part No.	Type
5/3-way mid-position valve, normally closed							
	Internal	Square	24 V DC	G $\frac{1}{8}$	120	196937	CPE14-M1BH-5/3G- $\frac{1}{8}$
				QS-6	-	196903	CPE14-M1BH-5/3G-QS-6
		QS-8		-	196904	CPE14-M1BH-5/3G-QS-8	
		M8x1		G $\frac{1}{8}$	120	550241	CPE14-M1CH-5/3G- $\frac{1}{8}$
5/3-way mid-position valve, normally exhausted							
	Internal	Square	24 V DC	G $\frac{1}{8}$	120	196935	CPE14-M1BH-5/3E- $\frac{1}{8}$
				QS-6	-	196899	CPE14-M1BH-5/3E-QS-6
		QS-8		-	196900	CPE14-M1BH-5/3E-QS-8	
		M8x1		G $\frac{1}{8}$	120	550243	CPE14-M1CH-5/3E- $\frac{1}{8}$
5/3-way mid-position valve, normally open							
	Internal	Square	24 V DC	G $\frac{1}{8}$	120	196933	CPE14-M1BH-5/3B- $\frac{1}{8}$
				QS-6	-	196895	CPE14-M1BH-5/3B-QS-6
		QS-8		-	196896	CPE14-M1BH-5/3B-QS-8	
		M8x1		G $\frac{1}{8}$	120	550245	CPE14-M1CH-5/3B- $\frac{1}{8}$
5/3-way mid-position valve, normally closed							
	External	Square	24 V DC	G $\frac{1}{8}$	120	196938	CPE14-M1BH-5/3GS- $\frac{1}{8}$
				QS-6	-	196905	CPE14-M1BH-5/3GS-QS-6
		QS-8		-	196906	CPE14-M1BH-5/3GS-QS-8	
		M8x1		G $\frac{1}{8}$	120	550242	CPE14-M1CH-5/3GS- $\frac{1}{8}$
5/3-way mid-position valve, normally exhausted							
	External	Square	24 V DC	G $\frac{1}{8}$	120	196936	CPE14-M1BH-5/3ES- $\frac{1}{8}$
				QS-6	-	196901	CPE14-M1BH-5/3ES-QS-6
		QS-8		-	196902	CPE14-M1BH-5/3ES-QS-8	
		M8x1		G $\frac{1}{8}$	120	550244	CPE14-M1CH-5/3ES- $\frac{1}{8}$
5/3-way mid-position valve, normally open							
	External	Square	24 V DC	G $\frac{1}{8}$	120	196934	CPE14-M1BH-5/3BS- $\frac{1}{8}$
				QS-6	-	196897	CPE14-M1BH-5/3BS-QS-6
		QS-8		-	196898	CPE14-M1BH-5/3BS-QS-8	
		M8x1		G $\frac{1}{8}$	120	550246	CPE14-M1CH-5/3BS- $\frac{1}{8}$

Manifold blocks CPE14

Technical data – Manifold block



Manifold block CPE...-PRS

Material:
Wrought aluminium alloy
RoHS-compliant



Dimensions – Fixed-grid manifold 5/2 and 5/3

Download CAD data → www.festo.com

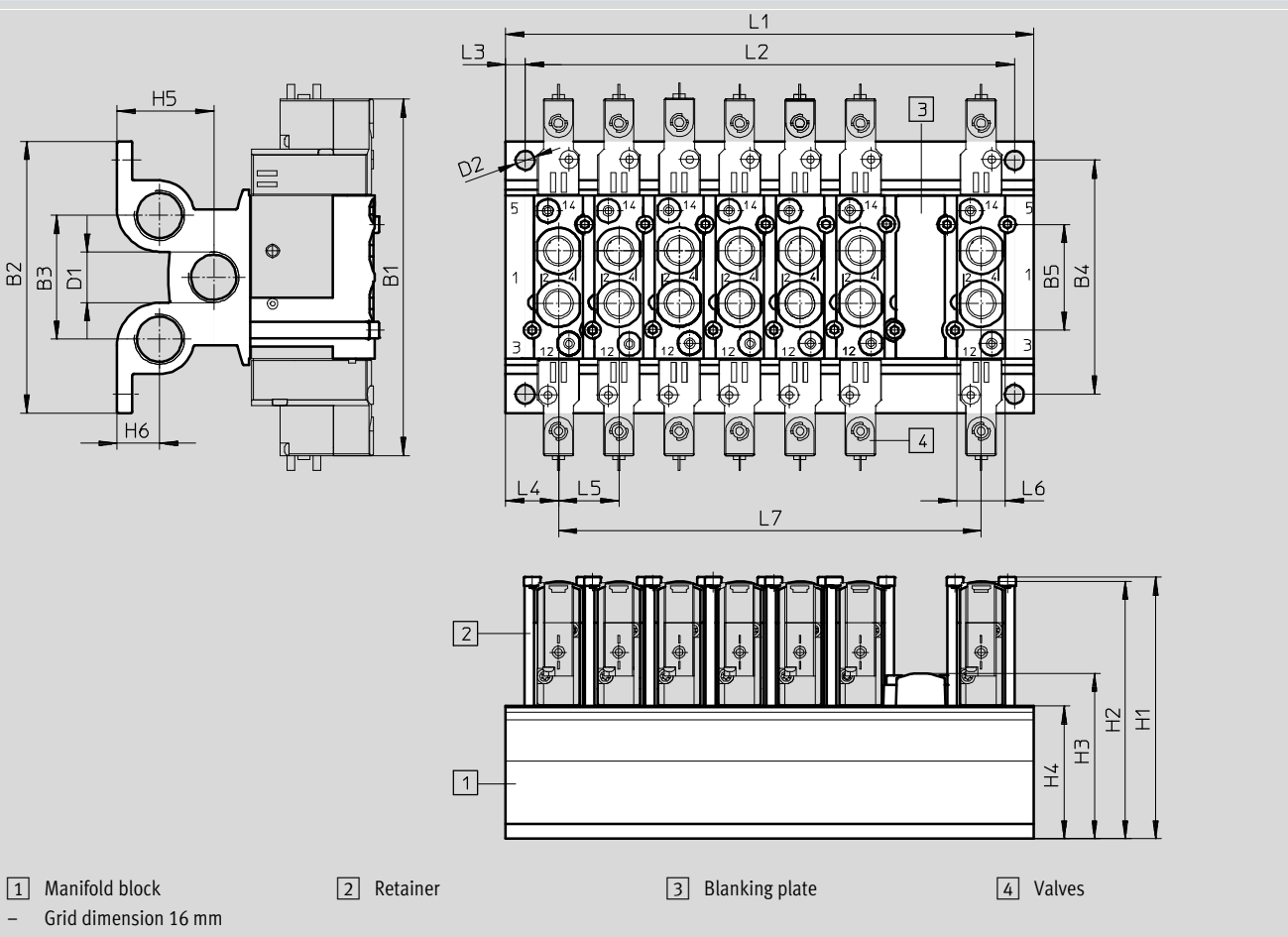

Type	B1	B2	B3	B4	B5	D1	D2	H1	H2	H3	H4	H5
CPE14-PRS...	118	90	41	77.5	35	G $\frac{3}{8}$	6.3	86.7	84.8	54.8	44	32

Type	H6	L1	L2	L3	L4	L5	L6	L7
CPE14-PRS...	14	$35 + (n-1) \times 20$	$L1 - 13 \pm 0.1$	6.5	17.5	20	17.4	$(n-1) \times 20$



Manifold blocks CPE14

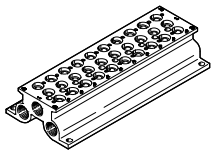

Ordering data – Fixed-grid manifold block

Ordering data						
	Valve positions	CRC	Max. tightening torque [Nm]	Weight [g]	Part No.	Type
Manifold block for 5/2-way and 5/3-way valves						
	2	2 ¹⁾	1.2	239	543830	CPE14-PRS-3/8-2
	3			326	543831	CPE14-PRS-3/8-3
	4			412	543832	CPE14-PRS-3/8-4
	5			498	543833	CPE14-PRS-3/8-5
	6			584	543834	CPE14-PRS-3/8-6
	7			671	543835	CPE14-PRS-3/8-7
	8			757	543836	CPE14-PRS-3/8-8
	9			843	543837	CPE14-PRS-3/8-9
	10			930	543838	CPE14-PRS-3/8-10

1) Corrosion resistance class 2 as per Festo standard 940 070

Components subject to moderate corrosion stress. Externally visible parts with primarily decorative surface requirements which are in direct contact with a normal industrial environment or media such as coolants or lubricating agents.

Ordering data			
	Material	Part No.	Type
Blanking plate for vacant positions			
	Polyamide	544480	CPE14-RP
Retainer set			
	Retainer: High-alloy stainless steel Screws: Galvanised steel Seals: Nitrile rubber	544395	CPE14-H5-SET

Ordering data			
	Material	Part No.	Type
Retainer			
	Retainer: High-alloy stainless steel (Packaging unit 50 pieces)	547046	CPE14-H5-50
Screws			
	Galvanised steel (Packaging unit 100 pieces)	547049	M3X45-8.8-VS-100
Seals			
	Nitrile rubber (Packaging unit 150 pieces)	547052	CPV14-VI-P.1/8-150

Manifold blocks CPE14

Technical data – Fixed-grid manifold block



Manifold block
for CPE14 3/2

Material:
Wrought aluminium alloy
RoHS-compliant



Dimensions – Fixed-grid manifold 3/2

Download CAD data → www.festo.com

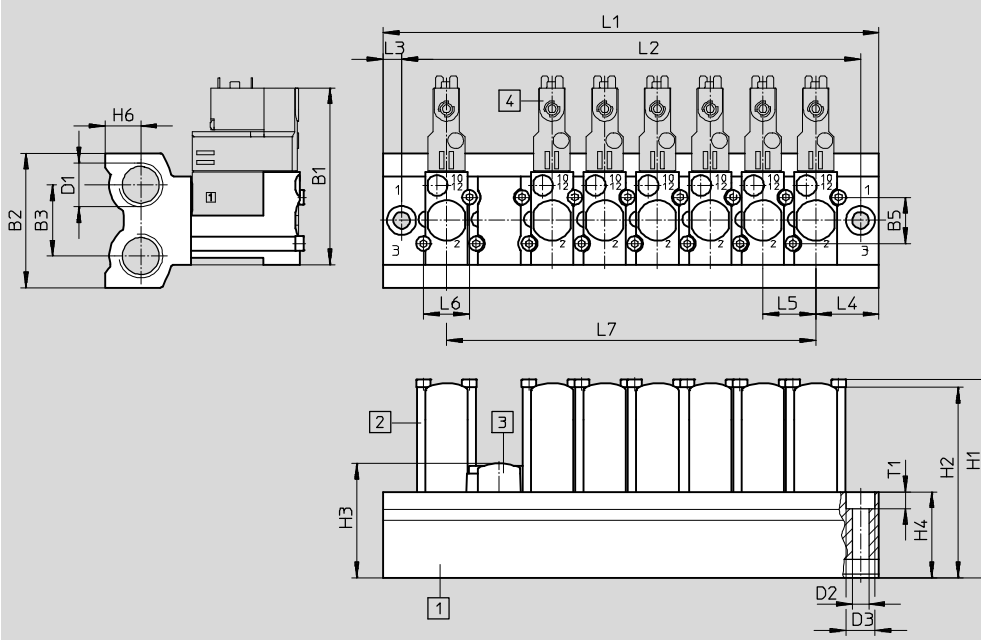

- 1 Manifold block
– Grid dimension 20 mm
- 2 Retainer
- 3 Blanking plate
- 4 Valves

Type	B1	B2	B3	B5	D1	D2	D3	H1	H2	H3	H4	H6
CPE14-3/2-PRS...	67	51	27	17.5	G3/8	6.3	11	75.2	72.2	43.3	32.5	13.5

Type	L1	L2	L3	L4	L5	L6	L7	T1
CPE14-3/2-PRS...	48 + (n-1) x 20	34 + (n-1) x 20	7	24	20	17.4	(n-1) x 20	6.3

Manifold blocks CPE14

Ordering data – Fixed-grid manifold block

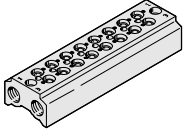

FESTO

Ordering data						
	Valve positions	CRC	Max. tightening torque of valve mounting [Nm]	Weight [g]	Part No.	Type
Manifold block for 3/2-way valves						
	2	2 ¹⁾	1.2	176	550559	CPE14-3/2-PRS-3/8-2
	3			228	550560	CPE14-3/2-PRS-3/8-3
	4			280	550561	CPE14-3/2-PRS-3/8-4
	5			332	550562	CPE14-3/2-PRS-3/8-5
	6			384	550563	CPE14-3/2-PRS-3/8-6
	7			436	550564	CPE14-3/2-PRS-3/8-7
	8			488	550565	CPE14-3/2-PRS-3/8-8
	9			540	550566	CPE14-3/2-PRS-3/8-9
	10			592	550567	CPE14-3/2-PRS-3/8-10

1) Corrosion resistance class 2 as per Festo standard 940 070

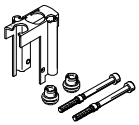
Components subject to moderate corrosion stress. Externally visible parts with primarily decorative surface requirements which are in direct contact with a normal industrial environment or media such as coolants or lubricating agents.

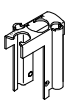
Ordering data			
	Material	Part No.	Type
Blanking plate			
	Polyamide	550581	CPE14-RP3
Retainer set			
	Retainer: High-alloy stainless steel Screws: Galvanised steel Seals: Nitrile rubber	550578	CPE14-H3-SET

Ordering data			
	Material	Part No.	Type
Retainer			
	Retainer: High-alloy stainless steel (Packaging unit 50 pieces)	551491	CPE14-H3-50
Screws			
	Galvanised steel (Packaging unit 100 pieces)	547049	M3X45-8.8-VS-100
Seals			
	Nitrile rubber (Packaging unit 150 pieces)	547052	CPV14-VI-P.1/8-150

1) Packaging unit quantity

Manifold blocks CPE14

Technical data – Modular manifold

Modular manifold block
for CPE14 5/2 and 5/3

Material:
Reinforced polyamide

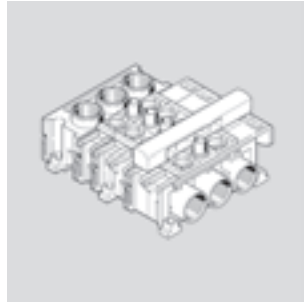

Dimensions – Modular manifold block

Download CAD data → www.festo.com

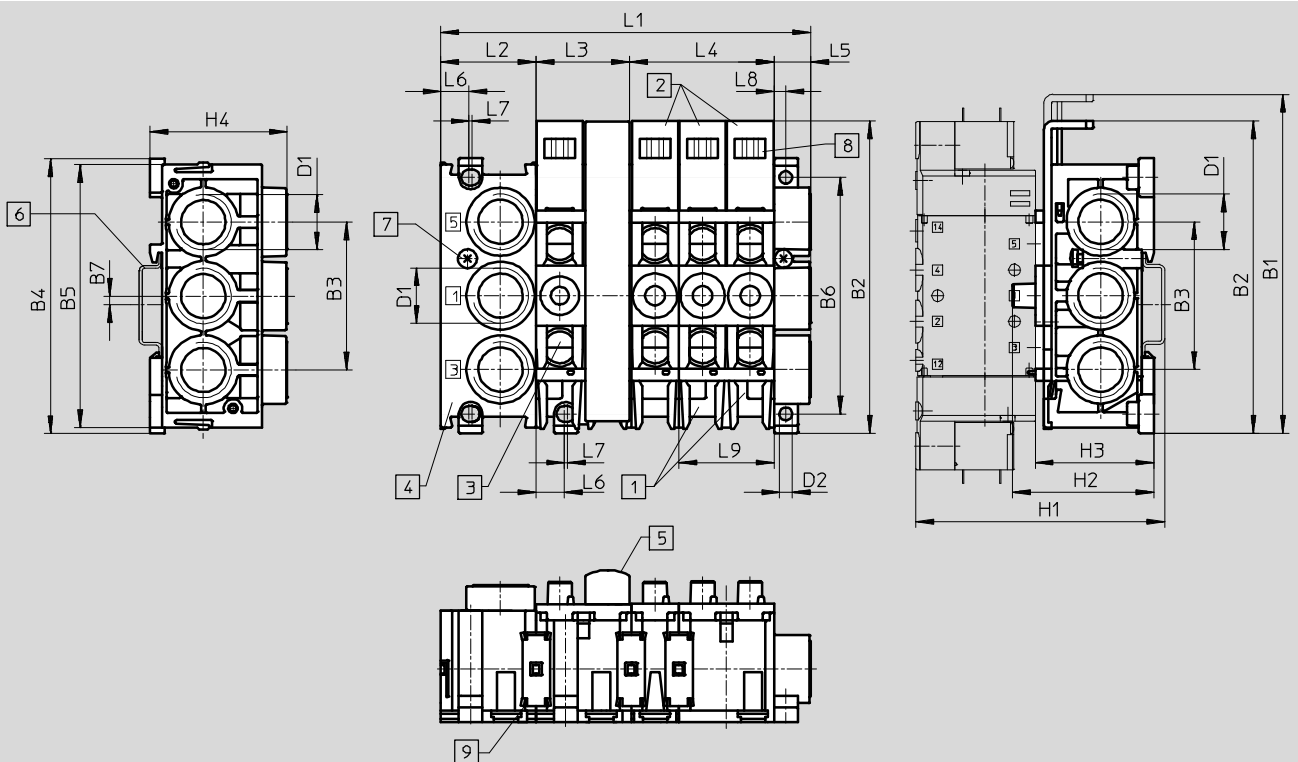

- | | | | |
|--|---|--|--|
| 1) Manifold block
CPE...-PRSG...-2 for 2 valves | 3) Expansion block
CPE...-PRSE...-2 for 2 valves | 6) H-rail to EN 50 002
for mounting | 8) Location for inscription label
type IBS 6 x 10 |
| 2) Manifold block
CPE...-PRSG...-3 for 3 valves | 4) End block CPE...-PRS-EP | 7) Locking screw for H-rail | 9) Connecting piece |
| 5) Blanking plate CPE...-PRSB | | | |

Size	B1	B2	B3	B4	B5	B6	B7	D1	D2 Ø	H1	H2	H3
CPE14	114.6	105.6	50	93	89	80	3	G ³ / ₈	4.3	~84	~48	~40

Size	H4	L1 ¹⁾	L2	L3	L4	L5	L6	L7	L8	L9
CPE14	46.4	32+(nx16)+12.4	32	32	48	12.4	10.1	-	4	32

1) n = Number of valve positions

Manifold blocks CPE14

Technical data – Modular manifold



Possible combinations			
Number of valve positions	One pressure zone	Two pressure zones	
		Variant 1	Variant 2
2	1x CPE...-PRSG-2	–	–
3	1x CPE...-PRSG-3	–	–
4	1x CPE...-PRSGO-2 1x CPE...-PRSE-2	1x CPE...-PRSG-2 1x CPE...-PRSEO-2 1x CPE...-PRS-EP	–
5	1x CPE...-PRSGO-3 1x CPE...-PRSE-2	1x CPE...-PRSG-3 1x CPE...-PRSEO-2 1x CPE...-PRS-EP	–
6	1x CPE...-PRSGO-2 1x CPE...-PRSEO-2 1x CPE...-PRSE-2	1x CPE...-PRSG-2 2x CPE...-PRSEO-2 1x CPE...-PRS-EP	1x CPE...-PRSGO-2 1x CPE...-PRSE-2 1x CPE...-PRSEO-2 1x CPE...-PRS-EP
7	1x CPE...-PRSGO-3 2x CPE...-PRSEO-2 1x CPE...-PRS-EP	1x CPE...-PRSG-3 2x CPE...-PRSEO-2 1x CPE...-PRS-EP	1x CPE...-PRSGO-3 1x CPE...-PRSE-2 1x CPE...-PRSEO-2 1x CPE...-PRS-EP
8	1x CPE...-PRSGO-2 3x CPE...-PRSEO-2 1x CPE...-PRS-EP	1x CPE...-PRSG-2 3x CPE...-PRSEO-2 1x CPE...-PRS-EP	1x CPE...-PRSGO-2 1x CPE...-PRSE-2 2x CPE...-PRSEO-2 1x CPE...-PRS-EP
9	1x CPE...-PRSGO-3 3x CPE...-PRSEO-2 1x CPE...-PRS-EP	1x CPE...-PRSG-3 3x CPE...-PRSEO-2 1x CPE...-PRS-EP	1x CPE...-PRSGO-3 1x CPE...-PRSE-2 2x CPE...-PRSEO-2 1x CPE...-PRS-EP
10	1x CPE...-PRSGO-2 4x CPE...-PRSEO-2 1x CPE...-PRS-EP	1x CPE...-PRSG-2 4x CPE...-PRSEO-2 1x CPE...-PRS-EP	1x CPE...-PRSGO-2 1x CPE...-PRSE-2 3x CPE...-PRSEO-2 1x CPE...-PRS-EP
11	1x CPE...-PRSGO-3 4x CPE...-PRSEO-2 1x CPE...-PRS-EP	1x CPE...-PRSG-3 4x CPE...-PRSEO-2 1x CPE...-PRS-EP	1x CPE...-PRSGO-3 1x CPE...-PRSE-2 3x CPE...-PRSEO-2 1x CPE...-PRS-EP
12	1x CPE...-PRSGO-2 5x CPE...-PRSEO-2 1x CPE...-PRS-EP	1x CPE...-PRSG-2 5x CPE...-PRSEO-2 1x CPE...-PRS-EP	1x CPE...-PRSGO-2 1x CPE...-PRSE-2 4x CPE...-PRSEO-2 1x CPE...-PRS-EP

 Note
 A maximum of 6 valve positions are possible per air supply.
 Use valve manifold blocks only in combination with 5/2-way and 5/3-way valves.

Manifold blocks CPE14

Ordering data – Modular manifold

FESTO

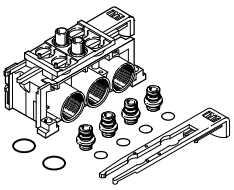
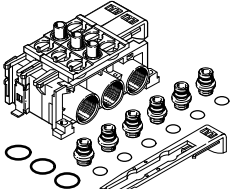
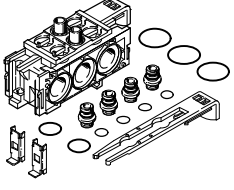
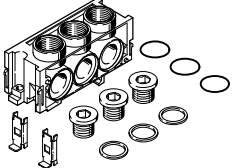
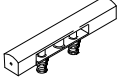
Ordering data					
	Ports 1, 3, 5	PRS ducts	Weight [g]	Part No.	Type
Manifold block PRSG for 2 valves					
	G $\frac{3}{8}$	Closed	95	164965	CPE14-PRSG-2
	G $\frac{3}{8}$	Open	95	187829	CPE14-PRSGO-2
Manifold block PRSG for 3 valves					
	G $\frac{3}{8}$	Closed	130	187824	CPE14-PRSG-3
	G $\frac{3}{8}$	Open	130	187820	CPE14-PRSGO-3
Manifold block PRSE for 2 valves					
	–	Closed	85	164967	CPE14-PRSE-2
	–	Open	85	187830	CPE14-PRSEO-2
End plate for manifold					
	G $\frac{3}{8}$	–	80	164969	CPE14-PRS-EP
Blanking plate for vacant positions					
	–	–	15	164968	CPE14-PRSB

Solenoid valves CPE18

Technical data

Functions:

3/2G, 3/2O



5/2-way single solenoid

5/2-way double solenoid

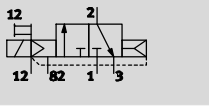
5/3G, 5/3B, 5/3E



3/2G with external pilot air supply, normally closed

-  - Width 18 mm
-  - Flow rate
850 ... 1,500 l/min
-  - Voltage for complete valves
24 V DC, 110, 230 V AC
basic valves
12, 24 V DC, 24, 110, 230 V AC

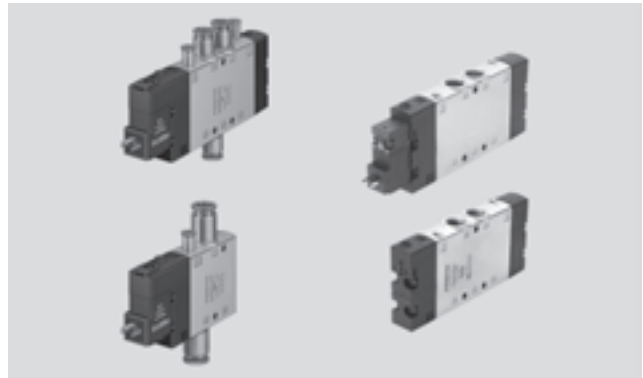

General technical data							
Valve function	3/2		5/2		5/3		
Normal position	G ¹⁾	O ²⁾	-		G ¹⁾	B ²⁾	E ³⁾
Memory stability	Single solenoid			Double solenoid	Single solenoid		
Pneumatic spring reset method	Yes			-	No		
Mechanical spring reset method	No			-	Yes		
Design	Piston spool						
Sealing principle	Soft						
Actuation type	Electric						
Control type	Piloted						
Pilot interface	To ISO 15218 or none in the case of integrated pilot valve						
Pilot air supply	Internal or external						
Direction of flow	-		Reversible with external pilot air supply				
Exhaust function	-		Flow control				
Manual override	Non-detenting, detenting via accessory						
Type of mounting	Using through holes						
Mounting position	Any						
Pneumatic connection	1, 2, 4	Threaded connection: G ¹ / ₄ ; QS connection: Ø 8 or Ø 10 mm					
	3, 5	Threaded connection: G ¹ / ₄					
	12, 14	Threaded connection: M5; QS connection: Ø 4					
	82, 84	Threaded connection: M5					
Nominal diameter	[mm]	8					
Standard nominal flow rate	G ¹ / ₄	[l/min]	1,300	1,300	1,450	1,200	1,300
Standard nominal flow rate	QS8	[l/min]	850				780
Standard nominal flow rate	QS10	[l/min]	1,000			1,050	1,000
Switching time on/off	[ms]	28/18, 36/30 ⁵⁾	26/20, 32/30 ⁵⁾	-	20/38, 20/34 ⁵⁾		
Changeover time	[ms]	-			13, 15 ⁵⁾	-	
Duty cycle	[%]	100					
Width	[mm]	18					
Conforms to	ISO 15218 in the case of interface with pilot valve						
Corrosion resistance class	CRC	2 ⁴⁾					

1) G = Normally closed
 2) O, B = Normally open
 3) E = Normally exhausted
 4) Corrosion resistance class 2 as per Festo standard 940 070
 Components subject to moderate corrosion stress. Externally visible parts with primarily decorative surface requirements which are in direct contact with a normal industrial environment or media such as coolants or lubricating agents.
 5) Switching time for basic valve

Solenoid valves CPE18

Technical data

Operating and environmental conditions					
Valve function		3/2	5/2 single solenoid	5/2 double solenoid	5/3
Operating medium	Compressed air in accordance with ISO 8573-1:2010 [7:4:4]				
Pilot medium	Compressed air in accordance with ISO 8573-1:2010 [7:4:4]				
Note on operating/pilot medium	Operation with lubricated medium possible (in which case lubricated operation will always be required)				
Operating pressure	Internal pilot air supply	[bar]	2.5 ... 10	2 ... 10	2.5 ... 10
	External pilot air supply	[bar]	-0.9 ... +10		
Pilot pressure		[bar]	2.5 ... 10	2 ... 10	2.5 ... 10
Ambient temperature		[°C]	-5 ... +50		
Temperature of medium		[°C]	-5 ... +50		
Certification for solenoid valves	c UL us - Recognised (OL), Germanischer Lloyd				

Electrical data			
Operating voltage	M1H	[V DC]	24 +10/-15%
	M2H	[V AC]	110 ±10% at 50 ... 60 Hz
	M3H	[V AC]	230 ±10% at 50 ... 60 Hz
Power consumption	M1H	[W]	1.5
	M2H, M3H	[VA]	Pull: 3, hold: 2.4
Protection class with plug socket	IP65 (EN 60529)		

Materials

Sectional view

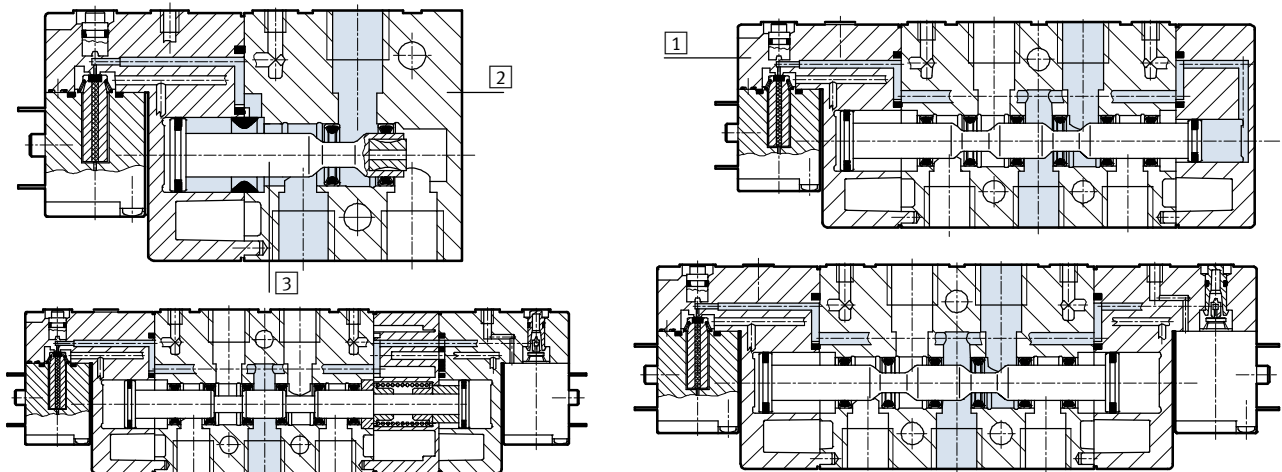

1	Cover	Polyamide
2	Housing	Die-cast aluminium
3	Piston spool	Steel
-	Seals	Nitrile rubber
	Note on materials	RoHS-compliant

Solenoid valves CPE18

Technical data

FESTO

Dimensions – 3/2-way valve

Download CAD data → www.festo.com

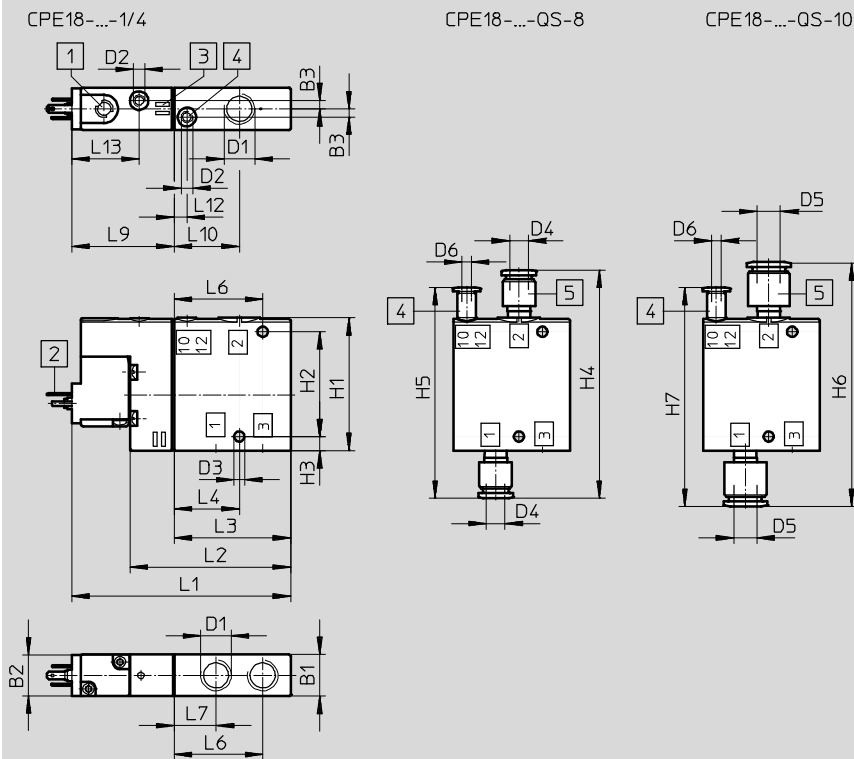

- 1 Manual override
- 2 Connection for plug socket type C
- 3 Location for inscription labels
- 4 Port 10/12 for external pilot air
- 5 QS push-in fitting

Type	B1	B2	B3	D1	D2	D3	D4	D5	D6	H1	H2	H3	H4	H5	H6	H7
CPE18-M1H-3...	18	17.5	3.5	G $\frac{1}{4}$	M5	4.4	8	10	4	57	45	6	98	90.5	105	94

Type	L1	L2	L3	L4	L6	L7	L9	L10	L12	L13
CPE18-M1H-3...	94	69	50	28	38	18	44	28	5.5	29

Solenoid valves CPE18

Technical data

Dimensions – 5/2-way single solenoid valve

Download CAD data → www.festo.com

CPE18-...-1/4

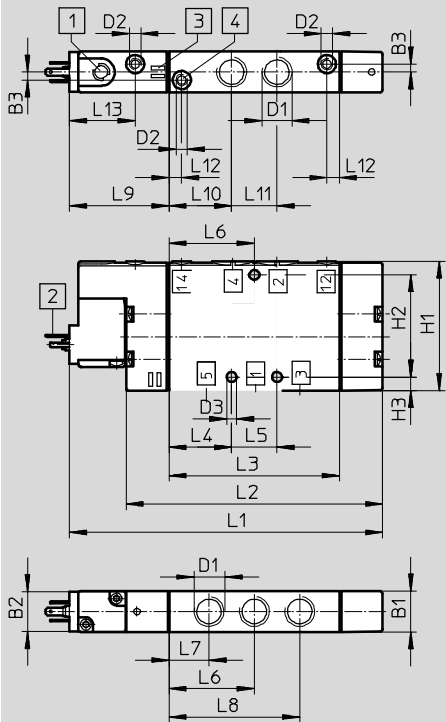

CPE18-...-QS-8

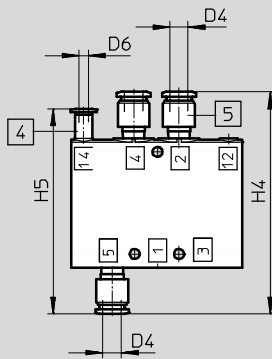

CPE18-...-QS-10

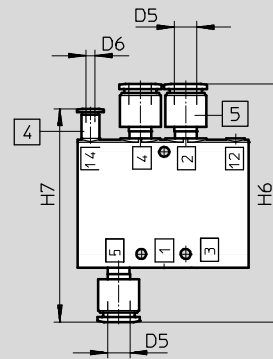

- 1 Manual override
- 2 Connection for plug socket type C
- 3 Location for inscription labels
- 4 Port 10/12 for external pilot air
- 5 QS push-in fitting

Type	B1	B2	B3	D1	D2	D3 ∅	D4 ∅	D5 ∅	D6 ∅	H1	H2	H3	H4	H5	H6	H7
CPE18-M1H-5...	18	17.5	3.5	G $\frac{1}{4}$	M5	4.4	8	10	4	57	45	6	98	90.5	105	94

Type	L1	L2	L3	L4	L5	L6	L7	L8	L9	L10	L11	L12	L13
CPE18-M1H-5...	138	113	75	27.5	20	37.5	17.5	57.5	44	27.5	20	5.5	29

Solenoid valves CPE18

Technical data

FESTO

Dimensions – 5/2-way double solenoid valve

Download CAD data → www.festo.com

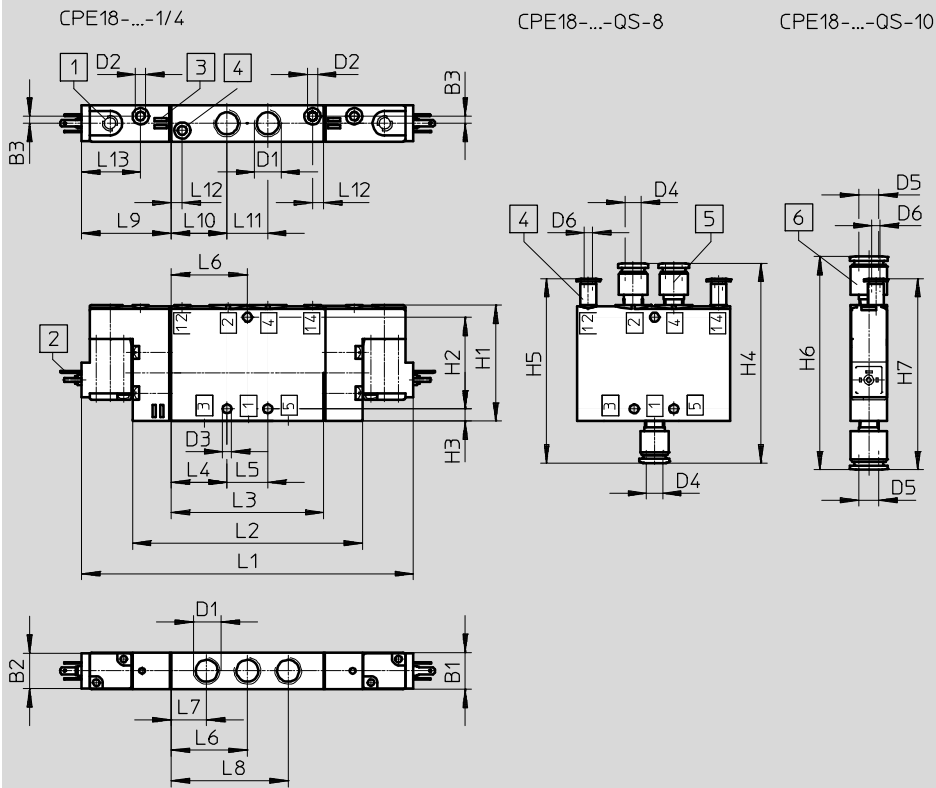

- 1 Manual override
- 2 Connection for plug socket
- 3 Location for inscription labels
- 4 Port 12/14 for external pilot air
- 5/6 QS push-in fitting

Type	B1	B2	B3	D1	D2	D3 ∅	D4 ∅	D5 ∅	D6 ∅	H1	H2	H3	H4	H5	H6	H7
CPE18-...-5J-1/4	18	17.5	3.5	G ¹ / ₄	M5	4.4	8	10	4	57	45	6	98	90.5	105	94

Type	L1	L2	L3	L4	L5	L6	L7	L8	L9	L10	L11	L12	L13
CPE18-...-5J-1/4	163	113	75	27.5	20	37.5	17.5	57.5	44	27.5	20	5.5	29

Solenoid valves CPE18

Technical data

Dimensions – 5/3-way valve

Download CAD data → www.festo.com

CPE18-...-1/4

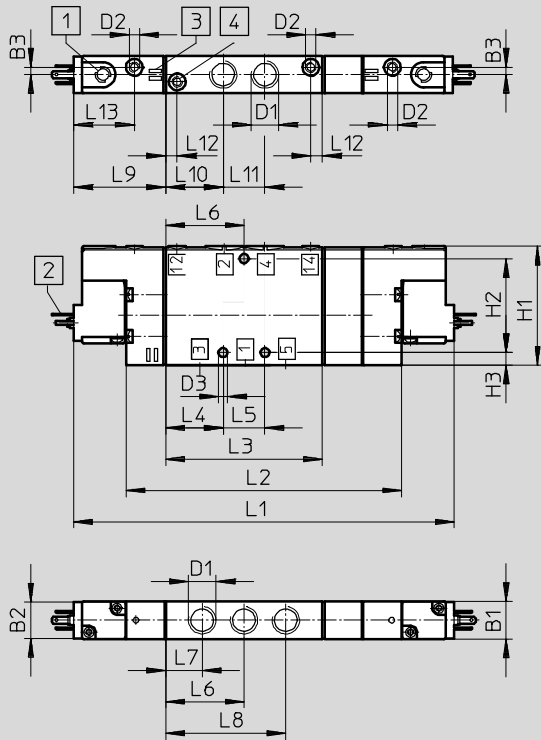

CPE18-...-QS-8

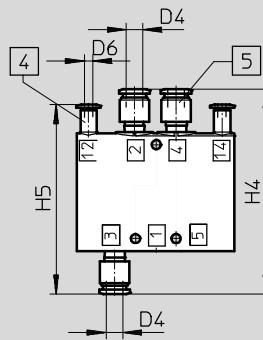

CPE18-...-QS-10

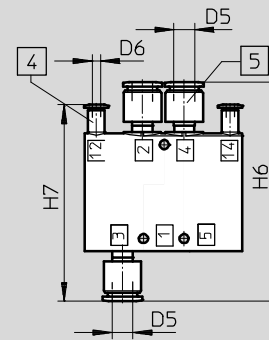

- 1 Manual override
- 2 Connection for plug socket type C
- 3 Location for inscription labels
- 4 Port 12/14 for external pilot air
- 5 QS push-in fitting

Type	B1	B2	B3	D1	D2	D3 ∅	D4 ∅	D5 ∅	D6 ∅	H1	H2	H3	H4	H5	H6	H7
CPE18-M1H...-5L	18	17.5	3.5	G3/4	M5	4.4	8	10	4	57	45	6	98	90.5	105	94
CPE18-M1H...-5/3																

Type	L1	L2	L3	L4	L5	L6	L7	L8	L9	L10	L11	L12	L13
CPE18-M1H...-5J	163	113	75	27.5	20	37.5	17.5	57.5	44	27.5	20	5.5	29
CPE18-M1H...-5/3	182	132											

Solenoid valves CPE18

FESTO

Ordering data

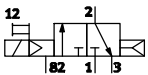
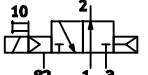
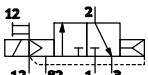
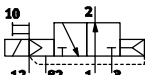
Ordering data – 3/2-way valve						
Circuit symbol	Pilot air supply	Voltage	Connection	Weight [g]	Part No.	Type
Normally closed						
	Internal	24 V DC	G¼	150	163141	CPE18-M1H-3GL-¼
			QS-8	-	163149	CPE18-M1H-3GL-QS-8
			QS-10	-	163157	CPE18-M1H-3GL-QS-10
		110 V AC	G¼	150	163761	CPE18-M2H-3GL-¼
			QS-8	-	163769	CPE18-M2H-3GL-QS-8
			QS-10	-	163777	CPE18-M2H-3GL-QS-10
		230 V AC	G¼	150	163785	CPE18-M3H-3GL-¼
			QS-8	-	163793	CPE18-M3H-3GL-QS-8
			QS-10	-	163801	CPE18-M3H-3GL-QS-10
Normally open						
	Internal	24 V DC	G¼	150	163140	CPE18-M1H-30L-¼
			QS-8	-	163148	CPE18-M1H-30L-QS-8
			QS-10	-	163156	CPE18-M1H-30L-QS-10
		110 V AC	G¼	150	163760	CPE18-M2H-30L-¼
			QS-8	-	163768	CPE18-M2H-30L-QS-8
			QS-10	-	163776	CPE18-M2H-30L-QS-10
		230 V AC	G¼	150	163784	CPE18-M3H-30L-¼
			QS-8	-	163792	CPE18-M3H-30L-QS-8
			QS-10	-	163800	CPE18-M3H-30L-QS-10
Normally closed						
	External	24 V DC	G¼	150	163145	CPE18-M1H-3GLS-¼
			QS-8	-	163153	CPE18-M1H-3GLS-QS-8
			QS-10	-	163161	CPE18-M1H-3GLS-QS-10
		110 V AC	G¼	150	163765	CPE18-M2H-3GLS-¼
			QS-8	-	163773	CPE18-M2H-3GLS-QS-8
			QS-10	-	163781	CPE18-M2H-3GLS-QS-10
		230 V AC	G¼	150	163789	CPE18-M3H-3GLS-¼
			QS-8	-	163797	CPE18-M3H-3GLS-QS-8
			QS-10	-	163805	CPE18-M3H-3GLS-QS-10
Normally open						
	External	24 V DC	G¼	150	163144	CPE18-M1H-30LS-¼
			QS-8	-	163152	CPE18-M1H-30LS-QS-8
			QS-10	-	163160	CPE18-M1H-30LS-QS-10
		110 V AC	G¼	150	163764	CPE18-M2H-30LS-¼
			QS-8	-	163772	CPE18-M2H-30LS-QS-8
			QS-10	-	163780	CPE18-M2H-30LS-QS-10
		230 V AC	G¼	150	163788	CPE18-M3H-30LS-¼
			QS-8	-	163796	CPE18-M3H-30LS-QS-8
			QS-10	-	163804	CPE18-M3H-30LS-QS-10

Solenoid valves CPE18

Ordering data

Ordering data – 5/2-way valve								
Circuit symbol	Pilot air supply	Voltage	Connection	Weight [g]	Part No.	Type		
5/2-way single solenoid valve								
	Internal	24 V DC	G $\frac{1}{4}$	220	163142	CPE18-M1H-5L- $\frac{1}{4}$		
			QS-8	–	163150	CPE18-M1H-5L-QS-8		
			QS-10	–	163158	CPE18-M1H-5L-QS-10		
		110 V AC		G $\frac{1}{4}$	220	163762	CPE18-M2H-5L- $\frac{1}{4}$	
				QS-8	–	163770	CPE18-M2H-5L-QS-8	
				QS-10	–	163778	CPE18-M2H-5L-QS-10	
		230 V AC		G $\frac{1}{4}$	220	163786	CPE18-M3H-5L- $\frac{1}{4}$	
				QS-8	–	163794	CPE18-M3H-5L-QS-8	
				QS-10	–	163802	CPE18-M3H-5L-QS-10	
5/2-way double solenoid valve								
	Internal	24 V DC	G $\frac{1}{4}$	270	163143	CPE18-M1H-5J- $\frac{1}{4}$		
			QS-8	–	163151	CPE18-M1H-5J-QS-8		
			QS-10	–	163159	CPE18-M1H-5J-QS-10		
		110 V AC		G $\frac{1}{4}$	270	163763	CPE18-M2H-5J- $\frac{1}{4}$	
				QS-8	–	163771	CPE18-M2H-5J-QS-8	
				QS-10	–	163779	CPE18-M2H-5J-QS-10	
		230 V AC		G $\frac{1}{4}$	270	163787	CPE18-M3H-5J- $\frac{1}{4}$	
				QS-8	–	163795	CPE18-M3H-5J-QS-8	
				QS-10	–	163803	CPE18-M3H-5J-QS-10	
5/2-way single solenoid valve								
	External	24 V DC	G $\frac{1}{4}$	220	163146	CPE18-M1H-5LS- $\frac{1}{4}$		
			QS-8	–	163154	CPE18-M1H-5LS-QS-8		
			QS-10	–	163162	CPE18-M1H-5LS-QS-10		
		110 V AC		G $\frac{1}{4}$	220	163766	CPE18-M2H-5LS- $\frac{1}{4}$	
				QS-8	–	163774	CPE18-M2H-5LS-QS-8	
				QS-10	–	163782	CPE18-M2H-5LS-QS-10	
		230 V AC		G $\frac{1}{4}$	220	163790	CPE18-M3H-5LS- $\frac{1}{4}$	
				QS-8	–	163798	CPE18-M3H-5LS-QS-8	
				QS-10	–	163806	CPE18-M3H-5LS-QS-10	
5/2-way double solenoid valve								
	External	24 V DC	G $\frac{1}{4}$	270	163147	CPE18-M1H-5JS- $\frac{1}{4}$		
			QS-8	–	163155	CPE18-M1H-5JS-QS-8		
			QS-10	–	163163	CPE18-M1H-5JS-QS-10		
		110 V AC		G $\frac{1}{4}$	270	163767	CPE18-M2H-5JS- $\frac{1}{4}$	
				QS-8	–	163775	CPE18-M2H-5JS-QS-8	
				QS-10	–	163783	CPE18-M2H-5JS-QS-10	
		230 V AC		G $\frac{1}{4}$	270	163791	CPE18-M3H-5JS- $\frac{1}{4}$	
				QS-8	–	163799	CPE18-M3H-5JS-QS-8	
				QS-10	–	163807	CPE18-M3H-5JS-QS-10	

Solenoid valves CPE18

Ordering data

Ordering data – 5/3-way valve						
Circuit symbol	Pilot air supply	Voltage	Connection	Weight [g]	Part No.	Type
5/3-way mid-position valve, normally closed						
	Internal	24 V DC	G¼	280	170247	CPE18-M1H-5/3G-¼
			QS-8	–	170253	CPE18-M1H-5/3G-QS-8
			QS-10	–	170259	CPE18-M1H-5/3G-QS-10
		110 V AC	G¼	280	170283	CPE18-M2H-5/3G-¼
			QS-8	–	170289	CPE18-M2H-5/3G-QS-8
			QS-10	–	170295	CPE18-M2H-5/3G-QS-10
		230 V AC	G¼	280	170319	CPE18-M3H-5/3G-¼
			QS-8	–	170325	CPE18-M3H-5/3G-QS-8
			QS-10	–	170331	CPE18-M3H-5/3G-QS-10
5/3-way mid-position valve, normally exhausted						
	Internal	24 V DC	G¼	280	170249	CPE18-M1H-5/3E-¼
			QS-8	–	170255	CPE18-M1H-5/3E-QS-8
			QS-10	–	170261	CPE18-M1H-5/3E-QS-10
		110 V AC	G¼	280	170285	CPE18-M2H-5/3E-¼
			QS-8	–	170291	CPE18-M2H-5/3E-QS-8
			QS-10	–	170297	CPE18-M2H-5/3E-QS-10
		230 V AC	G¼	280	170321	CPE18-M3H-5/3E-¼
			QS-8	–	170327	CPE18-M3H-5/3E-QS-8
			QS-10	–	170333	CPE18-M3H-5/3E-QS-10
5/3-way mid-position valve, normally open						
	Internal	24 V DC	G¼	280	170251	CPE18-M1H-5/3B-¼
			QS-8	–	170257	CPE18-M1H-5/3B-QS8
			QS-10	–	170263	CPE18-M1H-5/3B-QS10
		110 V AC	G¼	280	170287	CPE18-M2H-5/3B-¼
			QS-8	–	170293	CPE18-M2H-5/3B-QS-8
			QS-10	–	170299	CPE18-M2H-5/3B-QS-10
		230 V AC	G¼	280	170323	CPE18-M3H-5/3B-¼
			QS-8	–	170329	CPE18-M3H-5/3B-QS-8
			QS-10	–	170335	CPE18-M3H-5/3B-QS-10

Solenoid valves CPE18

Ordering data

Ordering data – 5/3-way valve						
Circuit symbol	Pilot air supply	Voltage	Connection	Weight [g]	Part No.	Type
5/3-way mid-position valve, normally closed						
	External	24 V DC	G $\frac{1}{4}$	280	170248	CPE18-M1H-5/3GS- $\frac{1}{4}$
			QS-8	–	170254	CPE18-M1H-5/3GS-QS-8
			QS-10	–	170260	CPE18-M1H-5/3GS-QS-10
		110 V AC	G $\frac{1}{4}$	280	170284	CPE18-M2H-5/3GS- $\frac{1}{4}$
			QS-8	–	170290	CPE18-M2H-5/3GS-QS-8
			QS-10	–	170296	CPE18-M2H-5/3GS-QS10
		230 V AC	G $\frac{1}{4}$	280	170320	CPE18-M3H-5/3GS- $\frac{1}{4}$
			QS-8	–	170326	CPE18-M3H-5/3GS-QS-8
			QS-10	–	170332	CPE18-M3H-5/3GS-QS10
5/3-way mid-position valve, normally exhausted						
	External	24 V DC	G $\frac{1}{4}$	280	170250	CPE18-M1H-5/3ES- $\frac{1}{4}$
			QS-8	–	170256	CPE18-M1H-5/3ES-QS-8
			QS-10	–	170262	CPE18-M1H-5/3ES-QS-10
		110 V AC	G $\frac{1}{4}$	280	170286	CPE18-M2H-5/3ES- $\frac{1}{4}$
			QS-8	–	170292	CPE18-M2H-5/3ES-QS-8
			QS-10	–	170298	CPE18-M2H-5/3ES-QS10
		230 V AC	G $\frac{1}{4}$	280	170322	CPE18-M3H-5/3ES- $\frac{1}{4}$
			QS-8	–	170328	CPE18-M3H-5/3ES-QS-8
			QS-10	–	170334	CPE18-M3H-5/3ES-QS10
5/3-way mid-position valve, normally open						
	External	24 V DC	G $\frac{1}{4}$	280	170252	CPE18-M1H-5/3BS- $\frac{1}{4}$
			QS-8	–	170258	CPE18-M1H-5/3BS-QS-8
			QS-10	–	170264	CPE18-M1H-5/3BS-QS-10
		110 V AC	G $\frac{1}{4}$	280	170288	CPE18-M2H-5/3BS- $\frac{1}{4}$
			QS-8	–	170294	CPE18-M2H-5/3BS-QS-8
			QS-10	–	170300	CPE18-M2H-5/3BS-QS-10
		230 V AC	G $\frac{1}{4}$	280	170324	CPE18-M3H-5/3BS- $\frac{1}{4}$
			QS-8	–	170330	CPE18-M3H-5/3BS-QS-8
			QS-10	–	170336	CPE18-M3H-5/3BS-QS-10

Basic valves CPE18

Technical data – Directional control valves without pilot valve

Materials

Sectional view

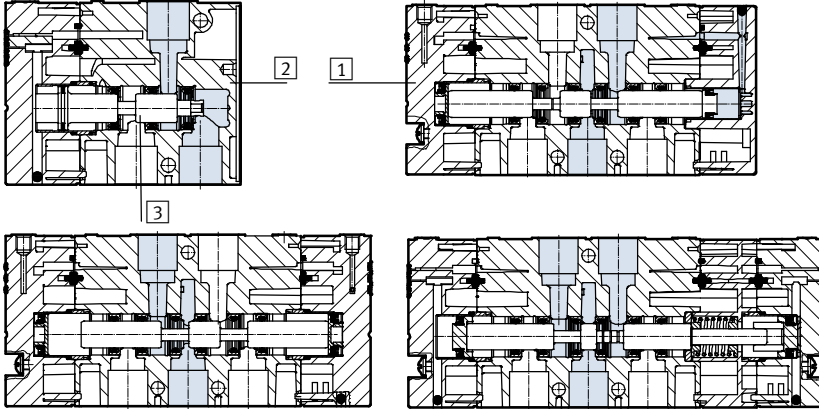

1	Cover	Polyamide
2	Housing	Die-cast aluminium
3	Piston spool	Steel
-	Seals	Nitrile rubber
	Note on materials	RoHS-compliant

Dimensions – 3/2-way valve

Download CAD data → www.festo.com

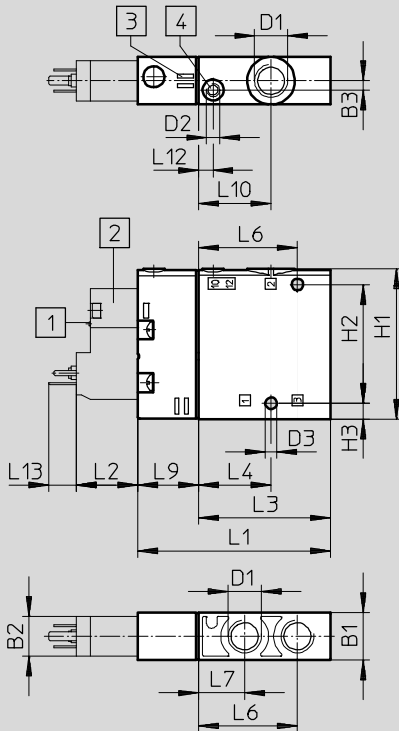

- 1 Manual override
- 2 Pilot valve, type C
- 3 Location for inscription label
- 4 Port 10/12 for external pilot air

Type	B1	B2	B3	D1	D2	D3 Ø	H1	H2	H3	L1	L2	L3	L4	L6	L7	L9	L10	L12	L13
CPE18-P1-3	18	15.2	3.5	G ¹ / ₄	M5	4.4	57	45	6	73	23.3	50	27.5	37.5	17.5	23	27.5	5.5	10.5

Basic valves CPE18

Technical data – Directional control valves without pilot valve

Dimensions – 5/2-way valve

Download CAD data → www.festo.com

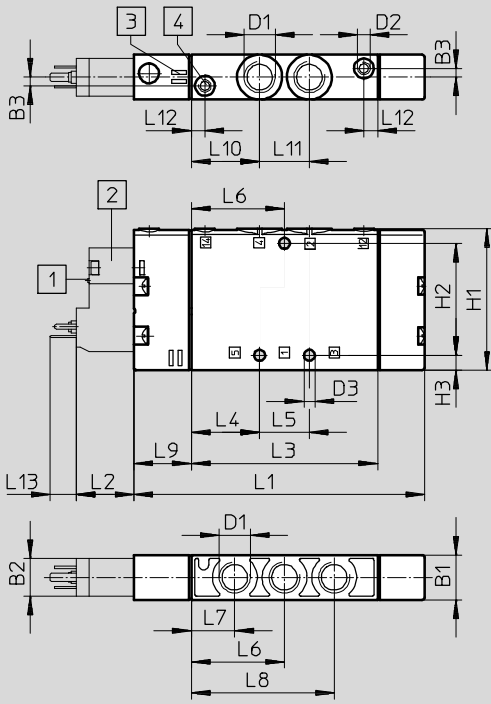

- 1 Manual override
- 2 Pilot valve, type C
- 3 Location for inscription label
- 4 Port 12/14 for external pilot air

Type	B1	B2	B3	D1	D2	D3 ∅	H1	H2	H3	L1	L2	L3	L4	L5	L6	L7	L8	L9	L10	L11	L12	L13
CPE18-P1-5L	18	15.2	3.5	G1/4	M5	4.4	57	45	6	117	23.3	75	27.5	20	37.5	17.5	57.5	23	27.5	20	5.5	10.5

Dimensions – 5/2-way double solenoid valve

Download CAD data → www.festo.com

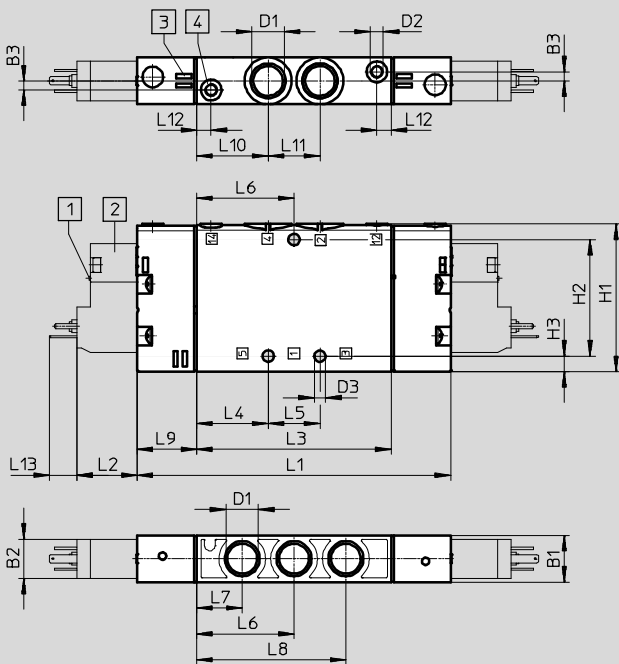

- 1 Manual override
- 2 Pilot valve, type C
- 3 Location for inscription label
- 4 Port 12/14 for external pilot air

Type	B1	B2	B3	D1	D2	D3 ∅	H1	H2	H3	L1	L2	L3	L4	L5	L6	L7	L8	L9	L10	L11	L12	L13
CPE18-P1-5J	18	15.2	3.5	G1/4	M5	4.4	57	45	6	121	23.3	75	27.5	20	37.5	17.5	57.5	23	27.5	20	5.5	10.5

Basic valves CPE18

Technical data – Directional control valves without pilot valve

Dimensions – 5/3-way valve

Download CAD data → www.festo.com

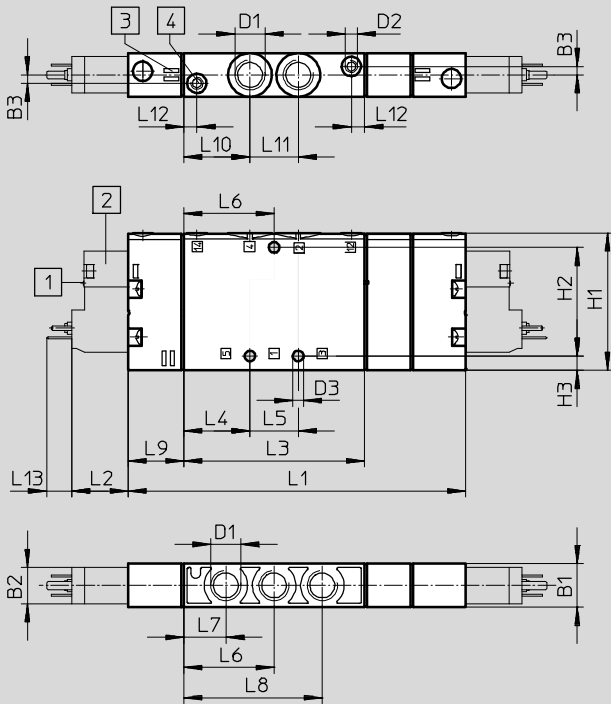

- 1 Manual override
- 2 Pilot valve, type C
- 3 Location for inscription label
- 4 Port 12/14 for external pilot air

Type	B1	B2	B3	D1	D2	D3	H1	H2	H3	L1	L2	L3	L4	L5	L6	L7	L8	L9	L10	L11	L12	L13
CPE18-P1-5]	18	15.2	3.5	G¼	M5	4.4	57	45	6	121	23.3	75	27.5	20	37.5	17.5	57.5	23	27.5	20	5.5	10.5
CPE18-P1-5/3										140												

Basic valves CPE18

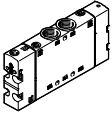

Ordering data

Ordering data – 3/2-way valve without pilot valve					
Design	Normal position	Pilot air supply	Weight [g]	Part No.	Type
	Closed	Internal	110	550163	CPE18-P1-3GL-1/4
	Open			550165	CPE18-P1-3OL-1/4
	Closed	External		550164	CPE18-P1-3GLS-1/4
	Open			550166	CPE18-P1-3OLS-1/4

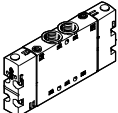
Ordering data – 5/2-way single solenoid valve without pilot valve					
Design		Pilot air supply	Weight [g]	Part No.	Type
		Internal	180	550153	CPE18-P1-5L-1/4
		External		550154	CPE18-P1-5LS-1/4

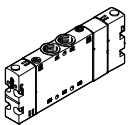
Ordering data – 5/2-way double solenoid valve without pilot valve					
Design		Pilot air supply	Weight [g]	Part No.	Type
		Internal	190	550155	CPE18-P1-5J-1/4
		External		550156	CPE18-P1-5JS-1/4

Ordering data – 5/3-way mid-position valve without pilot valve					
Design	Normal position	Pilot air supply	Weight [g]	Part No.	Type
	Closed	Internal	200	550157	CPE18-P1-5/3G-1/4
	Open			550159	CPE18-P1-5/3E-1/4
	Exhausted			550161	CPE18-P1-5/3B-1/4
	Closed	External		550158	CPE18-P1-5/3GS-1/4
	Open			550160	CPE18-P1-5/3ES-1/4
	Exhausted			550162	CPE18-P1-5/3BS-1/4

Ordering data – Pilot valve to ISO 15218								
Design	Plug, square design	Protective earth conductor	Output		Voltage		Part No.	Type
			[W]	[VA]	[V DC]	[V AC]		
	EN 175301-803, type C	No	1.8	–	24	–	546256	VSCS-B-M32-MH-WA-1C1
		No	1.8	–	12	–	546257	VSCS-B-M32-MH-WA-5C1
	EN 175301-803, type C	Yes	–	2.1	–	230	546260	VSCS-B-M32-MH-WA-3AC1
		Yes	–	2.1	–	110	546259	VSCS-B-M32-MH-WA-2AC1
		No	–	2.3	–	24	546258	VSCS-B-M32-MH-WA-1AC1

Manifold blocks CPE18

Technical data – Fixed-grid manifold block



Manifold block

for CPE18 5/2 and 5/3

Material:

Wrought aluminium alloy

RoHS-compliant



Dimensions – Fixed-grid manifold 5/2 and 5/3

Download CAD data → www.festo.com

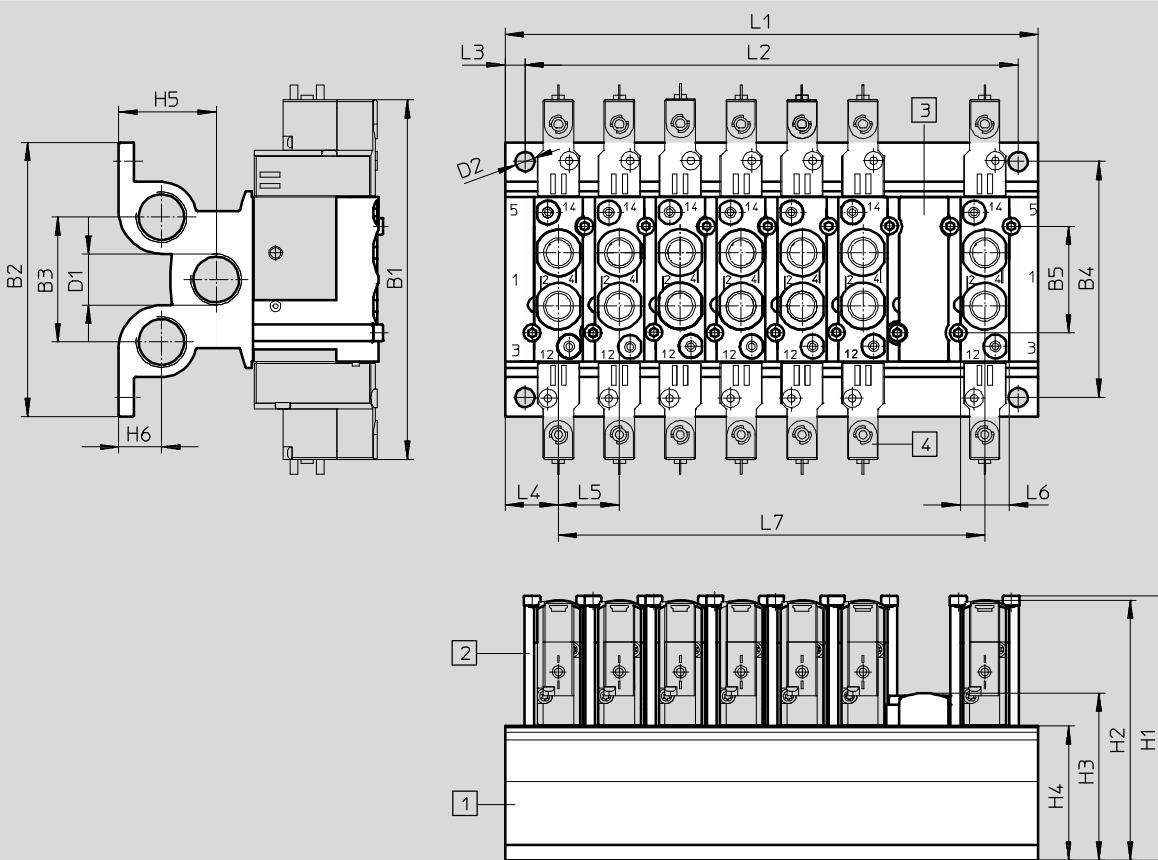

- 1 Manifold block
– Grid dimension 26 mm
- 2 Retainer
- 3 Blanking plate
- 4 Valves

Type	B1	B2	B3	B4	B5	D1	D2	H1	H2	H3	H4	H5
CPE18-PRS...	155	102	46	86,5	40	G $\frac{3}{8}$	8.3	105	101.45	59.8	44	30.5



Type	H6	L1	L2	L3	L4	L5	L6	L7
CPE18-PRS...	14	45 + (n-1) x 26	L1 - 17 ± 0.1	8.5	22.5	26	22.4	(n-1) x 26

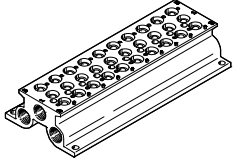

Manifold blocks CPE18

Ordering data – Fixed-grid manifold block

Ordering data						
	Valve positions	CRC	Max. tightening torque of valve mounting [Nm]	Weight [g]	Part No.	Type
Manifold block for 5/2 and 5/3-way valves						
	2	2 ¹⁾	2	353	543839	CPE18-PRS-3/8-2
	3			482	543840	CPE18-PRS-3/8-3
	4			611	543841	CPE18-PRS-3/8-4
	5			740	543842	CPE18-PRS-3/8-5
	6			870	543843	CPE18-PRS-3/8-6
	7			999	543844	CPE18-PRS-3/8-7
	8			1128	543845	CPE18-PRS-3/8-8
	9			1257	543846	CPE18-PRS-3/8-9
	10			1386	543847	CPE18-PRS-3/8-10

1) Corrosion resistance class 2 as per Festo standard 940 070
 Components subject to moderate corrosion stress. Externally visible parts with primarily decorative surface requirements which are in direct contact with a normal industrial environment or media such as coolants or lubricating agents.

Ordering data			
	Material	Part No.	Type
Blanking plate for vacant positions			
	Polyamide	544481	CPE18-RP
Retainer set			
	Retainer: High-alloy stainless steel Screws: Galvanised steel Seals: Nitrile rubber	544396	CPE18-H5-SET

Ordering data			
	Material	Part No.	Type
Retainer			
	Retainer: High-alloy stainless steel (Packaging unit 50 pieces)	547047	CPE18-H5-50
Screws			
	Galvanised steel (Packaging unit 100 pieces)	547050	M4X65-8.8-VS-100
Seals			
	Nitrile rubber (Packaging unit 150 pieces)	547053	CPV18-VI-P.1/4-150

Manifold blocks CPE18

Technical data – Fixed-grid manifold block



Manifold block
for CPE18 3/2

Material:
Wrought aluminium alloy

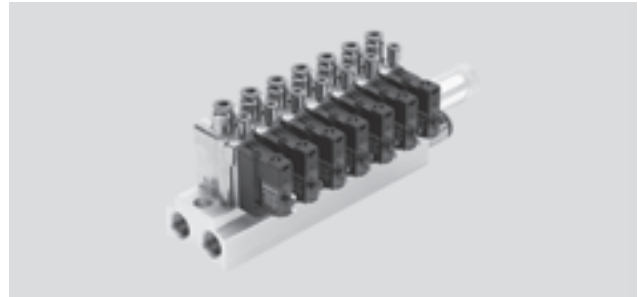

Dimensions – Fixed-grid manifold 3/2

Download CAD data → www.festo.com

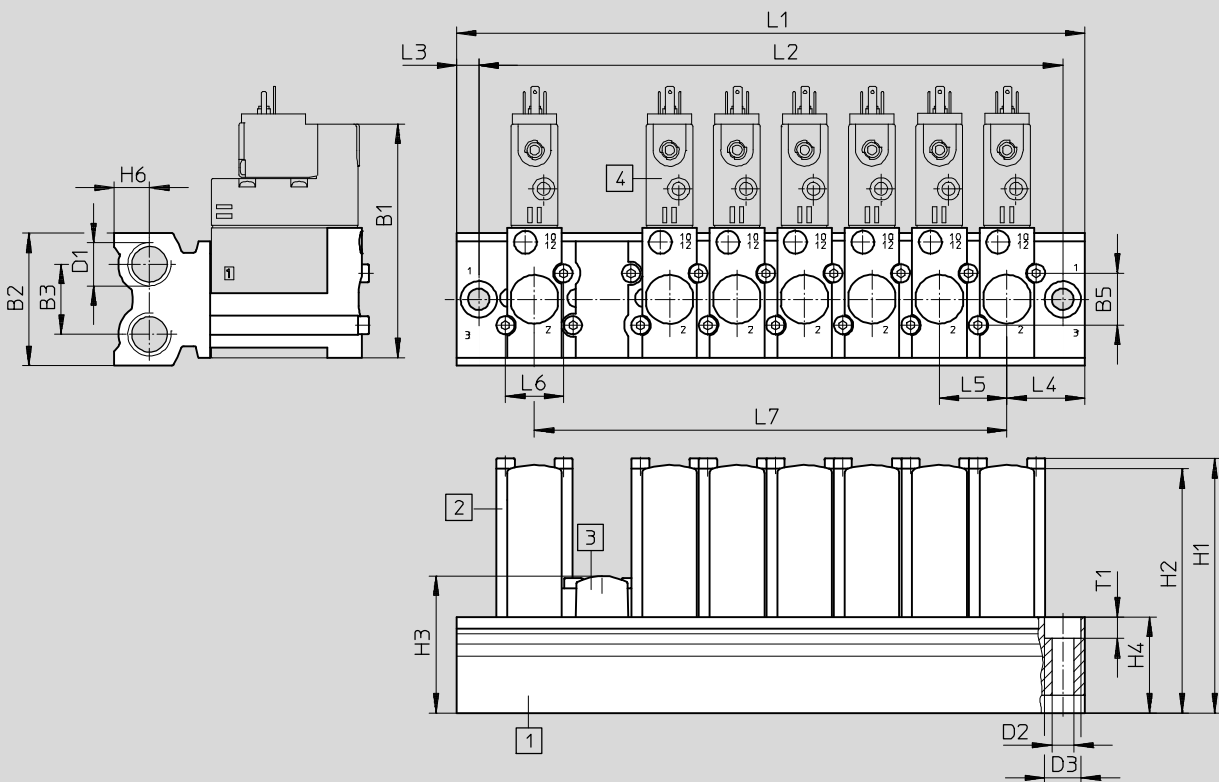

- 1 Manifold block
– Grid dimension 26 mm
- 2 Retainer
- 3 Blanking plate
- 4 Valves

Type	B1	B2	B3	B5	D1	D2	H1	H2	H3	H4	H6
CPE18-3/2-PRS...	90	51	27	200	G ³ / ₈	8.3	98	94	52.8	37	13.5

Type	L1	L2	L3	L4	L5	L6	L7	T1
CPE18-3/2-PRS...	60 + (n-1) x 26	43 + (n-1) x 26	8.5	24	26	22.4	(n-1) x 26	8.3

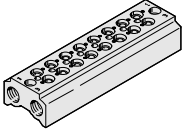

Manifold blocks CPE18

Ordering data – Fixed-grid manifold block

Ordering data						
	Valve positions	CRC	Max. tightening torque of valve mounting [Nm]	Weight [g]	Part No.	Type
Manifold block for 3/2-way valves						
	2	2 ¹⁾	2	266	550568	CPE18-3/2-PRS-3/8-2
	3			346	550569	CPE18-3/2-PRS-3/8-3
	4			426	550570	CPE18-3/2-PRS-3/8-4
	5			507	550571	CPE18-3/2-PRS-3/8-5
	6			587	550572	CPE18-3/2-PRS-3/8-6
	7			667	550573	CPE18-3/2-PRS-3/8-7
	8			748	550574	CPE18-3/2-PRS-3/8-8
	9			828	550575	CPE18-3/2-PRS-3/8-9
	10			908	550576	CPE18-3/2-PRS-3/8-10

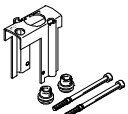
1) Corrosion resistance class 2 as per Festo standard 940 070
 Components subject to moderate corrosion stress. Externally visible parts with primarily decorative surface requirements which are in direct contact with a normal industrial environment or media such as coolants or lubricating agents.

Ordering data			
	Material	Part No.	Type
Blanking plate			
	Polyamide	550582	CPE18-RP3
Retainer set			
	Retainer: High-alloy stainless steel Screws: Galvanised steel Seals: Nitrile rubber	550579	CPE18-H3-SET

Ordering data			
	Material	Part No.	Type
Retainer			
	Retainer: High-alloy stainless steel (Packaging unit 50 pieces)	551492	CPE18-H3-50
Screws			
	Galvanised steel (Packaging unit 100 pieces)	547050	M4X65-8.8-VS-100
Seals			
	Nitrile rubber (Packaging unit 150 pieces)	547053	CPV18-VI-P-1/4-150

1) Packaging unit quantity

Manifold blocks CPE18

Technical data – Modular manifold



Modular manifold block
for CPE18 5/2 and 5/3

Material:
Reinforced polyamide

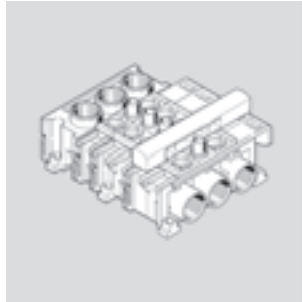

Dimensions – Modular manifold block

Download CAD data → www.festo.com

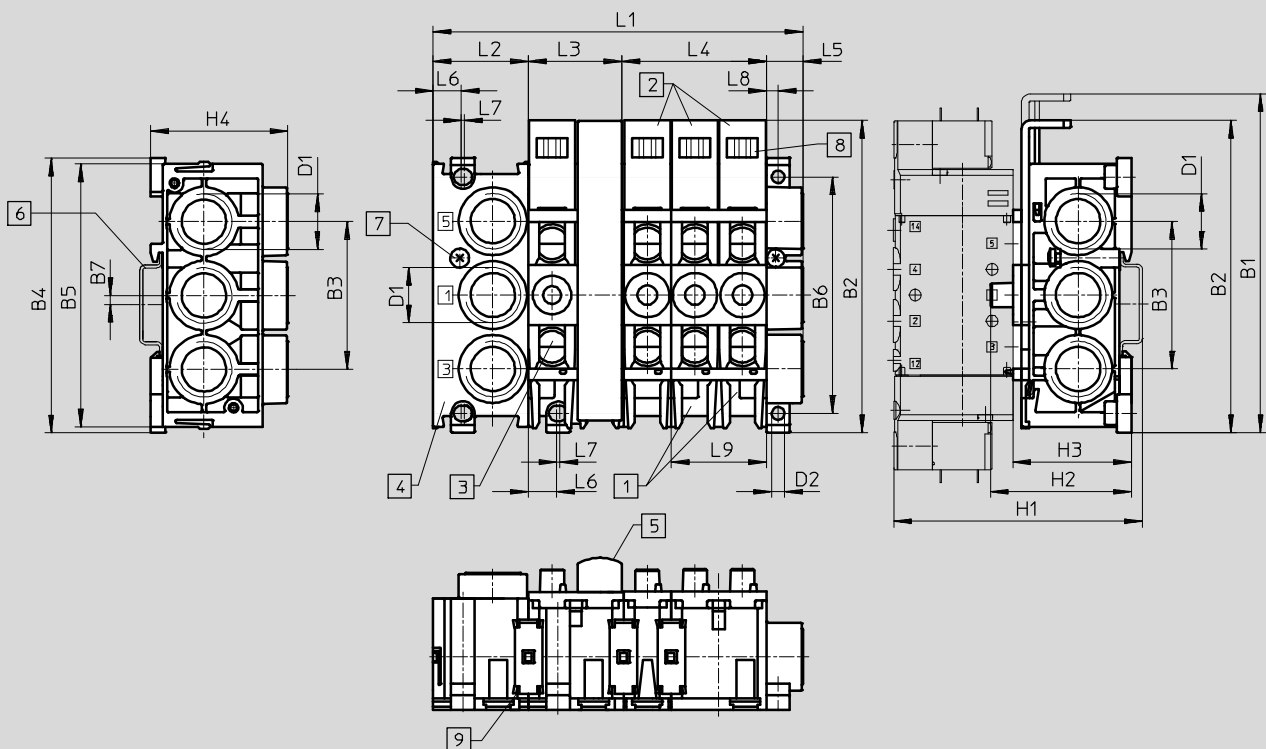

- | | | | |
|--|---|---------------------------------------|--|
| 1) Manifold block
CPE...-PRSG...-2 for 2 valves | 3) Expansion block
CPE...-PRSE...-2 for 2 valves | 6) H-rail to EN 50002
for mounting | 8) Location for inscription label
type IBS 6 x 10 |
| 2) Manifold block
CPE...-PRSG...-3 for 3 valves | 4) End block CPE...-PRS-EP | 7) Locking screw for H-rail | 9) Connecting piece |
| | 5) Blanking plate CPE...-PRSB | | |

Size	B1	B2	B3	B4	B5	B6	B7	D1	D2	H1	H2	H3
CPE18	151.6	136.5	59	113	–	100	2.75	G½	5.3	~106	~58	~46

Size	H4	L1 ¹⁾	L2	L3	L4	L5	L6	L7	L8	L9
CPE18	51.4	40+(nx20)+16.4	40	40	60	16.4	12.6	1	5.2	40

1) n = Number of valve positions

Manifold blocks CPE18

Technical data – Modular manifold

Possible combinations			
Number of valve positions	One pressure zone	Two pressure zones	
		Variant 1	Variant 2
2	1x CPE...-PRSG-2	–	–
3	1x CPE...-PRSG-3	–	–
4	1x CPE...-PRSGO-2 1x CPE...-PRSE-2	1x CPE...-PRSG-2 1x CPE...-PRSEO-2 1x CPE...-PRS-EP	–
5	1x CPE...-PRSGO-3 1x CPE...-PRSE-2	1x CPE...-PRSG-3 1x CPE...-PRSEO-2 1x CPE...-PRS-EP	–
6	1x CPE...-PRSGO-2 1x CPE...-PRSE-2 1x CPE...-PRSE-2	1x CPE...-PRSG-2 2x CPE...-PRSEO-2 1x CPE...-PRS-EP	1x CPE...-PRSGO-2 1x CPE...-PRSE-2 1x CPE...-PRSEO-2 1x CPE...-PRS-EP
7	1x CPE...-PRSGO-3 2x CPE...-PRSE-2 1x CPE...-PRS-EP	1x CPE...-PRSG-3 2x CPE...-PRSEO-2 1x CPE...-PRS-EP	1x CPE...-PRSGO-3 1x CPE...-PRSE-2 1x CPE...-PRSEO-2 1x CPE...-PRS-EP
8	1x CPE...-PRSGO-2 3x CPE...-PRSE-2 1x CPE...-PRS-EP	1x CPE...-PRSG-2 3x CPE...-PRSEO-2 1x CPE...-PRS-EP	1x CPE...-PRSGO-2 1x CPE...-PRSE-2 2x CPE...-PRSEO-2 1x CPE...-PRS-EP
9	1x CPE...-PRSGO-3 3x CPE...-PRSE-2 1x CPE...-PRS-EP	1x CPE...-PRSG-3 3x CPE...-PRSEO-2 1x CPE...-PRS-EP	1x CPE...-PRSGO-3 1x CPE...-PRSE-2 2x CPE...-PRSEO-2 1x CPE...-PRS-EP
10	1x CPE...-PRSGO-2 4x CPE...-PRSE-2 1x CPE...-PRS-EP	1x CPE...-PRSG-2 4x CPE...-PRSEO-2 1x CPE...-PRS-EP	1x CPE...-PRSGO-2 1x CPE...-PRSE-2 3x CPE...-PRSEO-2 1x CPE...-PRS-EP
11	1x CPE...-PRSGO-3 4x CPE...-PRSE-2 1x CPE...-PRS-EP	1x CPE...-PRSG-3 4x CPE...-PRSEO-2 1x CPE...-PRS-EP	1x CPE...-PRSGO-3 1x CPE...-PRSE-2 3x CPE...-PRSEO-2 1x CPE...-PRS-EP
12	1x CPE...-PRSGO-2 5x CPE...-PRSE-2 1x CPE...-PRS-EP	1x CPE...-PRSG-2 5x CPE...-PRSEO-2 1x CPE...-PRS-EP	1x CPE...-PRSGO-2 1x CPE...-PRSE-2 4x CPE...-PRSEO-2 1x CPE...-PRS-EP

 Note

A maximum of 6 valve positions are possible per air supply.
Use valve manifold blocks only in combination with 5/2- and 5/3-way valves.

Manifold blocks CPE18

Ordering data – Modular manifold

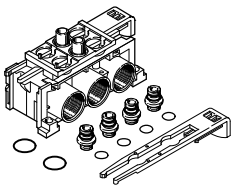
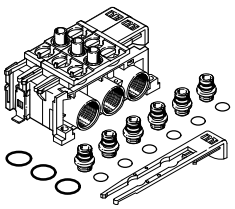
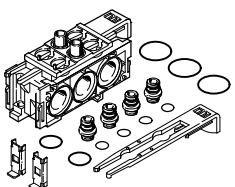
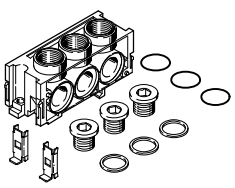
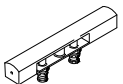
Ordering data					
	Ports 1, 3, 5	PRS ducts	Weight [g]	Part No.	Type
Manifold block PRSG for 2 valves					
	G $\frac{1}{2}$	Closed	170	164970	CPE18-PRSG-2
	G $\frac{1}{2}$	Open	170	187831	CPE18-PRSGO-2
Manifold block PRSG for 3 valves					
	G $\frac{1}{2}$	Closed	225	187825	CPE18-PRSG-3
	G $\frac{1}{2}$	Open	225	187821	CPE18-PRSGO-3
Manifold block PRSE for 2 valves					
	-	Closed	145	164972	CPE18-PRSE-2
	-	Open	145	187832	CPE18-PRSEO-2
End plate for manifold					
	G $\frac{1}{2}$	-	125	164973	CPE18-PRS-EP
Blanking plate for vacant positions					
	-	-	28	164974	CPE18-PRSB

Solenoid valves CPE24

Technical data

Functions:

3/2G, 3/2O



5/2-way single solenoid

5/2-way double solenoid

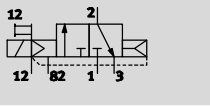
5/3G, 5/3B, 5/3E



3/2G with external pilot air supply, normally closed

-  - Width 24 mm
-  - Flow rate
1,250 ... 3,200 l/min
-  - Voltage
24 V DC, 110, 230 V AC
Basic valve
12, 24 V DC, 24, 110,
230 V AC



General technical data							
Valve function	3/2		5/2			5/3	
Normal position	G ¹⁾	O ²⁾	-	-	-	G ¹⁾	B ²⁾ E ³⁾
Memory stability	Single solenoid			Double solenoid	Single solenoid		
Pneumatic spring reset method	Yes			-	No		
Mechanical spring reset method	No			-	Yes		
Design	Piston spool						
Sealing principle	Soft						
Actuation type	Electric						
Control type	Piloted						
Pilot air supply	Internal or external						
Direction of flow	-		Reversible with external pilot air supply				
Exhaust function	-		Flow control				
Manual override	Non-detenting, detenting via accessory						
Type of mounting	Using through holes						
Mounting position	Any						
Pneumatic connection	1, 2, 4	Threaded connection: G ^{3/8} ; QS connection: Ø 10 or Ø 12 mm					
	3, 5	Threaded connection: G ^{3/8}					
	12, 14	Threaded connection: M5; QS connection: Ø 6					
	82, 84	Threaded connection: M5					
Nominal diameter	[mm]	11					
Standard nominal flow rate	G ^{3/8}	[l/min]	2,500	3,200	3,000	2,600	2,650
	QS10	[l/min]	1,250				
	QS12	[l/min]	1,650				
Switching time	On/off	[ms]	50/33	40/50	-	25/55	
	Changeover	[ms]	-			25	-
Duty cycle	[%]	100					
Width	[mm]	24					
Corrosion resistance class	CRC	2 ⁴⁾					

1) G = Normally closed

2) O, B = Normally open

3) E = Normally exhausted

4) Corrosion resistance class 2 as per Festo standard 940 070

Components subject to moderate corrosion stress. Externally visible parts with primarily decorative surface requirements which are in direct contact with a normal industrial environment or media such as coolants or lubricating agents.

Solenoid valves CPE24

Technical data

Operating and environmental conditions					
Valve function		3/2	5/2 single solenoid	5/2 double solenoid	5/3
Operating medium	Compressed air in accordance with ISO 8573-1:2010 [7:4:4]				
Pilot medium	Compressed air in accordance with ISO 8573-1:2010 [7:4:4]				
Note on operating/pilot medium	Operation with lubricated medium possible (in which case lubricated operation will always be required)				
Operating pressure	Internal pilot air supply	[bar]	2.5 ... 10	2 ... 10	2.5 ... 10
	External pilot air supply	[bar]	-0.9 ... +10		
Pilot pressure		[bar]	2.5 ... 10	2 ... 10	2.5 ... 10
Ambient temperature		[°C]	-5 ... +50		
Temperature of medium		[°C]	-5 ... +50		
Certification	c UL us - Recognised (OL), Germanischer Lloyd				

Electrical data				
Operating voltage	M1H	[V DC]	24 +10/-15%	
	M2H	[V AC]	110 ±10% at 50 ... 60 Hz	
	M3H	[V AC]	230 ±10% at 50 ... 60 Hz	
Power consumption	M1H	[W]	1.5	
	M2H, M3H	[VA]	Pull: 3, hold: 2,4	
Protection class with plug socket	IP65 (EN 60529)			

Materials

Sectional view

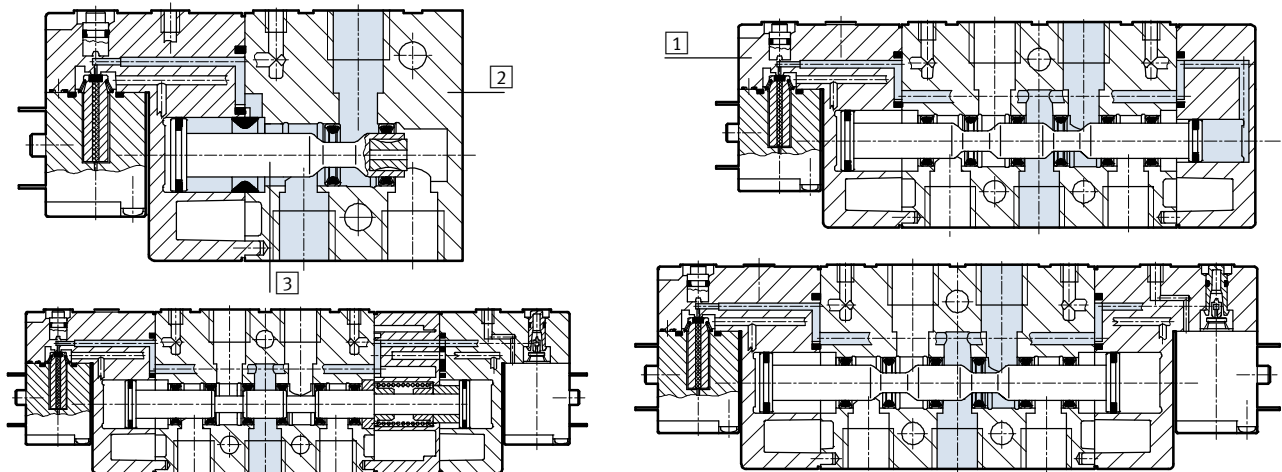

1	Cover	Polyamide
2	Housing	Die-cast aluminium
3	Piston spool	Steel
-	Seals	Nitrile rubber
	Note on materials	RoHS-compliant

Solenoid valves CPE24

Technical data

Dimensions – 3/2-way valve

Download CAD data → www.festo.com

CPE24-...-3/8

CPE24-...-QS-10

CPE24-...-QS-12

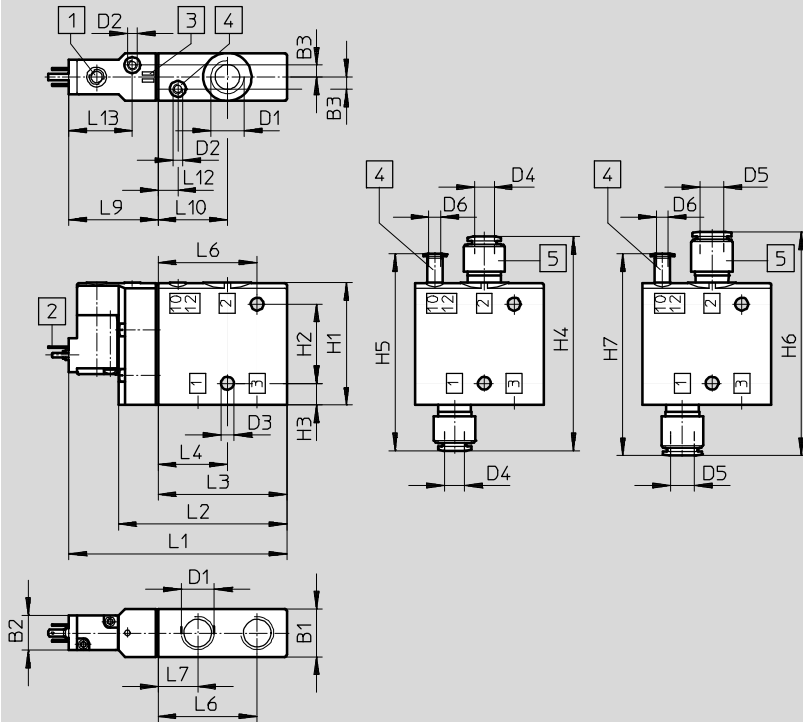

- 1 Manual override
- 2 Connection for plug socket
- 3 Location for inscription labels
- 4 Port 10/12 for external pilot air
- 5 QS push-in fitting

Type	B1 ±0.1	B2 -0.5	B3	D1	D2	D3 ∅	D4 ∅	D5 ∅	D6 ∅	H1 ±0.25	H2	H3 ±0.1	H4	H5	H6	H7
CPE24-M1H-3...	24	17.5	6	G3/8	M5	6.5	10	12	6	62	40	11	108	99.5	113	102

Type	L1	L2	L3 ±0.2	L4 ±0.12	L6 ±0.15	L7 ±0.12	L9	L10	L12 ±0.12	L13
CPE124-M1H-3...	110	85	65	35	50	20	45	35	10	32

Solenoid valves CPE24

Technical data

Dimensions – 5/2-way single solenoid valve

Download CAD data → www.festo.com

CPE24-...-3/8

CPE24-...-QS-10

CPE24-...-QS-12

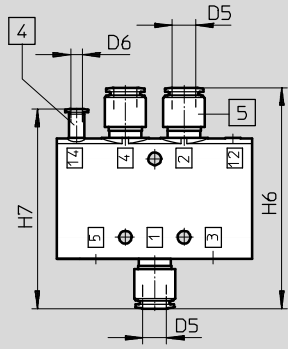
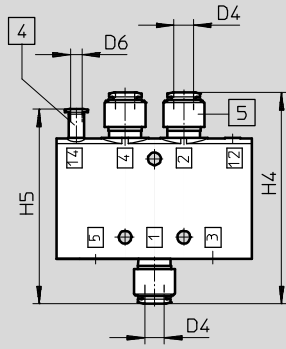
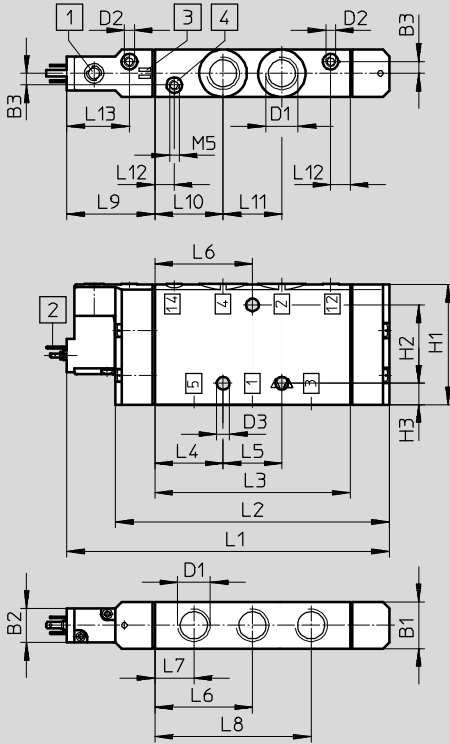

- 1 Manual override
- 2 Connection for plug socket
- 3 Location for inscription labels
- 4 Port 12/14 for external pilot air
- 5 QS push-in fitting

Type	B1	B2	B3	D1	D2	D3 ∅	D4 ∅	D5 ∅	D6 ∅	H1	H2	H3	H4	H5	H6	H7
CPE24-M1H-5L...	24	17.5	6	G3/8	M5	6.5	10	12	6	62	40	11	108	99.5	113	102

Type	L1	L2	L3	L4	L5	L6	L7	L8	L9	L10	L11	L12	L13
CPE24-M1H-5L...	165	140	100	35	30	50	20	80	45	35	30	10	32

Solenoid valves CPE24

Technical data

Dimensions – 5/2-way double solenoid valve

Download CAD data → www.festo.com

Threaded connection

Plug connector

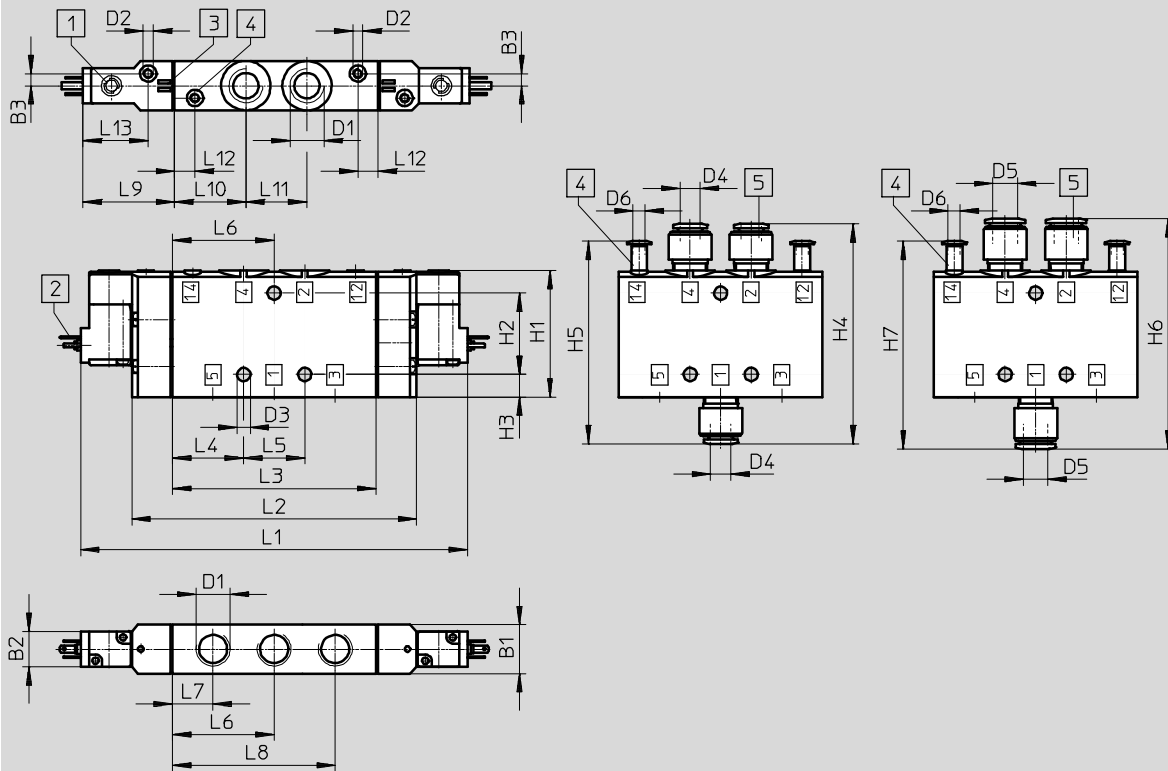

- 1 Manual override
- 2 Connection for plug socket
- 3 Location for inscription labels
- 4 Port 12/14 for external pilot air
- 5 QS push-in fitting

Type	B1	B2	B3	D1	D2	D3 ∅	D4 ∅	D5 ∅	D6 ∅	H1	H2	H3	H4	H5	H6	H7
CPE24-...-5J-3/8	24	17.5	6	G3/8	M5	6.5	10	12	6	62	40	11	108	99.5	113	102

Type	L1	L2	L3	L4	L5	L6	L7	L8	L9	L10	L11	L12	L13
CPE24-...-5J-3/8	190	140	100	35	30	50	20	80	45	35	30	10	32

Solenoid valves CPE24

Technical data



Dimensions – 5/3-way valve

Download CAD data → www.festo.com

CPE24-...-3/8

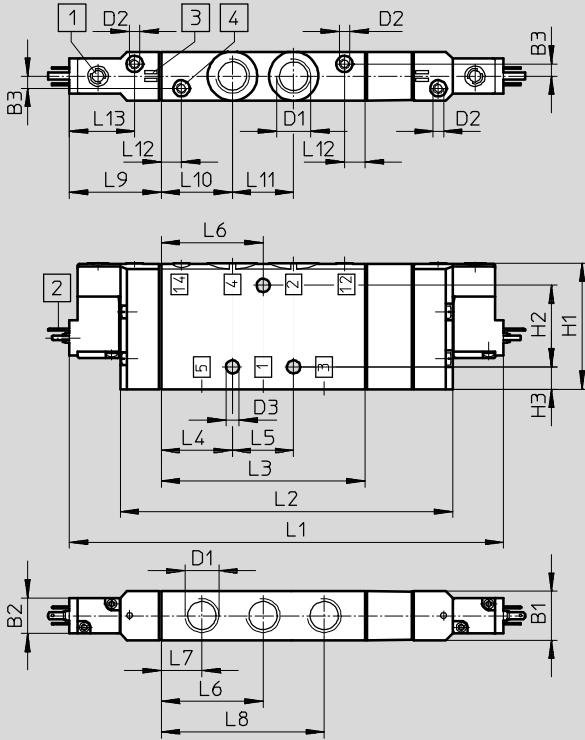

CPE24-...-QS-10

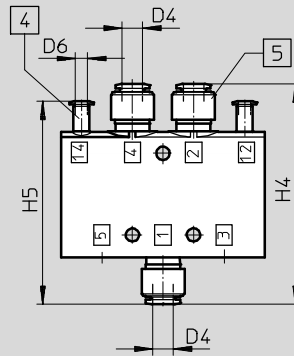

CPE24-...-QS-12

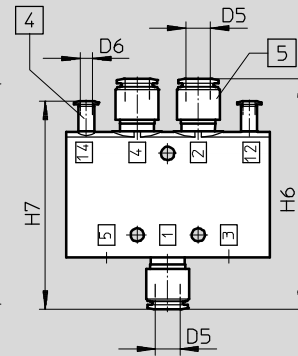

- 1 Manual override
- 2 Connection for plug socket
- 3 Location for inscription labels
- 4 Port 12/14 for external pilot air
- 5 QS push-in fitting

Type	B1 ±0.1	B2 -0.5	B3	D1	D2	D3 ∅	D4 ∅	D5 ∅	D6 ∅	H1 ±0.25	H2	H3 ±0.1	H4	H5	H6	H7
CPE24-M1H...-5	24	17.5	6	G3/8	M5	6.5	10	12	6	62	40	11	108	99.5	113	102
CPE24-M1H...-5/3																

Type	L1	L2	L3 ±0.2	L4 ±0.2	L5	L6	L7 ±0.12	L8 ±0.2	L9	L10 ±0.12	L11	L12 ±0.12	L13
CPE24-M1H...-5J	190	140	100	35	30	50	20	80	45	35	30	10	32
CPE24-M1H...-5/3	213	163											

Solenoid valves CPE24

Ordering data – 3/2-way valve

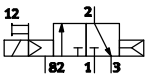
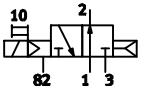
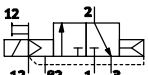
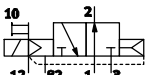
Ordering data									
Circuit symbol	Pilot air supply	Voltage	Connection	Weight [g]	Part No.	Type			
Normally closed									
	Internal	24 V DC	G $\frac{3}{8}$	220	163165	CPE24-M1H-3GL- $\frac{3}{8}$			
			QS-10	-	163173	CPE24-M1H-3GL-QS-10			
			QS-12	-	163181	CPE24-M1H-3GL-QS-12			
		110 V AC	G $\frac{3}{8}$	220			163809	CPE24-M2H-3GL- $\frac{3}{8}$	
					QS-10	-	163817	CPE24-M2H-3GL-QS-10	
					QS-12	-	163825	CPE24-M2H-3GL-QS-12	
		230 V AC	G $\frac{3}{8}$	220			163833	CPE24-M3H-3GL- $\frac{3}{8}$	
					QS-10	-	163841	CPE24-M3H-3GL-QS-10	
					QS-12	-	163849	CPE24-M3H-3GL-QS-12	
Normally open									
	Internal	24 V DC	G $\frac{3}{8}$	220	163164	CPE24-M1H-30L- $\frac{3}{8}$			
			QS-10	-	163172	CPE24-M1H-30L-QS-10			
			QS-12	-	163180	CPE24-M1H-30L-QS-12			
		110 V AC	G $\frac{3}{8}$	220			163808	CPE24-M2H-30L- $\frac{3}{8}$	
					QS-10	-	163816	CPE24-M2H-30L-QS-10	
					QS-12	-	163824	CPE24-M2H-30L-QS-12	
		230 V AC	G $\frac{3}{8}$	220			163832	CPE24-M3H-30L- $\frac{3}{8}$	
					QS-10	-	163840	CPE24-M3H-30L-QS-10	
					QS-12	-	163848	CPE24-M3H-30L-QS-12	
Normally closed									
	External	24 V DC	G $\frac{3}{8}$	220	163169	CPE24-M1H-3GLS- $\frac{3}{8}$			
			QS-10	-	163177	CPE24-M1H-3GLS-QS-10			
			QS-12	-	163185	CPE24-M1H-3GLS-QS-12			
		110 V AC	G $\frac{3}{8}$	220			163813	CPE24-M2H-3GLS- $\frac{3}{8}$	
					QS-10	-	163821	CPE24-M2H-3GLS-QS-10	
					QS-12	-	163829	CPE24-M2H-3GLS-QS-12	
		230 V AC	G $\frac{3}{8}$	220			163837	CPE24-M3H-3GLS- $\frac{3}{8}$	
					QS-10	-	163845	CPE24-M3H-3GLS-QS-10	
					QS-12	-	163853	CPE24-M3H-3GLS-QS-12	
Normally open									
	External	24 V DC	G $\frac{3}{8}$	220	163168	CPE24-M1H-30LS- $\frac{3}{8}$			
			QS-10	-	163176	CPE24-M1H-30LS-QS-10			
			QS-12	-	163184	CPE24-M1H-30LS-QS-12			
		110 V AC	G $\frac{3}{8}$	220			163812	CPE24-M2H-30LS- $\frac{3}{8}$	
					QS-10	-	163820	CPE24-M2H-30LS-QS-10	
					QS-12	-	163828	CPE24-M2H-30LS-QS-12	
		230 V AC	G $\frac{3}{8}$	220			163836	CPE24-M3H-30LS- $\frac{3}{8}$	
					QS-10	-	163844	CPE24-M3H-30LS-QS-10	
					QS-12	-	163852	CPE24-M3H-30LS-QS-12	

Solenoid valves CPE24

Ordering data – 5/2-way valve

Ordering data						
Circuit symbol	Pilot air supply	Voltage	Connection	Weight [g]	Part No.	Type
5/2-way single solenoid valve						
	Internal	24 V DC	G $\frac{3}{8}$	360	163166	CPE24-M1H-5L- $\frac{3}{8}$
			QS-10	-	163174	CPE24-M1H-5L-QS-10
			QS-12	-	163182	CPE24-M1H-5L-QS-12
		110 V AC	G $\frac{3}{8}$	360	163810	CPE24-M2H-5L- $\frac{3}{8}$
			QS-10	-	163818	CPE24-M2H-5L-QS-10
			QS-12	-	163826	CPE24-M2H-5L-QS-12
		230 V AC	G $\frac{3}{8}$	360	163834	CPE24-M3H-5L- $\frac{3}{8}$
			QS-10	-	163842	CPE24-M3H-5L-QS-10
			QS-12	-	163850	CPE24-M3H-5L-QS-12
5/2-way double solenoid valve						
	Internal	24 V DC	G $\frac{3}{8}$	390	163167	CPE24-M1H-5J- $\frac{3}{8}$
			QS-10	-	163175	CPE24-M1H-5J-QS-10
			QS-12	-	163183	CPE24-M1H-5J-QS-12
		110 V AC	G $\frac{3}{8}$	390	163811	CPE24-M2H-5J- $\frac{3}{8}$
			QS-10	-	163819	CPE24-M2H-5J-QS-10
			QS-12	-	163827	CPE24-M2H-5J-QS-12
		230 V AC	G $\frac{3}{8}$	390	163835	CPE24-M3H-5J- $\frac{3}{8}$
			QS-10	-	163843	CPE24-M3H-5J-QS-10
			QS-12	-	163851	CPE24-M3H-5J-QS-12
5/2-way single solenoid valve						
	External	24 V DC	G $\frac{3}{8}$	360	163170	CPE24-M1H-5LS- $\frac{3}{8}$
			QS-10	-	163178	CPE24-M1H-5LS-QS-10
			QS-12	-	163186	CPE24-M1H-5LS-QS-12
		110 V AC	G $\frac{3}{8}$	360	163814	CPE24-M2H-5LS- $\frac{3}{8}$
			QS-10	-	163822	CPE24-M2H-5LS-QS-10
			QS-12	-	163830	CPE24-M2H-5LS-QS-12
		230 V AC	G $\frac{3}{8}$	360	163838	CPE24-M3H-5LS- $\frac{3}{8}$
			QS-10	-	163846	CPE24-M3H-5LS-QS-10
			QS-12	-	163854	CPE24-M3H-5LS-QS-12
5/2-way double solenoid valve						
	External	24 V DC	G $\frac{3}{8}$	390	163171	CPE24-M1H-5JS- $\frac{3}{8}$
			QS-10	-	163179	CPE24-M1H-5JS-QS-10
			QS-12	-	163187	CPE24-M1H-5JS-QS-12
		110 V AC	G $\frac{3}{8}$	390	163815	CPE24-M2H-5JS- $\frac{3}{8}$
			QS-10	-	163823	CPE24-M2H-5JS-QS-10
			QS-12	-	163831	CPE24-M2H-5JS-QS-12
		230 V AC	G $\frac{3}{8}$	390	163839	CPE24-M3H-5JS- $\frac{3}{8}$
			QS-10	-	163847	CPE24-M3H-5JS-QS-10
			QS-12	-	163855	CPE24-M3H-5JS-QS-12

Solenoid valves CPE24

Ordering data – 5/3-way valve

Ordering data						
Circuit symbol	Pilot air supply	Voltage	Connection	Weight [g]	Part No.	Type
5/3-way mid-position valve, normally closed						
	Internal	24 V DC	G $\frac{3}{8}$	430	170265	CPE24-M1H-5/3G- $\frac{3}{8}$
			QS-10	–	170271	CPE24-M1H-5/3G-QS-10
			QS-12	–	170277	CPE24-M1H-5/3G-QS-12
		110 V AC	G $\frac{3}{8}$	430	170301	CPE24-M2H-5/3G- $\frac{3}{8}$
			QS-10	–	170307	CPE24-M2H-5/3G-QS-10
			QS-12	–	170313	CPE24-M2H-5/3G-QS-12
		230 V AC	G $\frac{3}{8}$	430	170337	CPE24-M3H-5/3G- $\frac{3}{8}$
			QS-10	–	170343	CPE24-M3H-5/3G-QS-10
			QS-12	–	170349	CPE24-M3H-5/3G-QS-12
5/3-way mid-position valve, normally exhausted						
	Internal	24 V DC	G $\frac{3}{8}$	430	170267	CPE24-M1H-5/3E- $\frac{3}{8}$
			QS-10	–	170273	CPE24-M1H-5/3E-QS-10
			QS-12	–	170279	CPE24-M1H-5/3E-QS-12
		110 V AC	G $\frac{3}{8}$	430	170303	CPE24-M2H-5/3E- $\frac{3}{8}$
			QS-10	–	170309	CPE24-M2H-5/3E-QS-10
			QS-12	–	170315	CPE24-M2H-5/3E-QS-12
		230 V AC	G $\frac{3}{8}$	430	170339	CPE24-M3H-5/3E- $\frac{3}{8}$
			QS-10	–	170345	CPE24-M3H-5/3E-QS-10
			QS-12	–	170351	CPE24-M3H-5/3E-QS-12
5/3-way mid-position valve, normally open						
	Internal	24 V DC	G $\frac{3}{8}$	430	170269	CPE24-M1H-5/3B- $\frac{3}{8}$
			QS-10	–	170275	CPE24-M1H-5/3B-QS-10
			QS-12	–	170281	CPE24-M1H-5/3B-QS-12
		110 V AC	G $\frac{3}{8}$	430	170305	CPE24-M2H-5/3B- $\frac{3}{8}$
			QS-10	–	170311	CPE24-M2H-5/3B-QS-10
			QS-12	–	170317	CPE24-M2H-5/3B-QS-12
		230 V AC	G $\frac{3}{8}$	430	170341	CPE24-M3H-5/3B- $\frac{3}{8}$
			QS-10	–	170347	CPE24-M3H-5/3B-QS-10
			QS-12	–	170353	CPE24-M3H-5/3B-QS-12





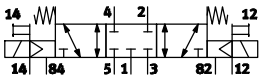
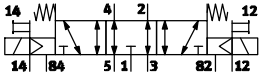
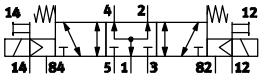

Solenoid valves CPE24

Ordering data – 5/3-way valve

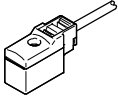
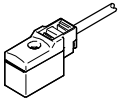
Ordering data – 5/3-way valve								
Circuit symbol	Pilot air supply	Voltage	Connection	Weight [g]	Part No.	Type		
5/3-way mid-position valve, normally closed								
	External	24 V DC	G $\frac{3}{8}$	430	170266	CPE24-M1H-5/3GS- $\frac{3}{8}$		
			QS-10	–	170272	CPE24-M1H-5/3GS-QS-10		
			QS-12	–	170278	CPE24-M1H-5/3GS-QS-12		
		110 V AC	External	24 V DC	G $\frac{3}{8}$	430	170302	CPE24-M2H-5/3GS- $\frac{3}{8}$
					QS-10	–	170308	CPE24-M2H-5/3GS-QS-10
					QS-12	–	170314	CPE24-M2H-5/3GS-QS-12
		230 V AC	External	24 V DC	G $\frac{3}{8}$	430	170338	CPE24-M3H-5/3GS- $\frac{3}{8}$
					QS-10	–	170344	CPE24-M3H-5/3GS-QS-10
					QS-12	–	170350	CPE24-M3H-5/3GS-QS-12
5/3-way mid-position valve, normally exhausted								
	External	24 V DC	G $\frac{3}{8}$	430	170268	CPE24-M1H-5/3ES- $\frac{3}{8}$		
			QS-10	–	170274	CPE24-M1H-5/3ES-QS-10		
			QS-12	–	170280	CPE24-M1H-5/3ES-QS-12		
		110 V AC	External	24 V DC	G $\frac{3}{8}$	430	170304	CPE24-M2H-5/3ES- $\frac{3}{8}$
					QS-10	–	170310	CPE24-M2H-5/3ES-QS-10
					QS-12	–	170316	CPE24-M2H-5/3ES-QS-12
		230 V AC	External	24 V DC	G $\frac{3}{8}$	430	170340	CPE24-M3H-5/3ES- $\frac{3}{8}$
					QS-10	–	170346	CPE24-M3H-5/3ES-QS-10
					QS-12	–	170352	CPE24-M3H-5/3ES-QS-12
5/3-way mid-position valve, normally open								
	External	24 V DC	G $\frac{3}{8}$	430	170270	CPE24-M1H-5/3BS- $\frac{3}{8}$		
			QS-10	–	170276	CPE24-M1H-5/3BS-QS-10		
			QS-12	–	170282	CPE24-M1H-5/3BS-QS-12		
		110 V AC	External	24 V DC	G $\frac{3}{8}$	430	170306	CPE24-M2H-5/3BS- $\frac{3}{8}$
					QS-10	–	170312	CPE24-M2H-5/3BS-QS-10
					QS-12	–	170318	CPE24-M2H-5/3BS-QS-12
		230 V AC	External	24 V DC	G $\frac{3}{8}$	430	170342	CPE24-M3H-5/3BS- $\frac{3}{8}$
					QS-10	–	170348	CPE24-M3H-5/3BS-QS-10
					QS-12	–	170354	CPE24-M3H-5/3BS-QS-12





Solenoid valves CPE, Compact Performance

Ordering data – Accessories for CPE10 and CPE14

Ordering data – Connecting cables and plug sockets with cable for CPE10 and CPE14 with KMYZ solenoid coils					
	Voltage	Cable length [m]	Switching status display with LED	Part No.	Type
Connecting cable with PUR cable, open end				Technical data → Internet: kmyz	
	24 V DC	2.5	■	193687	KMYZ-9-24-2,5-LED-PUR-B
		5	■	193689	KMYZ-9-24-5-LED-PUR-B
		10	■	196063	KMYZ-9-24-10-LED-PUR-B
Connecting cable with PVC cable and pre-assembled plug M8x1					
	24 V DC	0.5	■	196064	KMYZ-9-24-M8-0,5-LED-B
		2.5	■	196065	KMYZ-9-24-M8-2,5-LED-B
Connecting cable M8x1, 4-pin, angled socket/open end					
	24 V DC	2.5	■	562471	NEBV-M8W4L-E-2,5-2
		5	■	562472	NEBV-M8W4L-E-5-2
		10	■	562473	NEBV-M8W4L-E-10-2
Connecting cable M8x1, 4-pin, angled socket/straight plug M8x1, 3-pin					
	24 V DC	2.5	■	562468	NEBV-M8W4L-E-2,5-M8G3
		5	■	562469	NEBV-M8W4L-E-5-M8G3
		10	■	562470	NEBV-M8W4L-E-10-M8G3
Connecting cable M8x1, 4-pin, straight socket/open end				Technical data → Internet: sim	
	24 V DC	2.5	–	164250	SIM-K-4GD-2,5-PU
		5	–	164251	SIM-K-4GD-5-PU
Connecting cable M8x1, 4-pin, angled socket/open end					
	24 V DC	2.5	–	164252	SIM-K-4WD-2,5-PU
		5	–	164253	SIM-K-4WD-5-PU
Adapter					
	Plug M8, 3-pin/socket, 2-pin			571686	VAVE-C8-1R8
	Plug M8, 4-pin/socket, 2-pin			573194	VAVE-C8-1R1

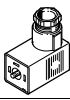
Solenoid valves CPE, Compact Performance

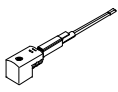
Ordering data – Accessories for CPE18 and CPE24





Ordering data – Plug sockets and plug sockets with cable for CPE18 and CPE24 with EB solenoid coils				
	Voltage	Cable length [m]	Switching status display with LED	Part No. Type
Plug socket without cable				Technical data → Internet: mssd
	–	–	–	151687 MSSD-EB
	–	–	–	539712 MSSD-EB-M12
Plug socket without cable with insulation displacement technology				
	–	–	–	192745 MSSD-EB-S-M14
Plug socket with PVC cable				Technical data → Internet: kmeb
	24 V DC	2.5	■	151688 KMEB-1-24-2,5-LED
	24 V DC	5	■	151689 KMEB-1-24-5-LED
	24 V DC	10	■	193457 KMEB-1-24-10-LED
	Up to 240 V	2.5	–	151690 KMEB-1-230-2,5
	Up to 240 V	5	–	151691 KMEB-1-230-5
Plug socket with PUR cable				
	24 V DC	2.5	■	174844 KMEB-2-24-2,5-LED
	24 V DC	5	■	174845 KMEB-2-24-5-LED
	Up to 240 V	2.5	–	174846 KMEB-2-230-2,5
	Up to 240 V	5	–	174847 KMEB-2-230-5

Ordering data – Illuminating seal for EB solenoid coils				Technical data → Internet: meb-ld	
	Voltage			Part No.	Type
	[V DC]	[V AC]			
	12 ... 24	–	–	151717	MEB-LD-12-24DC
	–	230	–	151718	MEB-LD-230AC

Solenoid valves CPE, Compact Performance

FESTO

Accessories

Ordering data – General accessories				
	Description	Delivery quantity	Part No.	Type
Blanking plugs				Technical data → Internet: b
	For manifold block CPE10	10 pieces	3569	B-1/4
	For manifold block CPE14, CPE18	10 pieces	3570	B-3/8
Separator for pressure zones				Technical data → Internet: vabd
	For manifold block CPE10	1 piece	537515	VABD-B6-14-P-C
	For manifold block CPE14, CPE18	1 piece	160997	PRSV-1/8
Silencer				Technical data → Internet: u
	For M3 thread	20 pieces	1231120	AMTE-M-LH-M3
	For M5 thread	1 piece	165003	UC-M5
	For M7 thread	1 piece	161418	UC-M7
	For G1/8 thread	1 piece	161419	UC-1/8
	For G1/4 thread	1 piece	165004	UC-1/4
Manual override				Technical data → Internet: ahb
	For KMYZ coils	1 piece	157600	AHB-MZB
	For EB coils	1 piece	157601	AHB-MEB
Inscription labels				Technical data → Internet: ibs
	-	64 pieces	18576	IBS-6x10

Solenoid valves CPE, Compact Performance

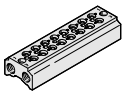

Accessories

Ordering data – Connection block NPT							
	Valve positions	Part No.	Type	Part No.	Type	Part No.	Type
For 5/2- and 5/3-way valves							
	2	550070	CPE10-PRS-1/4-2-NPT	550079	CPE14-PRS-3/8-2-NPT	550088	CPE18-PRS-3/8-2-NPT
	3	550071	CPE10-PRS-1/4-3-NPT	550080	CPE14-PRS-3/8-3-NPT	550089	CPE18-PRS-3/8-3-NPT
	4	550072	CPE10-PRS-1/4-4-NPT	550081	CPE14-PRS-3/8-4-NPT	550090	CPE18-PRS-3/8-4-NPT
	5	550073	CPE10-PRS-1/4-5-NPT	550082	CPE14-PRS-3/8-5-NPT	550091	CPE18-PRS-3/8-5-NPT
	6	550074	CPE10-PRS-1/4-6-NPT	550083	CPE14-PRS-3/8-6-NPT	550092	CPE18-PRS-3/8-6-NPT
	7	550075	CPE10-PRS-1/4-7-NPT	550084	CPE14-PRS-3/8-7-NPT	550093	CPE18-PRS-3/8-7-NPT
	8	550076	CPE10-PRS-1/4-8-NPT	550085	CPE14-PRS-3/8-8-NPT	550094	CPE18-PRS-3/8-8-NPT
	9	550077	CPE10-PRS-1/4-9-NPT	550086	CPE14-PRS-3/8-9-NPT	550095	CPE18-PRS-3/8-9-NPT
	10	550078	CPE10-PRS-1/4-10-NPT	550087	CPE14-PRS-3/8-10-NPT	550096	CPE18-PRS-3/8-10-NPT
	For 3/2-way valves						
	2	550601	CPE10-3/2-PRS-1/4-2-NPT	550610	CPE14-3/2-PRS-3/8-2-NPT	550619	CPE18-3/2-PRS-3/8-2-NPT
	3	550602	CPE10-3/2-PRS-1/4-3-NPT	550611	CPE14-3/2-PRS-3/8-3-NPT	550620	CPE18-3/2-PRS-3/8-3-NPT
	4	550603	CPE10-3/2-PRS-1/4-4-NPT	550612	CPE14-3/2-PRS-3/8-4-NPT	550621	CPE18-3/2-PRS-3/8-4-NPT
	5	550604	CPE10-3/2-PRS-1/4-5-NPT	550613	CPE14-3/2-PRS-3/8-5-NPT	550622	CPE18-3/2-PRS-3/8-5-NPT
	6	550605	CPE10-3/2-PRS-1/4-6-NPT	550614	CPE14-3/2-PRS-3/8-6-NPT	550623	CPE18-3/2-PRS-3/8-6-NPT
	7	550606	CPE10-3/2-PRS-1/4-7-NPT	550615	CPE14-3/2-PRS-3/8-7-NPT	550624	CPE18-3/2-PRS-3/8-7-NPT
	8	550607	CPE10-3/2-PRS-1/4-8-NPT	550616	CPE14-3/2-PRS-3/8-8-NPT	550625	CPE18-3/2-PRS-3/8-8-NPT
	9	550608	CPE10-3/2-PRS-1/4-9-NPT	550617	CPE14-3/2-PRS-3/8-9-NPT	550626	CPE18-3/2-PRS-3/8-9-NPT
	10	550609	CPE10-3/2-PRS-1/4-10-NPT	550618	CPE14-3/2-PRS-3/8-10-NPT	550627	CPE18-3/2-PRS-3/8-10-NPT

Product Range and Company Overview

A Complete Suite and Company Overview

Our experienced engineers provide complete support at every stage of your development process, including: conceptualization, analysis, engineering, design, assembly, documentation, validation, and production.

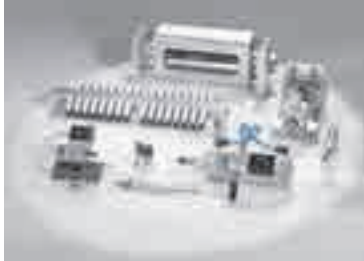

Custom Automation Components
Complete custom engineered solutions



Custom Control Cabinets
Comprehensive engineering support and on-site services



Complete Systems
Shipment, stocking and storage services

The Broadest Range of Automation Components

With a comprehensive line of more than 30,000 automation components, Festo is capable of solving the most complex automation requirements.



Electromechanical
Electromechanical actuators, motors, controllers & drivers



Pneumatics
Pneumatic linear and rotary actuators, valves, and air supply



PLCs and I/O Devices
PLC's, operator interfaces, sensors and I/O devices

Supporting Advanced Automation... As No One Else Can!

Festo is a leading global manufacturer of pneumatic and electromechanical systems, components and controls for industrial automation, with more than 16,000 employees in 60 national headquarters serving more than 180 countries. For more than 80 years, Festo has continuously elevated the state of manufacturing with innovations and optimized motion control solutions that deliver higher performing, more profitable automated manufacturing and processing equipment. Our dedication to the advancement of automation extends beyond technology to the education and development of current and future automation and robotics designers with simulation tools, teaching programs, and on-site services.

Quality Assurance, ISO 9001 and ISO 14001 Certifications

Festo Corporation is committed to supply all Festo products and services that will meet or exceed our customers' requirements in product quality, delivery, customer service and satisfaction.

To meet this commitment, we strive to ensure a consistent, integrated, and systematic approach to management that will meet or exceed the requirements of the ISO 9001 standard for Quality Management and the ISO 14001 standard for Environmental Management.



© Copyright 2013, Festo Corporation. While every effort is made to ensure that all dimensions and specifications are correct, Festo cannot guarantee that publications are completely free of any error, in particular typing or printing errors. Accordingly, Festo cannot be held responsible for the same. For Liability and Warranty conditions, refer to our "Terms and Conditions of Sale", available from your local Festo office. All rights reserved. No part of this publication may be reproduced, distributed, or transmitted in any form or by any means, electronic, mechanical, photocopying or otherwise, without the prior written permission of Festo. All technical data subject to change according to technical update.



Printed on recycled paper at New Horizon Graphic, Inc., FSC certified as an environmental friendly printing plant.

Festo North America

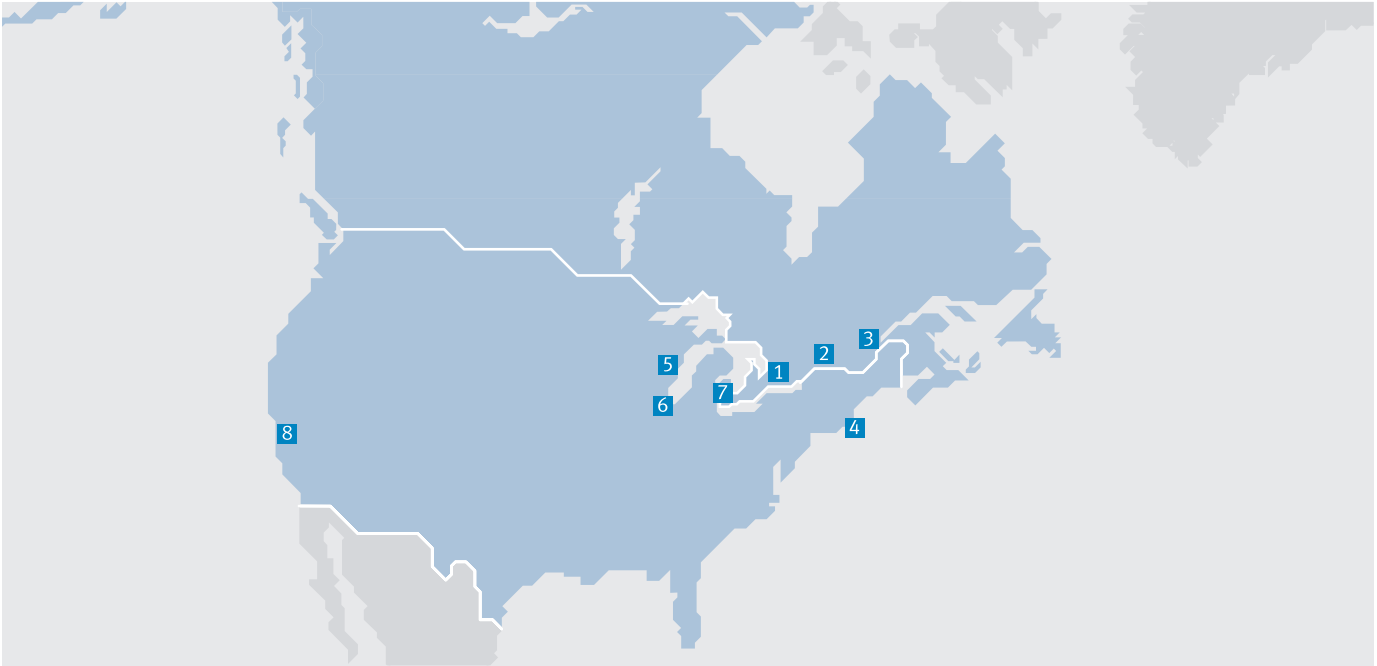

**1 Festo Canada
Headquarters
Festo Inc.**
5300 Explorer Drive
Mississauga, ON
L4W 5G4

2 Montréal
5600, Trans-Canada
Pointe-Claire, QC
H9R 1B6

3 Québec City
2930, rue Watt#117
Québec, QC
G1X 4G3



**4 Festo United States
Headquarters
Festo Corporation**
395 Moreland Road
Hauppauge, NY
11788

5 Appleton
North 922 Tower View Drive, Suite N
Greenville, WI
54942

7 Detroit
1441 West Long Lake Road
Troy, MI
48098

6 Chicago
85 W Algonquin - Suite 340
Arlington Heights, IL
60005

8 Silicon Valley
4935 Southfront Road, Suite F
Livermore, CA
94550

Festo Regional Contact Center

Canadian Customers

Commercial Support:
Tel: 1 877 GO FESTO (1 877 463 3786)
Fax: 1 877 FX FESTO (1 877 393 3786)
Email: festo.canada@ca.festo.com

Technical Support:
Tel: 1 866 GO FESTO (1 866 463 3786)
Fax: 1 877 FX FESTO (1 877 393 3786)
Email: technical.support@ca.festo.com

USA Customers

Commercial Support:
Tel: 1 800 99 FESTO (1 800 993 3786)
Fax: 1 800 96 FESTO (1 800 963 3786)
Email: customer.service@us.festo.com

Technical Support:
Tel: 1 866 GO FESTO (1 866 463 3786)
Fax: 1 800 96 FESTO (1 800 963 3786)
Email: product.support@us.festo.com